



Test Report No.: RF141111N015-3



# FCC TEST REPORT (PART 22)

**Product:** LTE phone  
**Model No.:** XP5700  
**FCC ID:** WYPL15V013AA  
**Applicant:** Sonim Technologies, Inc.  
**Address:** 1825 S. Grant St., Suite 200., San Mateo, CA, 94402  
**Manufacturer:** Sonim Technologies, Inc.  
**Address:** 1825 S. Grant St., Suite 200., San Mateo, CA, 94402  
**Prepared by:** Bureau Veritas Shenzhen Co., Ltd. Dongguan Branch  
**Lab Location:** No. 34, Chenwulu Section, Guantai Rd., Houjie Town, Dongguan City, Guangdong 523942, China  
**TEL:** +86 769 8593 5656  
**FAX:** +86 769 8593 1080  
**E-MAIL:** [customerservice.dg@cn.bureauveritas.com](mailto:customerservice.dg@cn.bureauveritas.com)  
**Report No.:** RF141111N015-3  
**Received Date:** Nov. 11, 2014  
**Test Date:** Nov. 12, 2014 ~ Dec. 15, 2014  
**Issued Date:** Dec. 16, 2014

This report should not be used by the client to claim product certification, approval, or endorsement by A2LA or any government agencies.

This report is for your exclusive use. Any copying or replication of this report to or for any other person or entity, or use of our name or trademark, is permitted only with our prior written permission. This report sets forth our findings solely with respect to the test samples identified herein. The results set forth in this report are not indicative or representative of the quality or characteristics of the lot from which a test sample was taken or any similar or identical product unless specifically and expressly noted. Our report includes all of the tests requested by you and the results thereof based upon the information that you provided to us. You have 60 days from date of issuance of this report to notify us of any material error or omission caused by our negligence, provided, however, that such notice shall be in writing and shall specifically address the issue you wish to raise. A failure to raise such issue within the prescribed time shall constitute your unqualified acceptance of the completeness of this report, the tests conducted and the correctness of the report contents. Unless specific mention, the uncertainty of measurement has been explicitly taken into account to declare the compliance or non-compliance to the specification.

Bureau Veritas Shenzhen Co., Ltd.  
Dongguan Branch

No. 34, Chenwulu Section, Guantai Rd.,  
Houjie Town, Dongguan City,  
Guangdong 523942, China

Tel: +86 769 8593 5656  
Fax: +86 769 8593 1080  
Email: [customerservice.dg@cn.bureauveritas.com](mailto:customerservice.dg@cn.bureauveritas.com)



## TABLE OF CONTENTS

|  |           |
|--|-----------|
| <b>RELEASE CONTROL RECORD .....</b>                            | <b>4</b>  |
| <b>1 CERTIFICATION .....</b>                                   | <b>5</b>  |
| <b>2 SUMMARY OF TEST RESULTS .....</b>                         | <b>6</b>  |
| 2.1 MEASUREMENT UNCERTAINTY .....                              | 6         |
| 2.2 TEST SITE AND INSTRUMENTS .....                            | 7         |
| <b>3 GENERAL INFORMATION .....</b>                             | <b>8</b>  |
| 3.1 GENERAL DESCRIPTION OF EUT .....                           | 8         |
| 3.2 CONFIGURATION OF SYSTEM UNDER TEST .....                   | 10        |
| 3.3 DESCRIPTION OF SUPPORT UNITS .....                         | 11        |
| 3.4 TEST ITEM AND TEST CONFIGURATION.....                      | 11        |
| 3.5 EUT OPERATING CONDITIONS.....                              | 14        |
| 3.6 GENERAL DESCRIPTION OF APPLIED STANDARDS .....             | 14        |
| <b>4 TEST TYPES AND RESULTS .....</b>                          | <b>15</b> |
| 4.1 OUTPUT POWER MEASUREMENT .....                             | 15        |
| 4.1.1 LIMITS OF OUTPUT POWER MEASUREMENT .....                 | 15        |
| 4.1.2 TEST PROCEDURES .....                                    | 15        |
| 4.1.3 TEST SETUP .....   | 16        |
| 4.1.4 TEST RESULTS .....                                       | 17        |
| 4.2 FREQUENCY STABILITY MEASUREMENT .....                      | 24        |
| 4.2.1 LIMITS OF FREQUENCY STABILITY MEASUREMENT .....          | 24        |
| 4.2.2 TEST PROCEDURE .....                                     | 24        |
| 4.2.3 TEST SETUP .....   | 24        |
| 4.2.4 TEST RESULTS .....                                       | 25        |
| 4.3 OCCUPIED BANDWIDTH MEASUREMENT .....                       | 26        |
| 4.3.1 TEST PROCEDURES .....                                    | 26        |
| 4.3.2 TEST SETUP .....   | 26        |
| 4.3.3 TEST RESULTS .....                                       | 27        |
| 4.4 BAND EDGE MEASUREMENT .....                                | 33        |
| 4.4.1 LIMITS OF BAND EDGE MEASUREMENT .....                    | 33        |
| 4.4.2 TEST SETUP .....   | 33        |
| 4.4.3 TEST PROCEDURES .....                                    | 33        |
| 4.4.4 TEST RESULTS .....                                       | 35        |
| 4.5 CONDUCTED SPURIOUS EMISSIONS.....                          | 40        |
| 4.5.1 LIMITS OF CONDUCTED SPURIOUS EMISSIONS MEASUREMENT ..... | 40        |
| 4.5.2 TEST PROCEDURE .....                                     | 40        |
| 4.5.3 TEST SETUP .....   | 40        |
| 4.5.4 TEST RESULTS .....                                       | 41        |
| 4.6 RADIATED EMISSION MEASUREMENT.....                         | 45        |



**Test Report No.: RF141111N015-3**

|          |   |           |
|----------|---|-----------|
| 4.6.1    | LIMITS OF RADIATED EMISSION MEASUREMENT .....   | 45        |
| 4.6.2    | TEST PROCEDURES .....   | 45        |
| 4.6.3    | DEVIATION FROM TEST STANDARD .....  | 45        |
| 4.6.4    | TEST SETUP .....  | 46        |
| 4.6.5    | TEST RESULTS .....  | 47        |
| 4.7      | PEAK TO AVERAGE RATIO.....  | 54        |
| 4.7.1    | LIMITS OF PEAK TO AVERAGE RATIO MEASUREMENT .....   | 54        |
| 4.7.2    | TEST SETUP.....   | 54        |
| 4.7.3    | TEST PROCEDURES .....   | 54        |
| 4.7.4    | TEST RESULTS .....  | 55        |
| <b>5</b> | <b>PHOTOGRAPHS OF THE TEST CONFIGURATION.....</b>   | <b>60</b> |
| <b>6</b> | <b>INFORMATION ON THE TESTING LABORATORIES .....</b>  | <b>61</b> |
| <b>7</b> | <b>APPENDIX A – MODIFICATIONS RECORDERS FOR ENGINEERING CHANGES TO THE EUT BY THE LAB .....</b> | <b>62</b> |



Test Report No.: RF141111N015-3

## RELEASE CONTROL RECORD

| ISSUE NO.      | REASON FOR CHANGE | DATE ISSUED   |
|----------------|-------------------|---------------|
| RF141111N015-3 | Original release  | Dec. 16, 2014 |



Test Report No.: RF141111N015-3

## 1 CERTIFICATION

**PRODUCT:** LTE phone  
**BRAND:** Sonim  
**MODEL NO.:** XP5700  
**APPLICANT:** Sonim Technologies, Inc.  
**TESTED:** Nov. 12, 2014 ~ Dec. 15, 2014  
**TEST SAMPLE:** Identical Prototype  
**STANDARDS:** FCC PART 22, Subpart H

The above equipment has been tested by **Bureau Veritas Shenzhen Co., Ltd. Dongguan Branch**, and found compliance with the requirement of the above standards. The test record, data evaluation & Equipment Under Test (EUT) configurations represented herein are true and accurate accounts of the measurements of the sample's EMC characteristics under the conditions specified in this report.

**TESTED BY :**  **DATE :** Dec. 16, 2014  
Glyn He/ Project Engineer

**APPROVED BY :**  **DATE :** Dec. 16, 2014  
Sam Tung / Technical Manager

## 2 SUMMARY OF TEST RESULTS

The EUT has been tested according to the following specifications:

| APPLIED STANDARD: FCC Part 22 & Part 2 |                              |        |   |
|--|------------------------------|--------|---|
| STANDARD SECTION                       | 1.1.1.1.1 TEST TYPE          | RESULT | REMARK  |
| 2.1046<br>22.913 (a)                   | Effective Radiated Power     | PASS   | Meet the requirement of limit.  |
| 2.1055<br>22.355                       | Frequency Stability          | PASS   | Meet the requirement of limit.  |
| 2.1049                                 | Occupied Bandwidth           | PASS   | Meet the requirement of limit.  |
| 22.917                                 | Band Edge Measurements       | PASS   | Meet the requirement of limit.  |
| 2.1051<br>22.917                       | Conducted Spurious Emissions | PASS   | Meet the requirement of limit.  |
| 2.1053<br>22.917                       | Radiated Spurious Emissions  | PASS   | Meet the requirement of limit.<br>Minimum passing margin is<br>-25.31dB at 1672MHz. |

### 2.1 MEASUREMENT UNCERTAINTY

Where relevant, the following measurement uncertainty levels have been estimated for tests performed on the EUT as specified in CISPR 16-4-2:

| MEASUREMENT         | FREQUENCY     | UNCERTAINTY |
|---------------------|---------------|-------------|
| Conducted emissions | 9kHz~30MHz    | 2.66dB      |
| Radiated emissions  | 9KHz ~ 30MHz  | 2.74dB      |
|                     | 30MHz ~ 1GHz  | 3.55dB      |
|                     | 1GHz ~ 18GHz  | 4.84dB      |
|                     | 18GHz ~ 40GHz | 1.94dB      |

This uncertainty represents an expanded uncertainty expressed at approximately the 95% confidence level using a coverage factor of k=2.



## 2.2 TEST SITE AND INSTRUMENTS

| Equipment                           | Manufacturer       | Model No.                    | Serial No.  | Last Cal.   | Next Cal.   |
|-------------------------------------|--------------------|------------------------------|-------------|-------------|-------------|
| EMI Test Receiver                   | Rohde&Schwarz      | ESU 26                       | 100005      | May 13,14   | May 12,15   |
| Bilog Antenna                       | Teseq              | CBL 6111D                    | 27089       | Jun. 27, 14 | Jun. 26, 15 |
| Horn Antenna<br>(1GHz -18GHz)       | ETS -Lindgren      | 3117                         | 00062558    | May 30, 14  | May 29, 16  |
| Horn Antenna<br>(15GHz-40GHz)       | SCHWARZBECK        | BBHA 9170                    | BBHA9170242 | Feb. 13,14  | Feb. 12,17  |
| Amplifier<br>(9kHz-1GHz)            | SONOMA             | 310D                         | 186955      | Mar. 05,14  | Mar. 04, 15 |
| Pre-Amplifier<br>(18GHz-40GHz)      | EMCI               | EMC 184045                   | 980102      | Nov. 20,14  | Nov. 19,15  |
| Pre-Amplifier<br>(100MHz-26.5GHz)   | Agilent            | 8449B                        | 3008A00409  | May 13,14   | May 12,15   |
| 3m Semi-anechoic<br>Chamber         | ETS-LINDGREN       | 9m*6m*6m                     | NSEMC003    | Apr. 19,14  | Apr. 18,15  |
| Test Software                       | ADT                | ADT_Radiated<br>_V7.6.15.9.2 | N/A         | N/A         | N/A         |
| Loop antenna<br>(9kHz~30MHz)        | Daze               | ZN30900A                     | 0708        | Dec. 05,14  | Dec. 04,15  |
| Spectrum Analyzer<br>(9KHz-25GHz)   | Agilent            | E7405A                       | MY45118807  | May 13,14   | May 12,15   |
| Power Meter                         | Anritsu            | ML2495A                      | 1139001     | Feb. 21,14  | Feb. 20,15  |
| Power Sensor                        | Anritsu            | MA2411B                      | 1126068     | Feb. 21,14  | Feb. 20,15  |
| Digital Multimeter                  | FLUKE              | 15B                          | A1220010DG  | Oct. 27,14  | Oct. 26,15  |
| Humid & Temp<br>Programmable Tester | Haida              | HD-2257                      | 110807201   | Sep.04,14   | Sep. 03,15  |
| Oscilloscope                        | Agilent            | DSO9254A                     | MY51260160  | Oct. 17, 14 | Oct. 16, 15 |
| Signal Analyzer                     | Rohde &<br>Schwarz | FSV7                         | 102331      | Nov. 05,14  | Nov. 04,15  |
| Signal Generator                    | Agilent            | N5183A                       | MY50140980  | Nov. 05,14  | Nov. 04,15  |
| ESG Vector Signal<br>Generator      | Agilent            | E4438C                       | MY49072505  | Mar.14, 14  | Mar.13, 15  |
| BLUETOOTH<br>TESTER                 | Rohde&Schwarz      | CBT32                        | 100811      | Sep. 04,14  | Sep. 03,15  |

- NOTE:**
1. The calibration interval of the above test instruments is 12 months or 24 months and the calibrations are traceable to CEPREI/CHINA, GRGT/CHINA and NIM/CHINA.
  2. The test was performed in Dongguan 966 Chamber
  3. The horn antenna are used only for the measurement of emission frequency above 1GHz if tested.
  4. The FCC Site Registration No. is 502831.

### 3 GENERAL INFORMATION

#### 3.1 GENERAL DESCRIPTION OF EUT

|                            |  |                     |
|----------------------------|--|---------------------|
| <b>EUT</b>                 | LTE phone  |                     |
| <b>MODEL NO.</b>           | XP5700   |                     |
| <b>TYPE NUMBER</b>         | L15V013AA, L15V013BA, L15V013CA                        |                     |
| <b>POWER SUPPLY</b>        | 5.0Vdc (adapter or host equipment)<br>3.7Vdc (battery) |                     |
| <b>MODULATION TYPE</b>     | <b>GSM/GPRS</b>  | GMSK                |
|                            | <b>EDGE</b>  | GMSK, 8PSK          |
|                            | <b>WCDMA</b>   | BPSK, QPSK          |
|                            | <b>LTE</b>   | QPSK, 16QAM         |
| <b>FREQUENCY RANGE</b>     | <b>GSM/GPRS/EDGE</b>                                   | 824.2MHz ~ 848.8MHz |
|                            | <b>WCDMA</b>   | 826.4MHz ~ 846.6MHz |
|                            | <b>LTE Band 5<br/>(Channel Bandwidth: 1.4MHz)</b>      | 824.7MHz ~ 848.3MHz |
|                            | <b>LTE Band 5<br/>(Channel Bandwidth: 3MHz)</b>        | 825.5MHz ~ 847.5MHz |
|                            | <b>LTE Band 5<br/>(Channel Bandwidth: 5MHz)</b>        | 826.5MHz ~ 846.5MHz |
|                            | <b>LTE Band 5<br/>(Channel Bandwidth: 10MHz)</b>       | 829MHz ~ 844MHz     |
| <b>MAX. ERP POWER</b>      | <b>GSM</b>   | 745mW               |
|                            | <b>EDGE</b>  | 299mW               |
|                            | <b>WCDMA</b>   | 95mW                |
|                            | <b>LTE Band 5<br/>(Channel Bandwidth: 1.4MHz)</b>      | 150mW               |
|                            | <b>LTE Band 5<br/>(Channel Bandwidth: 3MHz)</b>        | 143mW               |
|                            | <b>LTE Band 5<br/>(Channel Bandwidth: 5MHz)</b>        | 136mW               |
|                            | <b>LTE Band 5<br/>(Channel Bandwidth: 10MHz)</b>       | 141mW               |
| <b>EMISSION DESIGNATOR</b> | <b>GSM</b>   | 246KGXW             |
|                            | <b>EDGE</b>  | 246KG7W             |
|                            | <b>WCDMA</b>   | 4M17F9W             |
|                            | <b>LTE Band 5<br/>(Channel Bandwidth: 1.4MHz)</b>      | 1M11W7D             |
|                            | <b>LTE Band 5<br/>(Channel Bandwidth: 3MHz)</b>        | 2M68G7D             |
|                            | <b>LTE Band 5<br/>(Channel Bandwidth: 5MHz)</b>        | 4M49G7D             |





Test Report No.: RF141111N015-3

|                     |  |         |
|---------------------|--|---------|
|                     | <b>LTE Band 5<br/>(Channel Bandwidth: 10MHz)</b> | 8M97W7D |
| <b>ANTENNA TYPE</b> | Fixed Internal antenna with 2dBi gain            |         |
| <b>HW VERSION</b>   | A  |         |
| <b>SW VERSION</b>   | 5A.0.0-00-4.4.2-10.01.05                         |         |
| <b>I/O PORTS</b>    | Refer to user's manual                           |         |
| <b>DATA CABLE</b>   | USB Cable: Shielded, Detachable, 1.1m            |         |

**NOTE:**

1. For a more detailed features description, please refer to the manufacturer's specifications or the user's manual.
2. The EUT was powered by the following adapter:

| <b>ADAPTER</b> |                    |
|----------------|--------------------|
| <b>BRAND:</b>  | Sonim              |
| <b>MODEL:</b>  | S14C02             |
| <b>INPUT:</b>  | AC 100-240V, 200mA |
| <b>OUTPUT:</b> | DC 5V, 1200mA      |

3. For the test results, the EUT had been tested with all conditions. But only the worst case was shown in test report.

### 3.2 CONFIGURATION OF SYSTEM UNDER TEST

#### FOR RADIATION EMISSION TEST

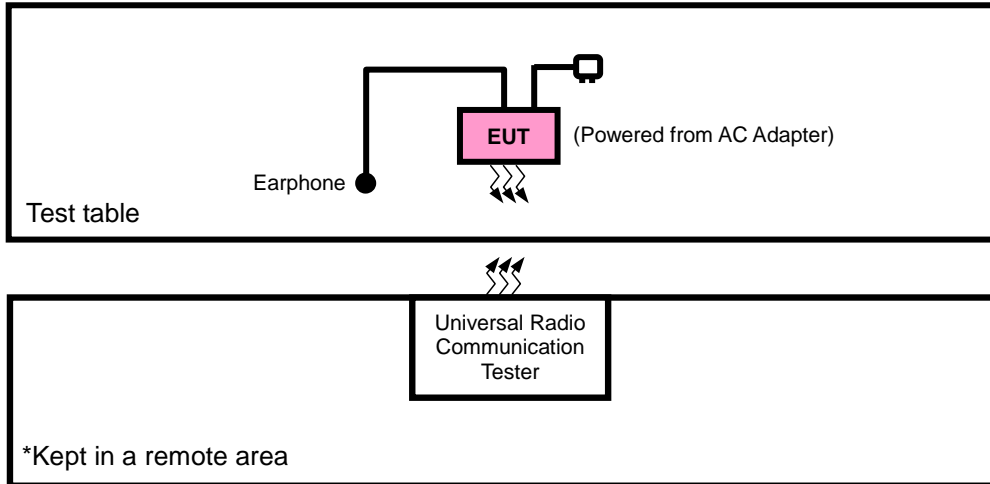

#### FOR E.R.P. TEST

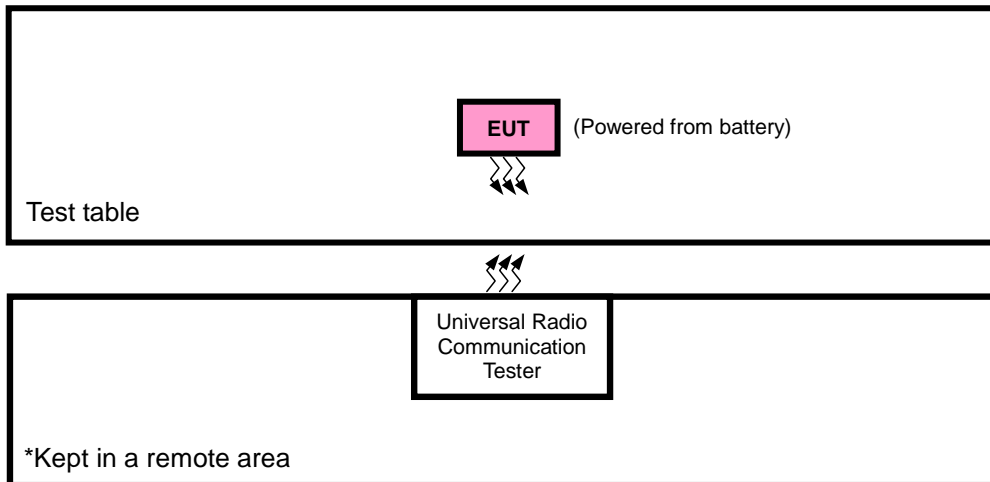



### 3.3 DESCRIPTION OF SUPPORT UNITS

The EUT has been tested as an independent unit together with other necessary accessories or support units. The following support units or accessories were used to form a representative test configuration during the tests.

| NO. | PRODUCT   | BRAND    | MODEL NO.  | SERIAL NO. | FCC ID |
|-----|-----------|----------|------------|------------|--------|
| 1   | DC source | LONG WEI | PS-6403D   | 010934269  | N/A    |
| 2   | PC        | HP       | A6608CN    | 3CR83825X3 | N/A    |
| 3   | Earphone  | Minami   | ME-816B5-E | N/A        | N/A    |

| NO. | SIGNAL CABLE DESCRIPTION OF THE ABOVE SUPPORT UNITS |
|-----|---|
| 1   | DC Line: Unshielded, Detachable 1.0m                |
| 2   | AC Line: Unshielded, Detachable 1.5m                |
| 3   | DC Line: Unshielded, Detachable 1.2m                |

**NOTE:**

1. All power cords of the above support units are non shielded (1.8m).

### 3.4 TEST ITEM AND TEST CONFIGURATION

Pre-Scan has been conducted to determine the worst-case mode from all possible combinations between available modulations, data rates, XYZ axis and antenna ports. The worst case in ERP and radiated emission was found when positioned on X-plane for GSM/EDGE/WCDMA and Z-plane for LTE. Following channel(s) was (were) selected for the final test as listed below:

| EUT CONFIGURE MODE | DESCRIPTION  |
|--------------------|--|
| A                  | EUT + Adapter + Earphone with GSM ,WCDMA or LTE link |
| B                  | EUT + Battery + Earphone with GSM ,WCDMA or LTE link |

**GSM MODE**

| EUT CONFIGURE MODE | TEST ITEM           | AVAILABLE CHANNEL | TESTED CHANNEL | MODE            |
|--------------------|---------------------|-------------------|----------------|-----------------|
| B                  | ERP                 | 128 to 251        | 128, 190, 251  | GSM, EDGE       |
| B                  | FREQUENCY STABILITY | 128 to 251        | 190            | GSM, EDGE       |
| B                  | OCCUPIED BANDWIDTH  | 128 to 251        | 128, 190, 251  | GSM, GPRS, EDGE |
| B                  | BAND EDGE           | 128 to 251        | 128, 251       | GSM, GPRS, EDGE |
| B                  | CONDCUDED EMISSION  | 128 to 251        | 128, 190, 251  | GSM             |
| A                  | RADIATED EMISSION   | 128 to 251        | 190            | GSM, EDGE       |



**Test Report No.: RF141111N015-3**

**WCDMA MODE**

| EUT CONFIGURE MODE | TEST ITEM           | AVAILABLE CHANNEL | TESTED CHANNEL   | MODE  |
|--------------------|---------------------|-------------------|------------------|-------|
| B                  | ERP                 | 4132 to 4233      | 4132, 4182, 4233 | WCDMA |
| B                  | FREQUENCY STABILITY | 4132 to 4233      | 4182             | WCDMA |
| B                  | OCCUPIED BANDWIDTH  | 4132 to 4233      | 4132, 4182, 4233 | WCDMA |
| B                  | BAND EDGE           | 4132 to 4233      | 4132, 4233       | WCDMA |
| B                  | CONDCUDED EMISSION  | 4132 to 4233      | 4132, 4182, 4233 | WCDMA |
| A                  | RADIATED EMISSION   | 4132 to 4233      | 4182             | WCDMA |

**LTE BAND 5 MODE**

| TEST ITEM           | Available Channel | Tested Channel      | Channel bandwidth | modulation | mode                |
|---------------------|-------------------|---------------------|-------------------|------------|---------------------|
| ERP                 | 20407 to 20643    | 20407, 20525, 20643 | 1.4MHz            | QPSK,16QAM | 1 RB / 0 RB Offset  |
|                     | 20415 to 20635    | 20415, 20525, 20635 | 3MHz              | QPSK,16QAM | 1 RB / 0 RB Offset  |
|                     | 20425 to 20625    | 20425, 20525, 20625 | 5MHz              | QPSK,16QAM | 1 RB / 0 RB Offset  |
|                     | 20450 to 20600    | 20450, 20525, 20600 | 10MHz             | QPSK,16QAM | 1 RB / 0 RB Offset  |
| FREQUENCY STABILITY | 20407 to 20643    | 20525               | 1.4MHz            | QPSK       | 1 RB / 0 RB Offset  |
|                     | 20415 to 20635    | 20525               | 3MHz              | QPSK       | 1 RB / 0 RB Offset  |
|                     | 20425 to 20625    | 20525               | 5MHz              | QPSK       | 1 RB / 0 RB Offset  |
|                     | 20450 to 20600    | 20525               | 10MHz             | QPSK       | 1 RB / 0 RB Offset  |
| OCCUPIED BANDWIDTH  | 20407 to 20643    | 20407, 20525, 20643 | 1.4MHz            | QPSK       | 6 RB / 0 RB Offset  |
|                     |                   |                     |                   | 16QAM      | 6 RB / 0 RB Offset  |
|                     | 20415 to 20635    | 20415, 20525, 20635 | 3MHz              | QPSK       | 15 RB / 0 RB Offset |
|                     |                   |                     |                   | 16QAM      | 15 RB / 0 RB Offset |
|                     | 20425 to 20625    | 20425, 20525, 20625 | 5MHz              | QPSK       | 25 RB / 0 RB Offset |
|                     |                   |                     |                   | 16QAM      | 25 RB / 0 RB Offset |
|                     | 20450 to 20600    | 20450, 20525, 20600 | 10MHz             | QPSK       | 50 RB / 0 RB Offset |
|                     |                   |                     |                   | 16QAM      | 50 RB / 0 RB Offset |



**Test Report No.: RF141111N015-3**

|                    |                |       |         |                     |                     |
|--------------------|----------------|-------|---------|---------------------|---------------------|
| BAND EDGE          | 20407 to 20643 | 20407 | 1.4 MHz | QPSK                | 1 RB / 0 RB Offset  |
|                    |                |       |         |                     | 6 RB / 0 RB Offset  |
|                    | 20407 to 20643 | 20643 | 1.4 MHz | QPSK                | 1 RB / 5 RB Offset  |
|                    |                |       |         |                     | 6 RB / 0 RB Offset  |
|                    | 20415 to 20635 | 20415 | 3 MHz   | QPSK                | 1 RB / 0 RB Offset  |
|                    |                |       |         |                     | 15 RB / 0 RB Offset |
|                    | 20415 to 20635 | 20635 | 3 MHz   | QPSK                | 1 RB / 14 RB Offset |
|                    |                |       |         |                     | 15 RB / 0 RB Offset |
| 20425 to 20625     | 20425          | 5MHz  | QPSK    | 1 RB / 0 RB Offset  |                     |
|                    |                |       |         | 25 RB / 0 RB Offset |                     |
| 20425 to 20625     | 20625          | 5MHz  | QPSK    | 1 RB / 24 RB Offset |                     |
|                    |                |       |         | 25 RB / 0 RB Offset |                     |
| 20450 to 20600     | 20450          | 10MHz | QPSK    | 1 RB / 0 RB Offset  |                     |
|                    |                |       |         | 50 RB / 0 RB Offset |                     |
| 20450 to 20600     | 20600          | 10MHz | QPSK    | 1 RB / 49 RB Offset |                     |
|                    |                |       |         | 50 RB / 0 RB Offset |                     |
| CONDCUDED EMISSION | 20407 to 20643 | 20525 | 1.4MHz  | QPSK                | 1 RB / 0 RB Offset  |
|                    | 20415 to 20635 | 20525 | 3MHz    | QPSK                | 1 RB / 0 RB Offset  |
|                    | 20425 to 20625 | 20525 | 5MHz    | QPSK                | 1 RB / 0 RB Offset  |
|                    | 20450 to 20600 | 20525 | 10MHz   | QPSK                | 1 RB / 0 RB Offset  |
| RADIATED EMISSION  | 20407 to 20643 | 20525 | 1.4MHz  | QPSK                | 1 RB / 0 RB Offset  |
|                    | 20415 to 20635 | 20525 | 3MHz    | QPSK                | 1 RB / 0 RB Offset  |
|                    | 20425 to 20625 | 20525 | 5MHz    | QPSK                | 1 RB / 0 RB Offset  |
|                    | 20450 to 20600 | 20525 | 10MHz   | QPSK                | 1 RB / 0 RB Offset  |

| TEST ITEM           | ENVIRONMENTAL CONDITIONS | INPUT POWER         | TESTED BY   |
|---------------------|--------------------------|---------------------|-------------|
| ERP                 | 23deg. C, 62%RH          | 3.7Vdc from Battery | Yuqiang Yin |
| FREQUENCY STABILITY | 23deg. C, 62%RH          | 3.7Vdc from Battery | Yuqiang Yin |
| OCCUPIED BANDWIDTH  | 23deg. C, 62%RH          | 3.7Vdc from Battery | Yuqiang Yin |
| BAND EDGE           | 23deg. C, 62%RH          | 3.7Vdc from Battery | Yuqiang Yin |
| CONDCUDED EMISSION  | 23deg. C, 62%RH          | 5Vdc from adapter   | Yuqiang Yin |
| RADIATED EMISSION   | 25deg. C, 63.6%RH        | 5Vdc from adapter   | Blue Zheng  |

**Bureau Veritas Shenzhen Co., Ltd.**  
Dongguan Branch

No. 34, Chenwulu Section, Guantai Rd.,  
Houjie Town, Dongguan City,  
Guangdong 523942, China

Tel: +86 769 8593 5656  
Fax: +86 769 8593 1080  
Email: [customerservice.dg@cn.bureauveritas.com](mailto:customerservice.dg@cn.bureauveritas.com)



Test Report No.: RF141111N015-3

### 3.5 EUT OPERATING CONDITIONS

The EUT makes a call to the communication simulator. The communication simulator station system controlled a EUT to export maximum output power under transmission mode and specific channel frequency

### 3.6 GENERAL DESCRIPTION OF APPLIED STANDARDS

The EUT is a RF product. According to the specifications of the manufacturer, it must comply with the requirements of the following standards:

**FCC 47 CFR Part 2**

**FCC 47 CFR Part 22**

**ANSI/TIA/EIA-603-C 2004**

**NOTE:** All test items have been performed and recorded as per the above standards.



## 4 TEST TYPES AND RESULTS

### 4.1 OUTPUT POWER MEASUREMENT

#### 4.1.1 LIMITS OF OUTPUT POWER MEASUREMENT

Mobile / Portable station are limited to 7 watts e.r.p.

#### 4.1.2 TEST PROCEDURES

##### EIRP / ERP MEASUREMENT:

- a. All measurements were done at low, middle and high operational frequency range. RBW and VBW is 1MHz for GSM, GPRS & EDGE, 5MHz for WCDMA mode, and 10MHz for LTE mode.
- b. Substitution method is used for E.I.R.P measurement. In the semi-anechoic chamber, EUT placed on the 0.8m height of Turn Table, rotated the table around 360 degrees to search the maximum radiation power and receiver antenna shall be rotated vertical and horizontal polarization and moved height from 1m to 4m to find the maximum polar radiated power. The "Read Value" is the spectrum reading the maximum power value.
- c. The substitution horn antenna is substituted for EUT at the same position and signals generator export the CW signal to the substitution antenna via a tx cable. Rotated the Turn Table and moved receiving antenna to find the maximum radiation power. Adjust output power level of S.G to get a Value of spectrum reading equal to "Read Value " of step b. Record the power level of S.G
- d.  $EIRP = \text{Output power level of S.G} - \text{TX cable loss} + \text{Antenna gain of substitution horn.}$   
 $E.R.P \text{ power can be calculated form E.I.R.P power by subtracting the gain of dipole, } E.R.P \text{ power} = E.I.P.R \text{ power} - 2.15\text{dBi.}$

##### CONDUCTED POWER MEASUREMENT:

The EUT was set up for the maximum power with GSM, GPRS, EDGE & WCDMA link data modulation and link up with simulator. Set the EUT to transmit under low, middle and high channel and record the power level shown on simulator.

### 4.1.3 TEST SETUP

#### EIRP / ERP MEASUREMENT:

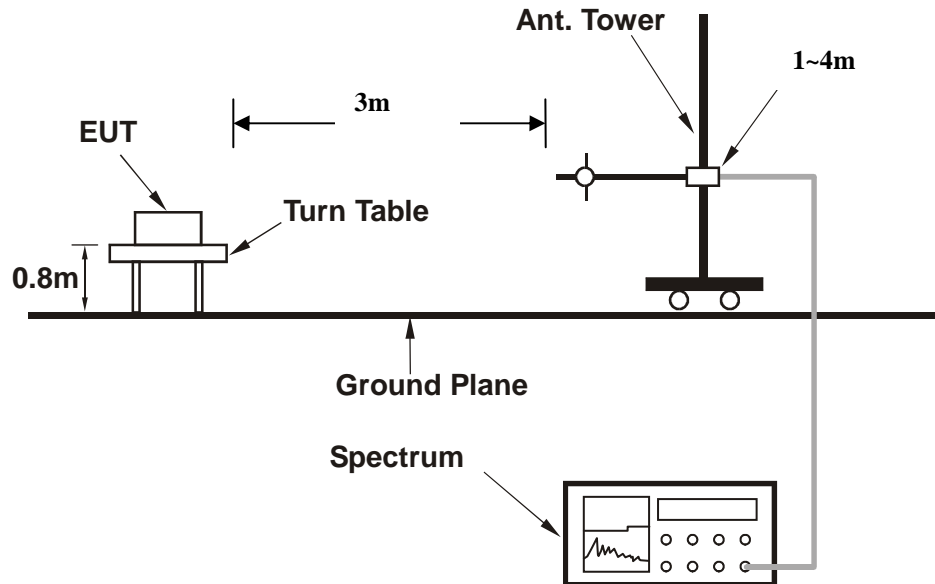

For the actual test configuration, please refer to the attached file (Test Setup Photo).

#### CONDUCTED POWER MEASUREMENT:



For the actual test configuration, please refer to the attached file (Test Setup Photo).



#### 4.1.4 TEST RESULTS

##### CONDUCTED OUTPUT POWER (dBm)

| Band            | GSM850 |       |              |
|-----------------|--------|-------|--------------|
| Channel         | 128    | 190   | 251          |
| Frequency (MHz) | 824.2  | 836.6 | 848.8        |
| GSM             | 31.67  | 31.73 | <b>31.79</b> |
| GPRS 8          | 31.50  | 31.78 | 31.74        |
| GPRS 10         | 29.69  | 29.71 | 29.83        |
| EDGE 8 (MCS1)   | 31.41  | 31.76 | 31.70        |
| EDGE 10 (MCS1)  | 29.69  | 29.64 | 29.77        |
| EDGE 8 (MCS9)   | 26.57  | 26.54 | 26.60        |
| EDGE 10 (MCS9)  | 26.39  | 26.38 | 26.48        |

| Band            | WCDMA V |              |       |
|-----------------|---------|--------------|-------|
| Channel         | 4132    | 4182         | 4233  |
| Frequency (MHz) | 826.4   | 836.4        | 846.6 |
| RMC 12.2K       | 22.72   | <b>22.74</b> | 22.71 |
| HSPA            |         |              |       |
| HSDPA Subtest-1 | 21.95   | 22.01        | 22.07 |
| HSDPA Subtest-2 | 21.85   | 21.90        | 21.83 |
| HSDPA Subtest-3 | 21.48   | 21.49        | 21.58 |
| HSDPA Subtest-4 | 21.45   | 21.48        | 21.57 |
| HSUPA Subtest-1 | 21.91   | 22.00        | 21.94 |
| HSUPA Subtest-2 | 20.83   | 20.84        | 20.81 |
| HSUPA Subtest-3 | 21.21   | 21.22        | 20.97 |
| HSUPA Subtest-4 | 20.63   | 20.63        | 20.69 |
| HSUPA Subtest-5 | 21.85   | 21.37        | 21.90 |



| Band/BW | Modulation | RB Size | RB Offset | Low CH<br>20407        | Mid CH<br>20525        | High CH<br>20643       | 3GPP<br>MPR<br>(dB) |
|---------|------------|---------|-----------|------------------------|------------------------|------------------------|---------------------|
|         |            |         |           | Frequency<br>824.7 MHz | Frequency<br>836.5 MHz | Frequency<br>848.3 MHz |                     |
| 5/1.4   | QPSK       | 1       | 0         | 23.79                  | 23.84                  | <b>23.85</b>           | 0                   |
|         |            | 1       | 2         | 22.72                  | 22.74                  | 22.81                  | 0                   |
|         |            | 1       | 5         | 22.92                  | 23.73                  | 23.66                  | 0                   |
|         |            | 3       | 0         | 23.73                  | 23.71                  | 23.84                  | 0                   |
|         |            | 3       | 1         | 23.69                  | 23.63                  | 23.77                  | 0                   |
|         |            | 3       | 3         | 23.71                  | 23.62                  | 23.76                  | 0                   |
|         |            | 6       | 0         | 22.68                  | 22.70                  | 22.80                  | 1                   |
|         | 16QAM      | 1       | 0         | 22.75                  | 22.80                  | <b>22.81</b>           | 1                   |
|         |            | 1       | 2         | 21.68                  | 21.70                  | 21.77                  | 1                   |
|         |            | 1       | 5         | 21.88                  | 22.69                  | 22.62                  | 1                   |
|         |            | 3       | 0         | 22.69                  | 22.67                  | 22.80                  | 1                   |
|         |            | 3       | 1         | 22.65                  | 22.59                  | 22.73                  | 1                   |
|         |            | 3       | 3         | 22.67                  | 22.58                  | 22.72                  | 1                   |
|         |            | 6       | 0         | 21.64                  | 21.66                  | 21.76                  | 2                   |

| Band/BW | Modulation | RB Size | RB Offset | Low CH<br>20415        | Mid CH<br>20525        | High CH<br>20635       | 3GPP<br>MPR<br>(dB) |
|---------|------------|---------|-----------|------------------------|------------------------|------------------------|---------------------|
|         |            |         |           | Frequency<br>825.5 MHz | Frequency<br>836.5 MHz | Frequency<br>847.5 MHz |                     |
| 5/3     | QPSK       | 1       | 0         | 23.86                  | 23.91                  | <b>23.92</b>           | 0                   |
|         |            | 1       | 7         | 22.79                  | 22.81                  | 22.88                  | 0                   |
|         |            | 1       | 14        | 22.99                  | 23.80                  | 23.73                  | 0                   |
|         |            | 8       | 0         | 22.80                  | 22.78                  | 22.91                  | 1                   |
|         |            | 8       | 3         | 22.76                  | 22.70                  | 22.84                  | 1                   |
|         |            | 8       | 7         | 22.78                  | 22.69                  | 22.83                  | 1                   |
|         |            | 15      | 0         | 22.75                  | 22.77                  | 22.87                  | 1                   |
|         | 16QAM      | 1       | 0         | 22.82                  | 22.87                  | <b>22.88</b>           | 1                   |
|         |            | 1       | 7         | 21.75                  | 21.77                  | 21.84                  | 1                   |
|         |            | 1       | 14        | 21.95                  | 22.76                  | 22.69                  | 1                   |
|         |            | 8       | 0         | 21.76                  | 21.74                  | 21.87                  | 2                   |
|         |            | 8       | 3         | 21.72                  | 21.66                  | 21.80                  | 2                   |
|         |            | 8       | 7         | 21.74                  | 21.65                  | 21.79                  | 2                   |
|         |            | 15      | 0         | 21.71                  | 21.73                  | 21.83                  | 2                   |



Test Report No.: RF141111N015-3

| Band/BW | Modulation | RB Size | RB Offset | Low CH<br>20425        | Mid CH<br>20525        | High CH<br>20625       | 3GPP<br>MPR<br>(dB) |
|---------|------------|---------|-----------|------------------------|------------------------|------------------------|---------------------|
|         |            |         |           | Frequency<br>826.5 MHz | Frequency<br>836.5 MHz | Frequency<br>846.5 MHz |                     |
| 5/5     | QPSK       | 1       | 0         | 23.95                  | 24.00                  | <b>24.01</b>           | 0                   |
|         |            | 1       | 12        | 22.88                  | 22.90                  | 22.97                  | 0                   |
|         |            | 1       | 24        | 23.08                  | 23.89                  | 23.82                  | 0                   |
|         |            | 12      | 0         | 22.89                  | 22.87                  | 23.00                  | 1                   |
|         |            | 12      | 6         | 22.85                  | 22.79                  | 22.93                  | 1                   |
|         |            | 12      | 13        | 22.87                  | 22.78                  | 22.92                  | 1                   |
|         |            | 25      | 0         | 22.84                  | 22.86                  | 22.96                  | 1                   |
|         | 16QAM      | 1       | 0         | 22.91                  | 22.96                  | <b>22.97</b>           | 1                   |
|         |            | 1       | 12        | 21.84                  | 21.86                  | 21.93                  | 1                   |
|         |            | 1       | 24        | 22.04                  | 22.85                  | 22.78                  | 1                   |
|         |            | 12      | 0         | 21.85                  | 21.83                  | 21.96                  | 2                   |
|         |            | 12      | 6         | 21.81                  | 21.75                  | 21.89                  | 2                   |
|         |            | 12      | 13        | 21.83                  | 21.74                  | 21.88                  | 2                   |
|         |            | 25      | 0         | 21.80                  | 21.82                  | 21.92                  | 2                   |

| Band/BW | Modulation | RB Size | RB Offset | Low CH<br>20450      | Mid CH<br>20525        | High CH<br>20600     | 3GPP<br>MPR<br>(dB) |
|---------|------------|---------|-----------|----------------------|------------------------|----------------------|---------------------|
|         |            |         |           | Frequency<br>829 MHz | Frequency<br>836.5 MHz | Frequency<br>844 MHz |                     |
| 5/10    | QPSK       | 1       | 0         | 24.07                | 24.12                  | <b>24.13</b>         | 0                   |
|         |            | 1       | 24        | 23.00                | 23.02                  | 23.09                | 0                   |
|         |            | 1       | 49        | 23.20                | 24.01                  | 23.94                | 0                   |
|         |            | 25      | 0         | 23.01                | 22.99                  | 23.12                | 1                   |
|         |            | 25      | 12        | 22.97                | 22.91                  | 23.05                | 1                   |
|         |            | 25      | 25        | 22.99                | 22.90                  | 23.04                | 1                   |
|         |            | 50      | 0         | 22.96                | 22.98                  | 23.08                | 1                   |
|         | 16QAM      | 1       | 0         | 23.03                | 23.08                  | <b>23.09</b>         | 1                   |
|         |            | 1       | 24        | 21.96                | 21.98                  | 22.05                | 1                   |
|         |            | 1       | 49        | 22.16                | 22.97                  | 22.90                | 1                   |
|         |            | 25      | 0         | 21.97                | 21.95                  | 22.08                | 2                   |
|         |            | 25      | 12        | 21.93                | 21.87                  | 22.01                | 2                   |
|         |            | 25      | 25        | 21.95                | 21.86                  | 22.00                | 2                   |
|         |            | 50      | 0         | 21.92                | 21.94                  | 22.04                | 2                   |



**ERP POWER (dBm)**

**GSM**

| Channel | Frequency (MHz) | LVL (dBm) | Correction Factor(dB) | ERP(dBm) | ERP(mW)       | Polarization (H/V) |
|---------|-----------------|-----------|-----------------------|----------|---------------|--------------------|
| 128     | 824.2           | -14.02    | 35.85                 | 19.68    | 92.90         | H                  |
| 189     | 836.4           | -14.51    | 37.09                 | 20.43    | 110.41        | H                  |
| 251     | 848.8           | -15.04    | 36.96                 | 19.77    | 94.84         | H                  |
| 128     | 824.2           | -6.35     | 36.88                 | 28.38    | 688.65        | V                  |
| 189     | 836.4           | -6.98     | 37.56                 | 28.43    | 696.63        | V                  |
| 251     | 848.8           | -6.85     | 37.72                 | 28.72    | <b>744.73</b> | V                  |

**EDGE**

| Channel | Frequency (MHz) | LVL (dBm) | Correction Factor(dB) | ERP(dBm) | ERP(mW)       | Polarization (H/V) |
|---------|-----------------|-----------|-----------------------|----------|---------------|--------------------|
| 128     | 824.2           | -17.67    | 35.85                 | 16.03    | 40.09         | H                  |
| 189     | 836.4           | -18.28    | 37.09                 | 16.66    | 46.34         | H                  |
| 251     | 848.8           | -18.84    | 36.96                 | 15.97    | 39.54         | H                  |
| 128     | 824.2           | -10.58    | 36.88                 | 24.15    | 260.02        | V                  |
| 189     | 836.4           | -10.65    | 37.56                 | 24.76    | <b>299.23</b> | V                  |
| 251     | 848.8           | -10.85    | 37.72                 | 24.72    | 296.48        | V                  |

**WCDMA**

| Channel | Frequency (MHz) | LVL (dBm) | Correction Factor(dB) | ERP(dBm) | ERP(mW)      | Polarization (H/V) |
|---------|-----------------|-----------|-----------------------|----------|--------------|--------------------|
| 4132    | 826.4           | -23.82    | 35.85                 | 9.88     | 9.73         | H                  |
| 4182    | 836.4           | -24.11    | 37.09                 | 10.83    | 12.11        | H                  |
| 4233    | 846.6           | -24.75    | 37                    | 10.10    | 10.23        | H                  |
| 4132    | 826.4           | -15.63    | 36.85                 | 19.07    | 80.72        | V                  |
| 4182    | 836.4           | -15.86    | 37.56                 | 19.55    | 90.16        | V                  |
| 4233    | 846.6           | -15.84    | 37.77                 | 19.78    | <b>95.06</b> | V                  |



LTE BAND 5

CHANNEL BANDWIDTH: 1.4MHz QPSK

| Channel | Frequency (MHz) | LVL (dBm) | Correction Factor(dB) | ERP(dBm) | ERP(mW)       | Polarization (H/V) | LIMIT (W) |
|---------|-----------------|-----------|-----------------------|----------|---------------|--------------------|-----------|
| 20407   | 824.7           | -13.62    | 35.47                 | 19.70    | 93.33         | H                  | 1         |
| 20525   | 836.5           | -13.05    | 36.88                 | 21.68    | 147.23        | H                  | 1         |
| 20643   | 848.3           | -13.01    | 36.92                 | 21.76    | <b>149.97</b> | H                  | 1         |
| 20407   | 824.7           | -24.66    | 36.59                 | 9.78     | 9.51          | V                  | 1         |
| 20525   | 836.5           | -24.33    | 37.35                 | 10.87    | 12.22         | V                  | 1         |
| 20643   | 848.3           | -24.19    | 37.71                 | 11.37    | 13.71         | V                  | 1         |

CHANNEL BANDWIDTH: 1.4MHz 16QAM

| Channel | Frequency (MHz) | LVL (dBm) | Correction Factor(dB) | ERP(dBm) | ERP(mW) | Polarization (H/V) | LIMIT (W) |
|---------|-----------------|-----------|-----------------------|----------|---------|--------------------|-----------|
| 20407   | 824.7           | -14.85    | 35.47                 | 18.47    | 70.31   | H                  | 1         |
| 20525   | 836.5           | -14.65    | 36.88                 | 20.08    | 101.86  | H                  | 1         |
| 20643   | 848.3           | -14.85    | 36.92                 | 19.92    | 98.17   | H                  | 1         |
| 20407   | 824.7           | -25.61    | 36.59                 | 8.83     | 7.64    | V                  | 1         |
| 20525   | 836.5           | -26.85    | 37.35                 | 8.35     | 6.84    | V                  | 1         |
| 20643   | 848.3           | -25.11    | 37.71                 | 10.45    | 11.09   | V                  | 1         |

CHANNEL BANDWIDTH: 3MHz QPSK

| Channel | Frequency (MHz) | LVL (dBm) | Correction Factor(dB) | ERP(dBm) | ERP(mW)       | Polarization (H/V) | LIMIT (W) |
|---------|-----------------|-----------|-----------------------|----------|---------------|--------------------|-----------|
| 20415   | 825.5           | -13.26    | 35.45                 | 20.04    | 100.93        | H                  | 1         |
| 20525   | 836.5           | -13.47    | 36.88                 | 21.26    | 133.66        | H                  | 1         |
| 20635   | 847.5           | -13.12    | 36.82                 | 21.55    | <b>142.89</b> | H                  | 1         |
| 20415   | 825.5           | -24.95    | 36.54                 | 9.44     | 8.79          | V                  | 1         |
| 20525   | 836.5           | -25.63    | 37.35                 | 9.57     | 9.06          | V                  | 1         |
| 20635   | 847.5           | -24.85    | 37.64                 | 10.64    | 11.59         | V                  | 1         |



Test Report No.: RF141111N015-3

**CHANNEL BANDWIDTH: 3MHz 16QAM**

| Channel | Frequency (MHz) | LVL (dBm) | Correction Factor(dB) | ERP(dBm) | ERP(mW) | Polarization (H/V) | LIMIT (W) |
|---------|-----------------|-----------|-----------------------|----------|---------|--------------------|-----------|
| 20415   | 825.5           | -14.06    | 35.45                 | 19.24    | 83.95   | H                  | 1         |
| 20525   | 836.5           | -14.25    | 36.88                 | 20.48    | 111.69  | H                  | 1         |
| 20635   | 847.5           | -14.55    | 36.82                 | 20.12    | 102.80  | H                  | 1         |
| 20415   | 825.5           | -25.19    | 36.54                 | 9.20     | 8.32    | V                  | 1         |
| 20525   | 836.5           | -25.43    | 37.35                 | 9.77     | 9.48    | V                  | 1         |
| 20635   | 847.5           | -25.88    | 37.64                 | 9.61     | 9.14    | V                  | 1         |

**CHANNEL BANDWIDTH: 5MHz QPSK**

| Channel | Frequency (MHz) | LVL (dBm) | Correction Factor(dB) | ERP(dBm) | ERP(mW)       | Polarization (H/V) | LIMIT (W) |
|---------|-----------------|-----------|-----------------------|----------|---------------|--------------------|-----------|
| 20425   | 826.5           | -13.63    | 35.59                 | 19.81    | 95.72         | H                  | 1         |
| 20525   | 836.5           | -13.52    | 36.88                 | 21.21    | 132.13        | H                  | 1         |
| 20625   | 846.5           | -13.41    | 36.9                  | 21.34    | <b>136.14</b> | H                  | 1         |
| 20425   | 826.5           | -24.95    | 36.51                 | 9.41     | 8.73          | V                  | 1         |
| 20525   | 836.5           | -24.74    | 37.35                 | 10.46    | 11.12         | V                  | 1         |
| 20625   | 846.5           | -24.29    | 37.62                 | 11.18    | 13.12         | V                  | 1         |

**CHANNEL BANDWIDTH: 5MHz 16QAM**

| Channel | Frequency (MHz) | LVL (dBm) | Correction Factor(dB) | ERP(dBm) | ERP(mW) | Polarization (H/V) | LIMIT (W) |
|---------|-----------------|-----------|-----------------------|----------|---------|--------------------|-----------|
| 20425   | 826.5           | -14.63    | 35.59                 | 18.81    | 76.03   | H                  | 1         |
| 20525   | 836.5           | -14.52    | 36.88                 | 20.21    | 104.95  | H                  | 1         |
| 20625   | 846.5           | -14.29    | 36.9                  | 20.46    | 111.17  | H                  | 1         |
| 20425   | 826.5           | -25.13    | 36.51                 | 9.23     | 8.38    | V                  | 1         |
| 20525   | 836.5           | -25.35    | 37.35                 | 9.85     | 9.66    | V                  | 1         |
| 20625   | 846.5           | -25.42    | 37.62                 | 10.05    | 10.12   | V                  | 1         |



Test Report No.: RF141111N015-3

**CHANNEL BANDWIDTH: 10MHz QPSK**

| Channel | Frequency (MHz) | LVL (dBm) | Correction Factor(dB) | ERP(dBm) | ERP(mW)       | Polarization (H/V) | LIMIT (W) |
|---------|-----------------|-----------|-----------------------|----------|---------------|--------------------|-----------|
| 20450   | 829             | -13.29    | 35.71                 | 20.27    | 106.41        | H                  | 1         |
| 20525   | 836.5           | -13.22    | 36.85                 | 21.48    | <b>140.60</b> | H                  | 1         |
| 20600   | 844             | -13.57    | 37.01                 | 21.29    | 134.59        | H                  | 1         |
| 20450   | 829             | -24.55    | 36.56                 | 9.86     | 9.68          | V                  | 1         |
| 20525   | 836.5           | -24.11    | 37.32                 | 11.06    | 12.76         | V                  | 1         |
| 20600   | 844             | -24.19    | 37.62                 | 11.28    | 13.43         | V                  | 1         |

**CHANNEL BANDWIDTH: 10MHz 16QAM**

| Channel | Frequency (MHz) | LVL (dBm) | Correction Factor(dB) | ERP(dBm) | ERP(mW) | Polarization (H/V) | LIMIT (W) |
|---------|-----------------|-----------|-----------------------|----------|---------|--------------------|-----------|
| 20450   | 829             | -14.36    | 35.71                 | 19.20    | 83.18   | H                  | 1         |
| 20525   | 836.5           | -14.59    | 36.85                 | 20.11    | 102.57  | H                  | 1         |
| 20600   | 844             | -14.33    | 37.01                 | 20.53    | 112.98  | H                  | 1         |
| 20450   | 829             | -25.36    | 36.56                 | 9.05     | 8.04    | V                  | 1         |
| 20525   | 836.5           | -25.16    | 37.32                 | 10.01    | 10.02   | V                  | 1         |
| 20600   | 844             | -25.59    | 37.62                 | 9.88     | 9.73    | V                  | 1         |

**REMARKS:** 1. ERP Output Power (dBm) = SPA Reading (dBm) + Correction Factor (dB).  
2. Correction factor (dB) = Free Space Loss + Antenna Factor + Cable Loss.

## 4.2 FREQUENCY STABILITY MEASUREMENT

### 4.2.1 LIMITS OF FREQUENCY STABILITY MEASUREMENT

1.5 ppm is for base and fixed station. 2.5 ppm is for mobile station.

### 4.2.2 TEST PROCEDURE

- Device is placed at the oven room. The oven room could control the temperatures and humidity. Power warm up is at least 15 min and power applied should perform before recording frequency error.
- EUT is connected the external power supply to control the DC input power. The test voltage range is from minimum to maximum working voltage. Each step shall be record the frequency error rate.
- The temperature range step is 10 degrees in this test items. All temperature levels shall be hold the  $\pm 0.5^{\circ}\text{C}$  during the measurement testing. The each temperature step shall be at least 0.5 hours, consider the EUT could be test under the stability condition.

**NOTE:** The frequency error was recorded frequency error from the communication simulator.

### 4.2.3 TEST SETUP

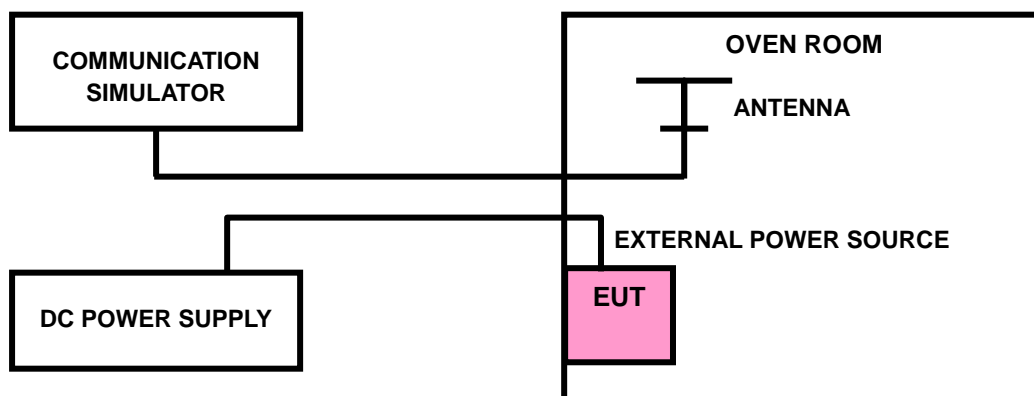





4.2.4 TEST RESULTS

FREQUENCY ERROR VS. VOLTAGE

| Voltage (Volts) | Frequency Error (ppm) |         |        |            |       |        |        | Limit (ppm) |
|-----------------|-----------------------|---------|--------|------------|-------|--------|--------|-------------|
|                 | GSM                   | EDGE    | WCDMA  | LTE Band 5 |       |        |        |             |
|                 |                       |         |        | 1.4 MHz    | 3 MHz | 5 MHz  | 10MHz  |             |
| 3.7             | -0.0214               | -0.0218 | 0.0155 | 0.015      | 0.012 | 0.006  | 0.015  | 2.5         |
| 3.5             | -0.0159               | -0.0192 | 0.0122 | 0.003      | 0.010 | -0.003 | 0.007  | 2.5         |
| 4.2             | -0.0070               | -0.0123 | 0.0097 | 0.004      | 0.004 | 0.007  | -0.004 | 2.5         |

NOTE: The applicant defined the normal working voltage of the battery is from 3.5Vdc to 4.2Vdc.

FREQUENCY ERROR vs. TEMPERATURE.

| Voltage (Volts) | Frequency Error (ppm) |         |        |            |        |        |        | Limit (ppm) |
|-----------------|-----------------------|---------|--------|------------|--------|--------|--------|-------------|
|                 | GSM                   | EDGE    | WCDMA  | LTE Band 5 |        |        |        |             |
|                 |                       |         |        | 1.4 MHz    | 3 MHz  | 5 MHz  | 10MHz  |             |
| -30             | -0.0240               | -0.0239 | 0.0192 | 0.015      | 0.019  | 0.017  | 0.019  | 2.5         |
| -20             | -0.0214               | -0.0239 | 0.0156 | 0.012      | 0.016  | 0.015  | 0.017  | 2.5         |
| -10             | -0.0206               | -0.0239 | 0.0123 | 0.012      | 0.013  | 0.010  | 0.015  | 2.5         |
| 0               | -0.0180               | -0.0207 | 0.0097 | 0.009      | 0.012  | 0.008  | 0.012  | 2.5         |
| 10              | -0.0160               | -0.0191 | 0.0043 | 0.006      | 0.008  | 0.005  | 0.011  | 2.5         |
| 20              | -0.0094               | -0.0181 | 0.0059 | 0.003      | 0.007  | 0.003  | 0.006  | 2.5         |
| 30              | -0.0031               | -0.0181 | 0.0043 | -0.003     | 0.005  | -0.002 | 0.004  | 2.5         |
| 40              | 0.0038                | -0.0156 | 0.0050 | -0.006     | 0.003  | 0.003  | 0.001  | 2.5         |
| 50              | 0.0062                | -0.0148 | 0.0098 | -0.009     | 0.001  | 0.008  | -0.003 | 2.5         |
| 60              | 0.0093                | -0.0136 | 0.0120 | -0.014     | -0.004 | 0.010  | -0.007 | 2.5         |

### 4.3 OCCUPIED BANDWIDTH MEASUREMENT

#### 4.3.1 TEST PROCEDURES

The EUT makes a call to the communication simulator. All measurements were done at low, middle and high operational frequency range. The communication simulator station system controlled a EUT to export maximum output power under transmission mode and specific channel frequency. Use OBW measurement function of Spectrum analyzer to measure 99 % occupied bandwidth.

#### 4.3.2 TEST SETUP

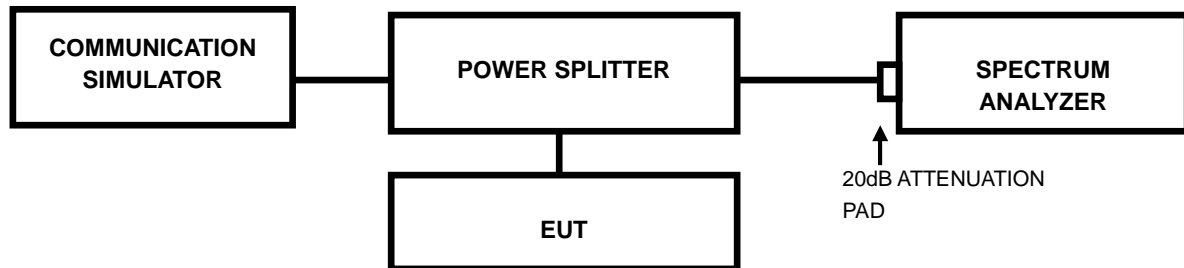

### 4.3.3 TEST RESULTS

| CHANNEL | Frequency (MHz) | 99% OCCUPIED Bandwidth (kHz) |        | CHANNEL | Frequency (MHz) | 99% OCCUPIED Bandwidth (MHz) |
|---------|-----------------|------------------------------|--------|---------|-----------------|------------------------------|
|         |                 | GSM                          | EDGE   |         |                 | WCDMA                        |
| 128     | 824.2           | 244.93                       | 246.38 | 4132    | 826.4           | 4.16                         |
| 190     | 836.6           | 246.38                       | 242.03 | 4182    | 836.4           | 4.14                         |
| 251     | 848.8           | 243.48                       | 240.58 | 4233    | 846.6           | 4.17                         |

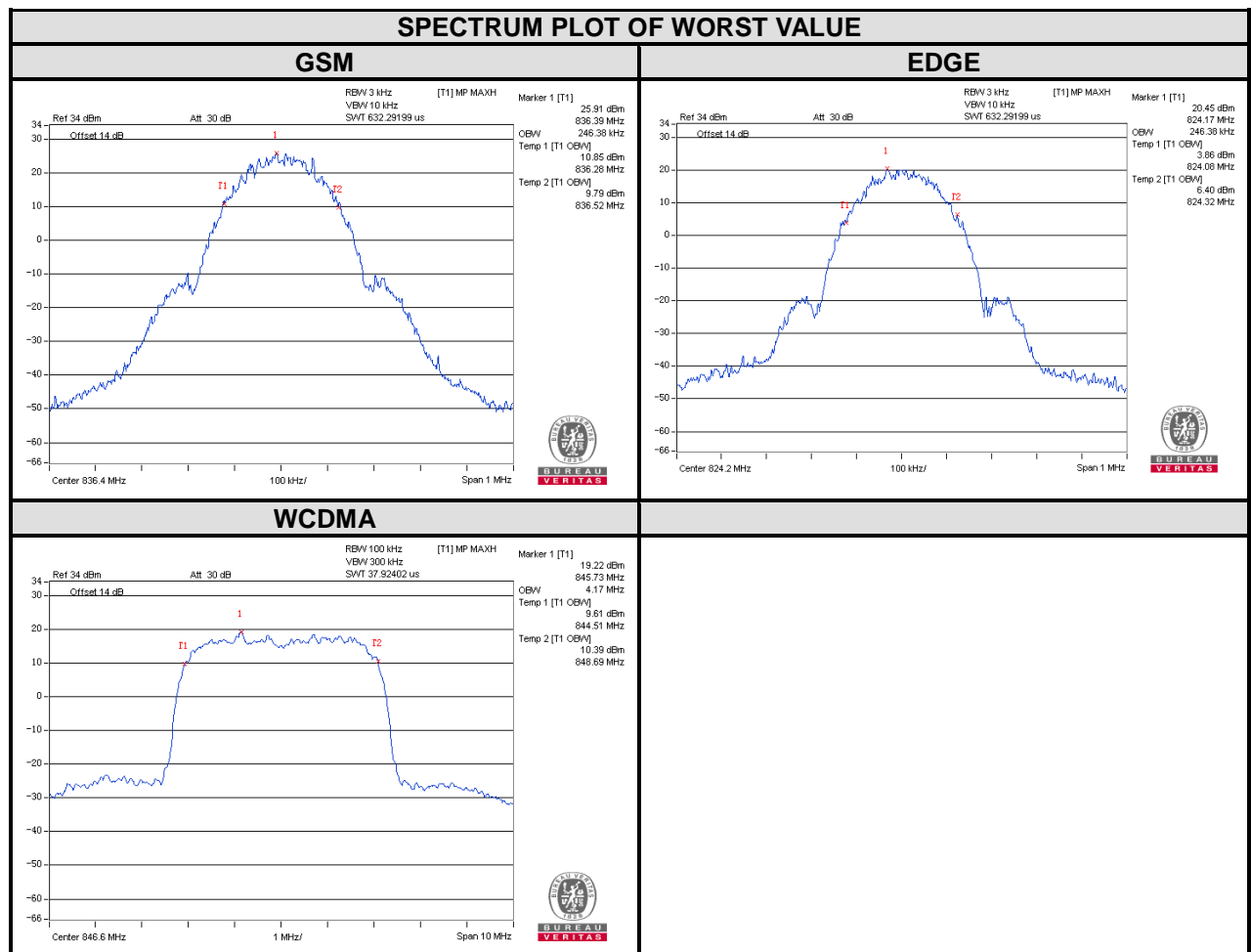



| CHANNEL | Frequency (MHz) | 26dB Bandwidth (kHz) |       | CHANNEL | Frequency (MHz) | 26dB Bandwidth (MHz) |
|---------|-----------------|----------------------|-------|---------|-----------------|----------------------|
|         |                 | GSM                  | EDGE  |         |                 |                      |
| 128     | 824.2           | 319.57               | 321   | 4132    | 826.4           | 4.68                 |
| 190     | 836.6           | 321.12               | 321.2 | 4182    | 836.4           | 4.67                 |
| 251     | 848.8           | 319.93               | 318.7 | 4233    | 846.6           | 4.67                 |

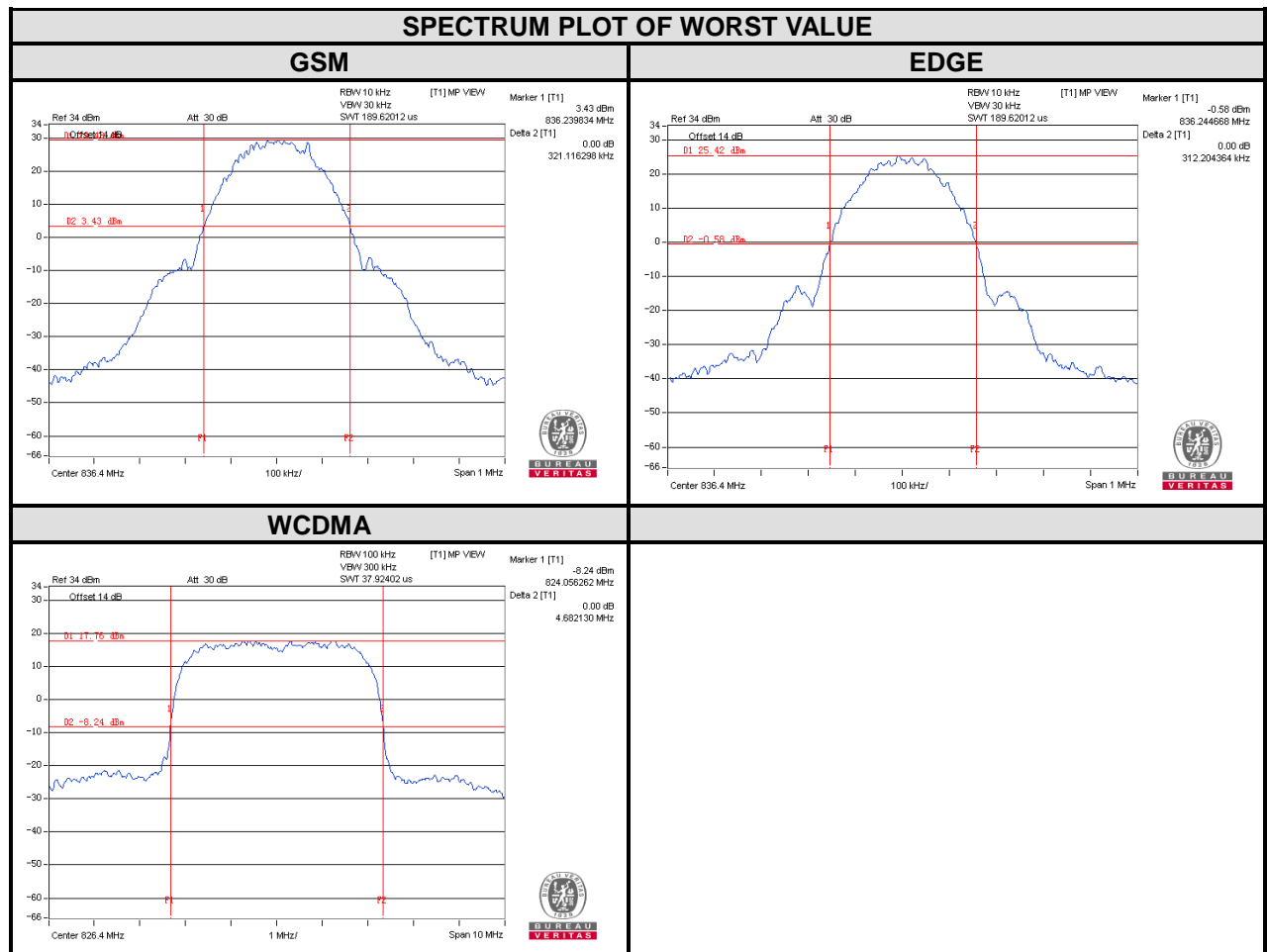



Test Report No.: RF141111N015-3

| LTE band 5                 |                 |                              |       |         |                 |                       |       |
|----------------------------|-----------------|------------------------------|-------|---------|-----------------|-----------------------|-------|
| Channel Bandwidth : 1.4MHz |                 |                              |       |         |                 |                       |       |
| Channel                    | Frequency (MHz) | 99% Occupied bandwidth (MHz) |       | Channel | Frequency (MHz) | 26 dB bandwidth (MHz) |       |
|                            |                 | QPSK                         | 16QAM |         |                 | QPSK                  | 16QAM |
| 20407                      | 824.7           | 1.09                         | 1.08  | 20407   | 824.7           | 1.26                  | 1.25  |
| 20525                      | 836.5           | 1.09                         | 1.08  | 20525   | 836.5           | 1.26                  | 1.27  |
| 20643                      | 848.3           | 1.10                         | 1.11  | 20643   | 848.3           | 1.33                  | 1.29  |

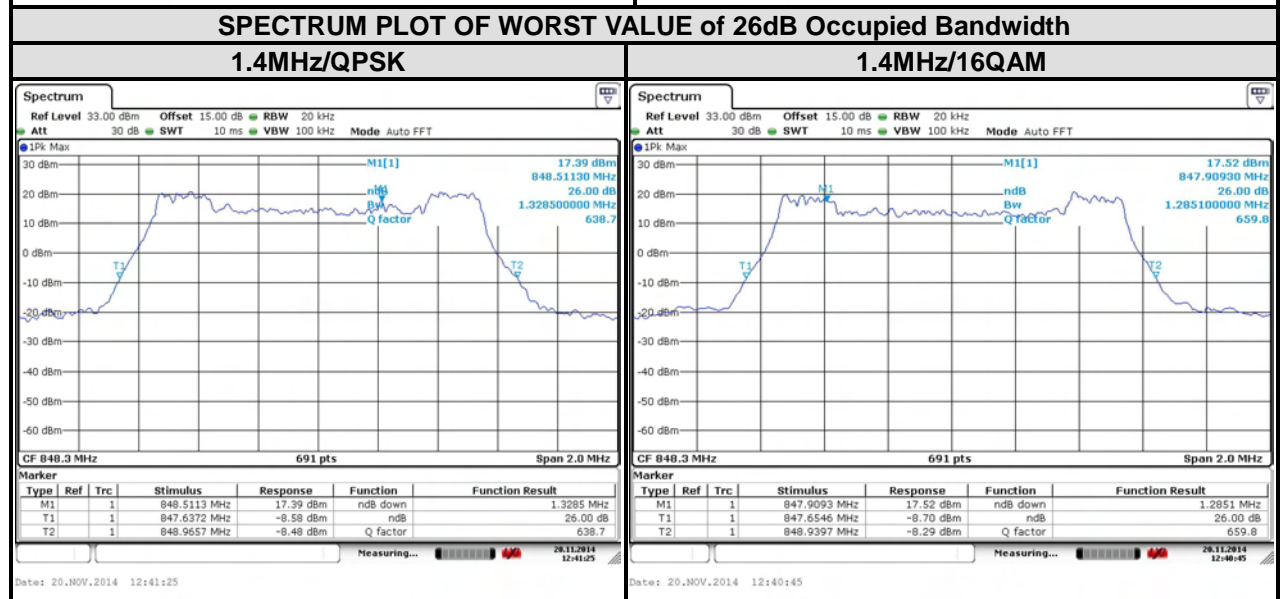
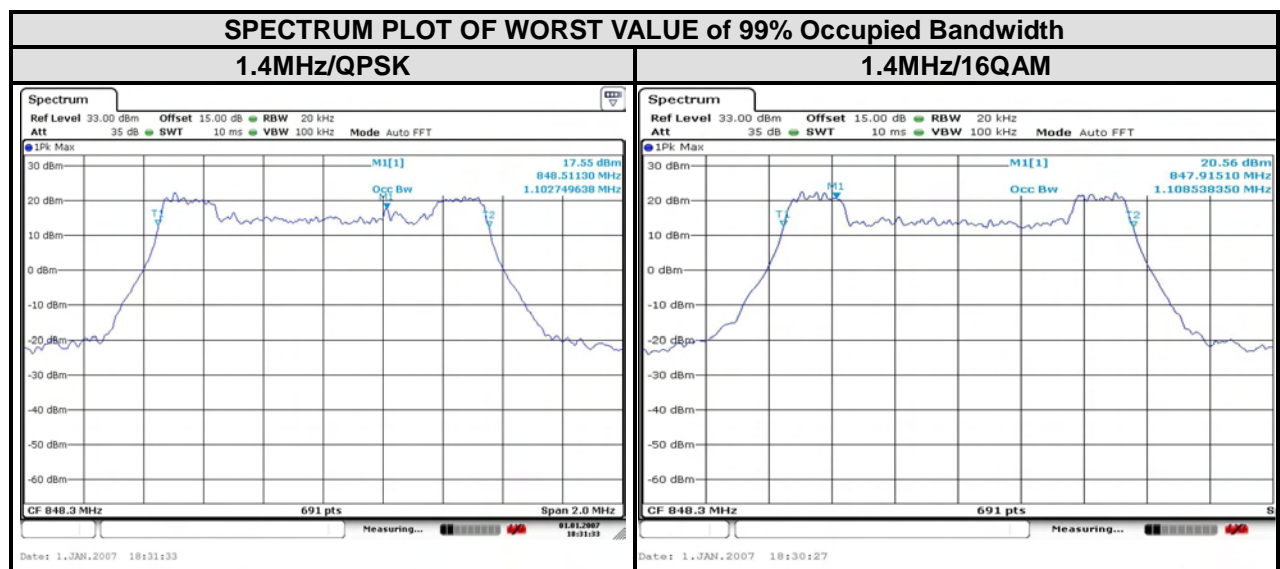

Bureau Veritas Shenzhen Co., Ltd.  
Dongguan Branch

No. 34, Chenwulu Section, Guantai Rd.,  
Houjie Town, Dongguan City,  
Guangdong 523942, China

Tel: +86 769 8593 5656  
Fax: +86 769 8593 1080  
Email: [customerservice.dg@cn.bureauveritas.com](mailto:customerservice.dg@cn.bureauveritas.com)



Test Report No.: RF141111N015-3

| LTE band 5               |                 |                              |       |         |                 |                       |       |
|--------------------------|-----------------|------------------------------|-------|---------|-----------------|-----------------------|-------|
| Channel Bandwidth : 3MHz |                 |                              |       |         |                 |                       |       |
| Channel                  | Frequency (MHz) | 99% Occupied bandwidth (MHz) |       | Channel | Frequency (MHz) | 26 dB bandwidth (MHz) |       |
|                          |                 | QPSK                         | 16QAM |         |                 | QPSK                  | 16QAM |
| 20415                    | 825.5           | 2.68                         | 2.67  | 20415   | 825.5           | 2.95                  | 2.93  |
| 20525                    | 836.5           | 2.68                         | 2.67  | 20525   | 836.5           | 2.94                  | 2.92  |
| 20635                    | 847.5           | 2.68                         | 2.67  | 20635   | 847.5           | 3.01                  | 2.97  |

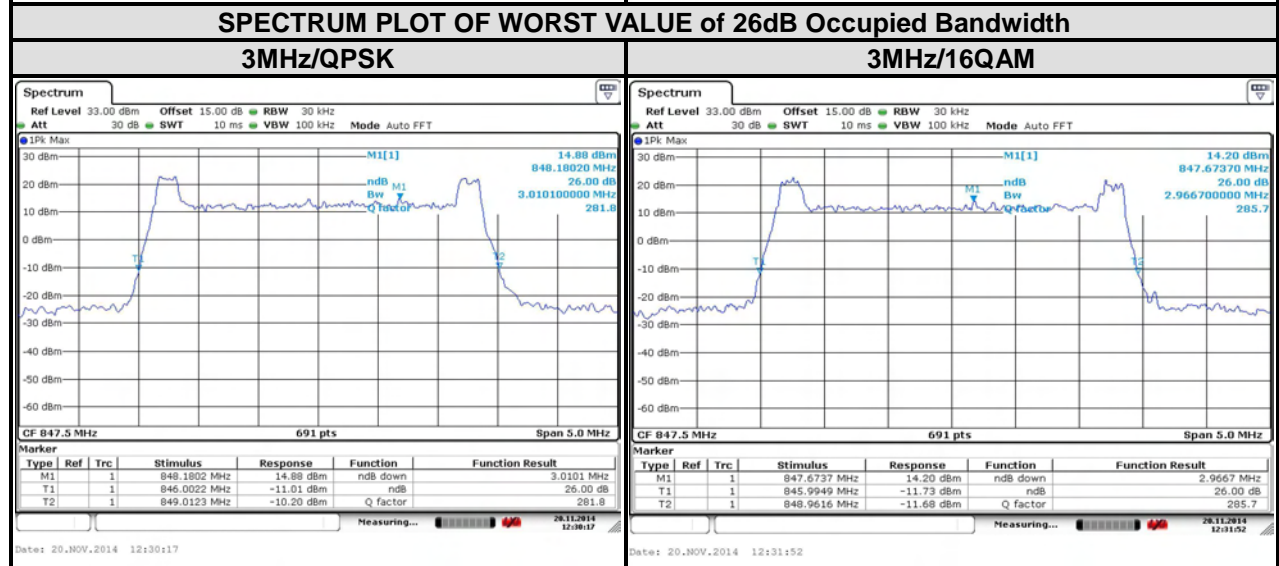
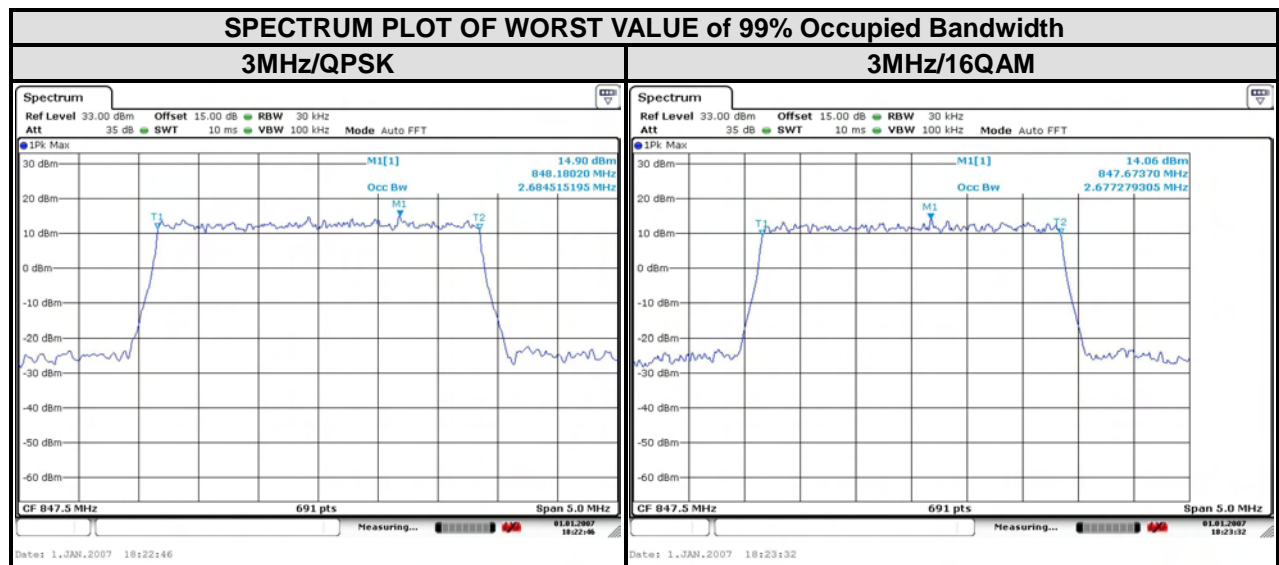

Bureau Veritas Shenzhen Co., Ltd.  
Dongguan Branch

No. 34, Chenwulu Section, Guantai Rd.,  
Houjie Town, Dongguan City,  
Guangdong 523942, China

Tel: +86 769 8593 5656  
Fax: +86 769 8593 1080  
Email: [customerservice.dg@cn.bureauveritas.com](mailto:customerservice.dg@cn.bureauveritas.com)



| LTE band 5                |                 |                              |       |         |                 |                       |       |
|---------------------------|-----------------|------------------------------|-------|---------|-----------------|-----------------------|-------|
| Channel Bandwidth : 5 MHz |                 |                              |       |         |                 |                       |       |
| Channel                   | Frequency (MHz) | 99% Occupied bandwidth (MHz) |       | Channel | Frequency (MHz) | 26 dB bandwidth (MHz) |       |
|                           |                 | QPSK                         | 16QAM |         |                 | QPSK                  | 16QAM |
| 20425                     | 826.5           | 4.47                         | 4.49  | 20425   | 826.5           | 4.92                  | 4.88  |
| 20525                     | 836.5           | 4.49                         | 4.46  | 20525   | 836.5           | 4.91                  | 4.85  |
| 20625                     | 846.5           | 4.47                         | 4.46  | 20625   | 846.5           | 4.94                  | 4.86  |

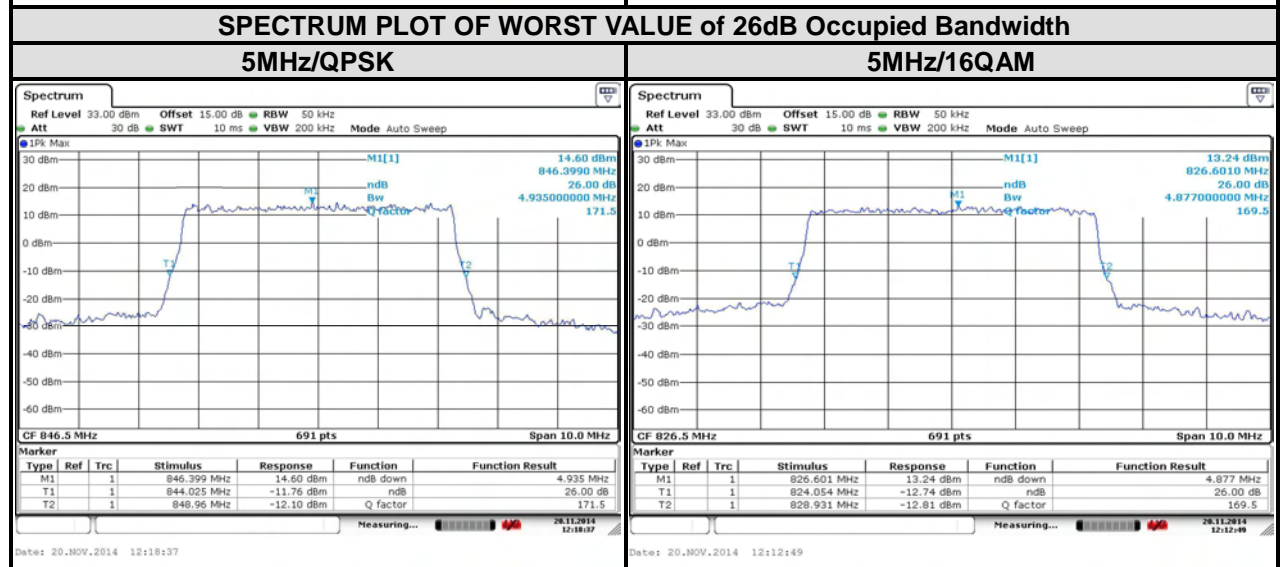
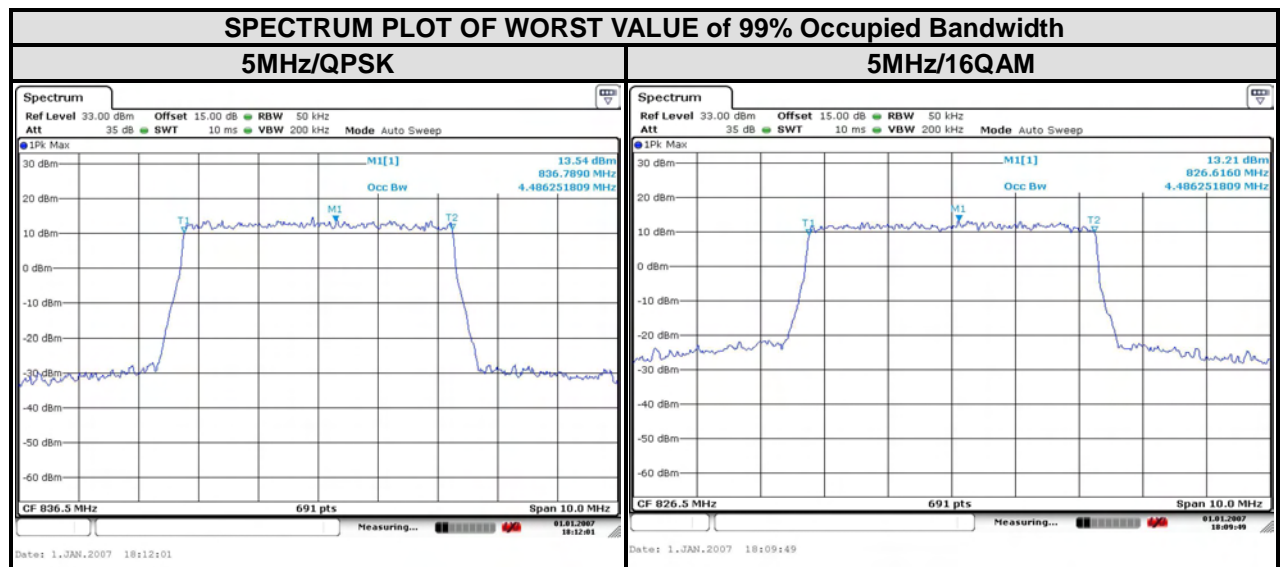



| LTE band 5                 |                 |                              |       |         |                 |                       |       |
|----------------------------|-----------------|------------------------------|-------|---------|-----------------|-----------------------|-------|
| Channel Bandwidth : 10 MHz |                 |                              |       |         |                 |                       |       |
| Channel                    | Frequency (MHz) | 99% Occupied bandwidth (MHz) |       | Channel | Frequency (MHz) | 26 dB bandwidth (MHz) |       |
|                            |                 | QPSK                         | 16QAM |         |                 | QPSK                  | 16QAM |
| 20450                      | 829             | 8.94                         | 8.97  | 20450   | 829             | 9.81                  | 9.81  |
| 20525                      | 836.5           | 8.91                         | 8.94  | 20525   | 836.5           | 9.73                  | 9.79  |
| 20600                      | 844             | 8.94                         | 8.97  | 20600   | 844             | 9.77                  | 9.79  |

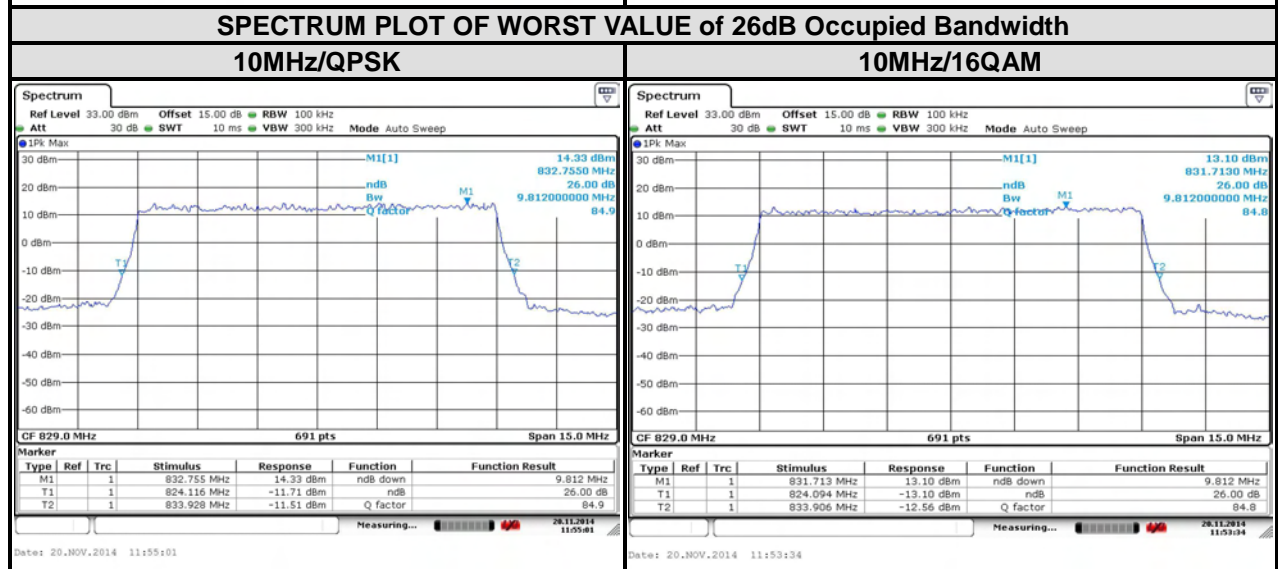
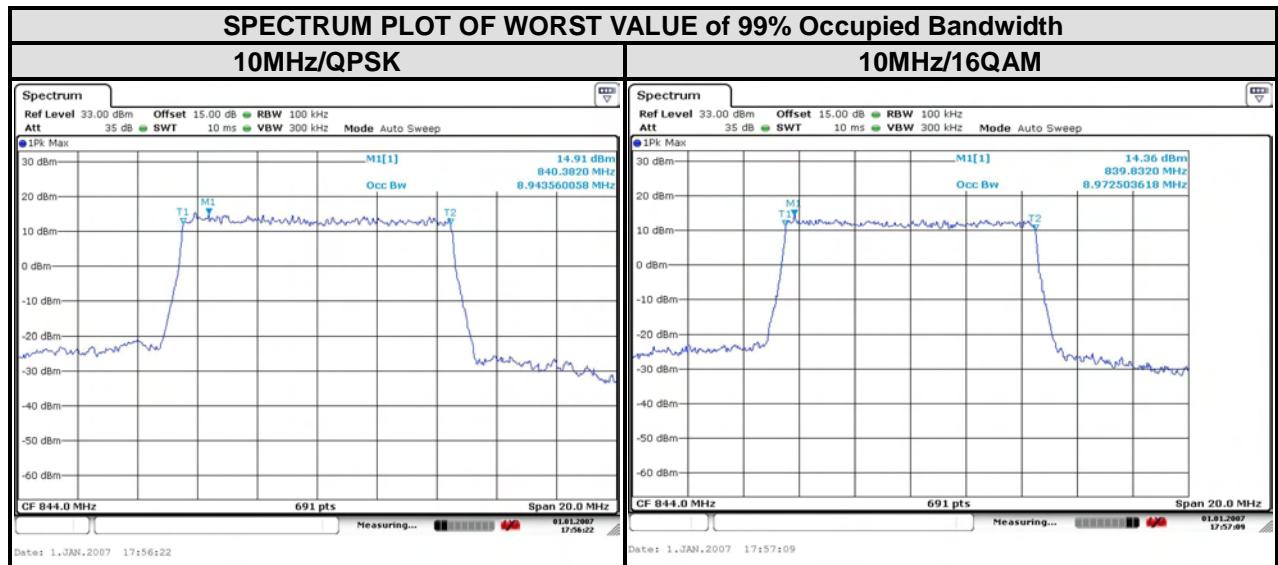



## 4.4 BAND EDGE MEASUREMENT

### 4.4.1 LIMITS OF BAND EDGE MEASUREMENT

Power of any emission outside of the authorized operating frequency ranges must be attenuated below the transmitting power (P) by a factor of at least  $43 + 10 \log(P)$  dB. In the 1 MHz bands immediately outside and adjacent to the frequency block a resolution bandwidth of at least one percent of the emission bandwidth of the fundamental emission of the transmitter may be employed.

### 4.4.2 TEST SETUP

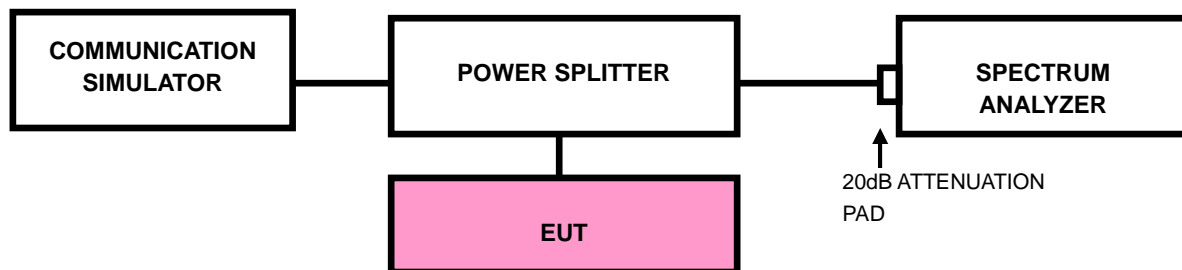

### 4.4.3 TEST PROCEDURES

- All measurements were done at low and high operational frequency range.
- The center frequency of spectrum is the band edge frequency and span is 1.5MHz. RBW of the spectrum is 10kHz and VBW of the spectrum is 30kHz (GSM/GPRS/EDGE).
- The center frequency of spectrum is the band edge frequency and span is 10MHz. RBW of the spectrum is 100kHz and VBW of the spectrum is 300kHz (WCDMA).
- The center frequency of spectrum is the band edge frequency and span is 1~5 MHz. RB of the spectrum is 20kHz and VB of the spectrum is 100 kHz. (LTE bandwidth 1.4MHz).
- The center frequency of spectrum is the band edge frequency and span is 1~5 MHz. RB of the spectrum is 30kHz and VB of the spectrum is 100kHz. (LTE bandwidth 3MHz)



**Test Report No.: RF141111N015-3**

- f. The center frequency of spectrum is the band edge frequency and span is 1~5 MHz. RB of the spectrum is 50kHz and VB of the spectrum is 200kHz. (LTE bandwidth 5MHz)
- g. The center frequency of spectrum is the band edge frequency and span is 1~5 MHz. RB of the spectrum is 100kHz and VB of the spectrum is 300kHz. (LTE bandwidth 10MHz)
- h. Record the max trace plot into the test report.



### 4.4.4 TEST RESULTS

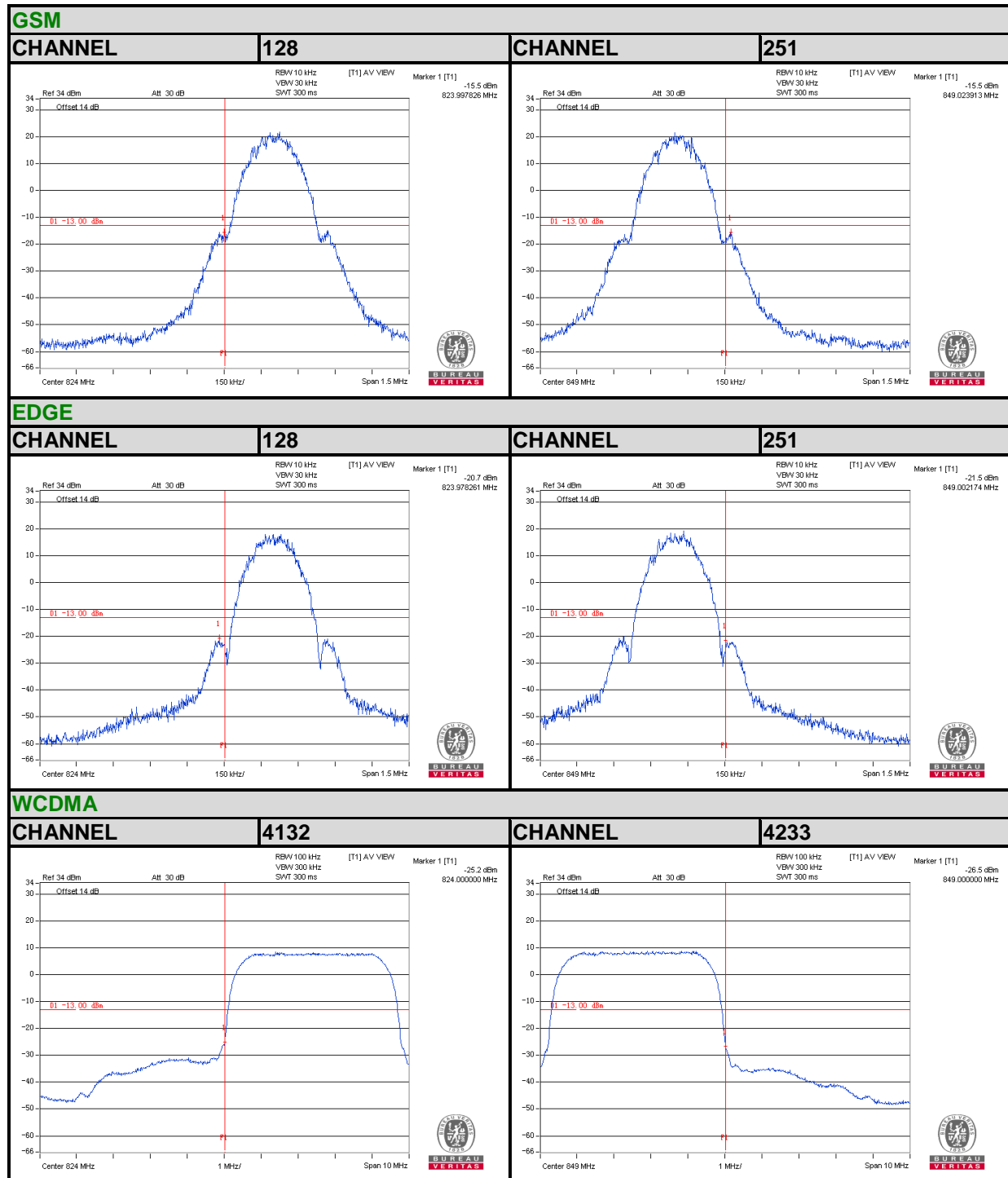



**LTE Band5**

**Channel Bandwidth: 1.4MHz**

|                |              |             |                |              |             |
|----------------|--------------|-------------|----------------|--------------|-------------|
| <b>CHANNEL</b> | <b>20407</b> | <b>1 RB</b> | <b>CHANNEL</b> | <b>20643</b> | <b>1 RB</b> |
|----------------|--------------|-------------|----------------|--------------|-------------|

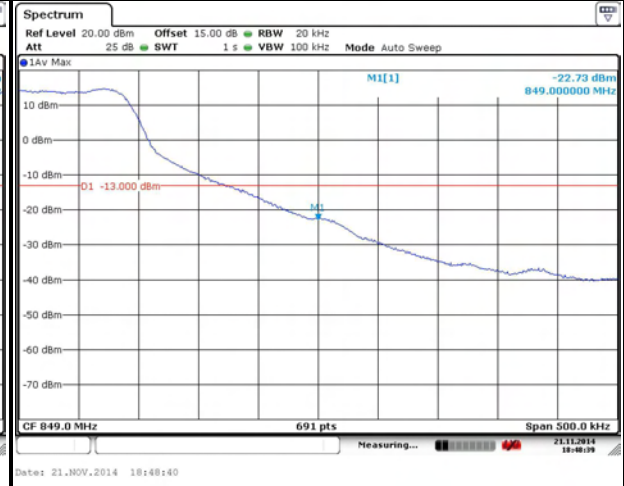
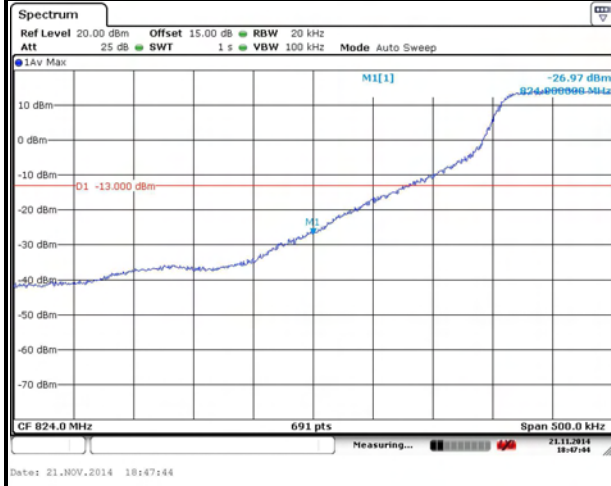

**LTE Band5**

**Channel Bandwidth: 1.4MHz**

|                |              |                |                |              |                |
|----------------|--------------|----------------|----------------|--------------|----------------|
| <b>CHANNEL</b> | <b>20407</b> | <b>Full RB</b> | <b>CHANNEL</b> | <b>20643</b> | <b>Full RB</b> |
|----------------|--------------|----------------|----------------|--------------|----------------|

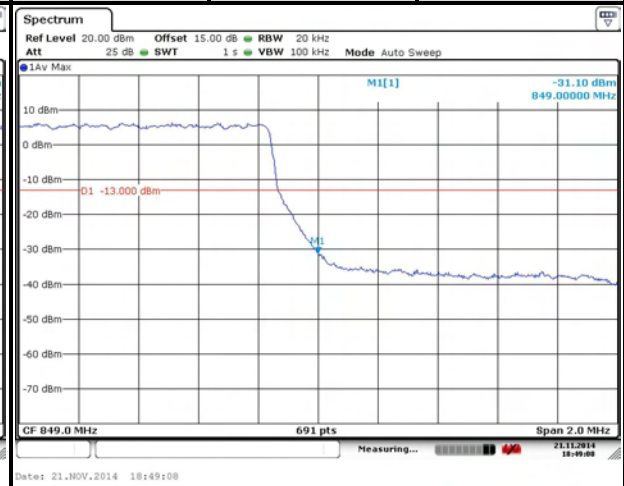
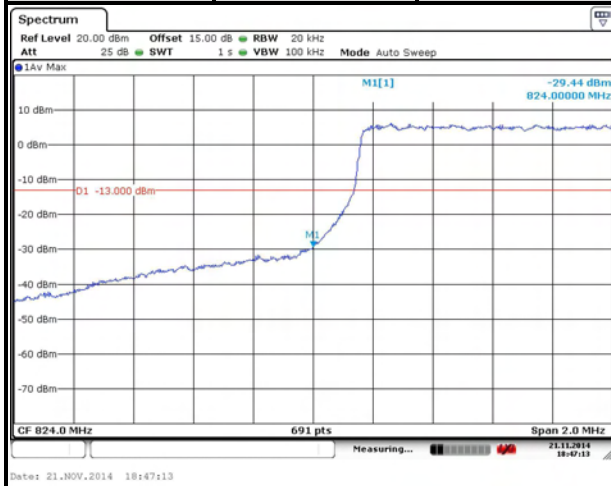



**LTE Band5**

**Channel Bandwidth: 3MHz**

|                |              |             |                |              |             |
|----------------|--------------|-------------|----------------|--------------|-------------|
| <b>CHANNEL</b> | <b>20415</b> | <b>1 RB</b> | <b>CHANNEL</b> | <b>20635</b> | <b>1 RB</b> |
|----------------|--------------|-------------|----------------|--------------|-------------|

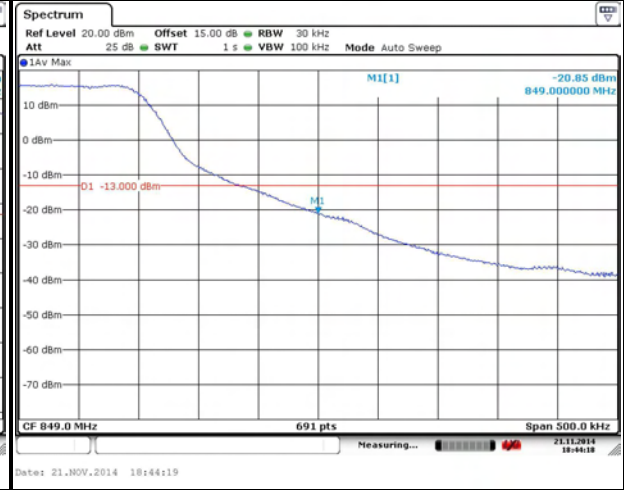
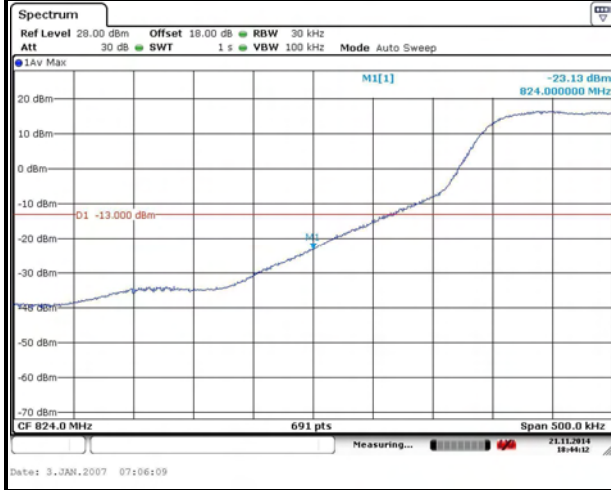

**LTE Band5**

**Channel Bandwidth: 3MHz**

|                |              |                |                |              |                |
|----------------|--------------|----------------|----------------|--------------|----------------|
| <b>CHANNEL</b> | <b>20415</b> | <b>Full RB</b> | <b>CHANNEL</b> | <b>20635</b> | <b>Full RB</b> |
|----------------|--------------|----------------|----------------|--------------|----------------|

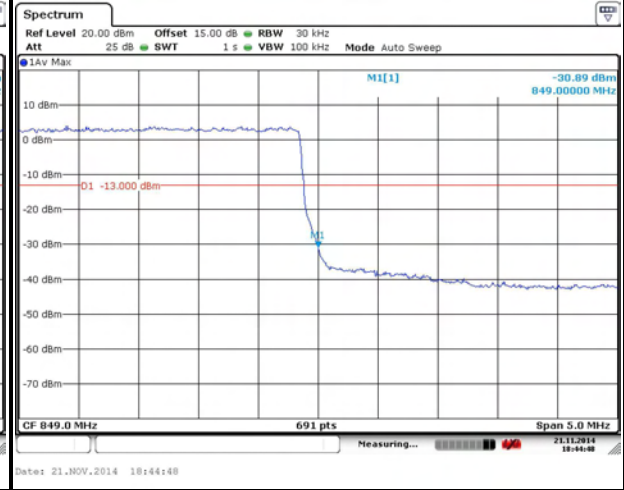
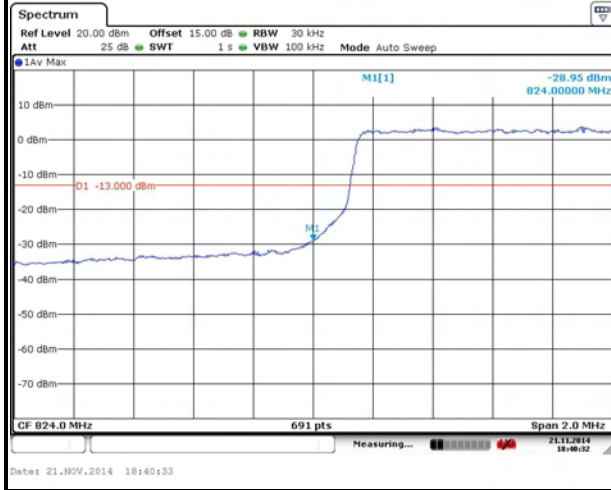



**LTE Band5**

**Channel Bandwidth: 5MHz**

|                |              |             |                |              |             |
|----------------|--------------|-------------|----------------|--------------|-------------|
| <b>CHANNEL</b> | <b>20425</b> | <b>1 RB</b> | <b>CHANNEL</b> | <b>20625</b> | <b>1 RB</b> |
|----------------|--------------|-------------|----------------|--------------|-------------|

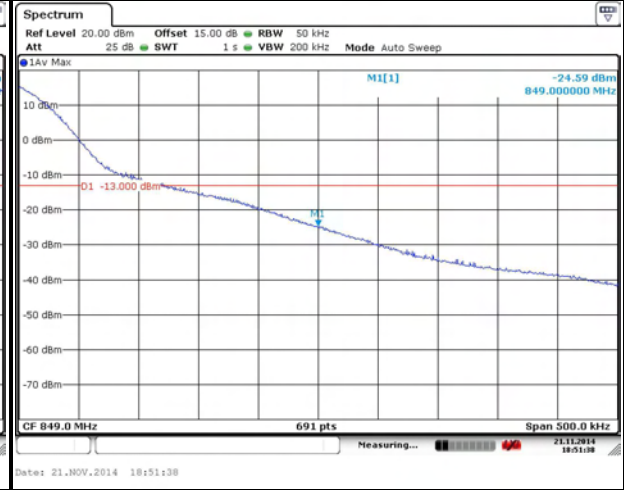
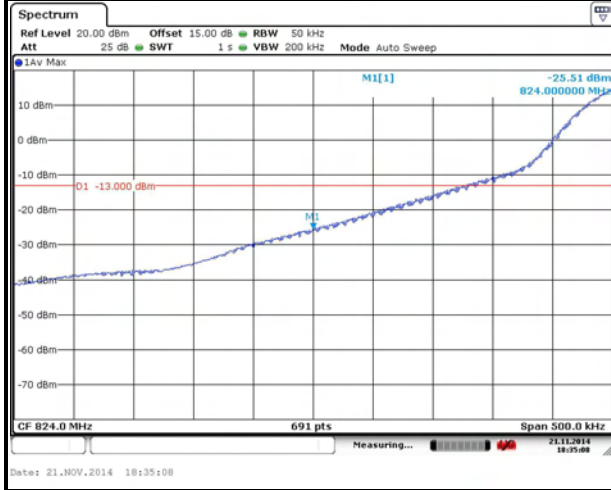

**LTE Band5**

**Channel Bandwidth: 5MHz**

|                |              |                |                |              |                |
|----------------|--------------|----------------|----------------|--------------|----------------|
| <b>CHANNEL</b> | <b>20425</b> | <b>Full RB</b> | <b>CHANNEL</b> | <b>20625</b> | <b>Full RB</b> |
|----------------|--------------|----------------|----------------|--------------|----------------|

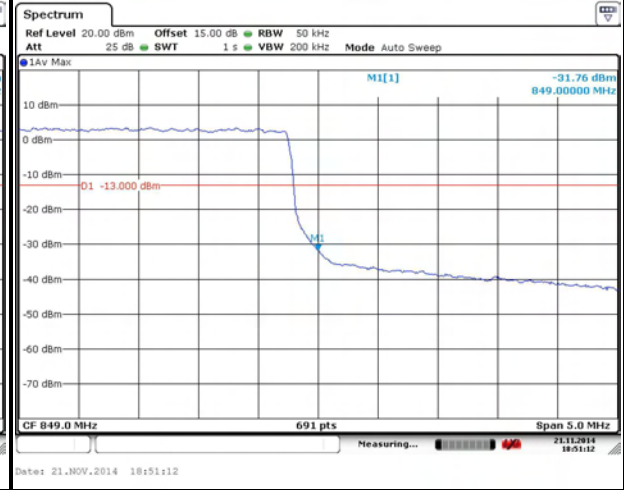
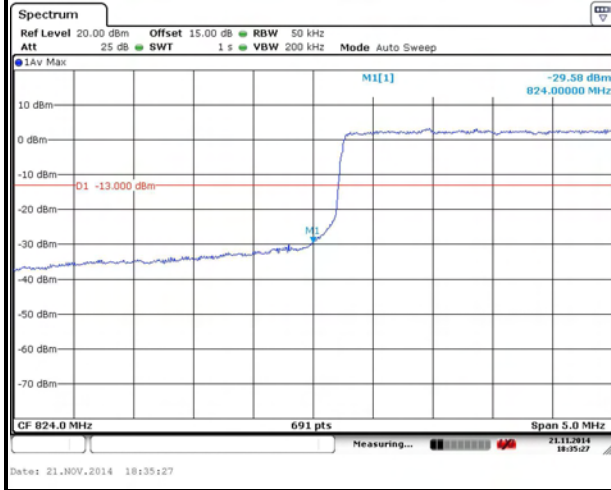



**LTE Band5**

**Channel Bandwidth: 10MHz**

|                |              |             |                |              |             |
|----------------|--------------|-------------|----------------|--------------|-------------|
| <b>CHANNEL</b> | <b>20450</b> | <b>1 RB</b> | <b>CHANNEL</b> | <b>20600</b> | <b>1 RB</b> |
|----------------|--------------|-------------|----------------|--------------|-------------|

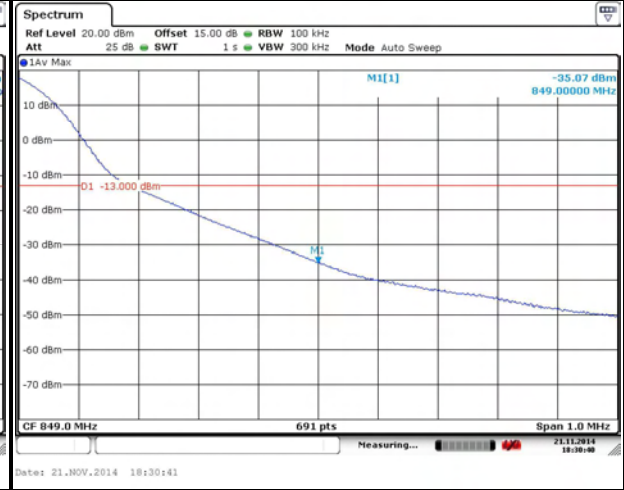
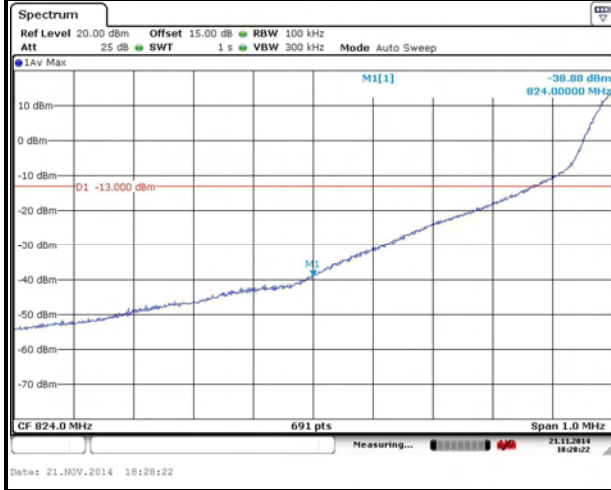

**LTE Band5**

**Channel Bandwidth: 10MHz**

|                |              |                |                |              |                |
|----------------|--------------|----------------|----------------|--------------|----------------|
| <b>CHANNEL</b> | <b>20450</b> | <b>Full RB</b> | <b>CHANNEL</b> | <b>20600</b> | <b>Full RB</b> |
|----------------|--------------|----------------|----------------|--------------|----------------|

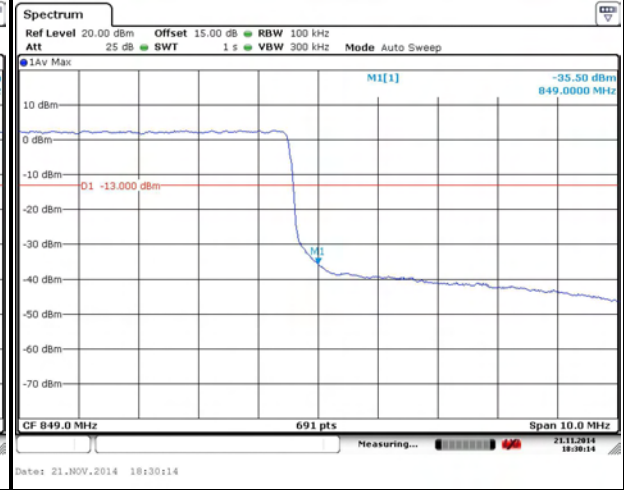
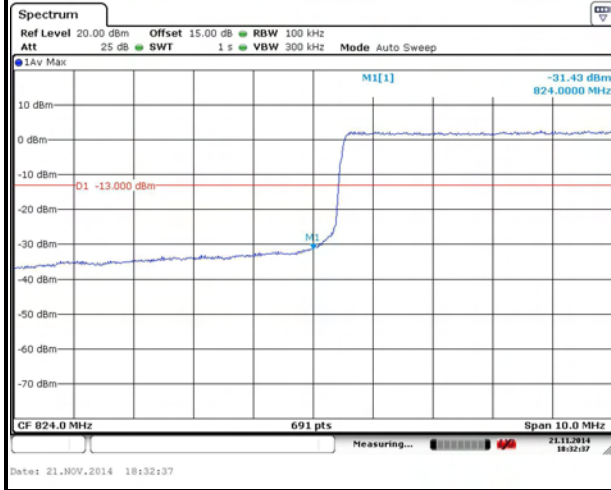

## 4.5 CONDUCTED SPURIOUS EMISSIONS

### 4.5.1 LIMITS OF CONDUCTED SPURIOUS EMISSIONS MEASUREMENT

The power of any emission outside of the authorized operating frequency ranges must be attenuated below the transmitting power (P) by a factor of at least  $43 + 10 \log(P)$  dB. The emission limit equal to  $-13\text{dBm}$ .

### 4.5.2 TEST PROCEDURE

- a. The EUT makes a phone call to the communication simulator. All measurements were done at low, middle and high operational frequency range.
- b. Measuring frequency range is from 9 kHz to 9GHz. 20dB attenuation pad is connected with spectrum. RBW=1MHz and VBW=3MHz is used for conducted emission measurement.

### 4.5.3 TEST SETUP

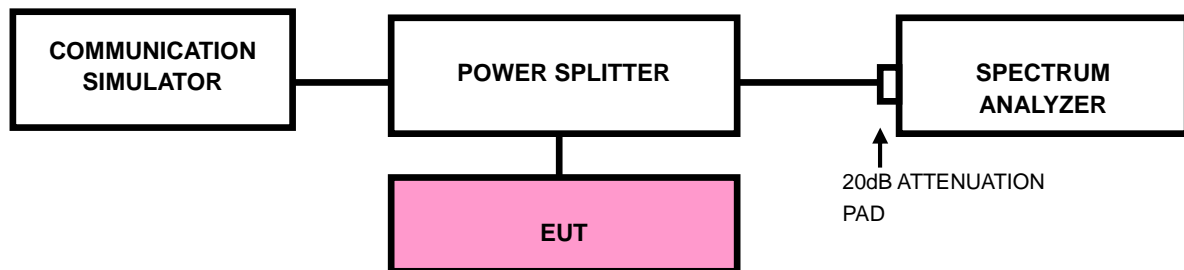





### 4.5.4 TEST RESULTS

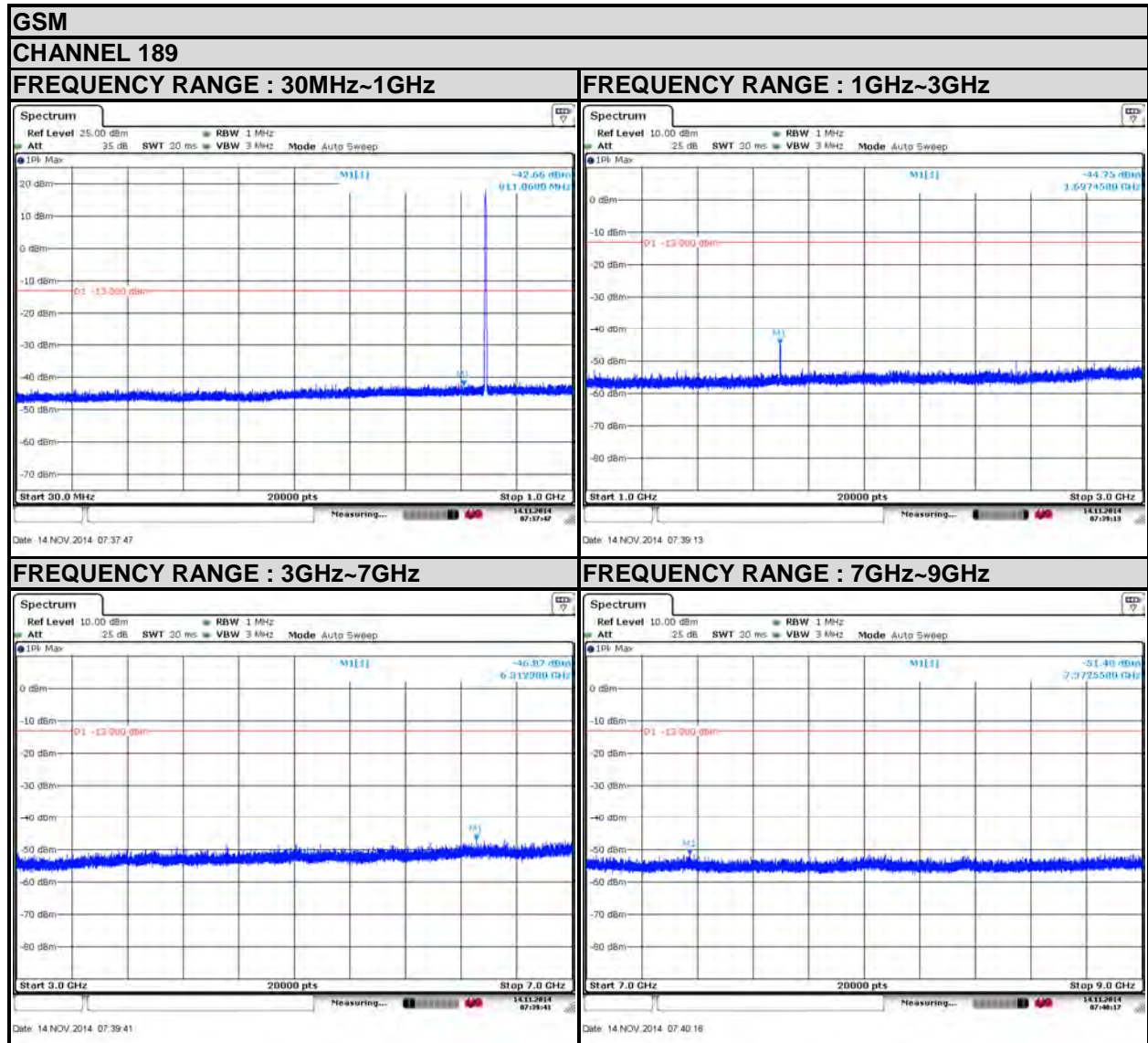



Test Report No.: RF141111N015-3

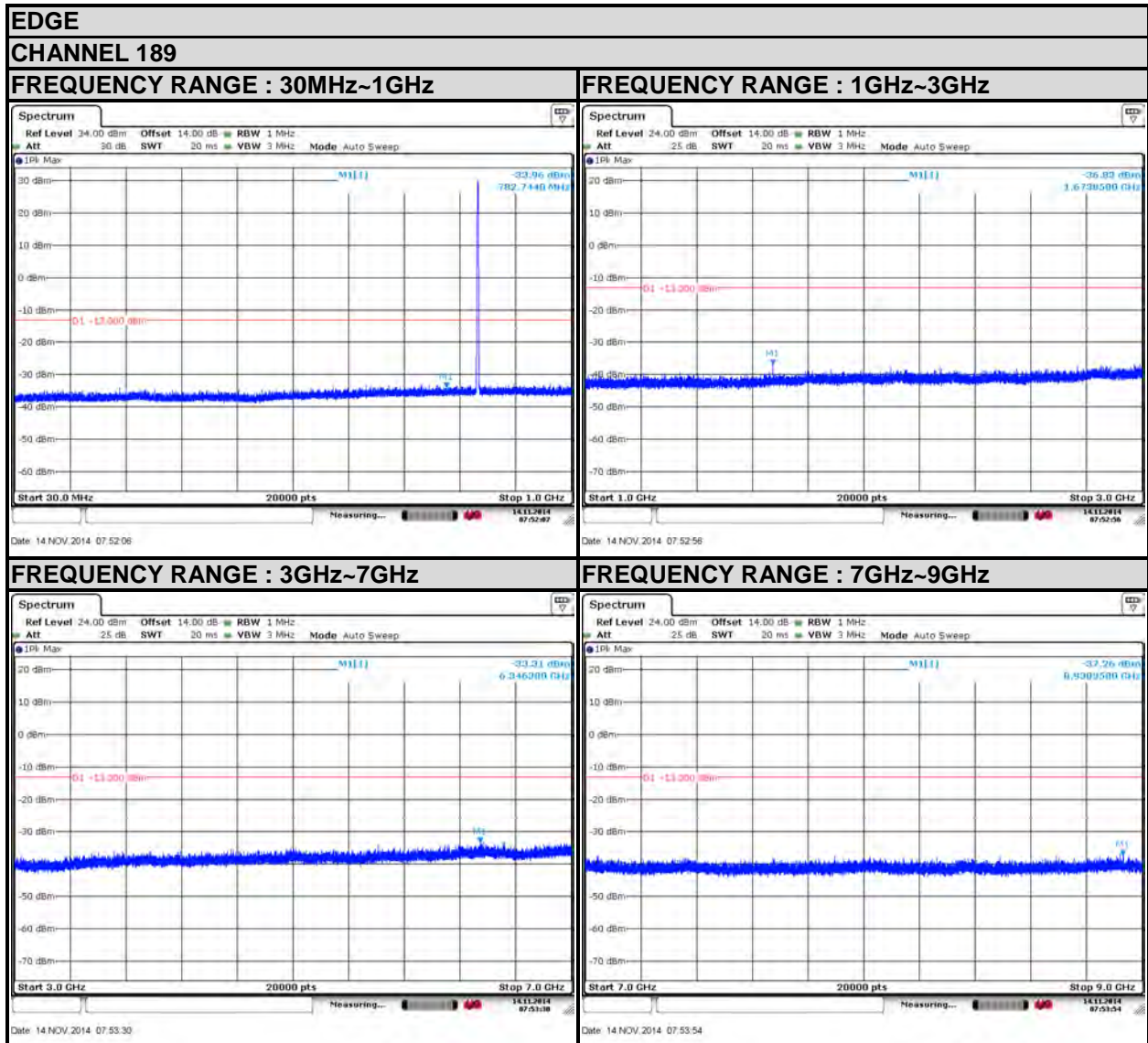

Bureau Veritas Shenzhen Co., Ltd.  
Dongguan Branch

No. 34, Chenwulu Section, Guantai Rd.,  
Houjie Town, Dongguan City,  
Guangdong 523942, China

Tel: +86 769 8593 5656  
Fax: +86 769 8593 1080  
Email: [customerservice.dg@cn.bureauveritas.com](mailto:customerservice.dg@cn.bureauveritas.com)



Test Report No.: RF141111N015-3

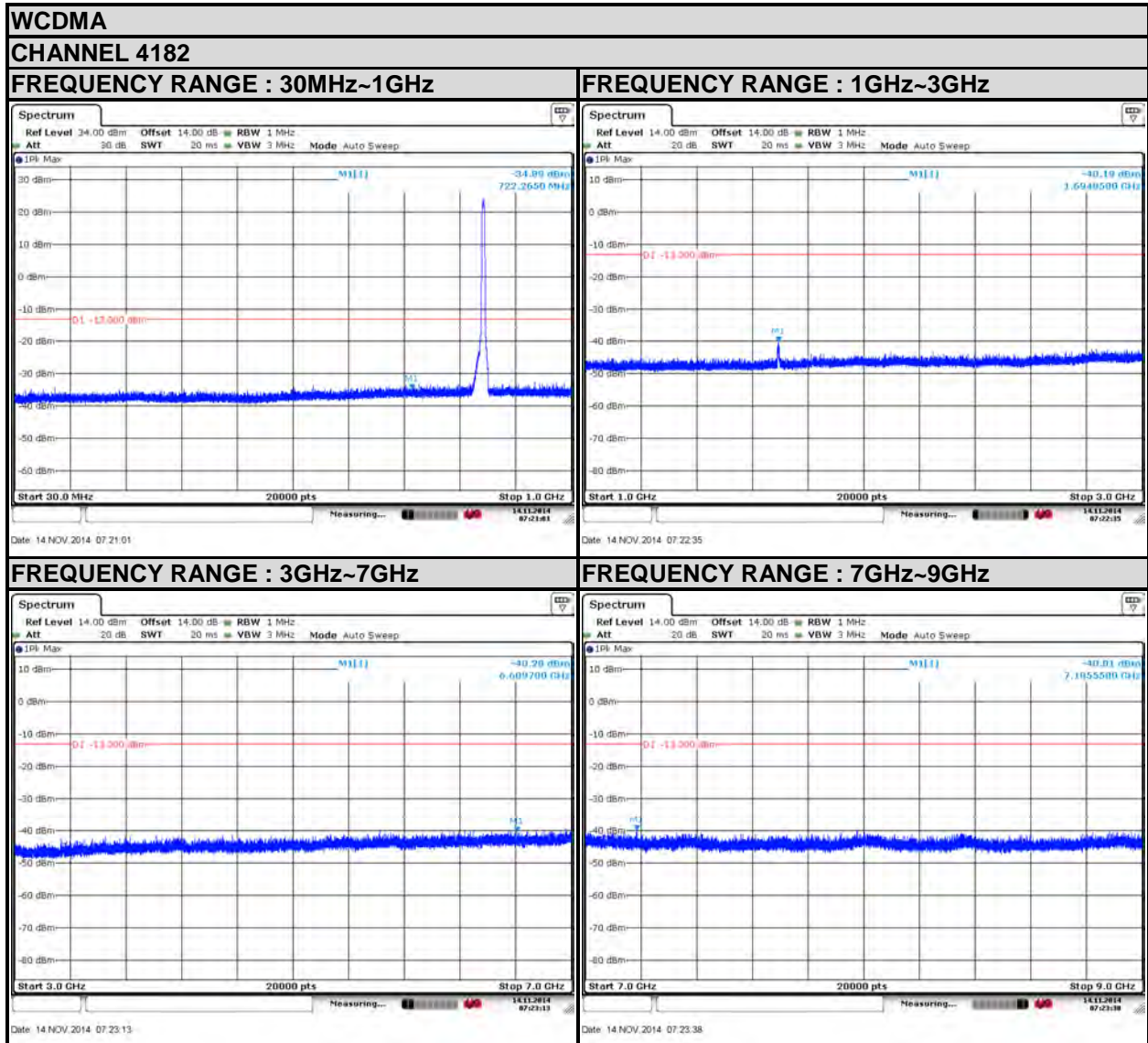

Bureau Veritas Shenzhen Co., Ltd.  
Dongguan Branch

No. 34, Chenwulu Section, Guantai Rd.,  
Houjie Town, Dongguan City,  
Guangdong 523942, China

Tel: +86 769 8593 5656  
Fax: +86 769 8593 1080  
Email: [customerservice.dg@cn.bureauveritas.com](mailto:customerservice.dg@cn.bureauveritas.com)

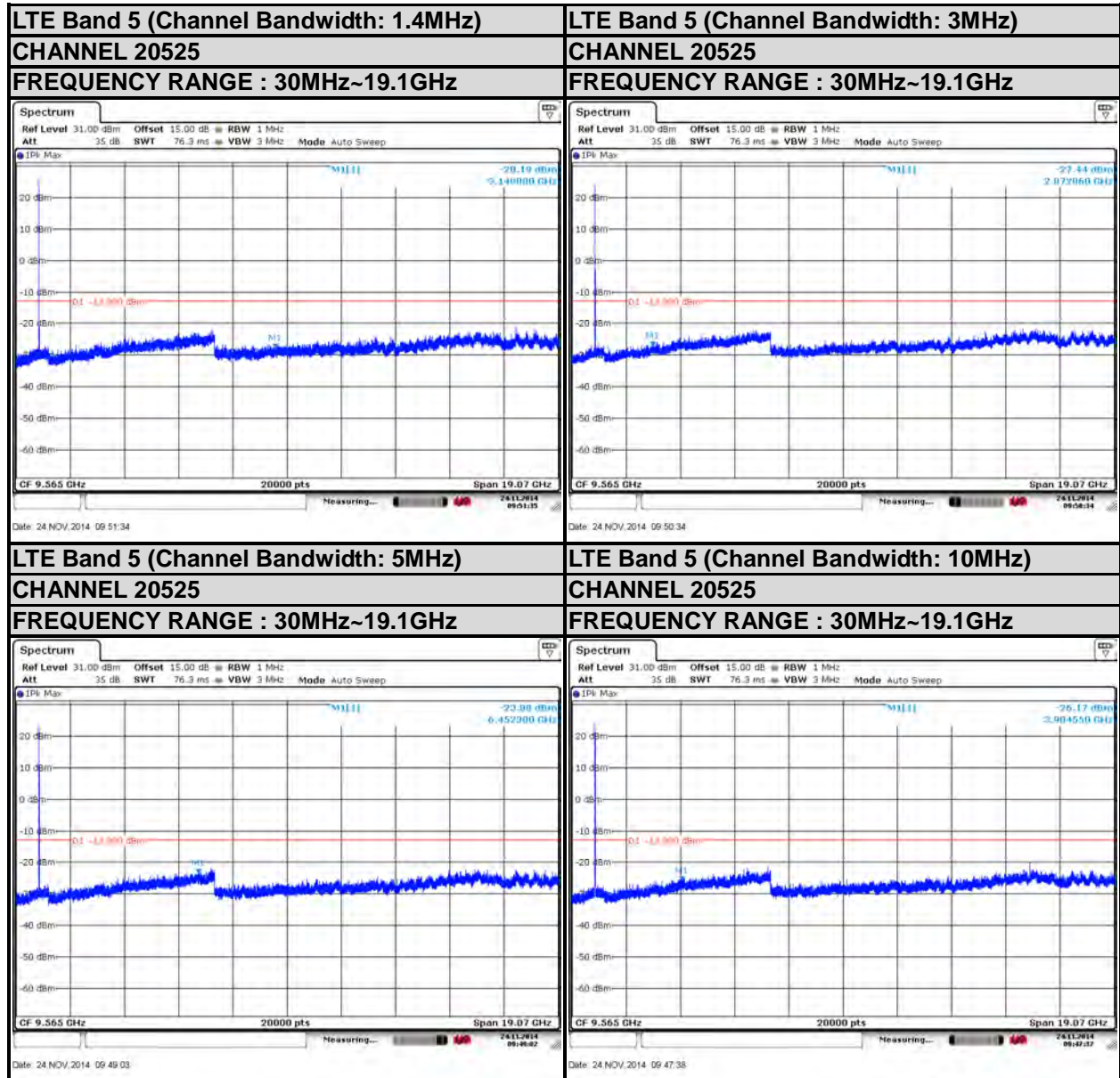



## 4.6 RADIATED EMISSION MEASUREMENT

### 4.6.1 LIMITS OF RADIATED EMISSION MEASUREMENT

The power of any emission outside of the authorized operating frequency ranges must be attenuated below the transmitting power (P) by a factor of at least  $43 + 10 \log(P)$  dB. The emission limit equal to  $-13\text{dBm}$ .

### 4.6.2 TEST PROCEDURES

- a. Substitution method is used for E.I.R.P measurement. In the semi-anechoic chamber, EUT placed on the 0.8m height of Turn Table, rotated the table around 360 degrees to search the maximum radiation power and receiver antenna shall be rotated vertical and horizontal polarization and moved height from 1m to 4m to find the maximum polar radiated power. The “Read Value” is the spectrum reading the maximum power value.
- b. The substitution horn antenna is substituted for EUT at the same position and signals generator export the CW signal to the substitution antenna via a TX cable. Rotated the Turn Table and moved receiving antenna to find the maximum radiation power. Adjust output power level of S.G to get a Value of spectrum reading equal to “Read Value “ of step a. Record the power level of S.G
- c.  $\text{EIRP} = \text{Output power level of S.G} - \text{TX cable loss} + \text{Antenna gain of substitution horn}$ .
- d. E.R.P power can be calculated form E.I.R.P power by subtracting the gain of dipole,  $\text{E.R.P power} = \text{E.I.P.R power} - 2.15\text{dBi}$ .

**NOTE:** The resolution bandwidth and video bandwidth of test receiver/spectrum analyzer is 1MHz/3MHz.

### 4.6.3 DEVIATION FROM TEST STANDARD

No deviation

#### 4.6.4 TEST SETUP

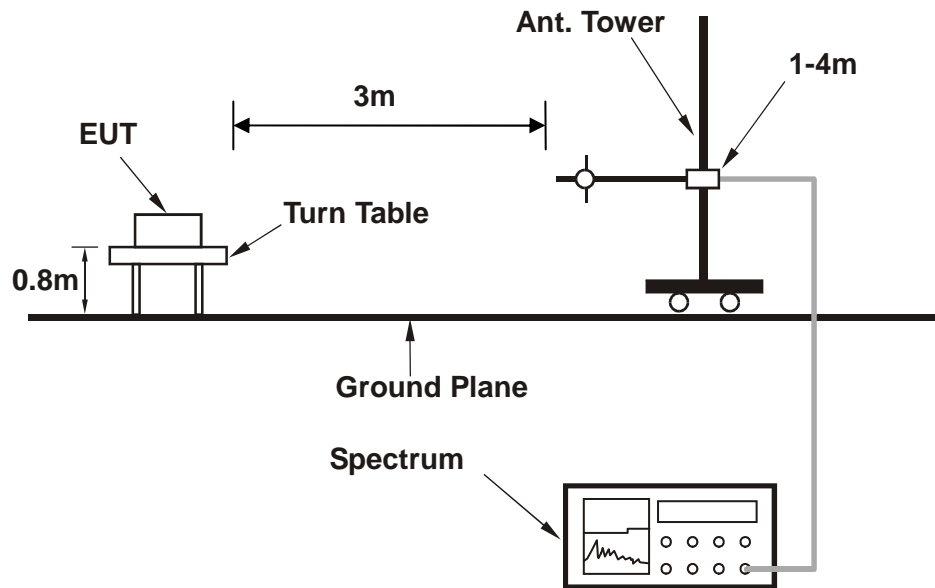

For the actual test configuration, please refer to the attached file (Test Setup Photo).



4.6.5 TEST RESULTS

BELOW 1GHz WORST-CASE DATA : LTE BAND 5

|  |               |                          |               |
|--|---------------|--------------------------|---------------|
| <b>SPURIOUS EMISSION FREQUENCY RANGE</b> | Below 1000MHz | <b>OPERATING CHANNEL</b> | Channel 20525 |
|--|---------------|--------------------------|---------------|

| SPURIOUS EMISSION LEVEL |                      |             |             |             |
|-------------------------|----------------------|-------------|-------------|-------------|
| Frequency (MHz)         | Antenna Polarization | Level (dBm) | Limit (dBm) | Margin (dB) |
| 65.75                   | H                    | -75.75      | -13         | -62.75      |
| 227.42                  | H                    | -72.58      | -13         | -59.58      |
| 303.59                  | H                    | -73.1       | -13         | -60.1       |
| 379.76                  | H                    | -67.53      | -13         | -54.53      |
| 420.18                  | H                    | -74.4       | -13         | -61.4       |
| 620.71                  | H                    | -74.65      | -13         | -61.65      |

NOTE: The emission behavior belongs to narrowband spurious emission.

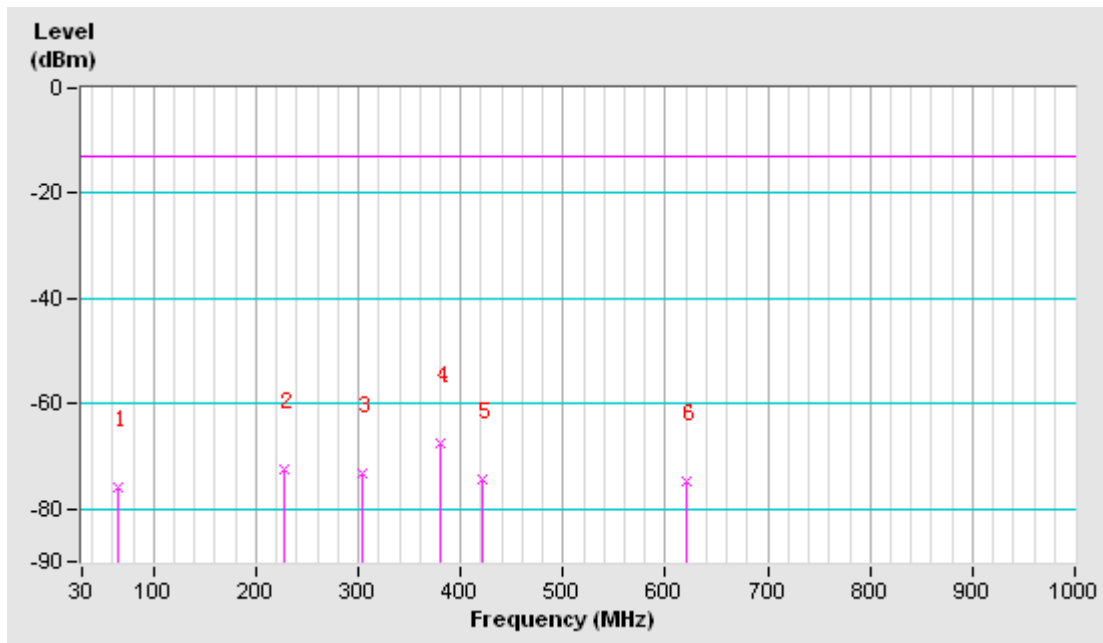



|  |               |                          |               |
|--|---------------|--------------------------|---------------|
| <b>SPURIOUS EMISSION FREQUENCY RANGE</b> | Below 1000MHz | <b>OPERATING CHANNEL</b> | Channel 20525 |
|--|---------------|--------------------------|---------------|

| SPURIOUS EMISSION LEVEL |                      |             |             |             |
|-------------------------|----------------------|-------------|-------------|-------------|
| Frequency (MHz)         | Antenna Polarization | Level (dBm) | Limit (dBm) | Margin (dB) |
| 132.6                   | V                    | -74.71      | -13         | -61.71      |
| 227.42                  | V                    | -67.89      | -13         | -54.89      |
| 303.59                  | V                    | -70.43      | -13         | -57.43      |
| 379.76                  | V                    | -70.08      | -13         | -57.08      |
| 457.48                  | V                    | -65.54      | -13         | -52.54      |
| 532.1                   | V                    | -68.43      | -13         | -55.43      |

**NOTE:** The emission behavior belongs to narrowband spurious emission.

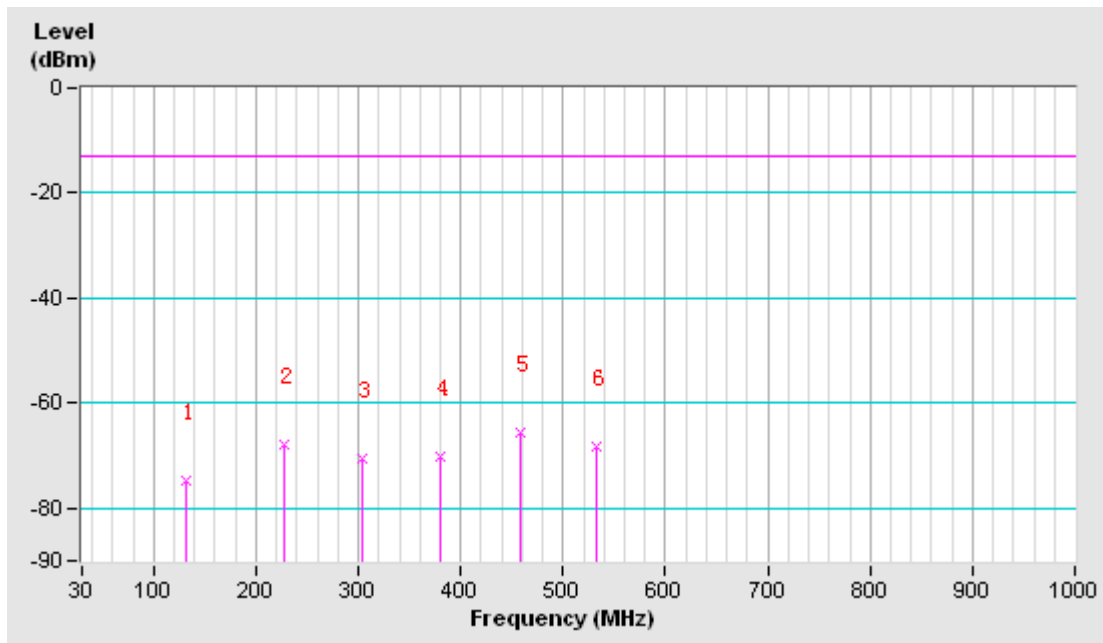





Test Report No.: RF141111N015-3

**ABOVE 1GHz DATA**

**GSM:**

| ANTENNA POLARITY & TEST DISTANCE: HORIZONTAL AT 3 M |             |                   |             |                       |                        |           |             |
|---|-------------|-------------------|-------------|-----------------------|------------------------|-----------|-------------|
| No.   | Freq. (MHz) | SPA READING (dBm) | Limit (dBm) | S.G Power Value (dBm) | Correction Factor (dB) | ERP (dBm) | Margin (dB) |
| 1   | 1672        | -51.36            | -13         | -44.75                | 0.11                   | -44.64    | -31.64      |
| 2   | 2509        | -63.01            | -13         | -52.90                | -0.06                  | -52.96    | -39.96      |
| 3   | 3345        | -66.13            | -13         | -54.54                | 0.69                   | -53.85    | -40.85      |
| 4   | 4182        | -69.88            | -13         | -56.05                | 0.12                   | -55.93    | -42.93      |
| ANTENNA POLARITY & TEST DISTANCE: VERTICAL AT 3 M   |             |                   |             |                       |                        |           |             |
| No.   | Freq. (MHz) | SPA READING (dBm) | Limit (dBm) | S.G Power Value (dBm) | Correction Factor (dB) | ERP (dBm) | Margin (dB) |
| 1   | 1672        | -56.42            | -13         | -45.47                | 0.11                   | -45.36    | -32.36      |
| 2   | 2509        | -63.55            | -13         | -51.80                | -0.06                  | -51.86    | -38.86      |
| 3   | 3345        | -68.84            | -13         | -56.48                | 0.69                   | -55.79    | -42.79      |
| 4   | 4182        | -69.27            | -13         | -52.16                | 0.12                   | -52.04    | -39.04      |

**REMARKS:**

1. ERP (dBm) = S.G Value (dBm) + Correction Factor (dB).
2. Correction Factor (dB) = Substitution Antenna Gain (dB) + Cable Loss (dB) - 2.15 (dB)

**EDGE:**

| ANTENNA POLARITY & TEST DISTANCE: HORIZONTAL AT 3 M |             |                       |             |                       |                        |           |             |
|---|-------------|-----------------------|-------------|-----------------------|------------------------|-----------|-------------|
| No.   | Freq. (MHz) | Emission Level (dBuV) | Limit (dBm) | S.G Power Value (dBm) | Correction Factor (dB) | ERP (dBm) | Margin (dB) |
| 1   | 1672        | -53.47                | -13         | -46.88                | 0.11                   | -46.77    | -33.77      |
| 2   | 2509        | -64.28                | -13         | -54.17                | -0.06                  | -54.23    | -41.23      |
| 3   | 3345        | -66.2                 | -13         | -54.61                | 0.69                   | -53.92    | -40.92      |
| 4   | 4182        | -69.06                | -13         | -55.23                | 0.12                   | -55.11    | -42.11      |
| ANTENNA POLARITY & TEST DISTANCE: VERTICAL AT 3 M   |             |                       |             |                       |                        |           |             |
| No.   | Freq. (MHz) | Emission Level (dBuV) | Limit (dBm) | S.G Power Value (dBm) | Correction Factor (dB) | ERP (dBm) | Margin (dB) |
| 1   | 1672        | -58.12                | -13         | -47.17                | 0.11                   | -47.06    | -34.06      |
| 2   | 2509        | -65.67                | -13         | -53.97                | -0.06                  | -54.03    | -41.03      |
| 3   | 3345        | -68.91                | -13         | -56.55                | 0.69                   | -55.86    | -42.86      |
| 4   | 4182        | -69.75                | -13         | -52.64                | 0.12                   | -52.52    | -39.52      |

**REMARKS:**

1. ERP (dBm) = S.G Value (dBm) + Correction Factor (dB).
2. Correction Factor (dB) = Substitution Antenna Gain (dB) + Cable Loss (dB) - 2.15 (dB)

Bureau Veritas Shenzhen Co., Ltd.  
Dongguan Branch

No. 34, Chenwulu Section, Guantai Rd.,  
Houjie Town, Dongguan City,  
Guangdong 523942, China

Tel: +86 769 8593 5656  
Fax: +86 769 8593 1080  
Email: [customerservice.dg@cn.bureauveritas.com](mailto:customerservice.dg@cn.bureauveritas.com)



Test Report No.: RF141111N015-3

WCDMA:

| ANTENNA POLARITY & TEST DISTANCE: HORIZONTAL AT 3 M |             |                   |             |                       |                        |           |             |
|---|-------------|-------------------|-------------|-----------------------|------------------------|-----------|-------------|
| No.   | Freq. (MHz) | SPA READING (dBm) | Limit (dBm) | S.G Power Value (dBm) | Correction Factor (dB) | ERP (dBm) | Margin (dB) |
| 1   | 1672        | -56.46            | -13         | -49.89                | 0.11                   | -49.78    | -36.78      |
| 2   | 2509        | -59.91            | -13         | -49.79                | -0.06                  | -49.85    | -36.85      |
| 3   | 3345        | -68.24            | -13         | -56.66                | 0.69                   | -55.97    | -42.97      |
| 4   | 4182        | -69.93            | -13         | -56.10                | 0.12                   | -55.98    | -42.98      |
| ANTENNA POLARITY & TEST DISTANCE: VERTICAL AT 3 M   |             |                   |             |                       |                        |           |             |
| No.   | Freq. (MHz) | SPA READING (dBm) | Limit (dBm) | S.G Power Value (dBm) | Correction Factor (dB) | ERP (dBm) | Margin (dB) |
| 1   | 1672        | -52.21            | -13         | -41.26                | 0.11                   | -41.15    | -28.15      |
| 2   | 2509        | -57.31            | -13         | -45.41                | -0.06                  | -45.47    | -32.47      |
| 3   | 3345        | -69.22            | -13         | -56.86                | 0.69                   | -56.17    | -43.17      |
| 4   | 4182        | -70.23            | -13         | -53.12                | 0.12                   | -53.00    | -40.00      |

**REMARKS:**

- ERP (dBm) = S.G Value (dBm) + Correction Factor (dB).
- Correction Factor (dB) = Substitution Antenna Gain (dB) + Cable Loss (dB) - 2.15 (dB)

**LTE BAND 5**

**CHANNEL BANDWIDTH: 1.4MHz / QPSK**

|                                 |                  |                        |                    |
|---------------------------------|------------------|------------------------|--------------------|
| <b>MODE</b>                     | TX channel 20525 | <b>FREQUENCY RANGE</b> | Above 1000MHz      |
| <b>ENVIRONMENTAL CONDITIONS</b> | 24deg. C, 60%RH  | <b>INPUT POWER</b>     | DC 5V from adapter |
| <b>TESTED BY</b>                | Blue Zheng       |                        |                    |

| ANTENNA POLARITY & TEST DISTANCE: HORIZONTAL AT 3 M |             |               |             |                       |                        |           |             |
|---|-------------|---------------|-------------|-----------------------|------------------------|-----------|-------------|
| No.   | Freq. (MHz) | Reading (dBm) | Limit (dBm) | S.G Power Value (dBm) | Correction Factor (dB) | ERP (dBm) | Margin (dB) |
| 1   | 1672        | -46.96        | -13         | -40.32                | 0.11                   | -40.21    | -27.21      |
| 2   | 2509        | -60.53        | -13         | -50.41                | -0.06                  | -50.47    | -37.47      |
| 3   | 3345        | -68.25        | -13         | -56.67                | 0.69                   | -55.98    | -42.98      |
| 4   | 4182        | -68.95        | -13         | -55.12                | 0.12                   | -55.00    | -42.00      |
| ANTENNA POLARITY & TEST DISTANCE: VERTICAL AT 3 M   |             |               |             |                       |                        |           |             |
| No.   | Freq. (MHz) | Reading (dBm) | Limit (dBm) | S.G Power Value (dBm) | Correction Factor (dB) | ERP (dBm) | Margin (dB) |
| 1   | 1672        | -49.63        | -13         | -38.68                | 0.11                   | -38.57    | -25.57      |
| 2   | 2509        | -62.58        | -13         | -50.77                | -0.06                  | -50.83    | -37.83      |
| 3   | 3345        | -67.95        | -13         | -55.58                | 0.69                   | -54.89    | -41.89      |
| 4   | 4182        | -68.88        | -13         | -51.77                | 0.12                   | -51.65    | -38.65      |

**REMARKS:**

- ERP (dBm) = S.G Value (dBm) + Correction Factor (dB).
- Correction Factor (dB) = Substitution Antenna Gain (dB) + Cable Loss (dB) - 2.15 (dB)

Bureau Veritas Shenzhen Co., Ltd.  
Dongguan Branch

No. 34, Chenwulu Section, Guantai Rd.,  
Houjie Town, Dongguan City,  
Guangdong 523942, China

Tel: +86 769 8593 5656  
Fax: +86 769 8593 1080  
Email: [customerservice.dg@cn.bureauveritas.com](mailto:customerservice.dg@cn.bureauveritas.com)



Test Report No.: RF141111N015-3

**CHANNEL BANDWIDTH: 3MHz / QPSK**

|                                 |                  |                        |                    |
|---------------------------------|------------------|------------------------|--------------------|
| <b>MODE</b>                     | TX channel 20525 | <b>FREQUENCY RANGE</b> | Above 1000MHz      |
| <b>ENVIRONMENTAL CONDITIONS</b> | 24deg. C, 60%RH  | <b>INPUT POWER</b>     | DC 5V from adapter |
| <b>TESTED BY</b>                | Blue Zheng       |                        |                    |

| <b>ANTENNA POLARITY &amp; TEST DISTANCE: HORIZONTAL AT 3 M</b> |             |               |             |                       |                        |           |             |
|--|-------------|---------------|-------------|-----------------------|------------------------|-----------|-------------|
| No.  | Freq. (MHz) | Reading (dBm) | Limit (dBm) | S.G Power Value (dBm) | Correction Factor (dB) | ERP (dBm) | Margin (dB) |
| 1  | 1672        | -49.63        | -13         | -43.01                | 0.11                   | -42.90    | -29.90      |
| 2  | 2509        | -62.53        | -13         | -52.42                | -0.06                  | -52.48    | -39.48      |
| 3  | 3345        | -67.49        | -13         | -55.91                | 0.69                   | -55.22    | -42.22      |
| 4  | 4182        | -68.59        | -13         | -54.76                | 0.12                   | -54.64    | -41.64      |
| <b>ANTENNA POLARITY &amp; TEST DISTANCE: VERTICAL AT 3 M</b>   |             |               |             |                       |                        |           |             |
| No.  | Freq. (MHz) | Reading (dBm) | Limit (dBm) | S.G Power Value (dBm) | Correction Factor (dB) | ERP (dBm) | Margin (dB) |
| 1  | 1672        | -50.63        | -13         | -39.68                | 0.11                   | -39.57    | -26.57      |
| 2  | 2509        | -62.35        | -13         | -50.54                | -0.06                  | -50.60    | -37.60      |
| 3  | 3345        | -68.49        | -13         | -56.12                | 0.69                   | -55.43    | -42.43      |
| 4  | 4182        | -68.53        | -13         | -51.42                | 0.12                   | -51.30    | -38.30      |

**REMARKS:**

- 1. ERP (dBm) = S.G Value (dBm) + Correction Factor (dB).
- 2. Correction Factor (dB) = Substitution Antenna Gain (dB) + Cable Loss (dB) - 2.15 (dB)



Test Report No.: RF141111N015-3

**CHANNEL BANDWIDTH: 5MHz / QPSK**

|                                 |                  |                        |                    |
|---------------------------------|------------------|------------------------|--------------------|
| <b>MODE</b>                     | TX channel 20525 | <b>FREQUENCY RANGE</b> | Above 1000MHz      |
| <b>ENVIRONMENTAL CONDITIONS</b> | 24deg. C, 60%RH  | <b>INPUT POWER</b>     | DC 5V from adapter |
| <b>TESTED BY</b>                | Blue Zheng       |                        |                    |

**ANTENNA POLARITY & TEST DISTANCE: HORIZONTAL AT 3 M**

| No. | Freq. (MHz) | Reading (dBm) | Limit (dBm) | S.G Power Value (dBm) | Correction Factor (dB) | ERP (dBm) | Margin (dB) |
|-----|-------------|---------------|-------------|-----------------------|------------------------|-----------|-------------|
| 1   | 1672        | -47.53        | -13         | -40.89                | 0.11                   | -40.78    | -27.78      |
| 2   | 2509        | -63.25        | -13         | -53.14                | -0.06                  | -53.20    | -40.20      |
| 3   | 3345        | -68.95        | -13         | -57.38                | 0.69                   | -56.69    | -43.69      |
| 4   | 4182        | -68.14        | -13         | -54.31                | 0.12                   | -54.19    | -41.19      |

**ANTENNA POLARITY & TEST DISTANCE: VERTICAL AT 3 M**

| No. | Freq. (MHz) | Reading (dBm) | Limit (dBm) | S.G Power Value (dBm) | Correction Factor (dB) | ERP (dBm) | Margin (dB) |
|-----|-------------|---------------|-------------|-----------------------|------------------------|-----------|-------------|
| 1   | 1672        | -50.63        | -13         | -39.68                | 0.11                   | -39.57    | -26.57      |
| 2   | 2509        | -63.32        | -13         | -51.53                | -0.06                  | -51.59    | -38.59      |
| 3   | 3345        | -68.52        | -13         | -56.15                | 0.69                   | -55.46    | -42.46      |
| 4   | 4182        | -70.35        | -13         | -53.24                | 0.12                   | -53.12    | -40.12      |

**REMARKS:**

1. ERP (dBm) = S.G Value (dBm) + Correction Factor (dB).
2. Correction Factor (dB) = Substitution Antenna Gain (dB) + Cable Loss (dB) - 2.15 (dB)



Test Report No.: RF141111N015-3

**CHANNEL BANDWIDTH: 10MHz / QPSK**

|                                 |                  |                        |                    |
|---------------------------------|------------------|------------------------|--------------------|
| <b>MODE</b>                     | TX channel 20525 | <b>FREQUENCY RANGE</b> | Above 1000MHz      |
| <b>ENVIRONMENTAL CONDITIONS</b> | 24deg. C, 60%RH  | <b>INPUT POWER</b>     | DC 5V from adapter |
| <b>TESTED BY</b>                | Blue Zheng       |                        |                    |

| ANTENNA POLARITY & TEST DISTANCE: HORIZONTAL AT 3 M |             |               |             |                       |                        |           |             |
|---|-------------|---------------|-------------|-----------------------|------------------------|-----------|-------------|
| No.   | Freq. (MHz) | Reading (dBm) | Limit (dBm) | S.G Power Value (dBm) | Correction Factor (dB) | ERP (dBm) | Margin (dB) |
| 1   | 1672        | -47.25        | -13         | -40.61                | 0.11                   | -40.50    | -27.50      |
| 2   | 2509        | -62.88        | -13         | -52.77                | -0.06                  | -52.83    | -39.83      |
| 3   | 3345        | -68.72        | -13         | -57.15                | 0.69                   | -56.46    | -43.46      |
| 4   | 4182        | -68.46        | -13         | -54.63                | 0.12                   | -54.51    | -41.51      |

| ANTENNA POLARITY & TEST DISTANCE: VERTICAL AT 3 M |             |               |             |                       |                        |           |             |
|---|-------------|---------------|-------------|-----------------------|------------------------|-----------|-------------|
| No.   | Freq. (MHz) | Reading (dBm) | Limit (dBm) | S.G Power Value (dBm) | Correction Factor (dB) | ERP (dBm) | Margin (dB) |
| 1   | 1672        | -49.37        | -13         | -38.42                | 0.11                   | -38.31    | -25.31      |
| 2   | 2509        | -62.16        | -13         | -50.34                | -0.06                  | -50.40    | -37.40      |
| 3   | 3345        | -68.87        | -13         | -56.51                | 0.69                   | -55.82    | -42.82      |
| 4   | 4182        | -69.41        | -13         | -52.30                | 0.12                   | -52.18    | -39.18      |

**REMARKS:**

- ERP (dBm) = S.G Value (dBm) + Correction Factor (dB).
- Correction Factor (dB) = Substitution Antenna Gain (dB) + Cable Loss (dB) - 2.15 (dB)

## 4.7 PEAK TO AVERAGE RATIO

### 4.7.1 LIMITS OF PEAK TO AVERAGE RATIO MEASUREMENT

In measuring transmissions in this band using an average power technique, the peak to-average ratio (PAR) of the transmission may not exceed 13 dB

### 4.7.2 TEST SETUP

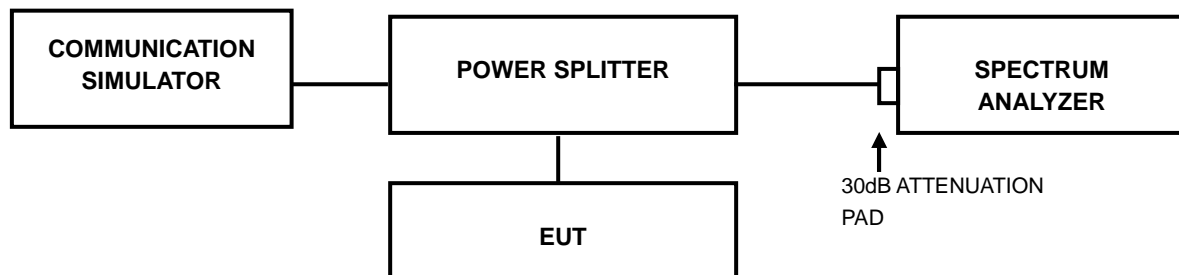

### 4.7.3 TEST PROCEDURES

1. Set resolution/measurement bandwidth  $\geq$  signal's occupied bandwidth;
2. Set the number of counts to a value that stabilizes the measured CCDF curve;
3. Record the maximum PAPR level associated with a probability of 0.1%.



4.7.4 TEST RESULTS

GSM

| CHANNEL | FREQUENCY (MHz) | PEAK TO AVERAGE RATIO (dB) |
|---------|-----------------|----------------------------|
| 189     | 836.4           | 8.43                       |

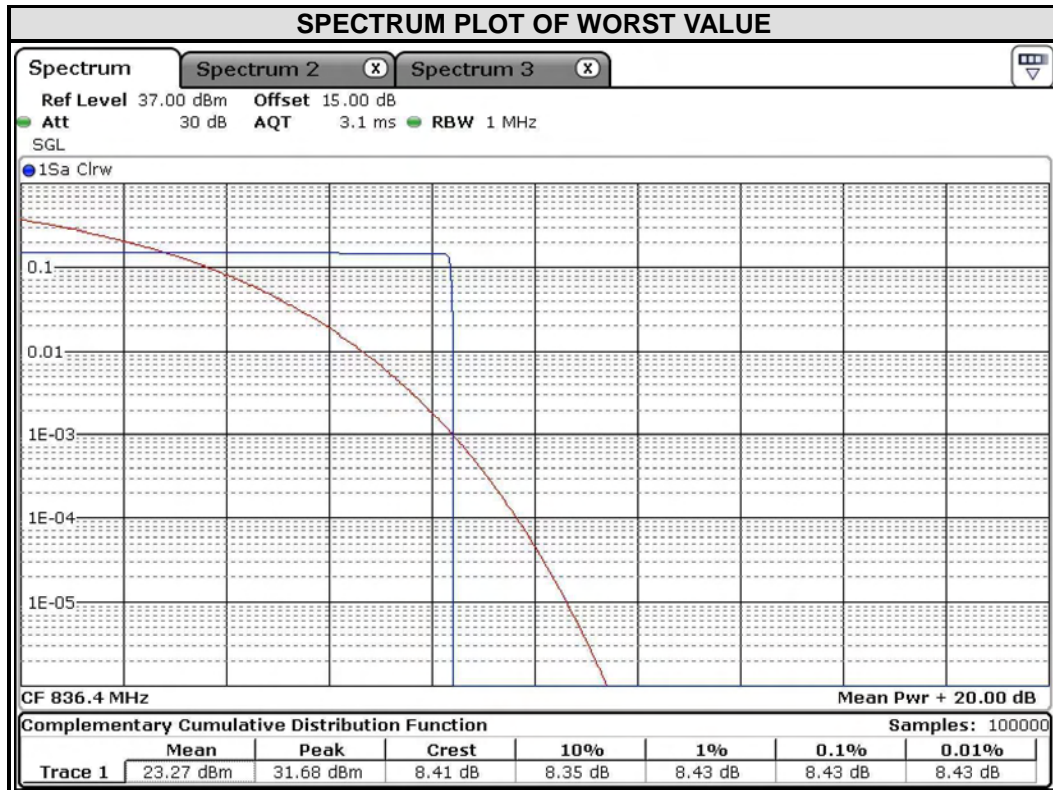



EDGE

| CHANNEL | FREQUENCY (MHz) | PEAK TO AVERAGE RATIO (dB) |
|---------|-----------------|----------------------------|
| 189     | 836.4           | 7.68                       |

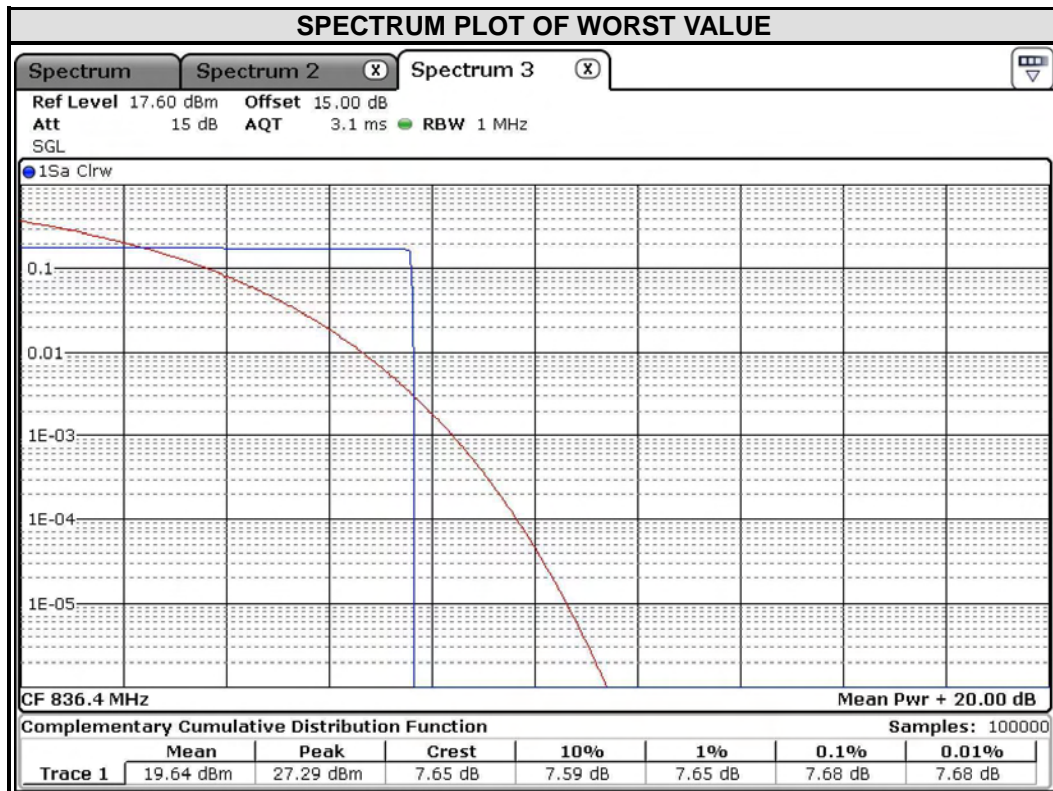





WCDMA

| CHANNEL | FREQUENCY (MHz) | PEAK TO AVERAGE RATIO (dB) |
|---------|-----------------|----------------------------|
| 4182    | 836.4           | 3.07                       |

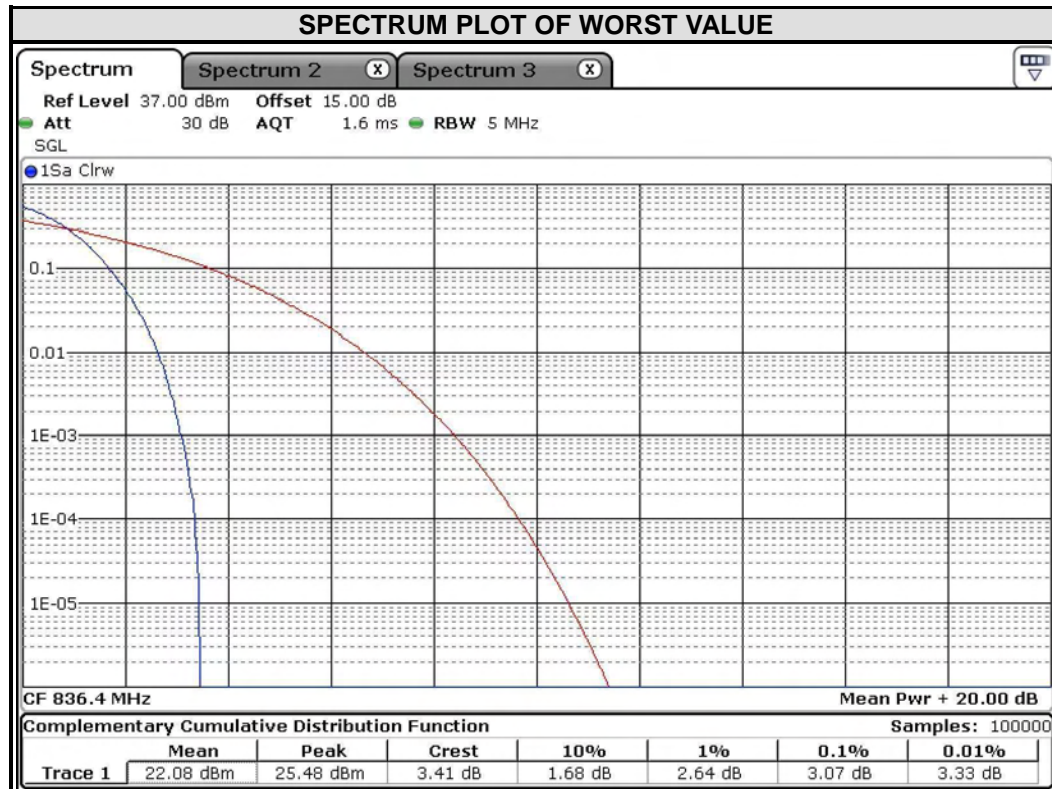



LTE BAND 5

| CHANNEL BANDWIDTH: 1.4MHz |                 |                            |       | CHANNEL BANDWIDTH: 3MHz |                 |                            |       |
|---------------------------|-----------------|----------------------------|-------|-------------------------|-----------------|----------------------------|-------|
| CHANNEL                   | FREQUENCY (MHz) | PEAK TO AVERAGE RATIO (dB) |       | CHANNEL                 | FREQUENCY (MHz) | PEAK TO AVERAGE RATIO (dB) |       |
|                           |                 | QPSK                       | 16QAM |                         |                 | QPSK                       | 16QAM |
| 20407                     | 824.7           | 5.80                       | 6.90  | 20415                   | 825.5           | 6.12                       | 7.01  |
| 20525                     | 836.5           | 5.13                       | 6.03  | 20525                   | 836.5           | 5.48                       | 6.09  |
| 20643                     | 848.3           | 4.90                       | 5.80  | 20635                   | 847.5           | 5.28                       | 6.26  |

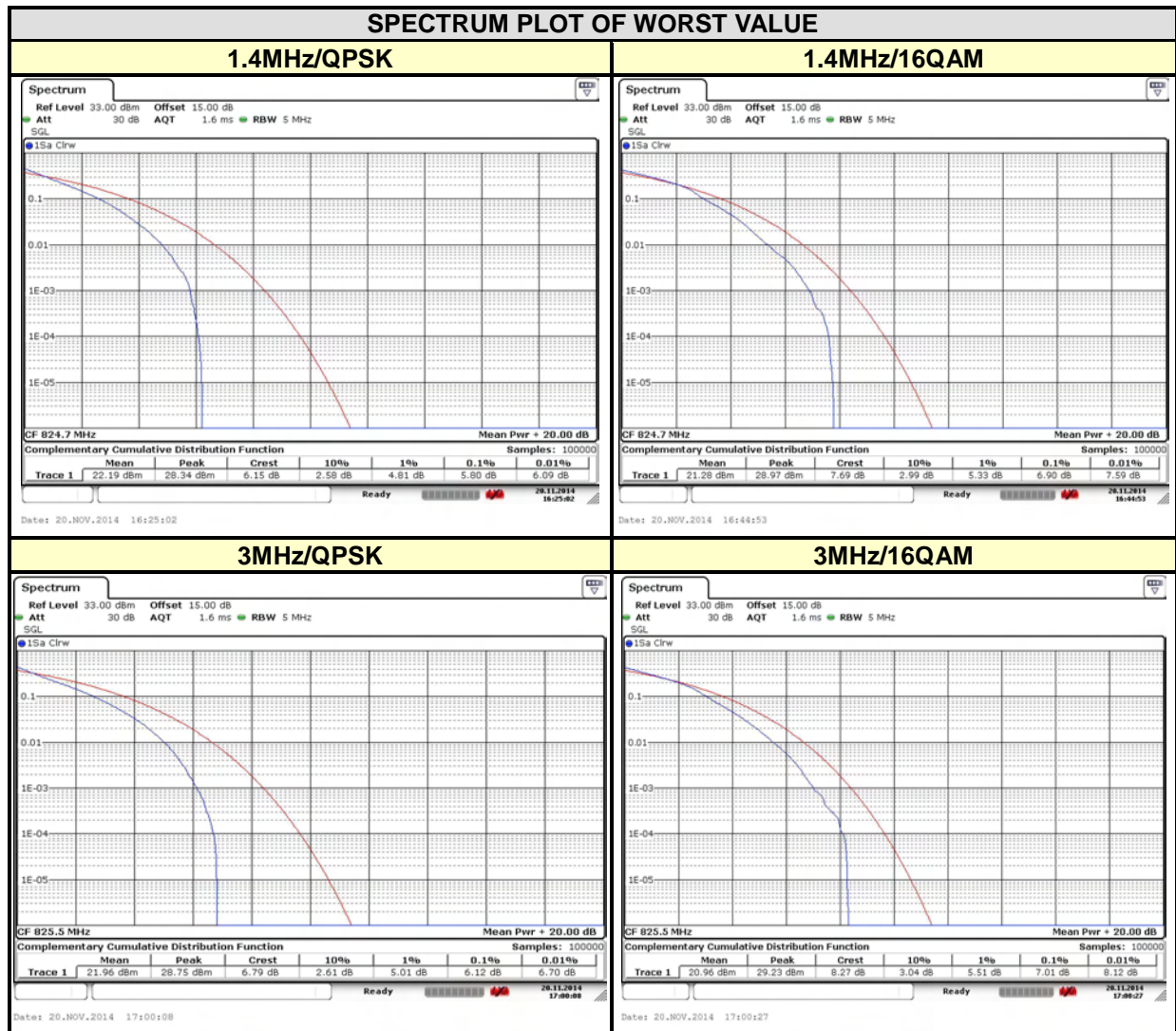



| CHANNEL BANDWIDTH: 5MHz |                 |                            |       | CHANNEL BANDWIDTH: 10MHz |                 |                            |       |
|-------------------------|-----------------|----------------------------|-------|--------------------------|-----------------|----------------------------|-------|
| CHANNEL                 | FREQUENCY (MHz) | PEAK TO AVERAGE RATIO (dB) |       | CHANNEL                  | FREQUENCY (MHz) | PEAK TO AVERAGE RATIO (dB) |       |
|                         |                 | QPSK                       | 16QAM |                          |                 | QPSK                       | 16QAM |
| 20425                   | 826.5           | 5.74                       | 6.78  | 20450                    | 829             | 6.14                       | 6.72  |
| 20525                   | 836.5           | 5.13                       | 5.97  | 20525                    | 836.5           | 5.59                       | 6.29  |
| 20625                   | 846.5           | 5.33                       | 6.17  | 20600                    | 844             | 5.54                       | 6.38  |

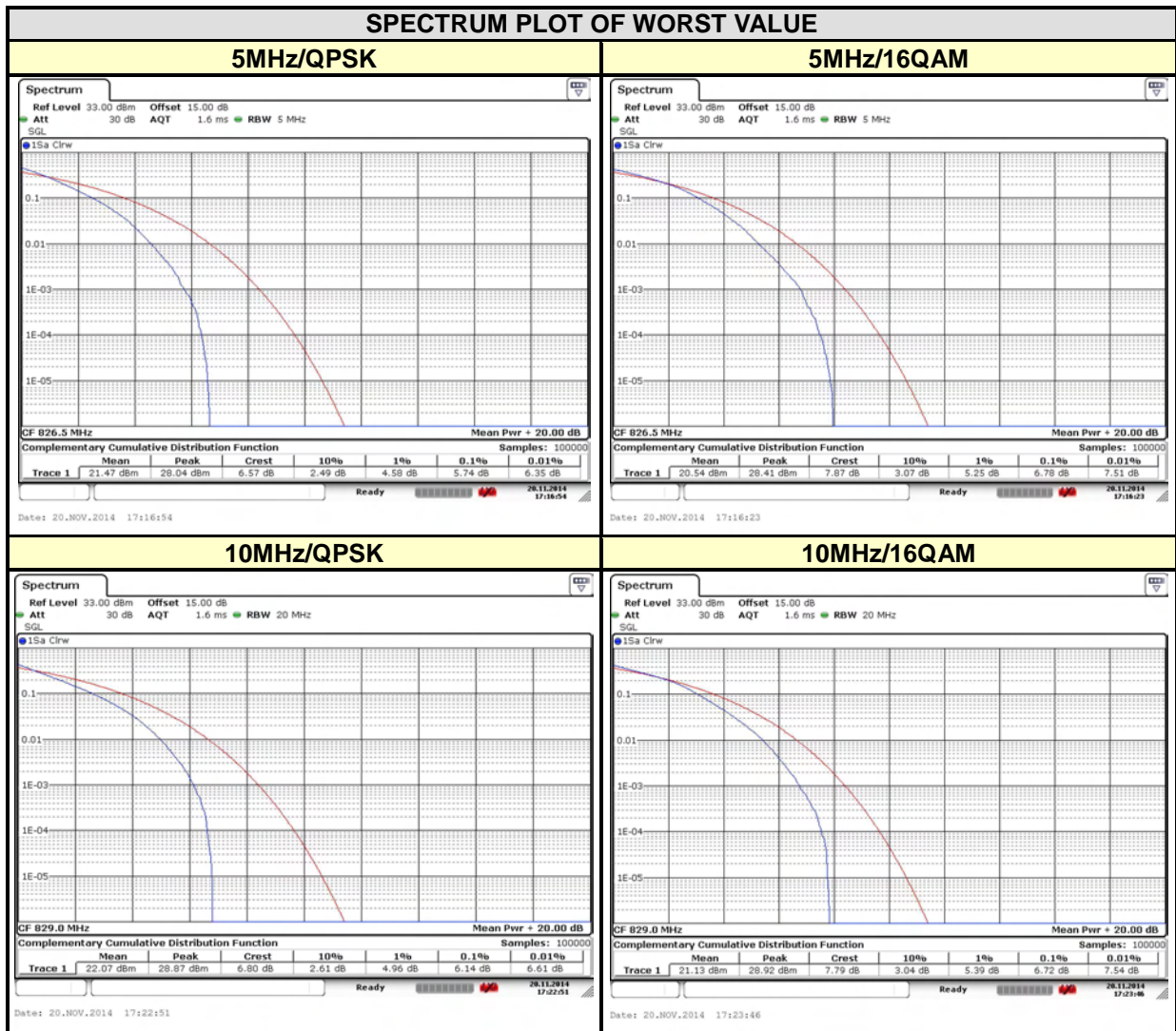



Test Report No.: RF141111N015-3

## 5 PHOTOGRAPHS OF THE TEST CONFIGURATION

Please refer to the attached file (Test Setup Photo).



Test Report No.: RF141111N015-3

## 6 INFORMATION ON THE TESTING LABORATORIES

We, Bureau Veritas Shenzhen Co., Ltd. Dongguan Branch, were founded in 2002 to provide our best service in EMC, Radio, Telecom and Safety consultation. Our laboratories are accredited and approved according to ISO/IEC 17025.

If you have any comments, please feel free to contact us at the following:

**Dongguan EMC/RF Lab:**

Tel: +86-769-85935656

Fax: +86-769-85931080

**Email:** [customerservice.dg@cn.bureauveritas.com](mailto:customerservice.dg@cn.bureauveritas.com)

**Web Site:** [www.adt.com.tw](http://www.adt.com.tw)

The address and road map of all our labs can be found in our web site also.



Test Report No.: RF141111N015-3

## 7 APPENDIX A – MODIFICATIONS RECORDERS FOR ENGINEERING CHANGES TO THE EUT BY THE LAB

No any modifications are made to the EUT by the lab during the test.

---END---