



Test Report No.: RF141111N015-7



# FCC TEST REPORT (WIFI 5G)

**Product:** LTE phone  
**Model No.:** XP5700  
**FCC ID:** WYPL15V013AA  
**Applicant:** Sonim Technologies, Inc.  
**Address:** 1825 S. Grant St., Suite 200., San Mateo, CA, 94402  
**Manufacturer:** Sonim Technologies, Inc.  
**Address:** 1825 S. Grant St., Suite 200., San Mateo, CA, 94402  
**Prepared by:** Bureau Veritas Shenzhen Co., Ltd. Dongguan Branch  
**Lab Location:** No. 34, Chenwulu Section, Guantai Rd., Houjie Town, Dongguan City, Guangdong 523942, China  
**TEL:** +86 769 8593 5656  
**FAX:** +86 769 8593 1080  
**E-MAIL:** [customerservice.dg@cn.bureauveritas.com](mailto:customerservice.dg@cn.bureauveritas.com)  
**Report No.:** RF141111N015-7  
**Received Date:** Nov. 11, 2014  
**Test Date:** Nov. 12, 2014 ~ Dec. 15, 2014  
**Issued Date:** Dec. 16, 2014

This report should not be used by the client to claim product certification, approval, or endorsement by A2LA or any government agencies.

Any copying or replication of this report to or for any other person or entity, or use of our name or trademark, is permitted only with our prior written permission. This report sets forth our findings solely with respect to the test samples identified herein. The results set forth in this report are not indicative or representative of the quality or characteristics of the lot from which a test sample was taken or any similar or identical product unless specifically and expressly noted. Our report includes all of the tests requested by you and the results thereof based upon the information that you provided to us. You have 60 days from date of issuance of this report to notify us of any material error or omission caused by our negligence, provided, however, that such notice shall be in writing and shall specifically address the issue you wish to raise. A failure to raise such issue within the prescribed time shall constitute your unqualified acceptance of the completeness of this report, the tests conducted and the correctness of the report contents. Unless specific mention, the uncertainty of measurement has been explicitly taken into account to declare the compliance or non-compliance to the specification.

Bureau Veritas Shenzhen Co., Ltd.  
Dongguan Branch

No. 34, Chenwulu Section, Guantai Rd., Houjie  
Town, Dongguan City,  
Guangdong 523942, China

Tel: +86 769 8593 5656  
Fax: +86 769 8593 1080  
Email: [customerservice.dg@cn.bureauveritas.com](mailto:customerservice.dg@cn.bureauveritas.com)



## TABLE OF CONTENTS

<b>RELEASE CONTROL RECORD .....</b>	<b>4</b>
<b>1 CERTIFICATION .....</b>	<b>5</b>
<b>2 SUMMARY OF TEST RESULTS.....</b>	<b>6</b>
2.1 MEASUREMENT UNCERTAINTY .....	6
<b>3 GENERAL INFORMATION .....</b>	<b>7</b>
3.1 GENERAL DESCRIPTION OF EUT .....	7
3.2 DESCRIPTION OF TEST MODES .....	9
3.2.1 TEST MODE APPLICABILITY AND TESTED CHANNEL DETAIL.....	11
3.3 DUTY CYCLE OF TEST SIGNAL .....	14
3.4 DESCRIPTION OF SUPPORT UNITS .....	15
3.4.1 CONFIGURATION OF SYSTEM UNDER TEST .....	17
3.5 GENERAL DESCRIPTION OF APPLIED STANDARDS .....	17
<b>4 TEST TYPES AND RESULTS.....</b>	<b>18</b>
4.1 RADIATED EMISSION AND BANDEDGE MEASUREMENT.....	18
4.1.1 LIMITS OF RADIATED EMISSION AND BANDEDGE MEASUREMENT.....	18
4.1.2 LIMITS OF UNWANTED EMISSION OUT OF THE RESTRICTED BANDS .....	18
4.1.3 TEST INSTRUMENTS.....	19
4.1.4 TEST PROCEDURES .....	20
4.1.5 DEVIATION FROM TEST STANDARD .....	20
4.1.6 TEST SETUP.....	21
4.1.7 EUT OPERATING CONDITION .....	21
4.1.8 TEST RESULTS .....	22
4.2 CONDUCTED EMISSION MEASUREMENT .....	57
4.2.1 LIMITS OF CONDUCTED EMISSION MEASUREMENT .....	57
4.2.2 TEST INSTRUMENTS.....	57
4.2.3 TEST PROCEDURES .....	57
4.2.4 DEVIATION FROM TEST STANDARD .....	58
4.2.5 TEST SETUP.....	58
4.2.6 EUT OPERATING CONDITIONS .....	58
4.2.7 TEST RESULTS .....	59



4.3	MAXIMUM CONDUCTED OUTPUT POWER MEASUREMENT .....	61
4.3.1	LIMITS OF MAXIMUM CONDUCTED OUTPUT POWER MEASUREMENT .....	61
4.3.2	TEST SETUP .....	61
4.3.3	TEST INSTRUMENTS.....	62
4.3.4	TEST PROCEDURE.....	62
4.3.5	DEVIATION FROM TEST STANDARD .....	63
4.3.6	EUT OPERATING CONDITIONS .....	63
4.3.7	TEST RESULTS .....	64
4.4	PEAK POWER SPECTRAL DENSITY MEASUREMENT .....	73
4.4.1	LIMITS OF PEAK POWER SPECTRAL DENSITY MEASUREMENT .....	73
4.4.2	TEST SETUP .....	73
4.4.3	TEST INSTRUMENTS.....	73
4.4.4	TEST PROCEDURES .....	73
4.4.5	DEVIATION FROM TEST STANDARD .....	74
4.4.6	EUT OPERATING CONDITIONS .....	74
4.4.7	TEST RESULTS .....	74
4.5	FREQUENCY STABILITY .....	77
4.5.1	LIMITS OF FREQUENCY STABILITY MEASUREMENT .....	81
4.5.2	TEST SETUP .....	81
4.5.3	TEST INSTRUMENTS.....	81
4.5.4	TEST PROCEDURE.....	82
4.5.5	DEVIATION FROM TEST STANDARD .....	82
4.5.6	EUT OPERATING CONDITION .....	82
4.5.7	TEST RESULTS .....	83
<b>5</b>	<b>PHOTOGRAPHS OF THE TEST CONFIGURATION .....</b>	<b>84</b>
<b>6</b>	<b>APPENDIX A – MODIFICATIONS RECORDERS FOR ENGINEERING CHANGES TO THE EUT BY THE LAB .....</b>	<b>85</b>



**BUREAU  
VERITAS**

Test Report No.: RF141111N015-7

## RELEASE CONTROL RECORD

ISSUE NO.	REASON FOR CHANGE	DATE ISSUED
RF141111N015-7	Original release	Dec. 16, 2014



## 1 CERTIFICATION

**PRODUCT:** LTE phone  
**BRAND NAME:** Sonim  
**MODEL NO.:** XP5700  
**APPLICANT:** Sonim Technologies, Inc.  
**TESTED:** Nov. 12, 2014 ~ Dec. 15, 2014  
**TEST SAMPLE:** Identical Prototype  
**STANDARDS:** FCC Part 15, Subpart E (15.407), Section 15.407  
ANSI C63.10-2009

The above equipment has been tested by **Bureau Veritas Shenzhen Co., Ltd. Dongguan Branch** and found compliance with the requirement of the above standards. The test record, data evaluation & Equipment Under Test (EUT) configurations represented herein are true and accurate accounts of the measurements of the sample's EMC characteristics under the conditions specified in this report.

**PREPARED BY :** Yuqiang Yin , **DATE:** Dec. 16, 2014  
(Yuqiang Yin / Engineer)

**APPROVED BY :** Glyn He , **DATE:** Dec. 16, 2014  
( Glyn He / Supervisor )



## 2 SUMMARY OF TEST RESULTS

The EUT has been tested according to the following specifications:

APPLIED STANDARD: FCC PART 15, SUBPART E (SECTION 15.407)			
STANDARD SECTION	TEST TYPE AND LIMIT	RESULT	REMARK
15.407(b)(5)	AC Power Conducted Emission	PASS	Meet the requirement of limit. Minimum passing margin is -13.64dB at 0.65781MHz.
15.407(b/1/2/3) (b)(5)	Electric Field Strength Spurious Emissions, 30MHz ~ 40000MHz	PASS	Meet the requirement of limit. Minimum passing margin is -3.8dB at 5725.00MHz.
15.407(a/1/2/3)	Maximum conducted output Power	PASS	Meet the requirement of limit.
15.407(a/1/2/3)	Peak Power Spectral Density	PASS	Meet the requirement of limit.
15.407(g)	Frequency Stability	PASS	Meet the requirement of limit.
15.203	Antenna Requirement	PASS	No antenna connector is used.

### 2.1 MEASUREMENT UNCERTAINTY

Where relevant, the following measurement uncertainty levels have been estimated for tests performed on the EUT as specified in CISPR 16-4-2:

MEASUREMENT	FREQUENCY	UNCERTAINTY
Conducted emissions	9kHz~30MHz	2.66dB
Radiated emissions	9KHz ~ 30MHz	2.74dB
	30MHz ~ 1GMHz	3.55dB
	1GHz ~ 18GHz	4.84dB
	18GHz ~ 40GHz	1.94dB

This uncertainty represents an expanded uncertainty expressed at approximately the 95% confidence level using a coverage factor of k = 2.



### 3 GENERAL INFORMATION

#### 3.1 GENERAL DESCRIPTION OF EUT

<b>EUT</b>	LTE phone
<b>MODEL NO.</b>	XP5700
<b>TYPE NUMBER</b>	L15V013AA, L15V013BA, L15V013CA
<b>POWER SUPPLY</b>	5.0Vdc (adapter or host equipment) 3.7Vdc (battery)
<b>MODULATION TYPE</b>	64QAM, 16QAM, QPSK, BPSK
<b>MODULATION TECHNOLOGY</b>	OFDM
<b>TRANSFER RATE</b>	802.11a: 54.0/ 48.0/ 36.0/ 24.0/ 18.0/ 12.0/ 9.0/ 6.0Mbps 802.11n: up to MCS7
<b>OPERATING FREQUENCY</b>	5180 ~ 5240MHz, 5260 ~ 5320MHz 5500 ~ 5700MHz, 5745 ~ 5805MHz
<b>NUMBER OF CHANNEL</b>	5180 ~ 5240MHz: 4 for 802.11a, 802.11n (20MHz) 2 for 802.11n (40MHz) 5260 ~ 5320MHz: 4 for 802.11a, 802.11n (20MHz) 2 for 802.11n (40MHz) 5500 ~ 5700MHz: 8 for 802.11a, 802.11n (20MHz) 3 for 802.11n (40MHz) 5745 ~ 5805MHz: 4 for 802.11a, 802.11n (20MHz) 2 for 802.11n (40MHz)
<b>AVERAGE POWER</b>	35.156mW for 5180 ~ 5240MHz 34.198mW for 5260 ~ 5320MHz 35.156mW for 5500 ~ 5700MHz 35.810mW for 5745 ~ 5805MHz
<b>ANTENNA TYPE</b>	5180 ~ 5240MHz: PIFA Antenna with 2dBi gain 5260 ~ 5320MHz: PIFA Antenna with 2dBi gain 5500 ~ 5700MHz: PIFA Antenna with 2dBi gain 5745 ~ 5805MHz: PIFA Antenna with 2dBi gain
<b>I/O PORTS</b>	Refer to user's manual
<b>CABLE SUPPLIED</b>	USB Cable: Shielded, Detachable, 1.1m

**NOTE:**

1. For a more detailed features description, please refer to the manufacturer's specifications or the user's manual.
2. The EUT was powered by the following adapter:



<b>ADAPTER</b>	
<b>BRAND:</b>	Sonim
<b>MODEL:</b>	S14C02
<b>INPUT:</b>	AC 100-240V, 200mA
<b>OUTPUT:</b>	DC 5V, 1200mA

3. The EUT incorporates a SISO function. Physically, the EUT provides one completed transmitters and one receivers.

<b>MODULATION MODE</b>	<b>TX FUNCTION</b>
<b>802.11a</b>	1TX/1RX
<b>802.11n (20MHz)</b>	1TX/1RX
<b>802.11n (40MHz)</b>	1TX/1RX

4. For the test results, the EUT had been tested with all conditions. But only the worst case was shown in test report.





### 3.2 DESCRIPTION OF TEST MODES

#### FOR 5150 ~ 5250MHz

4 channels are provided for 802.11a, 802.11n (20MHz):

CHANNEL	FREQUENCY	CHANNEL	FREQUENCY
36	5180 MHz	44	5220 MHz
40	5200 MHz	48	5240 MHz

2 channels are provided for 802.11n (40MHz):

CHANNEL	FREQUENCY	CHANNEL	FREQUENCY
38	5190 MHz	46	5230 MHz

#### FOR 5250 ~ 5350MHz

4 channels are provided for 802.11a, 802.11n (20MHz):

CHANNEL	FREQUENCY	CHANNEL	FREQUENCY
52	5260 MHz	60	5300 MHz
56	5280 MHz	64	5320 MHz

2 channels are provided for 802.11n (40MHz):

CHANNEL	FREQUENCY	CHANNEL	FREQUENCY
54	5270 MHz	62	5310 MHz



**FOR 5470 ~ 5725MHz**

8 channels are provided for 802.11a, 802.11n (20MHz):

CHANNEL	FREQUENCY	CHANNEL	FREQUENCY
100	5500 MHz	116	5580 MHz
104	5520 MHz	132	5660 MHz
108	5540 MHz	136	5680 MHz
112	5560 MHz	140	5700 MHz

3 channels are provided for 802.11n (40MHz):

CHANNEL	FREQUENCY	CHANNEL	FREQUENCY
102	5510 MHz	134	5670 MHz
110	5550 MHz		

**FOR 5725 ~ 5850MHz**

4 channels are provided for 802.11a, 802.11n (20MHz):

CHANNEL	FREQUENCY	CHANNEL	FREQUENCY
149	5745MHz	161	5805MHz
153	5765MHz		
157	5785MHz		

2 channels are provided for 802.11n (40MHz):

CHANNEL	FREQUENCY	CHANNEL	FREQUENCY
151	5755MHz	159	5795MHz



3.2.1 TEST MODE APPLICABILITY AND TESTED CHANNEL DETAIL

EUT CONFIGURE MODE	APPLICABLE TO				DESCRIPTION
	RE≥1G	RE<1G	PLC	APCM	
A	√	√	√	-	Powered by Adapter with wifi(5G) link
B	-	-	-	√	Powered by Battery with wifi(5G) link
C	-	-	-	-	Powered by USB with wifi(5G) link

Where **RE≥1G**: Radiated Emission above 1GHz      **RE<1G**: Radiated Emission below 1GHz  
**PLC**: Power Line Conducted Emission      **APCM**: Antenna Port Conducted Measurement

**NOTE:**  
The EUT had been pre-tested on the positioned of each 3 axis. The worst case was found when positioned on **X-plane**.  
**NOTE:** "-" means no effect.

**RADIATED EMISSION TEST (ABOVE 1GHz):**

- Pre-Scan has been conducted to determine the worst-case mode from all possible combinations between available modulations, data rates and antenna ports (if EUT with antenna diversity architecture).
- Following channel(s) was (were) selected for the final test as listed below.

EUT CONFIGURE MODE	MODE	FREQ. BAND (MHz)	AVAILABLE CHANNEL	TESTED CHANNEL	MODULATION TECHNOLOGY	MODULATION TYPE	DATA RATE (Mbps)
A	802.11a	5180-5240	36 to 48	36, 40, 48	OFDM	BPSK	6.0
A	802.11n (20MHz)		36 to 48	36, 40, 48	OFDM	BPSK	MCS0
A	802.11n (40MHz)		38 to 46	38, 46	OFDM	BPSK	MCS0
A	802.11a	5260-5320	52 to 64	52, 60, 64	OFDM	BPSK	6.0
A	802.11n (20MHz)		52 to 64	52, 60, 64	OFDM	BPSK	MCS0
A	802.11n (40MHz)		54 to 62	54, 62	OFDM	BPSK	MCS0
A	802.11a	5500-5700	100 to 140	100, 116, 140	OFDM	BPSK	6.0
A	802.11n (20MHz)		100 to 140	100, 116, 140	OFDM	BPSK	MCS0
A	802.11n (40MHz)		102 to 134	102, 110, 134	OFDM	BPSK	MCS0
A	802.11a	5725-5805	149 to 161	149, 157, 161	OFDM	BPSK	6.0
A	802.11n (20MHz)		149 to 161	149, 157, 161	OFDM	BPSK	MCS0
A	802.11n (40MHz)		151 to 159	151, 159	OFDM	BPSK	MCS0

**RADIATED EMISSION TEST (BELOW 1GHz):**

- Pre-Scan has been conducted to determine the worst-case mode from all possible combinations between available modulations, data rates and antenna ports (if EUT with antenna diversity architecture).
- Following channel(s) was (were) selected for the final test as listed below.

EUT CONFIGURE MODE	MODE	FREQ. BAND (MHz)	AVAILABLE CHANNEL	TESTED CHANNEL	MODULATION TECHNOLOGY	MODULATION TYPE	DATA RATE (Mbps)
A	802.11a	5180-5320	36 to 64	36	OFDM	BPSK	6.0



**POWER LINE CONDUCTED EMISSION TEST:**

- Pre-Scan has been conducted to determine the worst-case mode from all possible combinations between available modulations, data rates and antenna ports (if EUT with antenna diversity architecture).
- Following channel(s) was (were) selected for the final test as listed below.

EUT CONFIGURE MODE	MODE	FREQ. BAND (MHz)	AVAILABLE CHANNEL	TESTED CHANNEL	MODULATION TECHNOLOGY	MODULATION TYPE	DATA RATE (Mbps)
A	802.11a	5180-5320	36 to 64	36	OFDM	BPSK	6.0

**BANDEDGE MEASUREMENT:**

- Pre-Scan has been conducted to determine the worst-case mode from all possible combinations between available modulations, data rates and antenna ports (if EUT with antenna diversity architecture).
- Following channel(s) was (were) selected for the final test as listed below.

EUT CONFIGURE MODE	MODE	FREQ. BAND (MHz)	AVAILABLE CHANNEL	TESTED CHANNEL	MODULATION TECHNOLOGY	MODULATION TYPE	DATA RATE (Mbps)
A	802.11a	5180-5240	36 to 48	36, 48	OFDM	BPSK	6.0
A	802.11n (20MHz)		36 to 48	36, 48	OFDM	BPSK	MCS0
A	802.11n (40MHz)		38 to 46	38, 46	OFDM	BPSK	MCS0
A	802.11a	5260-5320	52 to 64	52, 64	OFDM	BPSK	6.0
A	802.11n (20MHz)		52 to 64	52, 64	OFDM	BPSK	MCS0
A	802.11n (40MHz)		54 to 62	54, 62	OFDM	BPSK	MCS0
A	802.11a	5500-5700	100 to 140	100, 140	OFDM	BPSK	6.0
A	802.11n (20MHz)		100 to 140	100, 140	OFDM	BPSK	MCS0
A	802.11n (40MHz)		102 to 134	102, 134	OFDM	BPSK	MCS0
A	802.11a	5725-5805	149 to 161	149, 161	OFDM	BPSK	6.0
A	802.11n (20MHz)		149 to 161	149, 161	OFDM	BPSK	MCS0
A	802.11n (40MHz)		151 to 159	151, 159	OFDM	BPSK	MCS0



**ANTENNA PORT CONDUCTED MEASUREMENT:**

- This item includes all test value of each mode, but only includes spectrum plot of worst value of each mode.
- Pre-Scan has been conducted to determine the worst-case mode from all possible combinations between available modulations, data rates and antenna ports (if EUT with antenna diversity architecture).
- Following channel(s) was (were) selected for the final test as listed below.

EUT CONFIGURE MODE	MODE	FREQ. BAND (MHz)	AVAILABLE CHANNEL	TESTED CHANNEL	MODULATION TECHNOLOGY	MODULATION TYPE	DATA RATE (Mbps)
B	802.11a	5180-5240	36 to 48	36, 40, 48	OFDM	BPSK	6.0
B	802.11n (20MHz)		36 to 48	36, 40, 48	OFDM	BPSK	MCS0
B	802.11n (40MHz)		38 to 46	38, 46	OFDM	BPSK	MCS0
B	802.11a	5260-5320	52 to 64	52, 60, 64	OFDM	BPSK	6.0
B	802.11n (20MHz)		52 to 64	52, 60, 64	OFDM	BPSK	MCS0
B	802.11n (40MHz)		54 to 62	54, 62	OFDM	BPSK	MCS0
B	802.11a	5500-5700	100 to 140	100, 116, 140	OFDM	BPSK	6.0
B	802.11n (20MHz)		100 to 140	100, 116, 140	OFDM	BPSK	MCS0
B	802.11n (40MHz)		102 to 134	102, 110, 134	OFDM	BPSK	MCS0
B	802.11a	5725-5805	149 to 161	149, 157, 161	OFDM	BPSK	6.0
B	802.11n (20MHz)		149 to 161	149, 157, 161	OFDM	BPSK	MCS0
B	802.11n (40MHz)		151 to 159	151, 159	OFDM	BPSK	MCS0

**TEST CONDITION:**

APPLICABLE TO	ENVIRONMENTAL CONDITIONS	INPUT POWER	TESTED BY
RE<1G	23deg. C, 62%RH	DC 5V By Adapter	Blue Zheng
RE≥1G	23deg. C, 62%RH	DC 5V By Adapter	Blue Zheng
PLC	24deg. C, 61%RH	DC 5V By Adapter	Yuqiang Yin
APCM	23.5deg. C, 60%RH	DC 3.7V By battery	Yuqiang Yin



### 3.3 DUTY CYCLE OF TEST SIGNAL

Duty cycle of test signal is < 98%, duty factor shall be considered.

802.11a: Duty cycle = 1.355/1.572 = 0.862, Duty factor = 10 \* log( 1/0.862) = 0.64

802.11n (20MHz): Duty cycle = 1.261/1.478 = 0.853, Duty factor = 10 \* log( 1/0.853) = 0.69

802.11n (40MHz): Duty cycle = 0.635/0.839 = 0.757, Duty factor = 10 \* log( 1/0.757) = 1.21

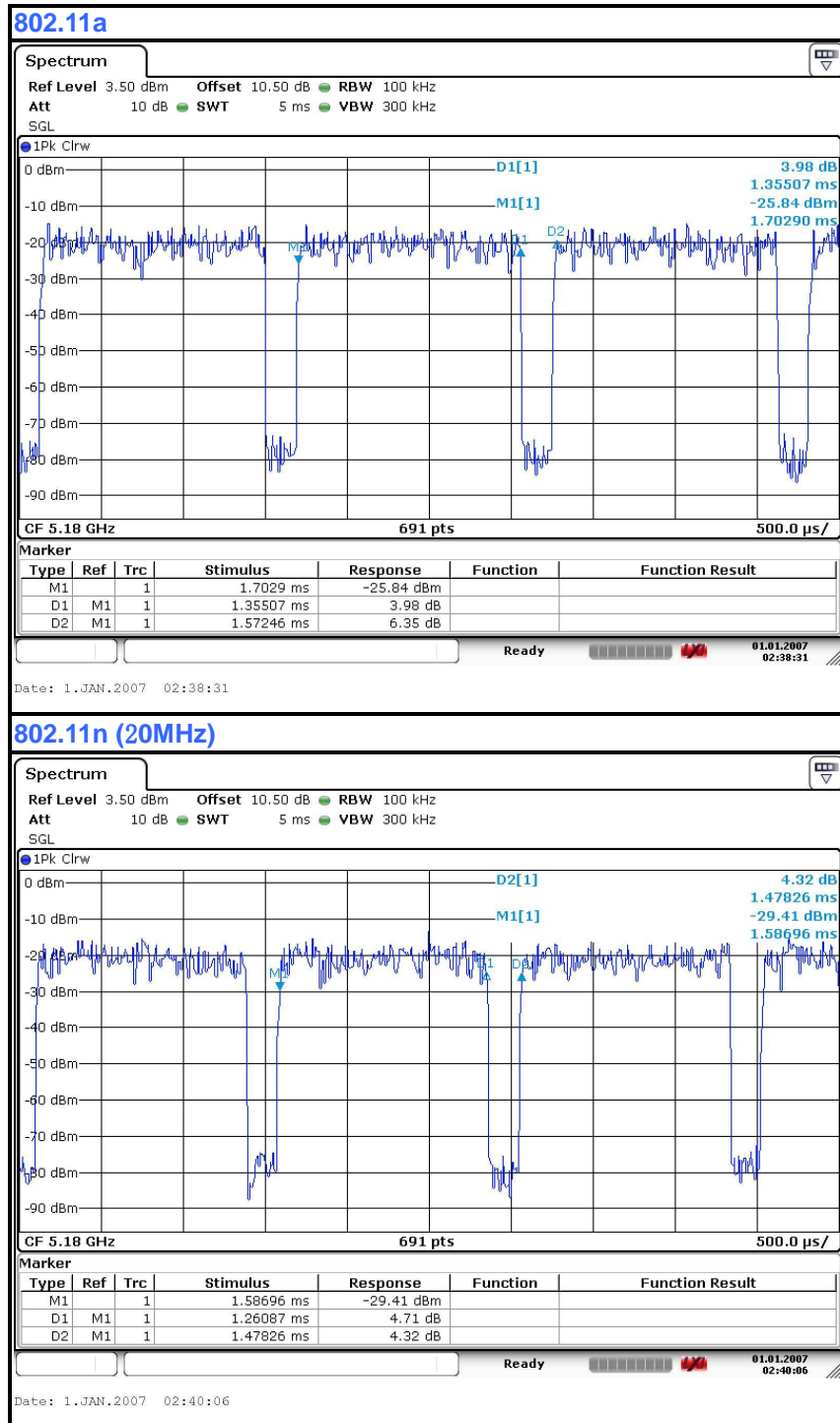



BUREAU VERITAS

Test Report No.: RF141111N015-7

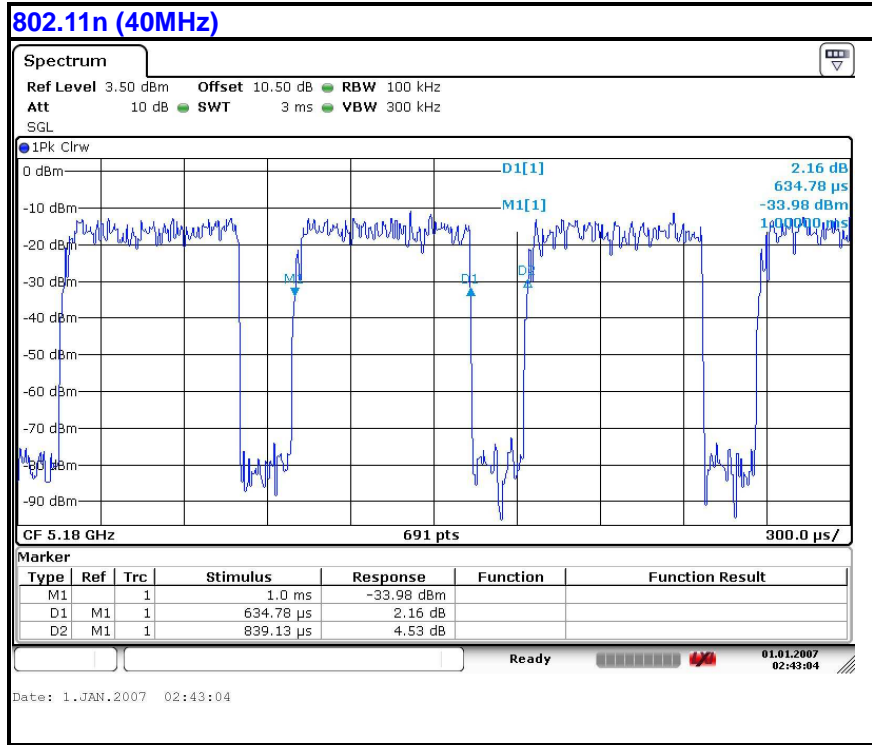



### 3.4 DESCRIPTION OF SUPPORT UNITS

The EUT has been tested as an independent unit together with other necessary accessories or support units. The following support units or accessories were used to form a representative test configuration during the tests.

NO.	PRODUCT	BRAND	MODEL NO.	SERIAL NO.	FCC ID
1	DC source	LONG WEI	PS-6403D	010934269	N/A
2	PC	HP	A6608CN	3CR83825X3	N/A
3	Earphone	Minami	ME-816B5-E	N/A	N/A

NO.	SIGNAL CABLE DESCRIPTION OF THE ABOVE SUPPORT UNITS
1	DC Line: Unshielded, Detachable 1.0m
2	AC Line: Unshielded, Detachable 1.5m
3	DC Line: Unshielded, Detachable 1.2m

**NOTE:**

1. All power cords of the above support units are non shielded (1.8m).





### 3.4.1 CONFIGURATION OF SYSTEM UNDER TEST

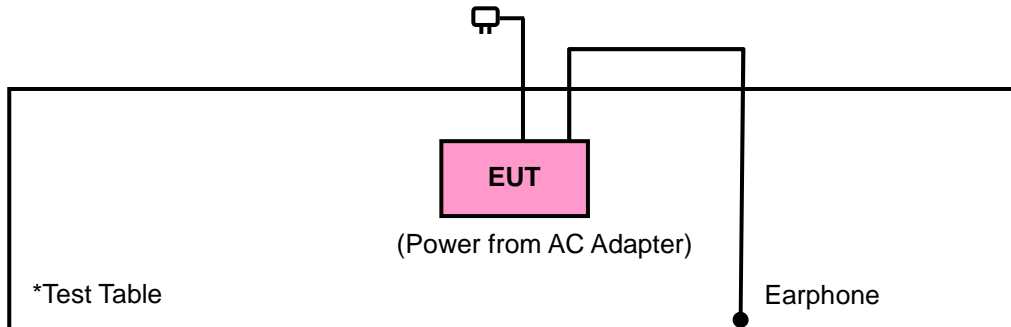

### 3.5 GENERAL DESCRIPTION OF APPLIED STANDARDS

The EUT is a RF Product. According to the specifications of the manufacturer, it must comply with the requirements of the following standards:

**FCC Part 15, Subpart E (15.407)**

**KDB 789033 D02\_v01\_General UNII Test Procedures New Rules**

**ANSI C63.10-2009**

All test items have been performed and recorded as per the above standards.

**NOTE:** The EUT is also considered as a kind of computer peripheral, because the connection to computer is necessary for typical use. It has been verified to comply with the requirements of FCC Part 15, Subpart B, Class B (verification). The test report has been issued separately.



## 4 TEST TYPES AND RESULTS

### 4.1 RADIATED EMISSION AND BANDEDGE MEASUREMENT

#### 4.1.1 LIMITS OF RADIATED EMISSION AND BANDEDGE MEASUREMENT

Radiated emissions which fall in the restricted bands must comply with the radiated emission limits specified as below table:

FREQUENCIES (MHz)	FIELD STRENGTH (microvolts/meter)	MEASUREMENT DISTANCE (meters)
0.009 ~ 0.490	2400/F(kHz)	300
0.490 ~ 1.705	24000/F(kHz)	30
1.705 ~ 30.0	30	30
30 ~ 88	100	3
88 ~ 216	150	3
216 ~ 960	200	3
Above 960	500	3

**NOTE:**

1. The lower limit shall apply at the transition frequencies.
2. Emission level (dBuV/m) = 20 log Emission level (uV/m).
3. For frequencies above 1000MHz, the field strength limits are based on average detector, however, the peak field strength of any emission shall not exceed the maximum permitted average limits, specified above by more than 20dB under any condition of modulation.

#### 4.1.2 LIMITS OF UNWANTED EMISSION OUT OF THE RESTRICTED BANDS

APPLICABLE TO	LIMIT	
	FIELD STRENGTH AT 3m (dBµV/m)	
	PK	AV
	74	54
√	EIRP LIMIT (dBm)	
	PK	PK
	-27	68.3

**NOTE:** The following formula is used to convert the equipment isotropic radiated power (eirp) to field strength:

$$E = \frac{1000000\sqrt{30P}}{3} \mu\text{V/m, where P is the eirp (Watts).}$$



#### 4.1.3 TEST INSTRUMENTS

Equipment	Manufacturer	Model No.	Serial No.	Last Cal.	Next Cal.
EMI Test Receiver	Rohde&Schwarz	ESU 26	100005	May 13,14	May 12,15
Bilog Antenna	Teseq	CBL 6111D	27089	Jun. 27, 14	Jun. 26, 15
Horn Antenna (1GHz -18GHz)	ETS -Lindgren	3117	00062558	May 30, 14	May 29, 16
Horn Antenna (15GHz-40GHz)	SCHWARZBECK	BBHA 9170	BBHA9170242	Feb. 13,14	Feb. 12,17
Amplifier (9kHz-1GHz)	SONOMA	310D	186955	Mar. 05,14	Mar. 04, 15
Pre-Amplifier (18GHz-40GHz)	EMCI	EMC 184045	980102	Nov. 03,14	Nov. 02,15
Pre-Amplifier (100MHz-26.5GHz)	Agilent	8449B	3008A00409	May 13,14	May 12,15
3m Semi-anechoic Chamber	ETS-LINDGREN	9m*6m*6m	NSEMC003	Apr. 19,14	Apr. 18,15
Test Software	ADT	ADT_Radiated _V7.6.15.9.2	N/A	N/A	N/A

**NOTE:**

1. The calibration interval of the above test instruments is 12 months and the calibrations are traceable to CEPREI/CHINA, GRGT/CHINA and NIM/CHINA.
2. The test was performed in 966 Chamber.
3. The FCC Site Registration No. is 502831.



#### 4.1.4 TEST PROCEDURES

- a. The EUT was placed on the top of a rotating table 0.8 meters above the ground at a 3 meter semi-anechoic chamber. The table was rotated 360 degrees to determine the position of the highest radiation.
- b. The EUT was set 3 meters away from the interference-receiving antenna, which was mounted on the top of a variable-height antenna tower.
- c. The antenna is a broadband antenna, and its height is varied from one meter to four meters above the ground to determine the maximum value of the field strength. Both horizontal and vertical polarizations of the antenna are set to make the measurement.
- d. For each suspected emission, the EUT was arranged to its worst case and then the antenna was tuned to heights from 1 meter to 4 meters and the rotatable table was turned from 0 degrees to 360 degrees to find the maximum reading.
- e. The test-receiver system was set to Peak Detect Function and Specified Bandwidth with Maximum Hold Mode.
- f. If the emission level of the EUT in peak mode was 10dB lower than the limit specified, then testing could be stopped and the peak values of the EUT would be reported. Otherwise the emissions that did not have 10dB margin would be re-tested one by one using peak, quasi-peak or average method as specified and then reported in a data sheet.

**NOTE:**

1. The resolution bandwidth and video bandwidth of test receiver/spectrum analyzer is 120kHz for Peak detection (PK) and Quasi-peak detection (QP) at frequency below 1GHz.
2. The resolution bandwidth of test receiver/spectrum analyzer is 1MHz and video bandwidth is 3MHz for Peak detection at frequency above 1GHz.
3. The resolution bandwidth of test receiver/spectrum analyzer is 1MHz and the video bandwidth is 10Hz for Average detection (AV) at frequency above 1GHz.
4. All modes of operation were investigated and the worst-case emissions are reported.

#### 4.1.5 DEVIATION FROM TEST STANDARD

No deviation.



#### 4.1.6 TEST SETUP

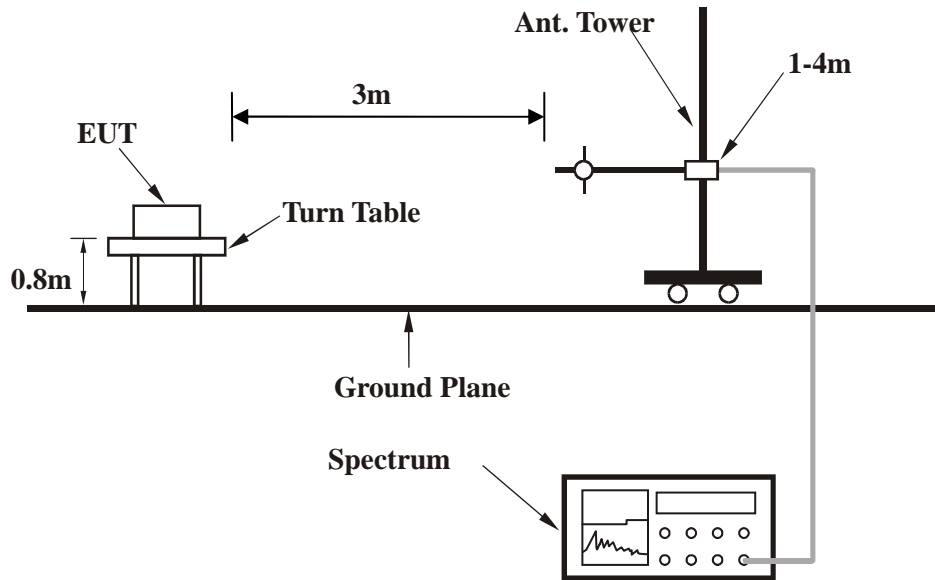

For the actual test configuration, please refer to the attached file (Test Setup Photo).

#### 4.1.7 EUT OPERATING CONDITION

- a. Set the EUT under full load condition and placed them on a testing table.
- b. Set the transmitter part of EUT under transmission condition continuously at specific channel frequency.
- c. The necessary accessories enable the EUT in full functions.



**4.1.8 TEST RESULTS**

**BELOW 1GHz WORST-CASE DATA:**

**802.11a**

<b>CHANNEL</b>	Channel 36	<b>DETECTOR FUNCTION</b>	Quasi-Peak (QP)
<b>FREQUENCY RANGE</b>	30MHz ~ 1GHz		

ANTENNA POLARITY & TEST DISTANCE: HORIZONTAL AT 3 M								
NO.	FREQ. (MHz)	EMISSION LEVEL (dBuV/m)	LIMIT (dBuV/m)	MARGIN (dB)	ANTENNA HEIGHT (m)	TABLE ANGLE (Degree)	RAW VALUE (dBuV)	CORRECTION FACTOR (dB/m)
1	151.25	33.9 QP	43.5	-9.7	1.00 H	0	20.58	13.27
2	227.42	36.9 QP	46.0	-9.1	1.00 H	0	24.73	12.18
3	303.59	39.1 QP	46.0	-6.9	1.00 H	0	22.58	16.54
4	340.90	37.8 QP	46.0	-8.2	1.00 H	0	20.18	17.66
5	381.31	38.7 QP	46.0	-7.4	1.00 H	0	19.95	18.70
6	479.25	36.5 QP	46.0	-9.5	1.00 H	0	14.92	21.56

**REMARKS:**

1. Emission level (dBuV/m) = Raw Value (dBuV) + Correction Factor (dB/m).
2. Correction Factor (dB/m) = Antenna Factor (dB/m) + Cable Factor (dB).
3. The other emission levels were very low against the limit.
4. Margin value = Emission level – Limit value.

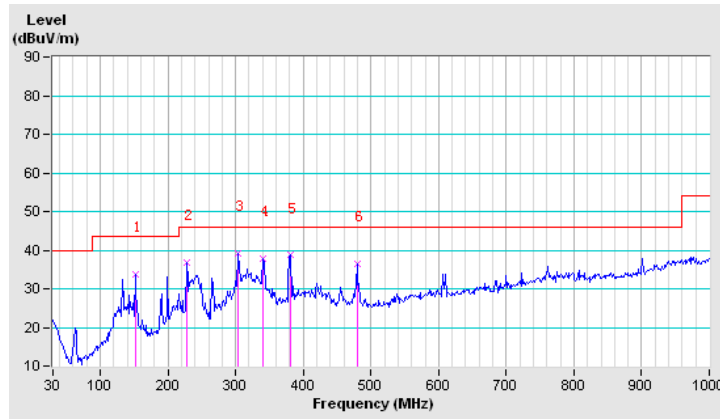



<b>CHANNEL</b>	Channel 36	<b>DETECTOR FUNCTION</b>	Quasi-Peak (QP)
<b>FREQUENCY RANGE</b>	30MHz ~ 1GHz		

ANTENNA POLARITY & TEST DISTANCE: VERTICAL AT 3 M								
NO.	FREQ. (MHz)	EMISSION LEVEL (dBuV/m)	LIMIT (dBuV/m)	MARGIN (dB)	ANTENNA HEIGHT (m)	TABLE ANGLE (Degree)	RAW VALUE (dBuV)	CORRECTION FACTOR (dB/m)
1	141.92	33.2 QP	43.5	-10.3	1.00 V	0	19.77	13.40
2	227.42	29.2 QP	46.0	-16.8	1.00 V	0	16.98	12.18
3	340.90	35.8 QP	46.0	-10.2	1.00 V	0	18.17	17.66
4	379.76	34.4 QP	46.0	-11.6	1.00 V	0	15.78	18.65
5	457.48	36.7 QP	46.0	-9.3	1.00 V	0	15.86	20.84
6	532.10	34.4 QP	46.0	-11.6	1.00 V	0	12.12	22.27

**REMARKS:**

1. Emission level (dBuV/m) = Raw Value (dBuV) + Correction Factor (dB/m).
2. Correction Factor (dB/m) = Antenna Factor (dB/m) + Cable Factor (dB).
3. The other emission levels were very low against the limit.
4. Margin value = Emission level – Limit value.

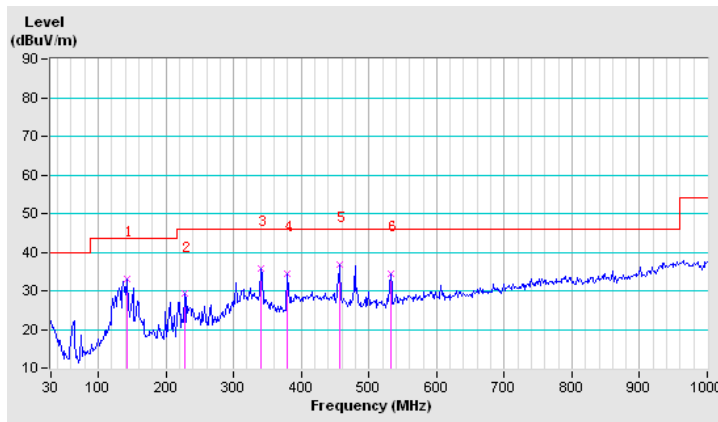



ABOVE 1GHz WORST-CASE DATA: Band 1

802.11a

CHANNEL	TX Channel 36	DETECTOR FUNCTION	Peak (PK)
FREQUENCY RANGE	1GHz ~ 40GHz		Average (AV)

ANTENNA POLARITY & TEST DISTANCE: HORIZONTAL AT 3 M								
NO.	FREQ. (MHz)	EMISSION LEVEL (dBuV/m)	LIMIT (dBuV/m)	MARGIN (dB)	ANTENNA HEIGHT (m)	TABLE ANGLE (Degree)	RAW VALUE (dBuV)	CORRECTION FACTOR (dB/m)
1	5150.00	57.3 PK	74.0	-16.7	1.19 H	224	17.32	39.98
2	5150.00	41.2 AV	54.0	-12.8	1.19 H	224	1.22	39.98
3	*5180.00	98.0 PK			1.19 H	224	57.96	40.04
4	*5180.00	81.2 AV			1.19 H	224	41.16	40.04
5	#10360.00	52.1 PK	74.0	-21.9	1.00 H	140	5.66	46.44
6	#10360.00	39.2 AV	54.0	-14.8	1.00 H	140	-7.24	46.44
ANTENNA POLARITY & TEST DISTANCE: VERTICAL AT 3 M								
NO.	FREQ. (MHz)	EMISSION LEVEL (dBuV/m)	LIMIT (dBuV/m)	MARGIN (dB)	ANTENNA HEIGHT (m)	TABLE ANGLE (Degree)	RAW VALUE (dBuV)	CORRECTION FACTOR (dB/m)
1	5150.00	58.4 PK	74.0	-15.6	1.07 V	273	18.42	39.98
2	5150.00	41.7 AV	54.0	-12.3	1.07 V	273	1.72	39.98
3	*5180.00	100.0 PK			1.07 V	273	59.96	40.04
4	*5180.00	83.1 AV			1.07 V	273	43.06	40.04
5	#10360.00	51.3 PK	74.0	-22.7	1.00 V	205	4.86	46.44
6	#10360.00	37.5 AV	54.0	-16.5	1.00 V	205	-8.94	46.44

REMARKS:

1. Emission level (dBuV/m) = Raw Value (dBuV) + Correction Factor (dB/m).
2. Correction Factor (dB/m) = Antenna Factor (dB/m) + Cable Factor (dB).
3. The other emission levels were very low against the limit.
4. Margin value = Emission level – Limit value.
5. " \* ": Fundamental frequency.
6. " # ": The radiated frequency is out of the restricted band.





CHANNEL	TX Channel 40	DETECTOR FUNCTION	Peak (PK)
FREQUENCY RANGE	1GHz ~ 40GHz		Average (AV)

ANTENNA POLARITY & TEST DISTANCE: HORIZONTAL AT 3 M

NO.	FREQ. (MHz)	EMISSION LEVEL (dBuV/m)	LIMIT (dBuV/m)	MARGIN (dB)	ANTENNA HEIGHT (m)	TABLE ANGLE (Degree)	RAW VALUE (dBuV)	CORRECTION FACTOR (dB/m)
1	#5200.00	97.1 PK			1.18 H	207	57.03	40.07
2	#5200.00	79.8 AV			1.18 H	207	39.73	40.07
3	#10400.00	51.9 PK	74.0	-22.1	1.00 H	96	5.38	46.52
4	#10400.00	37.5 AV	54.0	-16.5	1.00 H	96	-9.02	46.52

ANTENNA POLARITY & TEST DISTANCE: VERTICAL AT 3 M

NO.	FREQ. (MHz)	EMISSION LEVEL (dBuV/m)	LIMIT (dBuV/m)	MARGIN (dB)	ANTENNA HEIGHT (m)	TABLE ANGLE (Degree)	RAW VALUE (dBuV)	CORRECTION FACTOR (dB/m)
1	#5200.00	98.4 PK			1.19 V	273	58.33	40.07
2	#5200.00	81.9 AV			1.19 V	273	41.83	40.07
3	#10400.00	51.4 PK	74.0	-22.6	1.01 V	341	4.88	46.52
4	#10400.00	37.4 AV	54.0	-16.6	1.01 V	341	-9.12	46.52

REMARKS:

1. Emission level (dBuV/m) = Raw Value (dBuV) + Correction Factor (dB/m).
2. Correction Factor (dB/m) = Antenna Factor (dB/m) + Cable Factor (dB).
3. The other emission levels were very low against the limit.
4. Margin value = Emission level – Limit value.
5. " \* ": Fundamental frequency.
6. " # ": The radiated frequency is out of the restricted band.



CHANNEL	TX Channel 48	DETECTOR FUNCTION	Peak (PK)
FREQUENCY RANGE	1GHz ~ 40GHz		Average (AV)

ANTENNA POLARITY & TEST DISTANCE: HORIZONTAL AT 3 M								
NO.	FREQ. (MHz)	EMISSION LEVEL (dBuV/m)	LIMIT (dBuV/m)	MARGIN (dB)	ANTENNA HEIGHT (m)	TABLE ANGLE (Degree)	RAW VALUE (dBuV)	CORRECTION FACTOR (dB/m)
1	*5240.00	96.8 PK			1.08 H	211	56.66	40.14
2	*5240.00	79.9 AV			1.08 H	211	39.76	40.14
3	#10480.00	51.5 PK	74.0	-22.5	1.00 H	145	4.81	46.69
4	#10480.00	36.8 AV	54.0	-17.2	1.00 H	145	-9.89	46.69
ANTENNA POLARITY & TEST DISTANCE: VERTICAL AT 3 M								
NO.	FREQ. (MHz)	EMISSION LEVEL (dBuV/m)	LIMIT (dBuV/m)	MARGIN (dB)	ANTENNA HEIGHT (m)	TABLE ANGLE (Degree)	RAW VALUE (dBuV)	CORRECTION FACTOR (dB/m)
1	*5240.00	99.3 PK			1.07 V	275	59.16	40.14
2	*5240.00	82.0 AV			1.07 V	275	41.86	40.14
3	#10480.00	52.1 PK	74.0	-21.9	1.00 V	70	5.41	46.69
4	#10480.00	36.6 AV	54.0	-17.4	1.00 V	70	-10.09	46.69

REMARKS:

1. Emission level (dBuV/m) = Raw Value (dBuV) + Correction Factor (dB/m).
2. Correction Factor (dB/m) = Antenna Factor (dB/m) + Cable Factor (dB).
3. The other emission levels were very low against the limit.
4. Margin value = Emission level – Limit value.
5. " \* ": Fundamental frequency.
6. " # ": The radiated frequency is out of the restricted band.



**802.11n (20MHz)**

<b>CHANNEL</b>	TX Channel 36	<b>DETECTOR FUNCTION</b>	Peak (PK)
<b>FREQUENCY RANGE</b>	1GHz ~ 40GHz		Average (AV)

<b>ANTENNA POLARITY &amp; TEST DISTANCE: HORIZONTAL AT 3 M</b>								
<b>NO.</b>	<b>FREQ. (MHz)</b>	<b>EMISSION LEVEL (dBuV/m)</b>	<b>LIMIT (dBuV/m)</b>	<b>MARGIN (dB)</b>	<b>ANTENNA HEIGHT (m)</b>	<b>TABLE ANGLE (Degree)</b>	<b>RAW VALUE (dBuV)</b>	<b>CORRECTION FACTOR (dB/m)</b>
1	5150.00	57.3 PK	74.0	-16.7	1.20 H	227	17.32	39.98
2	5150.00	41.9 AV	54.0	-12.1	1.20 H	227	1.92	39.98
3	*5180.00	97.8 PK			1.20 H	227	57.76	40.04
4	*5180.00	81.1 AV			1.20 H	227	41.06	40.04
5	#10360.00	53.0 PK	74.0	-21.0	1.00 H	77	6.56	46.44
6	#10360.00	38.4 AV	54.0	-15.6	1.00 H	77	-8.04	46.44
<b>ANTENNA POLARITY &amp; TEST DISTANCE: VERTICAL AT 3 M</b>								
<b>NO.</b>	<b>FREQ. (MHz)</b>	<b>EMISSION LEVEL (dBuV/m)</b>	<b>LIMIT (dBuV/m)</b>	<b>MARGIN (dB)</b>	<b>ANTENNA HEIGHT (m)</b>	<b>TABLE ANGLE (Degree)</b>	<b>RAW VALUE (dBuV)</b>	<b>CORRECTION FACTOR (dB/m)</b>
1	5150.00	60.0 PK	74.0	-14.0	1.21 V	302	20.02	39.98
2	5150.00	42.0 AV	54.0	-12.0	1.21 V	302	2.02	39.98
3	*5180.00	99.4 PK			1.21 V	302	59.36	40.04
4	*5180.00	82.0 AV			1.21 V	302	41.96	40.04
5	#10360.00	52.5 PK	74.0	-21.5	1.00 V	229	6.06	46.44
6	#10360.00	37.5 AV	54.0	-16.5	1.00 V	229	-8.94	46.44

**REMARKS:**

1. Emission level (dBuV/m) = Raw Value (dBuV) + Correction Factor (dB/m).
2. Correction Factor (dB/m) = Antenna Factor (dB/m) + Cable Factor (dB).
3. The other emission levels were very low against the limit.
4. Margin value = Emission level – Limit value.
5. " \* ": Fundamental frequency.
6. " # ": The radiated frequency is out of the restricted band.



CHANNEL	TX Channel 40	DETECTOR FUNCTION	Peak (PK)
FREQUENCY RANGE	1GHz ~ 40GHz		Average (AV)

ANTENNA POLARITY & TEST DISTANCE: HORIZONTAL AT 3 M								
NO.	FREQ. (MHz)	EMISSION LEVEL (dBuV/m)	LIMIT (dBuV/m)	MARGIN (dB)	ANTENNA HEIGHT (m)	TABLE ANGLE (Degree)	RAW VALUE (dBuV)	CORRECTION FACTOR (dB/m)
1	#5200.00	95.8 PK			1.09 H	169	55.73	40.07
2	#5200.00	78.8 AV			1.09 H	169	38.73	40.07
3	#10400.00	52.1 PK	74.0	-21.9	1.00 H	130	5.58	46.52
4	#10400.00	37.7 AV	54.0	-16.3	1.00 H	130	-8.82	46.52
ANTENNA POLARITY & TEST DISTANCE: VERTICAL AT 3 M								
NO.	FREQ. (MHz)	EMISSION LEVEL (dBuV/m)	LIMIT (dBuV/m)	MARGIN (dB)	ANTENNA HEIGHT (m)	TABLE ANGLE (Degree)	RAW VALUE (dBuV)	CORRECTION FACTOR (dB/m)
1	#5200.00	97.7 PK			1.10 V	314	57.63	40.07
2	#5200.00	80.7 AV			1.10 V	314	40.63	40.07
3	#10400.00	51.9 PK	74.0	-22.1	1.00 V	320	5.38	46.52
4	#10400.00	37.2 AV	54.0	-16.8	1.00 V	320	-9.32	46.52

REMARKS:

1. Emission level (dBuV/m) = Raw Value (dBuV) + Correction Factor (dB/m).
2. Correction Factor (dB/m) = Antenna Factor (dB/m) + Cable Factor (dB).
3. The other emission levels were very low against the limit.
4. Margin value = Emission level – Limit value.
5. " \* ": Fundamental frequency.
6. " # ": The radiated frequency is out of the restricted band.



CHANNEL	TX Channel 48	DETECTOR FUNCTION	Peak (PK)
FREQUENCY RANGE	1GHz ~ 40GHz		Average (AV)

ANTENNA POLARITY & TEST DISTANCE: HORIZONTAL AT 3 M								
NO.	FREQ. (MHz)	EMISSION LEVEL (dBuV/m)	LIMIT (dBuV/m)	MARGIN (dB)	ANTENNA HEIGHT (m)	TABLE ANGLE (Degree)	RAW VALUE (dBuV)	CORRECTION FACTOR (dB/m)
1	*5240.00	96.0 PK			1.07 H	212	55.86	40.14
2	*5240.00	79.2 AV			1.07 H	212	39.06	40.14
3	#10480.00	51.6 PK	74.0	-22.4	1.00 H	164	4.91	46.69
4	#10480.00	37.3 AV	54.0	-16.7	1.00 H	164	-9.39	46.69
ANTENNA POLARITY & TEST DISTANCE: VERTICAL AT 3 M								
NO.	FREQ. (MHz)	EMISSION LEVEL (dBuV/m)	LIMIT (dBuV/m)	MARGIN (dB)	ANTENNA HEIGHT (m)	TABLE ANGLE (Degree)	RAW VALUE (dBuV)	CORRECTION FACTOR (dB/m)
1	*5240.00	97.7 PK			1.08 V	312	57.56	40.14
2	*5240.00	80.6 AV			1.08 V	312	40.46	40.14
3	#10480.00	52.2 PK	74.0	-21.8	1.00 V	210	5.51	46.69
4	#10480.00	37.8 AV	54.0	-16.2	1.00 V	210	-8.89	46.69

REMARKS:

1. Emission level (dBuV/m) = Raw Value (dBuV) + Correction Factor (dB/m).
2. Correction Factor (dB/m) = Antenna Factor (dB/m) + Cable Factor (dB).
3. The other emission levels were very low against the limit.
4. Margin value = Emission level – Limit value.
5. " \* ": Fundamental frequency.
6. " # ": The radiated frequency is out of the restricted band.



802.11n (40MHz)

CHANNEL	TX Channel 38	DETECTOR FUNCTION	Peak (PK)
FREQUENCY RANGE	1GHz ~ 40GHz		Average (AV)

ANTENNA POLARITY & TEST DISTANCE: HORIZONTAL AT 3 M								
NO.	FREQ. (MHz)	EMISSION LEVEL (dBuV/m)	LIMIT (dBuV/m)	MARGIN (dB)	ANTENNA HEIGHT (m)	TABLE ANGLE (Degree)	RAW VALUE (dBuV)	CORRECTION FACTOR (dB/m)
1	5150.00	61.3 PK	74.0	-12.7	1.19 H	226	21.32	39.98
2	5150.00	42.2 AV	54.0	-11.8	1.19 H	226	2.22	39.98
3	*5190.00	98.1 PK			1.19 H	226	58.05	40.05
4	*5190.00	87.0 AV			1.19 H	226	46.95	40.05
5	#10380.00	52.1 PK	74.0	-21.9	1.00 H	304	5.62	46.48
6	#10380.00	37.4 AV	54.0	-16.6	1.00 H	304	-9.08	46.48
ANTENNA POLARITY & TEST DISTANCE: VERTICAL AT 3 M								
NO.	FREQ. (MHz)	EMISSION LEVEL (dBuV/m)	LIMIT (dBuV/m)	MARGIN (dB)	ANTENNA HEIGHT (m)	TABLE ANGLE (Degree)	RAW VALUE (dBuV)	CORRECTION FACTOR (dB/m)
1	5150.00	61.0 PK	74.0	-13.0	1.00 V	313	21.02	39.98
2	5150.00	42.1 AV	54.0	-11.9	1.00 V	313	2.12	39.98
3	*5190.00	99.8 PK			1.00 V	313	59.75	40.05
4	*5190.00	87.8 AV			1.00 V	313	47.75	40.05
5	#10380.00	51.8 PK	74.0	-22.2	1.01 V	233	5.32	46.48
6	#10380.00	37.1 AV	54.0	-16.9	1.01 V	233	-9.38	46.48

REMARKS:

1. Emission level (dBuV/m) = Raw Value (dBuV) + Correction Factor (dB/m).
2. Correction Factor (dB/m) = Antenna Factor (dB/m) + Cable Factor (dB).
3. The other emission levels were very low against the limit.
4. Margin value = Emission level – Limit value.
5. " \* ": Fundamental frequency.
6. " # ": The radiated frequency is out of the restricted band.



<b>CHANNEL</b>	TX Channel 46	<b>DETECTOR FUNCTION</b>	Peak (PK)
<b>FREQUENCY RANGE</b>	1GHz ~ 40GHz		Average (AV)

ANTENNA POLARITY & TEST DISTANCE: HORIZONTAL AT 3 M								
NO.	FREQ. (MHz)	EMISSION LEVEL (dBuV/m)	LIMIT (dBuV/m)	MARGIN (dB)	ANTENNA HEIGHT (m)	TABLE ANGLE (Degree)	RAW VALUE (dBuV)	CORRECTION FACTOR (dB/m)
1	*5230.00	96.8 PK			1.07 H	212	56.68	40.12
2	*5230.00	85.4 AV			1.07 H	212	45.28	40.12
3	#10460.00	50.8 PK	74.0	-23.2	1.00 H	117	4.15	46.65
4	#10460.00	36.9 AV	54.0	-17.1	1.00 H	117	-9.75	46.65
ANTENNA POLARITY & TEST DISTANCE: VERTICAL AT 3 M								
NO.	FREQ. (MHz)	EMISSION LEVEL (dBuV/m)	LIMIT (dBuV/m)	MARGIN (dB)	ANTENNA HEIGHT (m)	TABLE ANGLE (Degree)	RAW VALUE (dBuV)	CORRECTION FACTOR (dB/m)
1	*5230.00	97.9 PK			1.20 V	312	57.78	40.12
2	*5230.00	86.7 AV			1.20 V	312	46.58	40.12
3	#10460.00	50.3 PK	74.0	-23.7	1.00 V	234	3.65	46.65
4	#10460.00	36.5 AV	54.0	-17.5	1.00 V	234	-10.15	46.65

**REMARKS:**

1. Emission level (dBuV/m) = Raw Value (dBuV) + Correction Factor (dB/m).
2. Correction Factor (dB/m) = Antenna Factor (dB/m) + Cable Factor (dB).
3. The other emission levels were very low against the limit.
4. Margin value = Emission level – Limit value.
5. " \* ": Fundamental frequency.
6. " # ": The radiated frequency is out of the restricted band.



**ABOVE 1GHz WORST-CASE DATA: Band 2**

**802.11a**

<b>CHANNEL</b>	TX Channel 52	<b>DETECTOR FUNCTION</b>	Peak (PK)
<b>FREQUENCY RANGE</b>	1GHz ~ 40GHz		Average (AV)

<b>ANTENNA POLARITY &amp; TEST DISTANCE: HORIZONTAL AT 3 M</b>								
<b>NO.</b>	<b>FREQ. (MHz)</b>	<b>EMISSION LEVEL (dBuV/m)</b>	<b>LIMIT (dBuV/m)</b>	<b>MARGIN (dB)</b>	<b>ANTENNA HEIGHT (m)</b>	<b>TABLE ANGLE (Degree)</b>	<b>RAW VALUE (dBuV)</b>	<b>CORRECTION FACTOR (dB/m)</b>
1	*5260.00	95.2 PK			1.03 H	292	55.02	40.18
2	*5260.00	78.8 AV			1.03 H	292	38.62	40.18
3	#10520.00	50.9 PK	74.0	-23.1	1.00 H	201	4.15	46.75
4	#10520.00	36.1 AV	54.0	-17.9	1.00 H	201	-10.65	46.75
<b>ANTENNA POLARITY &amp; TEST DISTANCE: VERTICAL AT 3 M</b>								
<b>NO.</b>	<b>FREQ. (MHz)</b>	<b>EMISSION LEVEL (dBuV/m)</b>	<b>LIMIT (dBuV/m)</b>	<b>MARGIN (dB)</b>	<b>ANTENNA HEIGHT (m)</b>	<b>TABLE ANGLE (Degree)</b>	<b>RAW VALUE (dBuV)</b>	<b>CORRECTION FACTOR (dB/m)</b>
1	*5260.00	98.3 PK			1.04 V	277	58.12	40.18
2	*5260.00	81.8 AV			1.04 V	277	41.62	40.18
3	#10520.00	50.8 PK	74.0	-23.2	1.01 V	311	4.05	46.75
4	#10520.00	35.7 AV	54.0	-18.3	1.01 V	311	-11.05	46.75

**REMARKS:**

1. Emission level (dBuV/m) = Raw Value (dBuV) + Correction Factor (dB/m).
2. Correction Factor (dB/m) = Antenna Factor (dB/m) + Cable Factor (dB).
3. The other emission levels were very low against the limit.
4. Margin value = Emission level – Limit value.
5. " \* ": Fundamental frequency.
6. " # ": The radiated frequency is out of the restricted band.





CHANNEL	TX Channel 60	DETECTOR FUNCTION	Peak (PK)
FREQUENCY RANGE	1GHz ~ 40GHz		Average (AV)

ANTENNA POLARITY & TEST DISTANCE: HORIZONTAL AT 3 M								
NO.	FREQ. (MHz)	EMISSION LEVEL (dBuV/m)	LIMIT (dBuV/m)	MARGIN (dB)	ANTENNA HEIGHT (m)	TABLE ANGLE (Degree)	RAW VALUE (dBuV)	CORRECTION FACTOR (dB/m)
1	*5300.00	93.8 PK			1.00 H	266	53.55	40.25
2	*5300.00	76.5 AV			1.00 H	266	36.25	40.25
3	10600.00	51.3 PK	74.0	-22.7	1.00 H	145	4.46	46.84
4	10600.00	36.9 AV	54.0	-17.1	1.00 H	145	-9.94	46.84
ANTENNA POLARITY & TEST DISTANCE: VERTICAL AT 3 M								
NO.	FREQ. (MHz)	EMISSION LEVEL (dBuV/m)	LIMIT (dBuV/m)	MARGIN (dB)	ANTENNA HEIGHT (m)	TABLE ANGLE (Degree)	RAW VALUE (dBuV)	CORRECTION FACTOR (dB/m)
1	*5300.00	97.2 PK			1.06 V	277	56.95	40.25
2	*5300.00	80.5 AV			1.06 V	277	40.25	40.25
3	10600.00	51.7 PK	74.0	-22.3	1.00 V	82	4.86	46.84
4	10600.00	36.5 AV	54.0	-17.5	1.00 V	82	-10.34	46.84

REMARKS:

1. Emission level (dBuV/m) = Raw Value (dBuV) + Correction Factor (dB/m).
2. Correction Factor (dB/m) = Antenna Factor (dB/m) + Cable Factor (dB).
3. The other emission levels were very low against the limit.
4. Margin value = Emission level – Limit value.
5. " \* ": Fundamental frequency.



CHANNEL	TX Channel 64	DETECTOR FUNCTION	Peak (PK)
FREQUENCY RANGE	1GHz ~ 40GHz		Average (AV)

ANTENNA POLARITY & TEST DISTANCE: HORIZONTAL AT 3 M

NO.	FREQ. (MHz)	EMISSION LEVEL (dBuV/m)	LIMIT (dBuV/m)	MARGIN (dB)	ANTENNA HEIGHT (m)	TABLE ANGLE (Degree)	RAW VALUE (dBuV)	CORRECTION FACTOR (dB/m)
1	*5320.00	93.2 PK			1.60 H	269	52.92	40.28
2	*5320.00	76.8 AV			1.60 H	269	36.52	40.28
3	5350.00	55.0 PK	74.0	-19.0	1.60 H	269	14.66	40.34
4	5350.00	40.6 AV	54.0	-13.4	1.60 H	269	0.26	40.34
5	10640.00	51.3 PK	74.0	-22.7	1.00 H	226	4.42	46.88
6	10640.00	36.2 AV	54.0	-17.8	1.00 H	226	-10.68	46.88

ANTENNA POLARITY & TEST DISTANCE: VERTICAL AT 3 M

NO.	FREQ. (MHz)	EMISSION LEVEL (dBuV/m)	LIMIT (dBuV/m)	MARGIN (dB)	ANTENNA HEIGHT (m)	TABLE ANGLE (Degree)	RAW VALUE (dBuV)	CORRECTION FACTOR (dB/m)
1	*5320.00	98.2 PK			1.03 V	276	57.92	40.28
2	*5320.00	80.7 AV			1.03 V	276	40.42	40.28
3	5350.00	53.9 PK	74.0	-20.1	1.03 V	N/A	13.56	40.34
4	5350.00	41.2 AV	54.0	-12.8	1.03 V	N/A	0.86	40.34
5	10640.00	51.9 PK	74.0	-22.1	1.00 V	108	5.02	46.88
6	10640.00	36.7 AV	54.0	-17.3	1.00 V	108	-10.18	46.88

REMARKS:

1. Emission level (dBuV/m) = Raw Value (dBuV) + Correction Factor (dB/m).
2. Correction Factor (dB/m) = Antenna Factor (dB/m) + Cable Factor (dB).
3. The other emission levels were very low against the limit.
4. Margin value = Emission level – Limit value.
5. " \* ": Fundamental frequency.



802.11n (20MHz)

CHANNEL	TX Channel 52	DETECTOR FUNCTION	Peak (PK)
FREQUENCY RANGE	1GHz ~ 40GHz		Average (AV)

ANTENNA POLARITY & TEST DISTANCE: HORIZONTAL AT 3 M								
NO.	FREQ. (MHz)	EMISSION LEVEL (dBuV/m)	LIMIT (dBuV/m)	MARGIN (dB)	ANTENNA HEIGHT (m)	TABLE ANGLE (Degree)	RAW VALUE (dBuV)	CORRECTION FACTOR (dB/m)
1	*5260.00	95.3 PK			1.03 H	290	55.12	40.18
2	*5260.00	77.6 AV			1.03 H	290	37.42	40.18
3	#10520.00	51.4 PK	74.0	-22.6	1.00 H	244	4.65	46.75
4	#10520.00	36.2 AV	54.0	-17.8	1.00 H	244	-10.55	46.75

ANTENNA POLARITY & TEST DISTANCE: VERTICAL AT 3 M								
NO.	FREQ. (MHz)	EMISSION LEVEL (dBuV/m)	LIMIT (dBuV/m)	MARGIN (dB)	ANTENNA HEIGHT (m)	TABLE ANGLE (Degree)	RAW VALUE (dBuV)	CORRECTION FACTOR (dB/m)
1	*5260.00	98.1 PK			1.06 V	278	57.92	40.18
2	*5260.00	80.5 AV			1.06 V	278	40.32	40.18
3	#10520.00	51.6 PK	74.0	-22.4	1.00 V	291	4.85	46.75
4	#10520.00	36.8 AV	54.0	-17.2	1.00 V	291	-9.95	46.75

REMARKS:

1. Emission level (dBuV/m) = Raw Value (dBuV) + Correction Factor (dB/m).
2. Correction Factor (dB/m) = Antenna Factor (dB/m) + Cable Factor (dB).
3. The other emission levels were very low against the limit.
4. Margin value = Emission level – Limit value.
5. " \* ": Fundamental frequency.
6. " # ": The radiated frequency is out of the restricted band.



CHANNEL	TX Channel 60	DETECTOR FUNCTION	Peak (PK)
FREQUENCY RANGE	1GHz ~ 40GHz		Average (AV)

ANTENNA POLARITY & TEST DISTANCE: HORIZONTAL AT 3 M								
NO.	FREQ. (MHz)	EMISSION LEVEL (dBuV/m)	LIMIT (dBuV/m)	MARGIN (dB)	ANTENNA HEIGHT (m)	TABLE ANGLE (Degree)	RAW VALUE (dBuV)	CORRECTION FACTOR (dB/m)
1	*5300.00	94.0 PK			1.02 H	271	53.75	40.25
2	*5300.00	76.8 AV			1.02 H	271	36.55	40.25
3	10600.00	51.9 PK	74.0	-22.1	1.00 H	192	5.06	46.84
4	10600.00	36.7 AV	54.0	-17.3	1.00 H	192	-10.14	46.84
ANTENNA POLARITY & TEST DISTANCE: VERTICAL AT 3 M								
NO.	FREQ. (MHz)	EMISSION LEVEL (dBuV/m)	LIMIT (dBuV/m)	MARGIN (dB)	ANTENNA HEIGHT (m)	TABLE ANGLE (Degree)	RAW VALUE (dBuV)	CORRECTION FACTOR (dB/m)
1	*5300.00	97.9 PK			1.05 V	277	57.65	40.25
2	*5300.00	80.4 AV			1.05 V	277	40.15	40.25
3	10600.00	51.5 PK	74.0	-22.5	1.00 V	66	4.66	46.84
4	10600.00	36.2 AV	54.0	-17.8	1.00 V	66	-10.64	46.84

REMARKS:

1. Emission level (dBuV/m) = Raw Value (dBuV) + Correction Factor (dB/m).
2. Correction Factor (dB/m) = Antenna Factor (dB/m) + Cable Factor (dB).
3. The other emission levels were very low against the limit.
4. Margin value = Emission level – Limit value.
5. " \* ": Fundamental frequency.



CHANNEL	TX Channel 64	DETECTOR FUNCTION	Peak (PK)
FREQUENCY RANGE	1GHz ~ 40GHz		Average (AV)

ANTENNA POLARITY & TEST DISTANCE: HORIZONTAL AT 3 M								
NO.	FREQ. (MHz)	EMISSION LEVEL (dBuV/m)	LIMIT (dBuV/m)	MARGIN (dB)	ANTENNA HEIGHT (m)	TABLE ANGLE (Degree)	RAW VALUE (dBuV)	CORRECTION FACTOR (dB/m)
1	*5320.00	93.3 PK			1.62 H	268	53.02	40.28
2	*5320.00	76.4 AV			1.62 H	268	36.12	40.28
3	5350.00	54.9 PK	74.0	-19.1	1.62 H	268	14.56	40.34
4	5350.00	40.7 AV	54.0	-13.3	1.62 H	268	0.36	40.34
5	10640.00	51.7 PK	74.0	-22.3	1.00 H	281	4.82	46.88
6	10640.00	37.0 AV	54.0	-17.0	1.00 H	281	-9.88	46.88
ANTENNA POLARITY & TEST DISTANCE: VERTICAL AT 3 M								
NO.	FREQ. (MHz)	EMISSION LEVEL (dBuV/m)	LIMIT (dBuV/m)	MARGIN (dB)	ANTENNA HEIGHT (m)	TABLE ANGLE (Degree)	RAW VALUE (dBuV)	CORRECTION FACTOR (dB/m)
1	*5320.00	97.6 PK			1.04 V	277	57.32	40.28
2	*5320.00	79.9 AV			1.04 V	277	39.62	40.28
3	5350.00	55.1 PK	74.0	-18.9	1.04 V	277	14.76	40.34
4	5350.00	41.0 AV	54.0	-13.0	1.04 V	277	0.66	40.34
5	10640.00	51.6 PK	74.0	-22.4	1.00 V	162	4.72	46.88
6	10640.00	36.8 AV	54.0	-17.2	1.00 V	162	-10.08	46.88

REMARKS:

1. Emission level (dBuV/m) = Raw Value (dBuV) + Correction Factor (dB/m).
2. Correction Factor (dB/m) = Antenna Factor (dB/m) + Cable Factor (dB).
3. The other emission levels were very low against the limit.
4. Margin value = Emission level – Limit value.
5. " \* ": Fundamental frequency.



802.11n (40MHz)

CHANNEL	TX Channel 54	DETECTOR FUNCTION	Peak (PK)
FREQUENCY RANGE	1GHz ~ 40GHz		Average (AV)

ANTENNA POLARITY & TEST DISTANCE: HORIZONTAL AT 3 M

NO.	FREQ. (MHz)	EMISSION LEVEL (dBuV/m)	LIMIT (dBuV/m)	MARGIN (dB)	ANTENNA HEIGHT (m)	TABLE ANGLE (Degree)	RAW VALUE (dBuV)	CORRECTION FACTOR (dB/m)
1	*5270.00	94.6 PK			1.60 H	283	54.40	40.20
2	*5270.00	83.5 AV			1.60 H	283	43.30	40.20
3	#10540.00	51.6 PK	74.0	-22.4	1.00 H	80	4.83	46.77
4	#10540.00	37.8 AV	54.0	-16.2	1.00 H	80	-8.97	46.77

ANTENNA POLARITY & TEST DISTANCE: VERTICAL AT 3 M

NO.	FREQ. (MHz)	EMISSION LEVEL (dBuV/m)	LIMIT (dBuV/m)	MARGIN (dB)	ANTENNA HEIGHT (m)	TABLE ANGLE (Degree)	RAW VALUE (dBuV)	CORRECTION FACTOR (dB/m)
1	*5270.00	99.2 PK			1.18 V	303	59.00	40.20
2	*5270.00	87.5 AV			1.18 V	303	47.30	40.20
3	#10540.00	51.1 PK	74.0	-22.9	1.00 V	125	4.33	46.77
4	#10540.00	37.6 AV	54.0	-16.4	1.00 V	125	-9.17	46.77

REMARKS:

1. Emission level (dBuV/m) = Raw Value (dBuV) + Correction Factor (dB/m).
2. Correction Factor (dB/m) = Antenna Factor (dB/m) + Cable Factor (dB).
3. The other emission levels were very low against the limit.
4. Margin value = Emission level – Limit value.
5. " \* ": Fundamental frequency.
6. " # ": The radiated frequency is out of the restricted band.



CHANNEL	TX Channel 62	DETECTOR FUNCTION	Peak (PK)
FREQUENCY RANGE	1GHz ~ 40GHz		Average (AV)

ANTENNA POLARITY & TEST DISTANCE: HORIZONTAL AT 3 M								
NO.	FREQ. (MHz)	EMISSION LEVEL (dBuV/m)	LIMIT (dBuV/m)	MARGIN (dB)	ANTENNA HEIGHT (m)	TABLE ANGLE (Degree)	RAW VALUE (dBuV)	CORRECTION FACTOR (dB/m)
1	*5310.00	93.0 PK			1.01 H	266	52.73	40.27
2	*5310.00	81.0 AV			1.01 H	266	40.73	40.27
3	5350.00	54.7 PK	74.0	-19.3	1.01 H	266	14.36	40.34
4	5350.00	41.1 AV	54.0	-12.9	1.01 H	266	0.76	40.34
5	10620.00	51.8 PK	74.0	-22.2	1.00 H	233	4.94	46.86
6	10620.00	37.4 AV	54.0	-16.6	1.00 H	233	-9.46	46.86
ANTENNA POLARITY & TEST DISTANCE: VERTICAL AT 3 M								
NO.	FREQ. (MHz)	EMISSION LEVEL (dBuV/m)	LIMIT (dBuV/m)	MARGIN (dB)	ANTENNA HEIGHT (m)	TABLE ANGLE (Degree)	RAW VALUE (dBuV)	CORRECTION FACTOR (dB/m)
1	*5310.00	97.4 PK			1.16 V	273	57.13	40.27
2	*5310.00	86.3 AV			1.16 V	273	46.03	40.27
3	5350.00	54.8 PK	74.0	-19.2	1.16 V	273	14.46	40.34
4	5350.00	41.3 AV	54.0	-12.7	1.16 V	273	0.96	40.34
5	10620.00	51.6 PK	74.0	-22.4	1.00 V	190	4.74	46.86
6	10620.00	37.2 AV	54.0	-16.8	1.00 V	190	-9.66	46.86

REMARKS:

1. Emission level (dBuV/m) = Raw Value (dBuV) + Correction Factor (dB/m).
2. Correction Factor (dB/m) = Antenna Factor (dB/m) + Cable Factor (dB).
3. The other emission levels were very low against the limit.
4. Margin value = Emission level – Limit value.
5. " \* ": Fundamental frequency.



ABOVE 1GHz WORST-CASE DATA: Band 3

802.11a

CHANNEL	TX Channel 100	DETECTOR FUNCTION	Peak (PK)
FREQUENCY RANGE	1GHz ~ 40GHz		Average (AV)

ANTENNA POLARITY & TEST DISTANCE: HORIZONTAL AT 3 M

NO.	FREQ. (MHz)	EMISSION LEVEL (dBuV/m)	LIMIT (dBuV/m)	MARGIN (dB)	ANTENNA HEIGHT (m)	TABLE ANGLE (Degree)	RAW VALUE (dBuV)	CORRECTION FACTOR (dB/m)
1	5460.00	54.5 PK	74.0	-19.5	1.08 H	257	13.97	40.53
2	5460.00	41.6 AV	54.0	-12.4	1.08 H	257	1.07	40.53
3	#5470.00	54.2 PK	68.3	-14.1	1.08 H	257	13.65	40.55
4	*5500.00	95.9 PK			1.08 H	257	55.30	40.60
5	*5500.00	79.6 AV			1.08 H	257	39.00	40.60
6	11000.00	51.6 PK	74.0	-22.4	1.00 H	163	4.34	47.26
7	11000.00	36.7 AV	54.0	-17.3	1.00 H	163	-10.56	47.26

ANTENNA POLARITY & TEST DISTANCE: VERTICAL AT 3 M

NO.	FREQ. (MHz)	EMISSION LEVEL (dBuV/m)	LIMIT (dBuV/m)	MARGIN (dB)	ANTENNA HEIGHT (m)	TABLE ANGLE (Degree)	RAW VALUE (dBuV)	CORRECTION FACTOR (dB/m)
1	5460.00	54.1 PK	74.0	-19.9	1.01 V	278	13.57	40.53
2	5460.00	41.6 AV	54.0	-12.4	1.01 V	278	1.07	40.53
3	#5470.00	54.5 PK	68.3	-13.8	1.01 V	278	13.95	40.55
4	*5500.00	97.0 PK			1.01 V	278	56.40	40.60
5	*5500.00	80.3 AV			1.01 V	278	39.70	40.60
6	11000.00	50.8 PK	74.0	-23.2	1.00 V	335	3.54	47.26
7	11000.00	36.2 AV	54.0	-17.8	1.00 V	335	-11.06	47.26

REMARKS:

1. Emission level (dBuV/m) = Raw Value (dBuV) + Correction Factor (dB/m).
2. Correction Factor (dB/m) = Antenna Factor (dB/m) + Cable Factor (dB).
3. The other emission levels were very low against the limit.
4. Margin value = Emission level – Limit value.
5. " \* ": Fundamental frequency.
6. " # ": The radiated frequency is out of the restricted band.





CHANNEL	TX Channel 116	DETECTOR FUNCTION	Peak (PK)
FREQUENCY RANGE	1GHz ~ 40GHz		Average (AV)

ANTENNA POLARITY & TEST DISTANCE: HORIZONTAL AT 3 M								
NO.	FREQ. (MHz)	EMISSION LEVEL (dBuV/m)	LIMIT (dBuV/m)	MARGIN (dB)	ANTENNA HEIGHT (m)	TABLE ANGLE (Degree)	RAW VALUE (dBuV)	CORRECTION FACTOR (dB/m)
1	*5580.00	97.8 PK			1.16 H	239	56.99	40.81
2	*5580.00	81.3 AV			1.16 H	239	40.49	40.81
3	11160.00	51.5 PK	74.0	-22.5	1.00 H	68	4.11	47.39
4	11160.00	36.7 AV	54.0	-17.3	1.00 H	68	-10.69	47.39
ANTENNA POLARITY & TEST DISTANCE: VERTICAL AT 3 M								
NO.	FREQ. (MHz)	EMISSION LEVEL (dBuV/m)	LIMIT (dBuV/m)	MARGIN (dB)	ANTENNA HEIGHT (m)	TABLE ANGLE (Degree)	RAW VALUE (dBuV)	CORRECTION FACTOR (dB/m)
1	*5580.00	97.7 PK			1.08 V	288	56.89	40.81
2	*5580.00	81.6 AV			1.08 V	288	40.79	40.81
3	11160.00	51.8 PK	74.0	-22.2	1.00 V	154	4.41	47.39
4	11160.00	36.9 AV	54.0	-17.1	1.00 V	154	-10.49	47.39

REMARKS:

1. Emission level (dBuV/m) = Raw Value (dBuV) + Correction Factor (dB/m).
2. Correction Factor (dB/m) = Antenna Factor (dB/m) + Cable Factor (dB).
3. The other emission levels were very low against the limit.
4. Margin value = Emission level – Limit value.
5. " \* ": Fundamental frequency.



CHANNEL	TX Channel 140	DETECTOR FUNCTION	Peak (PK)
FREQUENCY RANGE	1GHz ~ 40GHz		Average (AV)

ANTENNA POLARITY & TEST DISTANCE: HORIZONTAL AT 3 M								
NO.	FREQ. (MHz)	EMISSION LEVEL (dBuV/m)	LIMIT (dBuV/m)	MARGIN (dB)	ANTENNA HEIGHT (m)	TABLE ANGLE (Degree)	RAW VALUE (dBuV)	CORRECTION FACTOR (dB/m)
1	*5700.00	101.4 PK			1.13 H	261	60.27	41.13
2	*5700.00	84.5 AV			1.13 H	261	43.37	41.13
3	#5725.00	60.5 PK	68.3	-7.8	1.13 H	261	19.31	41.19
4	11400.00	51.4 PK	74.0	-22.6	1.00 H	201	3.80	47.60
5	11400.00	36.5 AV	54.0	-17.5	1.00 H	201	-11.10	47.60
ANTENNA POLARITY & TEST DISTANCE: VERTICAL AT 3 M								
NO.	FREQ. (MHz)	EMISSION LEVEL (dBuV/m)	LIMIT (dBuV/m)	MARGIN (dB)	ANTENNA HEIGHT (m)	TABLE ANGLE (Degree)	RAW VALUE (dBuV)	CORRECTION FACTOR (dB/m)
1	*5700.00	99.4 PK			1.08 V	307	58.27	41.13
2	*5700.00	83.1 AV			1.08 V	307	41.97	41.13
3	#5725.00	59.2 PK	68.3	-9.1	1.08 V	307	18.01	41.19
4	11400.00	52.0 PK	74.0	-22.0	1.00 V	190	4.40	47.60
5	11400.00	36.8 AV	54.0	-17.2	1.00 V	190	-10.80	47.60

REMARKS:

1. Emission level (dBuV/m) = Raw Value (dBuV) + Correction Factor (dB/m).
2. Correction Factor (dB/m) = Antenna Factor (dB/m) + Cable Factor (dB).
3. The other emission levels were very low against the limit.
4. Margin value = Emission level – Limit value.
5. " \* ": Fundamental frequency.
6. " # ": The radiated frequency is out of the restricted band.



802.11n (20MHz)

CHANNEL	TX Channel 100	DETECTOR FUNCTION	Peak (PK)
FREQUENCY RANGE	1GHz ~ 40GHz		Average (AV)

ANTENNA POLARITY & TEST DISTANCE: HORIZONTAL AT 3 M								
NO.	FREQ. (MHz)	EMISSION LEVEL (dBuV/m)	LIMIT (dBuV/m)	MARGIN (dB)	ANTENNA HEIGHT (m)	TABLE ANGLE (Degree)	RAW VALUE (dBuV)	CORRECTION FACTOR (dB/m)
1	5460.00	54.8 PK	74.0	-19.2	1.17 H	257	14.27	40.53
2	5460.00	41.1 AV	54.0	-12.9	1.17 H	257	0.57	40.53
3	#5470.00	55.1 PK	68.3	-13.2	1.17 H	257	14.55	40.55
4	*5500.00	95.4 PK			1.17 H	257	54.80	40.60
5	*5500.00	78.3 AV			1.17 H	257	37.70	40.60
6	11100.00	51.4 PK	74.0	-22.6	1.00 H	182	4.06	47.34
7	11100.00	36.0 AV	54.0	-18.0	1.00 H	182	-11.34	47.34

ANTENNA POLARITY & TEST DISTANCE: VERTICAL AT 3 M								
NO.	FREQ. (MHz)	EMISSION LEVEL (dBuV/m)	LIMIT (dBuV/m)	MARGIN (dB)	ANTENNA HEIGHT (m)	TABLE ANGLE (Degree)	RAW VALUE (dBuV)	CORRECTION FACTOR (dB/m)
1	5460.00	54.5 PK	74.0	-19.5	1.01 V	279	13.97	40.53
2	5460.00	41.0 AV	54.0	-13.0	1.01 V	279	0.47	40.53
3	#5470.00	55.2 PK	68.3	-13.1	1.01 V	279	14.65	40.55
4	*5500.00	96.6 PK			1.01 V	279	56.00	40.60
5	*5500.00	79.3 AV			1.01 V	279	38.70	40.60
6	11000.00	50.9 PK	74.0	-23.1	1.00 V	306	3.64	47.26
7	11000.00	35.9 AV	54.0	-18.1	1.00 V	306	-11.36	47.26

REMARKS:

1. Emission level (dBuV/m) = Raw Value (dBuV) + Correction Factor (dB/m).
2. Correction Factor (dB/m) = Antenna Factor (dB/m) + Cable Factor (dB).
3. The other emission levels were very low against the limit.
4. Margin value = Emission level – Limit value.
5. " \* ": Fundamental frequency.
6. " # ": The radiated frequency is out of the restricted band.



CHANNEL	TX Channel 116	DETECTOR FUNCTION	Peak (PK)
FREQUENCY RANGE	1GHz ~ 40GHz		Average (AV)

ANTENNA POLARITY & TEST DISTANCE: HORIZONTAL AT 3 M								
NO.	FREQ. (MHz)	EMISSION LEVEL (dBuV/m)	LIMIT (dBuV/m)	MARGIN (dB)	ANTENNA HEIGHT (m)	TABLE ANGLE (Degree)	RAW VALUE (dBuV)	CORRECTION FACTOR (dB/m)
1	*5580.00	96.7 PK			1.16 H	240	55.89	40.81
2	*5580.00	80.3 AV			1.16 H	240	39.49	40.81
3	11160.00	51.6 PK	74.0	-22.4	1.00 H	47	4.21	47.39
4	11160.00	37.1 AV	54.0	-16.9	1.00 H	47	-10.29	47.39
ANTENNA POLARITY & TEST DISTANCE: VERTICAL AT 3 M								
NO.	FREQ. (MHz)	EMISSION LEVEL (dBuV/m)	LIMIT (dBuV/m)	MARGIN (dB)	ANTENNA HEIGHT (m)	TABLE ANGLE (Degree)	RAW VALUE (dBuV)	CORRECTION FACTOR (dB/m)
1	*5580.00	97.3 PK			1.10 V	288	56.49	40.81
2	*5580.00	80.7 AV			1.10 V	288	39.89	40.81
3	11160.00	51.1 PK	74.0	-22.9	1.00 V	111	3.71	47.39
4	11160.00	36.9 AV	54.0	-17.1	1.00 V	111	-10.49	47.39

REMARKS:

1. Emission level (dBuV/m) = Raw Value (dBuV) + Correction Factor (dB/m).
2. Correction Factor (dB/m) = Antenna Factor (dB/m) + Cable Factor (dB).
3. The other emission levels were very low against the limit.
4. Margin value = Emission level – Limit value.
5. " \* ": Fundamental frequency.



CHANNEL	TX Channel 140	DETECTOR FUNCTION	Peak (PK)
FREQUENCY RANGE	1GHz ~ 40GHz		Average (AV)

ANTENNA POLARITY & TEST DISTANCE: HORIZONTAL AT 3 M								
NO.	FREQ. (MHz)	EMISSION LEVEL (dBuV/m)	LIMIT (dBuV/m)	MARGIN (dB)	ANTENNA HEIGHT (m)	TABLE ANGLE (Degree)	RAW VALUE (dBuV)	CORRECTION FACTOR (dB/m)
1	*5700.00	101.4 PK			1.14 H	264	60.27	41.13
2	*5700.00	83.9 AV			1.14 H	264	42.77	41.13
3	#5725.00	64.5 PK	68.3	-3.8	1.14 H	264	23.31	41.19
4	11400.00	51.7 PK	74.0	-22.3	1.00 H	245	4.10	47.60
5	11400.00	37.0 AV	54.0	-17.0	1.00 H	245	-10.60	47.60
ANTENNA POLARITY & TEST DISTANCE: VERTICAL AT 3 M								
NO.	FREQ. (MHz)	EMISSION LEVEL (dBuV/m)	LIMIT (dBuV/m)	MARGIN (dB)	ANTENNA HEIGHT (m)	TABLE ANGLE (Degree)	RAW VALUE (dBuV)	CORRECTION FACTOR (dB/m)
1	*5700.00	98.2 PK			1.20 V	307	57.07	41.13
2	*5700.00	81.5 AV			1.20 V	307	40.37	41.13
3	#5725.00	62.0 PK	68.3	-6.3	1.20 V	307	20.81	41.19
4	11400.00	51.9 PK	74.0	-22.1	1.00 V	177	4.30	47.60
5	11400.00	36.7 AV	54.0	-17.3	1.00 V	177	-10.90	47.60

REMARKS:

1. Emission level (dBuV/m) = Raw Value (dBuV) + Correction Factor (dB/m).
2. Correction Factor (dB/m) = Antenna Factor (dB/m) + Cable Factor (dB).
3. The other emission levels were very low against the limit.
4. Margin value = Emission level – Limit value.
5. " \* ": Fundamental frequency.
6. " # ": The radiated frequency is out of the restricted band.



802.11n (40MHz)

CHANNEL	TX Channel 102	DETECTOR FUNCTION	Peak (PK)
FREQUENCY RANGE	1GHz ~ 40GHz		Average (AV)

ANTENNA POLARITY & TEST DISTANCE: HORIZONTAL AT 3 M								
NO.	FREQ. (MHz)	EMISSION LEVEL (dBuV/m)	LIMIT (dBuV/m)	MARGIN (dB)	ANTENNA HEIGHT (m)	TABLE ANGLE (Degree)	RAW VALUE (dBuV)	CORRECTION FACTOR (dB/m)
1	5460.00	54.8 PK	74.0	-19.2	1.06 H	258	14.27	40.53
2	5460.00	41.1 AV	54.0	-12.9	1.06 H	258	0.57	40.53
3	#5470.00	54.9 PK	68.3	-13.4	1.06 H	258	14.35	40.55
4	*5510.00	97.4 PK			1.06 H	258	56.77	40.63
5	*5510.00	80.4 AV			1.06 H	258	39.77	40.63
6	11020.00	51.7 PK	74.0	-22.3	1.00 H	167	4.42	47.28
7	11020.00	37.2 AV	54.0	-16.8	1.00 H	167	-10.08	47.28
ANTENNA POLARITY & TEST DISTANCE: VERTICAL AT 3 M								
NO.	FREQ. (MHz)	EMISSION LEVEL (dBuV/m)	LIMIT (dBuV/m)	MARGIN (dB)	ANTENNA HEIGHT (m)	TABLE ANGLE (Degree)	RAW VALUE (dBuV)	CORRECTION FACTOR (dB/m)
1	5460.00	54.4 PK	74.0	-19.6	1.01 V	288	13.87	40.53
2	5460.00	41.5 AV	54.0	-12.5	1.01 V	288	0.97	40.53
3	#5470.00	54.8 PK	68.3	-13.5	N/A V	N/A	14.25	40.55
4	*5510.00	96.8 PK			1.00 V	288	56.17	40.63
5	*5510.00	81.0 AV			1.00 V	288	40.37	40.63
6	11020.00	51.9 PK	74.0	-22.1	1.00 V	335	4.62	47.28
7	11020.00	36.5 AV	54.0	-17.5	1.00 V	335	-10.78	47.28

REMARKS:

1. Emission level (dBuV/m) = Raw Value (dBuV) + Correction Factor (dB/m).
2. Correction Factor (dB/m) = Antenna Factor (dB/m) + Cable Factor (dB).
3. The other emission levels were very low against the limit.
4. Margin value = Emission level – Limit value.
5. " \* ": Fundamental frequency.
6. " # ": The radiated frequency is out of the restricted band.



CHANNEL	TX Channel 110	DETECTOR FUNCTION	Peak (PK)
FREQUENCY RANGE	1GHz ~ 40GHz		Average (AV)

ANTENNA POLARITY & TEST DISTANCE: HORIZONTAL AT 3 M								
NO.	FREQ. (MHz)	EMISSION LEVEL (dBuV/m)	LIMIT (dBuV/m)	MARGIN (dB)	ANTENNA HEIGHT (m)	TABLE ANGLE (Degree)	RAW VALUE (dBuV)	CORRECTION FACTOR (dB/m)
1	*5550.00	98.7 PK			1.06 H	262	57.97	40.73
2	*5550.00	87.9 AV			1.06 H	262	47.17	40.73
3	11100.00	51.8 PK	74.0	-22.2	1.00 H	108	4.46	47.34
4	11100.00	36.7 AV	54.0	-17.3	1.00 H	108	-10.64	47.34
ANTENNA POLARITY & TEST DISTANCE: VERTICAL AT 3 M								
NO.	FREQ. (MHz)	EMISSION LEVEL (dBuV/m)	LIMIT (dBuV/m)	MARGIN (dB)	ANTENNA HEIGHT (m)	TABLE ANGLE (Degree)	RAW VALUE (dBuV)	CORRECTION FACTOR (dB/m)
1	*5550.00	99.0 PK			1.09 V	281	58.27	40.73
2	*5550.00	88.0 AV			1.09 V	281	47.27	40.73
3	11100.00	52.1 PK	74.0	-21.9	1.00 V	30	4.76	47.34
4	11100.00	37.0 AV	54.0	-17.0	1.00 V	30	-10.34	47.34

REMARKS:

1. Emission level (dBuV/m) = Raw Value (dBuV) + Correction Factor (dB/m).
2. Correction Factor (dB/m) = Antenna Factor (dB/m) + Cable Factor (dB).
3. The other emission levels were very low against the limit.
4. Margin value = Emission level – Limit value.
5. " \* ": Fundamental frequency.



<b>CHANNEL</b>	TX Channel 134	<b>DETECTOR FUNCTION</b>	Peak (PK)
<b>FREQUENCY RANGE</b>	1GHz ~ 40GHz		Average (AV)

ANTENNA POLARITY & TEST DISTANCE: HORIZONTAL AT 3 M								
NO.	FREQ. (MHz)	EMISSION LEVEL (dBuV/m)	LIMIT (dBuV/m)	MARGIN (dB)	ANTENNA HEIGHT (m)	TABLE ANGLE (Degree)	RAW VALUE (dBuV)	CORRECTION FACTOR (dB/m)
1	*5670.00	100.6 PK			1.12 H	262	59.55	41.05
2	*5670.00	92.3 AV			1.12 H	262	51.25	41.05
3	#5725.00	55.3 PK	68.3	-13.0	1.12 H	262	14.11	41.19
4	11340.00	52.3 PK	74.0	-21.7	1.00 H	280	4.75	47.55
5	11340.00	37.1 AV	54.0	-16.9	1.00 H	280	-10.45	47.55
ANTENNA POLARITY & TEST DISTANCE: VERTICAL AT 3 M								
NO.	FREQ. (MHz)	EMISSION LEVEL (dBuV/m)	LIMIT (dBuV/m)	MARGIN (dB)	ANTENNA HEIGHT (m)	TABLE ANGLE (Degree)	RAW VALUE (dBuV)	CORRECTION FACTOR (dB/m)
1	*5670.00	104.0 PK			1.07 V	312	62.95	41.05
2	*5670.00	91.9 AV			1.07 V	312	50.85	41.05
3	#5725.00	57.5 PK	68.3	-10.8	1.07 V	312	16.31	41.19
4	11340.00	52.3 PK	74.0	-21.7	1.00 V	118	4.75	47.55
5	11340.00	37.1 AV	54.0	-16.9	1.00 V	118	-10.45	47.55

REMARKS:

1. Emission level (dBuV/m) = Raw Value (dBuV) + Correction Factor (dB/m).
2. Correction Factor (dB/m) = Antenna Factor (dB/m) + Cable Factor (dB).
3. The other emission levels were very low against the limit.
4. Margin value = Emission level – Limit value.
5. " \* ": Fundamental frequency.
6. " # ": The radiated frequency is out of the restricted band.





**ABOVE 1GHz WORST-CASE DATA: Band 4**

**802.11a**

<b>CHANNEL</b>	TX Channel 149	<b>DETECTOR FUNCTION</b>	Peak (PK)
<b>FREQUENCY RANGE</b>	1GHz ~ 40GHz		Average (AV)

ANTENNA POLARITY & TEST DISTANCE: HORIZONTAL AT 3 M								
NO.	FREQ. (MHz)	EMISSION LEVEL (dBuV/m)	LIMIT (dBuV/m)	MARGIN (dB)	ANTENNA HEIGHT (m)	TABLE ANGLE (Degree)	RAW VALUE (dBuV)	CORRECTION FACTOR (dB/m)
1	#5715.00	58.5 PK	68.3	-9.8	1.58 H	280	17.33	41.17
2	#5725.00	73.6 PK	78.3	-4.7	1.58 H	280	32.41	41.19
3	*5745.00	103.4 PK			1.58 H	280	62.15	41.25
4	*5745.00	84.7 AV			1.58 H	280	43.45	41.25
5	11490.00	52.4 PK	74.0	-21.6	1.00 H	210	4.73	47.67
6	11490.00	38.1 AV	54.0	-15.9	1.00 H	210	-9.57	47.67
ANTENNA POLARITY & TEST DISTANCE: VERTICAL AT 3 M								
NO.	FREQ. (MHz)	EMISSION LEVEL (dBuV/m)	LIMIT (dBuV/m)	MARGIN (dB)	ANTENNA HEIGHT (m)	TABLE ANGLE (Degree)	RAW VALUE (dBuV)	CORRECTION FACTOR (dB/m)
1	#5715.00	57.6 PK	68.3	-10.7	1.06 V	292	16.43	41.17
2	#5725.00	74.5 PK	78.3	-3.8	1.06 V	292	33.31	41.19
3	*5745.00	106.2 PK			1.06 V	292	64.95	41.25
4	*5745.00	85.2 AV			1.06 V	292	43.95	41.25
5	11490.00	52.6 PK	74.0	-21.4	1.00 V	262	4.93	47.67
6	11490.00	38.4 AV	54.0	-15.6	1.00 V	262	-9.27	47.67

**REMARKS:**

1. Emission level (dBuV/m) = Raw Value (dBuV) + Correction Factor (dB/m).
2. Correction Factor (dB/m) = Antenna Factor (dB/m) + Cable Factor (dB).
3. The other emission levels were very low against the limit.
4. Margin value = Emission level – Limit value.
5. " \* ": Fundamental frequency.
6. " # ": The radiated frequency is out of the restricted band.



CHANNEL	TX Channel 157	DETECTOR FUNCTION	Peak (PK)
FREQUENCY RANGE	1GHz ~ 40GHz		Average (AV)

ANTENNA POLARITY & TEST DISTANCE: HORIZONTAL AT 3 M								
NO.	FREQ. (MHz)	EMISSION LEVEL (dBuV/m)	LIMIT (dBuV/m)	MARGIN (dB)	ANTENNA HEIGHT (m)	TABLE ANGLE (Degree)	RAW VALUE (dBuV)	CORRECTION FACTOR (dB/m)
1	*5785.00	101.8 PK			1.55 H	280	60.45	41.35
2	*5785.00	85.1 AV			1.55 H	280	43.75	41.35
3	11570.00	51.3 PK	74.0	-22.7	1.00 H	304	3.55	47.75
4	11570.00	37.8 AV	54.0	-16.2	1.00 H	304	-9.95	47.75
ANTENNA POLARITY & TEST DISTANCE: VERTICAL AT 3 M								
NO.	FREQ. (MHz)	EMISSION LEVEL (dBuV/m)	LIMIT (dBuV/m)	MARGIN (dB)	ANTENNA HEIGHT (m)	TABLE ANGLE (Degree)	RAW VALUE (dBuV)	CORRECTION FACTOR (dB/m)
1	*5785.00	103.3 PK			1.16 V	292	61.95	41.35
2	*5785.00	84.6 AV			1.16 V	292	43.25	41.35
3	11570.00	51.7 PK	74.0	-22.3	1.00 V	254	3.95	47.75
4	11570.00	38.0 AV	54.0	-16.0	1.00 V	254	-9.75	47.75

REMARKS:

1. Emission level (dBuV/m) = Raw Value (dBuV) + Correction Factor (dB/m).
2. Correction Factor (dB/m) = Antenna Factor (dB/m) + Cable Factor (dB).
3. The other emission levels were very low against the limit.
4. Margin value = Emission level – Limit value.
5. " \* ": Fundamental frequency.



CHANNEL	TX Channel 161	DETECTOR FUNCTION	Peak (PK)
FREQUENCY RANGE	1GHz ~ 40GHz		Average (AV)

ANTENNA POLARITY & TEST DISTANCE: HORIZONTAL AT 3 M

NO.	FREQ. (MHz)	EMISSION LEVEL (dBuV/m)	LIMIT (dBuV/m)	MARGIN (dB)	ANTENNA HEIGHT (m)	TABLE ANGLE (Degree)	RAW VALUE (dBuV)	CORRECTION FACTOR (dB/m)
1	*5805.00	97.2 PK			1.53 H	280	55.79	41.41
2	*5805.00	78.3 AV			1.53 H	280	36.89	41.41
3	#5850.00	47.3 PK	78.3	-31.0	1.53 H	280	5.78	41.52
4	#5860.00	46.1 PK	68.3	-22.2	1.53 H	280	4.55	41.55
5	11610.00	52.3 PK	74.0	-21.7	1.00 H	194	4.51	47.79
6	11610.00	38.4 AV	54.0	-15.6	1.00 H	194	-9.39	47.79

ANTENNA POLARITY & TEST DISTANCE: VERTICAL AT 3 M

NO.	FREQ. (MHz)	EMISSION LEVEL (dBuV/m)	LIMIT (dBuV/m)	MARGIN (dB)	ANTENNA HEIGHT (m)	TABLE ANGLE (Degree)	RAW VALUE (dBuV)	CORRECTION FACTOR (dB/m)
1	*5805.00	101.7 PK			1.18 V	300	60.29	41.41
2	*5805.00	84.0 AV			1.18 V	300	42.59	41.41
3	#5850.00	51.0 PK	78.3	-27.3	1.18 V	300	9.48	41.52
4	#5860.00	48.1 PK	68.3	-20.2	1.18 V	300	6.55	41.55
5	11610.00	51.7 PK	74.0	-22.3	1.00 V	125	3.91	47.79
6	11610.00	38.2 AV	54.0	-15.8	1.00 V	125	-9.59	47.79

REMARKS:

1. Emission level (dBuV/m) = Raw Value (dBuV) + Correction Factor (dB/m).
2. Correction Factor (dB/m) = Antenna Factor (dB/m) + Cable Factor (dB).
3. The other emission levels were very low against the limit.
4. Margin value = Emission level – Limit value.
5. " \* ": Fundamental frequency.
6. " # ": The radiated frequency is out of the restricted band.



802.11n (20MHz)

CHANNEL	TX Channel 149	DETECTOR FUNCTION	Peak (PK)
FREQUENCY RANGE	1GHz ~ 40GHz		Average (AV)

ANTENNA POLARITY & TEST DISTANCE: HORIZONTAL AT 3 M								
NO.	FREQ. (MHz)	EMISSION LEVEL (dBuV/m)	LIMIT (dBuV/m)	MARGIN (dB)	ANTENNA HEIGHT (m)	TABLE ANGLE (Degree)	RAW VALUE (dBuV)	CORRECTION FACTOR (dB/m)
1	#5715.00	50.6 PK	68.3	-17.7	1.01 H	280	9.43	41.17
2	#5725.00	62.5 PK	78.3	-15.8	1.01 H	280	21.31	41.19
3	*5745.00	92.6 PK			1.01 H	280	51.35	41.25
4	*5745.00	75.4 AV			1.01 H	280	34.15	41.25
5	11490.00	52.4 PK	74.0	-21.6	1.00 H	355	4.73	47.67
6	11490.00	37.2 AV	54.0	-16.8	1.00 H	355	-10.47	47.67
ANTENNA POLARITY & TEST DISTANCE: VERTICAL AT 3 M								
NO.	FREQ. (MHz)	EMISSION LEVEL (dBuV/m)	LIMIT (dBuV/m)	MARGIN (dB)	ANTENNA HEIGHT (m)	TABLE ANGLE (Degree)	RAW VALUE (dBuV)	CORRECTION FACTOR (dB/m)
1	#5715.00	51.1 PK	68.3	-17.2	1.07 V	291	9.93	41.17
2	#5725.00	64.2 PK	78.3	-14.1	1.07 V	0	23.01	41.19
3	*5745.00	94.2 PK			1.07 V	291	52.95	41.25
4	*5745.00	76.7 AV			1.07 V	291	35.45	41.25
5	11490.00	53.1 PK	74.0	-20.9	1.00 V	192	5.43	47.67
6	11490.00	37.8 AV	54.0	-16.2	1.00 V	192	-9.87	47.67

REMARKS:

1. Emission level (dBuV/m) = Raw Value (dBuV) + Correction Factor (dB/m).
2. Correction Factor (dB/m) = Antenna Factor (dB/m) + Cable Factor (dB).
3. The other emission levels were very low against the limit.
4. Margin value = Emission level – Limit value.
5. " \* ": Fundamental frequency.
6. " # ": The radiated frequency is out of the restricted band.



CHANNEL	TX Channel 157	DETECTOR FUNCTION	Peak (PK)
FREQUENCY RANGE	1GHz ~ 40GHz		Average (AV)

ANTENNA POLARITY & TEST DISTANCE: HORIZONTAL AT 3 M								
NO.	FREQ. (MHz)	EMISSION LEVEL (dBuV/m)	LIMIT (dBuV/m)	MARGIN (dB)	ANTENNA HEIGHT (m)	TABLE ANGLE (Degree)	RAW VALUE (dBuV)	CORRECTION FACTOR (dB/m)
1	*5785.00	93.9 PK			1.53 H	283	52.55	41.35
2	*5785.00	76.2 AV			1.53 H	283	34.85	41.35
3	11570.00	50.9 PK	74.0	-23.1	1.00 H	340	3.15	47.75
4	11570.00	37.6 AV	54.0	-16.4	1.00 H	340	-10.15	47.75
ANTENNA POLARITY & TEST DISTANCE: VERTICAL AT 3 M								
NO.	FREQ. (MHz)	EMISSION LEVEL (dBuV/m)	LIMIT (dBuV/m)	MARGIN (dB)	ANTENNA HEIGHT (m)	TABLE ANGLE (Degree)	RAW VALUE (dBuV)	CORRECTION FACTOR (dB/m)
1	*5785.00	94.9 PK			1.17 V	300	53.55	41.35
2	*5785.00	76.7 AV			1.17 V	300	35.35	41.35
3	11570.00	53.0 PK	74.0	-21.0	1.00 V	264	5.25	47.75
4	11570.00	38.1 AV	54.0	-15.9	1.00 V	264	-9.65	47.75

REMARKS:

1. Emission level (dBuV/m) = Raw Value (dBuV) + Correction Factor (dB/m).
2. Correction Factor (dB/m) = Antenna Factor (dB/m) + Cable Factor (dB).
3. The other emission levels were very low against the limit.
4. Margin value = Emission level – Limit value.
5. " \* ": Fundamental frequency.



CHANNEL	TX Channel 161	DETECTOR FUNCTION	Peak (PK)
FREQUENCY RANGE	1GHz ~ 40GHz		Average (AV)

ANTENNA POLARITY & TEST DISTANCE: HORIZONTAL AT 3 M								
NO.	FREQ. (MHz)	EMISSION LEVEL (dBuV/m)	LIMIT (dBuV/m)	MARGIN (dB)	ANTENNA HEIGHT (m)	TABLE ANGLE (Degree)	RAW VALUE (dBuV)	CORRECTION FACTOR (dB/m)
1	*5805.00	95.2 PK			1.53 H	281	53.79	41.41
2	*5805.00	76.5 AV			1.53 H	281	35.09	41.41
3	#5850.00	48.0 PK	78.3	-30.3	1.53 H	281	6.48	41.52
4	#5860.00	46.8 PK	68.3	-21.5	1.53 H	281	5.25	41.55
5	11610.00	52.8 PK	74.0	-21.2	1.00 H	339	5.01	47.79
6	11610.00	37.7 AV	54.0	-16.3	1.00 H	339	-10.09	47.79
ANTENNA POLARITY & TEST DISTANCE: VERTICAL AT 3 M								
NO.	FREQ. (MHz)	EMISSION LEVEL (dBuV/m)	LIMIT (dBuV/m)	MARGIN (dB)	ANTENNA HEIGHT (m)	TABLE ANGLE (Degree)	RAW VALUE (dBuV)	CORRECTION FACTOR (dB/m)
1	*5805.00	95.6 PK			1.15 V	300	54.19	41.41
2	*5805.00	76.0 AV			1.15 V	300	34.59	41.41
3	#5850.00	46.8 PK	78.3	-31.5	1.15 V	300	5.28	41.52
4	#5860.00	46.6 PK	68.3	-21.7	1.15 V	300	5.05	41.55
5	11610.00	52.6 PK	74.0	-21.4	1.00 V	225	4.81	47.79
6	11610.00	37.6 AV	54.0	-16.4	1.00 V	225	-10.19	47.79

REMARKS:

1. Emission level (dBuV/m) = Raw Value (dBuV) + Correction Factor (dB/m).
2. Correction Factor (dB/m) = Antenna Factor (dB/m) + Cable Factor (dB).
3. The other emission levels were very low against the limit.
4. Margin value = Emission level – Limit value.
5. " \* ": Fundamental frequency.
6. " # ": The radiated frequency is out of the restricted band.



**802.11n (40MHz)**

<b>CHANNEL</b>	TX Channel 151	<b>DETECTOR FUNCTION</b>	Peak (PK)
<b>FREQUENCY RANGE</b>	1GHz ~ 40GHz		Average (AV)

<b>ANTENNA POLARITY &amp; TEST DISTANCE: HORIZONTAL AT 3 M</b>								
<b>NO.</b>	<b>FREQ. (MHz)</b>	<b>EMISSION LEVEL (dBuV/m)</b>	<b>LIMIT (dBuV/m)</b>	<b>MARGIN (dB)</b>	<b>ANTENNA HEIGHT (m)</b>	<b>TABLE ANGLE (Degree)</b>	<b>RAW VALUE (dBuV)</b>	<b>CORRECTION FACTOR (dB/m)</b>
1	#5715.00	49.5 PK	68.3	-18.8	1.54 H	278	8.33	41.17
2	#5725.00	57.1 PK	78.3	-21.2	1.54 H	278	15.91	41.19
3	*5755.00	94.1 PK			1.54 H	278	52.83	41.27
4	*5755.00	82.0 AV			1.54 H	278	40.73	41.27
5	11510.00	52.6 PK	74.0	-21.4	1.00 H	186	4.91	47.69
6	11510.00	37.5 AV	54.0	-16.5	1.00 H	186	-10.19	47.69
<b>ANTENNA POLARITY &amp; TEST DISTANCE: VERTICAL AT 3 M</b>								
<b>NO.</b>	<b>FREQ. (MHz)</b>	<b>EMISSION LEVEL (dBuV/m)</b>	<b>LIMIT (dBuV/m)</b>	<b>MARGIN (dB)</b>	<b>ANTENNA HEIGHT (m)</b>	<b>TABLE ANGLE (Degree)</b>	<b>RAW VALUE (dBuV)</b>	<b>CORRECTION FACTOR (dB/m)</b>
1	#5715.00	49.6 PK	68.3	-18.7	1.07 V	308	8.43	41.17
2	#5725.00	56.1 PK	78.3	-22.2	1.07 V	308	14.91	41.19
3	*5755.00	95.2 PK			1.07 V	308	53.93	41.27
4	*5755.00	82.6 AV			1.07 V	308	41.33	41.27
5	11510.00	51.9 PK	74.0	-22.1	1.00 V	94	4.21	47.69
6	11510.00	36.2 AV	54.0	-17.8	1.00 V	94	-11.49	47.69

**REMARKS:**

1. Emission level (dBuV/m) = Raw Value (dBuV) + Correction Factor (dB/m).
2. Correction Factor (dB/m) = Antenna Factor (dB/m) + Cable Factor (dB).
3. The other emission levels were very low against the limit.
4. Margin value = Emission level – Limit value.
5. " \* ": Fundamental frequency.
6. " # ": The radiated frequency is out of the restricted band.



CHANNEL	TX Channel 159	DETECTOR FUNCTION	Peak (PK)
FREQUENCY RANGE	1GHz ~ 40GHz		Average (AV)

ANTENNA POLARITY & TEST DISTANCE: HORIZONTAL AT 3 M								
NO.	FREQ. (MHz)	EMISSION LEVEL (dBuV/m)	LIMIT (dBuV/m)	MARGIN (dB)	ANTENNA HEIGHT (m)	TABLE ANGLE (Degree)	RAW VALUE (dBuV)	CORRECTION FACTOR (dB/m)
1	*5795.00	93.4 PK			1.01 H	277	52.02	41.38
2	*5795.00	81.8 AV			1.01 H	277	40.42	41.38
3	#5850.00	46.5 PK	78.3	-31.8	1.01 H	277	4.98	41.52
4	#5860.00	45.5 PK	68.3	-22.8	1.01 H	277	3.95	41.55
5	11590.00	52.2 PK	74.0	-21.8	1.00 H	201	4.43	47.77
6	11590.00	36.9 AV	54.0	-17.1	1.00 H	201	-10.87	47.77
ANTENNA POLARITY & TEST DISTANCE: VERTICAL AT 3 M								
NO.	FREQ. (MHz)	EMISSION LEVEL (dBuV/m)	LIMIT (dBuV/m)	MARGIN (dB)	ANTENNA HEIGHT (m)	TABLE ANGLE (Degree)	RAW VALUE (dBuV)	CORRECTION FACTOR (dB/m)
1	*5795.00	96.8 PK			1.15 V	297	55.42	41.38
2	*5795.00	84.7 AV			1.15 V	297	43.32	41.38
3	#5850.00	50.5 PK	78.3	-27.8	1.15 V	297	8.98	41.52
4	#5860.00	46.3 PK	68.3	-22.0	1.15 V	197	4.75	41.55
5	11590.00	52.4 PK	74.0	-21.6	1.00 V	114	4.63	47.77
6	11590.00	36.7 AV	54.0	-17.3	1.00 V	114	-11.07	47.77

REMARKS:

1. Emission level (dBuV/m) = Raw Value (dBuV) + Correction Factor (dB/m).
2. Correction Factor (dB/m) = Antenna Factor (dB/m) + Cable Factor (dB).
3. The other emission levels were very low against the limit.
4. Margin value = Emission level – Limit value.
5. " \* ": Fundamental frequency.
6. " # ": The radiated frequency is out of the restricted band.





## 4.2 CONDUCTED EMISSION MEASUREMENT

### 4.2.1 LIMITS OF CONDUCTED EMISSION MEASUREMENT

FREQUENCY OF EMISSION (MHz)	CONDUCTED LIMIT (dBµV)	
	Quasi-peak	Average
0.15 ~ 0.5	66 to 56	56 to 46
0.5 ~ 5	56	46
5 ~ 30	60	50

- NOTE:**
1. The lower limit shall apply at the transition frequencies.
  2. The limit decreases in line with the logarithm of the frequency in the range of 0.15 to 0.50MHz.
  3. All emanations from a class A/B digital device or system, including any network of conductors and apparatus connected thereto, shall not exceed the level of field strengths specified above.

### 4.2.2 TEST INSTRUMENTS

Equipment	Manufacturer	Model No.	Serial No.	Last Cal.	Next Cal.
EMI Test Receiver	Rohde&Schwarz	ESCI	101418	Mar. 28,14	Mar. 27,15
Artificial Mains Network	Rohde&Schwarz	ENV216	101173	May 14,14	May 13,15
Artificial Mains Network	Rohde&Schwarz	ESH3-Z5	100317	May 14,14	May 13,15
Test software	ADT	ADT_Cond_V7.3.7	N/A	N/A	N/A

- NOTE:**
1. The test was performed in shielded room 553.
  2. The calibration interval of the above test instruments is 12 months. And the calibrations are traceable to CEPREI/CHINA, GRGT/CHINA and NIM/CHINA.

### 4.2.3 TEST PROCEDURES

- a. The EUT was placed 0.4 meters from the conducting wall of the shielded room with EUT being connected to the power mains through a line impedance stabilization network (LISN). Other support units were connected to the power mains through another LISN. The two LISNs provide 50 ohm/ 50uH of coupling impedance for the measuring instrument.
- b. Both lines of the power mains connected to the EUT were checked for maximum conducted interference.
- c. The frequency range from 150kHz to 30MHz was searched. Emission levels under (Limit - 20dB) was not recorded.

**NOTE:** All modes of operation were investigated and the worst-case emissions are reported.



#### 4.2.4 DEVIATION FROM TEST STANDARD

No deviation.

#### 4.2.5 TEST SETUP

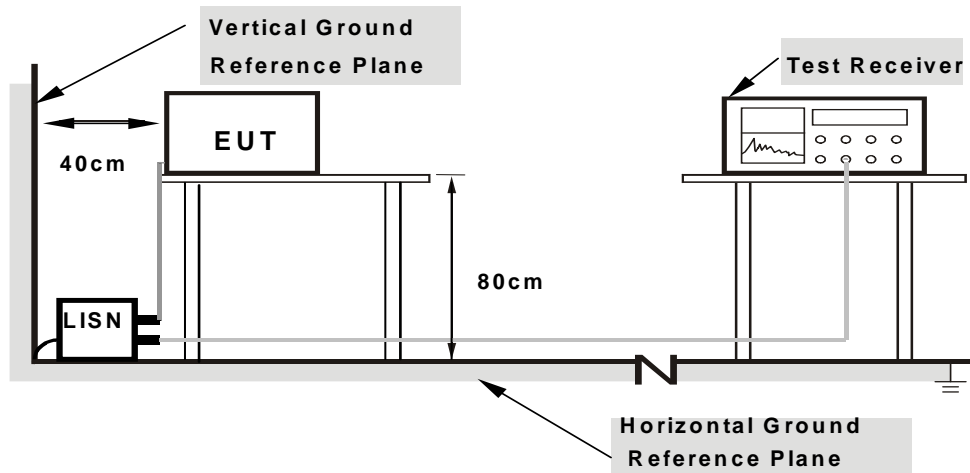

- Note:**
- 1.Support units were connected to second LISN.
  - 2.Both of LISNs (AMN) are 80 cm from EUT and at least 80 from other units and other metal planes

For the actual test configuration, please refer to the attached file (Test Setup Photo).

#### 4.2.6 EUT OPERATING CONDITIONS

Same as 4.1.6.



**4.2.7 TEST RESULTS**

**CONDUCTED WORST-CASE DATA : 802.11a**

<b>PHASE</b>	Line	<b>6dB BANDWIDTH</b>	9kHz
<b>CHANNEL</b>	Channel 36		

No	Freq. [MHz]	Corr. Factor (dB)	Reading Value [dB (uV)]		Emission Level [dB (uV)]		Limit [dB (uV)]		Margin (dB)	
			Q.P.	AV.	Q.P.	AV.	Q.P.	AV.	Q.P.	AV.
1	0.15391	10.83	37.25	21.91	48.08	32.74	65.79	55.79	-17.71	-23.05
2	0.58359	10.47	30.6	18.64	41.07	29.11	56	46	-14.93	-16.89
<b>3</b>	<b>0.65781</b>	<b>10.43</b>	<b>31.93</b>	<b>18.82</b>	<b>42.36</b>	<b>29.25</b>	<b>56</b>	<b>46</b>	<b>-13.64</b>	<b>-16.75</b>
4	0.73203	10.39	31.16	17.76	41.55	28.15	56	46	-14.45	-17.85
5	1.23828	10.16	30.17	13.87	40.33	24.03	56	46	-15.67	-21.97
6	1.87109	10.04	27.09	14.18	37.13	24.22	56	46	-18.87	-21.78

- REMARKS:**
1. Q.P. and AV. are abbreviations of quasi-peak and average individually.
  2. "-": The Quasi-peak reading value also meets average limit and measurement with the average detector is unnecessary.
  3. The emission levels of other frequencies were very low against the limit.
  4. Margin value = Emission level - Limit value
  5. Correction factor = Insertion loss + Cable loss
  6. Emission Level = Correction Factor + Reading Value.

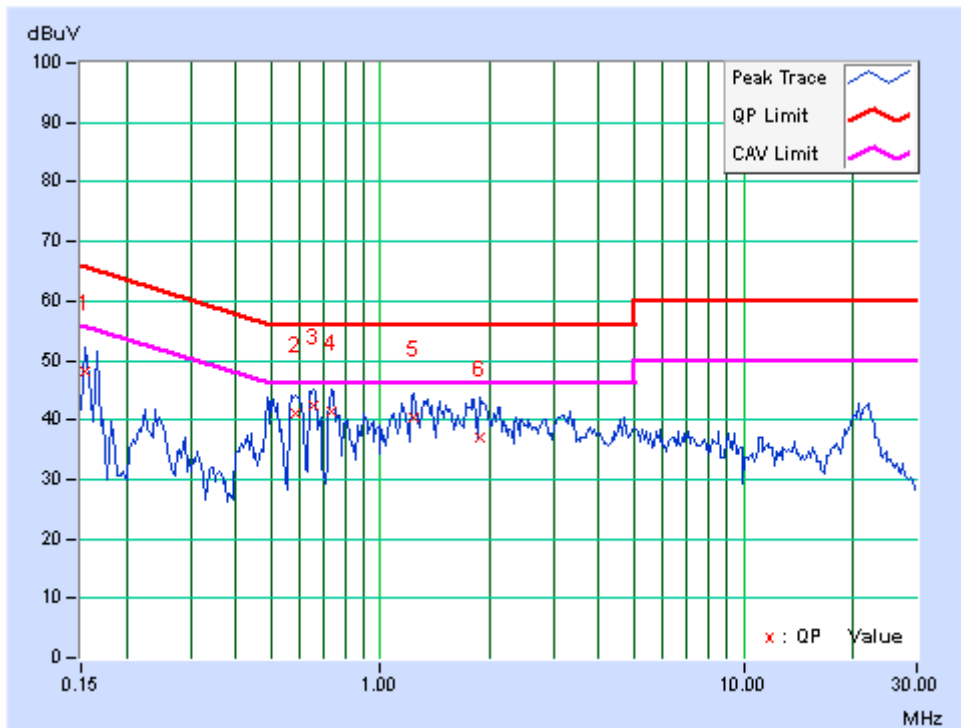



<b>PHASE</b>	Neutral	<b>6dB BANDWIDTH</b>	9kHz
<b>CHANNEL</b>	Channel 36		

No	Freq. [MHz]	Corr. Factor (dB)	Reading Value [dB (uV)]		Emission Level [dB (uV)]		Limit [dB (uV)]		Margin (dB)	
			Q.P.	AV.	Q.P.	AV.	Q.P.	AV.	Q.P.	AV.
1	0.15000	10.64	36.72	17.12	47.36	27.76	66	56	-18.64	-28.24
2	0.21641	10.55	25.26	8.19	35.81	18.74	62.96	52.96	-27.15	-34.22
3	0.51719	10.49	28.95	16.76	39.44	27.25	56	46	-16.56	-18.75
4	0.61094	10.4	27.23	7.98	37.63	18.38	56	46	-18.37	-27.62
5	1.34375	10.01	22.7	8.59	32.71	18.6	56	46	-23.29	-27.4
6	3.27734	9.81	17.73	7.54	27.54	17.35	56	46	-28.46	-28.65

- REMARKS:**
1. Q.P. and AV. are abbreviations of quasi-peak and average individually.
  2. "-": The Quasi-peak reading value also meets average limit and measurement with the average detector is unnecessary.
  3. The emission levels of other frequencies were very low against the limit.
  4. Margin value = Emission level - Limit value
  5. Correction factor = Insertion loss + Cable loss
  6. Emission Level = Correction Factor + Reading Value.

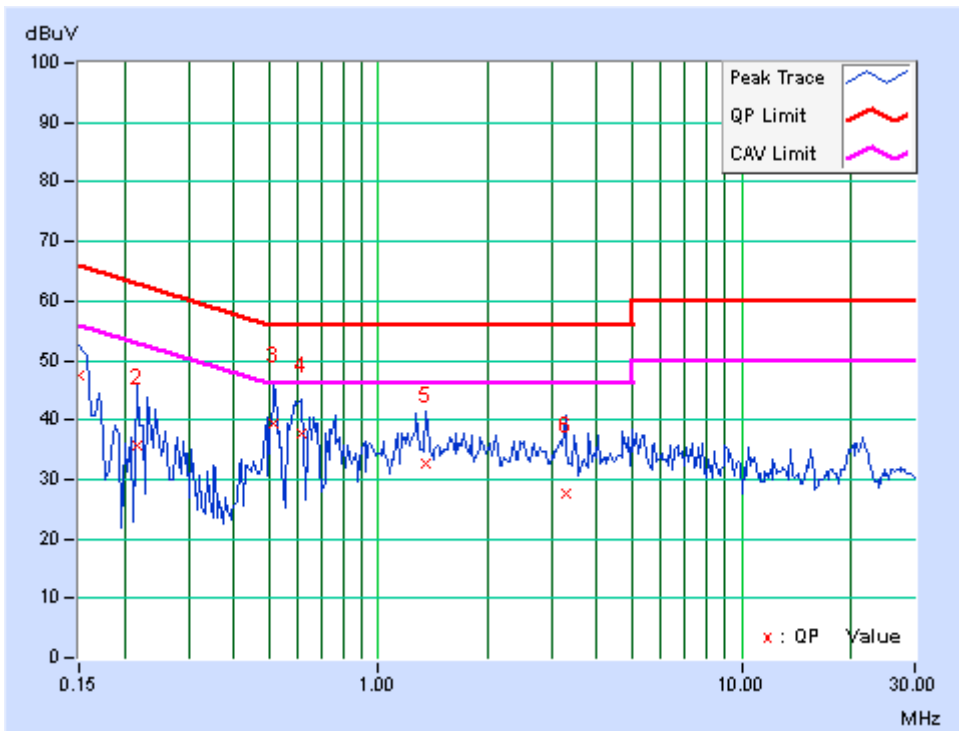



### 4.3 MAXIMUM CONDUCTED OUTPUT POWER MEASUREMENT

#### 4.3.1 LIMITS OF MAXIMUM CONDUCTED OUTPUT POWER MEASUREMENT

Operation Band	EUT Category		LIMIT
U-NII-1		Outdoor Access Point	1 Watt (30 dBm) (Max. e.i.r.p $\leq$ 125mW(21 dBm) at any elevation angle above 30 degrees as measured from the horizon)
		Fixed point-to-point Access Point	1 Watt (30 dBm)
		Indoor Access Point	1 Watt (30 dBm)
	√	Mobile and Portable client device	250mW (24 dBm)
U-NII-2A	√		250mW (24 dBm) or 11 dBm+10 log B*
U-NII-2C	√		250mW (24 dBm) or 11 dBm+10 log B*
U-NII-3	√		1 Watt (30 dBm)

NOTE: Where B is the 26dB emission bandwidth in MHz.

#### 4.3.2 TEST SETUP

##### FOR POWER OUTPUT MEASUREMENT

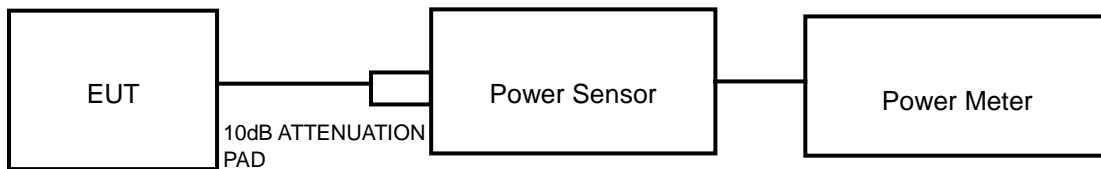

##### FOR 26dB BANDWIDTH

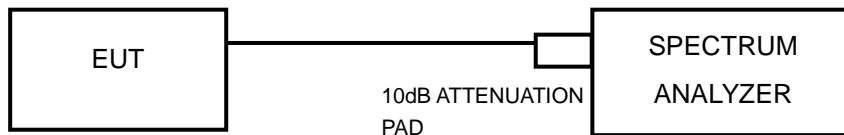



### 4.3.3 TEST INSTRUMENTS

Refer to section 4.1.3 to get information of above instrument.

### 4.3.4 TEST PROCEDURE

#### **FOR POWER MEASUREMENT**

Method PM is used to perform output power measurement, trigger and gating function of wide band power meter is enabled to measure max output power of TX on burst. Duty factor is not added to measured value.

#### **FOR 99 PERCENT OCCUPIED BANDWIDTH**

The following procedure shall be used for measuring (99 %) power bandwidth:

1. Set center frequency to the nominal EUT channel center frequency.
2. Set span = 1.5 times to 5.0 times the OBW.
3. Set RBW = 1 % to 5 % of the OBW
4. Set VBW  $\geq 3 \cdot$  RBW
5. Video averaging is not permitted. Where practical, a sample detection and single sweep mode shall be used. Otherwise, peak detection and max hold mode (until the trace stabilizes) shall be used.
6. Use the 99 % power bandwidth function of the instrument (if available).
7. If the instrument does not have a 99 % power bandwidth function, the trace data points are recovered and directly summed in power units. The recovered amplitude data points, beginning at the lowest frequency, are placed in a running sum until 0.5 % of the total is reached; that frequency is recorded as the lower frequency. The process is repeated until 99.5 % of the total is reached; that frequency is recorded as the upper frequency. The 99% occupied bandwidth is the difference between these two frequencies.



#### FOR 26dB BANDWIDTH

- 1) Set RBW = approximately 1% of the emission bandwidth.
- 2) Set the VBW > RBW.
- 3) Detector = Peak.
- 4) Trace mode = max hold.
- 5) Measure the maximum width of the emission that is 26 dB down from the peak of the emission. Compare this with the RBW setting of the analyzer. Readjust RBW and repeat measurement as needed until the RBW/EBW ratio is approximately 1%.

#### FOR 6dB BANDWIDTH

1. Set RBW = 100 kHz.
2. Set the video bandwidth (VBW)  $\geq 3$  RBW.
3. Detector = Peak.
4. Trace mode = max hold.
5. Sweep = auto couple.
6. Allow the trace to stabilize.
7. Measure the maximum width of the emission that is constrained by the frequencies associated with the two outermost amplitude points (upper and lower frequencies) that are attenuated by 6 dB relative to the maximum level measured in the fundamental emission.

#### 4.3.5 DEVIATION FROM TEST STANDARD

No deviation.

#### 4.3.6 EUT OPERATING CONDITIONS

The software provided by client to enable the EUT under transmission condition continuously at specific channel frequencies individually.



#### 4.3.7 TEST RESULTS

##### OUTPUT POWER:

##### 802.11a

CHANNEL	CHANNEL FREQUENCY (MHz)	AVERAGE POWER (mW)	AVERAGE POWER (dBm)	POWER LIMIT (dBm)	PASS/FAIL
36	5180	31.117	14.93	24	PASS
40	5200	31.477	14.98	24	PASS
48	5240	33.037	15.19	24	PASS
52	5260	30.832	14.89	24	PASS
60	5300	30.061	14.78	24	PASS
64	5320	33.884	15.30	24	PASS
100	5500	32.211	15.08	24	PASS
116	5580	30.200	14.80	24	PASS
140	5700	31.117	14.93	24	PASS
149	5745	33.884	15.30	30	PASS
157	5785	34.198	15.34	30	PASS
161	5805	33.343	15.23	30	PASS





**802.11n (20MHz)**

CHANNEL	CHANNEL FREQUENCY (MHz)	AVERAGE POWER (mW)	AVERAGE POWER (dBm)	POWER LIMIT (dBm)	PASS/FAIL
36	5180	31.915	15.04	24	PASS
40	5200	31.046	14.92	24	PASS
48	5240	34.674	15.40	24	PASS
52	5260	30.061	14.78	24	PASS
60	5300	30.200	14.80	24	PASS
64	5320	34.198	15.34	24	PASS
100	5500	32.509	15.12	24	PASS
116	5580	30.339	14.82	24	PASS
140	5700	31.189	14.94	24	PASS
149	5745	33.729	15.28	30	PASS
157	5785	34.119	15.33	30	PASS
161	5805	33.729	15.28	30	PASS

**802.11n (40MHz)**

CHANNEL	CHANNEL FREQUENCY (MHz)	AVERAGE POWER (mW)	AVERAGE POWER (dBm)	POWER LIMIT (dBm)	PASS/FAIL
38	5190	35.156	15.46	24	PASS
46	5230	32.211	15.08	24	PASS
54	5270	32.810	15.16	24	PASS
62	5310	34.041	15.32	24	PASS
102	5510	34.435	15.37	24	PASS
110	5550	35.156	15.46	24	PASS
134	5670	32.509	15.12	24	PASS
151	5755	35.810	15.54	30	PASS
159	5795	34.914	15.43	30	PASS



**99% OCCUPIED BANDWIDTH & 26dB BANDWIDTH/6dB BANDWIDTH:**

**802.11a**

CHANNEL	CHANNEL FREQUENCY (MHz)	99% OCCUPIED BANDWIDTH	26dB BANDWIDTH (MHz)	PASS/FAIL
36	5180	16.87	23.53	PASS
40	5200	16.61	21.79	PASS
48	5240	16.78	23.25	PASS
52	5260	16.68	20.28	PASS
60	5300	16.68	21.45	PASS
64	5320	16.80	23.07	PASS
100	5500	16.80	22.05	PASS
116	5580	16.56	22.53	PASS
140	5700	16.80	21.71	PASS
CHANNEL	CHANNEL FREQUENCY (MHz)	99% OCCUPIED BANDWIDTH	6dB BANDWIDTH (MHz)	PASS/FAIL
149	5745	17.43	16.37	PASS
157	5785	17.52	16.37	PASS
161	5805	18.36	17.63	PASS



802.11n (20MHz)

CHANNEL	CHANNEL FREQUENCY (MHz)	99% OCCUPIED BANDWIDTH	26dB BANDWIDTH (MHz)	PASS/FAIL
36	5180	18.00	23.44	PASS
40	5200	17.88	23.16	PASS
48	5240	17.88	25.96	PASS
52	5260	17.88	21.16	PASS
60	5300	17.76	22.76	PASS
64	5320	17.88	23.15	PASS
100	5500	17.76	21.75	PASS
116	5580	17.76	21.67	PASS
140	5700	18.00	30.15	PASS
CHANNEL	CHANNEL FREQUENCY (MHz)	99% OCCUPIED BANDWIDTH	6dB BANDWIDTH (MHz)	PASS/FAIL
149	5745	17.34	16.38	PASS
157	5785	18.24	17.61	PASS
161	5805	18.14	17.55	PASS



802.11n (40MHz)

CHANNEL	CHANNEL FREQUENCY (MHz)	99% OCCUPIED BANDWIDTH	26dB BANDWIDTH (MHz)	PASS/FAIL
38	5190	37.60	69.83	PASS
46	5230	37.00	65.80	PASS
54	5270	37.00	63.90	PASS
62	5310	36.80	68.13	PASS
102	5510	37.20	72.87	PASS
110	5550	37.40	79.85	PASS
134	5670	37.20	69.54	PASS
CHANNEL	CHANNEL FREQUENCY (MHz)	99% OCCUPIED BANDWIDTH	6dB BANDWIDTH (MHz)	PASS/FAIL
151	5755	41.80	35.34	PASS
159	5795	38.80	35.25	PASS



BUREAU VERITAS

Test Report No.: RF141111N015-7

For U-NII-1, U-NII-2A & U-NII-2C:

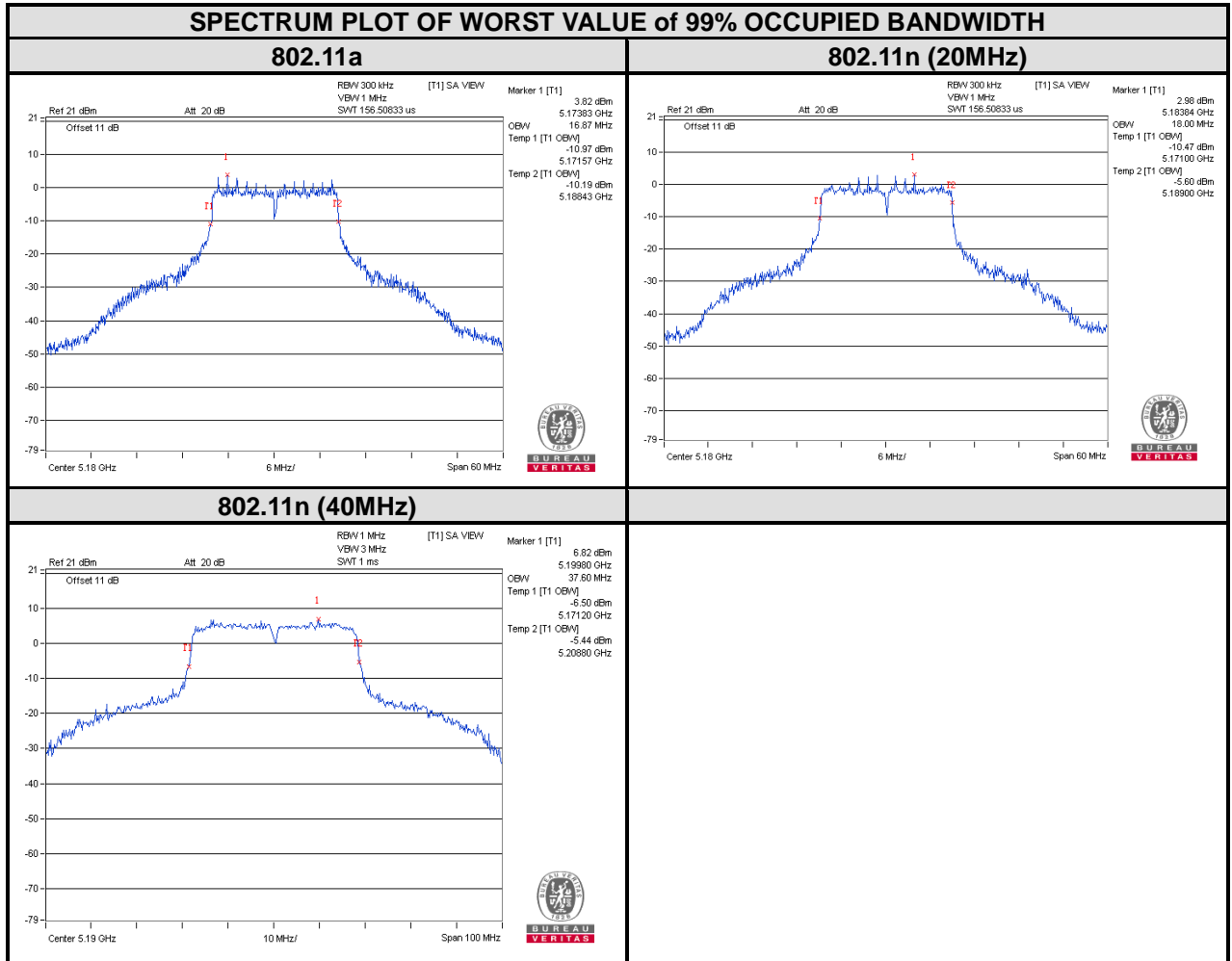



BUREAU VERITAS

Test Report No.: RF141111N015-7

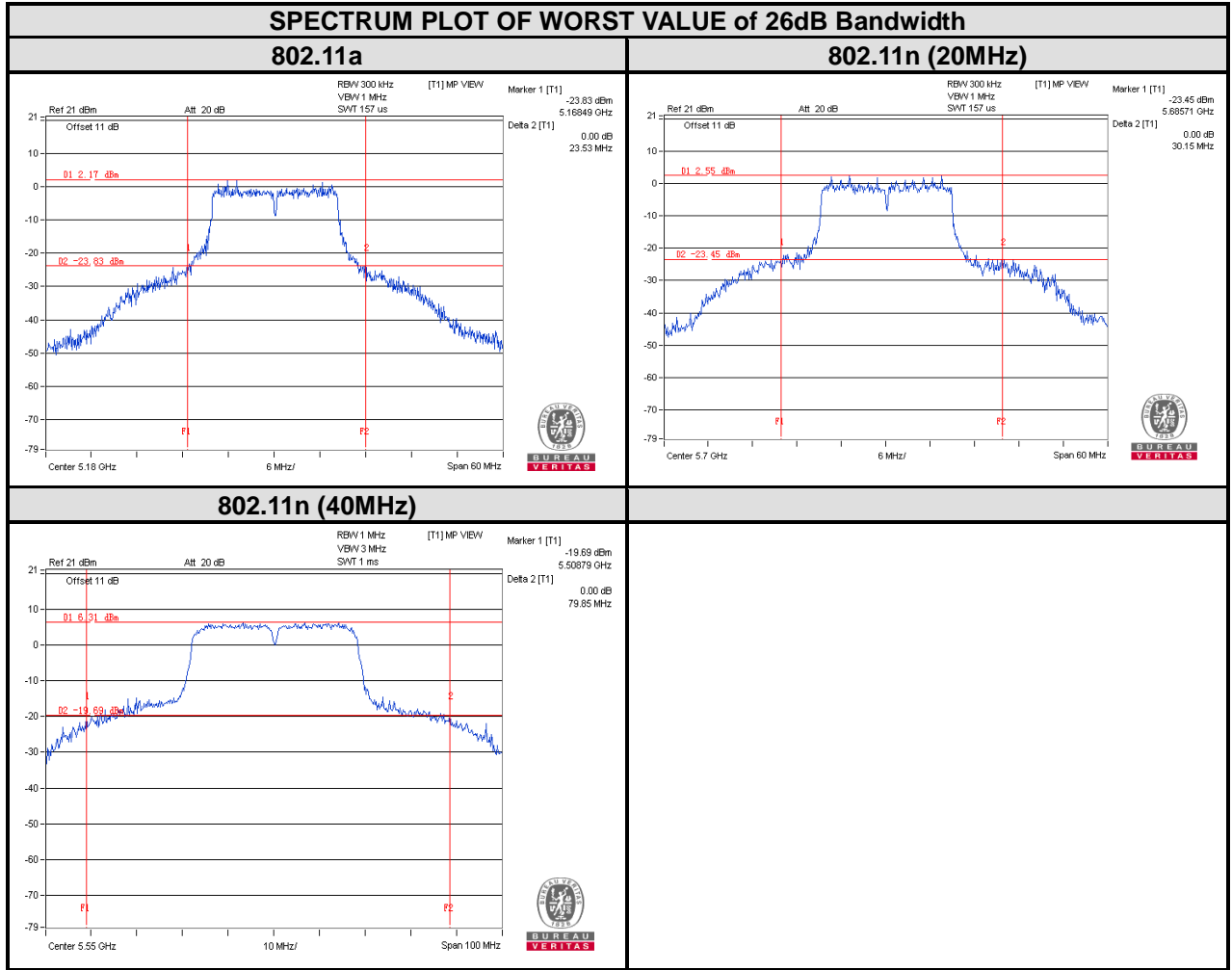



BUREAU VERITAS

Test Report No.: RF141111N015-7

For U-NII-3:

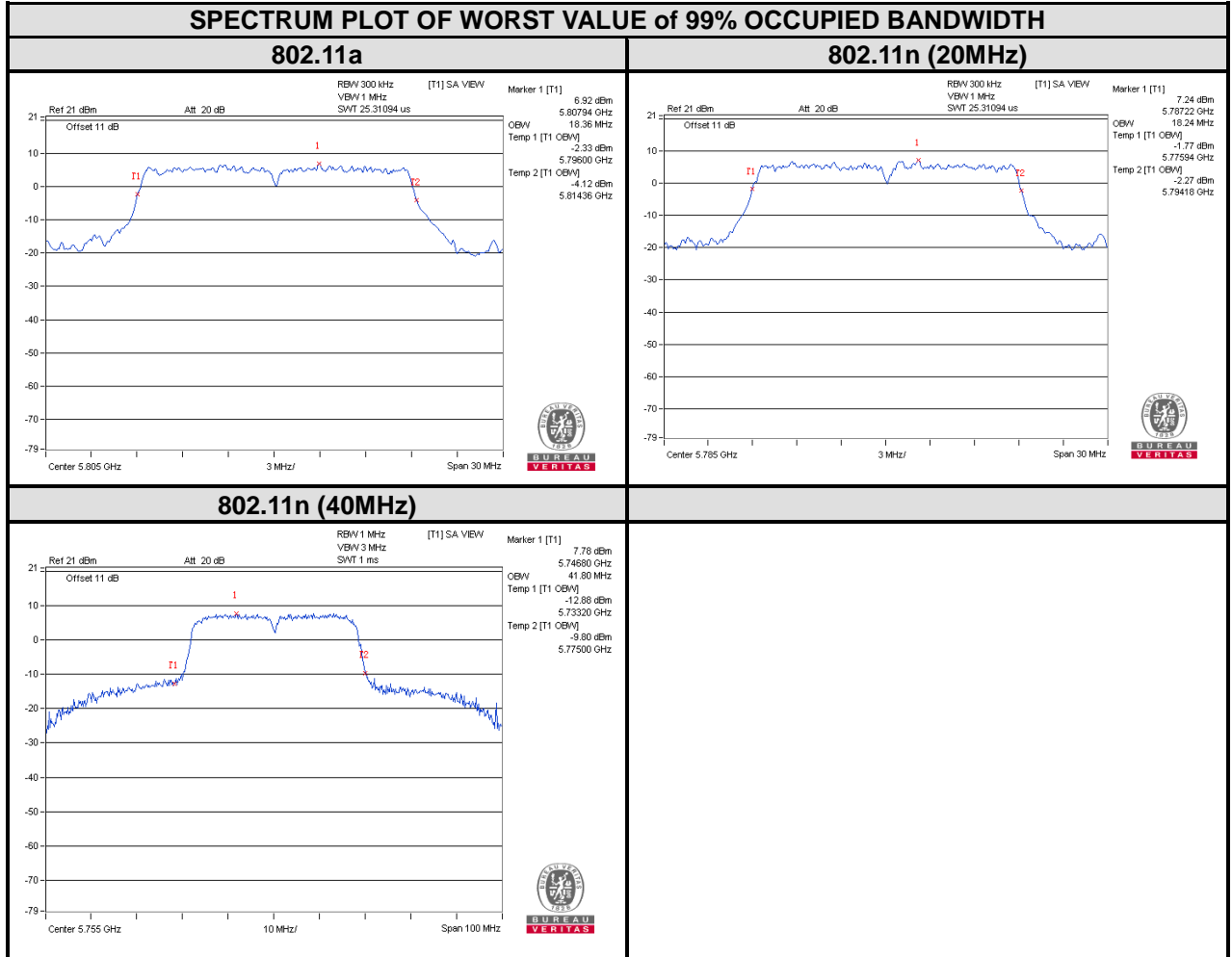



**BUREAU  
VERITAS**

Test Report No.: RF141111N015-7

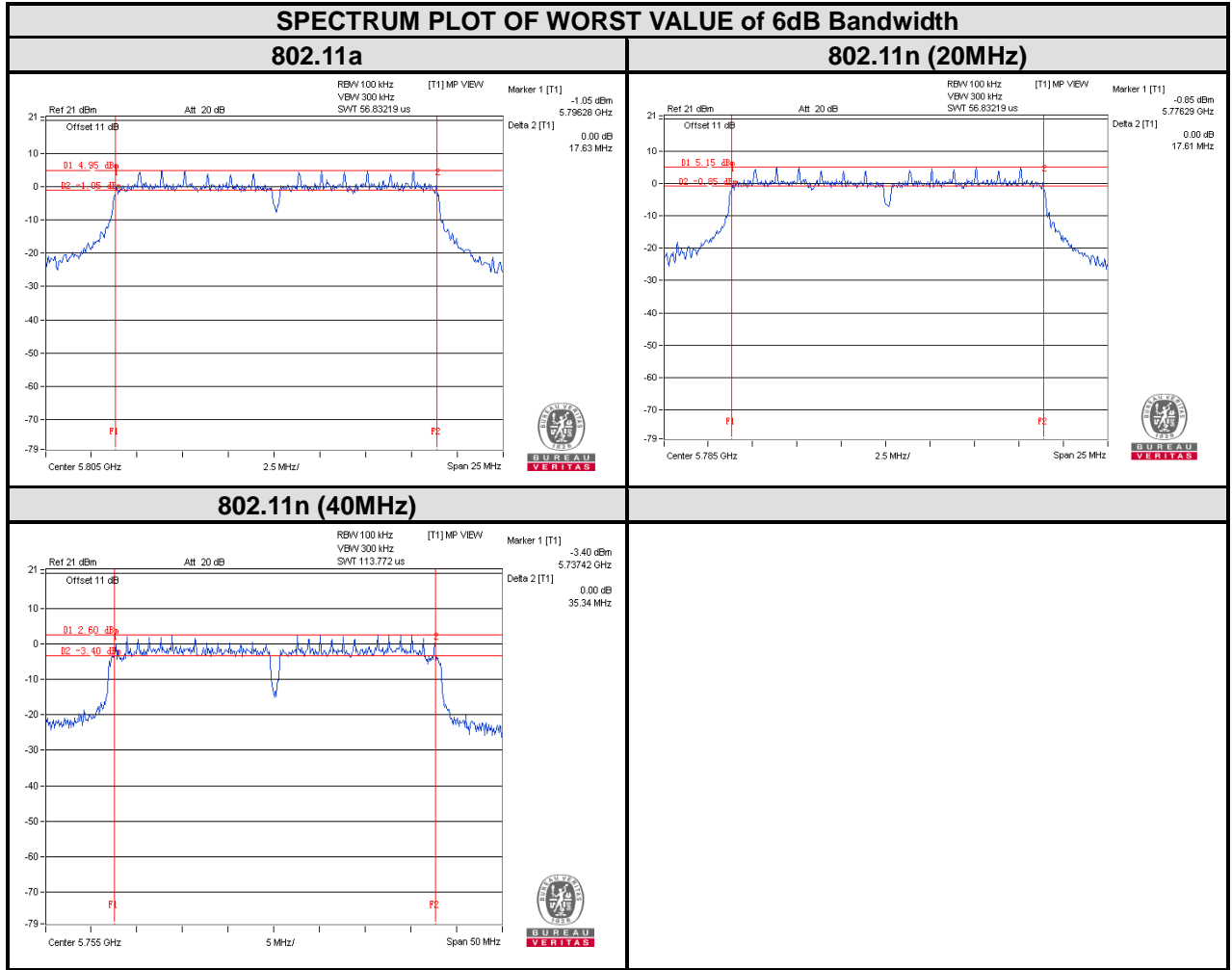





### 4.4 PEAK POWER SPECTRAL DENSITY MEASUREMENT

#### 4.4.1 LIMITS OF PEAK POWER SPECTRAL DENSITY MEASUREMENT

Operation Band	EUT Category		LIMIT
U-NII-1		Outdoor Access Point	17dBm/ MHz
		Fixed point-to-point Access Point	
		Indoor Access Point	
	√	Mobile and Portable client device	11dBm/ MHz
U-NII-2A	√		11dBm/ MHz
U-NII-2C	√		11dBm/ MHz
U-NII-3	√		30dBm/ 500kHz

#### 4.4.2 TEST SETUP

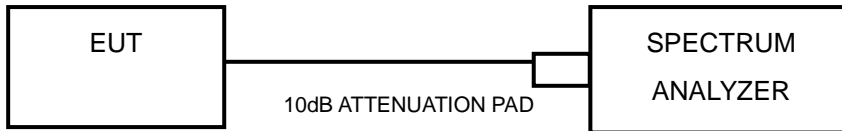

#### 4.4.3 TEST INSTRUMENTS

Refer to section 4.1.3 to get information of above instrument.

#### 4.4.4 TEST PROCEDURES

Using method SA-1

- 1) Set span to encompass the entire emission bandwidth (EBW) of the signal.
- 2) Set RBW = 30 KHz, Set VBW ≥ 1 MHz, Detector = RMS
- 3) Set Channel power measure = 1MHz
- 4) Sweep time = auto, trigger set to “free run”.
- 5) Trace average at least 100 traces in power averaging mode.
- 6) Record the max value



#### 4.4.5 DEVIATION FROM TEST STANDARD

No deviation.

#### 4.4.6 EUT OPERATING CONDITIONS

Same as 4.1.6.

#### 4.4.7 TEST RESULTS

**For U-NII-1, U-NII-2A & U-NII-2C:**

##### 802.11a

CHANNEL	FREQUENCY (MHz)	PSD w/o Duty Factor (dBm/MHz)	Duty Factor	PSD with Duty Factor (dBm/MHz)	MAXIMUM LIMIT (dBm/MHz)	PASS/FAIL
36	5180	9.65	0.64	10.29	11	PASS
40	5200	9.44	0.64	10.08	11	PASS
48	5240	10.06	0.64	10.76	11	PASS
52	5260	8.35	0.64	8.99	11	PASS
60	5300	8.98	0.64	9.62	11	PASS
64	5320	9.11	0.64	9.75	11	PASS
100	5500	8.75	0.64	9.39	11	PASS
116	5580	8.61	0.64	9.25	11	PASS
140	5700	9.13	0.64	9.77	11	PASS



**802.11n (20MHz)**

CHANNEL	FREQUENCY (MHz)	PSD w/o Duty Factor (dBm/MHz)	Duty Factor	PSD with Duty Factor (dBm/MHz)	MAXIMUM LIMIT (dBm/MHz)	PASS/FAIL
36	5180	8.92	0.69	9.61	11	PASS
40	5200	8.46	0.69	9.15	11	PASS
48	5240	8.93	0.69	9.62	11	PASS
52	5260	8.29	0.69	8.98	11	PASS
60	5300	8.25	0.69	8.94	11	PASS
64	5320	9.94	0.69	10.63	11	PASS
100	5500	8.79	0.69	9.48	11	PASS
116	5580	8.69	0.69	9.38	11	PASS
140	5700	9.49	0.69	9.18	11	PASS

**802.11n (40MHz)**

CHANNEL	FREQUENCY (MHz)	PSD w/o Duty Factor (dBm/MHz)	Duty Factor	PSD with Duty Factor (dBm/MHz)	MAXIMUM LIMIT (dBm/MHz)	PASS/FAIL
38	5190	7.22	1.21	8.43	11	PASS
46	5230	6.04	1.21	7.25	11	PASS
54	5270	5.92	1.21	7.13	11	PASS
62	5310	6.26	1.21	7.47	11	PASS
102	5510	6.81	1.21	8.02	11	PASS
110	5550	6.84	1.21	8.05	11	PASS
134	5670	7.05	1.21	8.26	11	PASS



For U-NII-3:

802.11a

CHANNEL	FREQUENCY (MHz)	PSD w/o Duty Factor (dBm/500kHz)	Duty Factor	PSD with Duty Factor (dBm/500kHz)	LIMIT (dBm/500kHz)	PASS /FAIL
149	5745	8.78	0.64	9.42	30	PASS
157	5785	7.53	0.64	8.17	30	PASS
161	5805	6.58	0.64	7.22	30	PASS

802.11n (20MHz)

CHANNEL	FREQUENCY (MHz)	PSD w/o Duty Factor (dBm/500kHz)	Duty Factor	PSD with Duty Factor (dBm/500kHz)	LIMIT (dBm/500kHz)	PASS /FAIL
149	5745	7.12	0.69	7.81	30	PASS
157	5785	6.88	0.69	7.57	30	PASS
161	5805	5.55	0.69	6.24	30	PASS

802.11n (40MHz)

CHANNEL	FREQUENCY (MHz)	PSD w/o Duty Factor (dBm/500kHz)	Duty Factor	PSD with Duty Factor (dBm/500kHz)	LIMIT (dBm/500kHz)	PASS /FAIL
151	5755	5.22	1.21	6.43	30	PASS
159	5795	5.14	1.21	6.35	30	PASS



**BUREAU  
VERITAS**

Test Report No.: RF141111N015-7

For 5180~5240MHz

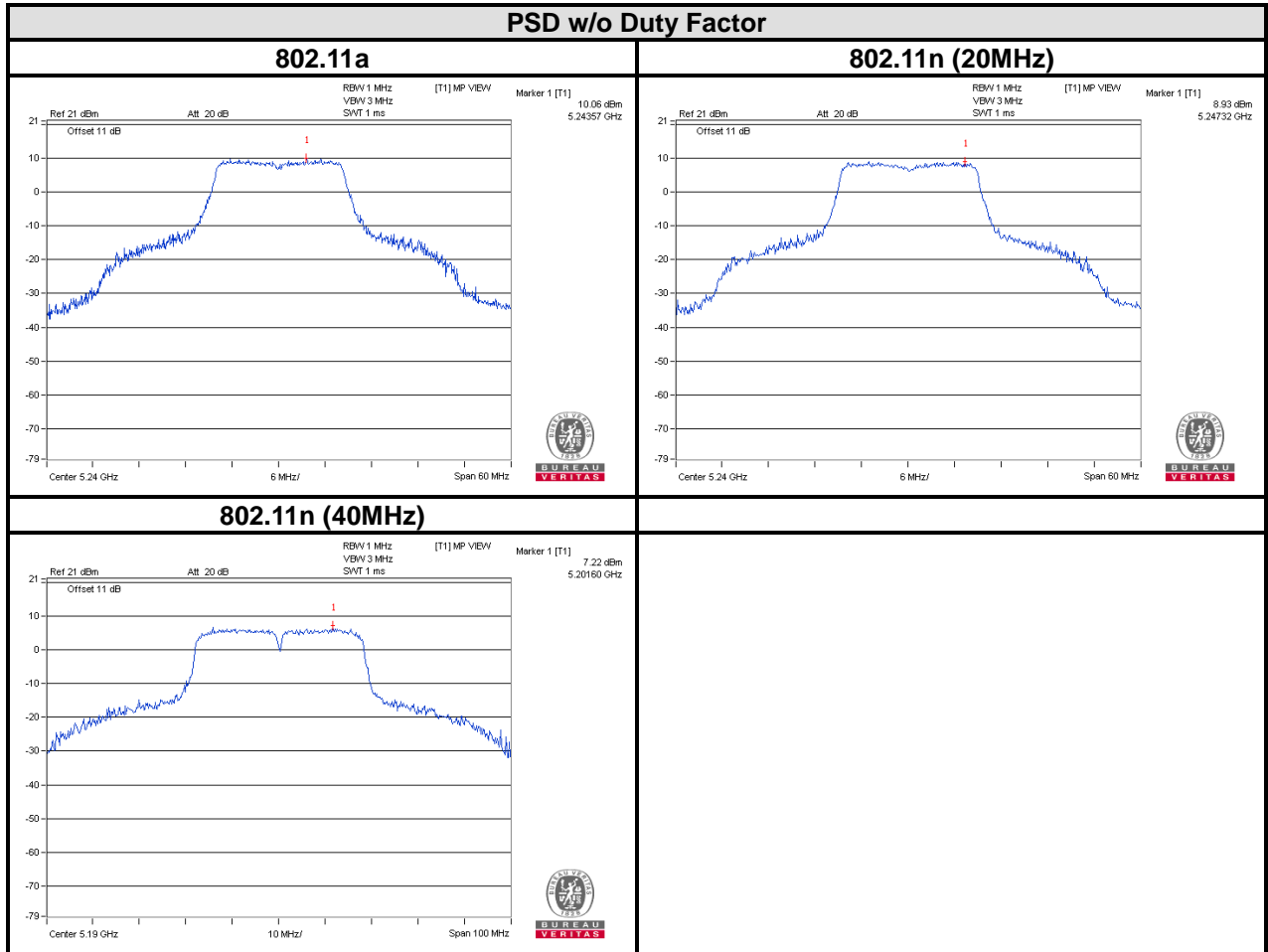



For 5260~5320MHz

PSD w/o Duty Factor

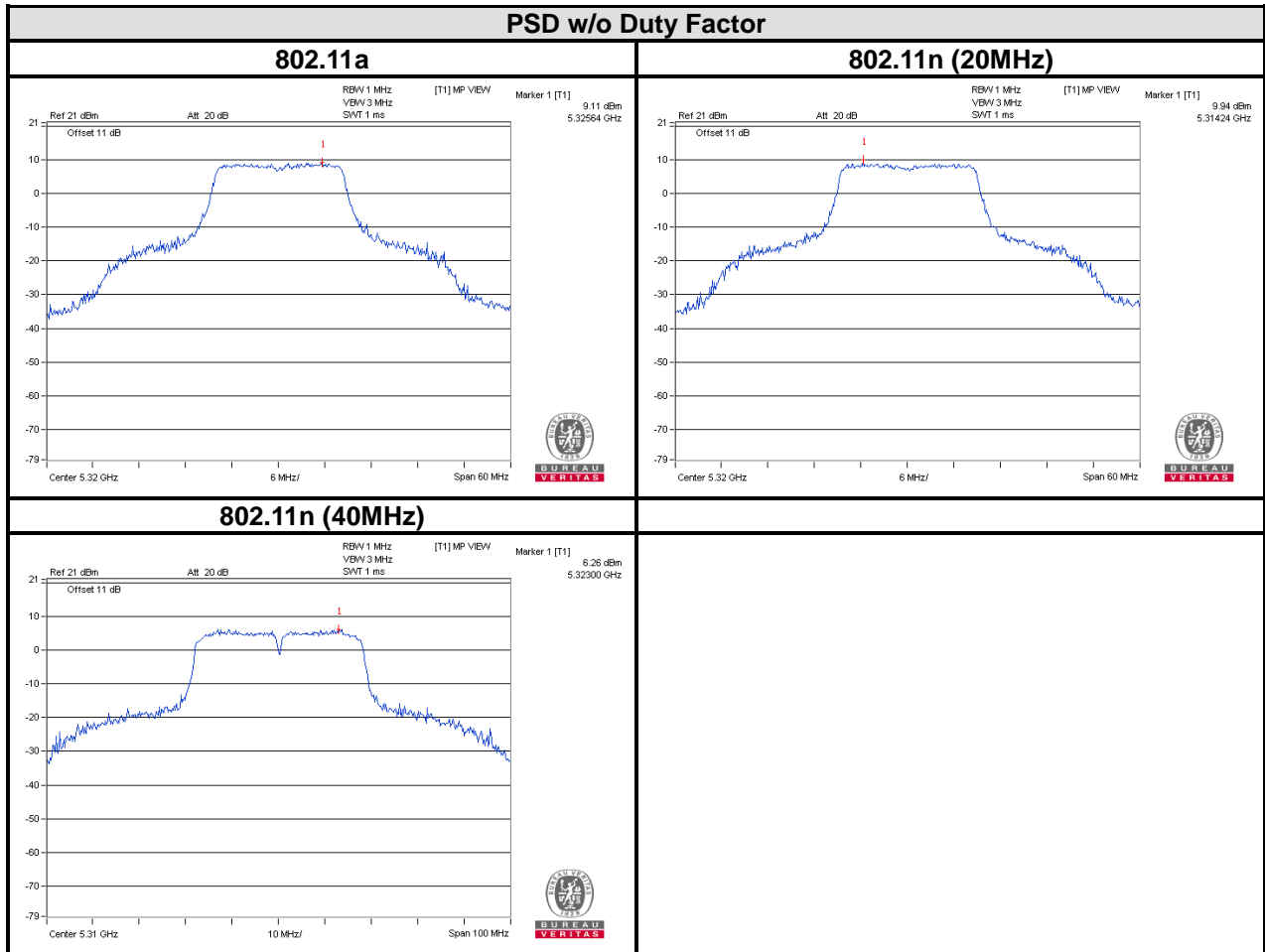



**BUREAU  
VERITAS**

Test Report No.: RF141111N015-7

For 5500~5700MHz

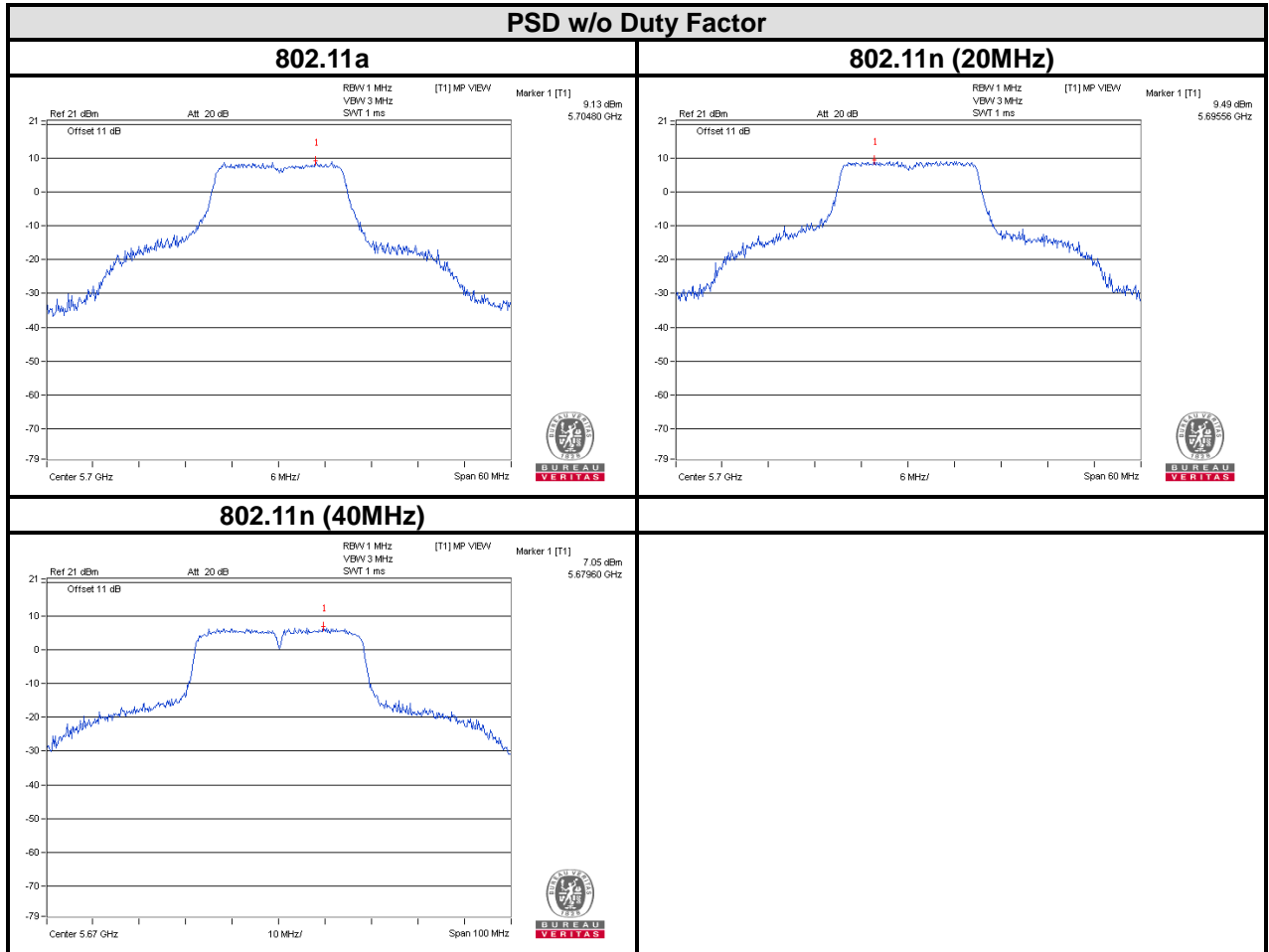



For 5745~5805MHz

PSD w/o Duty Factor	
<p><b>802.11a</b></p>	<p><b>802.11n (20MHz)</b></p>
<p><b>Note: The peak power spectral density is a “calculated” value derived from the conducted value: 11.79dBm/MHz=8.78dBm/500kHz</b></p>	<p><b>Note: The peak power spectral density is a “calculated” value derived from the conducted value: 10.13dBm/MHz=7.12dBm/500kHz</b></p>
<p><b>802.11n (40MHz)</b></p>	
<p><b>Note: The peak power spectral density is a “calculated” value derived from the conducted value: 8.23dBm/MHz=5.22dBm/500kHz</b></p>	





## 4.5 FREQUENCY STABILITY

### 4.5.1 LIMITS OF FREQUENCY STABILITY MEASUREMENT

The frequency of the carrier signal shall be maintained within band of operation

### 4.5.2 TEST SETUP

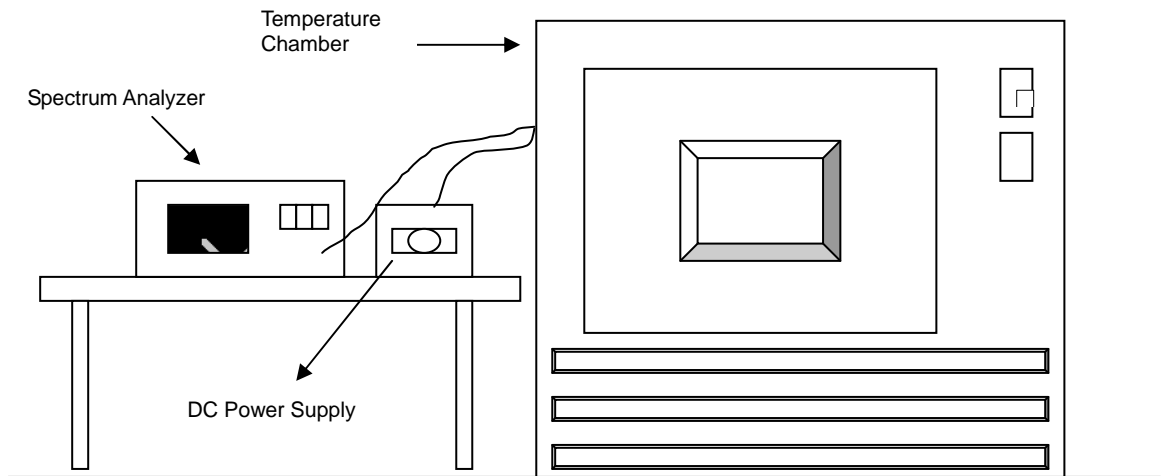

### 4.5.3 TEST INSTRUMENTS

Refer to section 4.1.3 to get information of above instrument.



#### 4.5.4 TEST PROCEDURE

- a. The EUT was placed inside the environmental test chamber and powered by nominal DC voltage.
- b. Turn the EUT on and couple its output to a spectrum analyzer.
- c. Turn the EUT off and set the chamber to the highest temperature specified.
- d. Allow sufficient time (approximately 30 min) for the temperature of the chamber to stabilize, turn the EUT on and measure the operating frequency after 2, 5, and 10 minutes.
- e. Repeat step 2 and 3 with the temperature chamber set to the lowest temperature.
- f. The test chamber was allowed to stabilize at +20 degree C for a minimum of 30 minutes. The supply voltage was then adjusted on the EUT from 85% to 115% and the frequency record.

#### 4.5.5 DEVIATION FROM TEST STANDARD

No deviation.

#### 4.5.6 EUT OPERATING CONDITION

Set the EUT transmit at un-modulation mode to test frequency stability.



#### 4.5.7 TEST RESULTS

FREQUENCY STABILITY VERSUS TEMP.									
OPERATING FREQUENCY: 5320MHz									
TEMP. (°C)	POWER SUPPLY (Vdc)	0 MINUTE		2 MINUTES		5 MINUTES		10 MINUTE	
		Measured Frequency (MHz)	Frequency Drift (%)	Measured Frequency (MHz)	Frequency Drift (%)	Measured Frequency (MHz)	Frequency Drift (%)	Measured Frequency (MHz)	Frequency Drift (%)
50	3.8	5320.0073	1.372	5320.0058	1.090	5320.0052	0.977	5320.008	1.504
40	3.8	5319.9782	-4.098	5319.9823	-3.327	5319.9819	-3.402	5319.9849	-2.838
30	3.8	5319.9948	-0.977	5320.0019	0.357	5320	0.000	5319.9949	-0.959
20	3.8	5319.9771	-4.305	5319.9743	-4.831	5319.979	-3.947	5319.9793	-3.891
10	3.8	5319.9847	-2.876	5319.9845	-2.914	5319.9847	-2.876	5319.9889	-2.086
0	3.8	5319.9908	-1.729	5319.9931	-1.297	5319.9846	-2.895	5319.9923	-1.447
-10	3.8	5319.9856	-2.707	5319.9947	-0.996	5319.9933	-1.259	5319.9896	-1.955
-20	3.8	5319.9883	-2.199	5319.9843	-2.951	5319.9854	-2.744	5319.9848	-2.857
-30	3.8	5319.9873	-2.387	5319.9831	-3.177	5319.9901	-1.861	5319.9897	-1.936

FREQUENCY STABILITY VERSUS VOLTAGE									
OPERATING FREQUENCY: 5320MHz									
TEMP. (°C)	POWER SUPPLY (Vdc)	0 MINUTE		2 MINUTE		5 MINUTE		10 MINUTE	
		Measured Frequency (MHz)	Frequency Drift (%)	Measured Frequency (MHz)	Frequency Drift (%)	Measured Frequency (MHz)	Frequency Drift (%)	Measured Frequency (MHz)	Frequency Drift (%)
20	4.2	5319.9765	-4.417	5319.9748	-4.737	5319.9794	-3.872	5319.9792	-3.910
	3.7	5319.9771	-4.305	5319.9743	-4.831	5319.979	-3.947	5319.9793	-3.891
	3.5	5319.9765	-4.417	5319.975	-4.699	5319.9793	-3.891	5319.98	-3.759



## 5 PHOTOGRAPHS OF THE TEST CONFIGURATION

Please refer to the attached file (Test Setup Photo).



Test Report No.: RF141111N015-7

## 6 APPENDIX A – MODIFICATIONS RECORDERS FOR ENGINEERING CHANGES TO THE EUT BY THE LAB

No modifications were made to the EUT by the lab during the test.

---END---