

# FCC TEST REPORT

## (WIFI 5G)

**Product:** LTE Smartphone

**Model No.:** XP7700

**FCC ID:** WYPL14V012AA

**Applicant:** Sonim Technologies, Inc.

**Address:** 1825 S. Grant St., Suite 200., San Mateo,CA,94402

**Manufacturer:** Sonim Technologies (Shenzhen) Limited

**Address:** Block B, 2nd Floor, Building #2, Daqian Industrial Park,  
Longchang Road,67 District Baoan, Shenzhen, Guangdong,  
P.R.China

**Prepared by:** Bureau Veritas Shenzhen Co., Ltd. Dongguan Branch

**Lab Location:** No. 34, Chenwulu Section, Guantai Rd., Houjie Town,  
Dongguan City, Guangdong 523942, China

**TEL:** +86 769 8593 5656

**FAX:** +86 769 8593 1080

**E-MAIL:** [customerservice.dg@cn.bureauveritas.com](mailto:customerservice.dg@cn.bureauveritas.com)

**Report No.:** RF150522N017-6

**Received Date:** May 22, 2015

**Test Date:** May 22, 2015 ~ May 27, 2015

**Issued Date:** May 28, 2015

This report should not be used by the client to claim product certification, approval, or endorsement by A2LA or any government agencies.

Any copying or replication of this report to or for any other person or entity, or use of our name or trademark, is permitted only with our prior written permission. This report sets forth our findings solely with respect to the test samples identified herein. The results set forth in this report are not indicative or representative of the quality or characteristics of the lot from which a test sample was taken or any similar or identical product unless specifically and expressly noted. Our report includes all of the tests requested by you and the results thereof based upon the information that you provided to us. You have 60 days from date of issuance of this report to notify us of any material error or omission caused by our negligence, provided, however, that such notice shall be in writing and shall specifically address the issue you wish to raise. A failure to raise such issue within the prescribed time shall constitute your unqualified acceptance of the completeness of this report, the tests conducted and the correctness of the report contents. Unless specific mention, the uncertainty of measurement has been explicitly taken into account to declare the compliance or non-compliance to the specification.



# TABLE OF CONTENTS

**RELEASE CONTROL RECORD ..... 4**

**1 CERTIFICATION ..... 5**

**2 SUMMARY OF TEST RESULTS ..... 6**

2.1 MEASUREMENT UNCERTAINTY ..... 6

**3 GENERAL INFORMATION ..... 7**

3.1 GENERAL DESCRIPTION OF EUT ..... 7

3.2 DESCRIPTION OF TEST MODES ..... 8

3.2.1 TEST MODE APPLICABILITY AND TESTED CHANNEL DETAIL ..... 9

3.3 DUTY CYCLE OF TEST SIGNAL ..... 12

3.4 DESCRIPTION OF SUPPORT UNITS ..... 12

3.4.1 CONFIGURATION OF SYSTEM UNDER TEST ..... 14

3.5 GENERAL DESCRIPTION OF APPLIED STANDARDS ..... 14

**4 TEST TYPES AND RESULTS ..... 15**

4.1 RADIATED EMISSION AND BANDEDGE MEASUREMENT ..... 15

4.1.1 LIMITS OF RADIATED EMISSION AND BANDEDGE MEASUREMENT ..... 15

4.1.2 LIMITS OF UNWANTED EMISSION OUT OF THE RESTRICTED BANDS ..... 15

4.1.3 TEST INSTRUMENTS ..... 16

4.1.4 TEST PROCEDURES ..... 17

4.1.5 DEVIATION FROM TEST STANDARD ..... 17

4.1.6 TEST SETUP ..... 18

4.1.7 EUT OPERATING CONDITION ..... 18

4.1.8 TEST RESULTS ..... 19

4.2 CONDUCTED EMISSION MEASUREMENT ..... 45

4.2.1 LIMITS OF CONDUCTED EMISSION MEASUREMENT ..... 45

4.2.2 TEST INSTRUMENTS ..... 45

4.2.3 TEST PROCEDURES ..... 45

4.2.4 DEVIATION FROM TEST STANDARD ..... 46

4.2.5 TEST SETUP ..... 46

4.2.6 EUT OPERATING CONDITIONS ..... 46

4.2.7 TEST RESULTS ..... 47



4.3	MAXIMUM CONDUCTED OUTPUT POWER MEASUREMENT .....	49
4.3.1	LIMITS OF MAXIMUM CONDUCTED OUTPUT POWER MEASUREMENT .....	49
4.3.2	TEST SETUP .....	49
4.3.3	TEST INSTRUMENTS.....	50
4.3.4	TEST PROCEDURE.....	50
4.3.5	DEVIATION FROM TEST STANDARD .....	51
4.3.6	EUT OPERATING CONDITIONS .....	51
4.3.7	TEST RESULTS .....	51
4.4	PEAK POWER SPECTRAL DENSITY MEASUREMENT .....	61
4.4.1	LIMITS OF PEAK POWER SPECTRAL DENSITY MEASUREMENT .....	61
4.4.2	TEST SETUP .....	61
4.4.3	TEST INSTRUMENTS.....	61
4.4.4	TEST PROCEDURES .....	61
4.4.5	DEVIATION FROM TEST STANDARD .....	62
4.4.6	EUT OPERATING CONDITIONS .....	62
4.4.7	TEST RESULTS .....	62
4.5	FREQUENCY STABILITY .....	67
4.5.1	LIMITS OF FREQUENCY STABILITY MEASUREMENT .....	67
4.5.2	TEST SETUP .....	67
4.5.3	TEST INSTRUMENTS.....	67
4.5.4	TEST PROCEDURE.....	68
4.5.5	DEVIATION FROM TEST STANDARD .....	68
4.5.6	EUT OPERATING CONDITION .....	68
4.5.7	TEST RESULTS .....	69
<b>5</b>	<b>PHOTOGRAPHS OF THE TEST CONFIGURATION .....</b>	<b>72</b>
<b>6</b>	<b>APPENDIX A – MODIFICATIONS RECORDERS FOR ENGINEERING CHANGES TO THE EUT BY THE LAB .....</b>	<b>73</b>



**BUREAU  
VERITAS**

Test Report No.: RF150522N017-6

## RELEASE CONTROL RECORD

ISSUE NO.	REASON FOR CHANGE	DATE ISSUED
RF150522N017-6	Original release	May 28, 2015



# 1 CERTIFICATION

**PRODUCT:** LTE Smartphone  
**BRAND NAME:** Sonim  
**MODEL NO.:** XP7700  
**APPLICANT:** Sonim Technologies, Inc.  
**TESTED:** May 22, 2015 ~ May 27, 2015  
**TEST SAMPLE:** Identical Prototype  
**STANDARDS:** **FCC Part 15, Subpart E (15.407), Section 15.407**  
ANSI C63.10-2009

The above equipment has been tested by **Bureau Veritas Shenzhen Co., Ltd. Dongguan Branch** and found compliance with the requirement of the above standards. The test record, data evaluation & Equipment Under Test (EUT) configurations represented herein are true and accurate accounts of the measurements of the sample's EMC characteristics under the conditions specified in this report.

**PREPARED BY** :  , **DATE:** May 28, 2015  
(Yuqiang Yin / Engineer)

**APPROVED BY** :  , **DATE:** May 28, 2015  
( Glyn He / Supervisor )



## 2 SUMMARY OF TEST RESULTS

The EUT has been tested according to the following specifications:

APPLIED STANDARD: FCC PART 15, SUBPART E (SECTION 15.407)			
STANDARD SECTION	TEST TYPE AND LIMIT	RESULT	REMARK
15.407(b)(5)	AC Power Conducted Emission	PASS	Meet the requirement of limit. Minimum passing margin is -11.06dB at 0.63856MHz.
15.407(b/1/2/3)(b)(5)	Electric Field Strength Spurious Emissions, 30MHz ~ 40000MHz	PASS	Meet the requirement of limit. Minimum passing margin is -3.1dB at 5725.00MHz.
15.407(a/1/2/3)	Maximum conducted output Power	PASS	Meet the requirement of limit.
15.407(a/1/2/3)	Peak Power Spectral Density	PASS	Meet the requirement of limit.
15.407(g)	Frequency Stability	PASS	Meet the requirement of limit.
15.203	Antenna Requirement	PASS	No antenna connector is used.

### 2.1 MEASUREMENT UNCERTAINTY

Where relevant, the following measurement uncertainty levels have been estimated for tests performed on the EUT as specified in CISPR 16-4-2:

MEASUREMENT	FREQUENCY	UNCERTAINTY
Conducted emissions	9kHz~30MHz	2.66dB
Radiated emissions	9KHz ~ 30MHz	2.74dB
	30MHz ~ 1GMHz	3.55dB
	1GHz ~ 18GHz	4.84dB
	18GHz ~ 40GHz	1.94dB

This uncertainty represents an expanded uncertainty expressed at approximately the 95% confidence level using a coverage factor of k = 2.



### 3 GENERAL INFORMATION

#### 3.1 GENERAL DESCRIPTION OF EUT

<b>PRODUCT</b>	LTE Smartphone
<b>MODEL NO.</b>	XP7700
<b>TYPE NUMBER</b>	L14V012AA
<b>POWER SUPPLY</b>	5.0Vdc (adapter or host equipment) 3.7Vdc (battery)
<b>MODULATION TYPE</b>	64QAM, 16QAM, QPSK, BPSK
<b>MODULATION TECHNOLOGY</b>	OFDM
<b>TRANSFER RATE</b>	802.11a: 54.0/ 48.0/ 36.0/ 24.0/ 18.0/ 12.0/ 9.0/ 6.0Mbps 802.11n: up to MCS7
<b>OPERATING FREQUENCY</b>	5180 ~ 5240MHz, 5260 ~ 5320MHz, 5500 ~ 5700MHz
<b>NUMBER OF CHANNEL</b>	5180 ~ 5240MHz: 4 for 802.11a, 802.11n (20MHz) 2 for 802.11n (40MHz) 5260 ~ 5320MHz: 4 for 802.11a, 802.11n (20MHz) 2 for 802.11n (40MHz) 5500 ~ 5700MHz: 8 for 802.11a, 802.11n (20MHz) 3 for 802.11n (40MHz)
<b>AVERAGE POWER</b>	8.054mW for 5180 ~ 5240MHz 7.745mW for 5260 ~ 5320MHz 9.954mW for 5500 ~ 5700MHz
<b>ANTENNA TYPE</b>	5180 ~ 5240MHz: PCB Antenna with 0.8dBi gain 5260 ~ 5320MHz: PCB Antenna with 1.3dBi gain 5500 ~ 5700MHz: PCB Antenna with 1dBi gain
<b>I/O PORTS</b>	Refer to user's manual
<b>CABLE SUPPLIED</b>	USB cable: Unshielded, detachable, 1.1m Earphone cable: Unshielded, detachable, 1.2m

**NOTE:**

- For a more detailed features description, please refer to the manufacturer's specifications or the user's manual.
- The EUT was powered by the following adapter:

<b>ADAPTER</b>	
<b>BRAND:</b>	Sonim
<b>MODEL:</b>	S11C02
<b>INPUT:</b>	AC 100-240V, 450mA
<b>OUTPUT:</b>	DC 5V, 2100mA

- The EUT matched the following USB cable:

<b>USB CABLE</b>	
<b>BRAND:</b>	Sunway
<b>MODEL:</b>	APC01G
<b>SIGNAL LINE:</b>	1.1 METER



- 4. The EUT incorporates a SISO function. Physically, the EUT provides one completed transmitters and one receivers.

MODULATION MODE	TX FUNCTION
802.11a	1TX/1RX
802.11n (20MHz)	1TX/1RX
802.11n (40MHz)	1TX/1RX

- 5. For the test results, the EUT had been tested with all conditions. But only the worst case was shown in test report.

### 3.2 DESCRIPTION OF TEST MODES

#### FOR 5150 ~ 5250MHz

4 channels are provided for 802.11a, 802.11n (20MHz):

CHANNEL	FREQUENCY	CHANNEL	FREQUENCY
36	5180 MHz	44	5220 MHz
40	5200 MHz	48	5240 MHz

2 channels are provided for 802.11n (40MHz):

CHANNEL	FREQUENCY	CHANNEL	FREQUENCY
38	5190 MHz	46	5230 MHz

#### FOR 5250 ~ 5350MHz

4 channels are provided for 802.11a, 802.11n (20MHz):

CHANNEL	FREQUENCY	CHANNEL	FREQUENCY
52	5260 MHz	60	5300 MHz
56	5280 MHz	64	5320 MHz

2 channels are provided for 802.11n (40MHz):

CHANNEL	FREQUENCY	CHANNEL	FREQUENCY
54	5270 MHz	62	5310 MHz





**FOR 5470 ~ 5725MHz**

8 channels are provided for 802.11a, 802.11n (20MHz):

CHANNEL	FREQUENCY	CHANNEL	FREQUENCY
100	5500 MHz	116	5580 MHz
104	5520 MHz	132	5660 MHz
108	5540 MHz	136	5680 MHz
112	5560 MHz	140	5700 MHz

3 channels are provided for 802.11n (40MHz):

CHANNEL	FREQUENCY	CHANNEL	FREQUENCY
102	5510 MHz	134	5670 MHz
110	5550 MHz		

**3.2.1 TEST MODE APPLICABILITY AND TESTED CHANNEL DETAIL**

EUT CONFIGURE MODE	APPLICABLE TO				DESCRIPTION
	RE≥1G	RE<1G	PLC	APCM	
A	√	√	√	-	Powered by Adapter with wifi(5G) link
B	-	-	-	√	Powered by Battery with wifi(5G) link
C	-	-	-	-	Powered by USB with wifi(5G) link

Where **RE≥1G**: Radiated Emission above 1GHz      **RE<1G**: Radiated Emission below 1GHz  
**PLC**: Power Line Conducted Emission      **APCM**: Antenna Port Conducted Measurement

**NOTE:**  
The EUT had been pre-tested on the positioned of each 3 axis. The worst case was found when positioned on **Y-plane**.  
**NOTE:** "-" means no effect.



**RADIATED EMISSION TEST (ABOVE 1GHz):**

- Pre-Scan has been conducted to determine the worst-case mode from all possible combinations between available modulations, data rates and antenna ports (if EUT with antenna diversity architecture).
- Following channel(s) was (were) selected for the final test as listed below.

EUT CONFIGURE MODE	MODE	FREQ. BAND (MHz)	AVAILABLE CHANNEL	TESTED CHANNEL	MODULATION TECHNOLOGY	MODULATION TYPE	DATA RATE (Mbps)
A	802.11a	5180-5240	36 to 48	36, 40, 48	OFDM	BPSK	6.0
A	802.11n (20MHz)		36 to 48	36, 40, 48	OFDM	BPSK	MCS0
A	802.11n (40MHz)		38 to 46	38, 46	OFDM	BPSK	MCS0
A	802.11a	5260-5320	52 to 64	52, 60, 64	OFDM	BPSK	6.0
A	802.11n (20MHz)		52 to 64	52, 60, 64	OFDM	BPSK	MCS0
A	802.11n (40MHz)		54 to 62	54, 62	OFDM	BPSK	MCS0
A	802.11a	5500-5700	100 to 140	100, 116, 140	OFDM	BPSK	6.0
A	802.11n (20MHz)		100 to 140	100, 116, 140	OFDM	BPSK	MCS0
A	802.11n (40MHz)		102 to 134	102, 110, 134	OFDM	BPSK	MCS0

**RADIATED EMISSION TEST (BELOW 1GHz):**

- Pre-Scan has been conducted to determine the worst-case mode from all possible combinations between available modulations, data rates and antenna ports (if EUT with antenna diversity architecture).
- Following channel(s) was (were) selected for the final test as listed below.

EUT CONFIGURE MODE	MODE	FREQ. BAND (MHz)	AVAILABLE CHANNEL	TESTED CHANNEL	MODULATION TECHNOLOGY	MODULATION TYPE	DATA RATE (Mbps)
A	802.11a	5180-5320	36 to 64	36	OFDM	BPSK	6.0

**POWER LINE CONDUCTED EMISSION TEST:**

- Pre-Scan has been conducted to determine the worst-case mode from all possible combinations between available modulations, data rates and antenna ports (if EUT with antenna diversity architecture).
- Following channel(s) was (were) selected for the final test as listed below.

EUT CONFIGURE MODE	MODE	FREQ. BAND (MHz)	AVAILABLE CHANNEL	TESTED CHANNEL	MODULATION TECHNOLOGY	MODULATION TYPE	DATA RATE (Mbps)
A	802.11a	5180-5320	36 to 64	36	OFDM	BPSK	6.0



**BANDEDGE MEASUREMENT:**

- Pre-Scan has been conducted to determine the worst-case mode from all possible combinations between available modulations, data rates and antenna ports (if EUT with antenna diversity architecture).
- Following channel(s) was (were) selected for the final test as listed below.

EUT CONFIGURE MODE	MODE	FREQ. BAND (MHz)	AVAILABLE CHANNEL	TESTED CHANNEL	MODULATION TECHNOLOGY	MODULATION TYPE	DATA RATE (Mbps)
A	802.11a	5180-5240	36 to 48	36, 48	OFDM	BPSK	6.0
A	802.11n (20MHz)		36 to 48	36, 48	OFDM	BPSK	MCS0
A	802.11n (40MHz)		38 to 46	38, 46	OFDM	BPSK	MCS0
A	802.11a	5260-5320	52 to 64	52, 64	OFDM	BPSK	6.0
A	802.11n (20MHz)		52 to 64	52, 64	OFDM	BPSK	MCS0
A	802.11n (40MHz)		54 to 62	54, 62	OFDM	BPSK	MCS0
A	802.11a	5500-5700	100 to 140	100, 140	OFDM	BPSK	6.0
A	802.11n (20MHz)		100 to 140	100, 140	OFDM	BPSK	MCS0
A	802.11n (40MHz)		102 to 134	102, 134	OFDM	BPSK	MCS0

**ANTENNA PORT CONDUCTED MEASUREMENT:**

- This item includes all test value of each mode, but only includes spectrum plot of worst value of each mode.
- Pre-Scan has been conducted to determine the worst-case mode from all possible combinations between available modulations, data rates and antenna ports (if EUT with antenna diversity architecture).
- Following channel(s) was (were) selected for the final test as listed below.

EUT CONFIGURE MODE	MODE	FREQ. BAND (MHz)	AVAILABLE CHANNEL	TESTED CHANNEL	MODULATION TECHNOLOGY	MODULATION TYPE	DATA RATE (Mbps)
B	802.11a	5180-5240	36 to 48	36, 40, 48	OFDM	BPSK	6.0
B	802.11n (20MHz)		36 to 48	36, 40, 48	OFDM	BPSK	MCS0
B	802.11n (40MHz)		38 to 46	38, 46	OFDM	BPSK	MCS0
B	802.11a	5260-5320	52 to 64	52, 60, 64	OFDM	BPSK	6.0
B	802.11n (20MHz)		52 to 64	52, 60, 64	OFDM	BPSK	MCS0
B	802.11n (40MHz)		54 to 62	54, 62	OFDM	BPSK	MCS0
B	802.11a	5500-5700	100 to 140	100, 116, 140	OFDM	BPSK	6.0
B	802.11n (20MHz)		100 to 140	100, 116, 140	OFDM	BPSK	MCS0
B	802.11n (40MHz)		102 to 134	102, 110, 134	OFDM	BPSK	MCS0

**TEST CONDITION:**

APPLICABLE TO	ENVIRONMENTAL CONDITIONS	INPUT POWER	TESTED BY
RE<1G	23deg. C, 62%RH	DC 5V By Adapter	Blue Zheng
RE≥1G	23deg. C, 62%RH	DC 5V By Adapter	Blue Zheng
PLC	24deg. C, 61%RH	DC 5V By Adapter	Yuqiang Yin
APCM	23.5deg. C, 60%RH	DC 3.7V By battery	Yuqiang Yin



### 3.3 DUTY CYCLE OF TEST SIGNAL

Duty cycle of test signal is < 98%, duty factor shall be considered.

**802.11a:** Duty cycle = 1.365/1.563 = 0.873, Duty factor = 10 \* log( 1/0.873) = 0.59

**802.11n (20MHz):** Duty cycle = 1.27/1.475 = 0.861, Duty factor = 10 \* log( 1/0.861) = 0.65

**802.11n (40MHz):** Duty cycle = 635/835 = 0.76, Duty factor = 10 \* log( 1/0.76) = 1.19

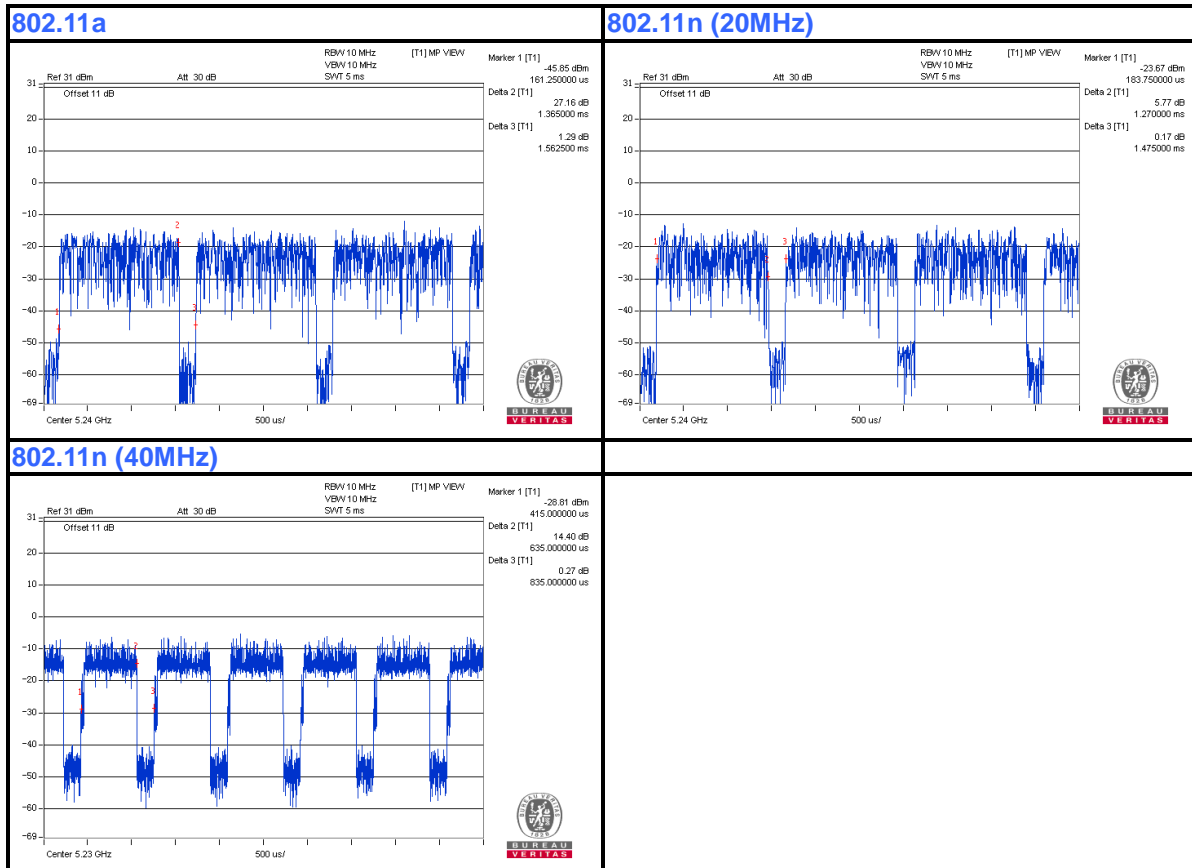



### 3.4 DESCRIPTION OF SUPPORT UNITS

The EUT has been tested as an independent unit together with other necessary accessories or support units. The following support units or accessories were used to form a representative test configuration during the tests.

NO.	PRODUCT	BRAND	MODEL NO.	SERIAL NO.	FCC ID
1	DC source	LONG WEI	PS-6403D	010934269	N/A
2	PC	HP	A6608CN	3CR83825X3	N/A
3	Earphone	Minami	ME-816B5-E	N/A	N/A

NO.	SIGNAL CABLE DESCRIPTION OF THE ABOVE SUPPORT UNITS
1	DC Line: Unshielded, Detachable 1.0m
2	AC Line: Unshielded, Detachable 1.5m
3	DC Line: Unshielded, Detachable 1.2m

**NOTE:**

1. All power cords of the above support units are non shielded (1.8m).



### 3.4.1 CONFIGURATION OF SYSTEM UNDER TEST

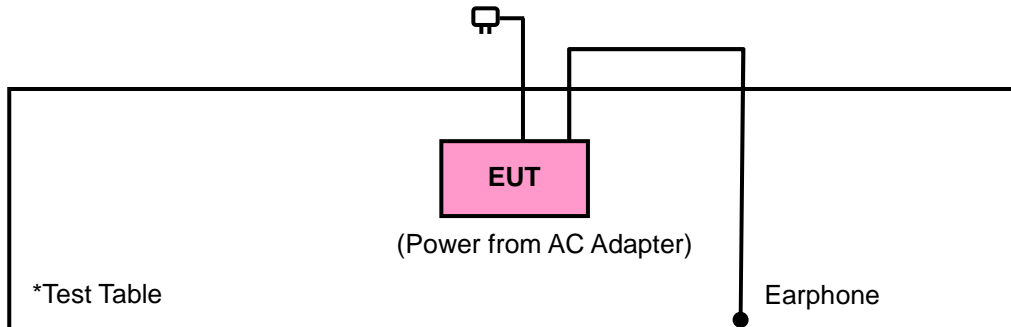

### 3.5 GENERAL DESCRIPTION OF APPLIED STANDARDS

The EUT is a RF Product. According to the specifications of the manufacturer, it must comply with the requirements of the following standards:

**FCC Part 15, Subpart E (15.407)**

**KDB 905462 \_Section 15.407 UNII Test Procedures**

ANSI C63.10-2009

All test items have been performed and recorded as per the above standards.

**NOTE:** The EUT is also considered as a kind of computer peripheral, because the connection to computer is necessary for typical use. It has been verified to comply with the requirements of FCC Part 15, Subpart B, Class B (verification). The test report has been issued separately.



## 4 TEST TYPES AND RESULTS

### 4.1 RADIATED EMISSION AND BANDEDGE MEASUREMENT

#### 4.1.1 LIMITS OF RADIATED EMISSION AND BANDEDGE MEASUREMENT

Radiated emissions which fall in the restricted bands must comply with the radiated emission limits specified as below table:

FREQUENCIES (MHz)	FIELD STRENGTH (microvolts/meter)	MEASUREMENT DISTANCE (meters)
0.009 ~ 0.490	2400/F(kHz)	300
0.490 ~ 1.705	24000/F(kHz)	30
1.705 ~ 30.0	30	30
30 ~ 88	100	3
88 ~ 216	150	3
216 ~ 960	200	3
Above 960	500	3

**NOTE:**

1. The lower limit shall apply at the transition frequencies.
2. Emission level (dBuV/m) = 20 log Emission level (uV/m).
3. For frequencies above 1000MHz, the field strength limits are based on average detector, however, the peak field strength of any emission shall not exceed the maximum permitted average limits, specified above by more than 20dB under any condition of modulation.

#### 4.1.2 LIMITS OF UNWANTED EMISSION OUT OF THE RESTRICTED BANDS

APPLICABLE TO	LIMIT	
	FIELD STRENGTH AT 3m (dBµV/m)	
	PK	AV
	74	54
√	EIRP LIMIT (dBm)	
	PK	PK
	-27	68.3

**NOTE:** The following formula is used to convert the equipment isotropic radiated power (eirp) to field strength:

$$E = \frac{1000000\sqrt{30P}}{3} \mu\text{V/m, where P is the eirp (Watts).}$$

**4.1.3 TEST INSTRUMENTS**

<b>Equipment</b>	<b>Manufacturer</b>	<b>Model No.</b>	<b>Serial No.</b>	<b>Last Cal.</b>	<b>Next Cal.</b>
EMI Test Receiver	Rohde&Schwarz	ESU 26	100005	May 11,15	May 10,16
Bilog Antenna	Teseq	CBL 6111D	30643	Jul. 25, 14	Jul. 24, 15
Horn Antenna (1GHz -18GHz)	ETS -Lindgren	3117	00062558	May 30, 14	May 29, 16
Amplifier (9kHz-1GHz)	SONOMA	310D	186955	Mar. 04,15	Mar. 03, 16
Pre-Amplifier (18GHz-40GHz)	EMCI	EMC 184045	980102	Nov. 20,14	Nov. 19,15
Pre-Amplifier (100MHz-26.5GHz)	Agilent	8449B	3008A00409	May 11,15	May 10,16
GPS Generator+ Antenna	TOJOIN	GNSS-5000A	E1-010119	Aug. 08, 14	Aug. 07, 15
3m Semi-anechoic Chamber	ETS-LINDGREN	9m*6m*6m	NSEMC003	Apr. 19,14	Apr. 18,16
Test Software	ADT	ADT_Radiated _V7.6.15.9.2	N/A	N/A	N/A
Spectrum Analyzer (10Hz-40GHz)	Rohde&Schwarz	FSV40	101003	Apr. 07,15	Apr. 06,16
Power Meter	Anritsu	ML2495A	1139001	Feb. 20,15	Feb. 19,16
Power Sensor	Anritsu	MA2411B	1126068	Feb. 20,15	Feb. 19,16
Digital Multimeter	FLUKE	15B	A1220010DG	Oct. 29, 14	Oct. 28, 15
Humid & Temp Programmable Tester	Haida	HD-2257	110807201	Sep.04,14	Sep. 03,15

**NOTE:**

1. The calibration interval of the above test instruments is 12 months and the calibrations are traceable to CEPREI/CHINA, GRGT/CHINA and NIM/CHINA.
2. The test was performed in 966 Chamber.
3. The FCC Site Registration No. is 502831.





#### 4.1.4 TEST PROCEDURES

- a. The EUT was placed on the top of a rotating table 0.8 meters above the ground at a 3 meter semi-anechoic chamber. The table was rotated 360 degrees to determine the position of the highest radiation.
- b. The EUT was set 3 meters away from the interference-receiving antenna, which was mounted on the top of a variable-height antenna tower.
- c. The antenna is a broadband antenna, and its height is varied from one meter to four meters above the ground to determine the maximum value of the field strength. Both horizontal and vertical polarizations of the antenna are set to make the measurement.
- d. For each suspected emission, the EUT was arranged to its worst case and then the antenna was tuned to heights from 1 meter to 4 meters and the rotatable table was turned from 0 degrees to 360 degrees to find the maximum reading.
- e. The test-receiver system was set to Peak Detect Function and Specified Bandwidth with Maximum Hold Mode.
- f. If the emission level of the EUT in peak mode was 10dB lower than the limit specified, then testing could be stopped and the peak values of the EUT would be reported. Otherwise the emissions that did not have 10dB margin would be re-tested one by one using peak, quasi-peak or average method as specified and then reported in a data sheet.

**NOTE:**

1. The resolution bandwidth and video bandwidth of test receiver/spectrum analyzer is 120kHz for Peak detection (PK) and Quasi-peak detection (QP) at frequency below 1GHz.
2. The resolution bandwidth of test receiver/spectrum analyzer is 1MHz and video bandwidth is 3MHz for Peak detection at frequency above 1GHz.
3. The resolution bandwidth of test receiver/spectrum analyzer is 1MHz and the video bandwidth is 10Hz for Average detection (AV) at frequency above 1GHz.
4. All modes of operation were investigated and the worst-case emissions are reported.

#### 4.1.5 DEVIATION FROM TEST STANDARD

No deviation.



#### 4.1.6 TEST SETUP

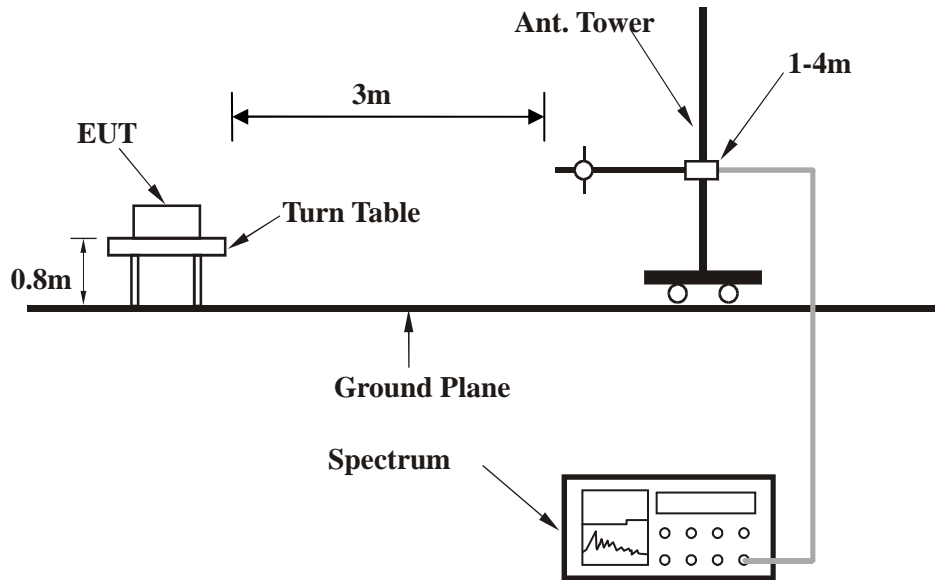

For the actual test configuration, please refer to the attached file (Test Setup Photo).

#### 4.1.7 EUT OPERATING CONDITION

- Set the EUT under full load condition and placed them on a testing table.
- Set the transmitter part of EUT under transmission condition continuously at specific channel frequency.
- The necessary accessories enable the EUT in full functions.



**4.1.8 TEST RESULTS**

**BELOW 1GHz WORST-CASE DATA:**

**802.11a**

<b>CHANNEL</b>	Channel 36	<b>DETECTOR FUNCTION</b>	Quasi-Peak (QP)
<b>FREQUENCY RANGE</b>	30MHz ~ 1GHz		

<b>ANTENNA POLARITY &amp; TEST DISTANCE: HORIZONTAL AT 3 M</b>								
<b>NO.</b>	<b>FREQ. (MHz)</b>	<b>EMISSION LEVEL (dBuV/m)</b>	<b>LIMIT (dBuV/m)</b>	<b>MARGIN (dB)</b>	<b>ANTENNA HEIGHT (m)</b>	<b>TABLE ANGLE (Degree)</b>	<b>RAW VALUE (dBuV)</b>	<b>CORRECTION FACTOR (dB/m)</b>
1	233.70	32.1 QP	46.0	-13.9	1.00 H	31	19.11	13.01
2	275.73	31.5 QP	46.0	-14.5	1.00 H	20	15.95	15.56
3	309.68	32.7 QP	46.0	-13.3	1.00 H	6	15.90	16.81
4	346.87	30.3 QP	46.0	-15.7	1.00 H	44	12.90	17.37
5	414.77	26.0 QP	46.0	-20.0	1.00 H	56	5.47	20.52
6	576.43	29.8 QP	46.0	-16.2	1.00 H	67	5.28	24.55

**REMARKS:**

1. Emission level (dBuV/m) = Raw Value (dBuV) + Correction Factor (dB/m).
2. Correction Factor (dB/m) = Antenna Factor (dB/m) + Cable Factor (dB).
3. The other emission levels were very low against the limit.
4. Margin value = Emission level – Limit value.

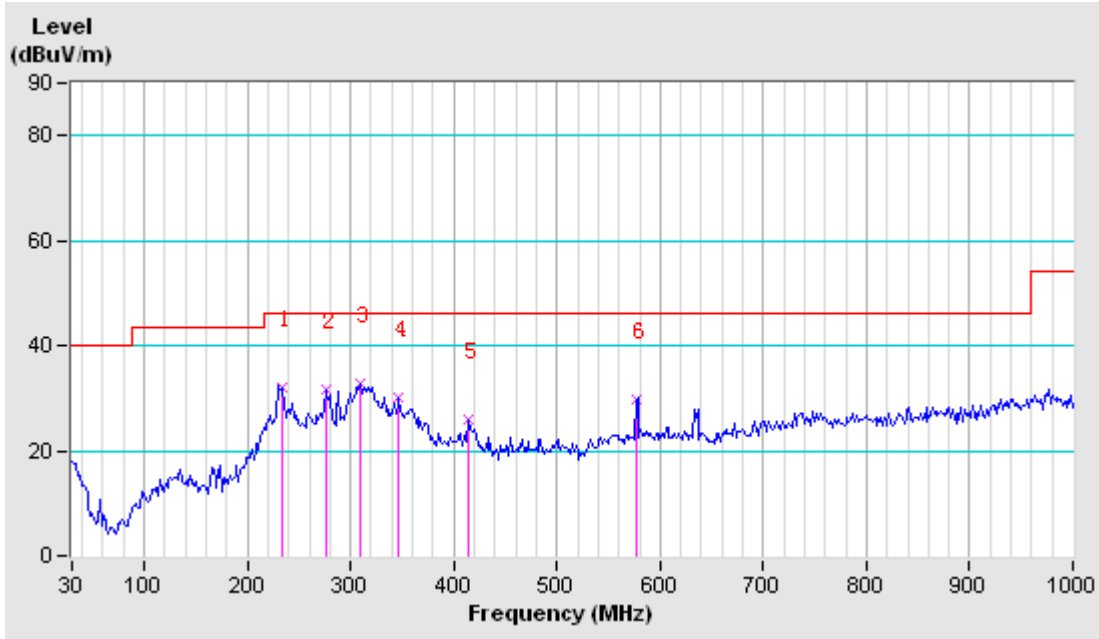



<b>CHANNEL</b>	Channel 36	<b>DETECTOR FUNCTION</b>	Quasi-Peak (QP)
<b>FREQUENCY RANGE</b>	30MHz ~ 1GHz		

ANTENNA POLARITY & TEST DISTANCE: VERTICAL AT 3 M								
NO.	FREQ. (MHz)	EMISSION LEVEL (dBuV/m)	LIMIT (dBuV/m)	MARGIN (dB)	ANTENNA HEIGHT (m)	TABLE ANGLE (Degree)	RAW VALUE (dBuV)	CORRECTION FACTOR (dB/m)
1	105.98	26.6 QP	43.5	-16.9	1.00 V	127	14.00	12.61
2	122.15	24.2 QP	43.5	-19.3	1.00 V	67	10.57	13.67
3	<b>181.97</b>	<b>32.3 QP</b>	<b>43.5</b>	<b>-11.2</b>	<b>1.00 V</b>	<b>116</b>	<b>21.16</b>	<b>11.12</b>
4	241.78	34.1 QP	46.0	-11.9	1.00 V	105	20.33	13.79
5	291.90	31.3 QP	46.0	-14.7	1.00 V	94	15.49	15.83
6	500.45	28.3 QP	46.0	-17.7	1.00 V	83	5.77	22.49

**REMARKS:**

1. Emission level (dBuV/m) = Raw Value (dBuV) + Correction Factor (dB/m).
2. Correction Factor (dB/m) = Antenna Factor (dB/m) + Cable Factor (dB).
3. The other emission levels were very low against the limit.
4. Margin value = Emission level – Limit value.

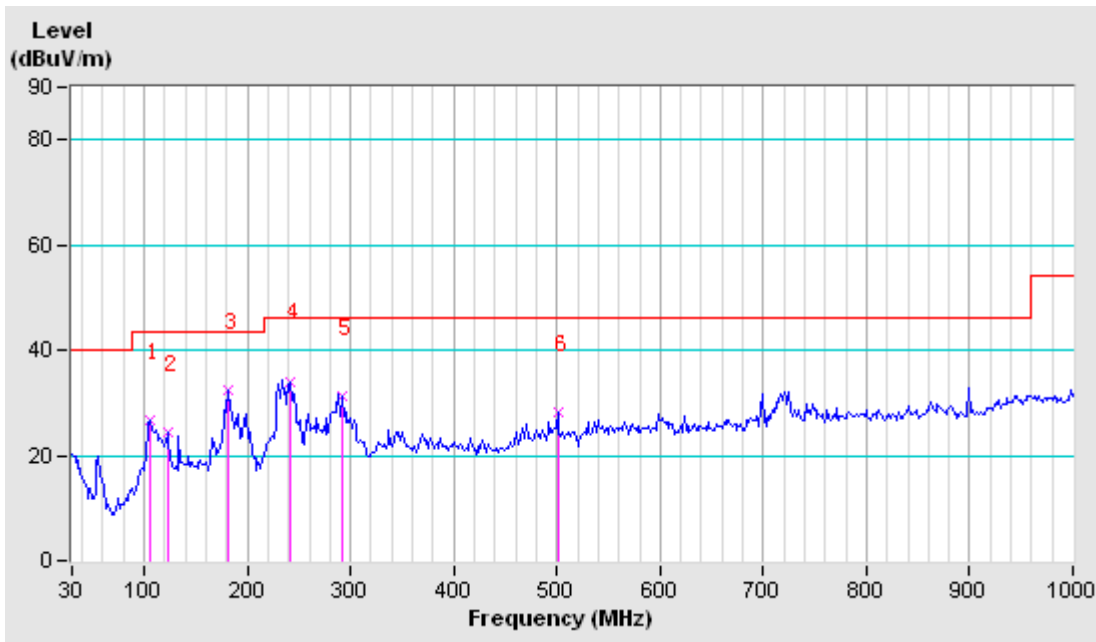



ABOVE 1GHz WORST-CASE DATA: Band 1

802.11a

CHANNEL	TX Channel 36	DETECTOR FUNCTION	Peak (PK)
FREQUENCY RANGE	1GHz ~ 40GHz		Average (AV)

ANTENNA POLARITY & TEST DISTANCE: HORIZONTAL AT 3 M								
NO.	FREQ. (MHz)	EMISSION LEVEL (dBuV/m)	LIMIT (dBuV/m)	MARGIN (dB)	ANTENNA HEIGHT (m)	TABLE ANGLE (Degree)	RAW VALUE (dBuV)	CORRECTION FACTOR (dB/m)
1	5150.00	66.7 PK	74.0	-7.3	1.14 H	360	27.01	39.65
2	5150.00	42.6 AV	54.0	-11.4	1.14 H	360	2.97	39.65
3	*5180.00	104.5 PK			1.14 H	360	64.82	39.70
4	*5180.00	86.4 AV			1.14 H	360	46.73	39.70
5	#10360.00	53.3 PK	74.0	-20.7	1.00 H	100	7.31	45.98
6	#10360.00	40.3 AV	54.0	-13.8	1.00 H	100	-5.73	45.98
ANTENNA POLARITY & TEST DISTANCE: VERTICAL AT 3 M								
NO.	FREQ. (MHz)	EMISSION LEVEL (dBuV/m)	LIMIT (dBuV/m)	MARGIN (dB)	ANTENNA HEIGHT (m)	TABLE ANGLE (Degree)	RAW VALUE (dBuV)	CORRECTION FACTOR (dB/m)
1	5150.00	61.6 PK	74.0	-12.4	1.13 V	0	21.97	39.65
2	5150.00	46.1 AV	54.0	-7.9	1.13 V	0	6.44	39.65
3	*5180.00	103.8 PK			1.13 V	0	64.07	39.70
4	*5180.00	86.6 AV			1.13 V	0	46.87	39.70
5	#10360.00	53.2 PK	74.0	-20.8	1.00 V	360	7.21	45.98
6	#10360.00	40.2 AV	54.0	-13.9	1.00 V	360	-5.83	45.98

REMARKS:

1. Emission level (dBuV/m) = Raw Value (dBuV) + Correction Factor (dB/m).
2. Correction Factor (dB/m) = Antenna Factor (dB/m) + Cable Factor (dB).
3. The other emission levels were very low against the limit.
4. Margin value = Emission level – Limit value.
5. " \* ": Fundamental frequency.
6. " # ": The radiated frequency is out of the restricted band.



CHANNEL	TX Channel 44	DETECTOR FUNCTION	Peak (PK)
FREQUENCY RANGE	1GHz ~ 40GHz		Average (AV)

ANTENNA POLARITY & TEST DISTANCE: HORIZONTAL AT 3 M								
NO.	FREQ. (MHz)	EMISSION LEVEL (dBuV/m)	LIMIT (dBuV/m)	MARGIN (dB)	ANTENNA HEIGHT (m)	TABLE ANGLE (Degree)	RAW VALUE (dBuV)	CORRECTION FACTOR (dB/m)
1	*5220.00	105.3 PK			1.28 H	360	65.53	39.76
2	*5220.00	86.7 AV			1.28 H	360	46.96	39.76
3	#10440.00	52.0 PK	74.0	-22.0	1.00 H	0	5.85	46.15
4	#10440.00	39.4 AV	54.0	-14.6	1.00 H	0	-6.76	46.15
ANTENNA POLARITY & TEST DISTANCE: VERTICAL AT 3 M								
NO.	FREQ. (MHz)	EMISSION LEVEL (dBuV/m)	LIMIT (dBuV/m)	MARGIN (dB)	ANTENNA HEIGHT (m)	TABLE ANGLE (Degree)	RAW VALUE (dBuV)	CORRECTION FACTOR (dB/m)
1	*5220.00	101.7 PK			1.00 V	3	61.96	39.76
2	*5220.00	84.3 AV			1.00 V	3	44.56	39.76
3	#10440.00	52.0 PK	74.0	-22.0	1.00 V	0	5.81	46.15
4	#10440.00	38.1 AV	54.0	-15.9	1.00 V	0	-8.06	46.15

REMARKS:

1. Emission level (dBuV/m) = Raw Value (dBuV) + Correction Factor (dB/m).
2. Correction Factor (dB/m) = Antenna Factor (dB/m) + Cable Factor (dB).
3. The other emission levels were very low against the limit.
4. Margin value = Emission level – Limit value.
5. " \* ": Fundamental frequency.
6. " # ": The radiated frequency is out of the restricted band.



CHANNEL	TX Channel 48	DETECTOR FUNCTION	Peak (PK)
FREQUENCY RANGE	1GHz ~ 40GHz		Average (AV)

ANTENNA POLARITY & TEST DISTANCE: HORIZONTAL AT 3 M								
NO.	FREQ. (MHz)	EMISSION LEVEL (dBuV/m)	LIMIT (dBuV/m)	MARGIN (dB)	ANTENNA HEIGHT (m)	TABLE ANGLE (Degree)	RAW VALUE (dBuV)	CORRECTION FACTOR (dB/m)
1	*5240.00	105.4 PK			1.29 H	0	65.61	39.79
2	*5240.00	86.9 AV			1.29 H	0	47.06	39.79
3	#10480.00	51.7 PK	74.0	-22.3	1.00 H	360	5.47	46.23
4	#10480.00	37.2 AV	54.0	-16.8	1.00 H	360	-9.05	46.23
ANTENNA POLARITY & TEST DISTANCE: VERTICAL AT 3 M								
NO.	FREQ. (MHz)	EMISSION LEVEL (dBuV/m)	LIMIT (dBuV/m)	MARGIN (dB)	ANTENNA HEIGHT (m)	TABLE ANGLE (Degree)	RAW VALUE (dBuV)	CORRECTION FACTOR (dB/m)
1	*5240.00	101.3 PK			1.00 V	360	61.50	39.79
2	*5240.00	84.2 AV			1.00 V	360	44.38	39.79
3	#10480.00	52.3 PK	74.0	-21.7	1.00 V	360	6.10	46.23
4	#10480.00	37.2 AV	54.0	-16.8	1.00 V	360	-9.03	46.23

REMARKS:

1. Emission level (dBuV/m) = Raw Value (dBuV) + Correction Factor (dB/m).
2. Correction Factor (dB/m) = Antenna Factor (dB/m) + Cable Factor (dB).
3. The other emission levels were very low against the limit.
4. Margin value = Emission level – Limit value.
5. " \* ": Fundamental frequency.
6. " # ": The radiated frequency is out of the restricted band.



802.11n (20MHz)

CHANNEL	TX Channel 36	DETECTOR FUNCTION	Peak (PK)
FREQUENCY RANGE	1GHz ~ 40GHz		Average (AV)

ANTENNA POLARITY & TEST DISTANCE: HORIZONTAL AT 3 M								
NO.	FREQ. (MHz)	EMISSION LEVEL (dBuV/m)	LIMIT (dBuV/m)	MARGIN (dB)	ANTENNA HEIGHT (m)	TABLE ANGLE (Degree)	RAW VALUE (dBuV)	CORRECTION FACTOR (dB/m)
1	5150.00	60.9 PK	74.0	-13.1	1.14 H	360	21.21	39.65
2	5150.00	43.4 AV	54.0	-10.6	1.14 H	360	3.79	39.65
3	*5180.00	104.1 PK			1.14 H	360	64.36	39.70
4	*5180.00	86.2 AV			1.14 H	360	46.46	39.70
5	#10420.00	52.3 PK	74.0	-21.7	1.14 H	0	6.19	46.11
6	#10420.00	40.3 AV	54.0	-13.7	1.14 H	0	-5.81	46.11
ANTENNA POLARITY & TEST DISTANCE: VERTICAL AT 3 M								
NO.	FREQ. (MHz)	EMISSION LEVEL (dBuV/m)	LIMIT (dBuV/m)	MARGIN (dB)	ANTENNA HEIGHT (m)	TABLE ANGLE (Degree)	RAW VALUE (dBuV)	CORRECTION FACTOR (dB/m)
1	5150.00	58.0 PK	74.0	-16.0	1.13 V	0	18.34	39.65
2	5150.00	43.2 AV	54.0	-10.8	1.13 V	0	3.57	39.65
3	*5180.00	100.8 PK			1.13 V	0	61.09	39.70
4	*5180.00	84.2 AV			1.13 V	0	44.52	39.70
5	#10420.00	52.7 PK	74.0	-21.3	1.14 V	0	6.59	46.11
6	#10420.00	39.7 AV	54.0	-14.3	1.14 V	0	-6.41	46.11

REMARKS:

1. Emission level (dBuV/m) = Raw Value (dBuV) + Correction Factor (dB/m).
2. Correction Factor (dB/m) = Antenna Factor (dB/m) + Cable Factor (dB).
3. The other emission levels were very low against the limit.
4. Margin value = Emission level – Limit value.
5. " \* ": Fundamental frequency.
6. " # ": The radiated frequency is out of the restricted band.





CHANNEL	TX Channel 44	DETECTOR FUNCTION	Peak (PK)
FREQUENCY RANGE	1GHz ~ 40GHz		Average (AV)

ANTENNA POLARITY & TEST DISTANCE: HORIZONTAL AT 3 M								
NO.	FREQ. (MHz)	EMISSION LEVEL (dBuV/m)	LIMIT (dBuV/m)	MARGIN (dB)	ANTENNA HEIGHT (m)	TABLE ANGLE (Degree)	RAW VALUE (dBuV)	CORRECTION FACTOR (dB/m)
1	*5220.00	104.0 PK			1.28 H	360	64.22	39.76
2	*5220.00	86.0 AV			1.28 H	360	46.20	39.76
3	#10440.00	52.2 PK	74.0	-21.8	1.00 H	0	6.02	46.15
4	#10440.00	39.5 AV	54.0	-14.5	1.00 H	0	-6.65	46.15
ANTENNA POLARITY & TEST DISTANCE: VERTICAL AT 3 M								
NO.	FREQ. (MHz)	EMISSION LEVEL (dBuV/m)	LIMIT (dBuV/m)	MARGIN (dB)	ANTENNA HEIGHT (m)	TABLE ANGLE (Degree)	RAW VALUE (dBuV)	CORRECTION FACTOR (dB/m)
1	*5220.00	101.2 PK			1.00 V	3	61.48	39.76
2	*5220.00	83.8 AV			1.00 V	3	44.08	39.76
3	#10440.00	52.2 PK	74.0	-21.8	1.00 V	0	6.05	46.15
4	#10440.00	38.2 AV	54.0	-15.8	1.00 V	0	-7.91	46.15

REMARKS:

1. Emission level (dBuV/m) = Raw Value (dBuV) + Correction Factor (dB/m).
2. Correction Factor (dB/m) = Antenna Factor (dB/m) + Cable Factor (dB).
3. The other emission levels were very low against the limit.
4. Margin value = Emission level – Limit value.
5. " \* ": Fundamental frequency.
6. " # ": The radiated frequency is out of the restricted band.



CHANNEL	TX Channel 48	DETECTOR FUNCTION	Peak (PK)
FREQUENCY RANGE	1GHz ~ 40GHz		Average (AV)

ANTENNA POLARITY & TEST DISTANCE: HORIZONTAL AT 3 M								
NO.	FREQ. (MHz)	EMISSION LEVEL (dBuV/m)	LIMIT (dBuV/m)	MARGIN (dB)	ANTENNA HEIGHT (m)	TABLE ANGLE (Degree)	RAW VALUE (dBuV)	CORRECTION FACTOR (dB/m)
1	*5240.00	104.5 PK			1.18 H	0	64.72	39.79
2	*5240.00	86.7 AV			1.18 H	0	46.94	39.79
3	#10480.00	53.3 PK	74.0	-20.7	1.00 H	360	7.04	46.23
4	#10480.00	39.6 AV	54.0	-14.4	1.00 H	360	-6.66	46.23
ANTENNA POLARITY & TEST DISTANCE: VERTICAL AT 3 M								
NO.	FREQ. (MHz)	EMISSION LEVEL (dBuV/m)	LIMIT (dBuV/m)	MARGIN (dB)	ANTENNA HEIGHT (m)	TABLE ANGLE (Degree)	RAW VALUE (dBuV)	CORRECTION FACTOR (dB/m)
1	*5240.00	101.9 PK			1.00 V	350	62.11	39.79
2	*5240.00	83.3 AV			1.00 V	350	43.50	39.79
3	#10480.00	52.4 PK	74.0	-21.6	1.00 V	360	6.13	46.23
4	#10480.00	38.2 AV	54.0	-15.8	1.00 V	360	-8.00	46.23

REMARKS:

1. Emission level (dBuV/m) = Raw Value (dBuV) + Correction Factor (dB/m).
2. Correction Factor (dB/m) = Antenna Factor (dB/m) + Cable Factor (dB).
3. The other emission levels were very low against the limit.
4. Margin value = Emission level – Limit value.
5. " \* ": Fundamental frequency.
6. " # ": The radiated frequency is out of the restricted band.



802.11n (40MHz)

CHANNEL	TX Channel 38	DETECTOR FUNCTION	Peak (PK)
FREQUENCY RANGE	1GHz ~ 40GHz		Average (AV)

ANTENNA POLARITY & TEST DISTANCE: HORIZONTAL AT 3 M								
NO.	FREQ. (MHz)	EMISSION LEVEL (dBuV/m)	LIMIT (dBuV/m)	MARGIN (dB)	ANTENNA HEIGHT (m)	TABLE ANGLE (Degree)	RAW VALUE (dBuV)	CORRECTION FACTOR (dB/m)
1	5150.00	69.4 PK	74.0	-4.6	1.29 H	0	29.75	39.65
2	5150.00	50.2 AV	54.0	-3.8	1.29 H	0	10.55	39.65
3	*5190.00	101.4 PK			1.29 H	0	61.71	39.71
4	*5190.00	78.4 AV			1.29 H	0	38.70	39.71
5	#10380.00	53.0 PK	74.0	-21.0	1.00 H	0	6.95	46.02
6	#10380.00	39.7 AV	54.0	-14.3	1.00 H	0	-6.36	46.02
ANTENNA POLARITY & TEST DISTANCE: VERTICAL AT 3 M								
NO.	FREQ. (MHz)	EMISSION LEVEL (dBuV/m)	LIMIT (dBuV/m)	MARGIN (dB)	ANTENNA HEIGHT (m)	TABLE ANGLE (Degree)	RAW VALUE (dBuV)	CORRECTION FACTOR (dB/m)
1	5150.00	70.6 PK	74.0	-3.4	1.13 V	0	30.95	39.65
2	5150.00	50.0 AV	54.0	-4.0	1.13 V	0	10.35	39.65
3	*5190.00	99.6 PK			1.13 V	0	59.84	39.71
4	*5190.00	77.2 AV			1.13 V	0	37.46	39.71
5	#10380.00	53.1 PK	74.0	-20.9	1.00 V	0	7.05	46.02
6	#10380.00	39.2 AV	54.0	-14.8	1.00 V	0	-6.80	46.02

REMARKS:

1. Emission level (dBuV/m) = Raw Value (dBuV) + Correction Factor (dB/m).
2. Correction Factor (dB/m) = Antenna Factor (dB/m) + Cable Factor (dB).
3. The other emission levels were very low against the limit.
4. Margin value = Emission level – Limit value.
5. " \* ": Fundamental frequency.
6. " # ": The radiated frequency is out of the restricted band.



CHANNEL	TX Channel 46	DETECTOR FUNCTION	Peak (PK)
FREQUENCY RANGE	1GHz ~ 40GHz		Average (AV)

ANTENNA POLARITY & TEST DISTANCE: HORIZONTAL AT 3 M								
NO.	FREQ. (MHz)	EMISSION LEVEL (dBuV/m)	LIMIT (dBuV/m)	MARGIN (dB)	ANTENNA HEIGHT (m)	TABLE ANGLE (Degree)	RAW VALUE (dBuV)	CORRECTION FACTOR (dB/m)
1	*5230.00	102.2 PK			1.18 H	0	62.42	39.78
2	*5230.00	79.2 AV			1.18 H	0	39.39	39.78
3	#10460.00	52.9 PK	74.0	-21.1	1.00 H	0	6.71	46.19
4	#10460.00	39.3 AV	54.0	-14.7	1.00 H	0	-6.86	46.19
ANTENNA POLARITY & TEST DISTANCE: VERTICAL AT 3 M								
NO.	FREQ. (MHz)	EMISSION LEVEL (dBuV/m)	LIMIT (dBuV/m)	MARGIN (dB)	ANTENNA HEIGHT (m)	TABLE ANGLE (Degree)	RAW VALUE (dBuV)	CORRECTION FACTOR (dB/m)
1	*5230.00	98.7 PK			1.12 V	360	58.94	39.78
2	*5230.00	76.2 AV			1.12 V	360	36.37	39.78
3	#10460.00	52.0 PK	74.0	-22.0	1.00 V	0	5.85	46.19
4	#10460.00	38.2 AV	54.0	-15.8	1.00 V	0	-8.02	46.19

REMARKS:

1. Emission level (dBuV/m) = Raw Value (dBuV) + Correction Factor (dB/m).
2. Correction Factor (dB/m) = Antenna Factor (dB/m) + Cable Factor (dB).
3. The other emission levels were very low against the limit.
4. Margin value = Emission level – Limit value.
5. " \* ": Fundamental frequency.
6. " # ": The radiated frequency is out of the restricted band.



ABOVE 1GHz WORST-CASE DATA: Band 2

802.11a

CHANNEL	TX Channel 52	DETECTOR FUNCTION	Peak (PK)
FREQUENCY RANGE	1GHz ~ 40GHz		Average (AV)

ANTENNA POLARITY & TEST DISTANCE: HORIZONTAL AT 3 M								
NO.	FREQ. (MHz)	EMISSION LEVEL (dBuV/m)	LIMIT (dBuV/m)	MARGIN (dB)	ANTENNA HEIGHT (m)	TABLE ANGLE (Degree)	RAW VALUE (dBuV)	CORRECTION FACTOR (dB/m)
1	*5260.00	104.7 PK			1.92 H	182	64.88	39.83
2	*5260.00	86.7 AV			1.92 H	182	46.89	39.83
3	#10520.00	52.4 PK	74.0	-21.6	1.00 H	360	6.09	46.29
4	#10520.00	38.1 AV	54.0	-15.9	1.00 H	360	-8.19	46.29
ANTENNA POLARITY & TEST DISTANCE: VERTICAL AT 3 M								
NO.	FREQ. (MHz)	EMISSION LEVEL (dBuV/m)	LIMIT (dBuV/m)	MARGIN (dB)	ANTENNA HEIGHT (m)	TABLE ANGLE (Degree)	RAW VALUE (dBuV)	CORRECTION FACTOR (dB/m)
1	*5260.00	103.3 PK			1.04 V	112	63.48	39.83
2	*5260.00	82.1 AV			1.04 V	112	42.27	39.83
3	#10520.00	53.4 PK	74.0	-20.6	1.00 V	360	7.13	46.29
4	#10520.00	38.5 AV	54.0	-15.5	1.00 V	360	-7.80	46.29

REMARKS:

1. Emission level (dBuV/m) = Raw Value (dBuV) + Correction Factor (dB/m).
2. Correction Factor (dB/m) = Antenna Factor (dB/m) + Cable Factor (dB).
3. The other emission levels were very low against the limit.
4. Margin value = Emission level – Limit value.
5. " \* ": Fundamental frequency.
6. " # ": The radiated frequency is out of the restricted band.



CHANNEL	TX Channel 60	DETECTOR FUNCTION	Peak (PK)
FREQUENCY RANGE	1GHz ~ 40GHz		Average (AV)

ANTENNA POLARITY & TEST DISTANCE: HORIZONTAL AT 3 M

NO.	FREQ. (MHz)	EMISSION LEVEL (dBuV/m)	LIMIT (dBuV/m)	MARGIN (dB)	ANTENNA HEIGHT (m)	TABLE ANGLE (Degree)	RAW VALUE (dBuV)	CORRECTION FACTOR (dB/m)
1	*5300.00	104.7 PK			1.57 H	228	64.76	39.89
2	*5300.00	86.4 AV			1.57 H	228	46.47	39.89
3	10600.00	52.9 PK	74.0	-21.1	1.00 H	0	6.54	46.38
4	10600.00	39.0 AV	54.0	-15.0	1.00 H	0	-7.34	46.38

ANTENNA POLARITY & TEST DISTANCE: VERTICAL AT 3 M

NO.	FREQ. (MHz)	EMISSION LEVEL (dBuV/m)	LIMIT (dBuV/m)	MARGIN (dB)	ANTENNA HEIGHT (m)	TABLE ANGLE (Degree)	RAW VALUE (dBuV)	CORRECTION FACTOR (dB/m)
1	*5300.00	103.1 PK			1.34 V	190	63.19	39.89
2	*5300.00	84.6 AV			1.34 V	190	44.69	39.89
3	10600.00	53.2 PK	74.0	-20.8	1.00 V	0	6.82	46.38
4	10600.00	38.2 AV	54.0	-15.8	1.00 V	0	-8.15	46.38

REMARKS:

1. Emission level (dBuV/m) = Raw Value (dBuV) + Correction Factor (dB/m).
2. Correction Factor (dB/m) = Antenna Factor (dB/m) + Cable Factor (dB).
3. The other emission levels were very low against the limit.
4. Margin value = Emission level – Limit value.
5. " \* ": Fundamental frequency.



CHANNEL	TX Channel 64	DETECTOR FUNCTION	Peak (PK)
FREQUENCY RANGE	1GHz ~ 40GHz		Average (AV)

ANTENNA POLARITY & TEST DISTANCE: HORIZONTAL AT 3 M

NO.	FREQ. (MHz)	EMISSION LEVEL (dBuV/m)	LIMIT (dBuV/m)	MARGIN (dB)	ANTENNA HEIGHT (m)	TABLE ANGLE (Degree)	RAW VALUE (dBuV)	CORRECTION FACTOR (dB/m)
1	*5320.00	103.6 PK			1.62 H	207	63.64	39.92
2	*5320.00	86.4 AV			1.62 H	207	46.52	39.92
3	5350.00	61.7 PK	74.0	-12.3	1.62 H	207	21.77	39.97
4	5350.00	44.3 AV	54.0	-9.7	1.62 H	207	4.33	39.97
5	10640.00	52.6 PK	74.0	-21.4	1.00 H	0	6.20	46.42
6	10640.00	38.1 AV	54.0	-15.9	1.00 H	0	-8.35	46.42

ANTENNA POLARITY & TEST DISTANCE: VERTICAL AT 3 M

NO.	FREQ. (MHz)	EMISSION LEVEL (dBuV/m)	LIMIT (dBuV/m)	MARGIN (dB)	ANTENNA HEIGHT (m)	TABLE ANGLE (Degree)	RAW VALUE (dBuV)	CORRECTION FACTOR (dB/m)
1	*5320.00	102.5 PK			1.00 V	253	62.57	39.92
2	*5320.00	83.8 AV			1.00 V	253	43.83	39.92
3	5350.00	58.6 PK	74.0	-15.4	1.00 V	253	18.65	39.97
4	5350.00	42.8 AV	54.0	-11.2	1.00 V	253	2.84	39.97
5	10640.00	53.1 PK	74.0	-20.9	1.00 V	0	6.70	46.42
6	10640.00	38.3 AV	54.0	-15.8	1.00 V	0	-8.17	46.42

REMARKS:

1. Emission level (dBuV/m) = Raw Value (dBuV) + Correction Factor (dB/m).
2. Correction Factor (dB/m) = Antenna Factor (dB/m) + Cable Factor (dB).
3. The other emission levels were very low against the limit.
4. Margin value = Emission level – Limit value.
5. " \* ": Fundamental frequency.



**802.11n (20MHz)**

<b>CHANNEL</b>	TX Channel 52	<b>DETECTOR FUNCTION</b>	Peak (PK)
<b>FREQUENCY RANGE</b>	1GHz ~ 40GHz		Average (AV)

<b>ANTENNA POLARITY &amp; TEST DISTANCE: HORIZONTAL AT 3 M</b>								
<b>NO.</b>	<b>FREQ. (MHz)</b>	<b>EMISSION LEVEL (dBuV/m)</b>	<b>LIMIT (dBuV/m)</b>	<b>MARGIN (dB)</b>	<b>ANTENNA HEIGHT (m)</b>	<b>TABLE ANGLE (Degree)</b>	<b>RAW VALUE (dBuV)</b>	<b>CORRECTION FACTOR (dB/m)</b>
1	*5260.00	102.9 PK			1.89 H	183	63.07	39.83
2	*5260.00	85.7 AV			1.89 H	183	45.86	39.83
3	#10520.00	52.6 PK	74.0	-21.4	1.00 H	0	6.33	46.29
4	#10520.00	38.2 AV	54.0	-15.8	1.00 H	0	-8.09	46.29

<b>ANTENNA POLARITY &amp; TEST DISTANCE: VERTICAL AT 3 M</b>								
<b>NO.</b>	<b>FREQ. (MHz)</b>	<b>EMISSION LEVEL (dBuV/m)</b>	<b>LIMIT (dBuV/m)</b>	<b>MARGIN (dB)</b>	<b>ANTENNA HEIGHT (m)</b>	<b>TABLE ANGLE (Degree)</b>	<b>RAW VALUE (dBuV)</b>	<b>CORRECTION FACTOR (dB/m)</b>
1	*5260.00	100.6 PK			1.04 V	163	60.75	39.83
2	*5260.00	82.6 AV			1.04 V	163	42.74	39.83
3	#10520.00	52.8 PK	74.0	-21.3	1.00 V	0	6.46	46.29
4	#10520.00	38.0 AV	54.0	-16.0	1.00 V	0	-8.33	46.29

**REMARKS:**

1. Emission level (dBuV/m) = Raw Value (dBuV) + Correction Factor (dB/m).
2. Correction Factor (dB/m) = Antenna Factor (dB/m) + Cable Factor (dB).
3. The other emission levels were very low against the limit.
4. Margin value = Emission level – Limit value.
5. " \* ": Fundamental frequency.
6. " # ": The radiated frequency is out of the restricted band.





CHANNEL	TX Channel 60	DETECTOR FUNCTION	Peak (PK)
FREQUENCY RANGE	1GHz ~ 40GHz		Average (AV)

ANTENNA POLARITY & TEST DISTANCE: HORIZONTAL AT 3 M								
NO.	FREQ. (MHz)	EMISSION LEVEL (dBuV/m)	LIMIT (dBuV/m)	MARGIN (dB)	ANTENNA HEIGHT (m)	TABLE ANGLE (Degree)	RAW VALUE (dBuV)	CORRECTION FACTOR (dB/m)
1	*5300.00	103.2 PK			1.57 H	63	63.27	39.89
2	*5300.00	85.1 AV			1.57 H	63	45.22	39.89
3	10600.00	52.4 PK	74.0	-21.6	1.00 H	0	6.05	46.38
4	10600.00	38.5 AV	54.0	-15.5	1.00 H	0	-7.88	46.38
ANTENNA POLARITY & TEST DISTANCE: VERTICAL AT 3 M								
NO.	FREQ. (MHz)	EMISSION LEVEL (dBuV/m)	LIMIT (dBuV/m)	MARGIN (dB)	ANTENNA HEIGHT (m)	TABLE ANGLE (Degree)	RAW VALUE (dBuV)	CORRECTION FACTOR (dB/m)
1	*5300.00	99.1 PK			1.33 V	55	59.21	39.89
2	*5300.00	80.5 AV			1.33 V	55	40.63	39.89
3	10600.00	54.0 PK	74.0	-20.0	1.00 V	0	7.65	46.38
4	10600.00	38.3 AV	54.0	-15.7	1.00 V	0	-8.08	46.38

REMARKS:

1. Emission level (dBuV/m) = Raw Value (dBuV) + Correction Factor (dB/m).
2. Correction Factor (dB/m) = Antenna Factor (dB/m) + Cable Factor (dB).
3. The other emission levels were very low against the limit.
4. Margin value = Emission level – Limit value.
5. " \* ": Fundamental frequency.



CHANNEL	TX Channel 64	DETECTOR FUNCTION	Peak (PK)
FREQUENCY RANGE	1GHz ~ 40GHz		Average (AV)

ANTENNA POLARITY & TEST DISTANCE: HORIZONTAL AT 3 M								
NO.	FREQ. (MHz)	EMISSION LEVEL (dBuV/m)	LIMIT (dBuV/m)	MARGIN (dB)	ANTENNA HEIGHT (m)	TABLE ANGLE (Degree)	RAW VALUE (dBuV)	CORRECTION FACTOR (dB/m)
1	*5320.00	103.1 PK			1.57 H	65	63.19	39.92
2	*5320.00	84.7 AV			1.57 H	65	44.81	39.92
3	5350.00	60.0 PK	74.0	-14.0	1.57 H	65	19.99	39.97
4	5350.00	45.0 AV	54.0	-9.0	1.57 H	65	5.05	39.97
5	10640.00	53.6 PK	74.0	-20.4	1.00 H	360	7.18	46.42
6	10640.00	39.8 AV	54.0	-14.2	1.00 H	360	-6.59	46.42
ANTENNA POLARITY & TEST DISTANCE: VERTICAL AT 3 M								
NO.	FREQ. (MHz)	EMISSION LEVEL (dBuV/m)	LIMIT (dBuV/m)	MARGIN (dB)	ANTENNA HEIGHT (m)	TABLE ANGLE (Degree)	RAW VALUE (dBuV)	CORRECTION FACTOR (dB/m)
1	*5320.00	99.6 PK			1.68 V	67	59.67	39.92
2	*5320.00	81.8 AV			1.68 V	67	41.88	39.92
3	5350.00	57.2 PK	74.0	-16.8	1.68 V	67	17.22	39.97
4	5350.00	42.7 AV	54.0	-11.3	1.68 V	67	2.70	39.97
5	10640.00	52.5 PK	74.0	-21.5	1.00 V	360	6.07	46.42
6	10640.00	38.8 AV	54.0	-15.2	1.00 V	360	-7.66	46.42

REMARKS:

1. Emission level (dBuV/m) = Raw Value (dBuV) + Correction Factor (dB/m).
2. Correction Factor (dB/m) = Antenna Factor (dB/m) + Cable Factor (dB).
3. The other emission levels were very low against the limit.
4. Margin value = Emission level – Limit value.
5. " \* ": Fundamental frequency.



**802.11n (40MHz)**

<b>CHANNEL</b>	TX Channel 54	<b>DETECTOR FUNCTION</b>	Peak (PK)
<b>FREQUENCY RANGE</b>	1GHz ~ 40GHz		Average (AV)

<b>ANTENNA POLARITY &amp; TEST DISTANCE: HORIZONTAL AT 3 M</b>								
<b>NO.</b>	<b>FREQ. (MHz)</b>	<b>EMISSION LEVEL (dBuV/m)</b>	<b>LIMIT (dBuV/m)</b>	<b>MARGIN (dB)</b>	<b>ANTENNA HEIGHT (m)</b>	<b>TABLE ANGLE (Degree)</b>	<b>RAW VALUE (dBuV)</b>	<b>CORRECTION FACTOR (dB/m)</b>
1	*5270.00	99.2 PK			1.74 H	61	59.36	39.84
2	*5270.00	76.6 AV			1.74 H	61	36.77	39.84
3	#10540.00	52.4 PK	74.0	-21.7	1.00 H	0	6.04	46.31
4	#10540.00	38.4 AV	54.0	-15.6	1.00 H	0	-7.91	46.31

<b>ANTENNA POLARITY &amp; TEST DISTANCE: VERTICAL AT 3 M</b>								
<b>NO.</b>	<b>FREQ. (MHz)</b>	<b>EMISSION LEVEL (dBuV/m)</b>	<b>LIMIT (dBuV/m)</b>	<b>MARGIN (dB)</b>	<b>ANTENNA HEIGHT (m)</b>	<b>TABLE ANGLE (Degree)</b>	<b>RAW VALUE (dBuV)</b>	<b>CORRECTION FACTOR (dB/m)</b>
1	*5270.00	97.7 PK			1.79 V	67	57.81	39.84
2	*5270.00	75.1 AV			1.79 V	67	35.21	39.84
3	#10540.00	53.3 PK	74.0	-20.7	1.00 V	67	6.96	46.31
4	#10540.00	38.4 AV	54.0	-15.6	1.00 V	67	-7.93	46.31

**REMARKS:**

1. Emission level (dBuV/m) = Raw Value (dBuV) + Correction Factor (dB/m).
2. Correction Factor (dB/m) = Antenna Factor (dB/m) + Cable Factor (dB).
3. The other emission levels were very low against the limit.
4. Margin value = Emission level – Limit value.
5. " \* ": Fundamental frequency.
6. " # ": The radiated frequency is out of the restricted band.



CHANNEL	TX Channel 62	DETECTOR FUNCTION	Peak (PK)
FREQUENCY RANGE	1GHz ~ 40GHz		Average (AV)

ANTENNA POLARITY & TEST DISTANCE: HORIZONTAL AT 3 M								
NO.	FREQ. (MHz)	EMISSION LEVEL (dBuV/m)	LIMIT (dBuV/m)	MARGIN (dB)	ANTENNA HEIGHT (m)	TABLE ANGLE (Degree)	RAW VALUE (dBuV)	CORRECTION FACTOR (dB/m)
1	*5310.00	99.1 PK			1.75 H	60	59.16	39.91
2	*5310.00	76.8 AV			1.75 H	60	36.89	39.91
3	5350.00	69.5 PK	74.0	-4.6	1.75 H	60	29.48	39.97
4	5350.00	50.1 AV	54.0	-3.9	1.75 H	60	10.17	39.97
5	10620.00	52.9 PK	74.0	-21.1	1.00 H	360	6.49	46.40
6	10620.00	38.2 AV	54.0	-15.8	1.00 H	360	-8.20	46.40
ANTENNA POLARITY & TEST DISTANCE: VERTICAL AT 3 M								
NO.	FREQ. (MHz)	EMISSION LEVEL (dBuV/m)	LIMIT (dBuV/m)	MARGIN (dB)	ANTENNA HEIGHT (m)	TABLE ANGLE (Degree)	RAW VALUE (dBuV)	CORRECTION FACTOR (dB/m)
1	*5310.00	97.8 PK			1.39 V	61	57.84	39.91
2	*5310.00	75.1 AV			1.39 V	61	35.21	39.91
3	5350.00	68.2 PK	74.0	-5.8	1.39 V	61	28.19	39.97
4	5350.00	48.8 AV	54.0	-5.3	1.39 V	61	8.78	39.97
5	10620.00	52.4 PK	74.0	-21.6	1.00 V	0	6.03	46.40
6	10620.00	38.2 AV	54.0	-15.8	1.00 V	0	-8.16	46.40

REMARKS:

1. Emission level (dBuV/m) = Raw Value (dBuV) + Correction Factor (dB/m).
2. Correction Factor (dB/m) = Antenna Factor (dB/m) + Cable Factor (dB).
3. The other emission levels were very low against the limit.
4. Margin value = Emission level – Limit value.
5. " \* ": Fundamental frequency.



ABOVE 1GHz WORST-CASE DATA: Band 3

802.11a

CHANNEL	TX Channel 100	DETECTOR FUNCTION	Peak (PK)
FREQUENCY RANGE	1GHz ~ 40GHz		Average (AV)

ANTENNA POLARITY & TEST DISTANCE: HORIZONTAL AT 3 M

NO.	FREQ. (MHz)	EMISSION LEVEL (dBuV/m)	LIMIT (dBuV/m)	MARGIN (dB)	ANTENNA HEIGHT (m)	TABLE ANGLE (Degree)	RAW VALUE (dBuV)	CORRECTION FACTOR (dB/m)
1	#5470.00	55.8 PK	68.3	-12.5	1.00 H	228	15.63	40.17
2	*5500.00	103.0 PK			1.00 H	206	62.78	40.22
3	*5500.00	85.2 AV			1.00 H	206	44.98	40.22
4	11000.00	54.6 PK	74.0	-19.4	1.00 H	206	7.80	46.80
5	11000.00	42.5 AV	54.0	-11.5	1.00 H	206	-4.30	46.80

ANTENNA POLARITY & TEST DISTANCE: VERTICAL AT 3 M

NO.	FREQ. (MHz)	EMISSION LEVEL (dBuV/m)	LIMIT (dBuV/m)	MARGIN (dB)	ANTENNA HEIGHT (m)	TABLE ANGLE (Degree)	RAW VALUE (dBuV)	CORRECTION FACTOR (dB/m)
1	#5470.00	64.3 PK	68.3	-4.0	1.00 V	310	39.02	25.28
2	*5500.00	115.2 PK			1.00 V	210	89.85	25.35
3	*5500.00	98.6 AV			1.00 V	210	73.25	25.35
4	11000.00	55.6 PK	74.0	-18.4	1.00 V	122	26.60	29.00
5	11000.00	44.6 AV	54.0	-9.4	1.00 V	122	15.60	29.00

REMARKS:

1. Emission level (dBuV/m) = Raw Value (dBuV) + Correction Factor (dB/m).
2. Correction Factor (dB/m) = Antenna Factor (dB/m) + Cable Factor (dB).
3. The other emission levels were very low against the limit.
4. Margin value = Emission level – Limit value.
5. " \* ": Fundamental frequency.
6. " # ": The radiated frequency is out of the restricted band.



CHANNEL	TX Channel 116	DETECTOR FUNCTION	Peak (PK)
FREQUENCY RANGE	1GHz ~ 40GHz		Average (AV)

ANTENNA POLARITY & TEST DISTANCE: HORIZONTAL AT 3 M								
NO.	FREQ. (MHz)	EMISSION LEVEL (dBuV/m)	LIMIT (dBuV/m)	MARGIN (dB)	ANTENNA HEIGHT (m)	TABLE ANGLE (Degree)	RAW VALUE (dBuV)	CORRECTION FACTOR (dB/m)
1	*5580.00	102.6 PK			1.00 H	332	62.17	40.43
2	*5580.00	83.4 AV			1.00 H	332	42.97	40.43
3	11160.00	53.6 PK	74.0	-20.4	1.00 H	211	6.66	46.94
4	11160.00	40.8 AV	54.0	-13.2	1.00 H	211	-6.14	46.94
ANTENNA POLARITY & TEST DISTANCE: VERTICAL AT 3 M								
NO.	FREQ. (MHz)	EMISSION LEVEL (dBuV/m)	LIMIT (dBuV/m)	MARGIN (dB)	ANTENNA HEIGHT (m)	TABLE ANGLE (Degree)	RAW VALUE (dBuV)	CORRECTION FACTOR (dB/m)
1	*5580.00	98.6 PK			1.00 V	223	58.17	40.43
2	*5580.00	77.2 AV			1.00 V	223	36.77	40.43
3	11160.00	51.6 PK	74.0	-22.4	1.00 V	240	4.66	46.94
4	11160.00	39.5 AV	54.0	-14.5	1.00 V	240	-7.44	46.94

REMARKS:

1. Emission level (dBuV/m) = Raw Value (dBuV) + Correction Factor (dB/m).
2. Correction Factor (dB/m) = Antenna Factor (dB/m) + Cable Factor (dB).
3. The other emission levels were very low against the limit.
4. Margin value = Emission level – Limit value.
5. " \* ": Fundamental frequency.



CHANNEL	TX Channel 140	DETECTOR FUNCTION	Peak (PK)
FREQUENCY RANGE	1GHz ~ 40GHz		Average (AV)

ANTENNA POLARITY & TEST DISTANCE: HORIZONTAL AT 3 M								
NO.	FREQ. (MHz)	EMISSION LEVEL (dBuV/m)	LIMIT (dBuV/m)	MARGIN (dB)	ANTENNA HEIGHT (m)	TABLE ANGLE (Degree)	RAW VALUE (dBuV)	CORRECTION FACTOR (dB/m)
1	*5700.00	104.9 PK			1.00 H	115	64.15	40.75
2	*5700.00	83.6 AV			1.00 H	115	42.85	40.75
3	#5725.00	65.2 PK	68.3	-3.1	1.00 H	145	24.39	40.81
4	11400.00	53.2 PK	74.0	-20.8	1.00 H	20	6.06	47.14
5	11400.00	39.6 AV	54.0	-14.4	1.00 H	20	-7.54	47.14
ANTENNA POLARITY & TEST DISTANCE: VERTICAL AT 3 M								
NO.	FREQ. (MHz)	EMISSION LEVEL (dBuV/m)	LIMIT (dBuV/m)	MARGIN (dB)	ANTENNA HEIGHT (m)	TABLE ANGLE (Degree)	RAW VALUE (dBuV)	CORRECTION FACTOR (dB/m)
1	*5700.00	96.8 PK			1.20 V	200	56.05	40.75
2	*5700.00	75.8 AV			1.20 V	200	35.05	40.75
3	#5725.00	53.6 PK	68.3	-14.7	1.00 V	214	12.79	40.81
4	11400.00	55.3 PK	74.0	-18.7	1.00 V	304	8.16	47.14
5	11400.00	40.8 AV	54.0	-13.2	1.00 V	304	-6.34	47.14

REMARKS:

1. Emission level (dBuV/m) = Raw Value (dBuV) + Correction Factor (dB/m).
2. Correction Factor (dB/m) = Antenna Factor (dB/m) + Cable Factor (dB).
3. The other emission levels were very low against the limit.
4. Margin value = Emission level – Limit value.
5. " \* ": Fundamental frequency.
6. " # ": The radiated frequency is out of the restricted band.



802.11n (20MHz)

CHANNEL	TX Channel 100	DETECTOR FUNCTION	Peak (PK)
FREQUENCY RANGE	1GHz ~ 40GHz		Average (AV)

ANTENNA POLARITY & TEST DISTANCE: HORIZONTAL AT 3 M								
NO.	FREQ. (MHz)	EMISSION LEVEL (dBuV/m)	LIMIT (dBuV/m)	MARGIN (dB)	ANTENNA HEIGHT (m)	TABLE ANGLE (Degree)	RAW VALUE (dBuV)	CORRECTION FACTOR (dB/m)
1	#5470.00	58.6 PK	68.3	-9.7	1.00 H	211	18.43	40.17
2	*5500.00	102.0 PK			1.00 H	214	61.78	40.22
3	*5500.00	83.3 AV			1.00 H	214	43.08	40.22
4	11000.00	55.2 PK	74.0	-18.8	1.00 H	302	8.40	46.80
5	11000.00	41.9 AV	54.0	-12.1	1.00 H	302	-4.90	46.80
ANTENNA POLARITY & TEST DISTANCE: VERTICAL AT 3 M								
NO.	FREQ. (MHz)	EMISSION LEVEL (dBuV/m)	LIMIT (dBuV/m)	MARGIN (dB)	ANTENNA HEIGHT (m)	TABLE ANGLE (Degree)	RAW VALUE (dBuV)	CORRECTION FACTOR (dB/m)
1	#5470.00	48.2 PK	68.3	-20.1	1.02 V	211	8.03	40.17
2	*5500.00	96.6 PK			1.45 V	102	56.38	40.22
3	*5500.00	75.6 AV			1.45 V	102	35.38	40.22
4	11000.00	53.2 PK	74.0	-20.8	1.00 V	224	6.40	46.80
5	11000.00	40.6 AV	54.0	-13.4	1.00 V	224	-6.20	46.80

REMARKS:

1. Emission level (dBuV/m) = Raw Value (dBuV) + Correction Factor (dB/m).
2. Correction Factor (dB/m) = Antenna Factor (dB/m) + Cable Factor (dB).
3. The other emission levels were very low against the limit.
4. Margin value = Emission level – Limit value.
5. " \* ": Fundamental frequency.
6. " # ": The radiated frequency is out of the restricted band.





CHANNEL	TX Channel 116	DETECTOR FUNCTION	Peak (PK)
FREQUENCY RANGE	1GHz ~ 40GHz		Average (AV)

ANTENNA POLARITY & TEST DISTANCE: HORIZONTAL AT 3 M								
NO.	FREQ. (MHz)	EMISSION LEVEL (dBuV/m)	LIMIT (dBuV/m)	MARGIN (dB)	ANTENNA HEIGHT (m)	TABLE ANGLE (Degree)	RAW VALUE (dBuV)	CORRECTION FACTOR (dB/m)
1	*5580.00	103.4 PK			1.00 H	221	62.97	40.43
2	*5580.00	87.3 AV			1.00 H	221	46.87	40.43
3	11160.00	54.3 PK	74.0	-19.7	1.00 H	306	7.36	46.94
4	11160.00	42.8 AV	54.0	-11.2	1.00 H	306	-4.14	46.94
ANTENNA POLARITY & TEST DISTANCE: VERTICAL AT 3 M								
NO.	FREQ. (MHz)	EMISSION LEVEL (dBuV/m)	LIMIT (dBuV/m)	MARGIN (dB)	ANTENNA HEIGHT (m)	TABLE ANGLE (Degree)	RAW VALUE (dBuV)	CORRECTION FACTOR (dB/m)
1	*5580.00	96.3 PK			1.00 V	210	55.87	40.43
2	*5580.00	74.9 AV			1.00 V	210	34.47	40.43
3	11160.00	52.1 PK	74.0	-21.9	1.00 V	142	5.16	46.94
4	11160.00	38.9 AV	54.0	-15.1	1.00 V	142	-8.04	46.94

REMARKS:

1. Emission level (dBuV/m) = Raw Value (dBuV) + Correction Factor (dB/m).
2. Correction Factor (dB/m) = Antenna Factor (dB/m) + Cable Factor (dB).
3. The other emission levels were very low against the limit.
4. Margin value = Emission level – Limit value.
5. " \* ": Fundamental frequency.



CHANNEL	TX Channel 140	DETECTOR FUNCTION	Peak (PK)
FREQUENCY RANGE	1GHz ~ 40GHz		Average (AV)

ANTENNA POLARITY & TEST DISTANCE: HORIZONTAL AT 3 M								
NO.	FREQ. (MHz)	EMISSION LEVEL (dBuV/m)	LIMIT (dBuV/m)	MARGIN (dB)	ANTENNA HEIGHT (m)	TABLE ANGLE (Degree)	RAW VALUE (dBuV)	CORRECTION FACTOR (dB/m)
1	*5700.00	103.6 PK			1.42 H	201	62.85	40.75
2	*5700.00	85.6 AV			1.42 H	201	44.85	40.75
3	#5725.00	65.1 PK	68.3	-3.2	1.00 H	214	24.29	40.81
4	11400.00	54.2 PK	74.0	-19.8	1.00 H	28	7.06	47.14
5	11400.00	41.1 AV	54.0	-12.9	1.00 H	28	-6.04	47.14
ANTENNA POLARITY & TEST DISTANCE: VERTICAL AT 3 M								
NO.	FREQ. (MHz)	EMISSION LEVEL (dBuV/m)	LIMIT (dBuV/m)	MARGIN (dB)	ANTENNA HEIGHT (m)	TABLE ANGLE (Degree)	RAW VALUE (dBuV)	CORRECTION FACTOR (dB/m)
1	*5700.00	96.4 PK			1.00 V	135	55.65	40.75
2	*5700.00	45.9 AV			1.00 V	135	5.15	40.75
3	#5725.00	54.6 PK	68.3	-13.7	1.00 V	214	13.79	40.81
4	11400.00	53.8 PK	74.0	-20.2	1.00 V	360	6.66	47.14
5	11400.00	39.7 AV	54.0	-14.3	1.00 V	360	-7.44	47.14

REMARKS:

1. Emission level (dBuV/m) = Raw Value (dBuV) + Correction Factor (dB/m).
2. Correction Factor (dB/m) = Antenna Factor (dB/m) + Cable Factor (dB).
3. The other emission levels were very low against the limit.
4. Margin value = Emission level – Limit value.
5. " \* ": Fundamental frequency.
6. " # ": The radiated frequency is out of the restricted band.



802.11n (40MHz)

CHANNEL	TX Channel 102	DETECTOR FUNCTION	Peak (PK)
FREQUENCY RANGE	1GHz ~ 40GHz		Average (AV)

ANTENNA POLARITY & TEST DISTANCE: HORIZONTAL AT 3 M								
NO.	FREQ. (MHz)	EMISSION LEVEL (dBuV/m)	LIMIT (dBuV/m)	MARGIN (dB)	ANTENNA HEIGHT (m)	TABLE ANGLE (Degree)	RAW VALUE (dBuV)	CORRECTION FACTOR (dB/m)
1	#5470.00	64.9 PK	68.3	-3.4	1.00 H	140	24.73	40.17
2	*5510.00	100.2 PK			1.00 H	360	59.95	40.25
3	*5510.00	74.3 AV			1.00 H	360	34.05	40.25
4	11020.00	53.2 PK	74.0	-20.8	1.00 H	26	6.38	46.82
5	11020.00	38.7 AV	54.0	-15.3	1.00 H	26	-8.12	46.82
ANTENNA POLARITY & TEST DISTANCE: VERTICAL AT 3 M								
NO.	FREQ. (MHz)	EMISSION LEVEL (dBuV/m)	LIMIT (dBuV/m)	MARGIN (dB)	ANTENNA HEIGHT (m)	TABLE ANGLE (Degree)	RAW VALUE (dBuV)	CORRECTION FACTOR (dB/m)
1	#5470.00	58.8 PK	68.3	-9.5	1.00 V	216	18.63	40.17
2	*5510.00	88.6 PK			1.00 V	214	48.35	40.25
3	*5510.00	65.6 AV			1.00 V	214	25.35	40.25
4	11020.00	52.4 PK	74.0	-21.6	1.00 V	219	5.58	46.82
5	11020.00	38.0 AV	54.0	-16.0	1.00 V	219	-8.82	46.82

REMARKS:

1. Emission level (dBuV/m) = Raw Value (dBuV) + Correction Factor (dB/m).
2. Correction Factor (dB/m) = Antenna Factor (dB/m) + Cable Factor (dB).
3. The other emission levels were very low against the limit.
4. Margin value = Emission level – Limit value.
5. " \* ": Fundamental frequency.
6. " # ": The radiated frequency is out of the restricted band.



CHANNEL	TX Channel 134	DETECTOR FUNCTION	Peak (PK)
FREQUENCY RANGE	1GHz ~ 40GHz		Average (AV)

ANTENNA POLARITY & TEST DISTANCE: HORIZONTAL AT 3 M								
NO.	FREQ. (MHz)	EMISSION LEVEL (dBuV/m)	LIMIT (dBuV/m)	MARGIN (dB)	ANTENNA HEIGHT (m)	TABLE ANGLE (Degree)	RAW VALUE (dBuV)	CORRECTION FACTOR (dB/m)
1	*5670.00	102.8 PK			1.00 H	114	62.13	40.67
2	*5670.00	78.6 AV			1.00 H	114	37.93	40.67
3	#5725.00	65.1 PK	68.3	-3.2	1.00 H	211	24.29	40.81
4	11340.00	55.4 PK	74.0	-18.6	1.00 H	314	8.31	47.09
5	11340.00	43.8 AV	54.0	-10.2	1.00 H	314	-3.29	47.09
ANTENNA POLARITY & TEST DISTANCE: VERTICAL AT 3 M								
NO.	FREQ. (MHz)	EMISSION LEVEL (dBuV/m)	LIMIT (dBuV/m)	MARGIN (dB)	ANTENNA HEIGHT (m)	TABLE ANGLE (Degree)	RAW VALUE (dBuV)	CORRECTION FACTOR (dB/m)
1	*5670.00	92.8 PK			1.00 V	214	52.13	40.67
2	*5670.00	75.6 AV			1.00 V	214	34.93	40.67
3	#5725.00	54.6 PK	68.3	-13.7	1.00 V	213	13.79	40.81
4	11340.00	54.6 PK	74.0	-19.4	1.00 V	342	7.51	47.09
5	11340.00	42.8 AV	54.0	-11.2	1.00 V	342	-4.29	47.09

REMARKS:

1. Emission level (dBuV/m) = Raw Value (dBuV) + Correction Factor (dB/m).
2. Correction Factor (dB/m) = Antenna Factor (dB/m) + Cable Factor (dB).
3. The other emission levels were very low against the limit.
4. Margin value = Emission level – Limit value.
5. " \* ": Fundamental frequency.
6. " # ": The radiated frequency is out of the restricted band.



## 4.2 CONDUCTED EMISSION MEASUREMENT

### 4.2.1 LIMITS OF CONDUCTED EMISSION MEASUREMENT

FREQUENCY OF EMISSION (MHz)	CONDUCTED LIMIT (dBμV)	
	Quasi-peak	Average
0.15 ~ 0.5	66 to 56	56 to 46
0.5 ~ 5	56	46
5 ~ 30	60	50

- NOTE:**
1. The lower limit shall apply at the transition frequencies.
  2. The limit decreases in line with the logarithm of the frequency in the range of 0.15 to 0.50MHz.
  3. All emanations from a class A/B digital device or system, including any network of conductors and apparatus connected thereto, shall not exceed the level of field strengths specified above.

### 4.2.2 TEST INSTRUMENTS

Equipment	Manufacturer	Model No.	Serial No.	Last Cal.	Next Cal.
EMI Test Receiver	Rohde&Schwarz	ESCI	100340	May 11,15	May 10,16
Artificial Mains Network	Rohde&Schwarz	ENV216	101173	May 11,15	May 10,16
Artificial Mains Network	Rohde&Schwarz	ESH3-Z5	100317	May 11,15	May 10,16
Test software	ADT	ADT_Cond_V7.3.7	N/A	N/A	N/A

- NOTE:**
1. The test was performed in shielded room 553.
  2. The calibration interval of the above test instruments is 12 months. And the calibrations are traceable to CEPREI/CHINA, GRGT/CHINA and NIM/CHINA.

### 4.2.3 TEST PROCEDURES

- a. The EUT was placed 0.4 meters from the conducting wall of the shielded room with EUT being connected to the power mains through a line impedance stabilization network (LISN). Other support units were connected to the power mains through another LISN. The two LISNs provide 50 ohm/ 50uH of coupling impedance for the measuring instrument.
- b. Both lines of the power mains connected to the EUT were checked for maximum conducted interference.
- c. The frequency range from 150kHz to 30MHz was searched. Emission levels under (Limit - 20dB) was not recorded.

**NOTE:** All modes of operation were investigated and the worst-case emissions are reported.



#### 4.2.4 DEVIATION FROM TEST STANDARD

No deviation.

#### 4.2.5 TEST SETUP

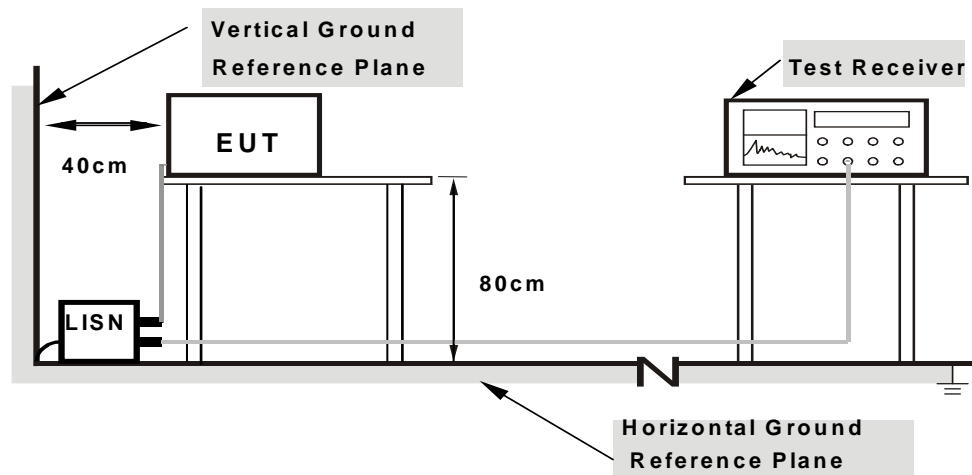

- Note:**
- 1.Support units were connected to second LISN.
  - 2.Both of LISNs (AMN) are 80 cm from EUT and at least 80 from other units and other metal planes

For the actual test configuration, please refer to the attached file (Test Setup Photo).

#### 4.2.6 EUT OPERATING CONDITIONS

Same as 4.1.6.



### 4.2.7 TEST RESULTS

#### CONDUCTED WORST-CASE DATA : 802.11a

<b>PHASE</b>	Line	<b>6dB BANDWIDTH</b>	9kHz
<b>CHANNEL</b>	Channel 36		

No	Freq. [MHz]	Corr. Factor (dB)	Reading Value [dB (uV)]		Emission Level [dB (uV)]		Limit [dB (uV)]		Margin (dB)	
			Q.P.	AV.	Q.P.	AV.	Q.P.	AV.	Q.P.	AV.
1	0.17744	10.71	23.20	9.57	33.91	20.28	64.60	54.60	-30.69	-34.32
<b>2</b>	<b>0.63856</b>	<b>10.46</b>	<b>32.99</b>	<b>24.48</b>	<b>43.45</b>	<b>34.94</b>	<b>56.00</b>	<b>46.00</b>	<b>-12.55</b>	<b>-11.06</b>
3	1.27608	10.19	24.16	10.38	34.35	20.57	56.00	46.00	-21.65	-25.43
4	1.96424	10.08	21.63	8.10	31.71	18.18	56.00	46.00	-24.29	-27.82
5	3.32492	10.10	23.96	8.08	34.06	18.18	56.00	46.00	-21.94	-27.82
6	23.45751	10.66	23.81	11.52	34.47	22.18	60.00	50.00	-25.53	-27.82

- REMARKS:**
1. Q.P. and AV. are abbreviations of quasi-peak and average individually.
  2. "-": The Quasi-peak reading value also meets average limit and measurement with the average detector is unnecessary.
  3. The emission levels of other frequencies were very low against the limit.
  4. Margin value = Emission level - Limit value
  5. Correction factor = Insertion loss + Cable loss
  6. Emission Level = Correction Factor + Reading Value.

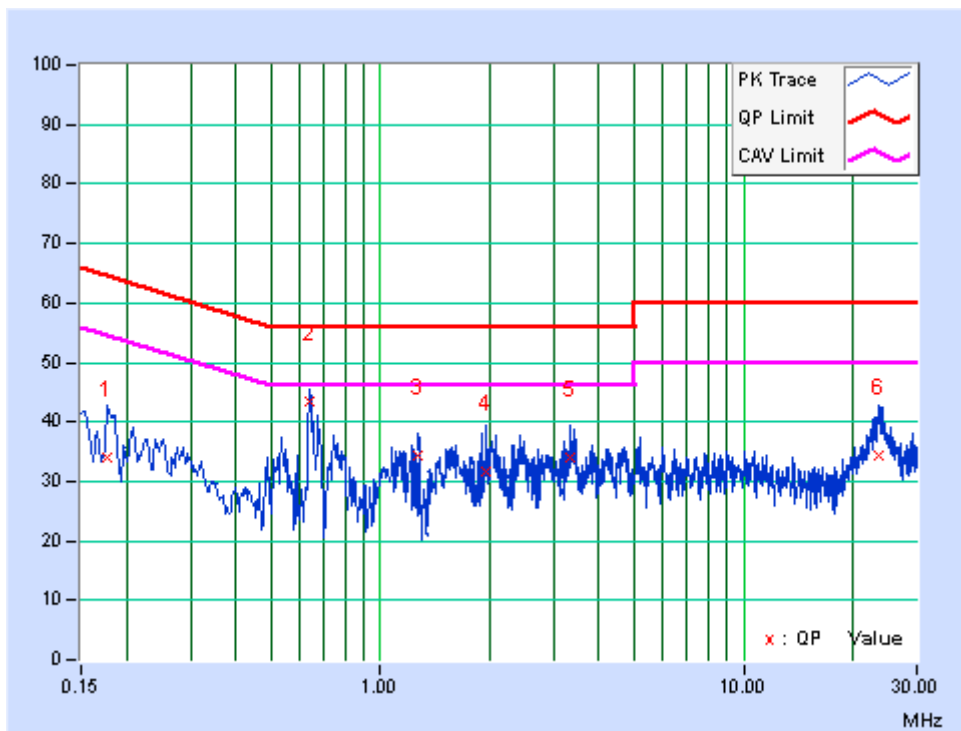



<b>PHASE</b>	Neutral	<b>6dB BANDWIDTH</b>	9kHz
<b>CHANNEL</b>	Channel 36		

No	Freq. [MHz]	Corr. Factor (dB)	Reading Value [dB (uV)]		Emission Level [dB (uV)]		Limit [dB (uV)]		Margin (dB)	
			Q.P.	AV.	Q.P.	AV.	Q.P.	AV.	Q.P.	AV.
1	0.15391	10.61	24.58	9.62	35.19	20.23	65.79	55.79	-30.59	-35.55
2	0.18122	10.56	22.92	7.59	33.48	18.15	64.43	54.43	-30.95	-36.28
3	0.63856	10.39	27.88	18.93	38.27	29.32	56.00	46.00	-17.73	-16.68
4	0.67394	10.35	24.71	13.05	35.06	23.40	56.00	46.00	-20.94	-22.60
5	1.52746	10.00	20.64	6.42	30.64	16.42	56.00	46.00	-25.36	-29.58
6	23.45751	10.53	29.77	10.76	40.30	21.29	60.00	50.00	-19.70	-28.71

- REMARKS:**
1. Q.P. and AV. are abbreviations of quasi-peak and average individually.
  2. "-": The Quasi-peak reading value also meets average limit and measurement with the average detector is unnecessary.
  3. The emission levels of other frequencies were very low against the limit.
  4. Margin value = Emission level - Limit value
  5. Correction factor = Insertion loss + Cable loss
  6. Emission Level = Correction Factor + Reading Value.

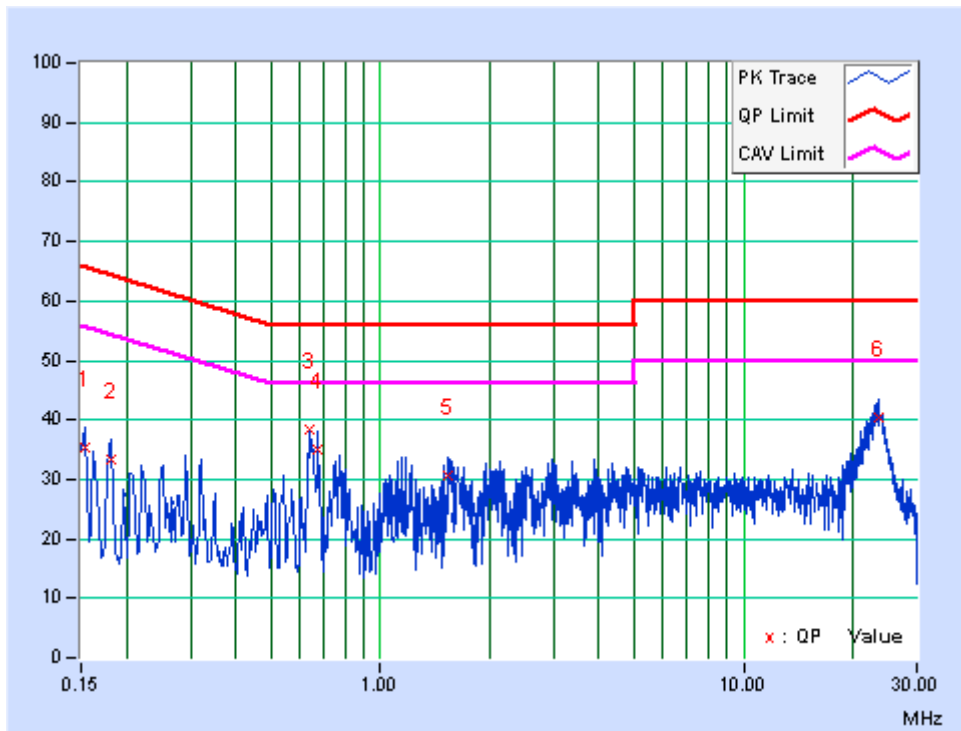





### 4.3 MAXIMUM CONDUCTED OUTPUT POWER MEASUREMENT

#### 4.3.1 LIMITS OF MAXIMUM CONDUCTED OUTPUT POWER MEASUREMENT

Operation Band	EUT Category		LIMIT
U-NII-1		Outdoor Access Point	1 Watt (30 dBm) (Max. e.i.r.p $\leq$ 125mW(21 dBm) at any elevation angle above 30 degrees as measured from the horizon)
		Fixed point-to-point Access Point	1 Watt (30 dBm)
		Indoor Access Point	1 Watt (30 dBm)
	√	Mobile and Portable client device	250mW (24 dBm)
U-NII-2A		√	250mW (24 dBm) or 11 dBm+10 log B*
U-NII-2C		√	250mW (24 dBm) or 11 dBm+10 log B*
U-NII-3		--	1 Watt (30 dBm)

**NOTE:** Where B is the 26dB emission bandwidth in MHz.

#### 4.3.2 TEST SETUP

##### FOR POWER OUTPUT MEASUREMENT

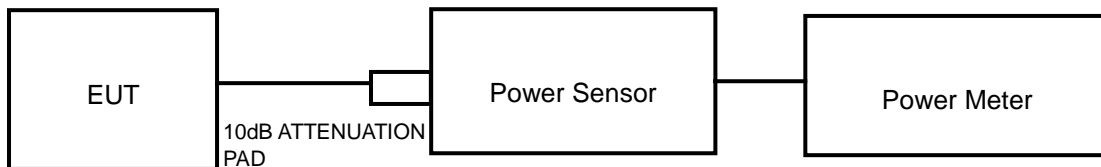

##### FOR 26dB BANDWIDTH

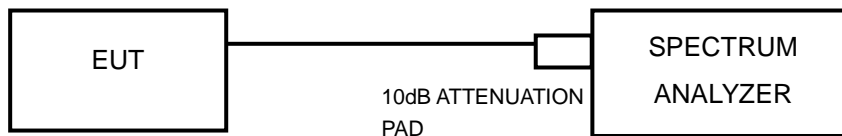



### 4.3.3 TEST INSTRUMENTS

Refer to section 4.1.3 to get information of above instrument.

### 4.3.4 TEST PROCEDURE

#### **FOR POWER MEASUREMENT**

Method PM is used to perform output power measurement, trigger and gating function of wide band power meter is enabled to measure max output power of TX on burst. Duty factor is not added to measured value.

#### **FOR 99 PERCENT OCCUPIED BANDWIDTH**

The following procedure shall be used for measuring (99 %) power bandwidth:

1. Set center frequency to the nominal EUT channel center frequency.
2. Set span = 1.5 times to 5.0 times the OBW.
3. Set RBW = 1 % to 5 % of the OBW
4. Set VBW  $\geq 3 \cdot$  RBW
5. Video averaging is not permitted. Where practical, a sample detection and single sweep mode shall be used. Otherwise, peak detection and max hold mode (until the trace stabilizes) shall be used.
6. Use the 99 % power bandwidth function of the instrument (if available).
7. If the instrument does not have a 99 % power bandwidth function, the trace data points are recovered and directly summed in power units. The recovered amplitude data points, beginning at the lowest frequency, are placed in a running sum until 0.5 % of the total is reached; that frequency is recorded as the lower frequency. The process is repeated until 99.5 % of the total is reached; that frequency is recorded as the upper frequency. The 99% occupied bandwidth is the difference between these two frequencies.



**FOR 26dB BANDWIDTH**

- 1) Set RBW = approximately 1% of the emission bandwidth.
- 2) Set the VBW > RBW.
- 3) Detector = Peak.
- 4) Trace mode = max hold.
- 5) Measure the maximum width of the emission that is 26 dB down from the peak of the emission. Compare this with the RBW setting of the analyzer. Readjust RBW and repeat measurement as needed until the RBW/EBW ratio is approximately 1%.

**4.3.5 DEVIATION FROM TEST STANDARD**

No deviation.

**4.3.6 EUT OPERATING CONDITIONS**

The software provided by client to enable the EUT under transmission condition continuously at specific channel frequencies individually.

**4.3.7 TEST RESULTS**

**OUTPUT POWER:**

**802.11a**

CHANNEL	CHANNEL FREQUENCY (MHz)	AVERAGE POWER (mW)	AVERAGE POWER (dBm)	POWER LIMIT (dBm)	PASS/FAIL
36	5180	6.699	8.26	24	PASS
40	5200	7.621	8.82	24	PASS
48	5240	7.194	8.57	24	PASS
52	5260	7.603	8.81	24	PASS
60	5300	7.362	8.67	24	PASS
64	5320	7.745	8.89	24	PASS
100	5500	7.691	8.86	24	PASS
116	5580	9.954	9.98	24	PASS
140	5700	9.354	9.71	24	PASS



**802.11n (20MHz)**

CHANNEL	CHANNEL FREQUENCY (MHz)	AVERAGE POWER (mW)	AVERAGE POWER (dBm)	POWER LIMIT (dBm)	PASS/FAIL
36	5180	6.486	8.12	24	PASS
40	5200	7.745	8.89	24	PASS
48	5240	7.261	8.61	24	PASS
52	5260	7.551	8.78	24	PASS
60	5300	7.228	8.59	24	PASS
64	5320	7.674	8.85	24	PASS
100	5500	7.656	8.84	24	PASS
116	5580	9.506	9.78	24	PASS
140	5700	8.892	9.49	24	PASS

**802.11n (40MHz)**

CHANNEL	CHANNEL FREQUENCY (MHz)	AVERAGE POWER (mW)	AVERAGE POWER (dBm)	POWER LIMIT (dBm)	PASS/FAIL
38	5190	8.054	9.06	24	PASS
46	5230	6.501	8.13	24	PASS
54	5270	7.586	8.80	24	PASS
62	5310	7.656	8.84	24	PASS
102	5510	8.035	9.05	24	PASS
110	5550	8.872	9.48	24	PASS
134	5670	9.078	9.58	24	PASS



**99% OCCUPIED BANDWIDTH & 26dB BANDWIDTH:**

**802.11a**

CHANNEL	CHANNEL FREQUENCY (MHz)	99% OCCUPIED BANDWIDTH	26dB BANDWIDTH (MHz)	PASS/FAIL
36	5180	16.61	20.22	PASS
40	5200	16.52	19.93	PASS
48	5240	16.52	20.38	PASS
52	5260	16.52	19.94	PASS
60	5300	16.61	20.57	PASS
64	5320	16.61	19.62	PASS
100	5500	16.52	20.57	PASS
116	5580	16.61	21.23	PASS
140	5700	16.44	20.45	PASS

**802.11n (20MHz)**

CHANNEL	CHANNEL FREQUENCY (MHz)	99% OCCUPIED BANDWIDTH	26dB BANDWIDTH (MHz)	PASS/FAIL
36	5180	17.64	20.94	PASS
40	5200	17.64	20.70	PASS
48	5240	17.76	21.15	PASS
52	5260	17.76	21.19	PASS
60	5300	17.76	20.87	PASS
64	5320	17.64	20.58	PASS
100	5500	17.76	20.78	PASS
116	5580	17.64	21.46	PASS
140	5700	17.88	20.77	PASS



802.11n (40MHz)

CHANNEL	CHANNEL FREQUENCY (MHz)	99% OCCUPIED BANDWIDTH	26dB BANDWIDTH (MHz)	PASS/FAIL
38	5190	36.40	42.95	PASS
46	5230	36.40	42.87	PASS
54	5270	36.40	43.40	PASS
62	5310	36.40	44.06	PASS
102	5510	36.40	43.19	PASS
110	5550	36.40	43.90	PASS
134	5670	36.40	42.83	PASS



**BUREAU  
VERITAS**

Test Report No.: RF150522N017-6

For 5180~5240MHz

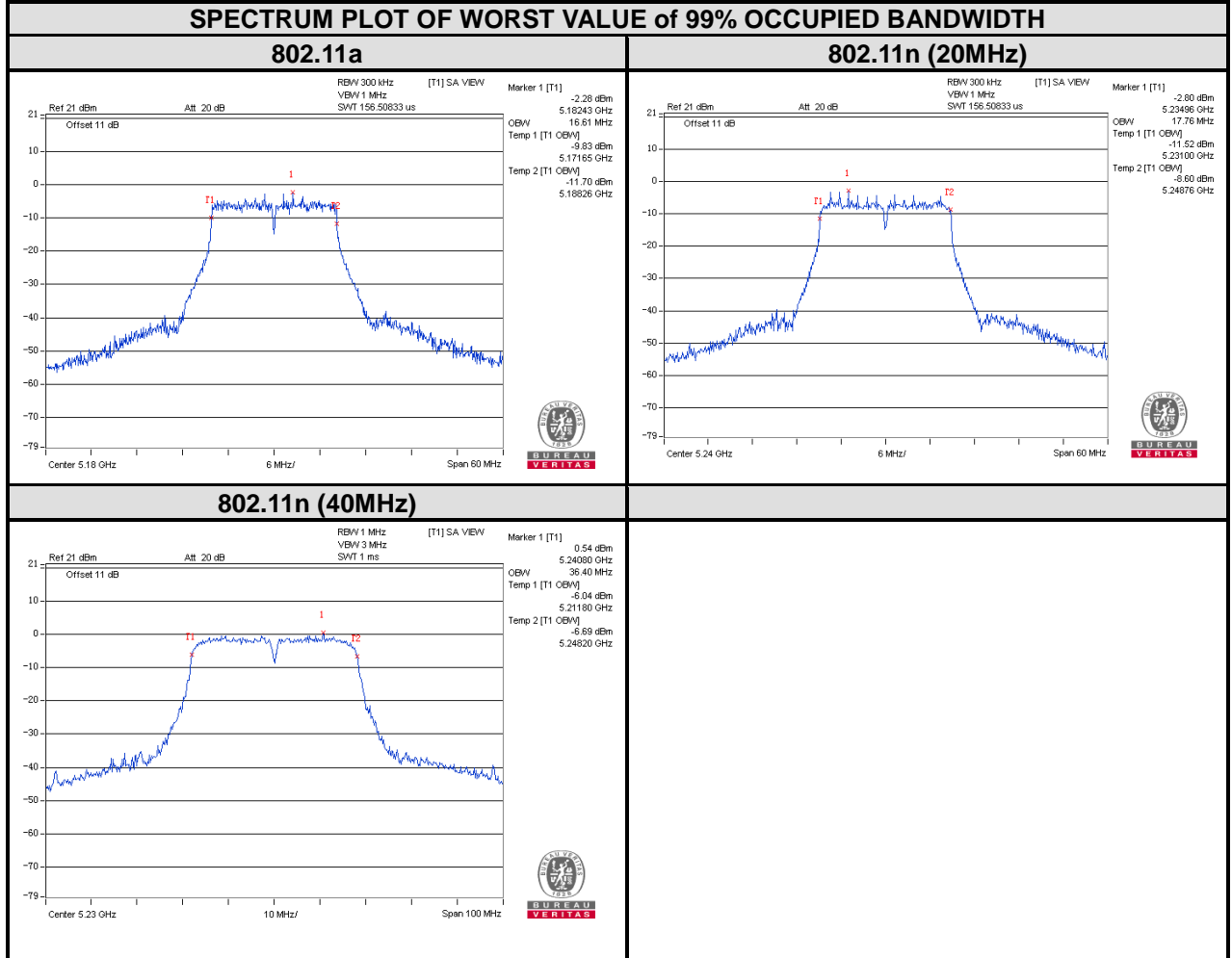

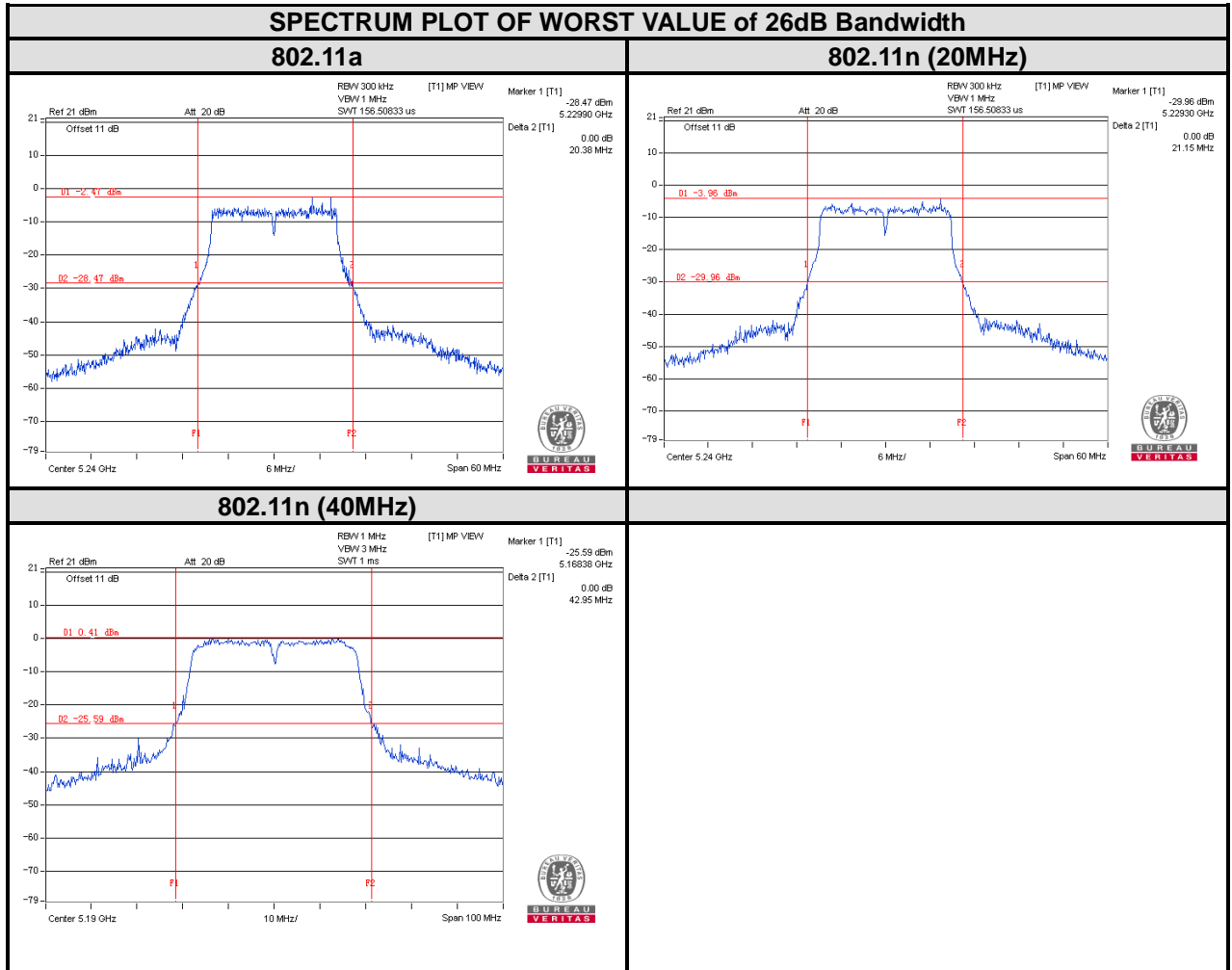





**BUREAU  
VERITAS**

Test Report No.: RF150522N017-6

For 5260~5320MHz

**SPECTRUM PLOT OF WORST VALUE of 99% OCCUPIED BANDWIDTH**

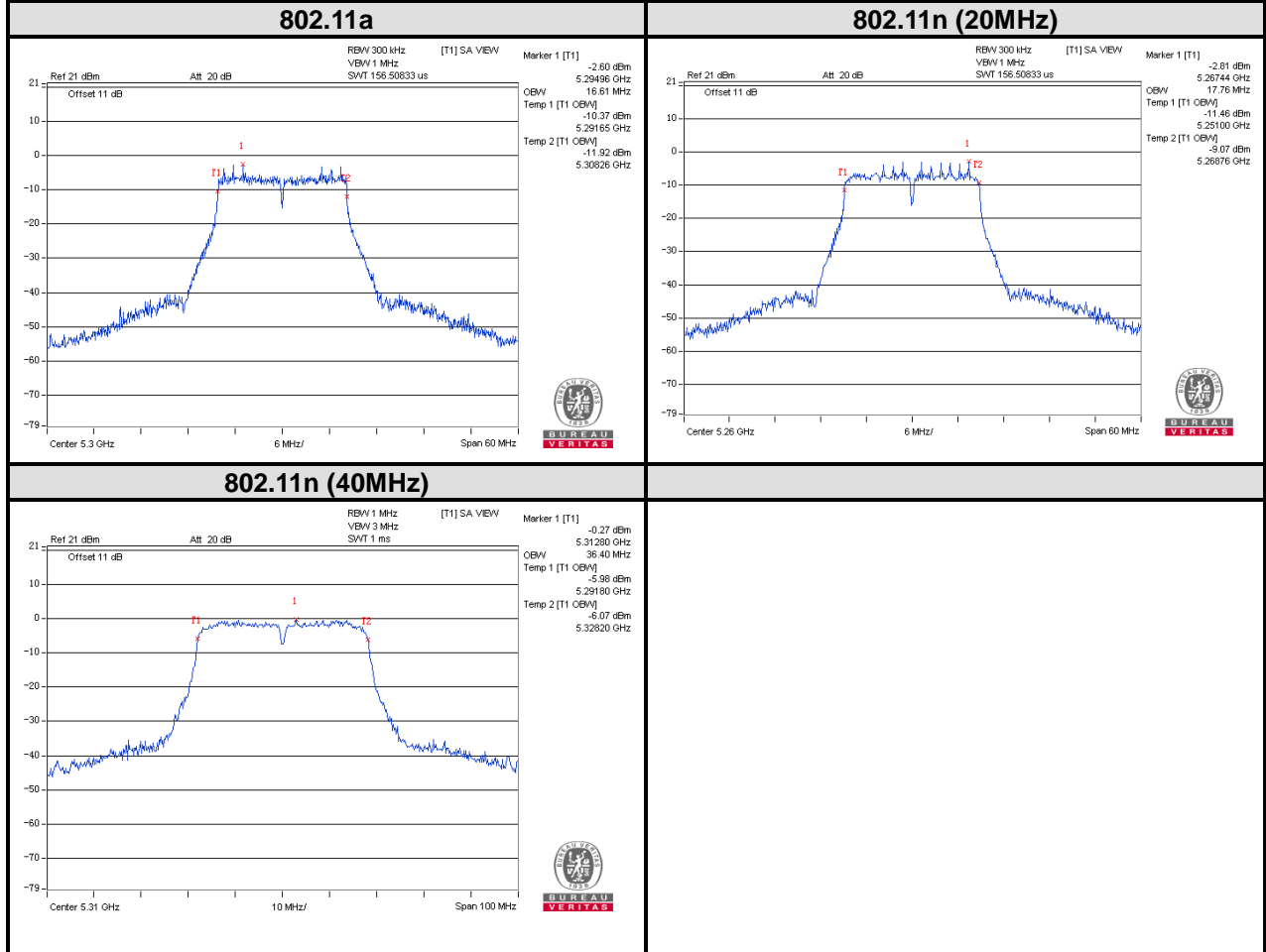



BUREAU VERITAS

Test Report No.: RF150522N017-6

### SPECTRUM PLOT OF WORST VALUE of 26dB Bandwidth

#### 802.11a

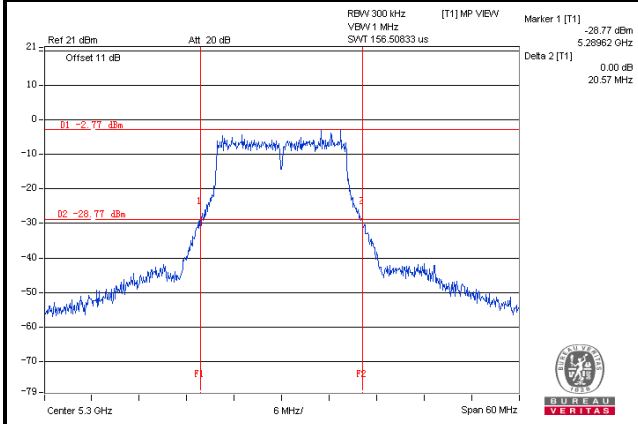

#### 802.11n (20MHz)

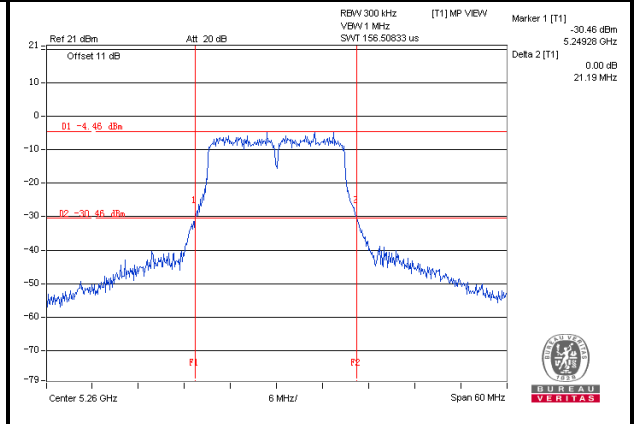

#### 802.11n (40MHz)

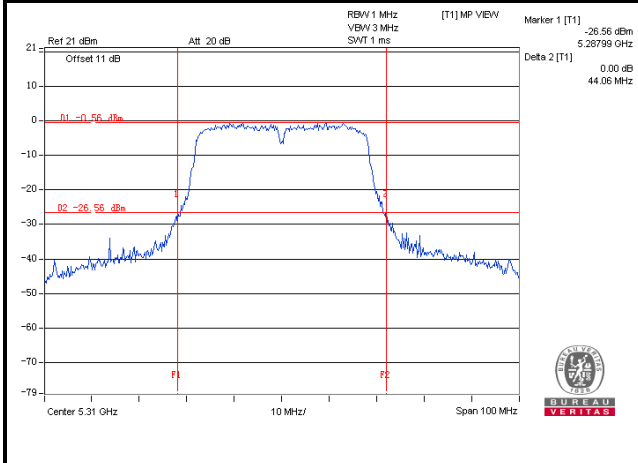



BUREAU VERITAS

Test Report No.: RF150522N017-6

For 5500~5700MHz

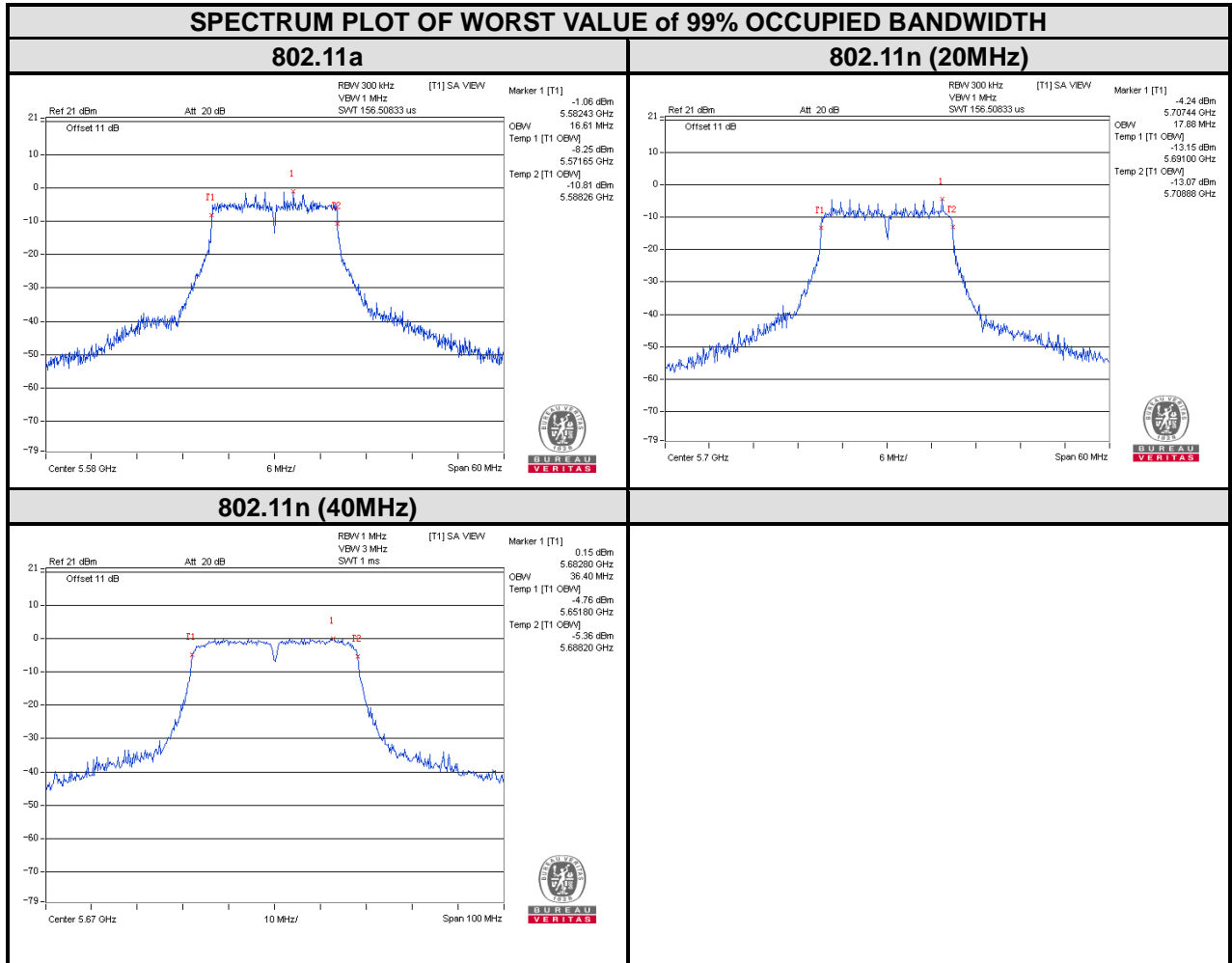

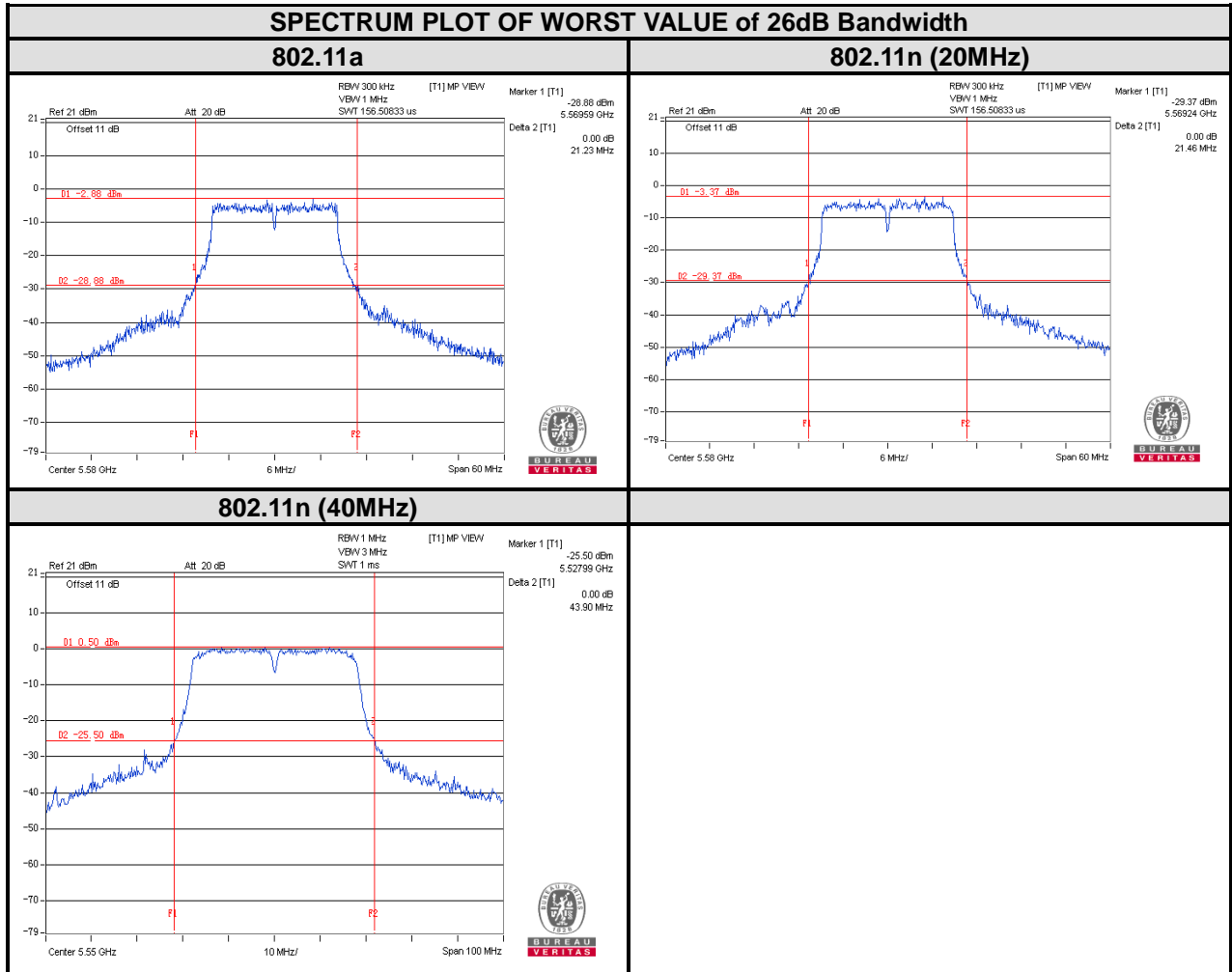



#### 4.4 PEAK POWER SPECTRAL DENSITY MEASUREMENT

##### 4.4.1 LIMITS OF PEAK POWER SPECTRAL DENSITY MEASUREMENT

Operation Band	EUT Category		LIMIT
U-NII-1		Outdoor Access Point	17dBm/ MHz
		Fixed point-to-point Access Point	
		Indoor Access Point	
	√	Mobile and Portable client device	11dBm/ MHz
U-NII-2A	√		11dBm/ MHz
U-NII-2C	√		11dBm/ MHz
U-NII-3	--		30dBm/ 500kHz

##### 4.4.2 TEST SETUP

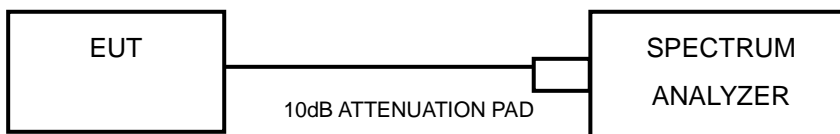

##### 4.4.3 TEST INSTRUMENTS

Refer to section 4.1.3 to get information of above instrument.

##### 4.4.4 TEST PROCEDURES

Using method SA-1

- 1) Set span to encompass the entire emission bandwidth (EBW) of the signal.
- 2) Set RBW = 30 KHz, Set VBW ≥ 1 MHz, Detector = RMS
- 3) Set Channel power measure = 1MHz
- 4) Sweep time = auto, trigger set to “free run”.
- 5) Trace average at least 100 traces in power averaging mode.
- 6) Record the max value



#### 4.4.5 DEVIATION FROM TEST STANDARD

No deviation.

#### 4.4.6 EUT OPERATING CONDITIONS

Same as 4.1.6.

#### 4.4.7 TEST RESULTS

**For U-NII-1, U-NII-2A & U-NII-2C:**

##### 802.11a

CHANNEL	FREQUENCY (MHz)	PSD w/o Duty Factor (dBm/MHz)	Duty Factor	PSD with Duty Factor (dBm/MHz)	MAXIMUM LIMIT (dBm/MHz)	PASS/FAIL
36	5180	5.63	0.59	6.22	11	PASS
40	5200	5.58	0.59	6.17	11	PASS
48	5240	5.24	0.59	5.83	11	PASS
52	5260	5.01	0.59	5.60	11	PASS
60	5300	5.06	0.59	5.65	11	PASS
64	5320	5.86	0.59	6.45	11	PASS
100	5500	5.65	0.59	6.24	11	PASS
116	5580	6.21	0.59	6.80	11	PASS
140	5700	4.31	0.59	4.90	11	PASS



**802.11n (20MHz)**

CHANNEL	FREQUENCY (MHz)	PSD w/o Duty Factor (dBm/MHz)	Duty Factor	PSD with Duty Factor (dBm/MHz)	MAXIMUM LIMIT (dBm/MHz)	PASS/FAIL
36	5180	5.25	0.65	5.90	11	PASS
40	5200	5.26	0.65	5.91	11	PASS
48	5240	4.79	0.65	5.44	11	PASS
52	5260	4.57	0.65	5.22	11	PASS
60	5300	5.42	0.65	6.07	11	PASS
64	5320	6.01	0.65	6.66	11	PASS
100	5500	5.03	0.65	5.68	11	PASS
116	5580	4.26	0.65	4.91	11	PASS
140	5700	4.36	0.65	5.01	11	PASS

**802.11n (40MHz)**

CHANNEL	FREQUENCY (MHz)	PSD w/o Duty Factor (dBm/MHz)	Duty Factor	PSD with Duty Factor (dBm/MHz)	MAXIMUM LIMIT (dBm/MHz)	PASS/FAIL
38	5190	2.64	1.19	3.83	11	PASS
46	5230	3.06	1.19	4.25	11	PASS
54	5270	2.63	1.19	3.82	11	PASS
62	5310	2.66	1.19	3.85	11	PASS
102	5510	3.26	1.19	4.45	11	PASS
110	5550	3.09	1.19	4.28	11	PASS
134	5670	2.82	1.19	4.01	11	PASS



BUREAU VERITAS

Test Report No.: RF150522N017-6

For 5180~5240MHz

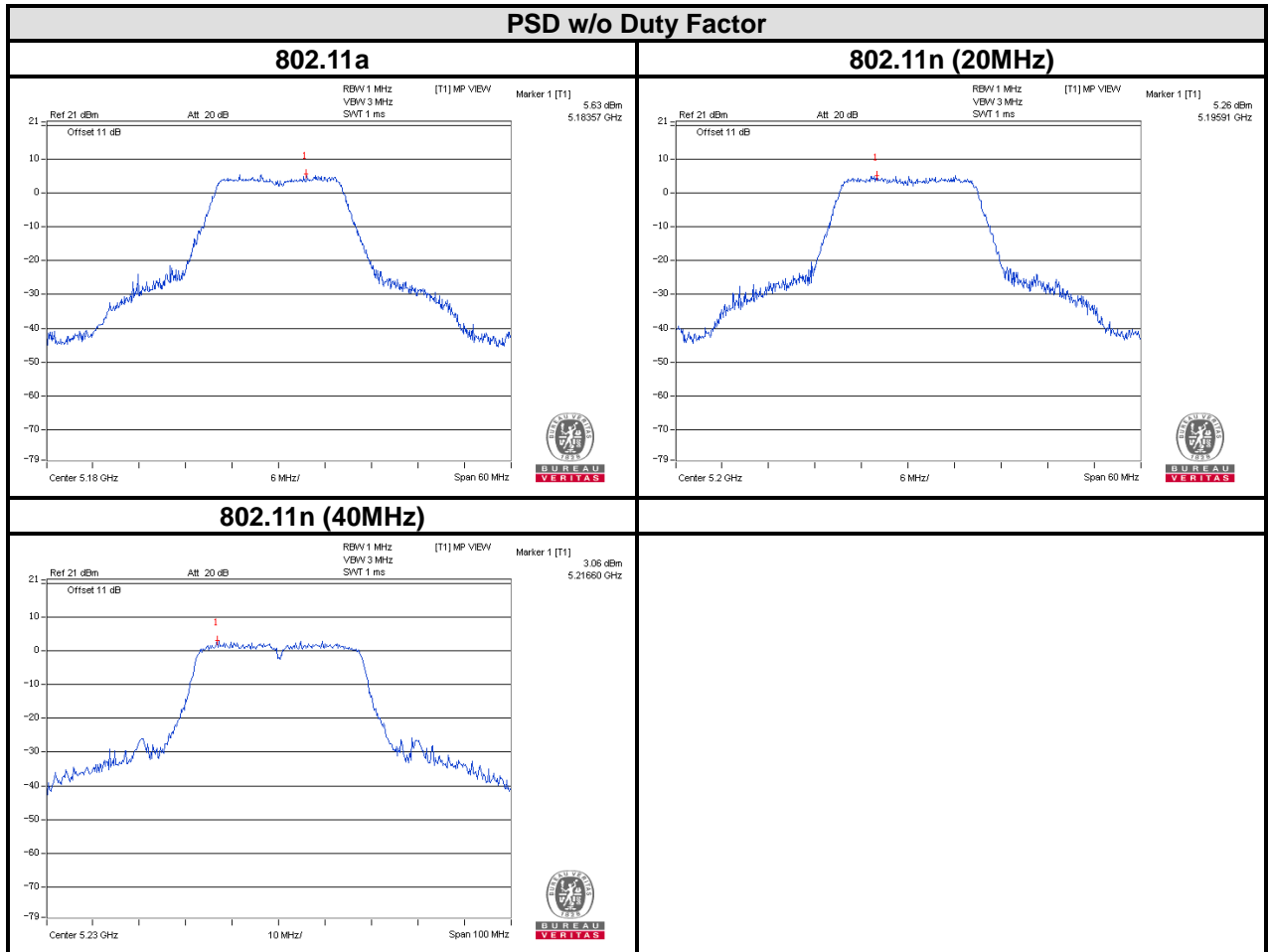





**BUREAU  
VERITAS**

Test Report No.: RF150522N017-6

For 5260~5320MHz

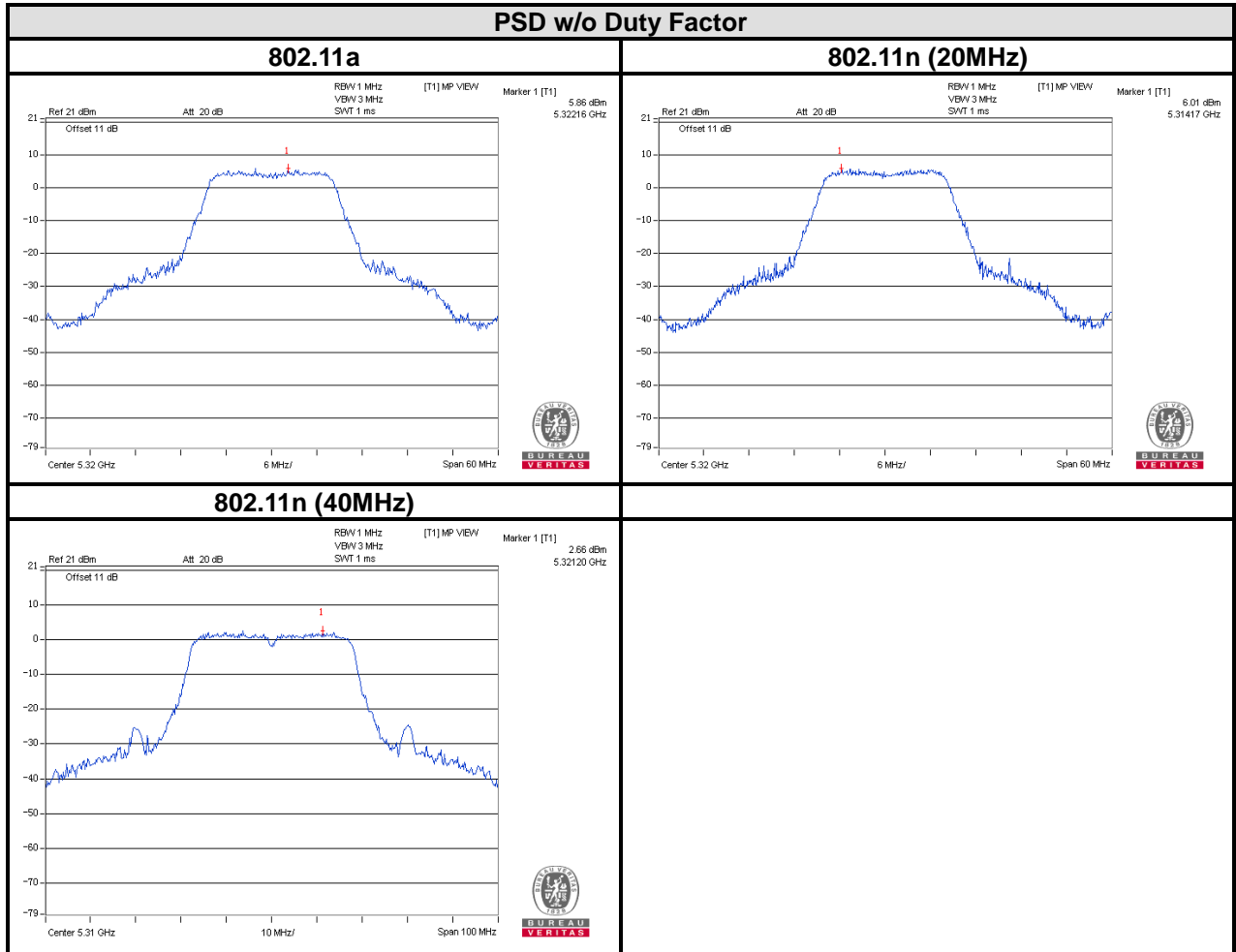



**BUREAU  
VERITAS**

Test Report No.: RF150522N017-6

For 5500~5700MHz

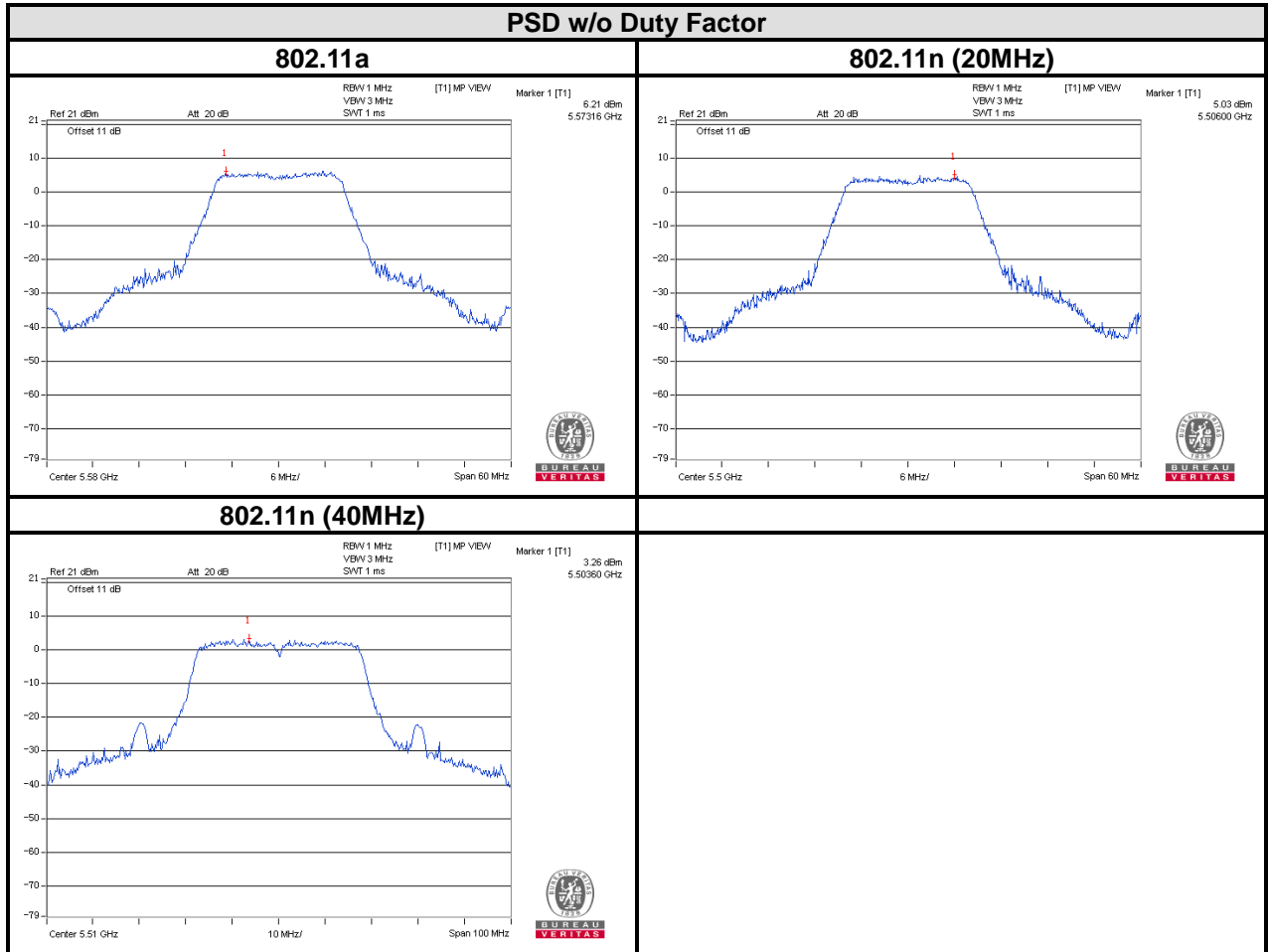



## 4.5 FREQUENCY STABILITY

### 4.5.1 LIMITS OF FREQUENCY STABILITY MEASUREMENT

The frequency of the carrier signal shall be maintained within band of operation

### 4.5.2 TEST SETUP

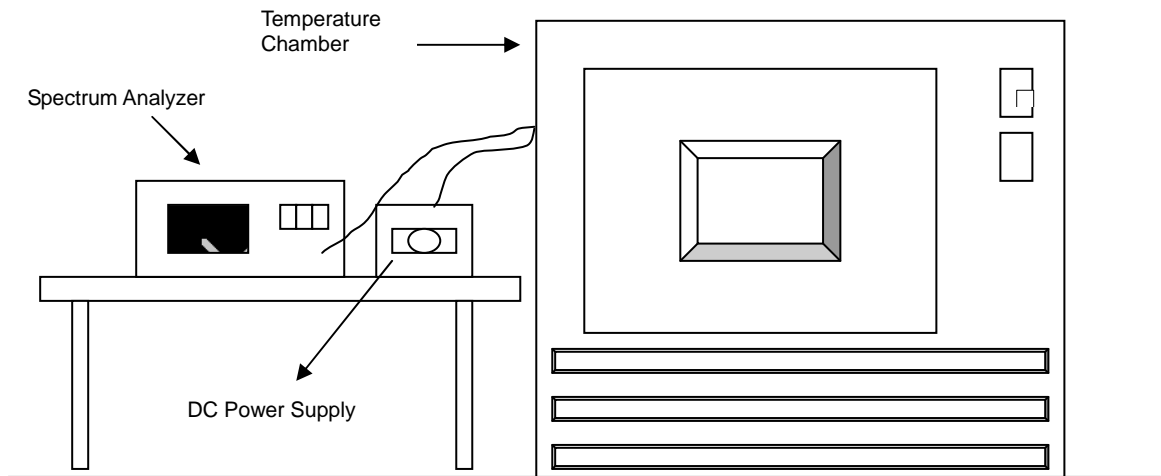

### 4.5.3 TEST INSTRUMENTS

Refer to section 4.1.3 to get information of above instrument.



#### 4.5.4 TEST PROCEDURE

- a. The EUT was placed inside the environmental test chamber and powered by nominal DC voltage.
- b. Turn the EUT on and couple its output to a spectrum analyzer.
- c. Turn the EUT off and set the chamber to the highest temperature specified.
- d. Allow sufficient time (approximately 30 min) for the temperature of the chamber to stabilize, turn the EUT on and measure the operating frequency after 2, 5, and 10 minutes.
- e. Repeat step 2 and 3 with the temperature chamber set to the lowest temperature.
- f. The test chamber was allowed to stabilize at +20 degree C for a minimum of 30 minutes. The supply voltage was then adjusted on the EUT from 85% to 115% and the frequency record.

#### 4.5.5 DEVIATION FROM TEST STANDARD

No deviation.

#### 4.5.6 EUT OPERATING CONDITION

Set the EUT transmit at un-modulation mode to test frequency stability.



**4.5.7 TEST RESULTS**

FREQUENCY STABILITY VERSUS TEMP.									
OPERATING FREQUENCY: 5200MHz									
TEMP. (°C)	POWER SUPPLY (Vdc)	0 MINUTE		2 MINUTES		5 MINUTES		10 MINUTE	
		Measured Frequency (MHz)	Frequency Drift (%)	Measured Frequency (MHz)	Frequency Drift (%)	Measured Frequency (MHz)	Frequency Drift (%)	Measured Frequency (MHz)	Frequency Drift (%)
50	3.8	5199.9834	-3.192	5199.9912	-1.692	5199.9914	-1.654	5199.9913	-1.673
40	3.8	5199.9832	-3.231	5199.9899	-1.942	5199.9914	-1.654	5199.9903	-1.865
30	3.8	5199.9834	-3.192	5199.9895	-2.019	5199.9897	-1.981	5199.9919	-1.558
20	3.8	5200.002	0.385	5200.005	0.962	5200.0079	1.519	5200.0067	1.288
10	3.8	5199.9904	-1.846	5199.9902	-1.885	5199.9863	-2.635	5199.9943	-1.096
0	3.8	5199.9915	-1.635	5199.9887	-2.173	5199.9875	-2.404	5199.9938	-1.192
-10	3.8	5199.9788	-4.077	5199.9768	-4.462	5199.9775	-4.327	5199.9795	-3.942
-20	3.8	5199.9785	-4.135	5199.9765	-4.519	5199.977	-4.423	5199.9815	-3.558
-30	3.8	5199.978	-4.231	5199.9766	-4.500	5199.976	-4.615	5199.9812	-3.615

FREQUENCY STABILITY VERSUS VOLTAGE									
OPERATING FREQUENCY: 5200MHz									
TEMP. (°C)	POWER SUPPLY (Vdc)	0 MINUTE		2 MINUTE		5 MINUTE		10 MINUTE	
		Measured Frequency (MHz)	Frequency Drift (%)	Measured Frequency (MHz)	Frequency Drift (%)	Measured Frequency (MHz)	Frequency Drift (%)	Measured Frequency (MHz)	Frequency Drift (%)
20	4.35	5200.001	0.192	5200.0055	1.058	5200.0088	1.692	5200.0051	0.981
	3.8	5200.002	0.385	5200.005	0.962	5200.0079	1.519	5200.0067	1.288
	3.5	5200.0011	0.212	5200.0043	0.827	5200.0083	1.596	5200.0054	1.038



FREQUENCY STABILITY VERSUS TEMP.									
OPERATING FREQUENCY: 5320MHz									
TEMP. (°C)	POWER SUPPLY (Vdc)	0 MINUTE		2 MINUTES		5 MINUTES		10 MINUTE	
		Measured Frequency (MHz)	Frequency Drift (%)	Measured Frequency (MHz)	Frequency Drift (%)	Measured Frequency (MHz)	Frequency Drift (%)	Measured Frequency (MHz)	Frequency Drift (%)
50	3.8	5319.9868	-2.4812	5319.9792	-3.9098	5319.9779	-4.1541	5319.9878	-2.2932
40	3.8	5319.9875	-2.3496	5319.981	-3.5714	5319.9785	-4.0414	5319.9868	-2.4812
30	3.8	5319.987	-2.4436	5319.9809	-3.5902	5319.979	-3.9474	5319.9867	-2.5000
20	3.8	5320.0157	2.9511	5320.0117	2.1992	5320.0126	2.3684	5320.0145	2.7256
10	3.8	5319.9723	-5.2068	5319.973	-5.0752	5319.9731	-5.0564	5319.9754	-4.6241
0	3.8	5319.9724	-5.1880	5319.9728	-5.1128	5319.9735	-4.9812	5319.9768	-4.3609
-10	3.8	5320.0223	4.1917	5320.0199	3.7406	5320.0238	4.4737	5320.0253	4.7556
-20	3.8	5320.0217	4.0789	5320.0199	3.7406	5320.0226	4.2481	5320.0243	4.5677
-30	3.8	5320.0217	4.0789	5320.0199	3.7406	5320.0237	4.4549	5320.0258	4.8496

FREQUENCY STABILITY VERSUS VOLTAGE									
OPERATING FREQUENCY: 5320MHz									
TEMP. (°C)	POWER SUPPLY (Vdc)	0 MINUTE		2 MINUTE		5 MINUTE		10 MINUTE	
		Measured Frequency (MHz)	Frequency Drift (%)	Measured Frequency (MHz)	Frequency Drift (%)	Measured Frequency (MHz)	Frequency Drift (%)	Measured Frequency (MHz)	Frequency Drift (%)
20	4.35	5320.0173	3.2519	5320.0123	2.3120	5320.0127	2.3872	5320.0155	2.9135
	3.8	5320.0157	2.9511	5320.0117	2.1992	5320.0126	2.3684	5320.0145	2.7256
	3.5	5320.0156	2.9323	5320.0117	2.1992	5320.0128	2.4060	5320.0152	2.8571



FREQUENCY STABILITY VERSUS TEMP.									
OPERATING FREQUENCY: 5580MHz									
TEMP. (°C)	POWER SUPPLY (Vdc)	0 MINUTE		2 MINUTES		5 MINUTES		10 MINUTE	
		Measured Frequency (MHz)	Frequency Drift (%)	Measured Frequency (MHz)	Frequency Drift (%)	Measured Frequency (MHz)	Frequency Drift (%)	Measured Frequency (MHz)	Frequency Drift (%)
50	3.8	5580.0191	3.4229	5580.0129	2.3118	5580.0122	2.1864	5580.0131	2.3477
40	3.8	5580.0192	3.4409	5580.0122	2.1864	5580.0121	2.1685	5580.0129	2.3118
30	3.8	5580.0183	3.2796	5580.0139	2.4910	5580.0129	2.3118	5580.0138	2.4731
20	3.8	5579.994	-1.0753	5579.9928	-1.2903	5579.9979	-0.3763	5579.9928	-1.2903
10	3.8	5579.9986	-0.2509	5580.0008	0.1434	5579.9982	-0.3226	5579.9969	-0.5556
0	3.8	5580.0005	0.0896	5579.9993	-0.1254	5579.9984	-0.2867	5579.998	-0.3584
-10	3.8	5580.0051	0.9140	5580.0078	1.3978	5580.0052	0.9319	5580.0022	0.3943
-20	3.8	5580.006	1.0753	5580.0081	1.4516	5580.0042	0.7527	5580.0019	0.3405
-30	3.8	5580.005	0.8961	5580.0076	1.3620	5580.0039	0.6989	5580.0018	0.3226

FREQUENCY STABILITY VERSUS VOLTAGE									
OPERATING FREQUENCY: 5580MHz									
TEMP. (°C)	POWER SUPPLY (Vdc)	0 MINUTE		2 MINUTE		5 MINUTE		10 MINUTE	
		Measured Frequency (MHz)	Frequency Drift (%)	Measured Frequency (MHz)	Frequency Drift (%)	Measured Frequency (MHz)	Frequency Drift (%)	Measured Frequency (MHz)	Frequency Drift (%)
20	4.35	5579.9938	-1.1111	5579.9934	-1.1828	5579.9991	-0.1613	5579.9933	-1.2007
	3.8	5579.994	-1.0753	5579.9928	-1.2903	5579.9979	-0.3763	5579.9928	-1.2903
	3.5	5579.9937	-1.1290	5579.9932	-1.2186	5579.9984	-0.2867	5579.9921	-1.4158



## 5 PHOTOGRAPHS OF THE TEST CONFIGURATION

Please refer to the attached file (Test Setup Photo).





## 6 APPENDIX A – MODIFICATIONS RECORDERS FOR ENGINEERING CHANGES TO THE EUT BY THE LAB

No modifications were made to the EUT by the lab during the test.

---END---