



FCC SAR Test Report

Report No. : SA141215C19B
 Applicant : Sonim Technologies, Inc.
 Address : 1825 S. Grant St., Suite 200., San Mateo,CA,94402
 Product : LTE Smartphone
 FCC ID : WYPL14V012AA
 Type Number : L14V012AA
 Brand : Sonim
 Model No. : XP7700
 Standards : FCC 47 CFR Part 2 (2.1093) / IEEE C95.1:1992 / IEEE 1528:2003
 IEEE 1528a-2005 / KDB 865664 D01 v01r03 / KDB 865664 D02 v01r01
 KDB 248227 D01 v02 / KDB 447498 D01 v05r02 / KDB 648474 D04 v01r02
 / KDB 941225 D01 v03 / KDB 941225 D05 v02r03 / KDB 941225 D06 v02
 Sample Received Date : May 22, 2015
 Date of Testing : May 26, 2015 ~ Jun. 07, 2015

CERTIFICATION: The above equipment have been tested by **Bureau Veritas Consumer Products Services (H.K.) Ltd., Taoyuan Branch – Lin Kou Laboratories**, and found compliance with the requirement of the above standards. The test record, data evaluation & Equipment Under Test (EUT) configurations represented herein are true and accurate accounts of the measurements of the sample’s SAR characteristics under the conditions specified in this report. It should not be reproduced except in full, without the written approval of our laboratory. The client should not use it to claim product certification, approval, or endorsement by TAF or any government agencies.

Prepared By : Gina Liu
 Gina Liu / Specialist
 Approved By : Gordon Lin
 Gordon Lin / Assistant Manager



This report is for your exclusive use. Any copying or replication of this report to or for any other person or entity, or use of our name or trademark, is permitted only with our prior written permission. This report sets forth our findings solely with respect to the test samples identified herein. The results set forth in this report are not indicative or representative of the quality or characteristics of the lot from which a test sample was taken or any similar or identical product unless specifically and expressly noted. Our report includes all of the tests requested by you and the results thereof based upon the information that you provided to us. You have 60 days from date of issuance of this report to notify us of any material error or omission caused by our negligence, provided, however, that such notice shall be in writing and shall specifically address the issue you wish to raise. A failure to raise such issue within the prescribed time shall constitute your unqualified acceptance of the completeness of this report, the tests conducted and the correctness of the report contents. Unless specific mention, the uncertainty of measurement has been explicitly taken into account to declare the compliance or non-compliance to the specification.



Table of Contents

Release Control Record	3
1. Summary of Maximum SAR Value	4
2. Description of Equipment Under Test	5
3. SAR Measurement System	6
3.1 Definition of Specific Absorption Rate (SAR)	6
3.2 SPEAG DASY System	6
3.2.1 Robot.....	7
3.2.2 Probes.....	8
3.2.3 Data Acquisition Electronics (DAE)	8
3.2.4 Phantoms	9
3.2.5 Device Holder.....	10
3.2.6 System Validation Dipoles.....	10
3.2.7 Tissue Simulating Liquids.....	11
3.3 SAR System Verification	14
3.4 SAR Measurement Procedure	15
3.4.1 Area & Zoom Scan Procedure	15
3.4.2 Volume Scan Procedure.....	15
3.4.3 Power Drift Monitoring.....	16
3.4.4 Spatial Peak SAR Evaluation	16
3.4.5 SAR Averaged Methods	16
4. SAR Measurement Evaluation	17
4.1 EUT Configuration and Setting.....	17
4.2 EUT Testing Position	19
4.2.1 Head Exposure Conditions.....	19
4.2.2 Body-Worn Accessory Exposure Conditions	21
4.2.3 Hotspot Mode Exposure conditions.....	22
4.2.4 Extremity Exposure conditions	23
4.2.5 SAR Test Exclusions	23
4.3 Tissue Verification	24
4.4 System Validation.....	24
4.5 System Verification.....	25
4.6 Maximum Output Power.....	26
4.6.1 Maximum Conducted Power	26
4.6.2 Measured Conducted Power Result.....	27
4.7 SAR Testing Results	30
4.7.1 SAR Results for Head	30
4.7.2 SAR Results for Body-Worn (Separation Distance is 1.0 cm Gap)	32
4.7.3 SAR Results for Hotspot (Separation Distance is 1.0 cm Gap).....	34
4.7.4 SAR Measurement Variability.....	36
4.7.5 Simultaneous Multi-band Transmission Evaluation	37
5. Calibration of Test Equipment.....	43
6. Measurement Uncertainty.....	44
7. Information on the Testing Laboratories.....	46
Appendix A. SAR Plots of System Verification	
Appendix B. SAR Plots of SAR Measurement	
Appendix C. Calibration Certificate for Probe and Dipole	
Appendix D. Photographs of EUT and Setup	



FCC SAR Test Report

1. Summary of Maximum SAR Value

Equipment Class	Mode	Highest Reported Head SAR _{1g} (W/kg)	Highest Reported Body-Worn SAR _{1g} Body SAR _{1g} (1.0 cm Gap) (W/kg)	Highest Reported Hotspot SAR _{1g} (1.0 cm Gap) (W/kg)
PCE	GSM850	0.93	0.95	0.95
	GSM1900	0.38	0.48	0.56
	WCDMA II	0.44	0.60	0.67
	WCDMA V	0.51	0.53	0.53
	LTE 7	0.15	0.41	1.17
DTS	2.4G WLAN	0.01	0.01	0.01
NII	5.2G WLAN	0.00	N/A	N/A
	5.6G WLAN	0.00	N/A	N/A
DSS	Bluetooth	N/A	N/A	N/A
DXX	NFC	N/A	N/A	N/A
Highest Simultaneous Transmission SAR		Head (W/kg)	Body-Worn (W/kg)	Hotspot (W/kg)
PCE+DTS		0.93	0.95	1.17
PCE+NII		0.93	1.27	1.49
PCE+DSS		N/A	1.16	N/A

Note:

- The SAR limit (**Head & Body: SAR_{1g} 1.6 W/kg**) for general population / uncontrolled exposure is specified in FCC 47 CFR part 2 (2.1093) and ANSI/IEEE C95.1-1992.



FCC SAR Test Report

2. Description of Equipment Under Test

EUT Type	LTE Smartphone
FCC ID	WYPL14V012AA
Brand Name	Sonim
Model Name	XP7700
Tx Frequency Bands (Unit: MHz)	GSM850 : 824.2 ~ 848.8 GSM1900 : 1850.2 ~ 1909.8 WCDMA Band II : 1852.4 ~ 1907.6 WCDMA Band V : 826.4 ~ 846.6 LTE Band 7 : 2502.5 ~ 2567.5 (5M), 2505 ~ 2565 (10M), 2507.5 ~ 2562.5 (15M), 2510 ~ 2560 (20M) WLAN : 2412 ~ 2462, 5180 ~ 5240, 5260 ~ 5320, 5500 ~ 5700 Bluetooth : 2402 ~ 2480 NFC : 13.56
Uplink Modulations	GSM & GPRS : GMSK EDGE : 8PSK WCDMA : QPSK LTE : QPSK, 16QAM 802.11b : DSSS 802.11a/g/n : OFDM Bluetooth : GFSK NFC : ASK
Maximum Tune-up Conducted Power (Unit: dBm)	GSM850 : 33.5 GSM1900 : 31.0 WCDMA Band II : 24.0 WCDMA Band V : 23.0 LTE Band 7 : 20.9 WLAN 2.4G : 15.0 WLAN 5.2G : 9.5 WLAN 5.3G : 9.0 WLAN 5.6G : 10.0 Bluetooth : 10.0
Antenna Type	Fixed Internal Antenna
EUT Stage	Identical Prototype

Note:

- The above EUT information is declared by manufacturer and for more detailed features description please refers to the manufacturer's specifications or User's Manual.

List of Accessory:

Battery	Brand Name	Sonim
	Model Name	BAT-04800-01S
	Power Rating	3.7Vdc, 4800mAh
	Type	Li-ion
Earphone	Brand Name	Minami
	Model Name	ME-816B5-E
	Signal Line Type	1.2 meter non-shielded cable without ferrite core

3. SAR Measurement System

3.1 Definition of Specific Absorption Rate (SAR)

SAR is related to the rate at which energy is absorbed per unit mass in an object exposed to a radio field. The SAR distribution in a biological body is complicated and is usually carried out by experimental techniques or numerical modeling. The standard recommends limits for two tiers of groups, occupational/controlled and general population/uncontrolled, based on a person's awareness and ability to exercise control over his or her exposure. In general, occupational/controlled exposure limits are higher than the limits for general population/uncontrolled.

The SAR definition is the time derivative (rate) of the incremental energy (dW) absorbed by (dissipated in) an incremental mass (dm) contained in a volume element (dv) of a given density (ρ). The equation description is as below:

$$\text{SAR} = \frac{d}{dt} \left(\frac{dW}{dm} \right) = \frac{d}{dt} \left(\frac{dW}{\rho dv} \right)$$

SAR is expressed in units of Watts per kilogram (W/kg)

SAR measurement can be related to the electrical field in the tissue by

$$\text{SAR} = \frac{\sigma |E|^2}{\rho}$$

Where: σ is the conductivity of the tissue, ρ is the mass density of the tissue and E is the RMS electrical field strength.

3.2 SPEAG DASY System

DASY system consists of high precision robot, probe alignment sensor, phantom, robot controller, controlled measurement server and near-field probe. The robot includes six axes that can move to the precision position of the DASY4/5 software defined. The DASY software can define the area that is detected by the probe. The robot is connected to controlled box. Controlled measurement server is connected to the controlled robot box. The DAE includes amplifier, signal multiplexing, AD converter, offset measurement and surface detection. It is connected to the Electro-optical coupler (ECO). The ECO performs the conversion from the optical into digital electric signal of the DAE and transfers data to the PC.



Fig-3.1 DASY System Setup

3.2.1 Robot

The DASY system uses the high precision robots from Stäubli SA (France). For the 6-axis controller system, the robot controller version (DASY4: CS7MB; DASY5: CS8c) from Stäubli is used. The Stäubli robot series have many features that are important for our application:

- High precision (repeatability ± 0.035 mm)
- High reliability (industrial design)
- Jerk-free straight movements
- Low ELF interference (the closed metallic construction shields against motor control fields)



Fig-3.2 DASY4





Fig-3.3 DASY5

FCC SAR Test Report

3.2.2 Probes

The SAR measurement is conducted with the dosimetric probe. The probe is specially designed and calibrated for use in liquid with high permittivity. The dosimetric probe has special calibration in liquid at different frequency.

Model	EX3DV4	
Construction	Symmetrical design with triangular core. Built-in shielding against static charges. PEEK enclosure material (resistant to organic solvents, e.g., DGBE).	
Frequency	10 MHz to 6 GHz Linearity: ± 0.2 dB	
Directivity	± 0.3 dB in HSL (rotation around probe axis) ± 0.5 dB in tissue material (rotation normal to probe axis)	
Dynamic Range	10 μ W/g to 100 mW/g Linearity: ± 0.2 dB (noise: typically < 1 μ W/g)	
Dimensions	Overall length: 337 mm (Tip: 20 mm) Tip diameter: 2.5 mm (Body: 12 mm) Typical distance from probe tip to dipole centers: 1 mm	

Model	ES3DV3	
Construction	Symmetrical design with triangular core. Interleaved sensors. Built-in shielding against static charges. PEEK enclosure material (resistant to organic solvents, e.g., DGBE).	
Frequency	10 MHz to 4 GHz Linearity: ± 0.2 dB	
Directivity	± 0.2 dB in HSL (rotation around probe axis) ± 0.3 dB in tissue material (rotation normal to probe axis)	
Dynamic Range	5 μ W/g to 100 mW/g Linearity: ± 0.2 dB	
Dimensions	Overall length: 337 mm (Tip: 20 mm) Tip diameter: 3.9 mm (Body: 12 mm) Distance from probe tip to dipole centers: 2.0 mm	

3.2.3 Data Acquisition Electronics (DAE)

Model	DAE3, DAE4	
Construction	Signal amplifier, multiplexer, A/D converter and control logic. Serial optical link for communication with DASY embedded system (fully remote controlled). Two step probe touch detector for mechanical surface detection and emergency robot stop.	
Measurement Range	-100 to +300 mV (16 bit resolution and two range settings: 4mV, 400mV)	
Input Offset Voltage	< 5 μ V (with auto zero)	
Input Bias Current	< 50 fA	
Dimensions	60 x 60 x 68 mm	

FCC SAR Test Report

3.2.4 Phantoms

Model	Twin SAM	
Construction	The shell corresponds to the specifications of the Specific Anthropomorphic Mannequin (SAM) phantom defined in IEEE 1528 and IEC 62209-1. It enables the dosimetric evaluation of left and right hand phone usage as well as body mounted usage at the flat phantom region. A cover prevents evaporation of the liquid. Reference markings on the phantom allow the complete setup of all predefined phantom positions and measurement grids by teaching three points with the robot.	
Material	Vinylester, glass fiber reinforced (VE-GF)	
Shell Thickness	2 ± 0.2 mm (6 ± 0.2 mm at ear point)	
Dimensions	Length: 1000 mm Width: 500 mm Height: adjustable feet	
Filling Volume	approx. 25 liters	

Model	ELI	
Construction	Phantom for compliance testing of handheld and body-mounted wireless devices in the frequency range of 30 MHz to 6 GHz. ELI is fully compatible with the IEC 62209-2 standard and all known tissue simulating liquids. ELI has been optimized regarding its performance and can be integrated into our standard phantom tables. A cover prevents evaporation of the liquid. Reference markings on the phantom allow installation of the complete setup, including all predefined phantom positions and measurement grids, by teaching three points. The phantom is compatible with all SPEAG dosimetric probes and dipoles.	
Material	Vinylester, glass fiber reinforced (VE-GF)	
Shell Thickness	2.0 ± 0.2 mm (bottom plate)	
Dimensions	Major axis: 600 mm Minor axis: 400 mm	
Filling Volume	approx. 30 liters	

FCC SAR Test Report

3.2.5 Device Holder

Model	Mounting Device	
Construction	In combination with the Twin SAM Phantom or ELI4, the Mounting Device enables the rotation of the mounted transmitter device in spherical coordinates. Rotation point is the ear opening point. Transmitter devices can be easily and accurately positioned according to IEC, IEEE, FCC or other specifications. The device holder can be locked for positioning at different phantom sections (left head, right head, flat).	
Material	POM	

Model	Laptop Extensions Kit	
Construction	Simple but effective and easy-to-use extension for Mounting Device that facilitates the testing of larger devices according to IEC 62209-2 (e.g., laptops, cameras, etc.). It is lightweight and fits easily on the upper part of the Mounting Device in place of the phone positioner.	
Material	POM, Acrylic glass, Foam	

3.2.6 System Validation Dipoles

Model	D-Serial	
Construction	Symmetrical dipole with 1/4 balun. Enables measurement of feed point impedance with NWA. Matched for use near flat phantoms filled with tissue simulating solutions.	
Frequency	750 MHz to 5800 MHz	
Return Loss	> 20 dB	
Power Capability	> 100 W (f < 1GHz), > 40 W (f > 1GHz)	

FCC SAR Test Report

3.2.7 Tissue Simulating Liquids

For SAR measurement of the field distribution inside the phantom, the phantom must be filled with homogeneous tissue simulating liquid to a depth of at least 15 cm. For head SAR testing, the liquid height from the ear reference point (ERP) of the phantom to the liquid top surface is larger than 15 cm. For body SAR testing, the liquid height from the center of the flat phantom to the liquid top surface is larger than 15 cm. The nominal dielectric values of the tissue simulating liquids in the phantom and the tolerance of 5% are listed in Table-3.1.

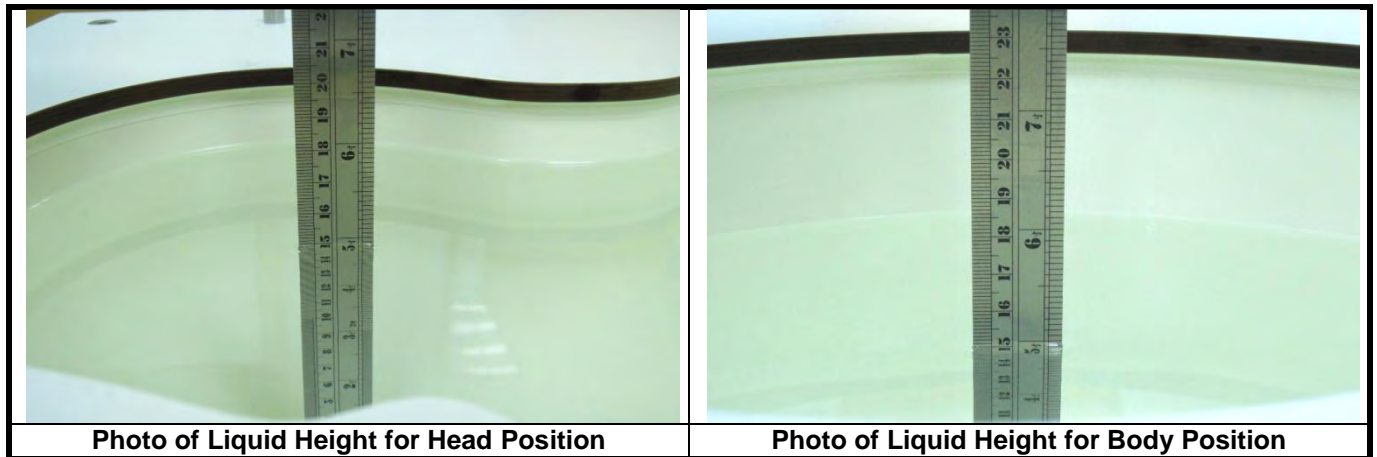

The dielectric properties of the head tissue simulating liquids are defined in IEEE 1528, and KDB 865664 D01 Appendix A. For the body tissue simulating liquids, the dielectric properties are defined in KDB 865664 D01 Appendix A. The dielectric properties of the tissue simulating liquids were verified prior to the SAR evaluation using a dielectric assessment kit and a network analyzer.



FCC SAR Test Report

Table-3.1 Targets of Tissue Simulating Liquid

Frequency (MHz)	Target Permittivity	Range of $\pm 5\%$	Target Conductivity	Range of $\pm 5\%$
For Head				
750	41.9	39.8 ~ 44.0	0.89	0.85 ~ 0.93
835	41.5	39.4 ~ 43.6	0.90	0.86 ~ 0.95
900	41.5	39.4 ~ 43.6	0.97	0.92 ~ 1.02
1450	40.5	38.5 ~ 42.5	1.20	1.14 ~ 1.26
1640	40.3	38.3 ~ 42.3	1.29	1.23 ~ 1.35
1750	40.1	38.1 ~ 42.1	1.37	1.30 ~ 1.44
1800	40.0	38.0 ~ 42.0	1.40	1.33 ~ 1.47
1900	40.0	38.0 ~ 42.0	1.40	1.33 ~ 1.47
2000	40.0	38.0 ~ 42.0	1.40	1.33 ~ 1.47
2300	39.5	37.5 ~ 41.5	1.67	1.59 ~ 1.75
2450	39.2	37.2 ~ 41.2	1.80	1.71 ~ 1.89
2600	39.0	37.1 ~ 41.0	1.96	1.86 ~ 2.06
3500	37.9	36.0 ~ 39.8	2.91	2.76 ~ 3.06
5200	36.0	34.2 ~ 37.8	4.66	4.43 ~ 4.89
5300	35.9	34.1 ~ 37.7	4.76	4.52 ~ 5.00
5500	35.6	33.8 ~ 37.4	4.96	4.71 ~ 5.21
5600	35.5	33.7 ~ 37.3	5.07	4.82 ~ 5.32
5800	35.3	33.5 ~ 37.1	5.27	5.01 ~ 5.53
For Body				
750	55.5	52.7 ~ 58.3	0.96	0.91 ~ 1.01
835	55.2	52.4 ~ 58.0	0.97	0.92 ~ 1.02
900	55.0	52.3 ~ 57.8	1.05	1.00 ~ 1.10
1450	54.0	51.3 ~ 56.7	1.30	1.24 ~ 1.37
1640	53.8	51.1 ~ 56.5	1.40	1.33 ~ 1.47
1750	53.4	50.7 ~ 56.1	1.49	1.42 ~ 1.56
1800	53.3	50.6 ~ 56.0	1.52	1.44 ~ 1.60
1900	53.3	50.6 ~ 56.0	1.52	1.44 ~ 1.60
2000	53.3	50.6 ~ 56.0	1.52	1.44 ~ 1.60
2300	52.9	50.3 ~ 55.5	1.81	1.72 ~ 1.90
2450	52.7	50.1 ~ 55.3	1.95	1.85 ~ 2.05
2600	52.5	49.9 ~ 55.1	2.16	2.05 ~ 2.27
3500	51.3	48.7 ~ 53.9	3.31	3.14 ~ 3.48
5200	49.0	46.6 ~ 51.5	5.30	5.04 ~ 5.57
5300	48.9	46.5 ~ 51.3	5.42	5.15 ~ 5.69
5500	48.6	46.2 ~ 51.0	5.65	5.37 ~ 5.93
5600	48.5	46.1 ~ 50.9	5.77	5.48 ~ 6.06
5800	48.2	45.8 ~ 50.6	6.00	5.70 ~ 6.30

FCC SAR Test Report

The following table gives the recipes for tissue simulating liquids.

Table-3.2 Recipes of Tissue Simulating Liquid

Tissue Type	Bactericide	DGBE	HEC	NaCl	Sucrose	Triton X-100	Water	Diethylene Glycol Mono-hexylether
H750	0.2	-	0.2	1.5	56.0	-	42.1	-
H835	0.2	-	0.2	1.5	57.0	-	41.1	-
H900	0.2	-	0.2	1.4	58.0	-	40.2	-
H1450	-	43.3	-	0.6	-	-	56.1	-
H1640	-	45.8	-	0.5	-	-	53.7	-
H1750	-	47.0	-	0.4	-	-	52.6	-
H1800	-	44.5	-	0.3	-	-	55.2	-
H1900	-	44.5	-	0.2	-	-	55.3	-
H2000	-	44.5	-	0.1	-	-	55.4	-
H2300	-	44.9	-	0.1	-	-	55.0	-
H2450	-	45.0	-	0.1	-	-	54.9	-
H2600	-	45.1	-	0.1	-	-	54.8	-
H3500	-	8.0	-	0.2	-	20.0	71.8	-
H5G	-	-	-	-	-	17.2	65.5	17.3
B750	0.2	-	0.2	0.8	48.8	-	50.0	-
B835	0.2	-	0.2	0.9	48.5	-	50.2	-
B900	0.2	-	0.2	0.9	48.2	-	50.5	-
B1450	-	34.0	-	0.3	-	-	65.7	-
B1640	-	32.5	-	0.3	-	-	67.2	-
B1750	-	31.0	-	0.2	-	-	68.8	-
B1800	-	29.5	-	0.4	-	-	70.1	-
B1900	-	29.5	-	0.3	-	-	70.2	-
B2000	-	30.0	-	0.2	-	-	69.8	-
B2300	-	31.0	-	0.1	-	-	68.9	-
B2450	-	31.4	-	0.1	-	-	68.5	-
B2600	-	31.8	-	0.1	-	-	68.1	-
B3500	-	28.8	-	0.1	-	-	71.1	-
B5G	-	-	-	-	-	10.7	78.6	10.7

3.3 SAR System Verification

The system check verifies that the system operates within its specifications. It is performed daily or before every SAR measurement. The system check uses normal SAR measurements in the flat section of the phantom with a matched dipole at a specified distance. The system verification setup is shown as below.

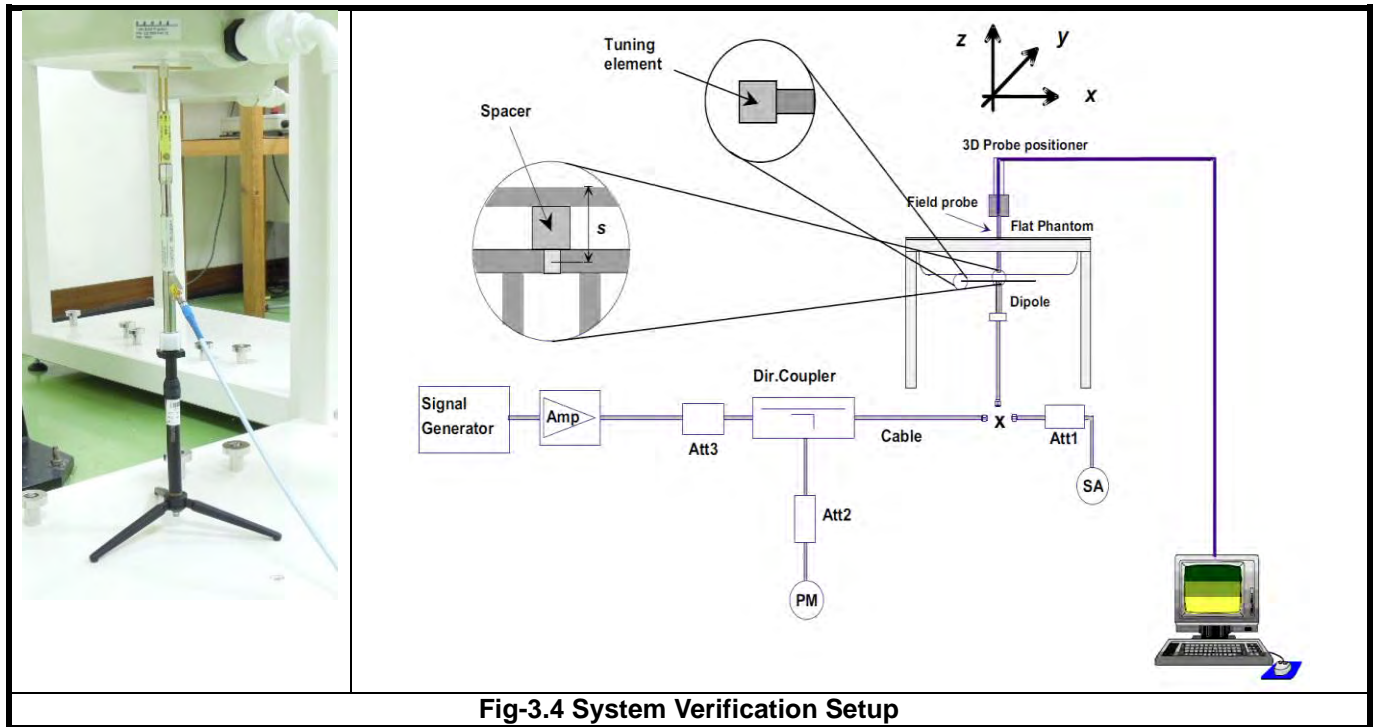

Fig-3.4 System Verification Setup

The validation dipole is placed beneath the flat phantom with the specific spacer in place. The distance spacer is touch the phantom surface with a light pressure at the reference marking and be oriented parallel to the long side of the phantom. The spectrum analyzer measures the forward power at the location of the system check dipole connector. The signal generator is adjusted for the desired forward power (250 mW is used for 700 MHz to 3 GHz, 100 mW is used for 3.5 GHz to 6 GHz) at the dipole connector and the power meter is read at that level. After connecting the cable to the dipole, the signal generator is readjusted for the same reading at power meter.

After system check testing, the SAR result will be normalized to 1W forward input power and compared with the reference SAR value derived from validation dipole certificate report. The deviation of system check should be within 10 %.

3.4 SAR Measurement Procedure

According to the SAR test standard, the recommended procedure for assessing the peak spatial-average SAR value consists of the following steps:

- (a) Power reference measurement
- (b) Area scan
- (c) Zoom scan
- (d) Power drift measurement

The SAR measurement procedures for each of test conditions are as follows:

- (a) Make EUT to transmit maximum output power
- (b) Measure conducted output power through RF cable
- (c) Place the EUT in the specific position of phantom
- (d) Perform SAR testing steps on the DASY system
- (e) Record the SAR value

3.4.1 Area & Zoom Scan Procedure

First Area Scan is used to locate the approximate location(s) of the local peak SAR value(s). The measurement grid within an Area Scan is defined by the grid extent, grid step size and grid offset. Next, in order to determine the EM field distribution in a three-dimensional spatial extension, Zoom Scan is required. The Zoom Scan is performed around the highest E-field value to determine the averaged SAR-distribution over 10 g. According to KDB 865664 D01, the resolution for Area and Zoom scan is specified in the table below.

Items	<= 2 GHz	2-3 GHz	3-4 GHz	4-5 GHz	5-6 GHz
Area Scan ($\Delta x, \Delta y$)	<= 15 mm	<= 12 mm	<= 12 mm	<= 10 mm	<= 10 mm
Zoom Scan ($\Delta x, \Delta y$)	<= 8 mm	<= 5 mm	<= 5 mm	<= 4 mm	<= 4 mm
Zoom Scan (Δz)	<= 5 mm	<= 5 mm	<= 4 mm	<= 3 mm	<= 2 mm
Zoom Scan Volume	>= 30 mm	>= 30 mm	>= 28 mm	>= 25 mm	>= 22 mm

Note:

When zoom scan is required and report SAR is <= 1.4 W/kg, the zoom scan resolution of $\Delta x / \Delta y$ (2-3GHz: <= 8 mm, 3-4GHz: <= 7 mm, 4-6GHz: <= 5 mm) may be applied.

3.4.2 Volume Scan Procedure

The volume scan is used for assess overlapping SAR distributions for antennas transmitting in different frequency bands. It is equivalent to an oversized zoom scan used in standalone measurements. The measurement volume will be used to enclose all the simultaneous transmitting antennas. For antennas transmitting simultaneously in different frequency bands, the volume scan is measured separately in each frequency band. In order to sum correctly to compute the 1g aggregate SAR, the EUT remain in the same test position for all measurements and all volume scan use the same spatial resolution and grid spacing. When all volume scan were completed, the software, SEMCAD postprocessor can combine and subsequently superpose these measurement data to calculating the multiband SAR.

FCC SAR Test Report

3.4.3 Power Drift Monitoring

All SAR testing is under the EUT install full charged battery and transmit maximum output power. In DASY measurement software, the power reference measurement and power drift measurement procedures are used for monitoring the power drift of EUT during SAR test. Both these procedures measure the field at a specified reference position before and after the SAR testing. The software will calculate the field difference in dB. If the power drift more than 5%, the SAR will be retested.

3.4.4 Spatial Peak SAR Evaluation

The procedure for spatial peak SAR evaluation has been implemented according to the test standard. It can be conducted for 1g and 10g, as well as for user-specific masses. The DASY software includes all numerical procedures necessary to evaluate the spatial peak SAR value.

The base for the evaluation is a "cube" measurement. The measured volume must include the 1g and 10g cubes with the highest averaged SAR values. For that purpose, the center of the measured volume is aligned to the interpolated peak SAR value of a previously performed area scan.

The entire evaluation of the spatial peak values is performed within the post-processing engine (SEMCAD). The system always gives the maximum values for the 1g and 10g cubes. The algorithm to find the cube with highest averaged SAR is divided into the following stages:

- (a) Extraction of the measured data (grid and values) from the Zoom Scan
- (b) Calculation of the SAR value at every measurement point based on all stored data (A/D values and measurement parameters)
- (c) Generation of a high-resolution mesh within the measured volume
- (d) Interpolation of all measured values from the measurement grid to the high-resolution grid
- (e) Extrapolation of the entire 3-D field distribution to the phantom surface over the distance from sensor to surface
- (f) Calculation of the averaged SAR within masses of 1g and 10g

3.4.5 SAR Averaged Methods

In DASY, the interpolation and extrapolation are both based on the modified Quadratic Shepard's method. The interpolation scheme combines a least-square fitted function method and a weighted average method which are the two basic types of computational interpolation and approximation.

Extrapolation routines are used to obtain SAR values between the lowest measurement points and the inner phantom surface. The extrapolation distance is determined by the surface detection distance and the probe sensor offset. The uncertainty increases with the extrapolation distance. To keep the uncertainty within 1% for the 1 g and 10 g cubes, the extrapolation distance should not be larger than 5 mm.

FCC SAR Test Report

4. SAR Measurement Evaluation

4.1 EUT Configuration and Setting

The EUT is a voice/data transmitter device that contains two WWAN transmitters (GSM/WCDMA/LTE). Confirming the LTE transmitter follows 3GPP standards, is category 3, FDD-LTE band 7 (BW 5/10/15/20 MHz), supports QPSK / 16QAM modulations, and supports data and supports data transmission only. Tested per 3GPP 36.521 maximum transmit procedures for both QPSK / 16QAM.

LTE Maximum Power Reduction in accordance with 3GPP 36.101: Power Reduction in accordance to 3GPP is active all times during LTE operation.

Modulation	Channel Bandwidth / RB Configurations				LTE MPR Setting (dB)
	BW 5 MHz	BW 10 MHz	BW 15 MHz	BW 20 MHz	
QPSK	> 8	> 12	> 16	> 18	1
16QAM	<= 8	<= 12	<= 16	<= 18	1
16QAM	> 8	> 12	> 16	> 18	2

Note: MPR is according to the standard and implemented in the circuit (mandatory).

In addition, the device is compliant with A-MPR requirements defined in 36.101 section 6.2.4 that may be required to meet 3GPP Adjacent Channel Leakage Ratio (“ACLR”) requirements. A-MPR was disabled for all FCC compliance testing.

The simultaneous transmission possibilities are listed as below.

Simultaneous TX Combination	Configuration	Head (Voice / VoIP)	Body Worn (Voice / VoIP)	Hotspot (Data)
1	GSM850 (Voice / Data) + WLAN (Data)	Yes	Yes	No
2	GSM1900 (Voice / Data) + WLAN (Data)	Yes	Yes	No
3	WCDMA II (Voice / Data) + WLAN (Data)	Yes	Yes	No
4	WCDMA V (Voice / Data) + WLAN (Data)	Yes	Yes	No
5	LTE 7 (Data) + WLAN (Data)	Yes	Yes	No
6	GSM850 (Voice / Data) + BT (Data)	No	Yes	No
7	GSM1900 (Voice / Data) + BT (Data)	No	Yes	No
8	WCDMA II (Voice / Data) + BT (Data)	No	Yes	No
9	WCDMA V (Voice / Data) + BT (Data)	No	Yes	No
10	LTE 7 (Data) + BT (Data)	No	Yes	No

Note :

1. The WLAN and BT cannot transmit simultaneously, so there is no co-location test requirement for WLAN and BT.

FCC SAR Test Report

For WWAN SAR testing, the EUT was linked and controlled by base station emulator (Agilent E5515C). Communication between the EUT and the emulator was established by air link. The distance between the EUT and the communicating antenna of the emulator is larger than 50 cm and the output power radiated from the emulator antenna is at least 30 dB smaller than the output power of EUT. The EUT was set from the emulator to radiate maximum output power during SAR testing.

The EUT is communicated with base station simulator (Agilent E5515C is used for GSM/WCDMA, and Anritsu MT8820C is used for LTE) by air link. During SAR testing, the base station simulator is set to make the EUT to radiate maximum output power.

For WCDMA, head and body SAR is tested under 12.2k RMC mode with power control set all up bits. SAR for AMR is not required since its power is less than 1/4 dB higher than RMC. SAR for HSDPA/HSUPA is not required since its power is less than 1/4 dB higher than RMC without HSDPA/HSUPA and SAR for 12.2 kbps RMC is less than 75% of the SAR limit (1.2 W/kg).

For LTE, set the related parameters of operating band, channel bandwidth, uplink channel number, modulation type, and RB in base station simulator. When the EUT has registered and communicated to base station simulator, set the simulator to make EUT transmitting the maximum radiated power. The steps for system simulator (Anritsu MT8820C) setup are as below.

1. Press the "Std" button to select "LTE 22.20S" function
2. Choose the "Screen Select" item to "Fundamental Measurement"
3. Enter the "Common" item
4. Set the Operating Band
5. Set the Channel Bandwidth
6. Set the UL Channel & Frequency
7. Set the Modulation
8. Set the RB number and RB shift
9. Press "Start Call" button when EUT register to the system simulator
10. Set the TX-1 Max. Power to make the EUT transmit maximum output power

For WLAN SAR testing, the EUT has installed WLAN engineering testing software which can provide continuous transmitting RF signal. According to KDB 248227 D01, WLAN SAR for this device was performed at the lowest data rate.

4.2 EUT Testing Position

According to KDB 648474 D04, handsets are tested for SAR compliance in head, body-worn accessory and other use configurations described in the following subsections.

4.2.1 Head Exposure Conditions

Head exposure is limited to next to the ear voice mode operations. Head SAR compliance is tested according to the test positions defined in IEEE Std 1528-2003 using the SAM phantom illustrated as below.

1. Define two imaginary lines on the handset
 - (a) The vertical centerline passes through two points on the front side of the handset - the midpoint of the width w_t of the handset at the level of the acoustic output, and the midpoint of the width w_b of the bottom of the handset.
 - (b) The horizontal line is perpendicular to the vertical centerline and passes through the center of the acoustic output. The horizontal line is also tangential to the face of the handset at point A.
 - (c) The two lines intersect at point A. Note that for many handsets, point A coincides with the center of the acoustic output; however, the acoustic output may be located elsewhere on the horizontal line. Also note that the vertical centerline is not necessarily parallel to the front face of the handset, especially for clamshell handsets, handsets with flip covers, and other irregularly shaped handsets.

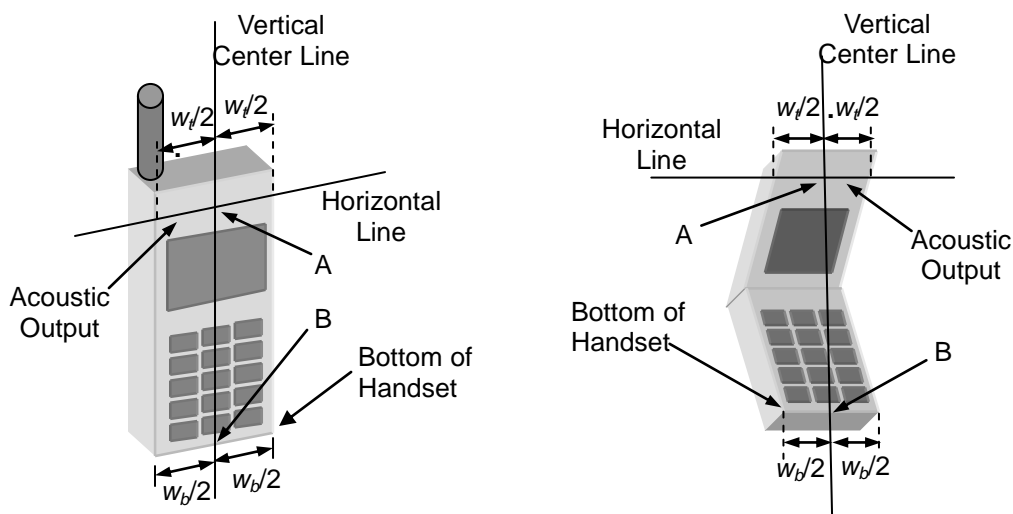

Fig-4.1 Illustration for Handset Vertical and Horizontal Reference Lines

FCC SAR Test Report

2. Cheek Position

- (a) To position the device with the vertical center line of the body of the device and the horizontal line crossing the center piece in a plane parallel to the sagittal plane of the phantom. While maintaining the device in this plane, align the vertical center line with the reference plane containing the three ear and mouth reference point (M: Mouth, RE: Right Ear, and LE: Left Ear) and align the center of the ear piece with the line RE-LE.
- (b) To move the device towards the phantom with the ear piece aligned with the line LE-RE until the phone touched the ear. While maintaining the device in the reference plane and maintaining the phone contact with the ear, move the bottom of the phone until any point on the front side is in contact with the cheek of the phantom or until contact with the ear is lost (see Fig-4.2).

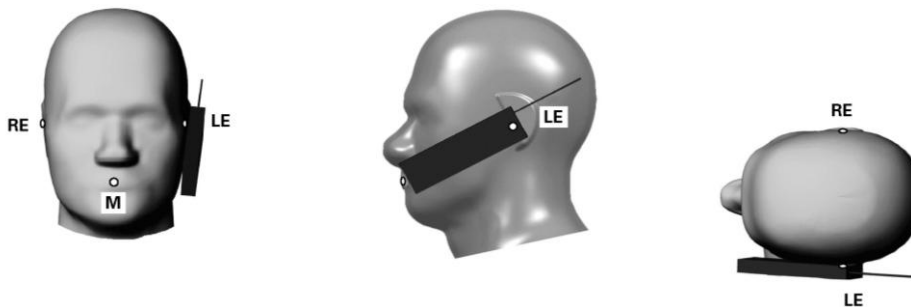

Fig-4.2 Illustration for Cheek Position

3. Tilted Position

- (a) To position the device in the “cheek” position described above.
- (b) While maintaining the device the reference plane described above and pivoting against the ear, moves it outward away from the mouth by an angle of 15 degrees or until contact with the ear is lost (see Fig-4.3).

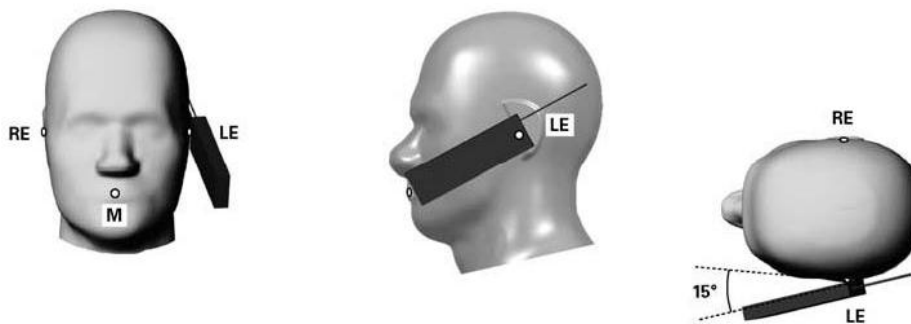

Fig-4.3 Illustration for Tilted Position

4.2.2 Body-Worn Accessory Exposure Conditions

Body-worn accessory exposure is typically related to voice mode operations when handsets are carried in body-worn accessories. The body-worn accessory procedures in KDB 447498 D01 are used to test for body-worn accessory SAR compliance, without a headset connected to it. This enables the test results for such configuration to be compatible with that required for hotspot mode when the body-worn accessory test separation distance is greater than or equal to that required for hotspot mode. When the reported SAR for a body-worn accessory, measured without a headset connected to the handset, is $> 1.2 \text{ W/kg}$, the highest reported SAR configuration for that wireless mode and frequency band should be repeated for that body-worn accessory with a headset attached to the handset.

Body-worn accessories that do not contain metallic or conductive components may be tested according to worst-case exposure configurations, typically according to the smallest test separation distance required for the group of body-worn accessories with similar operating and exposure characteristics. All body-worn accessories containing metallic components are tested in conjunction with the host device.

Body-worn accessory SAR compliance is based on a single minimum test separation distance for all wireless and operating modes applicable to each body-worn accessory used by the host, and according to the relevant voice and/or data mode transmissions and operations. If a body-worn accessory supports voice only operations in its normal and expected use conditions, testing of data mode for body-worn compliance is not required.

A conservative minimum test separation distance for supporting off-the-shelf body-worn accessories that may be acquired by users of consumer handsets is used to test for body-worn accessory SAR compliance. This distance is determined by the handset manufacturer, according to the requirements of Supplement C 01-01. Devices that are designed to operate on the body of users using lanyards and straps, or without requiring additional body-worn accessories, will be tested using a conservative minimum test separation distance $\leq 5 \text{ mm}$ to support compliance.

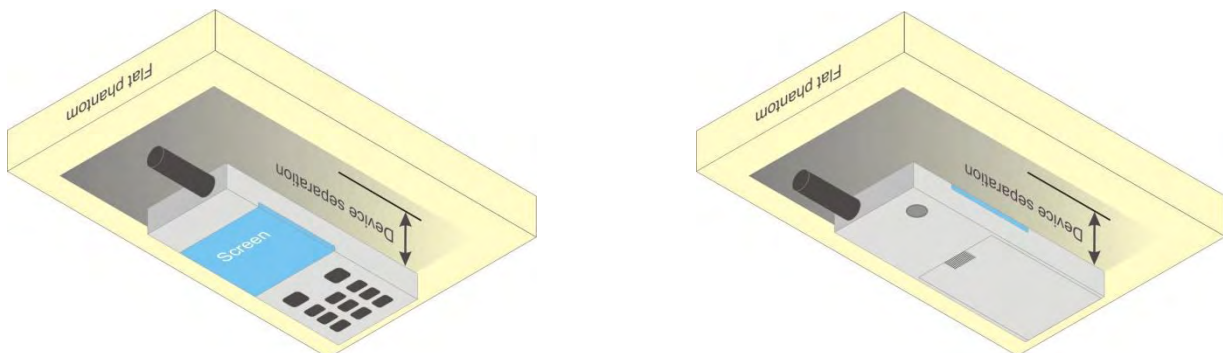
**Fig-4.4 Illustration for Body Worn Position**

4.2.3 Hotspot Mode Exposure conditions

For handsets that support hotspot mode operations, with wireless router capabilities and various web browsing functions, the relevant hand and body exposure conditions are tested according to the hotspot SAR procedures in KDB 941225 D06. A test separation distance of 10 mm is required between the phantom and all surfaces and edges with a transmitting antenna located within 25 mm from that surface or edge. When the form factor of a handset is smaller than 9 cm x 5 cm, a test separation distance of 5 mm (instead of 10 mm) is required for testing hotspot mode. When the separation distance required for body-worn accessory testing is larger than or equal to that tested for hotspot mode, in the same wireless mode and for the same surface of the phone, the hotspot mode SAR data may be used to support body-worn accessory SAR compliance for that particular configuration (surface).

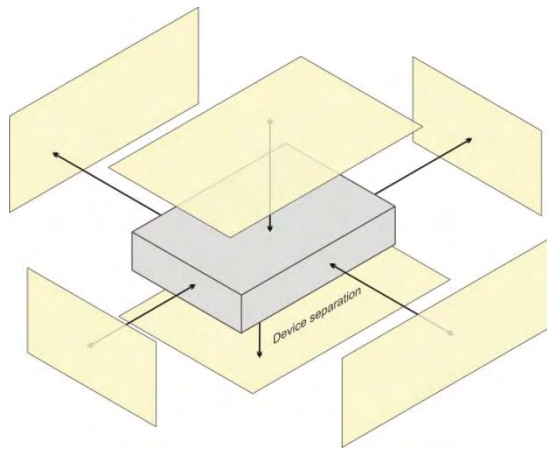

Based on the antenna location shown on appendix D of this report, the SAR testing required for hotspot mode is listed as below.

Antenna	Front Face	Rear Face	Left Side	Right Side	Top Side	Bottom Side
WWAN	V	V	V	V		V
WLAN / BT	V	V		V		

FCC SAR Test Report

4.2.4 Extremity Exposure conditions

For smart phones with a display diagonal dimension > 15 cm or an overall diagonal dimension > 16 cm that provide similar mobile web access and multimedia support found in mini-tablets or UMPC mini-tablets that support voice calls next to the ear, the following phablet procedures should be applied to evaluate SAR compliance for each applicable wireless modes and frequency band. Devices marketed as phablets, regardless of form factors and operating characteristics must be tested as a phablet to determine SAR compliance.

1. The normally required head and body-worn accessory SAR test procedures for handsets, including hotspot mode, must be applied.
2. The UMPC mini-tablet procedures must also be applied to test the SAR of all surfaces and edges with an antenna located at <= 25 mm from that surface or edge, in direct contact with a flat phantom, for 10-g extremity SAR according to the body-equivalent tissue dielectric parameters in KDB 865664 to address interactive hand use exposure conditions. The UMPC mini-tablet 1-g SAR at 5 mm is not required. When hotspot mode applies, 10-g extremity SAR is required only for the surfaces and edges with hotspot mode 1-g SAR > 1.2 W/kg. The normal tablet procedures in KDB 616217 are required when the over diagonal dimension of the device is > 20 cm. Hotspot mode SAR is not required when normal tablet procedures are applied. Extremity 10-g SAR is also not required for the front (top) surface of large form factor full size tablets. The more conservative tablet SAR results can be used to support the 10-g extremity SAR for phablet mode.
3. The simultaneous transmission operating configurations applicable to voice and data transmissions for both phone and mini-tablet modes must be taken into consideration separately for 1-g and 10-g SAR to determine the simultaneous transmission SAR test exclusion and measurement requirements for the relevant wireless modes and exposure conditions.

4.2.5 SAR Test Exclusions

According to KDB 447498 D01, the SAR test exclusion condition is based on source-based time-averaged maximum conducted output power, adjusted for tune-up tolerance, and the minimum test separation distance required for the exposure conditions. The SAR exclusion threshold is determined by the following formula.

$$\frac{\text{Max. Tune up Power}_{(mW)}}{\text{Min. Test Separation Distance}_{(mm)}} \times \sqrt{f_{(GHz)}} \leq 3.0 \text{ for SAR-1g, } \leq 7.5 \text{ for SAR-10g}$$

When the minimum test separation distance is < 5 mm, a distance of 5 mm is applied to determine SAR test exclusion.

Mode	Max. Tune-up Power (dBm)	Max. Tune-up Power (mW)	Body-Worn		
			Ant. to Surface (mm)	Calculated Result	Require SAR Testing?
WLAN 5.2G	9.5	9	10	2.1	No
WLAN 5.3G	9.0	8	10	1.8	No
WLAN 5.6G	10.0	10	10	2.4	No
BT (2.48 GHz)	10.0	10	10	1.6	No

Note:

1. When separation distance <= 50 mm and the calculated result shown in above table is <= 3.0, the SAR testing exclusion is applied.



FCC SAR Test Report

4.3 Tissue Verification

The measuring results for tissue simulating liquid are shown as below.

Test Date	Tissue Type	Frequency (MHz)	Liquid Temp. (°C)	Measured Conductivity (σ)	Measured Permittivity (ε _r)	Target Conductivity (σ)	Target Permittivity (ε _r)	Conductivity Deviation (%)	Permittivity Deviation (%)
May. 27, 2015	Head	835	21.4	0.876	42.458	0.90	41.5	-2.67	2.31
May. 27, 2015	Head	1900	21.5	1.460	38.508	1.40	40.0	4.29	-3.73
May. 28, 2015	Head	2450	21.5	1.831	38.200	1.80	39.2	1.72	-2.55
Jun. 07, 2015	Head	2600	21.2	1.987	37.616	1.96	39.0	1.38	-3.55
Jun. 03, 2015	Head	5200	22.2	4.599	36.160	4.66	36.0	-1.31	0.44
Jun. 03, 2015	Head	5600	22.1	4.885	35.648	5.07	35.5	-3.65	0.42
May. 26, 2015	Body	835	21.8	0.949	54.635	0.97	55.2	-2.16	-1.02
May. 27, 2015	Body	1900	21.5	1.547	53.811	1.52	53.3	1.78	0.96
May. 28, 2015	Body	2450	21.8	1.920	53.904	1.95	52.7	-1.54	2.28
Jun. 07, 2015	Body	2600	21.3	2.200	52.401	2.16	52.5	1.85	-0.19

Note:

The dielectric properties of the tissue simulating liquid must be measured within 24 hours before the SAR testing and within ±5% of the target values. Liquid temperature during the SAR testing must be within ±2 °C.

4.4 System Validation

The SAR measurement system was validated according to procedures in KDB 865664 D01. The validation status in tabulated summary is as below.

Test Date	Probe S/N	Calibration Point		Measured Conductivity (σ)	Measured Permittivity (ε _r)	Validation for CW			Validation for Modulation		
						Sensitivity Range	Probe Linearity	Probe Isotropy	Modulation Type	Duty Factor	PAR
May. 27, 2015	3864	Body	835	0.876	42.458	Pass	Pass	Pass	GMSK	Pass	N/A
May. 27, 2015	3864	Body	1900	1.460	38.508	Pass	Pass	Pass	GMSK	Pass	N/A
May. 28, 2015	3590	Body	2450	1.831	38.200	Pass	Pass	Pass	OFDM	N/A	Pass
Jun. 07, 2015	3873	Body	2600	1.987	37.616	Pass	Pass	Pass	N/A	N/A	Pass
Jun. 03, 2015	3590	Body	5200	4.599	36.160	Pass	Pass	Pass	OFDM	N/A	Pass
Jun. 03, 2015	3590	Body	5600	4.885	35.648	Pass	Pass	Pass	OFDM	N/A	Pass
May. 26, 2015	3590	Head	835	0.949	54.635	Pass	Pass	Pass	GMSK	Pass	N/A
May. 27, 2015	3650	Head	1900	1.547	53.811	Pass	Pass	Pass	GMSK	Pass	N/A
May. 28, 2015	3590	Head	2450	1.920	53.904	Pass	Pass	Pass	OFDM	N/A	Pass
Jun. 07, 2015	3873	Head	2600	2.200	52.401	Pass	Pass	Pass	N/A	N/A	N/A



FCC SAR Test Report

4.5 System Verification

The measuring result for system verification is tabulated as below.

Test Date	Mode	Frequency (MHz)	1W Target SAR-1g (W/kg)	Measured SAR-1g (W/kg)	Normalized to 1W SAR-1g (W/kg)	Deviation (%)	Dipole S/N	Probe S/N	DAE S/N
May. 27, 2015	Head	835	9.43	2.44	9.76	3.50	4d121	3864	510
May. 27, 2015	Head	1900	40.70	10.10	40.40	-0.74	5d036	3864	510
May. 28, 2015	Head	2450	51.00	12.10	48.40	-5.10	737	3590	861
Jun. 07, 2015	Head	2600	57.50	15.10	60.40	5.04	1020	3873	1341
Jun. 03, 2015	Head	5200	79.70	8.47	84.70	6.27	1019	3590	861
Jun. 03, 2015	Head	5600	83.80	8.02	80.20	-4.30	1019	3590	861
May. 26, 2015	Body	835	9.55	2.27	9.08	-4.92	4d121	3590	861
May. 27, 2015	Body	1900	40.50	10.40	41.60	2.72	5d036	3864	510
May. 28, 2015	Body	2450	49.50	11.80	47.20	-4.65	737	3590	861
Jun. 07, 2015	Body	2600	56.50	14.20	56.80	0.53	1020	3873	1341

Note:

Comparing to the reference SAR value provided by SPEAG, the validation data should be within its specification of 10 %. The result indicates the system check can meet the variation criterion and the plots can be referred to Appendix A of this report.



FCC SAR Test Report

4.6 Maximum Output Power

4.6.1 Maximum Conducted Power

The maximum conducted average power (Unit: dBm) including tune-up tolerance is shown as below.

Mode	GSM850	GSM1900
GSM (GMSK, 1Tx-slot)	33.5	31.0
GPRS (GMSK, 1Tx-slot)	33.5	31.0
GPRS (GMSK, 2Tx-slot)	33.5	30.5
EDGE (8PSK, 1Tx-slot)	28.5	27.5
EDGE (8PSK, 2Tx-slot)	28.0	27.0

Mode	WCDMA Band II	WCDMA Band V
RMC 12.2K	24.0	23.0
HSDPA	23.0	22.0
HSUPA	23.0	22.0

Mode	LTE 7
QPSK / 16QAM	20.9

Mode	2.4G WLAN	5.2G WLAN	5.3G WLAN	5.6G WLAN
802.11b	15.0	N/A	N/A	N/A
802.11g	13.5	N/A	N/A	N/A
802.11a	N/A	9.0	9.0	10.0
802.11n HT20	12.0	9.0	9.0	10.0
802.11n HT40	13.0	9.5	9.0	10.0

Mode	Bluetooth
All	10.0

4.6.2 Measured Conducted Power Result

The measuring conducted average power (Unit: dBm) is shown as below.

Band	GSM850			GSM1900		
Channel	128	189	251	512	661	810
Frequency (MHz)	824.2	836.4	848.8	1850.2	1880.0	1909.8
Maximum Burst-Averaged Output Power						
GSM (GMSK, 1Tx-slot)	32.71	33.03	32.94	30.84	30.62	30.53
GPRS (GMSK, 1Tx-slot)	32.69	33.02	32.93	30.83	30.60	30.55
GPRS (GMSK, 2Tx-slot)	32.57	32.94	32.40	30.05	29.67	29.62
EDGE (8PSK, 1Tx-slot)	27.89	28.19	27.82	26.98	26.53	26.42
EDGE (8PSK, 2Tx-slot)	27.38	27.69	27.27	26.50	26.03	25.91
Maximum Frame-Averaged Output Power						
GSM (GMSK, 1Tx-slot)	23.71	24.03	23.94	21.84	21.62	21.53
GPRS (GMSK, 1Tx-slot)	23.69	24.02	23.93	21.83	21.60	21.55
GPRS (GMSK, 2Tx-slot)	26.57	26.94	26.40	24.05	23.67	23.62
EDGE (8PSK, 1Tx-slot)	18.89	19.19	18.82	17.98	17.53	17.42
EDGE (8PSK, 2Tx-slot)	21.38	21.69	21.27	20.50	20.03	19.91

Note:

- SAR testing was performed on the maximum frame-averaged power mode.
- The frame-averaged power is linearly proportion to the slot number configured and it is linearly scaled the maximum burst-averaged power based on time slots. The calculated method is shown as below:

$$\text{Frame-averaged power} = 10 \times \log (\text{Burst-averaged power mW} \times \text{Slot used} / 8)$$

Band	WCDMA Band II			WCDMA Band V			3GPP MPR (dB)
Channel	9262	9400	9538	4132	4182	4233	
Frequency (MHz)	1852.4	1880.0	1907.6	826.4	836.4	846.6	
RMC 12.2K	23.51	23.52	23.68	22.59	22.48	22.51	-
HSDPA Subtest-1	22.58	22.72	22.51	21.66	21.61	21.64	0
HSDPA Subtest-2	22.48	22.51	22.50	21.62	21.60	21.57	0
HSDPA Subtest-3	22.12	22.16	22.04	20.99	20.95	20.98	0.5
HSDPA Subtest-4	22.08	22.21	22.25	21.15	21.04	21.06	0.5
HSUPA Subtest-1	22.23	22.49	22.32	21.32	21.28	21.39	0
HSUPA Subtest-2	20.35	20.42	20.37	19.39	19.33	19.42	2
HSUPA Subtest-3	21.22	21.56	21.18	20.35	20.30	20.39	1
HSUPA Subtest-4	20.18	20.23	20.15	19.16	19.09	19.22	2
HSUPA Subtest-5	22.52	22.63	22.58	21.45	21.44	21.43	0

FCC SAR Test Report

LTE Band / BW	RB Size	RB Offset	QPSK			3GPP MPR (dB)	16QAM			3GPP MPR (dB)
			Low CH 20775	Mid CH 21100	High CH 21425		Low CH 20775	Mid CH 21100	High CH 21425	
			2502.5 MHz	2535.0 MHz	2567.5 MHz		2502.5 MHz	2535.0 MHz	2567.5 MHz	
7 / 5M	1	0	20.65	20.72	20.67	0	19.47	19.51	19.58	1
	1	12	20.43	20.59	20.50	0	19.31	19.50	19.50	1
	1	24	20.41	20.51	20.35	0	19.38	19.42	19.53	1
	12	0	19.59	19.58	19.69	1	18.64	18.54	18.56	2
	12	6	19.39	19.50	19.54	1	18.62	18.74	18.64	2
	12	13	19.54	19.44	19.41	1	18.60	18.65	18.68	2
	25	0	19.48	19.45	19.47	1	18.53	18.60	18.72	2

LTE Band / BW	RB Size	RB Offset	QPSK			3GPP MPR (dB)	16QAM			3GPP MPR (dB)
			Low CH 20800	Mid CH 21100	High CH 21400		Low CH 20800	Mid CH 21100	High CH 21400	
			2505.0 MHz	2535.0 MHz	2565.0 MHz		2505.0 MHz	2535.0 MHz	2565.0 MHz	
7 / 10M	1	0	20.69	20.76	20.71	0	19.51	19.55	19.62	1
	1	24	20.47	20.63	20.54	0	19.35	19.54	19.54	1
	1	49	20.45	20.55	20.39	0	19.42	19.46	19.57	1
	25	0	19.63	19.62	19.73	1	18.68	18.58	18.60	2
	25	12	19.43	19.54	19.58	1	18.66	18.78	18.68	2
	25	25	19.58	19.48	19.45	1	18.64	18.69	18.72	2
	50	0	19.52	19.49	19.51	1	18.57	18.64	18.76	2

LTE Band / BW	RB Size	RB Offset	QPSK			3GPP MPR (dB)	16QAM			3GPP MPR (dB)
			Low CH 20825	Mid CH 21100	High CH 21375		Low CH 20825	Mid CH 21100	High CH 21375	
			2507.5 MHz	2535.0 MHz	2562.5 MHz		2507.5 MHz	2535.0 MHz	2562.5 MHz	
7 / 15M	1	0	20.75	20.82	20.77	0	19.57	19.61	19.68	1
	1	37	20.53	20.69	20.60	0	19.41	19.60	19.60	1
	1	74	20.51	20.61	20.45	0	19.48	19.52	19.63	1
	36	0	19.69	19.68	19.79	1	18.74	18.64	18.66	2
	36	19	19.49	19.60	19.64	1	18.72	18.84	18.74	2
	36	39	19.64	19.54	19.51	1	18.7	18.75	18.78	2
	75	0	19.58	19.55	19.57	1	18.63	18.70	18.82	2

LTE Band / BW	RB Size	RB Offset	QPSK			3GPP MPR (dB)	16QAM			3GPP MPR (dB)
			Low CH 20850	Mid CH 21100	High CH 21350		Low CH 20850	Mid CH 21100	High CH 21350	
			2510.0 MHz	2535.0 MHz	2560.0 MHz		2510.0 MHz	2535.0 MHz	2560.0 MHz	
7 / 20M	1	0	20.78	20.85	20.80	0	19.60	19.64	19.71	1
	1	50	20.56	20.72	20.63	0	19.44	19.63	19.63	1
	1	99	20.54	20.64	20.48	0	19.51	19.55	19.66	1
	50	0	19.72	19.71	19.82	1	18.77	18.67	18.69	2
	50	25	19.52	19.63	19.67	1	18.75	18.87	18.77	2
	50	50	19.67	19.57	19.54	1	18.73	18.78	18.81	2
	100	0	19.61	19.58	19.60	1	18.66	18.73	18.85	2

<WLAN 2.4G>

Mode	802.11b		
Channel / Frequency (MHz)	1 (2412)	6 (2437)	11 (2462)
Average Power	14.41	14.78	14.02
Mode	802.11g		
Channel / Frequency (MHz)	1 (2412)	6 (2437)	11 (2462)
Average Power	13.15	12.85	12.30
Mode	802.11n (HT20)		
Channel / Frequency (MHz)	1 (2412)	6 (2437)	11 (2462)
Average Power	11.85	11.78	10.52
Mode	802.11n (HT40)		
Channel / Frequency (MHz)	3 (2422)	6 (2437)	9 (2452)
Average Power	12.75	12.75	11.23

<WLAN 5.2G>

Mode	802.11a			
Channel / Frequency (MHz)	36 (5180)	40 (5200)	44 (5220)	48 (5240)
Average Power	8.26	8.82	8.56	8.57
Mode	802.11n (HT20)			
Channel / Frequency (MHz)	36 (5180)	40 (5200)	44 (5220)	48 (5240)
Average Power	8.12	8.89	8.74	8.61
Mode	802.11n (HT40)			
Channel / Frequency (MHz)	38 (5190)		46 (5230)	
Average Power	9.06		8.13	

<WLAN 5.3G>

Mode	802.11a			
Channel / Frequency (MHz)	52 (5260)	56 (5280)	60 (5300)	64 (5320)
Average Power	8.81	8.52	8.67	8.89
Mode	802.11n (HT20)			
Channel / Frequency (MHz)	52 (5260)	56 (5280)	60 (5300)	64 (5320)
Average Power	8.78	8.53	8.59	8.85
Mode	802.11n (HT40)			
Channel / Frequency (MHz)	54 (5270)		62 (5310)	
Average Power	8.80		8.84	

<WLAN 5.6G>

Mode	802.11a							
Channel / Frequency (MHz)	100 (5500)	104 (5520)	108 (5540)	112 (5560)	116 (5580)	132 (5660)	136 (5680)	140 (5700)
Average Power	8.86	8.46	8.23	9.43	9.98	8.91	9.34	9.71
Mode	802.11n (HT20)							
Channel / Frequency (MHz)	100 (5500)	104 (5520)	108 (5540)	112 (5560)	116 (5580)	132 (5660)	136 (5680)	140 (5700)
Average Power	8.84	8.36	8.87	9.74	9.78	8.79	9.22	9.49
Mode	802.11n (HT40)							
Channel / Frequency (MHz)	102 (5510)				134 (5670)			
Average Power	9.05				9.58			

4.7 SAR Testing Results

4.7.1 SAR Results for Head

Plot No.	Band	Mode	Test Position	Ch.	Max. Tune-up Power (dBm)	Measured Conducted Power (dBm)	Scaling Factor	Power Drift (dB)	Measured SAR-1g (W/kg)	Scaled SAR-1g (W/kg)
01	GSM850	GPRS10	Right Cheek	189	33.5	32.94	1.14	0.19	0.767	0.87
	GSM850	GPRS10	Right Cheek	128	33.5	32.57	1.24	0.14	0.747	0.93
	GSM850	GPRS10	Right Cheek	251	33.5	32.40	1.29	-0.11	0.706	0.91
	GSM850	GPRS10	Right Tilted	189	33.5	32.94	1.14	-0.16	0.42	0.48
	GSM850	GPRS10	Left Cheek	189	33.5	32.94	1.14	-0.04	0.637	0.72
	GSM850	GPRS10	Left Tilted	189	33.5	32.94	1.14	0.08	0.397	0.45
02	GSM1900	GPRS10	Right Cheek	512	30.5	30.05	1.11	0.11	0.342	0.38
	GSM1900	GPRS10	Right Tilted	512	30.5	30.05	1.11	-0.13	0.065	0.07
	GSM1900	GPRS10	Left Cheek	512	30.5	30.05	1.11	0.15	0.298	0.33
	GSM1900	GPRS10	Left Tilted	512	30.5	30.05	1.11	0.05	0.102	0.11
03	WCDMA II	RMC12.2K	Right Cheek	9538	24.0	23.68	1.08	-0.17	0.371	0.40
	WCDMA II	RMC12.2K	Right Tilted	9538	24.0	23.68	1.08	-0.05	0.062	0.07
	WCDMA II	RMC12.2K	Left Cheek	9538	24.0	23.68	1.08	0.12	0.409	0.44
	WCDMA II	RMC12.2K	Left Tilted	9538	24.0	23.68	1.08	0.16	0.113	0.12
04	WCDMA V	RMC12.2K	Right Cheek	4132	23.0	22.59	1.10	-0.11	0.464	0.51
	WCDMA V	RMC12.2K	Right Tilted	4132	23.0	22.59	1.10	-0.16	0.263	0.29
	WCDMA V	RMC12.2K	Left Cheek	4132	23.0	22.59	1.10	0.09	0.393	0.43
	WCDMA V	RMC12.2K	Left Tilted	4132	23.0	22.59	1.10	-0.056	0.261	0.29

Note:

- SAR is performed on the highest power channel. When the reported SAR value of highest power channel is \leq 0.8 W/kg, SAR testing for optional channel is not required.
- Since GPRS/EDGE of this device supports VOIP capability through 3rd party apps software, we have evaluated data mode for head SAR.

Plot No.	Band	Mode	Test Position	Ch.	RB#	RB Offset	Max. Tune-up Power (dBm)	Measured Conducted Power (dBm)	Scaling Factor	Power Drift (dB)	Measured SAR-1g (W/kg)	Scaled SAR-1g (W/kg)
05	LTE 7	QPSK20M	Right Cheek	21100	1	0	20.9	20.85	1.01	0.02	0.095	0.10
	LTE 7	QPSK20M	Right Cheek	21350	50	0	19.9	19.82	1.02	0.09	0.081	0.08
	LTE 7	QPSK20M	Right Tilted	21100	1	0	20.9	20.85	1.01	0.04	0.032	0.03
	LTE 7	QPSK20M	Right Tilted	21350	50	0	19.9	19.82	1.02	0.09	0.029	0.03
	LTE 7	QPSK20M	Left Cheek	21100	1	0	20.9	20.85	1.01	-0.04	0.145	0.15
	LTE 7	QPSK20M	Left Cheek	21350	50	0	19.9	19.82	1.02	0.07	0.128	0.13
	LTE 7	QPSK20M	Left Tilted	21100	1	0	20.9	20.85	1.01	0.1	0.035	0.04
	LTE 7	QPSK20M	Left Tilted	21350	50	0	19.9	19.82	1.02	0.02	0.030	0.03

Note:

- According to KDB 941225, LTE SAR testing for remaining RB offset configurations and required test channels is not required when the reported SAR of highest power 1RB configuration is less than 0.8 W/kg.
- According to KDB 941225, LTE SAR testing for remaining RB offset configurations and required test channels is not required when the reported SAR of highest power 50% RB configuration is less than 0.8 W/kg.
- According to KDB 941225, LTE SAR testing for 100% RB is not required when the maximum power of 100% RB is less than the maximum power of 1RB and 50% RB, and the highest reported SAR for 1RB and 50% RB is less than 0.8 W/kg.
- According to KDB 941225, LTE SAR testing for 16QAM is not required when the maximum power of 16QAM is less 1/2 dB higher than QPSK, and the highest reported SAR of QPSK is less than 1.45 W/kg.
- According to KDB 941225, LTE SAR testing for smaller channel bandwidth is not required when the maximum power of smaller channel bandwidth is less 1/2 dB higher than largest channel bandwidth, and the highest reported SAR of largest channel bandwidth is less than 1.45 W/kg.

FCC SAR Test Report

Plot No.	Band	Mode	Test Position	Ch.	Max. Tune-up Power (dBm)	Measured Conducted Power (dBm)	Scaling Factor	Power Drift (dB)	Measured SAR-1g (W/kg)	Scaled SAR-1g (W/kg)
	2.4G WLAN	802.11b	Right Cheek	6	15.0	14.78	1.05	0.12	0.000213	0.00
	2.4G WLAN	802.11b	Right Tilted	6	15.0	14.78	1.05	0.07	0.000517	0.00
06	2.4G WLAN	802.11b	Left Cheek	6	15.0	14.78	1.05	0.15	0.00867	0.01
	2.4G WLAN	802.11b	Left Tilted	6	15.0	14.78	1.05	0.01	0.00462	0.00
	5.2G WLAN	802.11n HT40	Right Cheek	38	9.5	9.06	1.11	0.00	0.00	0.00
	5.2G WLAN	802.11n HT40	Right Tilted	38	9.5	9.06	1.11	0.01	0.000141	0.00
	5.2G WLAN	802.11n HT40	Left Cheek	38	9.5	9.06	1.11	0.19	0.00214	0.00
07	5.2G WLAN	802.11n HT40	Left Tilted	38	9.5	9.06	1.11	0.04	0.00347	0.00
	5.6G WLAN	802.11n HT40	Right Cheek	134	10.0	9.58	1.10	0.00	0.00	0.00
	5.6G WLAN	802.11n HT40	Right Tilted	134	10.0	9.58	1.10	0.14	0.00138	0.00
	5.6G WLAN	802.11n HT40	Left Cheek	134	10.0	9.58	1.10	0.01	0.00213	0.00
08	5.6G WLAN	802.11n HT40	Left Tilted	134	10.0	9.58	1.10	0.07	0.00465	0.01

Note:

- For handsets operating next to ear, hotspot mode or mini-tablet configurations, the initial test position procedures were applied. The test position with the highest extrapolated peak SAR will be used as the initial test position. When the reported SAR of initial test position is ≤ 0.4 W/kg, SAR testing for remaining test positions is not required. Otherwise, SAR is evaluated at the subsequent highest peak SAR positions until the reported SAR result is ≤ 0.8 W/kg or all test positions are measured.
- For WLAN 2.4 GHz, the highest measured maximum output power channel for DSSS was selected for SAR measurement. When the reported SAR is ≤ 0.8 W/kg, no further SAR testing is required. Otherwise, SAR is evaluated at the next highest measured output power channel. When any reported SAR is > 1.2 W/kg, SAR is required for the third channel. For OFDM modes (802.11g/n), SAR is not required when the highest reported SAR for DSSS is adjusted by the ratio of OFDM to DSSS specified maximum output power and it is ≤ 1.2 W/kg.
- For WLAN 5 GHz, the initial test configuration was selected according to the transmission mode with the highest maximum output power. When the reported SAR of initial test configuration is > 0.8 W/kg, SAR is required for the subsequent highest measured output power channel until the reported SAR result is ≤ 1.2 W/kg or all required channels are measured. For other transmission modes, SAR is not required when the highest reported SAR for initial test configuration is adjusted by the ratio of subsequent test configuration to initial test configuration specified maximum output power and it is ≤ 1.2 W/kg.

4.7.2 SAR Results for Body-Worn (Separation Distance is 1.0 cm Gap)

Plot No.	Band	Mode	Test Position	Ch.	Max. Tune-up Power (dBm)	Measured Conducted Power (dBm)	Scaling Factor	Power Drift (dB)	Measured SAR-1g (W/kg)	Scaled SAR-1g (W/kg)
09	GSM850	GPRS10	Front Face	189	33.5	32.94	1.14	0.03	0.776	0.88
	GSM850	GPRS10	Front Face	128	33.5	32.57	1.24	-0.05	0.765	0.95
	GSM850	GPRS10	Front Face	251	33.5	32.40	1.29	0.15	0.675	0.87
	GSM850	GPRS10	Rear Face	189	33.5	32.94	1.14	-0.02	0.542	0.62
10	GSM1900	GPRS10	Front Face	512	30.5	30.05	1.11	-0.02	0.437	0.48
	GSM1900	GPRS10	Rear Face	512	30.5	30.05	1.11	0.02	0.250	0.28
11	WCDMA II	RMC12.2K	Front Face	9538	24.0	23.68	1.08	-0.12	0.562	0.60
	WCDMA II	RMC12.2K	Rear Face	9538	24.0	23.68	1.08	0.07	0.308	0.33
12	WCDMA V	RMC12.2K	Front Face	4132	23.0	22.59	1.10	-0.02	0.486	0.53
	WCDMA V	RMC12.2K	Rear Face	4132	23.0	22.59	1.10	0.03	0.349	0.38

Note:

- SAR is performed on the highest power channel. When the reported SAR value of highest power channel is <= 0.8 W/kg, SAR testing for optional channel is not required.

Plot No.	Band	Mode	Test Position	Ch.	RB#	RB Offset	Max. Tune-up Power (dBm)	Measured Conducted Power (dBm)	Scaling Factor	Power Drift (dB)	Measured SAR-1g (W/kg)	Scaled SAR-1g (W/kg)
	LTE 7	QPSK20M	Front Face	21100	1	0	20.9	20.85	1.01	0.10	0.370	0.37
	LTE 7	QPSK20M	Front Face	21350	50	0	19.9	19.82	1.02	0.03	0.311	0.32
13	LTE 7	QPSK20M	Rear Face	21100	1	0	20.9	20.85	1.01	0.03	0.406	0.41
	LTE 7	QPSK20M	Rear Face	21350	50	0	19.9	19.82	1.02	0.09	0.341	0.35

Note:

- According to KDB 941225, LTE SAR testing for remaining RB offset configurations and required test channels is not required when the reported SAR of highest power 1RB configuration is less than 0.8 W/kg.
- According to KDB 941225, LTE SAR testing for remaining RB offset configurations and required test channels is not required when the reported SAR of highest power 50% RB configuration is less than 0.8 W/kg.
- According to KDB 941225, LTE SAR testing for 100% RB is not required when the maximum power of 100% RB is less than the maximum power of 1RB and 50% RB, and the highest reported SAR for 1RB and 50% RB is less than 0.8 W/kg.
- According to KDB 941225, LTE SAR testing for 16QAM is not required when the maximum power of 16QAM is less 1/2 dB higher than QPSK, and the highest reported SAR of QPSK is less than 1.45 W/kg.
- According to KDB 941225, LTE SAR testing for smaller channel bandwidth is not required when the maximum power of smaller channel bandwidth is less 1/2 dB higher than largest channel bandwidth, and the highest reported SAR of largest channel bandwidth is less than 1.45 W/kg.



FCC SAR Test Report

A D T

Plot No.	Band	Mode	Test Position	Ch.	Max. Tune-up Power (dBm)	Measured Conducted Power (dBm)	Scaling Factor	Power Drift (dB)	Measured SAR-1g (W/kg)	Scaled SAR-1g (W/kg)
	2.4G WLAN	802.11b	Front Face	6	15.0	14.78	1.05	-0.02	0.00132	0.00
14	2.4G WLAN	802.11b	Rear Face	6	15.0	14.78	1.05	0.12	0.011	0.01

Note:

1. For handsets operating next to ear, hotspot mode or mini-tablet configurations, the initial test position procedures were applied. The test position with the highest extrapolated peak SAR will be used as the initial test position. When the reported SAR of initial test position is ≤ 0.4 W/kg, SAR testing for remaining test positions is not required. Otherwise, SAR is evaluated at the subsequent highest peak SAR positions until the reported SAR result is ≤ 0.8 W/kg or all test positions are measured.
2. For WLAN 2.4 GHz, the highest measured maximum output power channel for DSSS was selected for SAR measurement. When the reported SAR is ≤ 0.8 W/kg, no further SAR testing is required. Otherwise, SAR is evaluated at the next highest measured output power channel. When any reported SAR is > 1.2 W/kg, SAR is required for the third channel. For OFDM modes (802.11g/n), SAR is not required when the highest reported SAR for DSSS is adjusted by the ratio of OFDM to DSSS specified maximum output power and it is ≤ 1.2 W/kg.

FCC SAR Test Report

4.7.3 SAR Results for Hotspot (Separation Distance is 1.0 cm Gap)

Plot No.	Band	Mode	Test Position	Ch.	Max. Tune-up Power (dBm)	Measured Conducted Power (dBm)	Scaling Factor	Power Drift (dB)	Measured SAR-1g (W/kg)	Scaled SAR-1g (W/kg)
09	GSM850	GPRS10	Front Face	189	33.5	32.94	1.14	0.03	0.776	0.88
	GSM850	GPRS10	Front Face	128	33.5	32.57	1.24	-0.05	0.765	0.95
	GSM850	GPRS10	Front Face	251	33.5	32.40	1.29	0.15	0.675	0.87
	GSM850	GPRS10	Rear Face	189	33.5	32.94	1.14	-0.02	0.542	0.62
	GSM850	GPRS10	Left Side	189	33.5	32.94	1.14	0.02	0.501	0.57
	GSM850	GPRS10	Right Side	189	33.5	32.94	1.14	-0.05	0.648	0.74
	GSM850	GPRS10	Bottom Side	189	33.5	32.94	1.14	0.12	0.177	0.20
15	GSM1900	GPRS10	Front Face	512	30.5	30.05	1.11	-0.02	0.437	0.48
	GSM1900	GPRS10	Rear Face	512	30.5	30.05	1.11	0.02	0.250	0.28
	GSM1900	GPRS10	Left Side	512	30.5	30.05	1.11	0.1	0.162	0.18
	GSM1900	GPRS10	Right Side	512	30.5	30.05	1.11	0.04	0.116	0.13
	GSM1900	GPRS10	Bottom Side	512	30.5	30.05	1.11	0.01	0.502	0.56
16	WCDMA II	RMC12.2K	Front Face	9538	24.0	23.68	1.08	-0.12	0.562	0.60
	WCDMA II	RMC12.2K	Rear Face	9538	24.0	23.68	1.08	0.07	0.308	0.33
	WCDMA II	RMC12.2K	Left Side	9538	24.0	23.68	1.08	0.02	0.161	0.17
	WCDMA II	RMC12.2K	Right Side	9538	24.0	23.68	1.08	0.09	0.128	0.14
	WCDMA II	RMC12.2K	Bottom Side	9538	24.0	23.68	1.08	0	0.627	0.67
12	WCDMA V	RMC12.2K	Front Face	4132	23.0	22.59	1.10	-0.02	0.486	0.53
	WCDMA V	RMC12.2K	Rear Face	4132	23.0	22.59	1.10	0.03	0.349	0.38
	WCDMA V	RMC12.2K	Left Side	4132	23.0	22.59	1.10	-0.04	0.314	0.35
	WCDMA V	RMC12.2K	Right Side	4132	23.0	22.59	1.10	-0.03	0.437	0.48
	WCDMA V	RMC12.2K	Bottom Side	4132	23.0	22.59	1.10	0.15	0.096	0.11

Note:

- SAR is performed on the highest power channel. When the reported SAR value of highest power channel is ≤ 0.8 W/kg, SAR testing for optional channel is not required.

Plot No.	Band	Mode	Test Position	Ch.	RB#	RB Offset	Max. Tune-up Power (dBm)	Measured Conducted Power (dBm)	Scaling Factor	Power Drift (dB)	Measured SAR-1g (W/kg)	Scaled SAR-1g (W/kg)
17	LTE 7	QPSK20M	Front Face	21100	1	0	20.9	20.85	1.01	0.1	0.370	0.37
	LTE 7	QPSK20M	Front Face	21350	50	0	19.9	19.82	1.02	0.03	0.311	0.32
	LTE 7	QPSK20M	Rear Face	21100	1	0	20.9	20.85	1.01	0.03	0.406	0.41
	LTE 7	QPSK20M	Rear Face	21350	50	0	19.9	19.82	1.02	0.09	0.341	0.35
	LTE 7	QPSK20M	Left Side	21100	1	0	20.9	20.85	1.01	0.11	0.085	0.09
	LTE 7	QPSK20M	Left Side	21350	50	0	19.9	19.82	1.02	0.14	0.086	0.09
	LTE 7	QPSK20M	Right Side	21100	1	0	20.9	20.85	1.01	-0.04	0.044	0.04
	LTE 7	QPSK20M	Right Side	21350	50	0	19.9	19.82	1.02	0.13	0.037	0.04
	LTE 7	QPSK20M	Bottom Side	21100	1	0	20.9	20.85	1.01	-0.14	1.09	1.10
	LTE 7	QPSK20M	Bottom Side	20850	1	0	20.9	20.78	1.03	0.13	0.998	1.03
	LTE 7	QPSK20M	Bottom Side	21350	1	0	20.9	20.80	1.02	0.15	1.14	1.17
	LTE 7	QPSK20M	Bottom Side	21350	1	0	20.9	20.80	1.02	0.03	1.10	1.13
	LTE 7	QPSK20M	Bottom Side	21350	50	0	19.9	19.82	1.02	-0.03	0.894	0.91
	LTE 7	QPSK20M	Bottom Side	20850	50	0	19.9	19.72	1.04	0.05	0.767	0.80
LTE 7	QPSK20M	Bottom Side	21100	50	0	19.9	19.71	1.04	0.05	0.876	0.92	
LTE 7	QPSK20M	Bottom Side	20850	100	0	19.9	19.61	1.07	0.06	0.789	0.84	

Note:

- According to KDB 941225, LTE SAR testing for remaining RB offset configurations and required test channels is not required when the reported SAR of highest power 1RB configuration is less than 0.8 W/kg.
- According to KDB 941225, LTE SAR testing for remaining RB offset configurations and required test channels is not required when the reported SAR of highest power 50% RB configuration is less than 0.8 W/kg.
- According to KDB 941225, LTE SAR testing for 100% RB is not required when the maximum power of 100% RB is less than the maximum power of 1RB and 50% RB, and the highest reported SAR for 1RB and 50% RB is less

FCC SAR Test Report

than 0.8 W/kg.

4. According to KDB 941225, LTE SAR testing for 16QAM is not required when the maximum power of 16QAM is less 1/2 dB higher than QPSK, and the highest reported SAR of QPSK is less than 1.45 W/kg.
5. According to KDB 941225, LTE SAR testing for smaller channel bandwidth is not required when the maximum power of smaller channel bandwidth is less 1/2 dB higher than largest channel bandwidth, and the highest reported SAR of largest channel bandwidth is less than 1.45 W/kg.

Plot No.	Band	Mode	Test Position	Ch.	Max. Tune-up Power (dBm)	Measured Conducted Power (dBm)	Scaling Factor	Power Drift (dB)	Measured SAR-1g (W/kg)	Scaled SAR-1g (W/kg)
	2.4G WLAN	802.11b	Front Face	6	15.0	14.78	1.05	-0.02	0.00132	0.00
	2.4G WLAN	802.11b	Rear Face	6	15.0	14.78	1.05	0.12	0.011	0.01
18	2.4G WLAN	802.11b	Right Side	6	15.0	14.78	1.05	0.03	0.012	0.01

Note:

1. For handsets operating next to ear, hotspot mode or mini-tablet configurations, the initial test position procedures were applied. The test position with the highest extrapolated peak SAR will be used as the initial test position. When the reported SAR of initial test position is ≤ 0.4 W/kg, SAR testing for remaining test positions is not required. Otherwise, SAR is evaluated at the subsequent highest peak SAR positions until the reported SAR result is ≤ 0.8 W/kg or all test positions are measured.
2. For WLAN 2.4 GHz, the highest measured maximum output power channel for DSSS was selected for SAR measurement. When the reported SAR is ≤ 0.8 W/kg, no further SAR testing is required. Otherwise, SAR is evaluated at the next highest measured output power channel. When any reported SAR is > 1.2 W/kg, SAR is required for the third channel. For OFDM modes (802.11g/n), SAR is not required when the highest reported SAR for DSSS is adjusted by the ratio of OFDM to DSSS specified maximum output power and it is ≤ 1.2 W/kg.

FCC SAR Test Report

4.7.4 SAR Measurement Variability

According to KDB 865664 D01, SAR measurement variability was assessed for each frequency band, which is determined by the SAR probe calibration point and tissue-equivalent medium used for the device measurements. When both head and body tissue-equivalent media are required for SAR measurements in a frequency band, the variability measurement procedures should be applied to the tissue medium with the highest measured SAR, using the highest measured SAR configuration for that tissue-equivalent medium. Alternatively, if the highest measured SAR for both head and body tissue-equivalent media are ≤ 1.45 W/kg and the ratio of these highest SAR values, i.e., largest divided by smallest value, is ≤ 1.10 , the highest SAR configuration for either head or body tissue-equivalent medium may be used to perform the repeated measurement. These additional measurements are repeated after the completion of all measurements requiring the same head or body tissue-equivalent medium in a frequency band. The test device should be returned to ambient conditions (normal room temperature) with the battery fully charged before it is re-mounted on the device holder for the repeated measurement(s) to minimize any unexpected variations in the repeated results.

SAR repeated measurement procedure:

1. When the highest measured SAR is < 0.80 W/kg, repeated measurement is not required.
2. When the highest measured SAR is ≥ 0.80 W/kg, repeat that measurement once.
3. If the ratio of largest to smallest SAR for the original and first repeated measurements is > 1.20 , or when the original or repeated measurement is ≥ 1.45 W/kg, perform a second repeated measurement.
4. If the ratio of largest to smallest SAR for the original, first and second repeated measurements is > 1.20 , and the original, first or second repeated measurement is ≥ 1.5 W/kg, perform a third repeated measurement.

Band	Test Position	Ch.	Original Measured SAR-1g (W/kg)	1st Repeated SAR-1g (W/kg)	L/S Ratio	2nd Repeated SAR-1g (W/kg)	L/S Ratio	3rd Repeated SAR-1g (W/kg)	L/S Ratio
LTE 7	QPSK20M	Bottom Side	21350	1.14	1.10	1.04	N/A	N/A	N/A

FCC SAR Test Report

4.7.5 Simultaneous Multi-band Transmission Evaluation

<Estimated SAR Calculation>

According to KDB 447498 D01, when standalone SAR test exclusion applies to an antenna that transmits simultaneously with other antennas, the standalone SAR was estimated according to following formula to result in substantially conservative SAR values of ≤ 0.4 W/kg to determine simultaneous transmission SAR test exclusion.

$$\text{Estimated SAR} = \frac{\text{Max. Tune up Power}_{(mW)}}{\text{Min. Test Separation Distance}_{(mm)}} \times \frac{\sqrt{f_{(GHz)}}}{7.5}$$

If the minimum test separation distance is < 5 mm, a distance of 5 mm is used for estimated SAR calculation. When the test separation distance is > 50 mm, the 0.4 W/kg is used for SAR-1g.

Mode / Band	Frequency (GHz)	Max. Tune-up Power (dBm)	Test Position	Separation Distance (mm)	Estimated SAR (W/kg)
WLAN (NII)	5.8	10.0	Body	10	0.32
BT (DSS)	2.48	10.0	Body	10	0.21

Note:

1. The separation distance is determined from the outer housing of the EUT to the user.
2. When standalone SAR testing is not required, an estimated SAR can be applied to determine simultaneous transmission SAR test exclusion.

FCC SAR Test Report

<SAR Summation Analysis>

Simultaneous transmission SAR test exclusion is determined for each operating configuration and exposure condition according to the reported standalone SAR of each applicable simultaneous transmitting antenna. When the sum of SAR_{1g} of all simultaneously transmitting antennas in an operating mode and exposure condition combination is within the SAR limit (SAR_{1g} 1.6 W/kg), the simultaneous transmission SAR is not required. When the sum of SAR_{1g} is greater than the SAR limit (SAR_{1g} 1.6 W/kg), SAR test exclusion is determined by the SPLSR.

No.	Conditions (SAR1 + SAR2)	Exposure Condition	Test Position	Max. SAR1	Max. SAR2	SAR Summation	SPLSR Analysis
1	GSM850 + WLAN (DTS)	Head	Right Cheek	0.93	0.00	0.93	ΣSAR < 1.6, Not required
			Right Tilted	0.48	0.00	0.48	ΣSAR < 1.6, Not required
			Left Cheek	0.72	0.01	0.73	ΣSAR < 1.6, Not required
			Left Tilted	0.45	0.00	0.45	ΣSAR < 1.6, Not required
		Body-Worn	Front Face	0.95	0.00	0.95	ΣSAR < 1.6, Not required
			Rear Face	0.62	0.01	0.63	ΣSAR < 1.6, Not required
		Hotspot	Front Face	0.95	0.00	0.95	ΣSAR < 1.6, Not required
			Rear Face	0.62	0.01	0.63	ΣSAR < 1.6, Not required
			Left Side	0.57	0.00	0.57	ΣSAR < 1.6, Not required
			Right Side	0.74	0.01	0.75	ΣSAR < 1.6, Not required
			Top Side	0.00	0.00	0.00	ΣSAR < 1.6, Not required
			Bottom Side	0.20	0.00	0.20	ΣSAR < 1.6, Not required
2	GSM850 + WLAN (NII)	Head	Right Cheek	0.93	0.00	0.93	ΣSAR < 1.6, Not required
			Right Tilted	0.48	0.00	0.48	ΣSAR < 1.6, Not required
			Left Cheek	0.72	0.00	0.72	ΣSAR < 1.6, Not required
			Left Tilted	0.45	0.01	0.46	ΣSAR < 1.6, Not required
		Body-Worn	Front Face	0.95	0.32	1.27	ΣSAR < 1.6, Not required
			Rear Face	0.62	0.32	0.94	ΣSAR < 1.6, Not required
		Hotspot	Front Face	0.95	0.32	1.27	ΣSAR < 1.6, Not required
			Rear Face	0.62	0.32	0.94	ΣSAR < 1.6, Not required
			Left Side	0.57	0.32	0.89	ΣSAR < 1.6, Not required
			Right Side	0.74	0.32	1.06	ΣSAR < 1.6, Not required
			Top Side	0.00	0.32	0.32	ΣSAR < 1.6, Not required
			Bottom Side	0.20	0.32	0.52	ΣSAR < 1.6, Not required
3	GSM850 + BT (DSS)	Body-Worn	Front Face	0.95	0.21	1.16	ΣSAR < 1.6, Not required
			Rear Face	0.62	0.21	0.83	ΣSAR < 1.6, Not required



FCC SAR Test Report

A D T

No.	Conditions (SAR1 + SAR2)	Exposure Condition	Test Position	Max. SAR1	Max. SAR2	SAR Summation	SPLSR Analysis
4	GSM1900 + WLAN (DTS)	Head	Right Cheek	0.38	0.00	0.38	Σ SAR < 1.6, Not required
			Right Tilted	0.07	0.00	0.07	Σ SAR < 1.6, Not required
			Left Cheek	0.33	0.01	0.34	Σ SAR < 1.6, Not required
			Left Tilted	0.11	0.00	0.11	Σ SAR < 1.6, Not required
		Body-Worn	Front Face	0.48	0.00	0.48	Σ SAR < 1.6, Not required
			Rear Face	0.28	0.01	0.29	Σ SAR < 1.6, Not required
		Hotspot	Front Face	0.48	0.00	0.48	Σ SAR < 1.6, Not required
			Rear Face	0.28	0.01	0.29	Σ SAR < 1.6, Not required
			Left Side	0.18	0.00	0.18	Σ SAR < 1.6, Not required
			Right Side	0.13	0.01	0.14	Σ SAR < 1.6, Not required
			Top Side	0.00	0.00	0.00	Σ SAR < 1.6, Not required
			Bottom Side	0.56	0.00	0.56	Σ SAR < 1.6, Not required
5	GSM1900 + WLAN (NII)	Head	Right Cheek	0.38	0.00	0.38	Σ SAR < 1.6, Not required
			Right Tilted	0.07	0.00	0.07	Σ SAR < 1.6, Not required
			Left Cheek	0.33	0.00	0.33	Σ SAR < 1.6, Not required
			Left Tilted	0.11	0.01	0.12	Σ SAR < 1.6, Not required
		Body-Worn	Front Face	0.48	0.32	0.80	Σ SAR < 1.6, Not required
			Rear Face	0.28	0.32	0.60	Σ SAR < 1.6, Not required
		Hotspot	Front Face	0.48	0.32	0.80	Σ SAR < 1.6, Not required
			Rear Face	0.28	0.32	0.60	Σ SAR < 1.6, Not required
			Left Side	0.18	0.32	0.50	Σ SAR < 1.6, Not required
			Right Side	0.13	0.32	0.45	Σ SAR < 1.6, Not required
			Top Side	0.00	0.32	0.32	Σ SAR < 1.6, Not required
			Bottom Side	0.56	0.32	0.88	Σ SAR < 1.6, Not required
6	GSM1900 + BT (DSS)	Body-Worn	Front Face	0.48	0.21	0.69	Σ SAR < 1.6, Not required
			Rear Face	0.28	0.21	0.49	Σ SAR < 1.6, Not required



FCC SAR Test Report

No.	Conditions (SAR1 + SAR2)	Exposure Condition	Test Position	Max. SAR1	Max. SAR2	SAR Summation	SPLSR Analysis
7	WCDMA II + WLAN (DTS)	Head	Right Cheek	0.40	0.00	0.40	Σ SAR < 1.6, Not required
			Right Tilted	0.07	0.00	0.07	Σ SAR < 1.6, Not required
			Left Cheek	0.44	0.01	0.45	Σ SAR < 1.6, Not required
			Left Tilted	0.12	0.00	0.12	Σ SAR < 1.6, Not required
		Body-Worn	Front Face	0.60	0.00	0.60	Σ SAR < 1.6, Not required
			Rear Face	0.33	0.01	0.34	Σ SAR < 1.6, Not required
		Hotspot	Front Face	0.60	0.00	0.60	Σ SAR < 1.6, Not required
			Rear Face	0.33	0.01	0.34	Σ SAR < 1.6, Not required
			Left Side	0.17	0.00	0.17	Σ SAR < 1.6, Not required
			Right Side	0.14	0.01	0.15	Σ SAR < 1.6, Not required
			Top Side	0.00	0.00	0.00	Σ SAR < 1.6, Not required
			Bottom Side	0.67	0.00	0.67	Σ SAR < 1.6, Not required
8	WCDMA II + WLAN (NII)	Head	Right Cheek	0.40	0.00	0.40	Σ SAR < 1.6, Not required
			Right Tilted	0.07	0.00	0.07	Σ SAR < 1.6, Not required
			Left Cheek	0.44	0.00	0.44	Σ SAR < 1.6, Not required
			Left Tilted	0.12	0.01	0.13	Σ SAR < 1.6, Not required
		Body-Worn	Front Face	0.60	0.32	0.92	Σ SAR < 1.6, Not required
			Rear Face	0.33	0.32	0.65	Σ SAR < 1.6, Not required
		Hotspot	Front Face	0.60	0.32	0.92	Σ SAR < 1.6, Not required
			Rear Face	0.33	0.32	0.65	Σ SAR < 1.6, Not required
			Left Side	0.17	0.32	0.49	Σ SAR < 1.6, Not required
			Right Side	0.14	0.32	0.46	Σ SAR < 1.6, Not required
			Top Side	0.00	0.32	0.32	Σ SAR < 1.6, Not required
			Bottom Side	0.67	0.32	0.99	Σ SAR < 1.6, Not required
9	WCDMA II + BT (DSS)	Body-Worn	Front Face	0.60	0.21	0.81	Σ SAR < 1.6, Not required
			Rear Face	0.33	0.21	0.54	Σ SAR < 1.6, Not required



FCC SAR Test Report

A D T

No.	Conditions (SAR1 + SAR2)	Exposure Condition	Test Position	Max. SAR1	Max. SAR2	SAR Summation	SPLSR Analysis
10	WCDMA V + WLAN (DTS)	Head	Right Cheek	0.51	0.00	0.51	Σ SAR < 1.6, Not required
			Right Tilted	0.29	0.00	0.29	Σ SAR < 1.6, Not required
			Left Cheek	0.43	0.01	0.44	Σ SAR < 1.6, Not required
			Left Tilted	0.29	0.00	0.29	Σ SAR < 1.6, Not required
		Body-Worn	Front Face	0.53	0.00	0.53	Σ SAR < 1.6, Not required
			Rear Face	0.38	0.01	0.39	Σ SAR < 1.6, Not required
		Hotspot	Front Face	0.53	0.00	0.53	Σ SAR < 1.6, Not required
			Rear Face	0.38	0.01	0.39	Σ SAR < 1.6, Not required
			Left Side	0.35	0.00	0.35	Σ SAR < 1.6, Not required
			Right Side	0.48	0.01	0.49	Σ SAR < 1.6, Not required
			Top Side	0.00	0.00	0.00	Σ SAR < 1.6, Not required
			Bottom Side	0.11	0.00	0.11	Σ SAR < 1.6, Not required
11	WCDMA V + WLAN (NII)	Head	Right Cheek	0.51	0.00	0.51	Σ SAR < 1.6, Not required
			Right Tilted	0.29	0.00	0.29	Σ SAR < 1.6, Not required
			Left Cheek	0.43	0.00	0.43	Σ SAR < 1.6, Not required
			Left Tilted	0.29	0.01	0.30	Σ SAR < 1.6, Not required
		Body-Worn	Front Face	0.53	0.32	0.85	Σ SAR < 1.6, Not required
			Rear Face	0.38	0.32	0.70	Σ SAR < 1.6, Not required
		Hotspot	Front Face	0.53	0.32	0.85	Σ SAR < 1.6, Not required
			Rear Face	0.38	0.32	0.70	Σ SAR < 1.6, Not required
			Left Side	0.35	0.32	0.67	Σ SAR < 1.6, Not required
			Right Side	0.48	0.32	0.80	Σ SAR < 1.6, Not required
			Top Side	0.00	0.32	0.32	Σ SAR < 1.6, Not required
			Bottom Side	0.11	0.32	0.43	Σ SAR < 1.6, Not required
12	WCDMA V + BT (DSS)	Body-Worn	Front Face	0.53	0.21	0.74	Σ SAR < 1.6, Not required
			Rear Face	0.38	0.21	0.59	Σ SAR < 1.6, Not required



FCC SAR Test Report

A D T

No.	Conditions (SAR1 + SAR2)	Exposure Condition	Test Position	Max. SAR1	Max. SAR2	SAR Summation	SPLSR Analysis
13	LTE 7 + WLAN (DTS)	Head	Right Cheek	0.10	0.00	0.10	Σ SAR < 1.6, Not required
			Right Tilted	0.03	0.00	0.03	Σ SAR < 1.6, Not required
			Left Cheek	0.15	0.01	0.16	Σ SAR < 1.6, Not required
			Left Tilted	0.04	0.00	0.04	Σ SAR < 1.6, Not required
		Body-Worn	Front Face	0.37	0.00	0.37	Σ SAR < 1.6, Not required
			Rear Face	0.41	0.01	0.42	Σ SAR < 1.6, Not required
		Hotspot	Front Face	0.37	0.00	0.37	Σ SAR < 1.6, Not required
			Rear Face	0.41	0.01	0.42	Σ SAR < 1.6, Not required
			Left Side	0.09	0.00	0.09	Σ SAR < 1.6, Not required
			Right Side	0.04	0.01	0.05	Σ SAR < 1.6, Not required
			Top Side	0.00	0.00	0.00	Σ SAR < 1.6, Not required
			Bottom Side	1.17	0.00	1.17	Σ SAR < 1.6, Not required
14	LTE 7 + WLAN (NII)	Head	Right Cheek	0.10	0.00	0.10	Σ SAR < 1.6, Not required
			Right Tilted	0.03	0.00	0.03	Σ SAR < 1.6, Not required
			Left Cheek	0.15	0.00	0.15	Σ SAR < 1.6, Not required
			Left Tilted	0.04	0.01	0.05	Σ SAR < 1.6, Not required
		Body-Worn	Front Face	0.37	0.32	0.69	Σ SAR < 1.6, Not required
			Rear Face	0.41	0.32	0.73	Σ SAR < 1.6, Not required
		Hotspot	Front Face	0.37	0.32	0.69	Σ SAR < 1.6, Not required
			Rear Face	0.41	0.32	0.73	Σ SAR < 1.6, Not required
			Left Side	0.09	0.32	0.41	Σ SAR < 1.6, Not required
			Right Side	0.04	0.32	0.36	Σ SAR < 1.6, Not required
			Top Side	0.00	0.32	0.32	Σ SAR < 1.6, Not required
			Bottom Side	1.17	0.32	1.49	Σ SAR < 1.6, Not required
15	LTE 7 + BT (DSS)	Body-Worn	Front Face	0.37	0.21	0.58	Σ SAR < 1.6, Not required
			Rear Face	0.41	0.21	0.62	Σ SAR < 1.6, Not required

Test Engineer : Blake Wang, and Mars Chang



5. Calibration of Test Equipment

Equipment	Manufacturer	Model	SN	Cal. Date	Cal. Interval
System Validation Dipole	SPEAG	D835V2	4d121	Aug. 28, 2014	2 Years
System Validation Dipole	SPEAG	D1900V2	5d036	Jan. 26, 2015	2 Years
System Validation Dipole	SPEAG	D2450V2	737	Aug. 21, 2014	2 Years
System Validation Dipole	SPEAG	D2600V2	1020	Aug. 21, 2014	2 Years
Dosimetric E-Field Probe	SPEAG	EX3DV4	3590	Feb. 26, 2015	1 Year
Dosimetric E-Field Probe	SPEAG	EX3DV4	3864	Jul. 25, 2014	1 Year
Dosimetric E-Field Probe	SPEAG	EX3DV4	3873	Aug. 26, 2014	1 Year
Data Acquisition Electronics	SPEAG	DAE3	510	Aug. 26, 2014	1 Year
Data Acquisition Electronics	SPEAG	DAE4	861	Apr. 28, 2015	1 Year
Data Acquisition Electronics	SPEAG	DAE4	1341	Aug. 26, 2014	1 Year
Wireless Communication Test Set	Agilent	E5515C	MY50266628	Dec. 05, 2013	2 Years
Radio Communication Analyzer	Anritsu	MT8820C	6201300638	Jul. 22, 2014	1 Year
ENA Series Network Analyzer	Agilent	E5071C	MY46214281	Jun. 13, 2014	1 Year
EXA Spectrum Analyzer	Agilent	N9010A	MY53470455	Feb. 26, 2015	1 Year
MXG Analog Signal Generator	Agilent	N5181A	MY50143868	Jun. 26, 2014	1 Year
Power Meter	Anritsu	ML2495A	1218009	Jun. 26, 2014	1 Year
Power Sensor	Anritsu	MA2411B	1207252	Jun. 26, 2014	1 Year
Thermometer	YFE	YF-160A	130504579	Aug. 21, 2014	1 Year



FCC SAR Test Report

6. Measurement Uncertainty

Source of Uncertainty	Tolerance (± %)	Probability Distribution	Divisor	Ci (1g)	Ci (10g)	Standard Uncertainty (± %, 1g)	Standard Uncertainty (± %, 10g)	Vi
Measurement System								
Probe Calibration	6.0	Normal	1	1	1	6.0	6.0	∞
Axial Isotropy	4.7	Rectangular	√3	0.707	0.707	1.9	1.9	∞
Hemispherical Isotropy	9.6	Rectangular	√3	0.707	0.707	3.9	3.9	∞
Boundary Effect	1.0	Rectangular	√3	1	1	0.6	0.6	∞
Linearity	4.7	Rectangular	√3	1	1	2.7	2.7	∞
System Detection Limits	0.25	Rectangular	√3	1	1	0.14	0.14	∞
Readout Electronics	0.3	Normal	1	1	1	0.3	0.3	∞
Response Time	0.0	Rectangular	√3	1	1	0.0	0.0	∞
Integration Time	1.7	Rectangular	√3	1	1	1.0	1.0	∞
RF Ambient Conditions - Noise	3.0	Rectangular	√3	1	1	1.7	1.7	∞
RF Ambient Conditions - Reflections	3.0	Rectangular	√3	1	1	1.7	1.7	∞
Probe Positioner Mechanical Tolerance	0.4	Rectangular	√3	1	1	0.2	0.2	∞
Probe Positioning with Respect to Phantom Shell	2.9	Rectangular	√3	1	1	1.7	1.7	∞
Extrapolation, interpolation, and integration algorithms for max. SAR evaluation	2.0	Rectangular	√3	1	1	1.2	1.2	∞
Test Sample Related								
Test Sample Positioning	1.5 / 0.7	Normal	1	1	1	1.5	0.7	32
Device Holder Uncertainty	4.2 / 1.8	Normal	1	1	1	4.2	1.8	32
Output Power Variation - SAR Drift Measurement	5.0	Rectangular	√3	1	1	2.9	2.9	∞
Phantom and Tissue Parameters								
Phantom Uncertainty (Shape and Thickness Tolerances)	7.2	Rectangular	√3	1	1	4.2	4.2	∞
Liquid Conductivity - Deviation from Target Values	5.0	Rectangular	√3	0.64	0.43	1.8	1.2	∞
Liquid Conductivity - Measurement Uncertainty	1.0	Normal	1	0.64	0.43	0.6	0.4	25
Liquid Permittivity - Deviation from Target Values	5.0	Rectangular	√3	0.60	0.49	1.7	1.4	∞
Liquid Permittivity - Measurement Uncertainty	0.5	Normal	1	0.60	0.49	0.3	0.2	25
Combined Standard Uncertainty						± 11.2 %	± 10.4 %	
Expanded Uncertainty (K=2)						± 22.4 %	± 20.8 %	

Uncertainty budget for frequency range 300 MHz to 3 GHz



FCC SAR Test Report

Source of Uncertainty	Tolerance (± %)	Probability Distribution	Divisor	Ci (1g)	Ci (10g)	Standard Uncertainty (± %, 1g)	Standard Uncertainty (± %, 10g)	Vi
Measurement System								
Probe Calibration	6.55	Normal	1	1	1	6.55	6.55	∞
Axial Isotropy	4.7	Rectangular	√3	0.707	0.707	1.9	1.9	∞
Hemispherical Isotropy	9.6	Rectangular	√3	0.707	0.707	3.9	3.9	∞
Boundary Effect	2.0	Rectangular	√3	1	1	1.2	1.2	∞
Linearity	4.7	Rectangular	√3	1	1	2.7	2.7	∞
System Detection Limits	0.25	Rectangular	√3	1	1	0.14	0.14	∞
Readout Electronics	0.3	Normal	1	1	1	0.3	0.3	∞
Response Time	0.0	Rectangular	√3	1	1	0.0	0.0	∞
Integration Time	1.7	Rectangular	√3	1	1	1.0	1.0	∞
RF Ambient Conditions - Noise	3.0	Rectangular	√3	1	1	1.7	1.7	∞
RF Ambient Conditions - Reflections	3.0	Rectangular	√3	1	1	1.7	1.7	∞
Probe Positioner Mechanical Tolerance	0.4	Rectangular	√3	1	1	0.2	0.2	∞
Probe Positioning with Respect to Phantom Shell	6.7	Rectangular	√3	1	1	3.9	3.9	∞
Extrapolation, interpolation, and integration algorithms for max. SAR evaluation	4.0	Rectangular	√3	1	1	2.3	2.3	∞
Test Sample Related								
Test Sample Positioning	1.5 / 0.7	Normal	1	1	1	1.5	0.7	32
Device Holder Uncertainty	4.2 / 1.8	Normal	1	1	1	4.2	1.8	32
Output Power Variation - SAR Drift Measurement	5.0	Rectangular	√3	1	1	2.9	2.9	∞
Phantom and Tissue Parameters								
Phantom Uncertainty (Shape and Thickness Tolerances)	7.6	Rectangular	√3	1	1	4.4	4.4	∞
Liquid Conductivity - Deviation from Target Values	5.0	Rectangular	√3	0.64	0.43	1.8	1.2	∞
Liquid Conductivity - Measurement Uncertainty	1.0	Normal	1	0.64	0.43	0.6	0.4	25
Liquid Permittivity - Deviation from Target Values	5.0	Rectangular	√3	0.60	0.49	1.7	1.4	∞
Liquid Permittivity - Measurement Uncertainty	0.5	Normal	1	0.60	0.49	0.3	0.2	25
Combined Standard Uncertainty						± 12.3 %	± 11.5 %	
Expanded Uncertainty (K=2)						± 24.6 %	± 23.0 %	

Uncertainty budget for frequency range 3 GHz to 6 GHz



FCC SAR Test Report

7. Information on the Testing Laboratories

We, Bureau Veritas Consumer Products Services (H.K.) Ltd., Taoyuan Branch, were founded in 1988 to provide our best service in EMC, Radio, Telecom and Safety consultation. Our laboratories are accredited and approved according to ISO/IEC 17025.

If you have any comments, please feel free to contact us at the following:

Taiwan HwaYa EMC/RF/Safety/Telecom Lab:

Add: No. 19, Hwa Ya 2nd Rd, Wen Hwa Vil., Kwei Shan Hsiang, Taoyuan Hsien 333, Taiwan, R.O.C.

Tel: 886-3-318-3232

Fax: 886-3-327-0892

Taiwan LinKo EMC/RF Lab:

Add: No. 47-2, 14th Ling, Chia Pau Vil., Linkou Dist., New Taipei City 244, Taiwan, R.O.C.

Tel: 886-2-2605-2180

Fax: 886-2-2605-1924

Taiwan HsinChu EMC/RF Lab:

Add: No. 81-1, Lu Liao Keng, 9th Ling, Wu Lung Vil., Chiung Lin Township, Hsinchu County 307, Taiwan, R.O.C.

Tel: 886-3-593-5343

Fax: 886-3-593-5342

Email: service.adt@tw.bureauveritas.com

Web Site: www.adt.com.tw

The road map of all our labs can be found in our web site also.

---END---



Appendix A. SAR Plots of System Verification

The plots for system verification with largest deviation for each SAR system combination are shown as follows.

System Check_H835_150527

DUT: Dipole 835 MHz; Type: D835V2; SN: 4d121

Communication System: CW; Frequency: 835 MHz; Duty Cycle: 1:1

Medium: H08T09N1_0527 Medium parameters used: $f = 835 \text{ MHz}$; $\sigma = 0.876 \text{ S/m}$; $\epsilon_r = 42.458$; $\rho = 1000 \text{ kg/m}^3$

Ambient Temperature : $22.3 \text{ }^\circ\text{C}$; Liquid Temperature : $21.4 \text{ }^\circ\text{C}$

DASY5 Configuration:

- Probe: EX3DV4 - SN3864; ConvF(10.03, 10.03, 10.03); Calibrated: 2014/07/25;
- Sensor-Surface: 2mm (Mechanical Surface Detection)
- Electronics: DAE3 Sn510; Calibrated: 2014/08/26
- Phantom: Twin SAM Phantom_1653; Type: QD000P40;
- Measurement SW: DASY52, Version 52.8 (8); SEMCAD X Version 14.6.10 (7331)

Pin=250mW/Area Scan (61x61x1): Interpolated grid: $dx=1.500 \text{ mm}$, $dy=1.500 \text{ mm}$
Maximum value of SAR (interpolated) = 3.10 W/kg

Pin=250mW/Zoom Scan (5x5x7)/Cube 0: Measurement grid: $dx=8\text{mm}$, $dy=8\text{mm}$, $dz=5\text{mm}$

Reference Value = 60.41 V/m ; Power Drift = -0.11 dB

Peak SAR (extrapolated) = 3.67 W/kg

SAR(1 g) = 2.44 W/kg ; SAR(10 g) = 1.6 W/kg

Maximum value of SAR (measured) = 3.10 W/kg

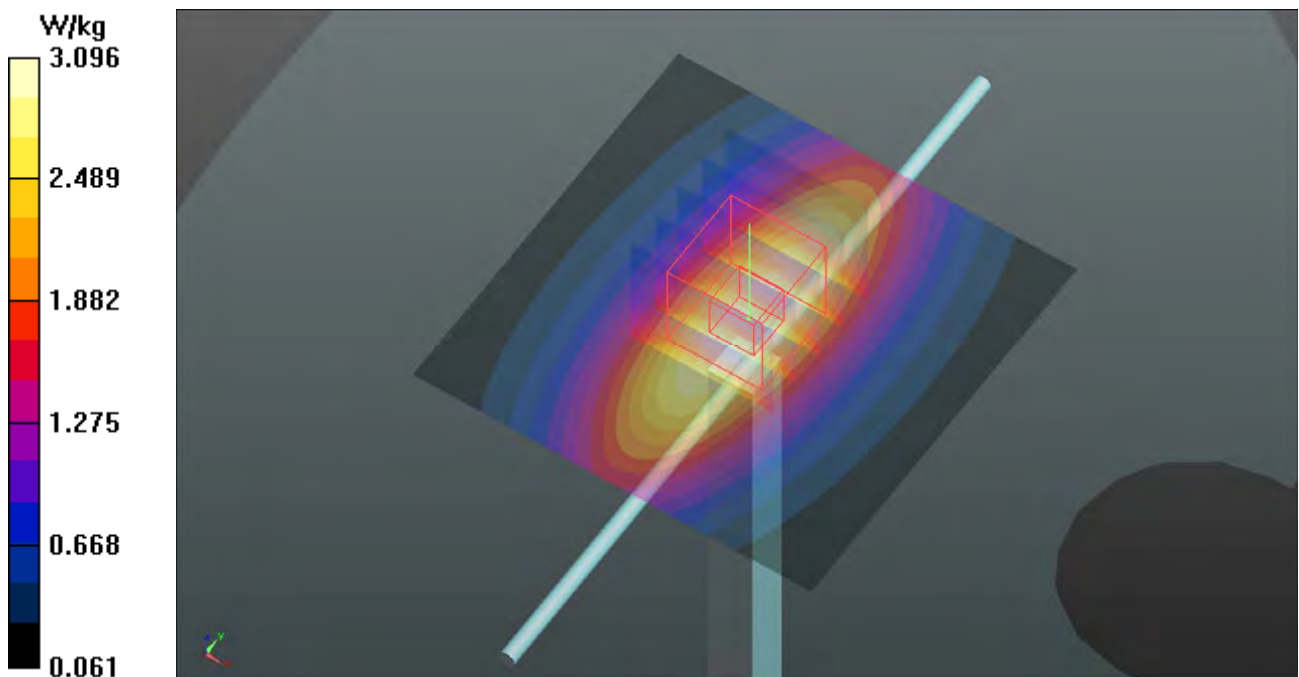

System Check_H1900_150527

DUT: Dipole 1900 MHz; Type: D1900V2; SN: 5d036

Communication System: CW; Frequency: 1900 MHz; Duty Cycle: 1:1

Medium: H18T19N3_0527 Medium parameters used: $f = 1900$ MHz; $\sigma = 1.46$ S/m; $\epsilon_r = 38.508$; $\rho = 1000$ kg/m³

Ambient Temperature : 22.6 °C ; Liquid Temperature : 21.5 °C

DASY5 Configuration:

- Probe: EX3DV4 - SN3864; ConvF(8.1, 8.1, 8.1); Calibrated: 2014/07/25;
- Sensor-Surface: 2mm (Mechanical Surface Detection)
- Electronics: DAE3 Sn510; Calibrated: 2014/08/26
- Phantom: Twin SAM Phantom_1652; Type: QD000P40;
- Measurement SW: DASY52, Version 52.8 (8); SEMCAD X Version 14.6.10 (7331)

Pin=250mW/Area Scan (61x61x1): Interpolated grid: dx=1.500 mm, dy=1.500 mm
Maximum value of SAR (interpolated) = 15.5 W/kg

Pin=250mW/Zoom Scan (5x5x7)/Cube 0: Measurement grid: dx=8mm, dy=8mm, dz=5mm

Reference Value = 100.9 V/m; Power Drift = -0.07 dB

Peak SAR (extrapolated) = 18.5 W/kg

SAR(1 g) = 10.1 W/kg; SAR(10 g) = 5.26 W/kg

Maximum value of SAR (measured) = 14.3 W/kg

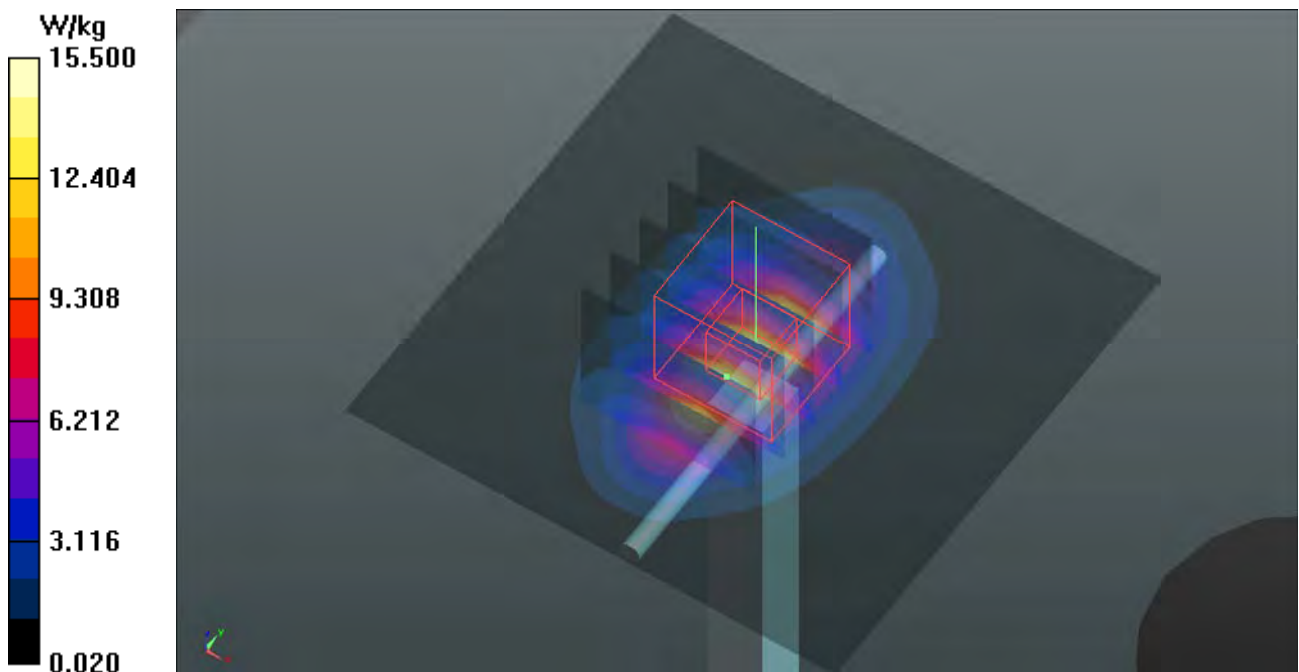

System Check_H2450_150528

DUT: Dipole 2450 MHz; Type: D2450V2; SN: 737

Communication System: CW; Frequency: 2450 MHz; Duty Cycle: 1:1

Medium: H24T25N2_0528 Medium parameters used: $f = 2450$ MHz; $\sigma = 1.831$ S/m; $\epsilon_r = 38.2$; $\rho = 1000$ kg/m³

Ambient Temperature : 22.2 °C ; Liquid Temperature : 21.5 °C

DASY5 Configuration:

- Probe: EX3DV4 - SN3590; ConvF(7.89, 7.89, 7.89); Calibrated: 2015/02/26;
- Sensor-Surface: 2mm (Mechanical Surface Detection)
- Electronics: DAE4 Sn861; Calibrated: 2015/04/28
- Phantom: Twin SAM Phantom_1202; Type: QD000P40;
- Measurement SW: DASY52, Version 52.8 (8); SEMCAD X Version 14.6.10 (7331)

Pin=250mW/Area Scan (81x81x1): Interpolated grid: dx=1.200 mm, dy=1.200 mm
Maximum value of SAR (interpolated) = 18.6 W/kg

Pin=250mW/Zoom Scan (7x7x7)/Cube 0: Measurement grid: dx=5mm, dy=5mm, dz=5mm
Reference Value = 102.1 V/m; Power Drift = -0.03 dB
Peak SAR (extrapolated) = 24.6 W/kg
SAR(1 g) = 12.1 W/kg; SAR(10 g) = 5.62 W/kg
Maximum value of SAR (measured) = 18.3 W/kg

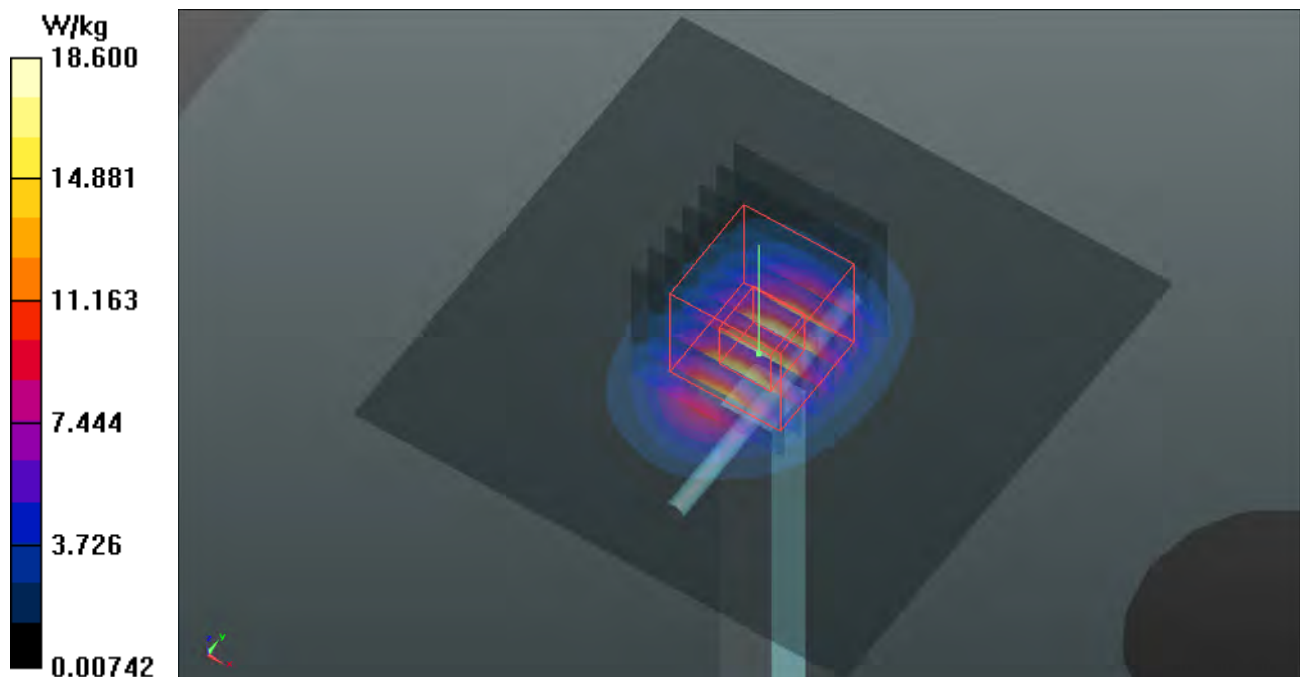

System Check_H2600_150607

DUT: Dipole 2600 MHz; Type: D2600V2; SN: 1020

Communication System: CW; Frequency: 2600 MHz; Duty Cycle: 1:1

Medium: H2600-A_0607 Medium parameters used: $f = 2600$ MHz; $\sigma = 1.987$ S/m; $\epsilon_r = 37.616$; $\rho = 1000$ kg/m³

Ambient Temperature : 22.1 °C ; Liquid Temperature : 21.2 °C

DASY5 Configuration:

- Probe: EX3DV4 - SN3873; ConvF(7.05, 7.05, 7.05); Calibrated: 2014/08/26;
- Sensor-Surface: 2mm (Mechanical Surface Detection)
- Electronics: DAE4 Sn1341; Calibrated: 2014/08/26
- Phantom: Right Phantom with CRP v5.0; Type: QD000P40CD; Serial: TP:1722
- Measurement SW: DASY52, Version 52.8 (8); SEMCAD X Version 14.6.10 (7331)

Pin=250mW/Area Scan (81x81x1): Interpolated grid: dx=1.200 mm, dy=1.200 mm

Maximum value of SAR (interpolated) = 23.6 W/kg

Pin=250mW/Zoom Scan (7x7x7)/Cube 0: Measurement grid: dx=5mm, dy=5mm, dz=5mm

Reference Value = 111.1 V/m; Power Drift = 0.03 dB

Peak SAR (extrapolated) = 32.3 W/kg

SAR(1 g) = 15.1 W/kg; SAR(10 g) = 6.66 W/kg

Maximum value of SAR (measured) = 23.7 W/kg

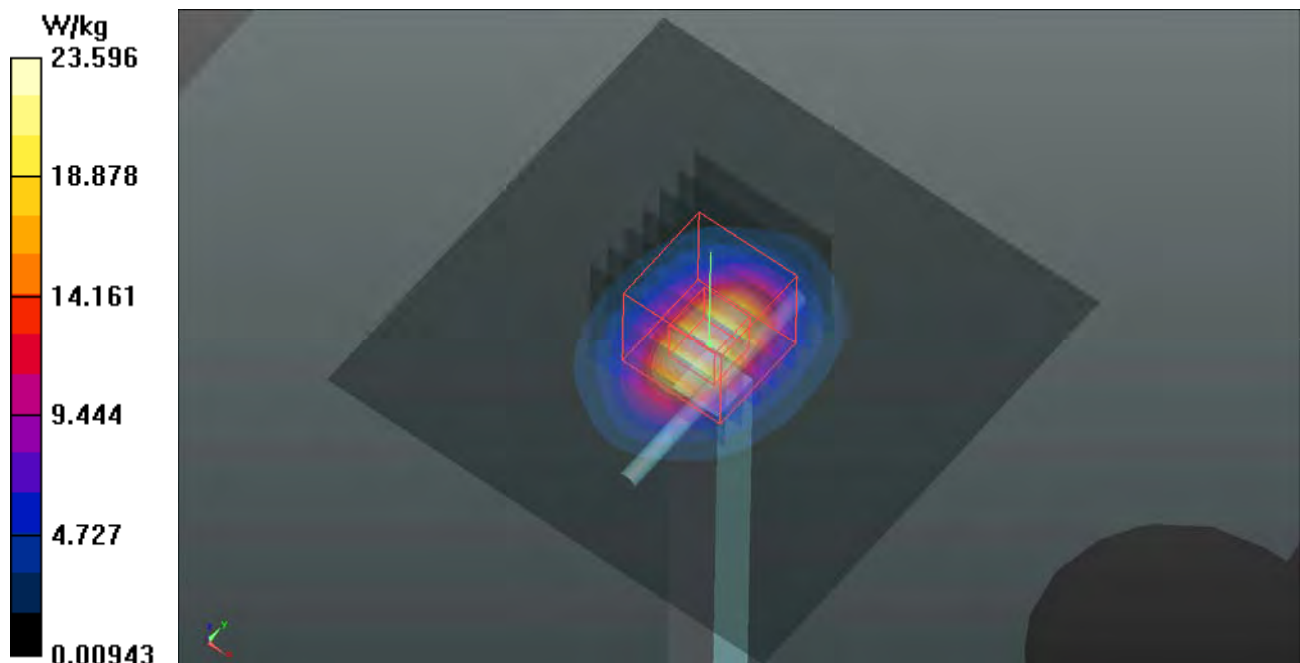

System Check_H5200_150603

DUT: Dipole 5 GHz; Type: D5GHzV2; SN: 1019

Communication System: CW; Frequency: 5200 MHz; Duty Cycle: 1:1

Medium: H50T60N3_0603 Medium parameters used: $f = 5200$ MHz; $\sigma = 4.599$ S/m; $\epsilon_r = 36.16$; $\rho = 1000$ kg/m³

Ambient Temperature : 22.5 °C ; Liquid Temperature : 22.2 °C

DASY5 Configuration:

- Probe: EX3DV4 - SN3590; ConvF(5.69, 5.69, 5.69); Calibrated: 2015/02/26;
- Sensor-Surface: 2mm (Mechanical Surface Detection)
- Electronics: DAE4 Sn861; Calibrated: 2015/04/28
- Phantom: Twin SAM Phantom_1202; Type: QD000P40;
- Measurement SW: DASY52, Version 52.8 (8); SEMCAD X Version 14.6.10 (7331)

Pin=100mW/Area Scan (91x91x1): Interpolated grid: dx=1.000 mm, dy=1.000 mm
Maximum value of SAR (interpolated) = 17.0 W/kg

Pin=100mW/Zoom Scan (7x7x12)/Cube 0: Measurement grid: dx=4mm, dy=4mm, dz=2mm
Reference Value = 63.53 V/m; Power Drift = 0.03 dB
Peak SAR (extrapolated) = 32.0 W/kg
SAR(1 g) = 8.47 W/kg; SAR(10 g) = 2.46 W/kg
Maximum value of SAR (measured) = 17.4 W/kg

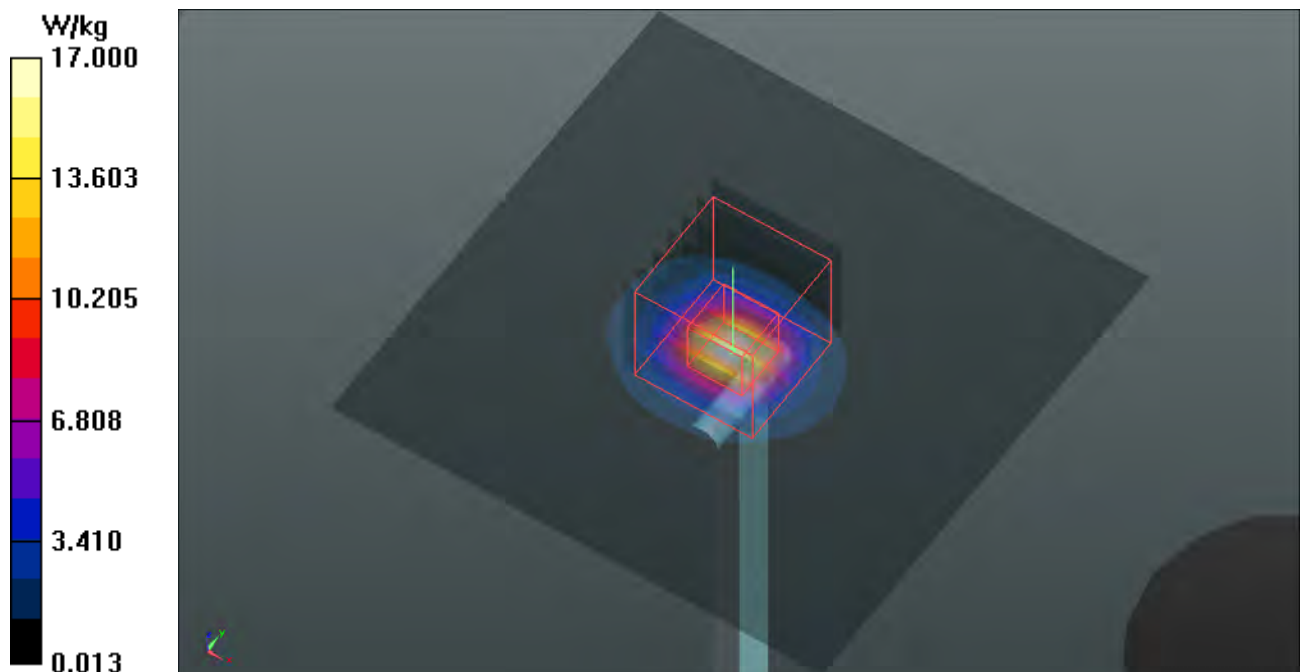

System Check_H5600_150603

DUT: Dipole 5 GHz; Type: D5GHzV2; SN: 1019

Communication System: CW; Frequency: 5600 MHz; Duty Cycle: 1:1

Medium: H50T60N3_0603 Medium parameters used: $f = 5600$ MHz; $\sigma = 4.885$ S/m; $\epsilon_r = 35.648$; $\rho = 1000$ kg/m³

Ambient Temperature : 22.5 °C ; Liquid Temperature : 22.1 °C

DASY5 Configuration:

- Probe: EX3DV4 - SN3590; ConvF(4.72, 4.72, 4.72); Calibrated: 2015/02/26;
- Sensor-Surface: 2mm (Mechanical Surface Detection)
- Electronics: DAE4 Sn861; Calibrated: 2015/04/28
- Phantom: Twin SAM Phantom_1202; Type: QD000P40;
- Measurement SW: DASY52, Version 52.8 (8); SEMCAD X Version 14.6.10 (7331)

Pin=100mW/Area Scan (91x91x1): Interpolated grid: dx=1.000 mm, dy=1.000 mm
Maximum value of SAR (interpolated) = 16.0 W/kg

Pin=100mW/Zoom Scan (7x7x12)/Cube 0: Measurement grid: dx=4mm, dy=4mm, dz=2mm
Reference Value = 63.46 V/m; Power Drift = -0.01 dB

Peak SAR (extrapolated) = 34.8 W/kg

SAR(1 g) = 8.02 W/kg; SAR(10 g) = 2.24 W/kg

Maximum value of SAR (measured) = 16.8 W/kg

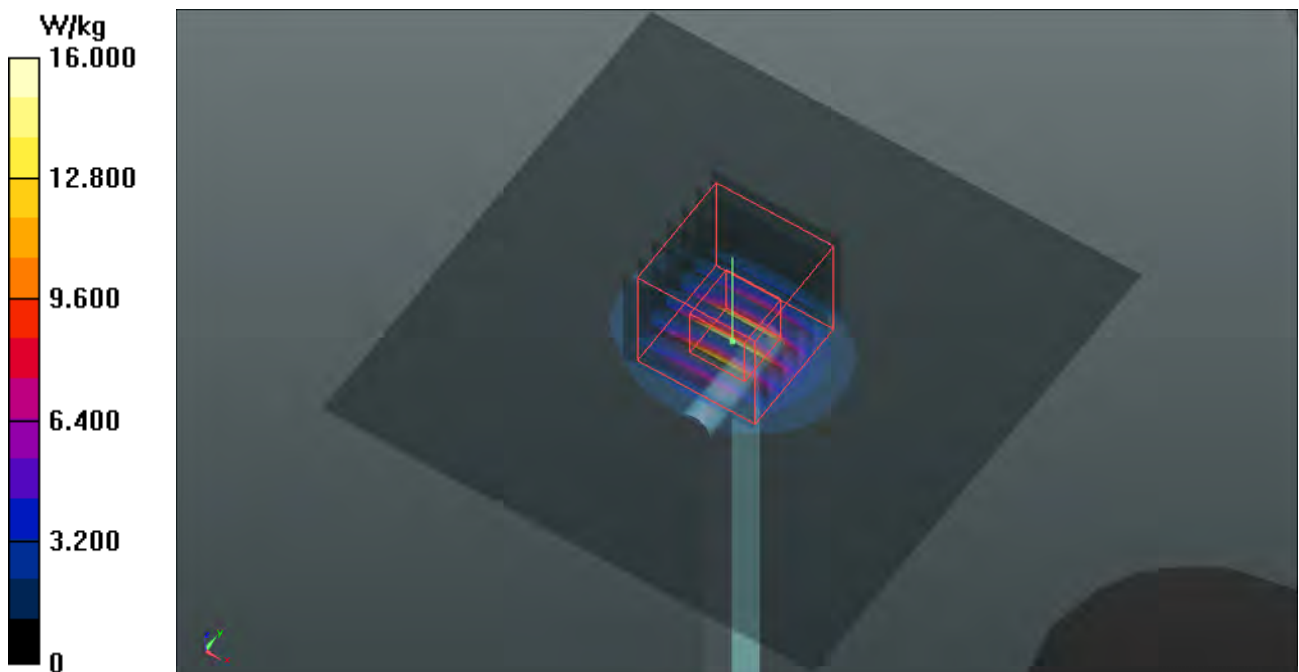

System Check_B835_150526

DUT: Dipole 835 MHz; Type: D835V2; SN: 4d121

Communication System: CW; Frequency: 835 MHz; Duty Cycle: 1:1

Medium: B08T09N3_0526 Medium parameters used: $f = 835 \text{ MHz}$; $\sigma = 0.949 \text{ S/m}$; $\epsilon_r = 54.635$; $\rho = 1000 \text{ kg/m}^3$

Ambient Temperature : $22.6 \text{ }^\circ\text{C}$; Liquid Temperature : $21.8 \text{ }^\circ\text{C}$

DASY5 Configuration:

- Probe: EX3DV4 - SN3590; ConvF(10.3, 10.3, 10.3); Calibrated: 2015/02/26;
- Sensor-Surface: 2mm (Mechanical Surface Detection)
- Electronics: DAE4 Sn861; Calibrated: 2015/04/28
- Phantom: Twin SAM Phantom_1202; Type: QD000P40;
- Measurement SW: DASY52, Version 52.8 (8); SEMCAD X Version 14.6.10 (7331)

Pin=250mW/Area Scan (61x61x1): Interpolated grid: $dx=1.500 \text{ mm}$, $dy=1.500 \text{ mm}$
Maximum value of SAR (interpolated) = 2.80 W/kg

Pin=250mW/Zoom Scan (5x5x7)/Cube 0: Measurement grid: $dx=8\text{mm}$, $dy=8\text{mm}$, $dz=5\text{mm}$

Reference Value = 52.64 V/m ; Power Drift = -0.01 dB

Peak SAR (extrapolated) = 3.24 W/kg

SAR(1 g) = 2.27 W/kg ; SAR(10 g) = 1.55 W/kg

Maximum value of SAR (measured) = 2.81 W/kg

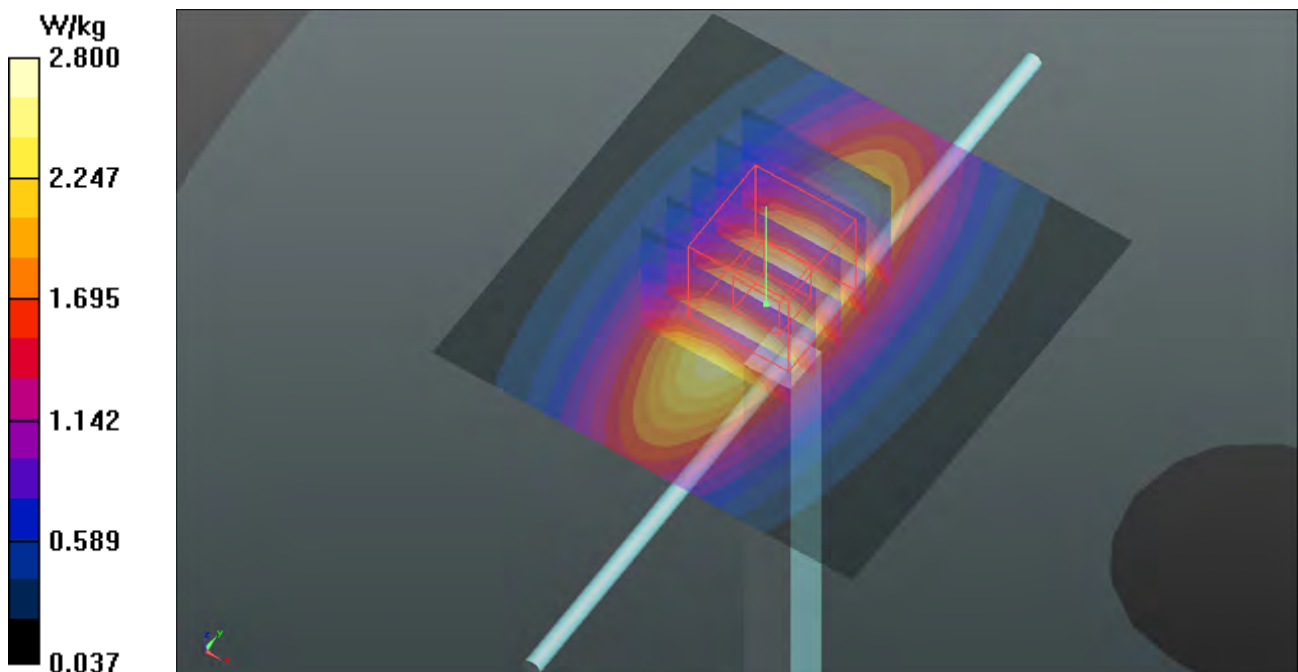

System Check_B1900_150527

DUT: Dipole 1900 MHz; Type: D1900V2; SN: 5d036

Communication System: CW; Frequency: 1900 MHz; Duty Cycle: 1:1

Medium: B18T19N1_0527 Medium parameters used: $f = 1900$ MHz; $\sigma = 1.547$ S/m; $\epsilon_r = 53.811$; $\rho = 1000$ kg/m³

Ambient Temperature : 22.5 °C ; Liquid Temperature : 21.5 °C

DASY5 Configuration:

- Probe: EX3DV4 - SN3864; ConvF(7.72, 7.72, 7.72); Calibrated: 2014/07/25;
- Sensor-Surface: 2mm (Mechanical Surface Detection)
- Electronics: DAE3 Sn510; Calibrated: 2014/08/26
- Phantom: Twin SAM Phantom_1653; Type: QD000P40;
- Measurement SW: DASY52, Version 52.8 (8); SEMCAD X Version 14.6.10 (7331)

Pin=250mW/Area Scan (61x61x1): Interpolated grid: dx=1.500 mm, dy=1.500 mm
Maximum value of SAR (interpolated) = 15.7 W/kg

Pin=250mW/Zoom Scan (5x5x7)/Cube 0: Measurement grid: dx=8mm, dy=8mm, dz=5mm

Reference Value = 99.05 V/m; Power Drift = 0.04 dB

Peak SAR (extrapolated) = 18.8 W/kg

SAR(1 g) = 10.4 W/kg; SAR(10 g) = 5.4 W/kg

Maximum value of SAR (measured) = 14.7 W/kg

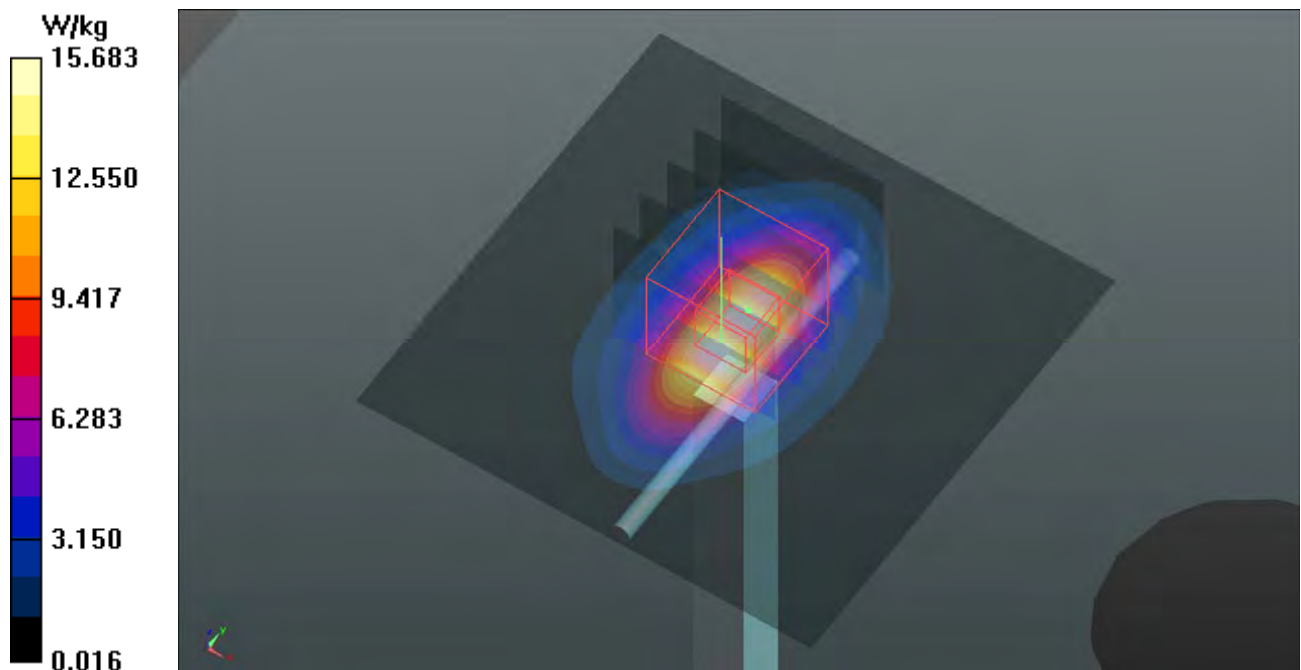

System Check_B2450_150528

DUT: Dipole 2450 MHz; Type: D2450V2; SN: 737

Communication System: CW; Frequency: 2450 MHz; Duty Cycle: 1:1

Medium: B24T25N1_0528 Medium parameters used: $f = 2450$ MHz; $\sigma = 1.92$ S/m; $\epsilon_r = 53.904$; $\rho = 1000$ kg/m³

Ambient Temperature : 22.5 °C ; Liquid Temperature : 21.8 °C

DASY5 Configuration:

- Probe: EX3DV4 - SN3590; ConvF(7.78, 7.78, 7.78); Calibrated: 2015/02/26;
- Sensor-Surface: 2mm (Mechanical Surface Detection)
- Electronics: DAE4 Sn861; Calibrated: 2015/04/28
- Phantom: Twin SAM Phantom_1654; Type: QD000P40;
- Measurement SW: DASY52, Version 52.8 (8); SEMCAD X Version 14.6.10 (7331)

- Pin=250mW/Area Scan (81x81x1): Interpolated grid: dx=1.200 mm, dy=1.200 mm
Maximum value of SAR (interpolated) = 18.4 W/kg

- Pin=250mW/Zoom Scan (7x7x7)/Cube 0: Measurement grid: dx=5mm, dy=5mm, dz=5mm
Reference Value = 97.39 V/m; Power Drift = 0.02 dB

Peak SAR (extrapolated) = 25.0 W/kg

SAR(1 g) = 11.8 W/kg; SAR(10 g) = 5.42 W/kg

Maximum value of SAR (measured) = 18.3 W/kg

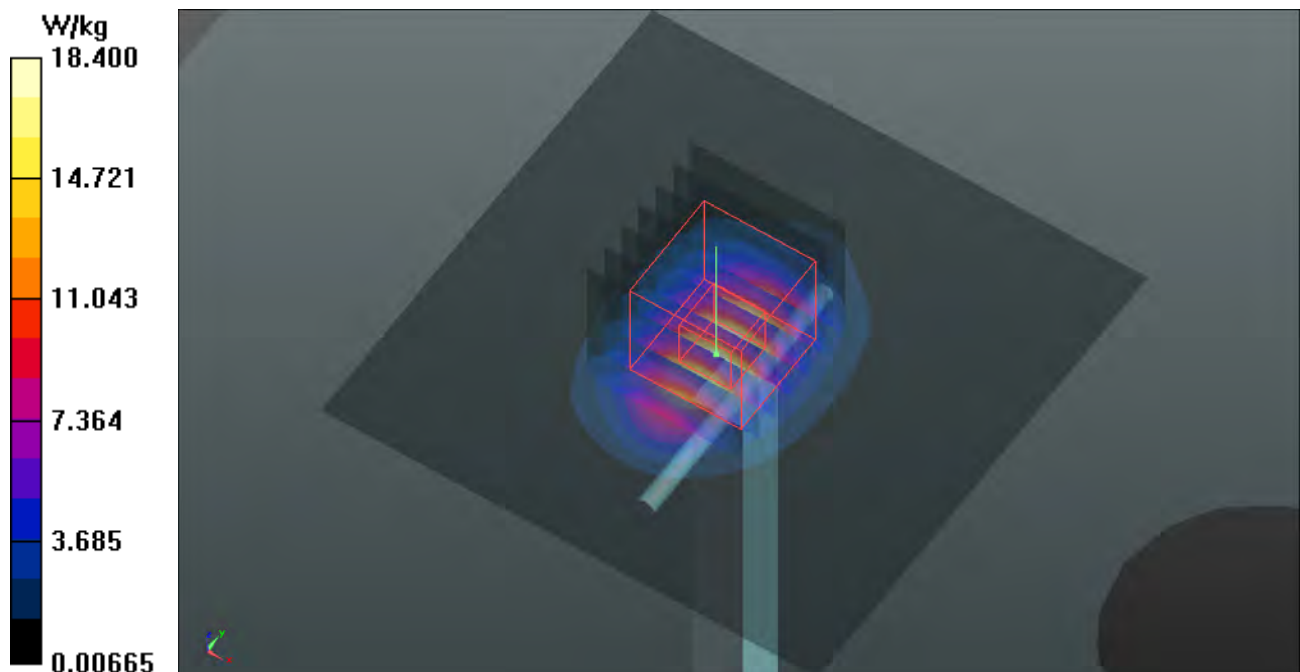

System Check_B2600_150601

DUT: Dipole 2600 MHz; Type: D2600V2; SN: 1020

Communication System: CW; Frequency: 2600 MHz; Duty Cycle: 1:1

Medium: B2600-A_0607 Medium parameters used: $f = 2600$ MHz; $\sigma = 2.2$ S/m; $\epsilon_r = 52.401$; $\rho = 1000$ kg/m³

Ambient Temperature : 22.2 °C ; Liquid Temperature : 21.3 °C

DASY5 Configuration:

- Probe: EX3DV4 - SN3873; ConvF(6.94, 6.94, 6.94); Calibrated: 2014/08/26;
- Sensor-Surface: 2mm (Mechanical Surface Detection)
- Electronics: DAE4 Sn1341; Calibrated: 2014/08/26
- Phantom: ELI 5.0; Type: QD OVA 001 BB; Serial: TP:1205
- Measurement SW: DASY52, Version 52.8 (8); SEMCAD X Version 14.6.10 (7331)

Pin=250mW/Area Scan (81x81x1): Interpolated grid: dx=1.200 mm, dy=1.200 mm
Maximum value of SAR (interpolated) = 22.3 W/kg

Pin=250mW/Zoom Scan (7x7x7)/Cube 0: Measurement grid: dx=5mm, dy=5mm, dz=5mm

Reference Value = 99.67 V/m; Power Drift = 0.03 dB

Peak SAR (extrapolated) = 31.2 W/kg

SAR(1 g) = 14.2 W/kg; SAR(10 g) = 6.28 W/kg

Maximum value of SAR (measured) = 22.4 W/kg

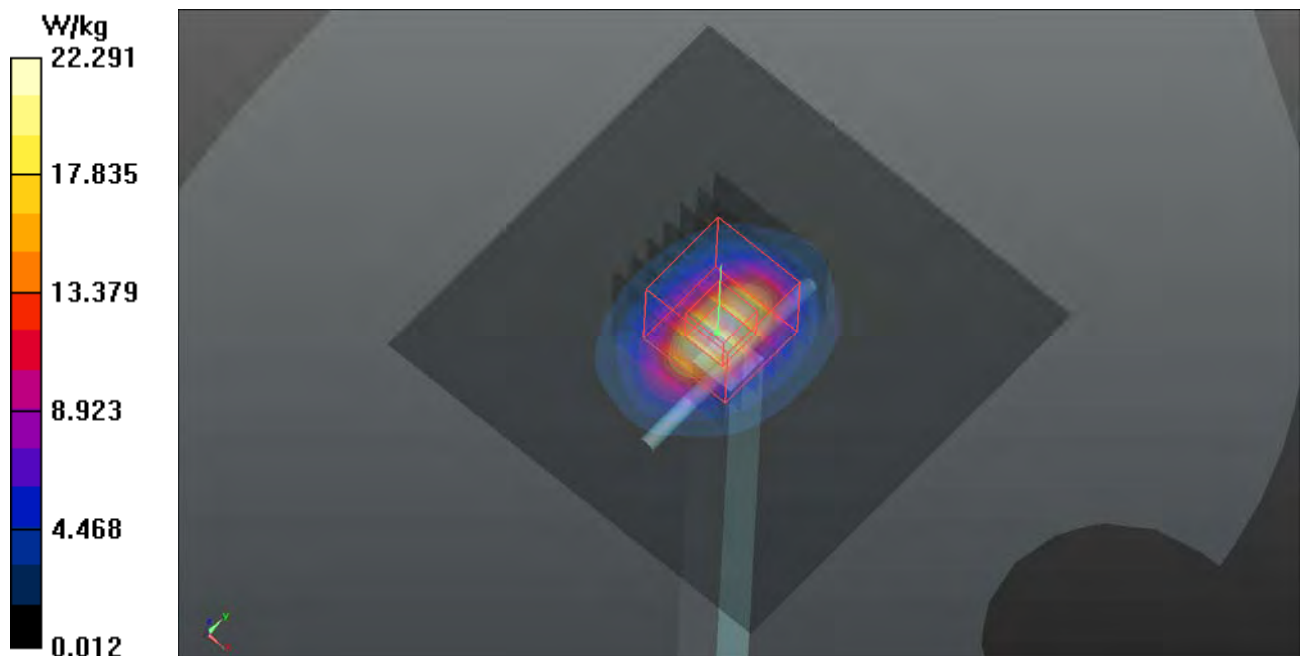



Appendix B. SAR Plots of SAR Measurement

The SAR plots for highest measured SAR in each exposure configuration, wireless mode and frequency band combination, and measured SAR > 1.5 W/kg are shown as follows.

P01 GSM850_GPRS10_Right Cheek_Ch128

DUT: 150522C22

Communication System: GPRS10; Frequency: 824.2 MHz; Duty Cycle: 1:4

Medium: H08T09N1_0527 Medium parameters used: $f = 824.2$ MHz; $\sigma = 0.865$ S/m; $\epsilon_r = 42.575$; $\rho = 1000$ kg/m³

Ambient Temperature : 22.3 °C ; Liquid Temperature : 21.4 °C

DASY5 Configuration:

- Probe: EX3DV4 - SN3864; ConvF(10.03, 10.03, 10.03); Calibrated: 2014/07/25;
- Sensor-Surface: 2mm (Mechanical Surface Detection)
- Electronics: DAE3 Sn510; Calibrated: 2014/08/26
- Phantom: Twin SAM Phantom_1653; Type: QD000P40;
- Measurement SW: DASY52, Version 52.8 (8); SEMCAD X Version 14.6.10 (7331)

- **Area Scan (71x121x1):** Interpolated grid: dx=1.500 mm, dy=1.500 mm

Maximum value of SAR (interpolated) = 0.761 W/kg

- **Zoom Scan (5x5x7)/Cube 0:** Measurement grid: dx=8mm, dy=8mm, dz=5mm

Reference Value = 9.177 V/m; Power Drift = 0.14 dB

Peak SAR (extrapolated) = 0.954 W/kg

SAR(1 g) = 0.747 W/kg; SAR(10 g) = 0.593 W/kg

Maximum value of SAR (measured) = 0.868 W/kg

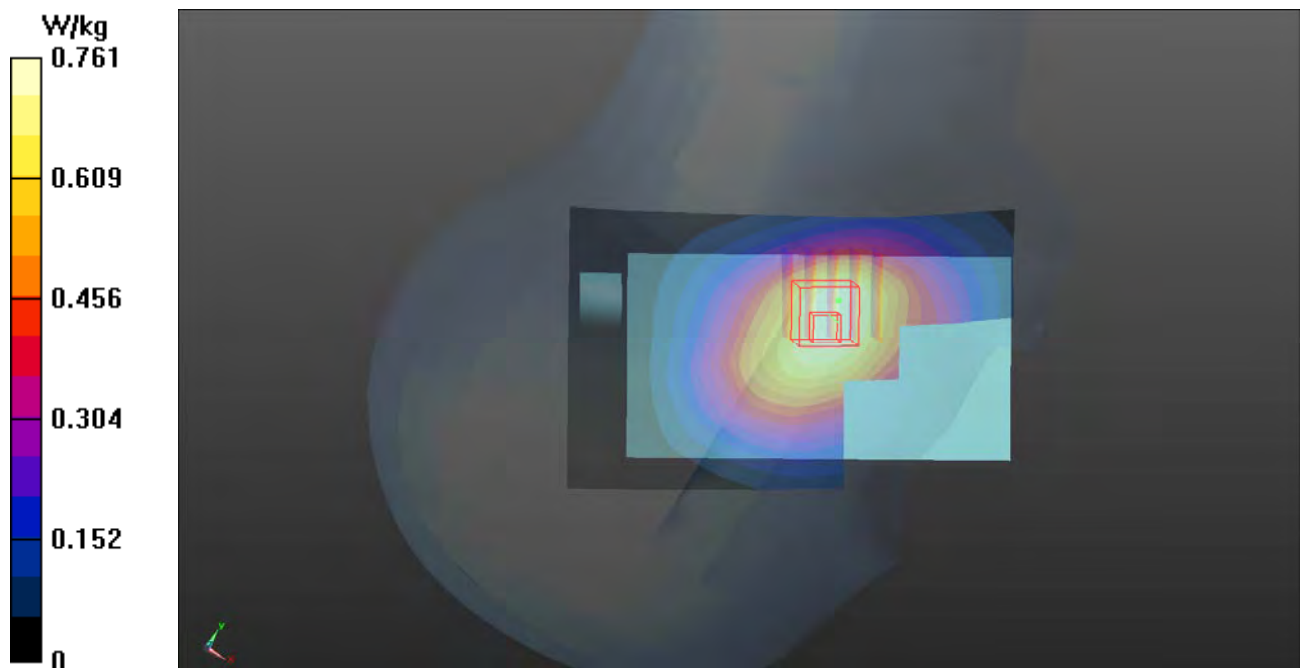

P02 GSM1900_GPRS10_Right Check_Ch512

DUT: 150522C22

Communication System: GPRS10; Frequency: 1850.2 MHz; Duty Cycle: 1:4

Medium: H18T19N3_0527 Medium parameters used: $f = 1850.2$ MHz; $\sigma = 1.412$ S/m; $\epsilon_r = 38.746$; $\rho = 1000$ kg/m³

Ambient Temperature : 22.6 °C ; Liquid Temperature : 21.5 °C

DASY5 Configuration:

- Probe: EX3DV4 - SN3864; ConvF(8.1, 8.1, 8.1); Calibrated: 2014/07/25;
- Sensor-Surface: 2mm (Mechanical Surface Detection)
- Electronics: DAE3 Sn510; Calibrated: 2014/08/26
- Phantom: Twin SAM Phantom_1652; Type: QD000P40;
- Measurement SW: DASY52, Version 52.8 (8); SEMCAD X Version 14.6.10 (7331)

- **Area Scan (71x121x1):** Interpolated grid: dx=1.500 mm, dy=1.500 mm

Maximum value of SAR (interpolated) = 0.464 W/kg

- **Zoom Scan (5x5x7)/Cube 0:** Measurement grid: dx=8mm, dy=8mm, dz=5mm

Reference Value = 4.699 V/m; Power Drift = 0.11 dB

Peak SAR (extrapolated) = 0.542 W/kg

SAR(1 g) = 0.342 W/kg; SAR(10 g) = 0.227 W/kg

Maximum value of SAR (measured) = 0.460 W/kg

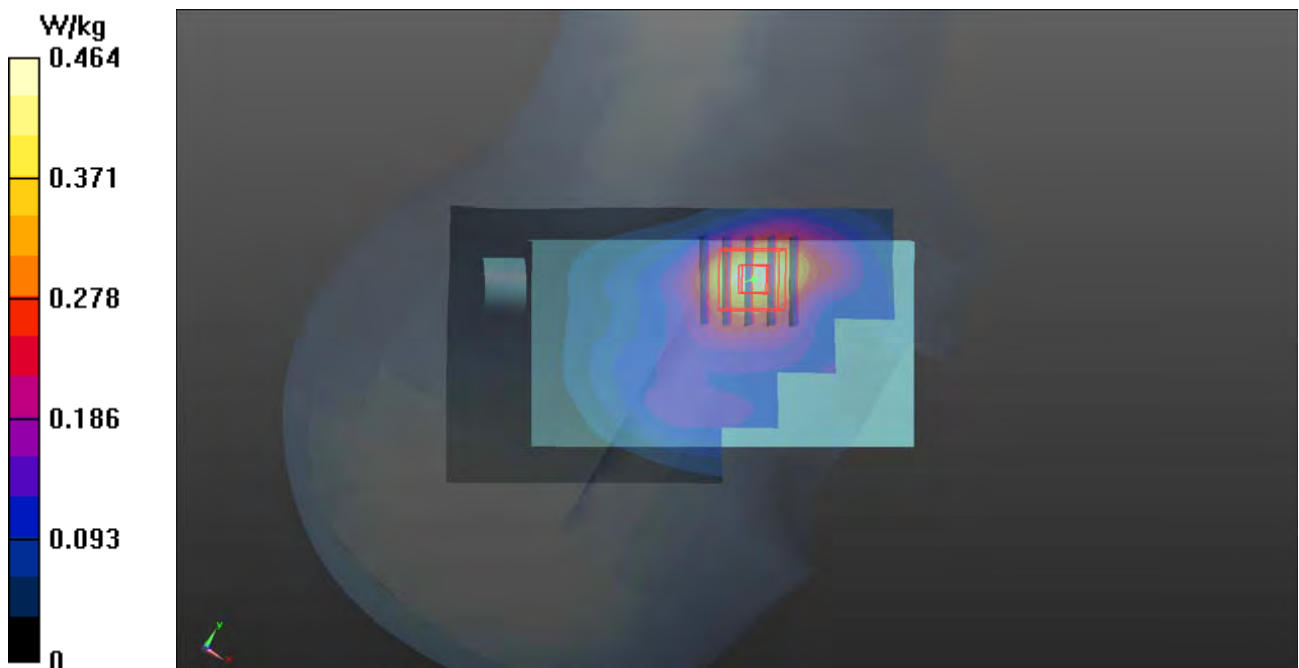

P03 WCDMA II_RMC12.2K_Left Check_Ch9538

DUT: 150522C22

Communication System: WCDMA; Frequency: 1907.6 MHz; Duty Cycle: 1:1

Medium: H18T19N3_0527 Medium parameters used: $f = 1908$ MHz; $\sigma = 1.467$ S/m; $\epsilon_r = 38.472$; $\rho = 1000$ kg/m³

Ambient Temperature : 22.5 °C ; Liquid Temperature : 21.5 °C

DASY5 Configuration:

- Probe: EX3DV4 - SN3864; ConvF(8.1, 8.1, 8.1); Calibrated: 2014/07/25;
- Sensor-Surface: 2mm (Mechanical Surface Detection)
- Electronics: DAE3 Sn510; Calibrated: 2014/08/26
- Phantom: Twin SAM Phantom_1652; Type: QD000P40;
- Measurement SW: DASY52, Version 52.8 (8); SEMCAD X Version 14.6.10 (7331)

- **Area Scan (71x121x1):** Interpolated grid: dx=1.500 mm, dy=1.500 mm

Maximum value of SAR (interpolated) = 0.554 W/kg

- **Zoom Scan (5x5x7)/Cube 0:** Measurement grid: dx=8mm, dy=8mm, dz=5mm

Reference Value = 5.887 V/m; Power Drift = 0.12 dB

Peak SAR (extrapolated) = 0.633 W/kg

SAR(1 g) = 0.409 W/kg; SAR(10 g) = 0.247 W/kg

Maximum value of SAR (measured) = 0.527 W/kg

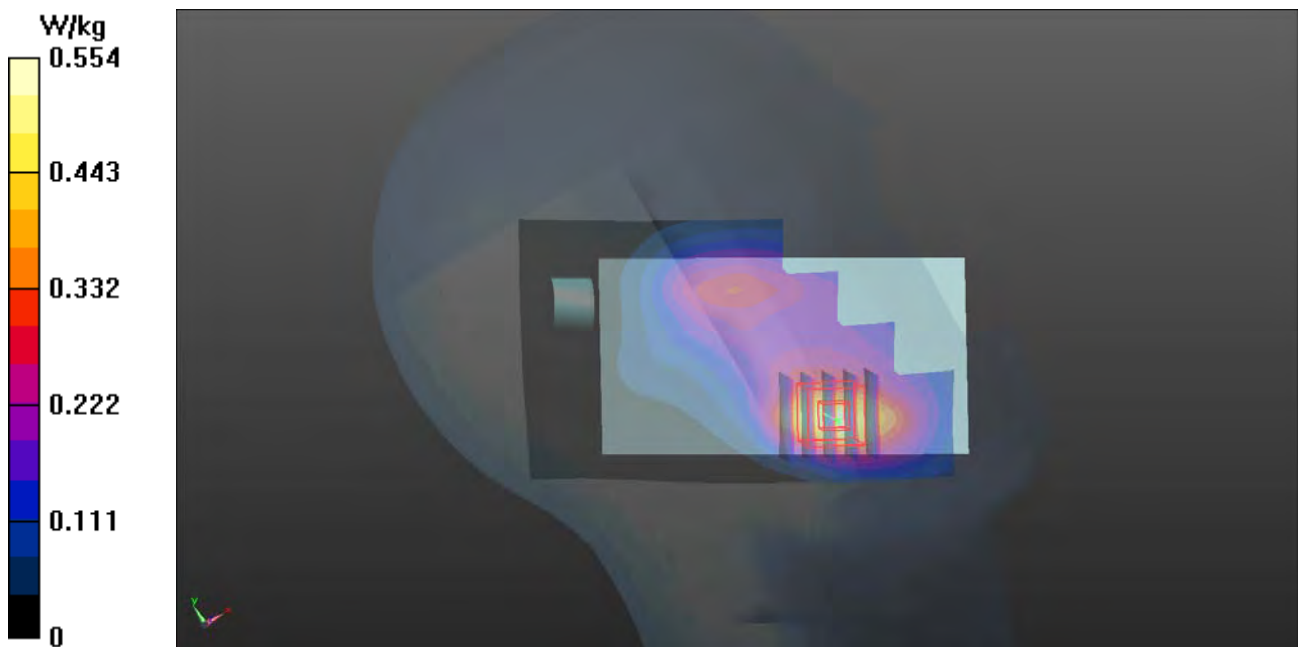

P04 WCDMA V_RMC12.2K_Right Cheek_Ch4132

DUT: 150522C22

Communication System: WCDMA; Frequency: 826.4 MHz; Duty Cycle: 1:1

Medium: H08T09N1_0527 Medium parameters used: $f = 826.4$ MHz; $\sigma = 0.867$ S/m; $\epsilon_r = 42.553$; $\rho = 1000$ kg/m³

Ambient Temperature : 22.3 °C ; Liquid Temperature : 21.4 °C

DASY5 Configuration:

- Probe: EX3DV4 - SN3864; ConvF(10.03, 10.03, 10.03); Calibrated: 2014/07/25;
- Sensor-Surface: 2mm (Mechanical Surface Detection)
- Electronics: DAE3 Sn510; Calibrated: 2014/08/26
- Phantom: Twin SAM Phantom_1653; Type: QD000P40;
- Measurement SW: DASY52, Version 52.8 (8); SEMCAD X Version 14.6.10 (7331)

- **Area Scan (71x121x1):** Interpolated grid: dx=1.500 mm, dy=1.500 mm

Maximum value of SAR (interpolated) = 0.525 W/kg

- **Zoom Scan (5x5x7)/Cube 0:** Measurement grid: dx=8mm, dy=8mm, dz=5mm

Reference Value = 7.627 V/m; Power Drift = -0.11 dB

Peak SAR (extrapolated) = 0.576 W/kg

SAR(1 g) = 0.464 W/kg; SAR(10 g) = 0.354 W/kg

Maximum value of SAR (measured) = 0.519 W/kg

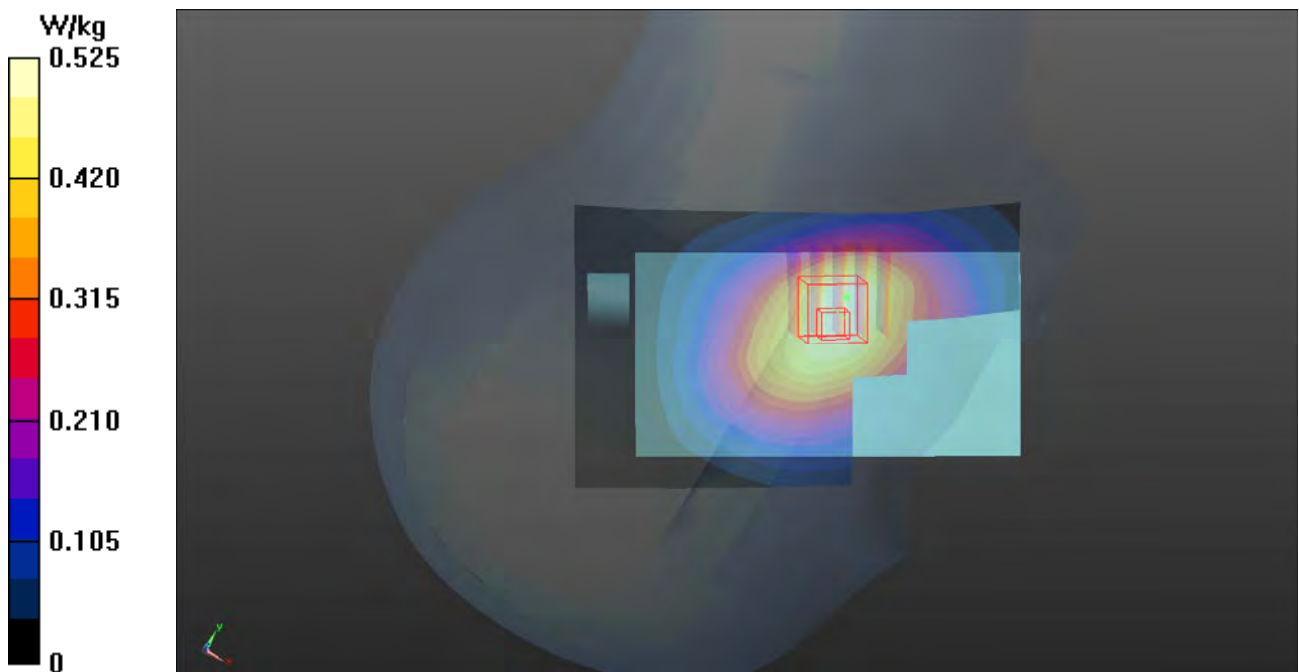

P05 LTE 7_QPSK20M_Left Cheek_Ch21100_1RB_OS0

DUT: 150522N017

Communication System: LTE; Frequency: 2535 MHz; Duty Cycle: 1:1

Medium: H2600-A_0607 Medium parameters used: $f = 2535$ MHz; $\sigma = 1.913$ S/m; $\epsilon_r = 37.903$; $\rho = 1000$ kg/m³

Ambient Temperature : 22.1 °C ; Liquid Temperature : 21.2 °C

DASY5 Configuration:

- Probe: EX3DV4 - SN3873; ConvF(7.05, 7.05, 7.05); Calibrated: 2014/08/26;
- Sensor-Surface: 2mm (Mechanical Surface Detection)
- Electronics: DAE4 Sn1341; Calibrated: 2014/08/26
- Phantom: Right Phantom with CRP v5.0; Type: QD000P40CD; Serial: TP:1722
- Measurement SW: DASY52, Version 52.8 (8); SEMCAD X Version 14.6.10 (7331)

- **Area Scan (81x131x1):** Interpolated grid: dx=1.200 mm, dy=1.200 mm

Maximum value of SAR (interpolated) = 0.217 W/kg

- **Zoom Scan (5x5x7)/Cube 0:** Measurement grid: dx=8mm, dy=8mm, dz=5mm

Reference Value = 4.505 V/m; Power Drift = -0.04 dB

Peak SAR (extrapolated) = 0.260 W/kg

SAR(1 g) = 0.145 W/kg; SAR(10 g) = 0.082 W/kg

Maximum value of SAR (measured) = 0.202 W/kg

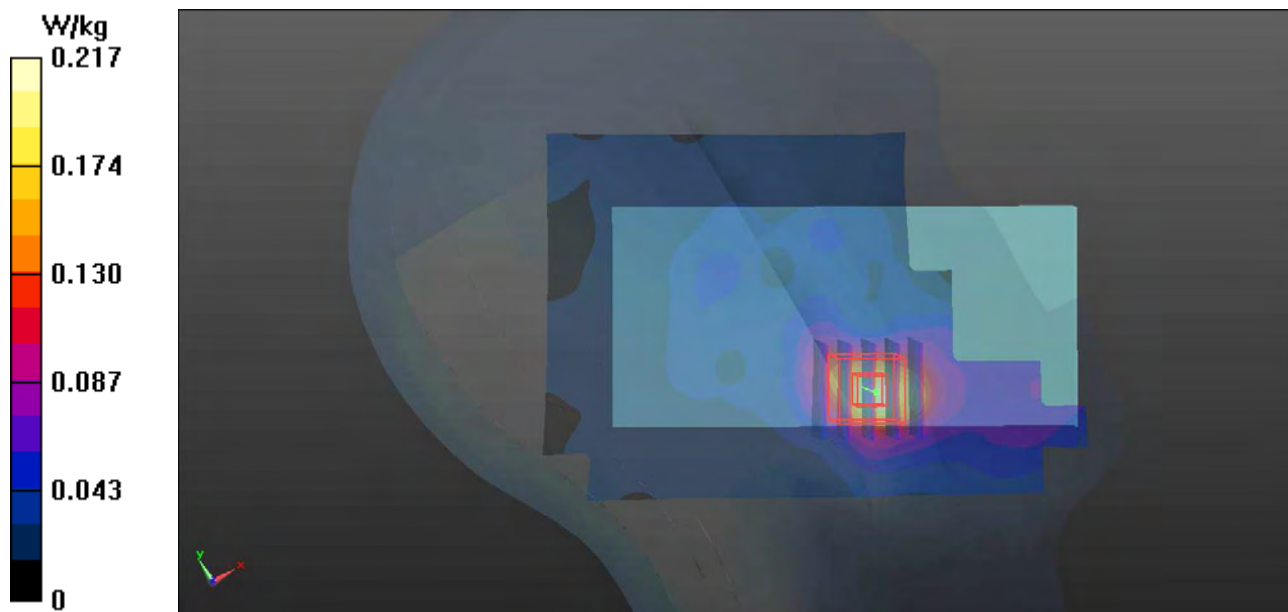

P06 2.4G WLAN_802.11b_Left Cheek_Ch6

DUT: 150522C22

Communication System: WLAN_2.4G; Frequency: 2437 MHz; Duty Cycle: 1:1

Medium: H24T25N2_0528 Medium parameters used: $f = 2437$ MHz; $\sigma = 1.816$ S/m; $\epsilon_r = 38.246$; $\rho = 1000$ kg/m³

Ambient Temperature : 22.2 °C ; Liquid Temperature : 21.5 °C

DASY5 Configuration:

- Probe: EX3DV4 - SN3590; ConvF(7.89, 7.89, 7.89); Calibrated: 2015/02/26;
- Sensor-Surface: 2mm (Mechanical Surface Detection)
- Electronics: DAE4 Sn861; Calibrated: 2015/04/28
- Phantom: Twin SAM Phantom_1202; Type: QD000P40;
- Measurement SW: DASY52, Version 52.8 (8); SEMCAD X Version 14.6.10 (7331)

- **Area Scan (91x151x1):** Interpolated grid: dx=1.200 mm, dy=1.200 mm

Maximum value of SAR (interpolated) = 0.0225 W/kg

- **Zoom Scan (5x5x7)/Cube 0:** Measurement grid: dx=8mm, dy=8mm, dz=5mm

Reference Value = 0.9060 V/m; Power Drift = 0.15 dB

Peak SAR (extrapolated) = 0.0160 W/kg

SAR(1 g) = 0.00867 W/kg; SAR(10 g) = 0.00498 W/kg

Maximum value of SAR (measured) = 0.0114 W/kg

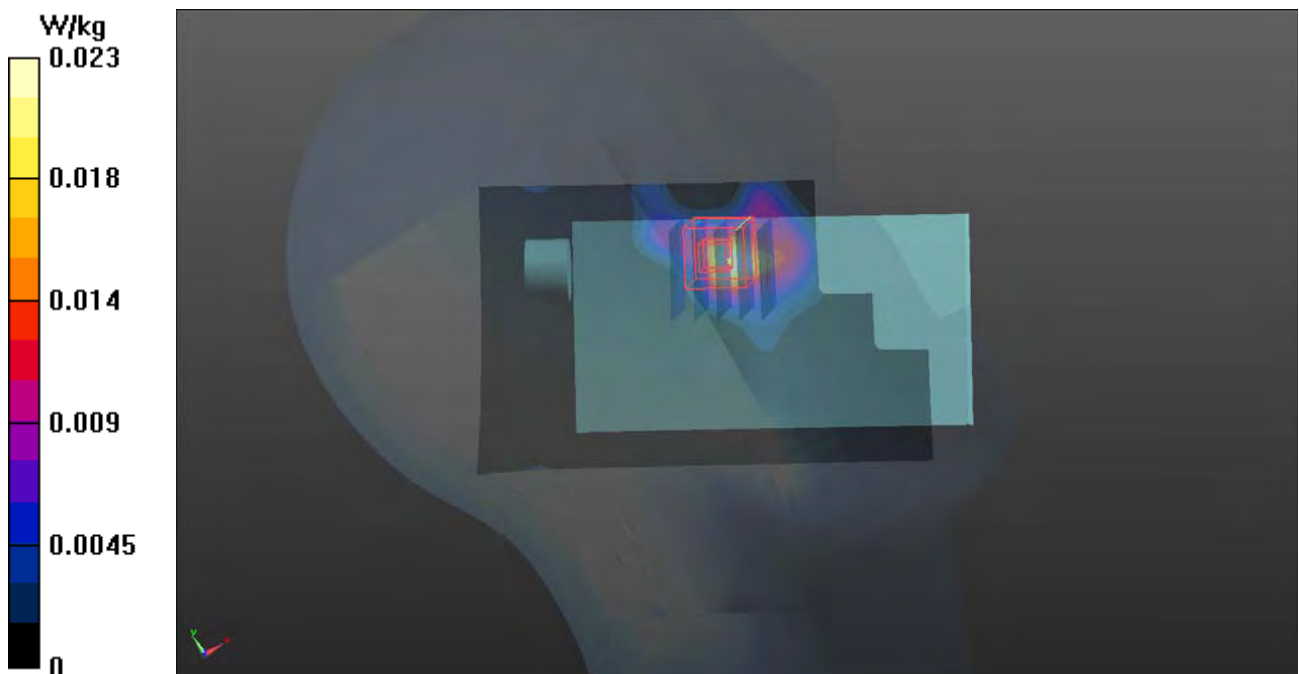

P07 5.2G WLAN_802.11n HT40_Left Tilted_Ch38

DUT: 150522C22

Communication System: WLAN_5G; Frequency: 5190 MHz; Duty Cycle: 1:1

Medium: H50T60N3_0603 Medium parameters used: $f = 5190$ MHz; $\sigma = 4.584$ S/m; $\epsilon_r = 36.127$; $\rho = 1000$ kg/m³

Ambient Temperature : 22.5 °C; Liquid Temperature : 22.2 °C

DASY5 Configuration:

- Probe: EX3DV4 - SN3590; ConvF(5.69, 5.69, 5.69); Calibrated: 2015/02/26;
- Sensor-Surface: 2mm (Mechanical Surface Detection)
- Electronics: DAE4 Sn861; Calibrated: 2015/04/28
- Phantom: Twin SAM Phantom_1202; Type: QD000P40;
- Measurement SW: DASY52, Version 52.8 (8); SEMCAD X Version 14.6.10 (7331)

- **Area Scan (121x161x1):** Interpolated grid: dx=1.000 mm, dy=1.000 mm

Maximum value of SAR (interpolated) = 0.0162 W/kg

- **Zoom Scan (6x6x12)/Cube 0:** Measurement grid: dx=5mm, dy=5mm, dz=2mm

Reference Value = 1.043 V/m; Power Drift = 0.04 dB

Peak SAR (extrapolated) = 0.0560 W/kg

SAR(1 g) = 0.00347 W/kg; SAR(10 g) = 0.00189 W/kg

Maximum value of SAR (measured) = 0.0110 W/kg

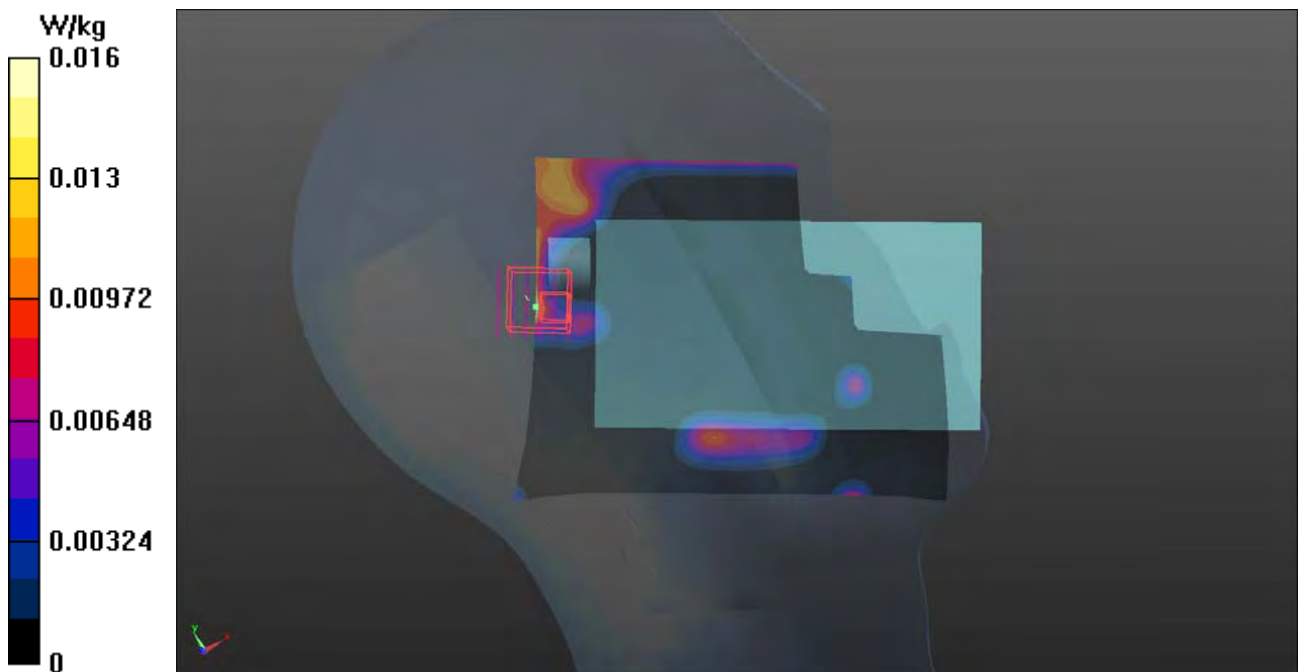

P08 5.6G WLAN_802.11n HT40_Left Tilted_Ch134

DUT: 150522C22

Communication System: WLAN_5G; Frequency: 5670 MHz; Duty Cycle: 1:1

Medium: H50T60N3_0603 Medium parameters used: $f = 5670$ MHz; $\sigma = 5.112$ S/m; $\epsilon_r = 35.669$; $\rho = 1000$ kg/m³

Ambient Temperature : 22.5 °C ; Liquid Temperature : 22.2 °C

DASY5 Configuration:

- Probe: EX3DV4 - SN3590; ConvF(4.72, 4.72, 4.72); Calibrated: 2015/02/26;
- Sensor-Surface: 2mm (Mechanical Surface Detection)
- Electronics: DAE4 Sn861; Calibrated: 2015/04/28
- Phantom: Twin SAM Phantom_1202; Type: QD000P40;
- Measurement SW: DASY52, Version 52.8 (8); SEMCAD X Version 14.6.10 (7331)

Area Scan (121x161x1): Interpolated grid: dx=1.000 mm, dy=1.000 mm

Maximum value of SAR (interpolated) = 0.0336 W/kg

Zoom Scan (6x6x12)/Cube 0: Measurement grid: dx=5mm, dy=5mm, dz=2mm

Reference Value = 0.8970 V/m; Power Drift = 0.07 dB

Peak SAR (extrapolated) = 0.0470 W/kg

SAR(1 g) = 0.00465 W/kg; SAR(10 g) = 0.00224 W/kg

Maximum value of SAR (measured) = 0.0136 W/kg

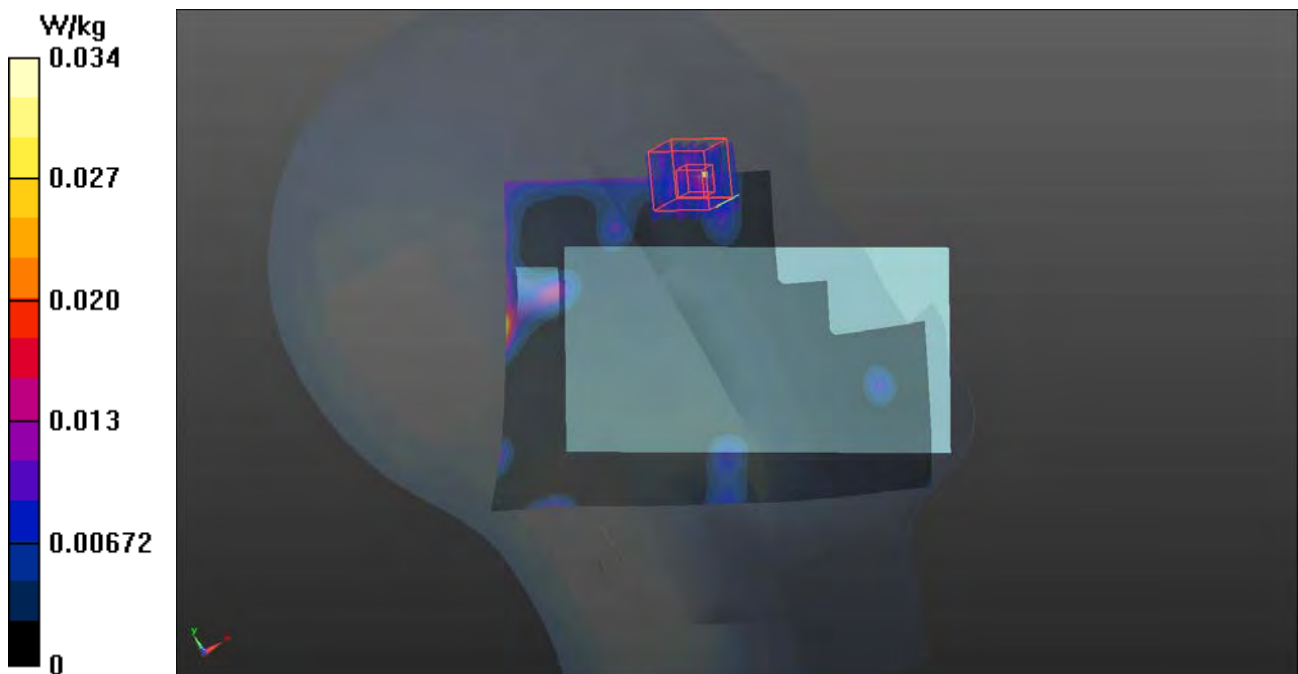

P09 GSM850_GPRS10_Fornt Face_1cm_Ch128

DUT: 150522C22

Communication System: GPRS10; Frequency: 824.2 MHz; Duty Cycle: 1:4

Medium: B08T09N3_0526 Medium parameters used: $f = 824.2$ MHz; $\sigma = 0.937$ S/m; $\epsilon_r = 54.731$; $\rho = 1000$ kg/m³

Ambient Temperature : 22.6 °C ; Liquid Temperature : 21.8 °C

DASY5 Configuration:

- Probe: EX3DV4 - SN3590; ConvF(10.3, 10.3, 10.3); Calibrated: 2015/02/26;
- Sensor-Surface: 2mm (Mechanical Surface Detection)
- Electronics: DAE4 Sn861; Calibrated: 2015/04/28
- Phantom: Twin SAM Phantom_1202; Type: QD000P40;
- Measurement SW: DASY52, Version 52.8 (8); SEMCAD X Version 14.6.10 (7331)

- **Area Scan (71x121x1):** Interpolated grid: dx=1.500 mm, dy=1.500 mm

Maximum value of SAR (interpolated) = 0.961 W/kg

- **Zoom Scan (5x5x7)/Cube 0:** Measurement grid: dx=8mm, dy=8mm, dz=5mm

Reference Value = 32.53 V/m; Power Drift = -0.05 dB

Peak SAR (extrapolated) = 1.03 W/kg

SAR(1 g) = 0.765 W/kg; SAR(10 g) = 0.458 W/kg

Maximum value of SAR (measured) = 0.944 W/kg

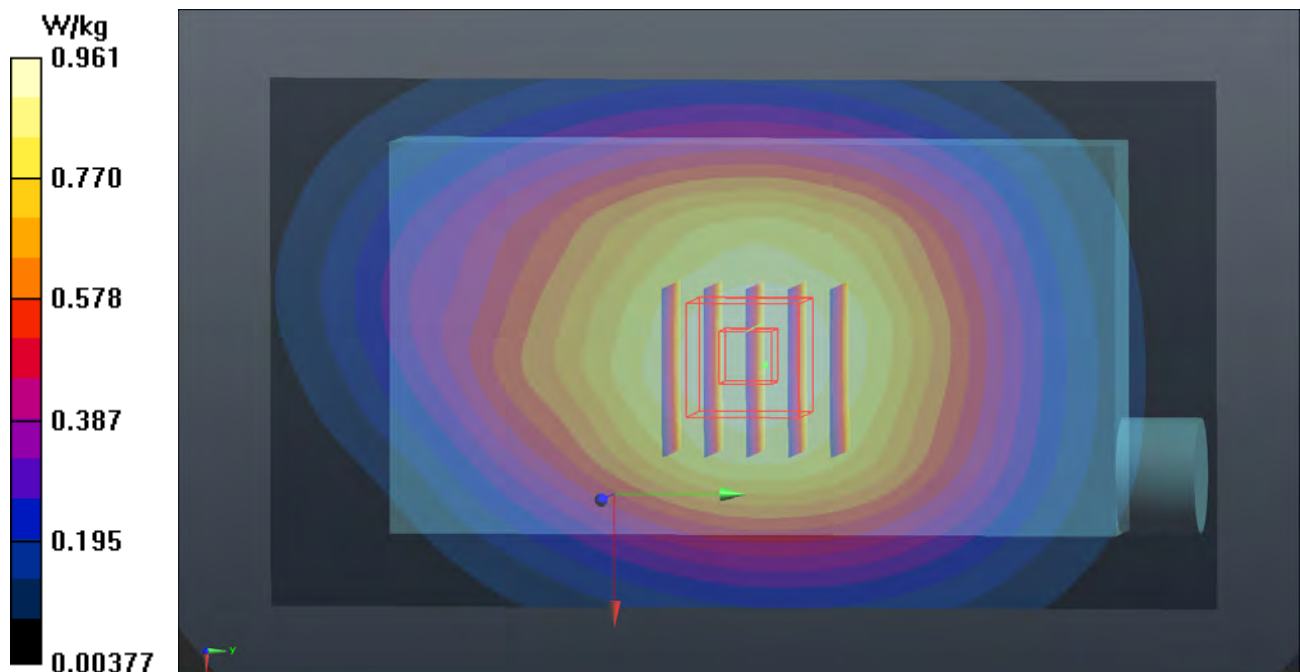

P10 GSM1900_GPRS10_Front Face_1cm_Ch512

DUT: 150522C22

Communication System: GPRS10; Frequency: 1850.2 MHz; Duty Cycle: 1:4

Medium: B18T19N1_0527 Medium parameters used: $f = 1850.2$ MHz; $\sigma = 1.517$ S/m; $\epsilon_r = 53.778$; $\rho = 1000$ kg/m³

Ambient Temperature : 22.5 °C ; Liquid Temperature : 21.5 °C

DASY5 Configuration:

- Probe: EX3DV4 - SN3864; ConvF(7.72, 7.72, 7.72); Calibrated: 2014/07/25;
- Sensor-Surface: 2mm (Mechanical Surface Detection)
- Electronics: DAE3 Sn510; Calibrated: 2014/08/26
- Phantom: Twin SAM Phantom_1653; Type: QD000P40;
- Measurement SW: DASY52, Version 52.8 (8); SEMCAD X Version 14.6.10 (7331)

- **Area Scan (71x121x1):** Interpolated grid: dx=1.500 mm, dy=1.500 mm

Maximum value of SAR (interpolated) = 0.552 W/kg

- **Zoom Scan (5x5x7)/Cube 0:** Measurement grid: dx=8mm, dy=8mm, dz=5mm

Reference Value = 9.441 V/m; Power Drift = -0.02 dB

Peak SAR (extrapolated) = 0.688 W/kg

SAR(1 g) = 0.437 W/kg; SAR(10 g) = 0.259 W/kg

Maximum value of SAR (measured) = 0.578 W/kg

- **Zoom Scan (5x5x7)/Cube 1:** Measurement grid: dx=8mm, dy=8mm, dz=5mm

Reference Value = 9.441 V/m; Power Drift = -0.02 dB

Peak SAR (extrapolated) = 0.659 W/kg

SAR(1 g) = 0.405 W/kg; SAR(10 g) = 0.247 W/kg

Maximum value of SAR (measured) = 0.531 W/kg

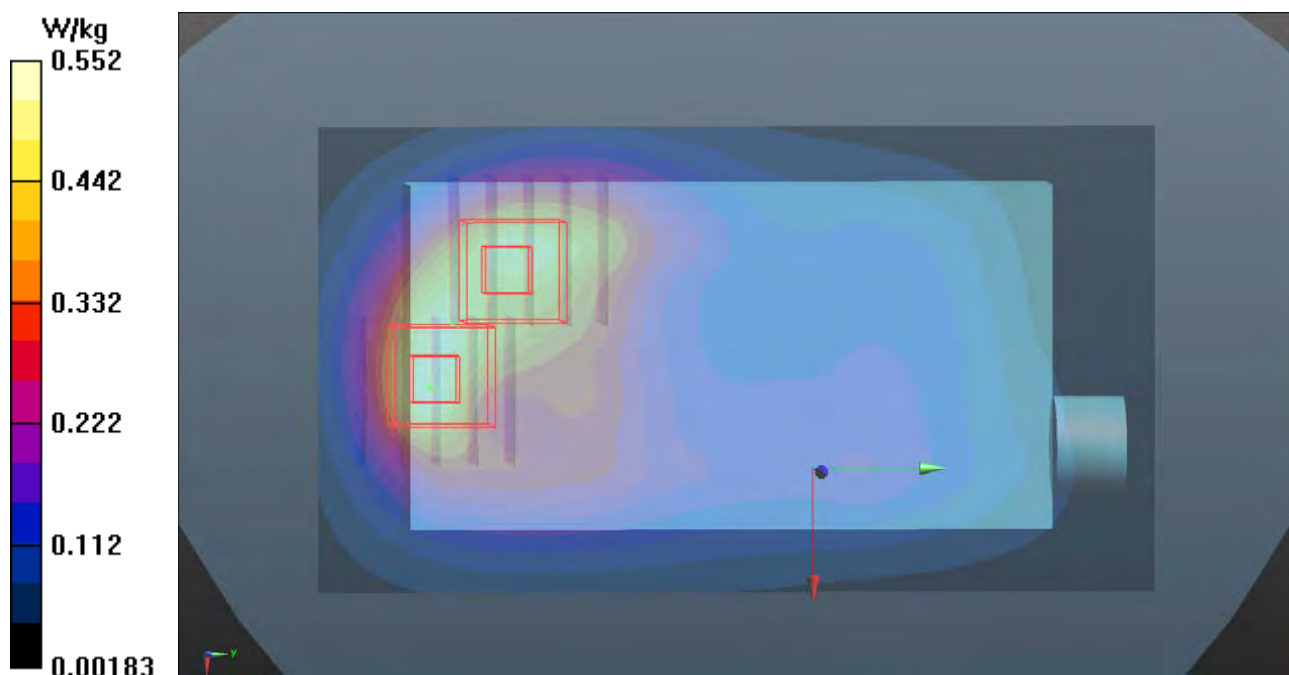

P11 WCDMA II_RMC12.2K_Front Face_1cm_Ch9538

DUT: 150522C22

Communication System: WCDMA; Frequency: 1907.6 MHz; Duty Cycle: 1:1

Medium: B18T19N1_0527 Medium parameters used: $f = 1908 \text{ MHz}$; $\sigma = 1.556 \text{ S/m}$; $\epsilon_r = 53.761$; $\rho = 1000 \text{ kg/m}^3$

Ambient Temperature : $22.5 \text{ }^\circ\text{C}$; Liquid Temperature : $21.5 \text{ }^\circ\text{C}$

DASY5 Configuration:

- Probe: EX3DV4 - SN3864; ConvF(7.72, 7.72, 7.72); Calibrated: 2014/07/25;
- Sensor-Surface: 2mm (Mechanical Surface Detection)
- Electronics: DAE3 Sn510; Calibrated: 2014/08/26
- Phantom: Twin SAM Phantom_1653; Type: QD000P40;
- Measurement SW: DASY52, Version 52.8 (8); SEMCAD X Version 14.6.10 (7331)

- **Area Scan (71x121x1):** Interpolated grid: $dx=1.500 \text{ mm}$, $dy=1.500 \text{ mm}$

Maximum value of SAR (interpolated) = 0.760 W/kg

- **Zoom Scan (5x5x7)/Cube 0:** Measurement grid: $dx=8\text{mm}$, $dy=8\text{mm}$, $dz=5\text{mm}$

Reference Value = 8.114 V/m ; Power Drift = -0.12 dB

Peak SAR (extrapolated) = 0.896 W/kg

SAR(1 g) = 0.562 W/kg ; SAR(10 g) = 0.324 W/kg

Maximum value of SAR (measured) = 0.726 W/kg

- **Zoom Scan (5x5x7)/Cube 1:** Measurement grid: $dx=8\text{mm}$, $dy=8\text{mm}$, $dz=5\text{mm}$

Reference Value = 8.114 V/m ; Power Drift = -0.12 dB

Peak SAR (extrapolated) = 0.826 W/kg

SAR(1 g) = 0.474 W/kg ; SAR(10 g) = 0.277 W/kg

Maximum value of SAR (measured) = 0.689 W/kg

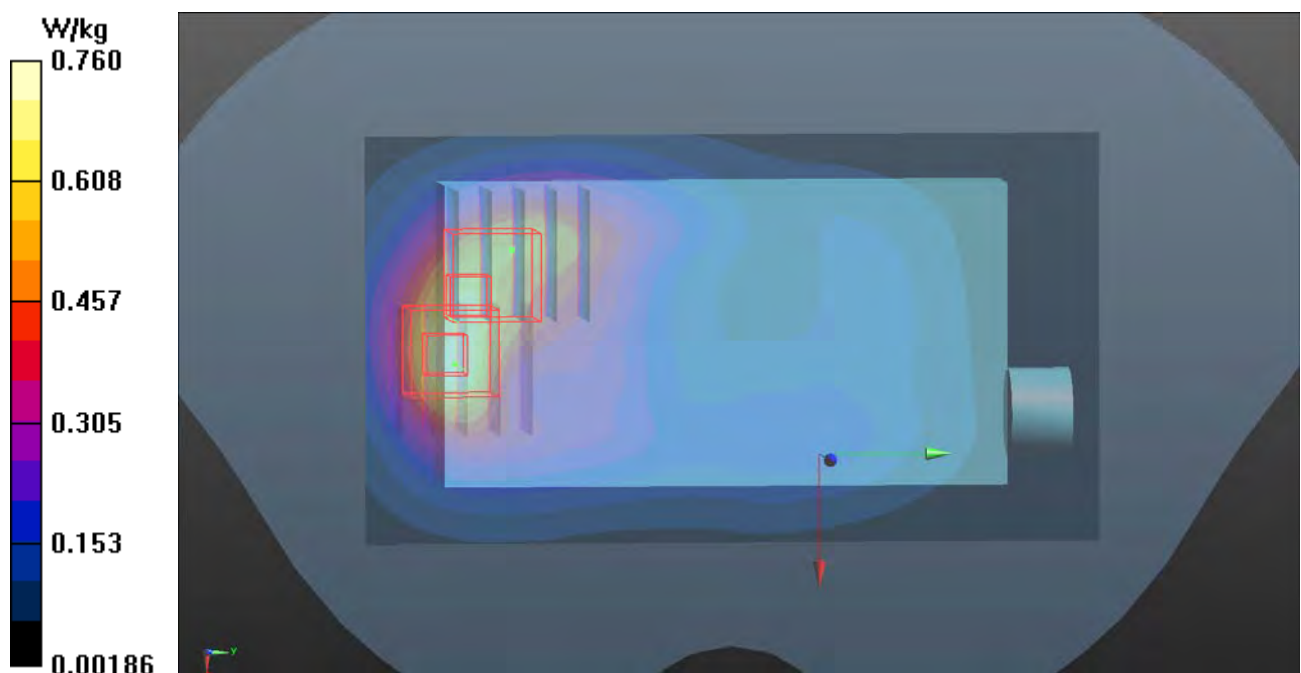

P12 WCDMA V_RMC12.2K_Front Face_1cm_Ch4132

DUT: 150522C22

Communication System: WCDMA; Frequency: 826.4 MHz; Duty Cycle: 1:1

Medium: B08T09N3_0526 Medium parameters used: $f = 826.4$ MHz; $\sigma = 0.94$ S/m; $\epsilon_r = 54.715$; $\rho = 1000$ kg/m³

Ambient Temperature : 22.6 °C ; Liquid Temperature : 21.8 °C

DASY5 Configuration:

- Probe: EX3DV4 - SN3590; ConvF(10.3, 10.3, 10.3); Calibrated: 2015/02/26;
- Sensor-Surface: 2mm (Mechanical Surface Detection)
- Electronics: DAE4 Sn861; Calibrated: 2015/04/28
- Phantom: Twin SAM Phantom_1202; Type: QD000P40;
- Measurement SW: DASY52, Version 52.8 (8); SEMCAD X Version 14.6.10 (7331)

- **Area Scan (71x121x1):** Interpolated grid: dx=1.500 mm, dy=1.500 mm

Maximum value of SAR (interpolated) = 0.554 W/kg

- **Zoom Scan (5x5x7)/Cube 0:** Measurement grid: dx=8mm, dy=8mm, dz=5mm

Reference Value = 24.64 V/m; Power Drift = -0.02 dB

Peak SAR (extrapolated) = 0.604 W/kg

SAR(1 g) = 0.486 W/kg; SAR(10 g) = 0.380 W/kg

Maximum value of SAR (measured) = 0.554 W/kg

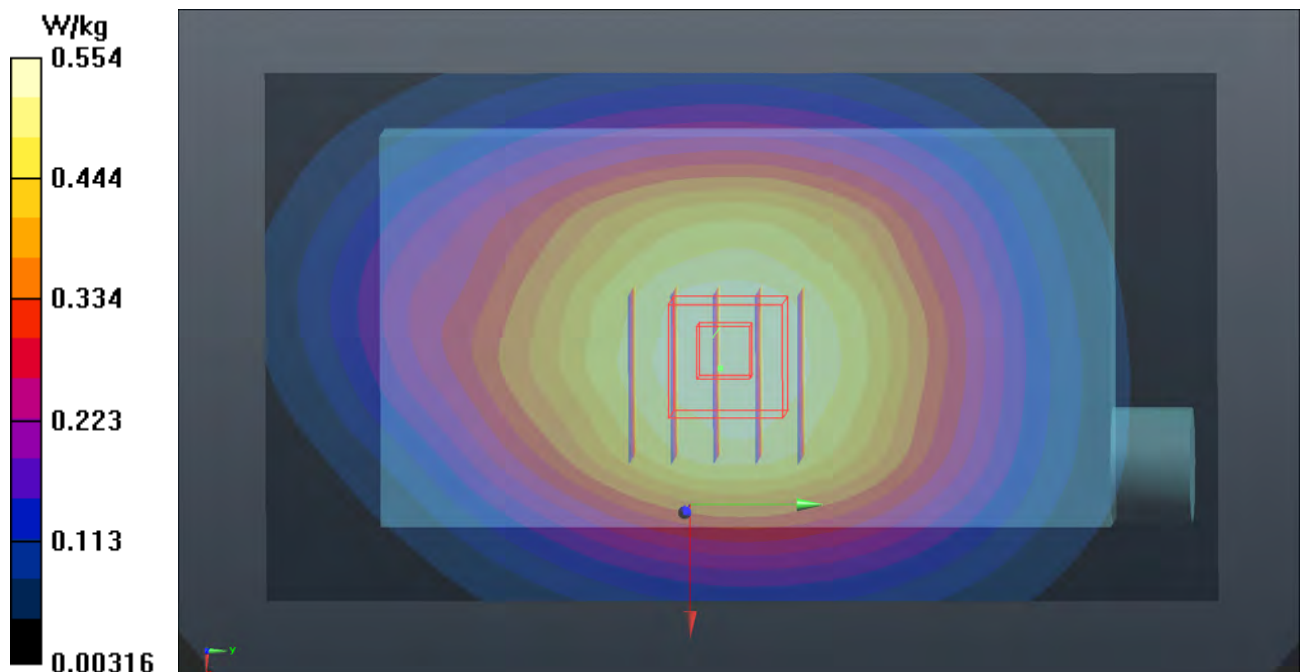

P13 LTE 7_QPSK20M_Rear Face_1cm_Ch21100_1RB_OS0

DUT: 150522N017

Communication System: LTE; Frequency: 2535 MHz; Duty Cycle: 1:1

Medium: B2600-A_0607 Medium parameters used: $f = 2535$ MHz; $\sigma = 2.12$ S/m; $\epsilon_r = 52.621$; $\rho = 1000$ kg/m³

Ambient Temperature : 22.2 °C ; Liquid Temperature : 21.3 °C

DASY5 Configuration:

- Probe: EX3DV4 - SN3873; ConvF(6.94, 6.94, 6.94); Calibrated: 2014/08/26;
- Sensor-Surface: 2mm (Mechanical Surface Detection)
- Electronics: DAE4 Sn1341; Calibrated: 2014/08/26
- Phantom: ELI 5.0; Type: QD OVA 001 BB; Serial: TP:1205
- Measurement SW: DASY52, Version 52.8 (8); SEMCAD X Version 14.6.10 (7331)

- **Area Scan (81x131x1):** Interpolated grid: dx=1.200 mm, dy=1.200 mm

Maximum value of SAR (interpolated) = 0.718 W/kg

- **Zoom Scan (5x5x7)/Cube 0:** Measurement grid: dx=8mm, dy=8mm, dz=5mm

Reference Value = 3.399 V/m; Power Drift = 0.03 dB

Peak SAR (extrapolated) = 0.817 W/kg

SAR(1 g) = 0.406 W/kg; SAR(10 g) = 0.204 W/kg

Maximum value of SAR (measured) = 0.599 W/kg

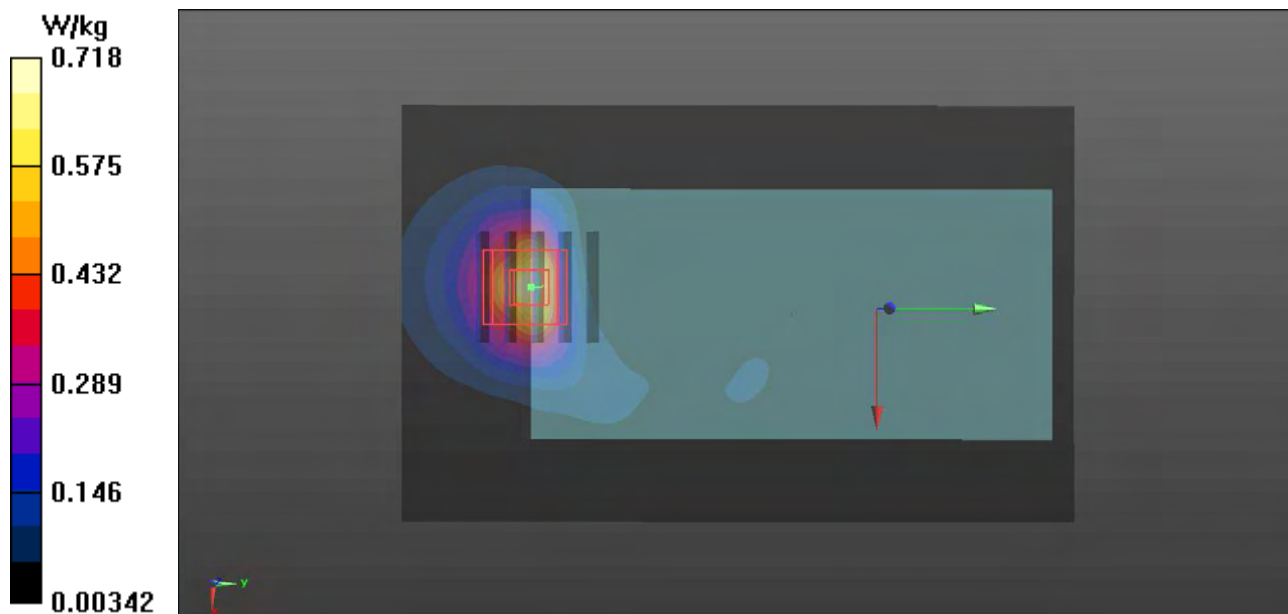

P14 2.4G WLAN_802.11b_Rear Face_1cm_Ch6

DUT: 150522C22

Communication System: WLAN_2.4G; Frequency: 2437 MHz; Duty Cycle: 1:1

Medium: B24T25N1_0528 Medium parameters used: $f = 2437$ MHz; $\sigma = 1.902$ S/m; $\epsilon_r = 53.969$; $\rho = 1000$ kg/m³

Ambient Temperature : 22.4 °C ; Liquid Temperature : 21.7 °C

DASY5 Configuration:

- Probe: EX3DV4 - SN3590; ConvF(7.78, 7.78, 7.78); Calibrated: 2015/02/26;
- Sensor-Surface: 2mm (Mechanical Surface Detection)
- Electronics: DAE4 Sn861; Calibrated: 2015/04/28
- Phantom: Twin SAM Phantom_1654; Type: QD000P40;
- Measurement SW: DASY52, Version 52.8 (8); SEMCAD X Version 14.6.10 (7331)

- **Area Scan (91x151x1):** Interpolated grid: dx=1.200 mm, dy=1.200 mm

Maximum value of SAR (interpolated) = 0.0141 W/kg

- **Zoom Scan (5x5x7)/Cube 0:** Measurement grid: dx=8mm, dy=8mm, dz=5mm

Reference Value = 1.860 V/m; Power Drift = 0.12 dB

Peak SAR (extrapolated) = 0.0220 W/kg

SAR(1 g) = 0.011 W/kg; SAR(10 g) = 0.00533 W/kg

Maximum value of SAR (measured) = 0.0153 W/kg

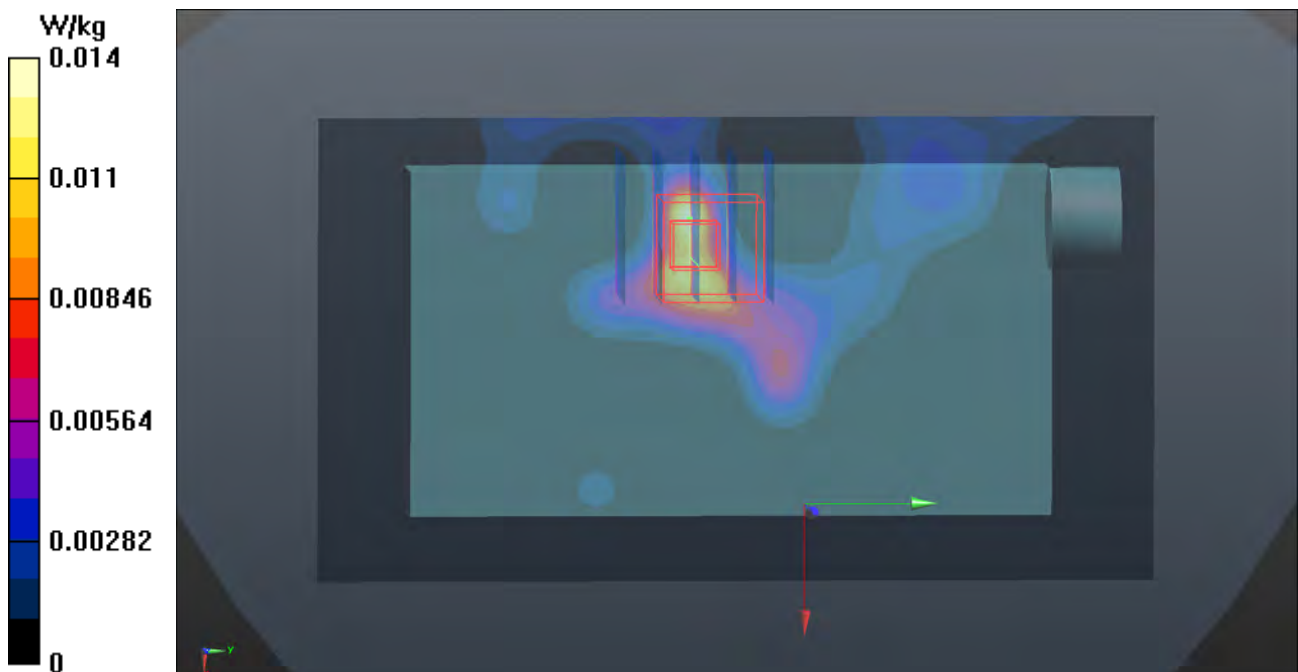

P15 GSM1900_GPRS10_Bottom Side_1cm_Ch512

DUT: 150522C22

Communication System: GPRS10; Frequency: 1850.2 MHz; Duty Cycle: 1:4

Medium: B18T19N1_0527 Medium parameters used: $f = 1850.2$ MHz; $\sigma = 1.517$ S/m; $\epsilon_r = 53.778$; $\rho = 1000$ kg/m³

Ambient Temperature : 22.5 °C ; Liquid Temperature : 21.5 °C

DASY5 Configuration:

- Probe: EX3DV4 - SN3864; ConvF(7.72, 7.72, 7.72); Calibrated: 2014/07/25;
- Sensor-Surface: 2mm (Mechanical Surface Detection)
- Electronics: DAE3 Sn510; Calibrated: 2014/08/26
- Phantom: Twin SAM Phantom_1653; Type: QD000P40;
- Measurement SW: DASY52, Version 52.8 (8); SEMCAD X Version 14.6.10 (7331)

- **Area Scan (61x81x1):** Interpolated grid: dx=1.500 mm, dy=1.500 mm

Maximum value of SAR (interpolated) = 0.620 W/kg

- **Zoom Scan (5x5x7)/Cube 0:** Measurement grid: dx=8mm, dy=8mm, dz=5mm

Reference Value = 20.10 V/m; Power Drift = 0.01 dB

Peak SAR (extrapolated) = 0.825 W/kg

SAR(1 g) = 0.502 W/kg; SAR(10 g) = 0.279 W/kg

Maximum value of SAR (measured) = 0.681 W/kg

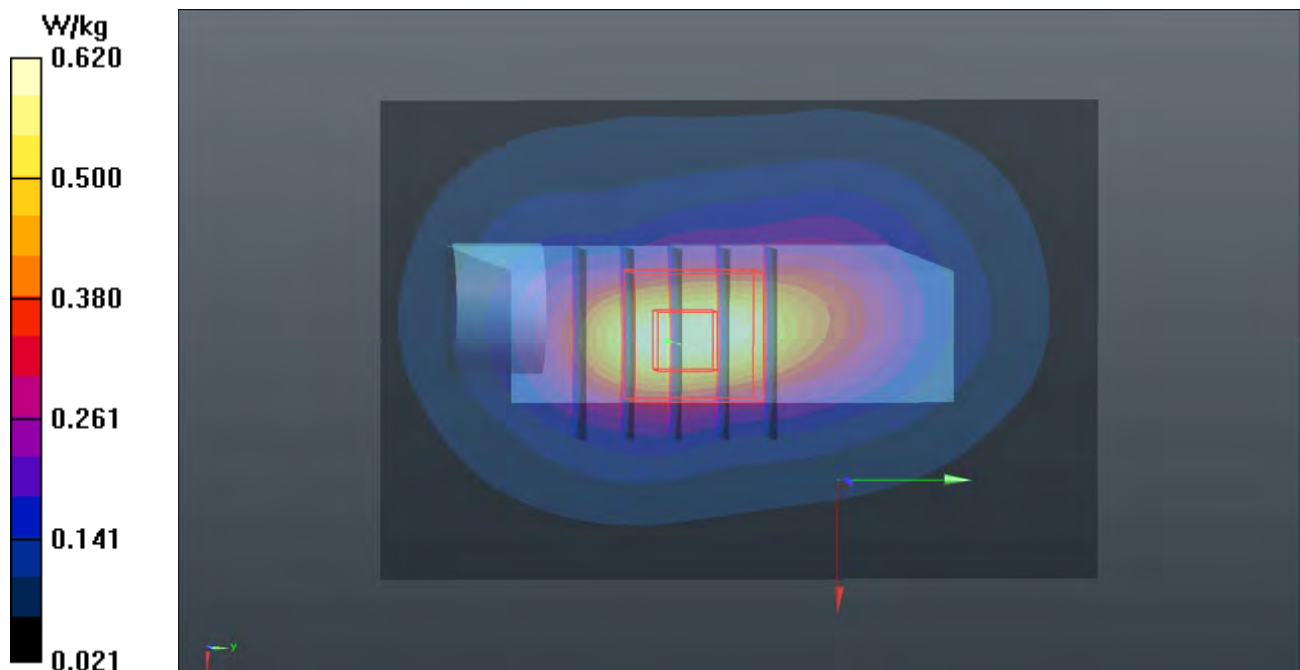

P16 WCDMA II_RMC12.2K_Bottom Side_1cm_Ch9538

DUT: 150522C22

Communication System: WCDMA; Frequency: 1907.6 MHz; Duty Cycle: 1:1

Medium: B18T19N1_0527 Medium parameters used: $f = 1908$ MHz; $\sigma = 1.556$ S/m; $\epsilon_r = 53.761$; $\rho = 1000$ kg/m³

Ambient Temperature : 22.5 °C ; Liquid Temperature : 21.5 °C

DASY5 Configuration:

- Probe: EX3DV4 - SN3864; ConvF(7.72, 7.72, 7.72); Calibrated: 2014/07/25;
- Sensor-Surface: 2mm (Mechanical Surface Detection)
- Electronics: DAE3 Sn510; Calibrated: 2014/08/26
- Phantom: Twin SAM Phantom_1653; Type: QD000P40;
- Measurement SW: DASY52, Version 52.8 (8); SEMCAD X Version 14.6.10 (7331)

- **Area Scan (61x81x1):** Interpolated grid: dx=1.500 mm, dy=1.500 mm

Maximum value of SAR (interpolated) = 0.777 W/kg

- **Zoom Scan (5x5x7)/Cube 0:** Measurement grid: dx=8mm, dy=8mm, dz=5mm

Reference Value = 22.40 V/m; Power Drift = 0.00 dB

Peak SAR (extrapolated) = 1.05 W/kg

SAR(1 g) = 0.627 W/kg; SAR(10 g) = 0.346 W/kg

Maximum value of SAR (measured) = 0.840 W/kg

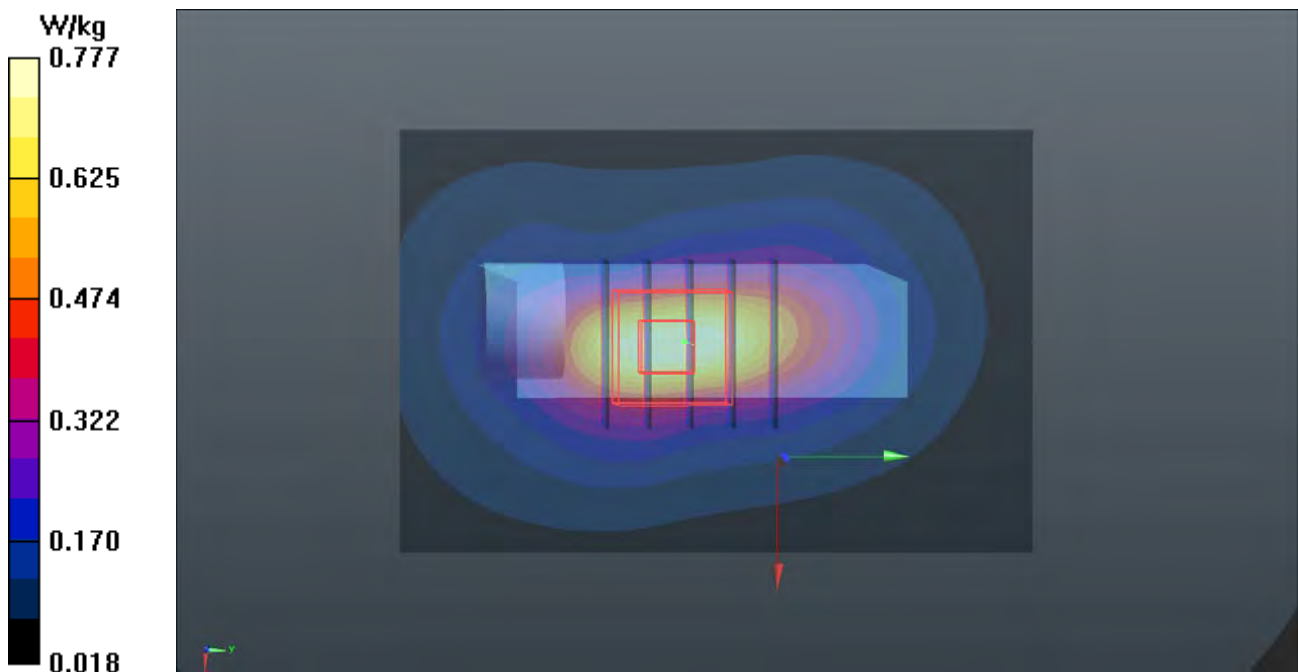

P17 LTE 7_QPSK20M_Bottom Side_1cm_Ch21350_1RB_OS0

DUT: 150522N017

Communication System: LTE; Frequency: 2560 MHz; Duty Cycle: 1:1

Medium: B2600-A_0607 Medium parameters used: $f = 2560$ MHz; $\sigma = 2.153$ S/m; $\epsilon_r = 52.542$; $\rho = 1000$ kg/m³

Ambient Temperature : 22.2 °C; Liquid Temperature : 21.3 °C

DASY5 Configuration:

- Probe: EX3DV4 - SN3873; ConvF(6.94, 6.94, 6.94); Calibrated: 2014/08/26;
- Sensor-Surface: 2mm (Mechanical Surface Detection)
- Electronics: DAE4 Sn1341; Calibrated: 2014/08/26
- Phantom: ELI 5.0; Type: QD OVA 001 BB; Serial: TP:1205
- Measurement SW: DASY52, Version 52.8 (8); SEMCAD X Version 14.6.10 (7331)

- **Area Scan (61x101x1):** Interpolated grid: dx=1.200 mm, dy=1.200 mm

Maximum value of SAR (interpolated) = 1.88 W/kg

- **Zoom Scan (5x5x7)/Cube 0:** Measurement grid: dx=8mm, dy=8mm, dz=5mm

Reference Value = 21.26 V/m; Power Drift = 0.15 dB

Peak SAR (extrapolated) = 2.40 W/kg

SAR(1 g) = 1.14 W/kg; SAR(10 g) = 0.546 W/kg

Maximum value of SAR (measured) = 1.73 W/kg

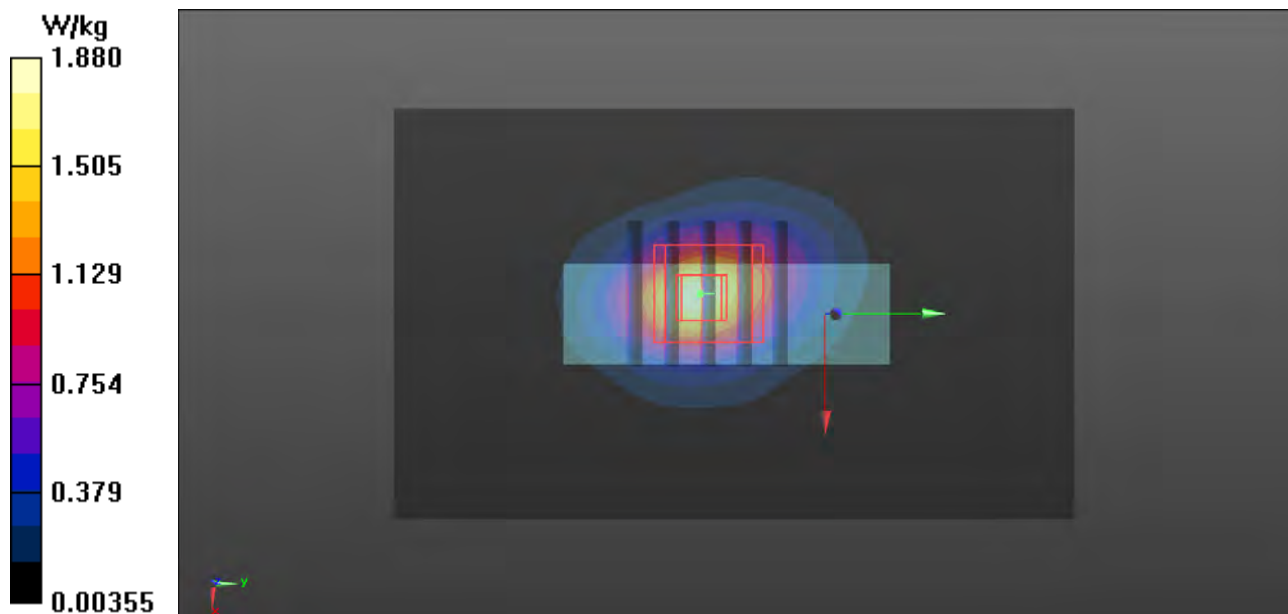

P18 2.4G WLAN_802.11b_Right Side_1cm_Ch6

DUT: 150522C22

Communication System: WLAN_2.4G; Frequency: 2437 MHz; Duty Cycle: 1:1

Medium: B24T25N1_0528 Medium parameters used: $f = 2437$ MHz; $\sigma = 1.902$ S/m; $\epsilon_r = 53.969$; $\rho = 1000$ kg/m³

Ambient Temperature : 22.4 °C; Liquid Temperature : 21.7 °C

DASY5 Configuration:

- Probe: EX3DV4 - SN3590; ConvF(7.78, 7.78, 7.78); Calibrated: 2015/02/26;
- Sensor-Surface: 2mm (Mechanical Surface Detection)
- Electronics: DAE4 Sn861; Calibrated: 2015/04/28
- Phantom: Twin SAM Phantom_1654; Type: QD000P40;
- Measurement SW: DASY52, Version 52.8 (8); SEMCAD X Version 14.6.10 (7331)

- **Area Scan (71x151x1):** Interpolated grid: dx=1.200 mm, dy=1.200 mm

Maximum value of SAR (interpolated) = 0.0210 W/kg

- **Zoom Scan (5x5x7)/Cube 0:** Measurement grid: dx=8mm, dy=8mm, dz=5mm

Reference Value = 2.664 V/m; Power Drift = 0.03 dB

Peak SAR (extrapolated) = 0.0200 W/kg

SAR(1 g) = 0.012 W/kg; SAR(10 g) = 0.00519 W/kg

Maximum value of SAR (measured) = 0.0158 W/kg

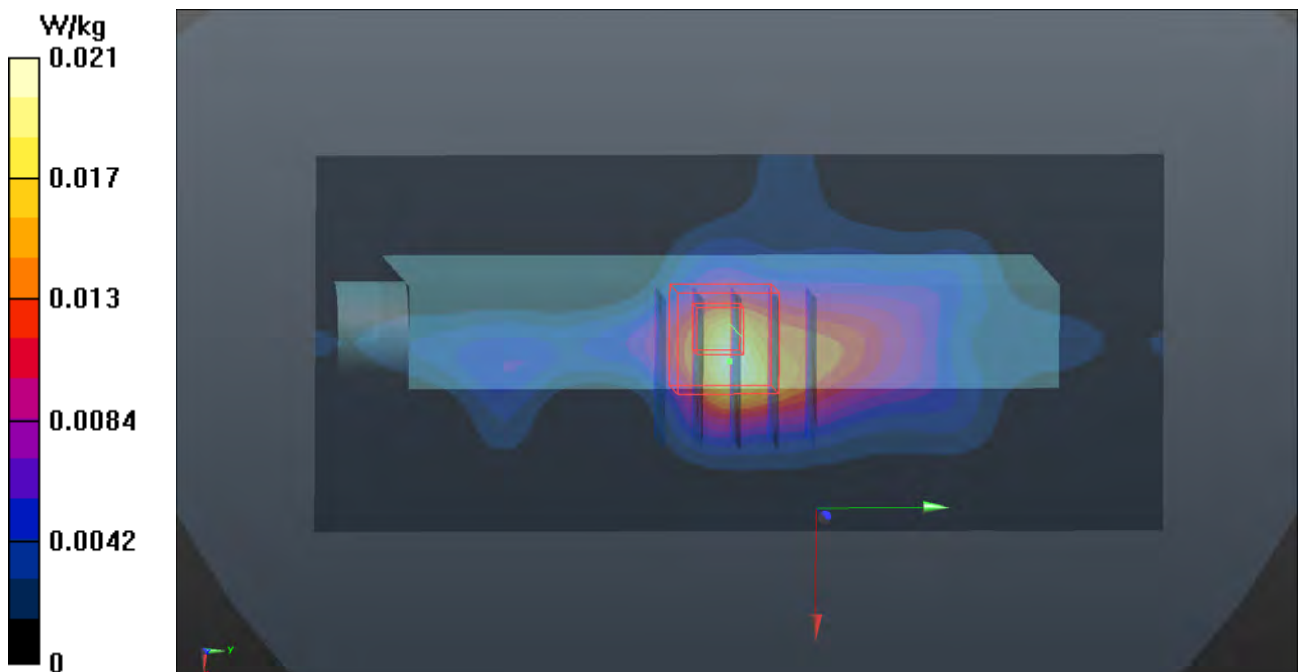



Appendix C. Calibration Certificate for Probe and Dipole

The SPEAG calibration certificates are shown as follows.



Accredited by the Swiss Accreditation Service (SAS)
**The Swiss Accreditation Service is one of the signatories to the EA
Multilateral Agreement for the recognition of calibration certificates**

Accreditation No.: SCS 108

Client B.V. ADT (Auden)

Certificate No: D835V2-4d121_Aug14

CALIBRATION CERTIFICATE

Object D835V2 - SN: 4d121

**Calibration procedure(s) QA CAL-05.v9
Calibration procedure for dipole validation kits above 700 MHz**

Calibration date: August 28, 2014

This calibration certificate documents the traceability to national standards, which realize the physical units of measurements (SI).
The measurements and the uncertainties with confidence probability are given on the following pages and are part of the certificate.

All calibrations have been conducted in the closed laboratory facility: environment temperature (22 ± 3)°C and humidity < 70%.

Calibration Equipment used (M&TE critical for calibration)

Primary Standards	ID #	Cal Date (Certificate No.)	Scheduled Calibration
Power meter EPM-442A	GB37480704	09-Oct-13 (No. 217-01827)	Oct-14
Power sensor HP 8481A	US37292783	09-Oct-13 (No. 217-01827)	Oct-14
Power sensor HP 8481A	MY41092317	09-Oct-13 (No. 217-01828)	Oct-14
Reference 20 dB Attenuator	SN: 5058 (20k)	03-Apr-14 (No. 217-01918)	Apr-15
Type-N mismatch combination	SN: 5047.2 / 06327	03-Apr-14 (No. 217-01921)	Apr-15
Reference Probe ES3DV3	SN: 3205	30-Dec-13 (No. ES3-3205_Dec13)	Dec-14
DAE4	SN: 601	18-Aug-14 (No. DAE4-601_Aug14)	Aug-15
Secondary Standards	ID #	Check Date (in house)	Scheduled Check
RF generator R&S SMT-06	100005	04-Aug-99 (in house check Oct-13)	In house check: Oct-16
Network Analyzer HP 8753E	US37390585 S4206	18-Oct-01 (in house check Oct-13)	In house check: Oct-14

Calibrated by:	Name Michael Weber	Function Laboratory Technician	Signature
Approved by:	Name Katja Pokovic	Function Technical Manager	

Issued: August 28, 2014

This calibration certificate shall not be reproduced except in full without written approval of the laboratory.



Accredited by the Swiss Accreditation Service (SAS)

The Swiss Accreditation Service is one of the signatories to the EA Multilateral Agreement for the recognition of calibration certificates

Accreditation No.: **SCS 108**

Glossary:

TSL	tissue simulating liquid
ConvF	sensitivity in TSL / NORM x,y,z
N/A	not applicable or not measured

Calibration is Performed According to the Following Standards:

- IEEE Std 1528-2013, "IEEE Recommended Practice for Determining the Peak Spatial-Averaged Specific-Absorption Rate (SAR) in the Human Head from Wireless Communications Devices: Measurement Techniques", June 2013
- IEC 62209-1, "Procedure to measure the Specific Absorption Rate (SAR) for hand-held devices used in close proximity to the ear (frequency range of 300 MHz to 3 GHz)", February 2005
- KDB 865664, "SAR Measurement Requirements for 100 MHz to 6 GHz"

Additional Documentation:

- DASY4/5 System Handbook

Methods Applied and Interpretation of Parameters:

- Measurement Conditions:** Further details are available from the Validation Report at the end of the certificate. All figures stated in the certificate are valid at the frequency indicated.
- Antenna Parameters with TSL:** The dipole is mounted with the spacer to position its feed point exactly below the center marking of the flat phantom section, with the arms oriented parallel to the body axis.
- Feed Point Impedance and Return Loss:** These parameters are measured with the dipole positioned under the liquid filled phantom. The impedance stated is transformed from the measurement at the SMA connector to the feed point. The Return Loss ensures low reflected power. No uncertainty required.
- Electrical Delay:** One-way delay between the SMA connector and the antenna feed point. No uncertainty required.
- SAR measured:** SAR measured at the stated antenna input power.
- SAR normalized:** SAR as measured, normalized to an input power of 1 W at the antenna connector.
- SAR for nominal TSL parameters:** The measured TSL parameters are used to calculate the nominal SAR result.

The reported uncertainty of measurement is stated as the standard uncertainty of measurement multiplied by the coverage factor $k=2$, which for a normal distribution corresponds to a coverage probability of approximately 95%.

Measurement Conditions

DASY system configuration, as far as not given on page 1.

DASY Version	DASY5	V52.8.8
Extrapolation	Advanced Extrapolation	
Phantom	Modular Flat Phantom	
Distance Dipole Center - TSL	15 mm	with Spacer
Zoom Scan Resolution	dx, dy, dz = 5 mm	
Frequency	835 MHz \pm 1 MHz	

Head TSL parameters

The following parameters and calculations were applied.

	Temperature	Permittivity	Conductivity
Nominal Head TSL parameters	22.0 °C	41.5	0.90 mho/m
Measured Head TSL parameters	(22.0 \pm 0.2) °C	42.0 \pm 6 %	0.94 mho/m \pm 6 %
Head TSL temperature change during test	< 0.5 °C	----	----

SAR result with Head TSL

SAR averaged over 1 cm³ (1 g) of Head TSL	Condition	
SAR measured	250 mW input power	2.43 W/kg
SAR for nominal Head TSL parameters	normalized to 1W	9.43 W/kg \pm 17.0 % (k=2)

SAR averaged over 10 cm³ (10 g) of Head TSL	condition	
SAR measured	250 mW input power	1.59 W/kg
SAR for nominal Head TSL parameters	normalized to 1W	6.21 W/kg \pm 16.5 % (k=2)

Body TSL parameters

The following parameters and calculations were applied.

	Temperature	Permittivity	Conductivity
Nominal Body TSL parameters	22.0 °C	55.2	0.97 mho/m
Measured Body TSL parameters	(22.0 \pm 0.2) °C	55.2 \pm 6 %	1.01 mho/m \pm 6 %
Body TSL temperature change during test	< 0.5 °C	----	----

SAR result with Body TSL

SAR averaged over 1 cm³ (1 g) of Body TSL	Condition	
SAR measured	250 mW input power	2.46 W/kg
SAR for nominal Body TSL parameters	normalized to 1W	9.55 W/kg \pm 17.0 % (k=2)

SAR averaged over 10 cm³ (10 g) of Body TSL	condition	
SAR measured	250 mW input power	1.62 W/kg
SAR for nominal Body TSL parameters	normalized to 1W	6.33 W/kg \pm 16.5 % (k=2)

Appendix (Additional assessments outside the scope of SCS108)

Antenna Parameters with Head TSL

Impedance, transformed to feed point	51.9 Ω - 1.8 j Ω
Return Loss	- 31.8 dB

Antenna Parameters with Body TSL

Impedance, transformed to feed point	47.4 Ω - 4.0 j Ω
Return Loss	- 26.2 dB

General Antenna Parameters and Design

Electrical Delay (one direction)	1.394 ns
----------------------------------	----------

After long term use with 100W radiated power, only a slight warming of the dipole near the feedpoint can be measured.

The dipole is made of standard semirigid coaxial cable. The center conductor of the feeding line is directly connected to the second arm of the dipole. The antenna is therefore short-circuited for DC-signals. On some of the dipoles, small end caps are added to the dipole arms in order to improve matching when loaded according to the position as explained in the "Measurement Conditions" paragraph. The SAR data are not affected by this change. The overall dipole length is still according to the Standard.

No excessive force must be applied to the dipole arms, because they might bend or the soldered connections near the feedpoint may be damaged.

Additional EUT Data

Manufactured by	SPEAG
Manufactured on	June 29, 2010

DASY5 Validation Report for Head TSL

Date: 28.08.2014

Test Laboratory: SPEAG, Zurich, Switzerland

DUT: Dipole 835 MHz; Type: D835V2; Serial: D835V2 - SN: 4d121

Communication System: UID 0 - CW; Frequency: 835 MHz

Medium parameters used: $f = 835$ MHz; $\sigma = 0.94$ S/m; $\epsilon_r = 42$; $\rho = 1000$ kg/m³

Phantom section: Flat Section

Measurement Standard: DASY5 (IEEE/IEC/ANSI C63.19-2011)

DASY52 Configuration:

- Probe: ES3DV3 - SN3205; ConvF(6.22, 6.22, 6.22); Calibrated: 30.12.2013;
- Sensor-Surface: 3mm (Mechanical Surface Detection)
- Electronics: DAE4 Sn601; Calibrated: 18.08.2014
- Phantom: Flat Phantom 4.9L; Type: QD000P49AA; Serial: 1001
- DASY52 52.8.8(1222); SEMCAD X 14.6.10(7331)

Dipole Calibration for Head Tissue/Pin=250 mW, d=15mm/Zoom Scan (7x7x7)/Cube 0:

Measurement grid: dx=5mm, dy=5mm, dz=5mm

Reference Value = 56.89 V/m; Power Drift = -0.02 dB

Peak SAR (extrapolated) = 3.61 W/kg

SAR(1 g) = 2.43 W/kg; SAR(10 g) = 1.59 W/kg

Maximum value of SAR (measured) = 2.85 W/kg

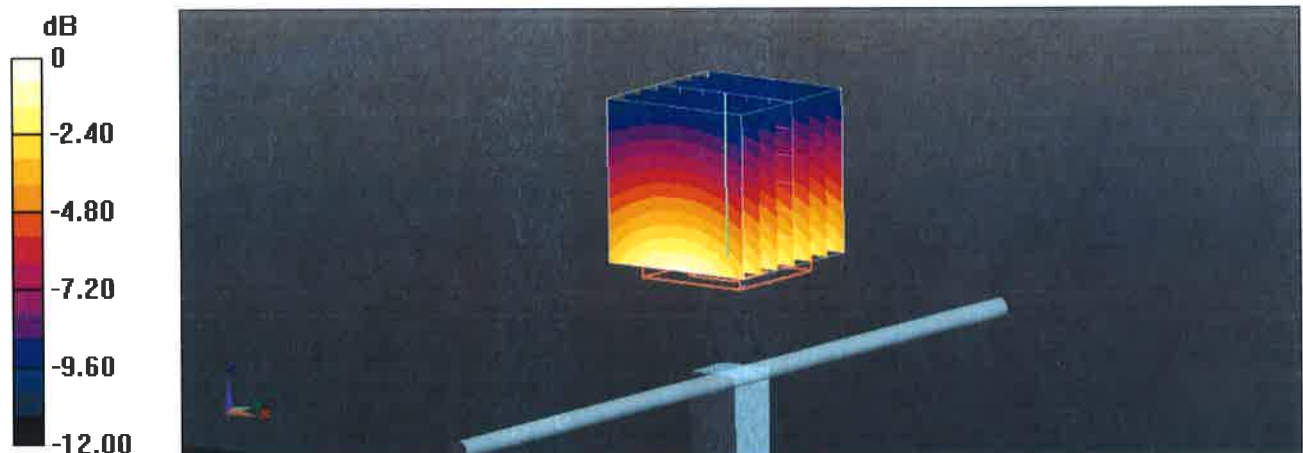

0 dB = 2.85 W/kg = 4.55 dBW/kg

Impedance Measurement Plot for Head TSL

27 Aug 2014 15:34:54

CH1 S11 1 U FS

1: 51.893 Ω -1.8105 Ω 105.27 pF

835.000 000 MHz

*
Del
CA
Avg
16
H1d

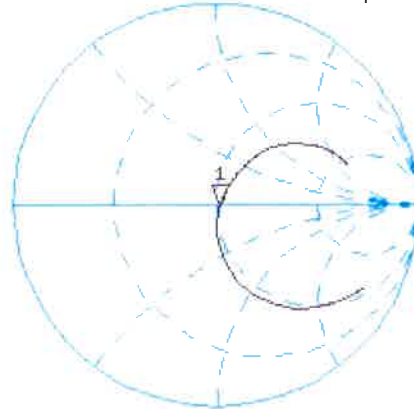

CH2 S11

LOG

5 dB/REF -20 dB

1: -31.796 dB

835.000 000 MHz

CA
Avg
16
H1d

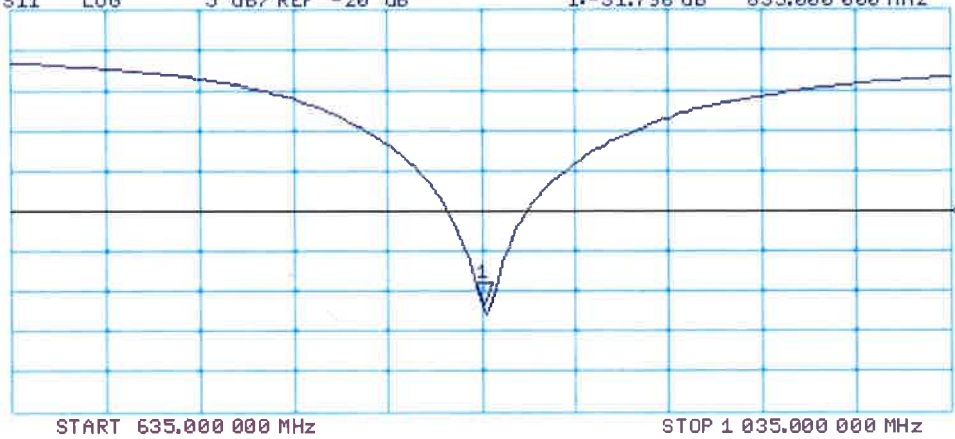

DASY5 Validation Report for Body TSL

Date: 27.08.2014

Test Laboratory: SPEAG, Zurich, Switzerland

DUT: Dipole 835 MHz; Type: D835V2; Serial: D835V2 - SN: 4d121

Communication System: UID 0 - CW; Frequency: 835 MHz

Medium parameters used: $f = 835$ MHz; $\sigma = 1.01$ S/m; $\epsilon_r = 55.2$; $\rho = 1000$ kg/m³

Phantom section: Flat Section

Measurement Standard: DASY5 (IEEE/IEC/ANSI C63.19-2011)

DASY52 Configuration:

- Probe: ES3DV3 - SN3205; ConvF(6.09, 6.09, 6.09); Calibrated: 30.12.2013;
- Sensor-Surface: 3mm (Mechanical Surface Detection)
- Electronics: DAE4 Sn601; Calibrated: 18.08.2014
- Phantom: Flat Phantom 4.9L; Type: QD000P49AA; Serial: 1001
- DASY52 52.8.8(1222); SEMCAD X 14.6.10(7331)

Dipole Calibration for Body Tissue/Pin=250 mW, d=15mm/Zoom Scan (7x7x7)/Cube 0:

Measurement grid: dx=5mm, dy=5mm, dz=5mm

Reference Value = 55.00 V/m; Power Drift = -0.01 dB

Peak SAR (extrapolated) = 3.60 W/kg

SAR(1 g) = 2.46 W/kg; SAR(10 g) = 1.62 W/kg

Maximum value of SAR (measured) = 2.86 W/kg

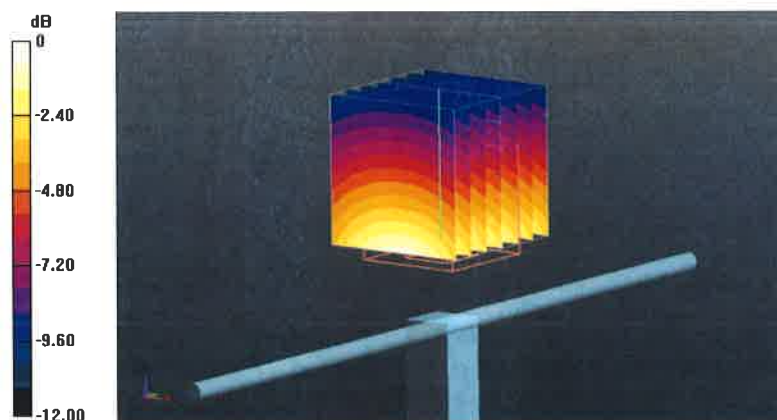

0 dB = 2.86 W/kg = 4.56 dBW/kg

Impedance Measurement Plot for Body TSL

26 Aug 2014 15:36:17

CH1 S11 1 U FS

2: 47.381 Ω -4.0215 Ω 47.397 pF

835.000 000 MHz

*
Del

CA

Avg
16

H1d

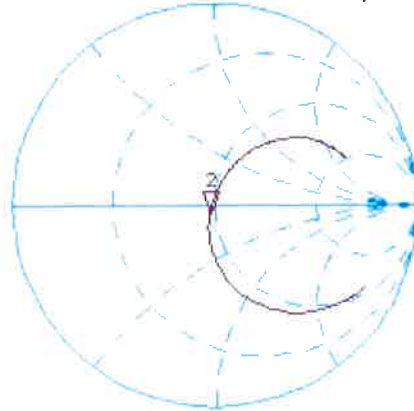

CH2 S11 LOG

5 dB/REF -20 dB

2: -26.158 dB

835.000 000 MHz

CA

Avg
16

H1d

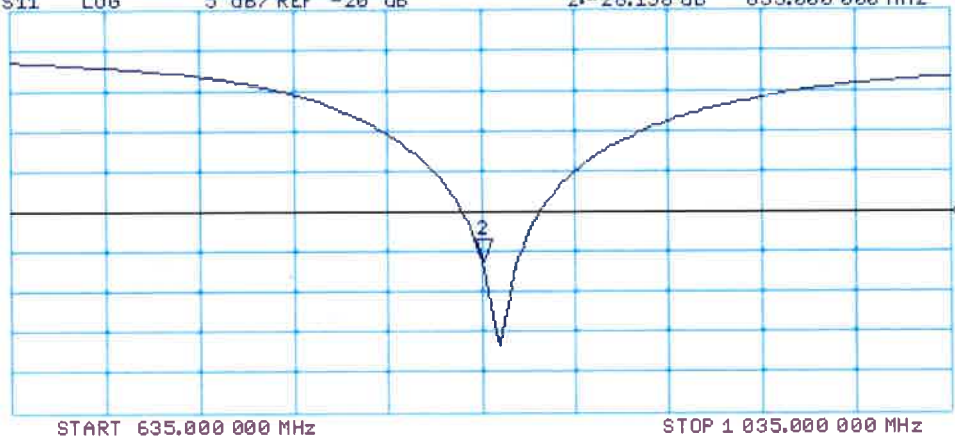



Accredited by the Swiss Accreditation Service (SAS)
The Swiss Accreditation Service is one of the signatories to the EA
Multilateral Agreement for the recognition of calibration certificates

Accreditation No.: **SCS 0108**

Client **B.V. ADT (Auden)**

Certificate No: **D1900V2-5d036_Jan15**

CALIBRATION CERTIFICATE

Object **D1900V2 - SN: 5d036**

Calibration procedure(s) **QA CAL-05.v9
Calibration procedure for dipole validation kits above 700 MHz**

Calibration date: **January 26, 2015**

This calibration certificate documents the traceability to national standards, which realize the physical units of measurements (SI).
The measurements and the uncertainties with confidence probability are given on the following pages and are part of the certificate.

All calibrations have been conducted in the closed laboratory facility: environment temperature $(22 \pm 3)^\circ\text{C}$ and humidity $< 70\%$.

Calibration Equipment used (M&TE critical for calibration)

Primary Standards	ID #	Cal Date (Certificate No.)	Scheduled Calibration
Power meter EPM-442A	GB37480704	07-Oct-14 (No. 217-02020)	Oct-15
Power sensor HP 8481A	US37292783	07-Oct-14 (No. 217-02020)	Oct-15
Power sensor HP 8481A	MY41092317	07-Oct-14 (No. 217-02021)	Oct-15
Reference 20 dB Attenuator	SN: 5058 (20k)	03-Apr-14 (No. 217-01918)	Apr-15
Type-N mismatch combination	SN: 5047.2 / 06327	03-Apr-14 (No. 217-01921)	Apr-15
Reference Probe ES3DV3	SN: 3205	30-Dec-14 (No. ES3-3205_Dec14)	Dec-15
DAE4	SN: 601	18-Aug-14 (No. DAE4-601_Aug14)	Aug-15
Secondary Standards	ID #	Check Date (in house)	Scheduled Check
RF generator R&S SMT-06	100005	04-Aug-99 (in house check Oct-13)	In house check: Oct-16
Network Analyzer HP 8753E	US37390585 S4206	18-Oct-01 (in house check Oct-14)	In house check: Oct-15

Calibrated by:	Name Leif Klysner	Function Laboratory Technician	Signature
Approved by:	Name Katja Pokovic	Function Technical Manager	Signature

Issued: January 27, 2015

This calibration certificate shall not be reproduced except in full without written approval of the laboratory.



Accredited by the Swiss Accreditation Service (SAS)

Accreditation No.: **SCS 0108**

The Swiss Accreditation Service is one of the signatories to the EA
Multilateral Agreement for the recognition of calibration certificates

Glossary:

TSL	tissue simulating liquid
ConvF	sensitivity in TSL / NORM x,y,z
N/A	not applicable or not measured

Calibration is Performed According to the Following Standards:

- IEEE Std 1528-2013, "IEEE Recommended Practice for Determining the Peak Spatial-Averaged Specific Absorption Rate (SAR) in the Human Head from Wireless Communications Devices: Measurement Techniques", June 2013
- IEC 62209-1, "Procedure to measure the Specific Absorption Rate (SAR) for hand-held devices used in close proximity to the ear (frequency range of 300 MHz to 3 GHz)", February 2005
- KDB 865664, "SAR Measurement Requirements for 100 MHz to 6 GHz"

Additional Documentation:

- DASY4/5 System Handbook

Methods Applied and Interpretation of Parameters:

- Measurement Conditions:** Further details are available from the Validation Report at the end of the certificate. All figures stated in the certificate are valid at the frequency indicated.
- Antenna Parameters with TSL:** The dipole is mounted with the spacer to position its feed point exactly below the center marking of the flat phantom section, with the arms oriented parallel to the body axis.
- Feed Point Impedance and Return Loss:** These parameters are measured with the dipole positioned under the liquid filled phantom. The impedance stated is transformed from the measurement at the SMA connector to the feed point. The Return Loss ensures low reflected power. No uncertainty required.
- Electrical Delay:** One-way delay between the SMA connector and the antenna feed point. No uncertainty required.
- SAR measured:** SAR measured at the stated antenna input power.
- SAR normalized:** SAR as measured, normalized to an input power of 1 W at the antenna connector.
- SAR for nominal TSL parameters:** The measured TSL parameters are used to calculate the nominal SAR result.

The reported uncertainty of measurement is stated as the standard uncertainty of measurement multiplied by the coverage factor $k=2$, which for a normal distribution corresponds to a coverage probability of approximately 95%.

Measurement Conditions

DASY system configuration, as far as not given on page 1.

DASY Version	DASY5	V52.8.8
Extrapolation	Advanced Extrapolation	
Phantom	Modular Flat Phantom	
Distance Dipole Center - TSL	10 mm	with Spacer
Zoom Scan Resolution	dx, dy, dz = 5 mm	
Frequency	1900 MHz ± 1 MHz	

Head TSL parameters

The following parameters and calculations were applied.

	Temperature	Permittivity	Conductivity
Nominal Head TSL parameters	22.0 °C	40.0	1.40 mho/m
Measured Head TSL parameters	(22.0 ± 0.2) °C	39.4 ± 6 %	1.40 mho/m ± 6 %
Head TSL temperature change during test	< 0.5 °C	----	----

SAR result with Head TSL

SAR averaged over 1 cm³ (1 g) of Head TSL	Condition	
SAR measured	250 mW input power	10.2 W/kg
SAR for nominal Head TSL parameters	normalized to 1W	40.7 W/kg ± 17.0 % (k=2)

SAR averaged over 10 cm³ (10 g) of Head TSL	condition	
SAR measured	250 mW input power	5.34 W/kg
SAR for nominal Head TSL parameters	normalized to 1W	21.3 W/kg ± 16.5 % (k=2)

Body TSL parameters

The following parameters and calculations were applied.

	Temperature	Permittivity	Conductivity
Nominal Body TSL parameters	22.0 °C	53.3	1.52 mho/m
Measured Body TSL parameters	(22.0 ± 0.2) °C	53.0 ± 6 %	1.51 mho/m ± 6 %
Body TSL temperature change during test	< 0.5 °C	----	----

SAR result with Body TSL

SAR averaged over 1 cm³ (1 g) of Body TSL	Condition	
SAR measured	250 mW input power	10.1 W/kg
SAR for nominal Body TSL parameters	normalized to 1W	40.5 W/kg ± 17.0 % (k=2)

SAR averaged over 10 cm³ (10 g) of Body TSL	condition	
SAR measured	250 mW input power	5.34 W/kg
SAR for nominal Body TSL parameters	normalized to 1W	21.4 W/kg ± 16.5 % (k=2)

Appendix (Additional assessments outside the scope of SCS0108)

Antenna Parameters with Head TSL

Impedance, transformed to feed point	51.5 Ω + 5.7 j Ω
Return Loss	- 24.7 dB

Antenna Parameters with Body TSL

Impedance, transformed to feed point	47.0 Ω + 6.2 j Ω
Return Loss	- 23.0 dB

General Antenna Parameters and Design

Electrical Delay (one direction)	1.196 ns
----------------------------------	----------

After long term use with 100W radiated power, only a slight warming of the dipole near the feedpoint can be measured.

The dipole is made of standard semirigid coaxial cable. The center conductor of the feeding line is directly connected to the second arm of the dipole. The antenna is therefore short-circuited for DC-signals. On some of the dipoles, small end caps are added to the dipole arms in order to improve matching when loaded according to the position as explained in the "Measurement Conditions" paragraph. The SAR data are not affected by this change. The overall dipole length is still according to the Standard.

No excessive force must be applied to the dipole arms, because they might bend or the soldered connections near the feedpoint may be damaged.

Additional EUT Data

Manufactured by	SPEAG
Manufactured on	May 08, 2003

DASY5 Validation Report for Head TSL

Date: 26.01.2015

Test Laboratory: SPEAG, Zurich, Switzerland

DUT: Dipole 1900 MHz; Type: D1900V2; Serial: D1900V2 - SN: 5d036

Communication System: UID 0 - CW; Frequency: 1900 MHz

Medium parameters used: $f = 1900$ MHz; $\sigma = 1.4$ S/m; $\epsilon_r = 39.4$; $\rho = 1000$ kg/m³

Phantom section: Flat Section

Measurement Standard: DASY5 (IEEE/IEC/ANSI C63.19-2011)

DASY52 Configuration:

- Probe: ES3DV3 - SN3205; ConvF(5, 5, 5); Calibrated: 30.12.2014;
- Sensor-Surface: 3mm (Mechanical Surface Detection)
- Electronics: DAE4 Sn601; Calibrated: 18.08.2014
- Phantom: Flat Phantom 5.0 (front); Type: QD000P50AA; Serial: 1001
- DASY52 52.8.8(1222); SEMCAD X 14.6.10(7331)

Dipole Calibration for Head Tissue/Pin=250 mW, d=10mm/Zoom Scan (7x7x7)/Cube 0:

Measurement grid: dx=5mm, dy=5mm, dz=5mm

Reference Value = 99.05 V/m; Power Drift = 0.01 dB

Peak SAR (extrapolated) = 18.8 W/kg

SAR(1 g) = 10.2 W/kg; SAR(10 g) = 5.34 W/kg

Maximum value of SAR (measured) = 13.0 W/kg

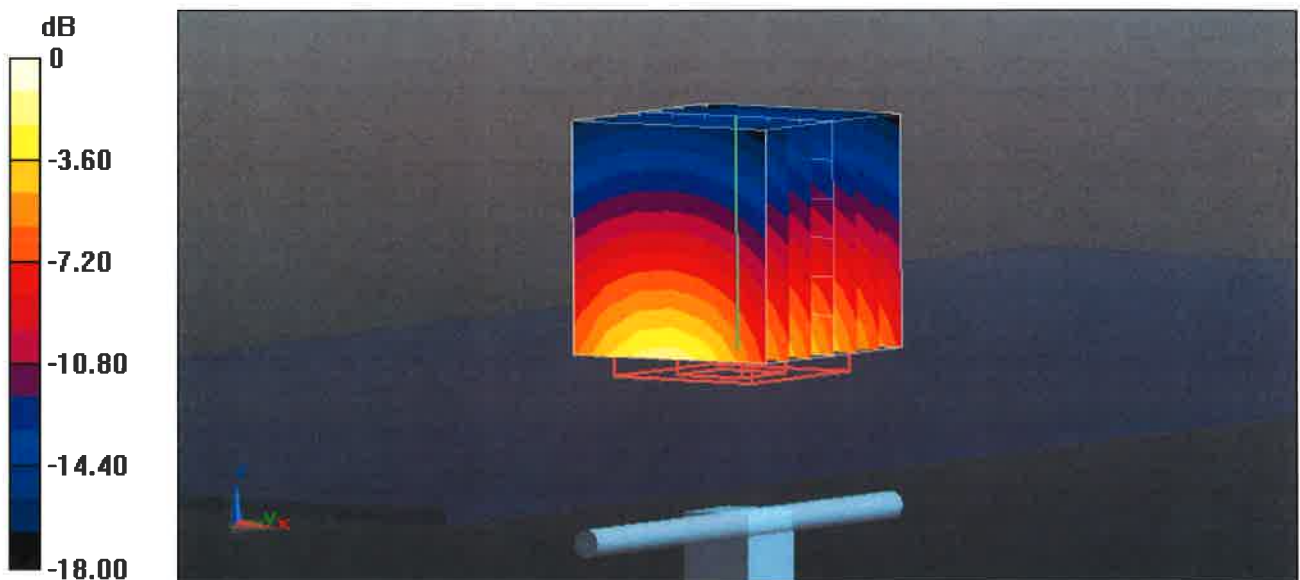

0 dB = 13.0 W/kg = 11.14 dBW/kg

Impedance Measurement Plot for Head TSL

26 Jan 2015 11:50:16

CH1 S11 1 U FS 1: 51.531 Ω 5.7383 Ω 480.67 pF 1 900.000 000 MHz

*
De1
CA

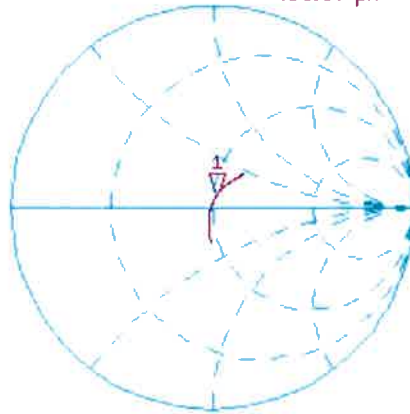

Avg
16

H1d

CH2 S11 LOG 5 dB/REF -20 dB 1: -24.666 dB 1 900.000 000 MHz

De1

CA

Avg
16

H1d



DASY5 Validation Report for Body TSL

Date: 26.01.2015

Test Laboratory: SPEAG, Zurich, Switzerland

DUT: Dipole 1900 MHz; Type: D1900V2; Serial: D1900V2 - SN: 5d036

Communication System: UID 0 - CW; Frequency: 1900 MHz

Medium parameters used: $f = 1900$ MHz; $\sigma = 1.51$ S/m; $\epsilon_r = 53$; $\rho = 1000$ kg/m³

Phantom section: Flat Section

Measurement Standard: DASY5 (IEEE/IEC/ANSI C63.19-2011)

DASY52 Configuration:

- Probe: ES3DV3 - SN3205; ConvF(4.65, 4.65, 4.65); Calibrated: 30.12.2014;
- Sensor-Surface: 3mm (Mechanical Surface Detection)
- Electronics: DAE4 Sn601; Calibrated: 18.08.2014
- Phantom: Flat Phantom 5.0 (back); Type: QD000P50AA; Serial: 1002
- DASY52 52.8.8(1222); SEMCAD X 14.6.10(7331)

Dipole Calibration for Body Tissue/Pin=250 mW, d=10mm/Zoom Scan (7x7x7)/Cube 0:

Measurement grid: dx=5mm, dy=5mm, dz=5mm

Reference Value = 95.91 V/m; Power Drift = 0.06 dB

Peak SAR (extrapolated) = 17.2 W/kg

SAR(1 g) = 10.1 W/kg; SAR(10 g) = 5.34 W/kg

Maximum value of SAR (measured) = 12.7 W/kg



Impedance Measurement Plot for Body TSL

26 Jan 2015 11:49:36

CH1 S11 1 U FS 1: 47.010 Ω 6.2187 Ω 520.92 μH 1 900.000 000 MHz

*
De1

CA

Avg
16

H1d

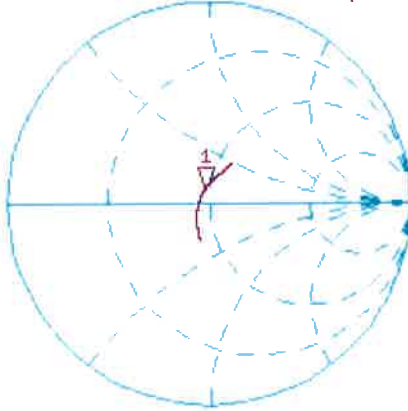

CH2 S11 LOG 5 dB/REF -20 dB 1:-22.978 dB 1 900.000 000 MHz

De1

CA

Avg
16

H1d

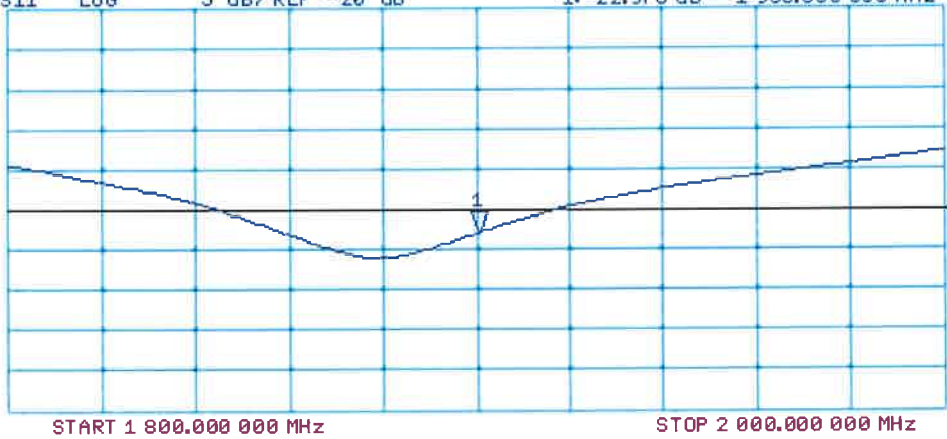



Accredited by the Swiss Accreditation Service (SAS)
The Swiss Accreditation Service is one of the signatories to the EA
Multilateral Agreement for the recognition of calibration certificates

Accreditation No.: **SCS 108**

Client **B.V. ADT (Auden)**

Certificate No: **D2450V2-737_Aug14**

CALIBRATION CERTIFICATE

Object **D2450V2 - SN: 737**

Calibration procedure(s) **QA CAL-05.v9
Calibration procedure for dipole validation kits above 700 MHz**

Calibration date: **August 21, 2014**

This calibration certificate documents the traceability to national standards, which realize the physical units of measurements (SI).
The measurements and the uncertainties with confidence probability are given on the following pages and are part of the certificate.

All calibrations have been conducted in the closed laboratory facility: environment temperature (22 ± 3)°C and humidity < 70%.

Calibration Equipment used (M&TE critical for calibration)

Primary Standards	ID #	Cal Date (Certificate No.)	Scheduled Calibration
Power meter EPM-442A	GB37480704	09-Oct-13 (No. 217-01827)	Oct-14
Power sensor HP 8481A	US37292783	09-Oct-13 (No. 217-01827)	Oct-14
Power sensor HP 8481A	MY41092317	09-Oct-13 (No. 217-01828)	Oct-14
Reference 20 dB Attenuator	SN: 5058 (20k)	03-Apr-14 (No. 217-01918)	Apr-15
Type-N mismatch combination	SN: 5047.2 / 06327	03-Apr-14 (No. 217-01921)	Apr-15
Reference Probe ES3DV3	SN: 3205	30-Dec-13 (No. ES3-3205_Dec13)	Dec-14
DAE4	SN: 601	18-Aug-14 (No. DAE4-601_Aug14)	Aug-15
Secondary Standards	ID #	Check Date (in house)	Scheduled Check
RF generator R&S SMT-06	100005	04-Aug-99 (in house check Oct-13)	In house check: Oct-16
Network Analyzer HP 8753E	US37390585 S4206	18-Oct-01 (in house check Oct-13)	In house check: Oct-14

Calibrated by: **Claudio Leubler** **Laboratory Technician**

Signature

Approved by: **Katja Pokovic** **Technical Manager**

Issued: August 21, 2014

This calibration certificate shall not be reproduced except in full without written approval of the laboratory.



Accredited by the Swiss Accreditation Service (SAS)

Accreditation No.: **SCS 108**

The Swiss Accreditation Service is one of the signatories to the EA Multilateral Agreement for the recognition of calibration certificates

Glossary:

TSL	tissue simulating liquid
ConvF	sensitivity in TSL / NORM x,y,z
N/A	not applicable or not measured

Calibration is Performed According to the Following Standards:

- IEEE Std 1528-2013, "IEEE Recommended Practice for Determining the Peak Spatial-Averaged Specific-Absorption Rate (SAR) in the Human Head from Wireless Communications Devices: Measurement Techniques", June 2013
- IEC 62209-1, "Procedure to measure the Specific Absorption Rate (SAR) for hand-held devices used in close proximity to the ear (frequency range of 300 MHz to 3 GHz)", February 2005
- KDB 865664, "SAR Measurement Requirements for 100 MHz to 6 GHz"

Additional Documentation:

- DASY4/5 System Handbook

Methods Applied and Interpretation of Parameters:

- Measurement Conditions:** Further details are available from the Validation Report at the end of the certificate. All figures stated in the certificate are valid at the frequency indicated.
- Antenna Parameters with TSL:** The dipole is mounted with the spacer to position its feed point exactly below the center marking of the flat phantom section, with the arms oriented parallel to the body axis.
- Feed Point Impedance and Return Loss:** These parameters are measured with the dipole positioned under the liquid filled phantom. The impedance stated is transformed from the measurement at the SMA connector to the feed point. The Return Loss ensures low reflected power. No uncertainty required.
- Electrical Delay:** One-way delay between the SMA connector and the antenna feed point. No uncertainty required.
- SAR measured:** SAR measured at the stated antenna input power.
- SAR normalized:** SAR as measured, normalized to an input power of 1 W at the antenna connector.
- SAR for nominal TSL parameters:** The measured TSL parameters are used to calculate the nominal SAR result.

The reported uncertainty of measurement is stated as the standard uncertainty of measurement multiplied by the coverage factor $k=2$, which for a normal distribution corresponds to a coverage probability of approximately 95%.

Measurement Conditions

DASY system configuration, as far as not given on page 1.

DASY Version	DASY5	V52.8.8
Extrapolation	Advanced Extrapolation	
Phantom	Modular Flat Phantom	
Distance Dipole Center - TSL	10 mm	with Spacer
Zoom Scan Resolution	dx, dy, dz = 5 mm	
Frequency	2450 MHz ± 1 MHz	

Head TSL parameters

The following parameters and calculations were applied.

	Temperature	Permittivity	Conductivity
Nominal Head TSL parameters	22.0 °C	39.2	1.80 mho/m
Measured Head TSL parameters	(22.0 ± 0.2) °C	38.0 ± 6 %	1.82 mho/m ± 6 %
Head TSL temperature change during test	< 0.5 °C	----	----

SAR result with Head TSL

SAR averaged over 1 cm³ (1 g) of Head TSL	Condition	
SAR measured	250 mW input power	12.9 W/kg
SAR for nominal Head TSL parameters	normalized to 1W	51.0 W/kg ± 17.0 % (k=2)

SAR averaged over 10 cm³ (10 g) of Head TSL	condition	
SAR measured	250 mW input power	5.97 W/kg
SAR for nominal Head TSL parameters	normalized to 1W	23.7 W/kg ± 16.5 % (k=2)

Body TSL parameters

The following parameters and calculations were applied.

	Temperature	Permittivity	Conductivity
Nominal Body TSL parameters	22.0 °C	52.7	1.95 mho/m
Measured Body TSL parameters	(22.0 ± 0.2) °C	50.5 ± 6 %	2.02 mho/m ± 6 %
Body TSL temperature change during test	< 0.5 °C	----	----

SAR result with Body TSL

SAR averaged over 1 cm³ (1 g) of Body TSL	Condition	
SAR measured	250 mW input power	12.7 W/kg
SAR for nominal Body TSL parameters	normalized to 1W	49.5 W/kg ± 17.0 % (k=2)

SAR averaged over 10 cm³ (10 g) of Body TSL	condition	
SAR measured	250 mW input power	5.84 W/kg
SAR for nominal Body TSL parameters	normalized to 1W	23.0 W/kg ± 16.5 % (k=2)

Appendix (Additional assessments outside the scope of SCS108)

Antenna Parameters with Head TSL

Impedance, transformed to feed point	54.9 Ω + 3.6 j Ω
Return Loss	- 24.7 dB

Antenna Parameters with Body TSL

Impedance, transformed to feed point	50.6 Ω + 4.8 j Ω
Return Loss	- 26.4 dB

General Antenna Parameters and Design

Electrical Delay (one direction)	1.162 ns
----------------------------------	----------

After long term use with 100W radiated power, only a slight warming of the dipole near the feedpoint can be measured.

The dipole is made of standard semirigid coaxial cable. The center conductor of the feeding line is directly connected to the second arm of the dipole. The antenna is therefore short-circuited for DC-signals. On some of the dipoles, small end caps are added to the dipole arms in order to improve matching when loaded according to the position as explained in the "Measurement Conditions" paragraph. The SAR data are not affected by this change. The overall dipole length is still according to the Standard.

No excessive force must be applied to the dipole arms, because they might bend or the soldered connections near the feedpoint may be damaged.

Additional EUT Data

Manufactured by	SPEAG
Manufactured on	August 26, 2003

DASY5 Validation Report for Head TSL

Date: 21.08.2014

Test Laboratory: SPEAG, Zurich, Switzerland

DUT: Dipole 2450 MHz; Type: D2450V2; Serial: D2450V2 - SN: 737

Communication System: UID 0 - CW; Frequency: 2450 MHz

Medium parameters used: $f = 2450$ MHz; $\sigma = 1.82$ S/m; $\epsilon_r = 38$; $\rho = 1000$ kg/m³

Phantom section: Flat Section

Measurement Standard: DASY5 (IEEE/IEC/ANSI C63.19-2011)

DASY52 Configuration:

- Probe: ES3DV3 - SN3205; ConvF(4.53, 4.53, 4.53); Calibrated: 30.12.2013;
- Sensor-Surface: 3mm (Mechanical Surface Detection)
- Electronics: DAE4 Sn601; Calibrated: 18.08.2014
- Phantom: Flat Phantom 5.0 (front); Type: QD000P50AA; Serial: 1001
- DASY52 52.8.8(1222); SEMCAD X 14.6.10(7331)

Dipole Calibration for Head Tissue/Pin=250 mW, d=10mm/Zoom Scan (7x7x7)/Cube 0:

Measurement grid: dx=5mm, dy=5mm, dz=5mm

Reference Value = 100.7 V/m; Power Drift = 0.02 dB

Peak SAR (extrapolated) = 26.7 W/kg

SAR(1 g) = 12.9 W/kg; SAR(10 g) = 5.97 W/kg

Maximum value of SAR (measured) = 17.1 W/kg

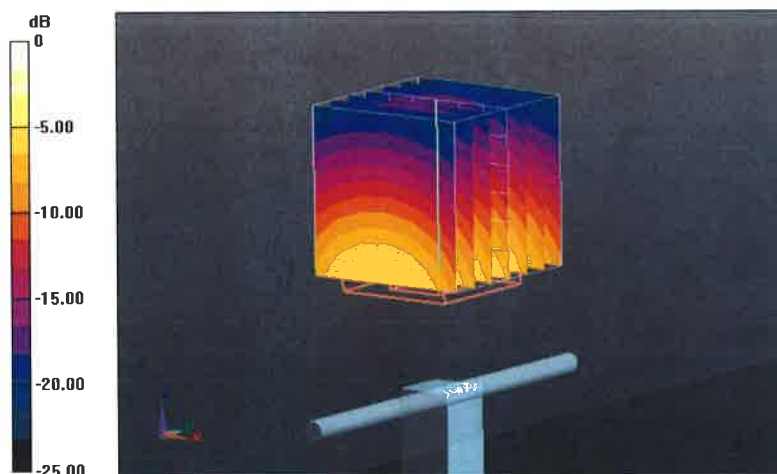

0 dB = 17.1 W/kg = 12.33 dBW/kg

Impedance Measurement Plot for Head TSL

21 Aug 2014 12:34:40
[CH1] S11 1 U FS 1: 54.932 Ω 3.6172 Ω 234.98 ρH 2 450.000 000 MHz

*
Del
CA

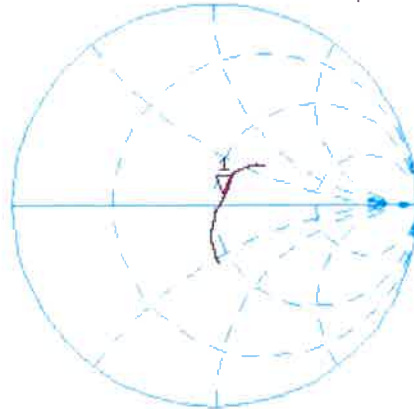

Avg
16

H1d

CH2 S11 LOG 5 dB/REF -20 dB 1: -24.695 dB 2 450.000 000 MHz

CA

Avg
16

H1d



DASY5 Validation Report for Body TSL

Date: 21.08.2014

Test Laboratory: SPEAG, Zurich, Switzerland

DUT: Dipole 2450 MHz; Type: D2450V2; Serial: D2450V2 - SN: 737

Communication System: UID 0 - CW; Frequency: 2450 MHz

Medium parameters used: $f = 2450$ MHz; $\sigma = 2.02$ S/m; $\epsilon_r = 50.5$; $\rho = 1000$ kg/m³

Phantom section: Flat Section

Measurement Standard: DASY5 (IEEE/IEC/ANSI C63.19-2011)

DASY52 Configuration:

- Probe: ES3DV3 - SN3205; ConvF(4.35, 4.35, 4.35); Calibrated: 30.12.2013;
- Sensor-Surface: 3mm (Mechanical Surface Detection)
- Electronics: DAE4 Sn601; Calibrated: 18.08.2014
- Phantom: Flat Phantom 5.0 (back); Type: QD000P50AA; Serial: 1002
- DASY52 52.8.8(1222); SEMCAD X 14.6.10(7331)

Dipole Calibration for Body Tissue/Pin=250 mW, d=10mm/Zoom Scan (7x7x7)/Cube 0:

Measurement grid: dx=5mm, dy=5mm, dz=5mm

Reference Value = 93.87 V/m; Power Drift = 0.03 dB

Peak SAR (extrapolated) = 26.6 W/kg

SAR(1 g) = 12.7 W/kg; SAR(10 g) = 5.84 W/kg

Maximum value of SAR (measured) = 16.8 W/kg

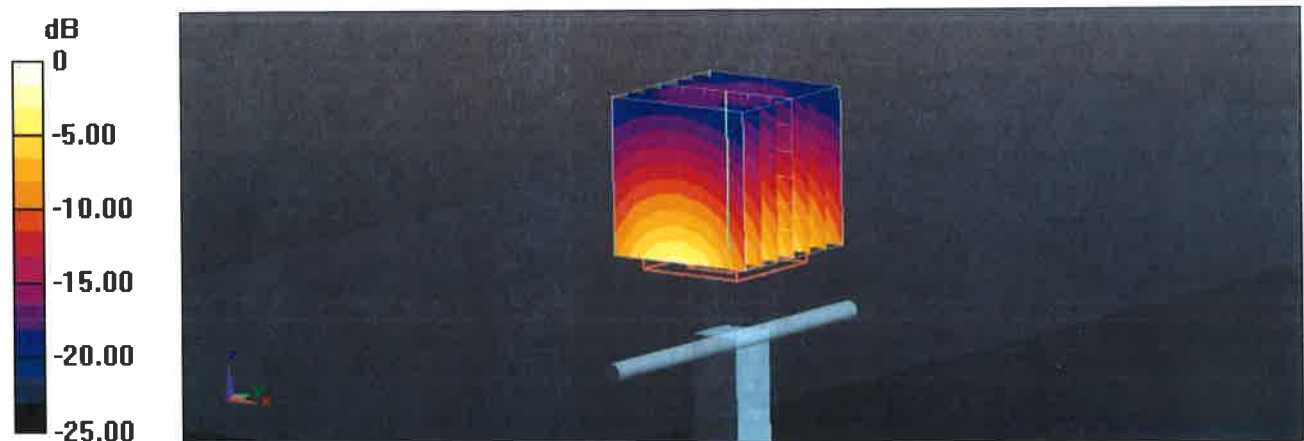

0 dB = 16.8 W/kg = 12.25 dBW/kg

Impedance Measurement Plot for Body TSL

21 Aug 2014 12:33:59

CH1 S11 1 U FS

1: 50.629 Ω 4.7793 Ω 310.47 μH

2 450.000 000 MHz

*
De1
CA

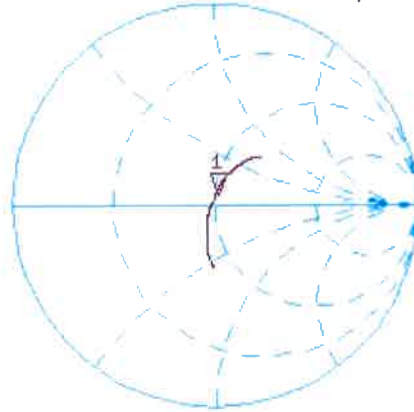

Avg
16

↑

CH2 S11 LOG 5 dB/REF -20 dB 1:-26.397 dB 2 450.000 000 MHz

CA

Avg
16

↑

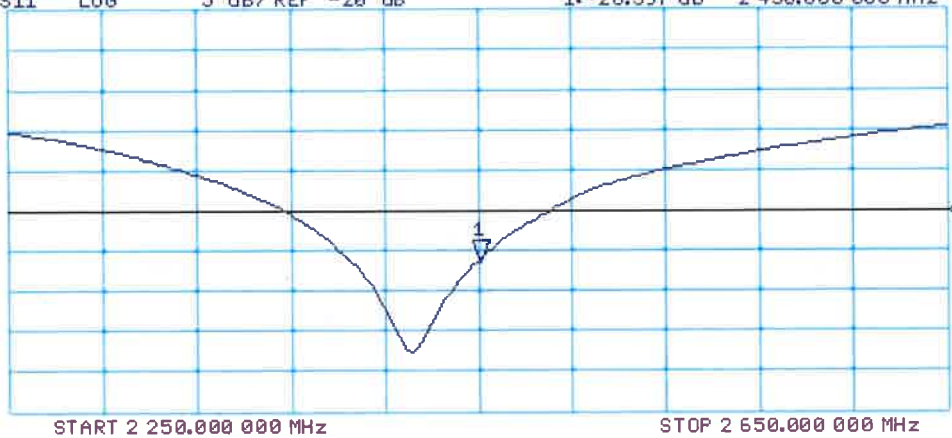



Accredited by the Swiss Accreditation Service (SAS)
The Swiss Accreditation Service is one of the signatories to the EA
Multilateral Agreement for the recognition of calibration certificates

Accreditation No.: **SCS 108**

Client **B.V. ADT (Auden)**

Certificate No: **D2600V2-1020_Aug14**

CALIBRATION CERTIFICATE

Object **D2600V2 - SN: 1020**

Calibration procedure(s) **QA CAL-05.v9
Calibration procedure for dipole validation kits above 700 MHz**

Calibration date: **August 21, 2014**

This calibration certificate documents the traceability to national standards, which realize the physical units of measurements (SI).
The measurements and the uncertainties with confidence probability are given on the following pages and are part of the certificate.

All calibrations have been conducted in the closed laboratory facility: environment temperature (22 ± 3)°C and humidity < 70%.

Calibration Equipment used (M&TE critical for calibration)

Primary Standards	ID #	Cal Date (Certificate No.)	Scheduled Calibration
Power meter EPM-442A	GB37480704	09-Oct-13 (No. 217-01827)	Oct-14
Power sensor HP 8481A	US37292783	09-Oct-13 (No. 217-01827)	Oct-14
Power sensor HP 8481A	MY41092317	09-Oct-13 (No. 217-01828)	Oct-14
Reference 20 dB Attenuator	SN: 5058 (20k)	03-Apr-14 (No. 217-01918)	Apr-15
Type-N mismatch combination	SN: 5047.2 / 06327	03-Apr-14 (No. 217-01921)	Apr-15
Reference Probe ES3DV3	SN: 3205	30-Dec-13 (No. ES3-3205_Dec13)	Dec-14
DAE4	SN: 601	18-Aug-14 (No. DAE4-601_Aug14)	Aug-15
Secondary Standards	ID #	Check Date (in house)	Scheduled Check
RF generator R&S SMT-06	100005	04-Aug-99 (in house check Oct-13)	In house check: Oct-16
Network Analyzer HP 8753E	US37390585 S4206	18-Oct-01 (in house check Oct-13)	In house check: Oct-14

Calibrated by: **Claudio Leubler** **Laboratory Technician**

Approved by: **Katja Pokovic** **Technical Manager**

Signature

Issued: August 21, 2014

This calibration certificate shall not be reproduced except in full without written approval of the laboratory.



Accredited by the Swiss Accreditation Service (SAS)

The Swiss Accreditation Service is one of the signatories to the EA
Multilateral Agreement for the recognition of calibration certificates

Accreditation No.: **SCS 108**

Glossary:

TSL	tissue simulating liquid
ConvF	sensitivity in TSL / NORM x,y,z
N/A	not applicable or not measured

Calibration is Performed According to the Following Standards:

- IEEE Std 1528-2013, "IEEE Recommended Practice for Determining the Peak Spatial-Averaged Specific-Absorption Rate (SAR) in the Human Head from Wireless Communications Devices: Measurement Techniques", June 2013
- IEC 62209-1, "Procedure to measure the Specific Absorption Rate (SAR) for hand-held devices used in close proximity to the ear (frequency range of 300 MHz to 3 GHz)", February 2005
- KDB 865664, "SAR Measurement Requirements for 100 MHz to 6 GHz"

Additional Documentation:

- DASY4/5 System Handbook

Methods Applied and Interpretation of Parameters:

- Measurement Conditions:** Further details are available from the Validation Report at the end of the certificate. All figures stated in the certificate are valid at the frequency indicated.
- Antenna Parameters with TSL:** The dipole is mounted with the spacer to position its feed point exactly below the center marking of the flat phantom section, with the arms oriented parallel to the body axis.
- Feed Point Impedance and Return Loss:** These parameters are measured with the dipole positioned under the liquid filled phantom. The impedance stated is transformed from the measurement at the SMA connector to the feed point. The Return Loss ensures low reflected power. No uncertainty required.
- Electrical Delay:** One-way delay between the SMA connector and the antenna feed point. No uncertainty required.
- SAR measured:** SAR measured at the stated antenna input power.
- SAR normalized:** SAR as measured, normalized to an input power of 1 W at the antenna connector.
- SAR for nominal TSL parameters:** The measured TSL parameters are used to calculate the nominal SAR result.

The reported uncertainty of measurement is stated as the standard uncertainty of measurement multiplied by the coverage factor $k=2$, which for a normal distribution corresponds to a coverage probability of approximately 95%.

Measurement Conditions

DASY system configuration, as far as not given on page 1.

DASY Version	DASY5	V52.8.8
Extrapolation	Advanced Extrapolation	
Phantom	Modular Flat Phantom	
Distance Dipole Center - TSL	10 mm	with Spacer
Zoom Scan Resolution	dx, dy, dz = 5 mm	
Frequency	2600 MHz ± 1 MHz	

Head TSL parameters

The following parameters and calculations were applied.

	Temperature	Permittivity	Conductivity
Nominal Head TSL parameters	22.0 °C	39.0	1.96 mho/m
Measured Head TSL parameters	(22.0 ± 0.2) °C	37.5 ± 6 %	1.99 mho/m ± 6 %
Head TSL temperature change during test	< 0.5 °C	----	----

SAR result with Head TSL

SAR averaged over 1 cm³ (1 g) of Head TSL	Condition	
SAR measured	250 mW input power	14.6 W/kg
SAR for nominal Head TSL parameters	normalized to 1W	57.5 W/kg ± 17.0 % (k=2)

SAR averaged over 10 cm³ (10 g) of Head TSL	condition	
SAR measured	250 mW input power	6.53 W/kg
SAR for nominal Head TSL parameters	normalized to 1W	25.9 W/kg ± 16.5 % (k=2)

Body TSL parameters

The following parameters and calculations were applied.

	Temperature	Permittivity	Conductivity
Nominal Body TSL parameters	22.0 °C	52.5	2.16 mho/m
Measured Body TSL parameters	(22.0 ± 0.2) °C	50.0 ± 6 %	2.20 mho/m ± 6 %
Body TSL temperature change during test	< 0.5 °C	----	----

SAR result with Body TSL

SAR averaged over 1 cm³ (1 g) of Body TSL	Condition	
SAR measured	250 mW input power	14.4 W/kg
SAR for nominal Body TSL parameters	normalized to 1W	56.5 W/kg ± 17.0 % (k=2)

SAR averaged over 10 cm³ (10 g) of Body TSL	condition	
SAR measured	250 mW input power	6.38 W/kg
SAR for nominal Body TSL parameters	normalized to 1W	25.2 W/kg ± 16.5 % (k=2)

Appendix (Additional assessments outside the scope of SCS108)

Antenna Parameters with Head TSL

Impedance, transformed to feed point	48.7 Ω - 3.6 j Ω
Return Loss	- 28.2 dB

Antenna Parameters with Body TSL

Impedance, transformed to feed point	45.3 Ω - 3.4 j Ω
Return Loss	- 24.4 dB

General Antenna Parameters and Design

Electrical Delay (one direction)	1.153 ns
----------------------------------	----------

After long term use with 100W radiated power, only a slight warming of the dipole near the feedpoint can be measured.

The dipole is made of standard semirigid coaxial cable. The center conductor of the feeding line is directly connected to the second arm of the dipole. The antenna is therefore short-circuited for DC-signals. On some of the dipoles, small end caps are added to the dipole arms in order to improve matching when loaded according to the position as explained in the "Measurement Conditions" paragraph. The SAR data are not affected by this change. The overall dipole length is still according to the Standard.

No excessive force must be applied to the dipole arms, because they might bend or the soldered connections near the feedpoint may be damaged.

Additional EUT Data

Manufactured by	SPEAG
Manufactured on	May 13, 2008

DASY5 Validation Report for Head TSL

Date: 21.08.2014

Test Laboratory: SPEAG, Zurich, Switzerland

DUT: Dipole 2600 MHz; Type: D2600V2; Serial: D2600V2 - SN: 1020

Communication System: UID 0 - CW; Frequency: 2600 MHz

Medium parameters used: $f = 2600$ MHz; $\sigma = 1.99$ S/m; $\epsilon_r = 37.5$; $\rho = 1000$ kg/m³

Phantom section: Flat Section

Measurement Standard: DASY5 (IEEE/IEC/ANSI C63.19-2011)

DASY52 Configuration:

- Probe: ES3DV3 - SN3205; ConvF(4.46, 4.46, 4.46); Calibrated: 30.12.2013;
- Sensor-Surface: 3mm (Mechanical Surface Detection)
- Electronics: DAE4 Sn601; Calibrated: 18.08.2014
- Phantom: Flat Phantom 5.0 (front); Type: QD000P50AA; Serial: 1001
- DASY52 52.8.8(1222); SEMCAD X 14.6.10(7331)

Dipole Calibration for Head Tissue/Pin=250 mW, d=10mm/Zoom Scan (7x7x7)/Cube 0:

Measurement grid: dx=5mm, dy=5mm, dz=5mm

Reference Value = 103.5 V/m; Power Drift = 0.01 dB

Peak SAR (extrapolated) = 31.0 W/kg

SAR(1 g) = 14.6 W/kg; SAR(10 g) = 6.53 W/kg

Maximum value of SAR (measured) = 19.4 W/kg

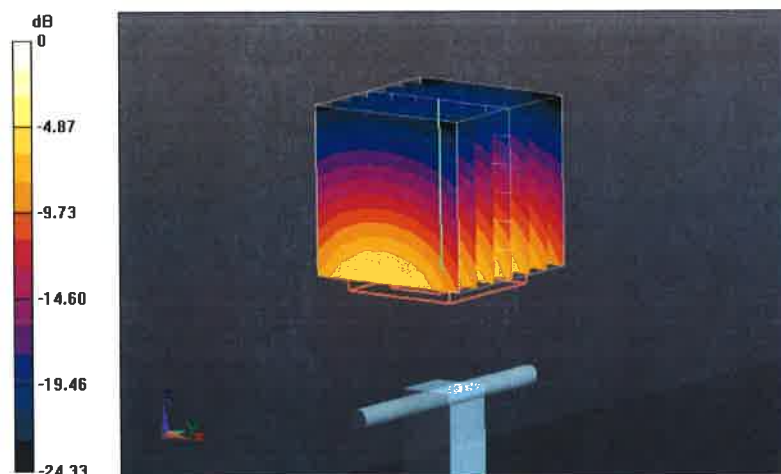

0 dB = 19.4 W/kg = 12.88 dBW/kg

Impedance Measurement Plot for Head TSL

21 Aug 2014 12:52:30

CH1 S11 1 U FS

1: 48.736 Ω -3.6309 Ω 16.859 pF

2 600.000 000 MHz

*
De1
CA

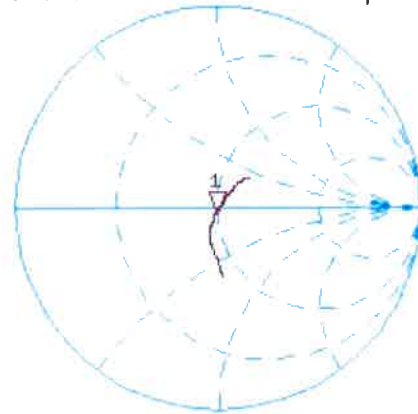

Av9
12

H1d

CH2 S11 LOG 5 dB/REF -20 dB 1:-28.200 dB 2 600.000 000 MHz

CA

Av9
12

H1d



DASY5 Validation Report for Body TSL

Date: 21.08.2014

Test Laboratory: SPEAG, Zurich, Switzerland

DUT: Dipole 2600 MHz; Type: D2600V2; Serial: D2600V2 - SN: 1020

Communication System: UID 0 - CW; Frequency: 2600 MHz

Medium parameters used: $f = 2600$ MHz; $\sigma = 2.2$ S/m; $\epsilon_r = 50$; $\rho = 1000$ kg/m³

Phantom section: Flat Section

Measurement Standard: DASY5 (IEEE/IEC/ANSI C63.19-2011)

DASY52 Configuration:

- Probe: ES3DV3 - SN3205; ConvF(4.24, 4.24, 4.24); Calibrated: 30.12.2013;
- Sensor-Surface: 3mm (Mechanical Surface Detection)
- Electronics: DAE4 Sn601; Calibrated: 18.08.2014
- Phantom: Flat Phantom 5.0 (back); Type: QD000P50AA; Serial: 1002
- DASY52 52.8.8(1222); SEMCAD X 14.6.10(7331)

Dipole Calibration for Body Tissue/ $P_{in}=250$ mW, $d=10$ mm/Zoom Scan (7x7x7)/Cube 0:

Measurement grid: $dx=5$ mm, $dy=5$ mm, $dz=5$ mm

Reference Value = 96.98 V/m; Power Drift = 0.03 dB

Peak SAR (extrapolated) = 31.2 W/kg

SAR(1 g) = 14.4 W/kg; SAR(10 g) = 6.38 W/kg

Maximum value of SAR (measured) = 19.1 W/kg



0 dB = 19.1 W/kg = 12.81 dBW/kg

Impedance Measurement Plot for Body TSL

21 Aug 2014 12:51:55

CH1 S11 1 U FS

1: 45.330 Ω -3.3906 Ω 18.054 pF

2 500.000 000 MHz

*
Del

CA

Avg
16

H1d

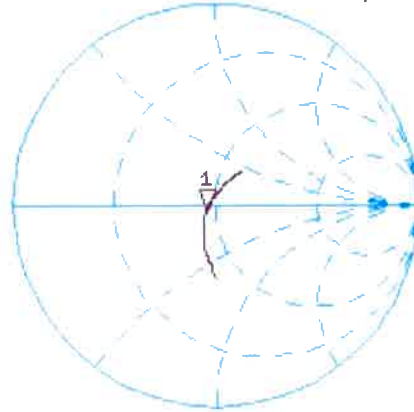

CH2 S11 LOG

5 dB/REF -20 dB

1: -24.368 dB 2 500.000 000 MHz

CA

Avg
16

H1d

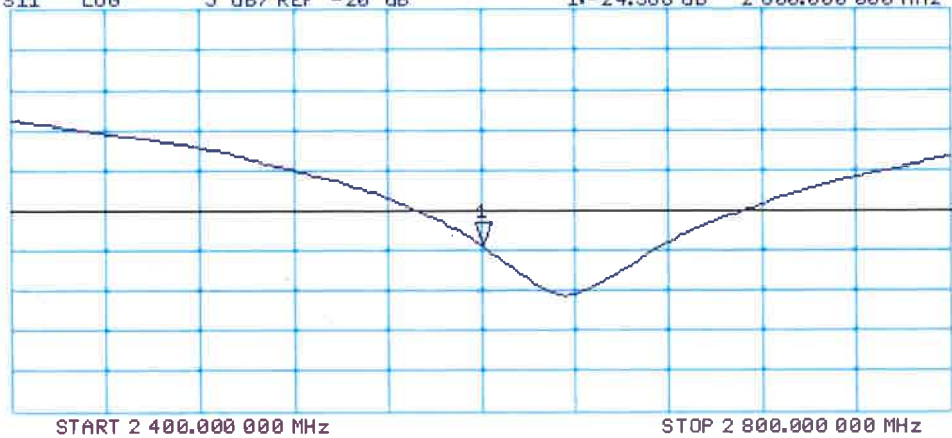



Accredited by the Swiss Accreditation Service (SAS)
The Swiss Accreditation Service is one of the signatories to the EA
Multilateral Agreement for the recognition of calibration certificates

Accreditation No.: **SCS 0108**

Client **B.V.ADT (Auden)**

Certificate No: **EX3-3590_Feb15**

CALIBRATION CERTIFICATE

Object **EX3DV4 - SN:3590**

Calibration procedure(s) **QA CAL-01.v9, QA CAL-14.v4, QA CAL-23.v5, QA CAL-25.v6
Calibration procedure for dosimetric E-field probes**

Calibration date: **February 26, 2015**

This calibration certificate documents the traceability to national standards, which realize the physical units of measurements (SI).
The measurements and the uncertainties with confidence probability are given on the following pages and are part of the certificate.

All calibrations have been conducted in the closed laboratory facility: environment temperature (22 ± 3)°C and humidity < 70%.

Calibration Equipment used (M&TE critical for calibration)

Primary Standards	ID	Cal Date (Certificate No.)	Scheduled Calibration
Power meter E4419B	GB41293874	03-Apr-14 (No. 217-01911)	Apr-15
Power sensor E4412A	MY41498087	03-Apr-14 (No. 217-01911)	Apr-15
Reference 3 dB Attenuator	SN: S5054 (3c)	03-Apr-14 (No. 217-01915)	Apr-15
Reference 20 dB Attenuator	SN: S5277 (20x)	03-Apr-14 (No. 217-01919)	Apr-15
Reference 30 dB Attenuator	SN: S5129 (30b)	03-Apr-14 (No. 217-01920)	Apr-15
Reference Probe ES3DV2	SN: 3013	30-Dec-14 (No. ES3-3013_Dec14)	Dec-15
DAE4	SN: 660	14-Jan-15 (No. DAE4-660_Jan15)	Jan-16
Secondary Standards	ID	Check Date (in house)	Scheduled Check
RF generator HP 8648C	US3642U01700	4-Aug-99 (in house check Apr-13)	In house check: Apr-16
Network Analyzer HP 8753E	US37390585	18-Oct-01 (in house check Oct-14)	In house check: Oct-15

	Name	Function	Signature
Calibrated by:	Jeton Kastrati	Laboratory Technician	
Approved by:	Katja Pokovic	Technical Manager	
			Issued: February 27, 2015
This calibration certificate shall not be reproduced except in full without written approval of the laboratory.			



Accredited by the Swiss Accreditation Service (SAS)

Accreditation No.: **SCS 0108**

The Swiss Accreditation Service is one of the signatories to the EA Multilateral Agreement for the recognition of calibration certificates

Glossary:

TSL	tissue simulating liquid
NORM _{x,y,z}	sensitivity in free space
ConvF	sensitivity in TSL / NORM _{x,y,z}
DCP	diode compression point
CF	crest factor (1/duty_cycle) of the RF signal
A, B, C, D	modulation dependent linearization parameters
Polarization φ	φ rotation around probe axis
Polarization ϑ	ϑ rotation around an axis that is in the plane normal to probe axis (at measurement center), i.e., $\vartheta = 0$ is normal to probe axis
Connector Angle	information used in DASY system to align probe sensor X to the robot coordinate system

Calibration is Performed According to the Following Standards:

- IEEE Std 1528-2013, "IEEE Recommended Practice for Determining the Peak Spatial-Averaged Specific Absorption Rate (SAR) in the Human Head from Wireless Communications Devices: Measurement Techniques", June 2013
- IEC 62209-1, "Procedure to measure the Specific Absorption Rate (SAR) for hand-held devices used in close proximity to the ear (frequency range of 300 MHz to 3 GHz)", February 2005

Methods Applied and Interpretation of Parameters:

- NORM_{x,y,z}**: Assessed for E-field polarization $\vartheta = 0$ ($f \leq 900$ MHz in TEM-cell; $f > 1800$ MHz: R22 waveguide). NORM_{x,y,z} are only intermediate values, i.e., the uncertainties of NORM_{x,y,z} does not affect the E²-field uncertainty inside TSL (see below ConvF).
- NORM(f)_{x,y,z}** = NORM_{x,y,z} * frequency_response (see Frequency Response Chart). This linearization is implemented in DASY4 software versions later than 4.2. The uncertainty of the frequency response is included in the stated uncertainty of ConvF.
- DCP_{x,y,z}**: DCP are numerical linearization parameters assessed based on the data of power sweep with CW signal (no uncertainty required). DCP does not depend on frequency nor media.
- PAR**: PAR is the Peak to Average Ratio that is not calibrated but determined based on the signal characteristics
- A_{x,y,z}; B_{x,y,z}; C_{x,y,z}; D_{x,y,z}; VR_{x,y,z}; A, B, C, D** are numerical linearization parameters assessed based on the data of power sweep for specific modulation signal. The parameters do not depend on frequency nor media. VR is the maximum calibration range expressed in RMS voltage across the diode.
- ConvF and Boundary Effect Parameters**: Assessed in flat phantom using E-field (or Temperature Transfer Standard for $f \leq 800$ MHz) and inside waveguide using analytical field distributions based on power measurements for $f > 800$ MHz. The same setups are used for assessment of the parameters applied for boundary compensation (alpha, depth) of which typical uncertainty values are given. These parameters are used in DASY4 software to improve probe accuracy close to the boundary. The sensitivity in TSL corresponds to NORM_{x,y,z} * ConvF whereby the uncertainty corresponds to that given for ConvF. A frequency dependent ConvF is used in DASY version 4.4 and higher which allows extending the validity from ± 50 MHz to ± 100 MHz.
- Spherical isotropy (3D deviation from isotropy)**: in a field of low gradients realized using a flat phantom exposed by a patch antenna.
- Sensor Offset**: The sensor offset corresponds to the offset of virtual measurement center from the probe tip (on probe axis). No tolerance required.
- Connector Angle**: The angle is assessed using the information gained by determining the NORM_x (no uncertainty required).

Probe EX3DV4

SN:3590

Manufactured: March 23, 2009
Calibrated: February 26, 2015

Calibrated for DASY/EASY Systems
(Note: non-compatible with DASY2 system!)

DASY/EASY - Parameters of Probe: EX3DV4 - SN:3590

Basic Calibration Parameters

	Sensor X	Sensor Y	Sensor Z	Unc (k=2)
Norm ($\mu\text{V}/(\text{V}/\text{m})^2$) ^A	0.50	0.47	0.51	$\pm 10.1 \%$
DCP (mV) ^B	96.7	96.6	95.3	

Modulation Calibration Parameters

UID	Communication System Name		A dB	B dB $\sqrt{\mu\text{V}}$	C	D dB	VR mV	Unc ^E (k=2)
0	CW	X	0.0	0.0	1.0	0.00	138.1	$\pm 2.2 \%$
		Y	0.0	0.0	1.0		141.5	
		Z	0.0	0.0	1.0		131.8	

The reported uncertainty of measurement is stated as the standard uncertainty of measurement multiplied by the coverage factor $k=2$, which for a normal distribution corresponds to a coverage probability of approximately 95%.

^A The uncertainties of NormX,Y,Z do not affect the E^2 -field uncertainty inside TSL (see Pages 5 and 6).

^B Numerical linearization parameter: uncertainty not required.

^E Uncertainty is determined using the max. deviation from linear response applying rectangular distribution and is expressed for the square of the field value.

DASY/EASY - Parameters of Probe: EX3DV4 - SN:3590

Calibration Parameter Determined in Head Tissue Simulating Media

f (MHz) ^C	Relative Permittivity ^F	Conductivity (S/m) ^F	ConvF X	ConvF Y	ConvF Z	Alpha ^G	Depth ^G (mm)	Unct. (k=2)
750	41.9	0.89	10.52	10.52	10.52	0.39	0.84	± 12.0 %
835	41.5	0.90	10.17	10.17	10.17	0.22	1.22	± 12.0 %
900	41.5	0.97	10.07	10.07	10.07	0.57	0.69	± 12.0 %
1450	40.5	1.20	9.06	9.06	9.06	0.32	0.88	± 12.0 %
1640	40.3	1.29	8.93	8.93	8.93	0.50	0.69	± 12.0 %
1750	40.1	1.37	8.83	8.83	8.83	0.48	0.70	± 12.0 %
1900	40.0	1.40	8.65	8.65	8.65	0.79	0.57	± 12.0 %
2000	40.0	1.40	8.57	8.57	8.57	0.52	0.66	± 12.0 %
2300	39.5	1.67	8.23	8.23	8.23	0.49	0.67	± 12.0 %
2450	39.2	1.80	7.89	7.89	7.89	0.27	0.99	± 12.0 %
2600	39.0	1.96	7.68	7.68	7.68	0.30	0.95	± 12.0 %
3500	37.9	2.91	7.85	7.85	7.85	0.40	0.99	± 13.1 %
5200	36.0	4.66	5.69	5.69	5.69	0.35	1.80	± 13.1 %
5300	35.9	4.76	5.47	5.47	5.47	0.35	1.80	± 13.1 %
5500	35.6	4.96	5.07	5.07	5.07	0.40	1.80	± 13.1 %
5600	35.5	5.07	4.72	4.72	4.72	0.40	1.80	± 13.1 %
5800	35.3	5.27	4.97	4.97	4.97	0.40	1.80	± 13.1 %

^C Frequency validity above 300 MHz of ± 100 MHz only applies for DASY v4.4 and higher (see Page 2), else it is restricted to ± 50 MHz. The uncertainty is the RSS of the ConvF uncertainty at calibration frequency and the uncertainty for the indicated frequency band. Frequency validity below 300 MHz is ± 10, 25, 40, 50 and 70 MHz for ConvF assessments at 30, 64, 128, 150 and 220 MHz respectively. Above 5 GHz frequency validity can be extended to ± 110 MHz.

^F At frequencies below 3 GHz, the validity of tissue parameters (ϵ and σ) can be relaxed to ± 10% if liquid compensation formula is applied to measured SAR values. At frequencies above 3 GHz, the validity of tissue parameters (ϵ and σ) is restricted to ± 5%. The uncertainty is the RSS of the ConvF uncertainty for indicated target tissue parameters.

^G Alpha/Depth are determined during calibration. SPEAG warrants that the remaining deviation due to the boundary effect after compensation is always less than ± 1% for frequencies below 3 GHz and below ± 2% for frequencies between 3-6 GHz at any distance larger than half the probe tip diameter from the boundary.

DASY/EASY - Parameters of Probe: EX3DV4 - SN:3590

Calibration Parameter Determined in Body Tissue Simulating Media

f (MHz) ^C	Relative Permittivity ^F	Conductivity (S/m) ^F	ConvF X	ConvF Y	ConvF Z	Alpha ^G	Depth ^G (mm)	Unct. (k=2)
750	55.5	0.96	10.34	10.34	10.34	0.39	0.88	± 12.0 %
835	55.2	0.97	10.30	10.30	10.30	0.49	0.79	± 12.0 %
900	55.0	1.05	10.03	10.03	10.03	0.21	1.30	± 12.0 %
1450	54.0	1.30	8.94	8.94	8.94	0.32	1.13	± 12.0 %
1640	53.8	1.40	9.32	9.32	9.32	0.55	0.77	± 12.0 %
1750	53.4	1.49	8.53	8.53	8.53	0.31	1.03	± 12.0 %
1900	53.3	1.52	8.08	8.08	8.08	0.28	0.93	± 12.0 %
2000	53.3	1.52	8.17	8.17	8.17	0.32	0.87	± 12.0 %
2300	52.9	1.81	7.93	7.93	7.93	0.38	0.82	± 12.0 %
2450	52.7	1.95	7.78	7.78	7.78	0.80	0.54	± 12.0 %
2600	52.5	2.16	7.44	7.44	7.44	0.80	0.50	± 12.0 %
3500	51.3	3.31	7.15	7.15	7.15	0.29	1.35	± 13.1 %
5200	49.0	5.30	5.00	5.00	5.00	0.45	1.90	± 13.1 %
5300	48.9	5.42	4.82	4.82	4.82	0.45	1.90	± 13.1 %
5500	48.6	5.65	4.44	4.44	4.44	0.50	1.90	± 13.1 %
5600	48.5	5.77	4.41	4.41	4.41	0.50	1.90	± 13.1 %
5800	48.2	6.00	4.63	4.63	4.63	0.50	1.90	± 13.1 %

^C Frequency validity above 300 MHz of ± 100 MHz only applies for DASY v4.4 and higher (see Page 2), else it is restricted to ± 50 MHz. The uncertainty is the RSS of the ConvF uncertainty at calibration frequency and the uncertainty for the indicated frequency band. Frequency validity below 300 MHz is ± 10, 25, 40, 50 and 70 MHz for ConvF assessments at 30, 64, 128, 150 and 220 MHz respectively. Above 5 GHz frequency validity can be extended to ± 110 MHz.

^F At frequencies below 3 GHz, the validity of tissue parameters (ϵ and σ) can be relaxed to ± 10% if liquid compensation formula is applied to measured SAR values. At frequencies above 3 GHz, the validity of tissue parameters (ϵ and σ) is restricted to ± 5%. The uncertainty is the RSS of the ConvF uncertainty for indicated target tissue parameters.

^G Alpha/Depth are determined during calibration. SPEAG warrants that the remaining deviation due to the boundary effect after compensation is always less than ± 1% for frequencies below 3 GHz and below ± 2% for frequencies between 3-6 GHz at any distance larger than half the probe tip diameter from the boundary.

Frequency Response of E-Field (TEM-Cell: ifi110 EXX, Waveguide: R22)

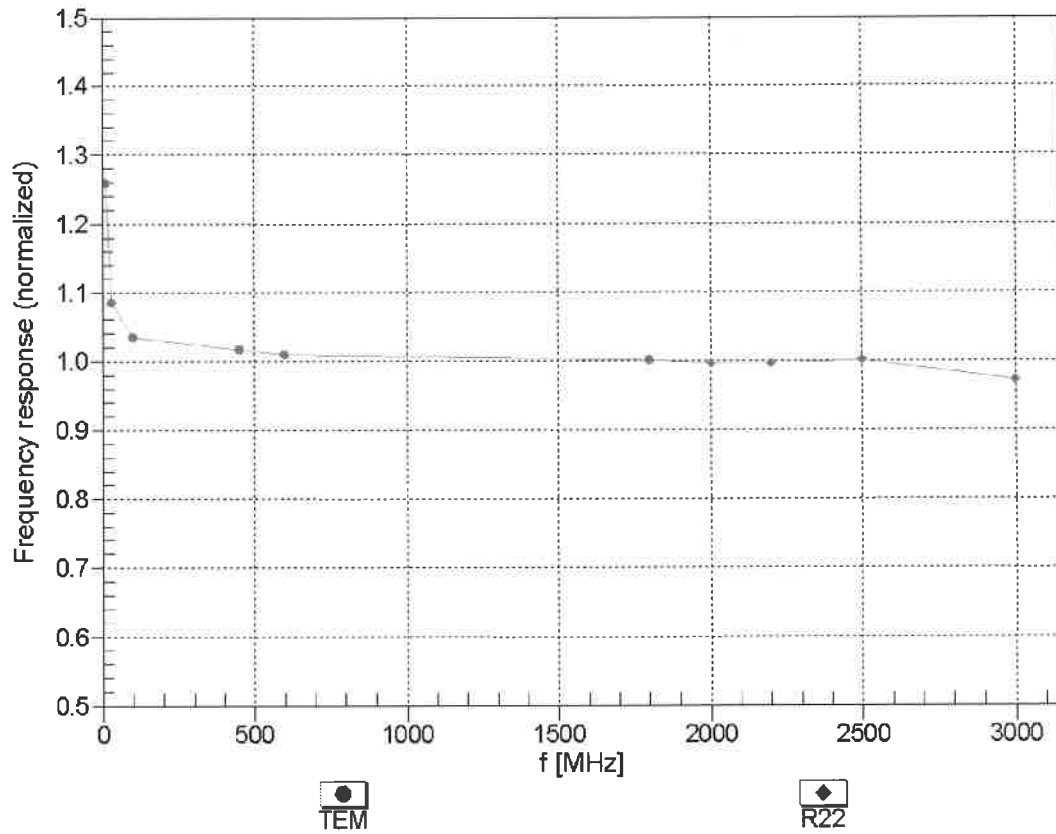

Uncertainty of Frequency Response of E-field: $\pm 6.3\%$ (k=2)

Receiving Pattern (ϕ), $\vartheta = 0^\circ$

f=600 MHz,TEM

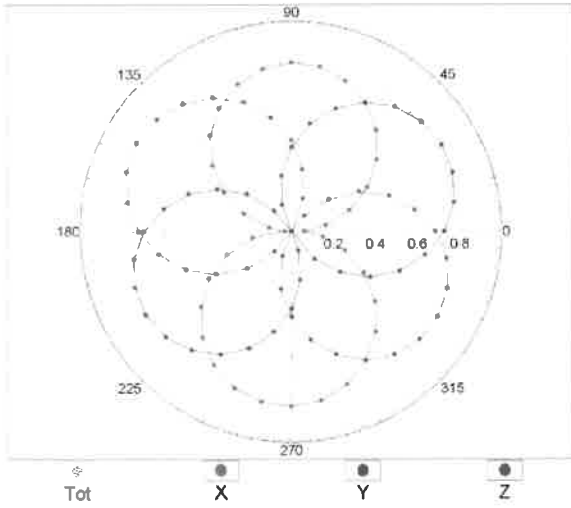

f=1800 MHz,R22

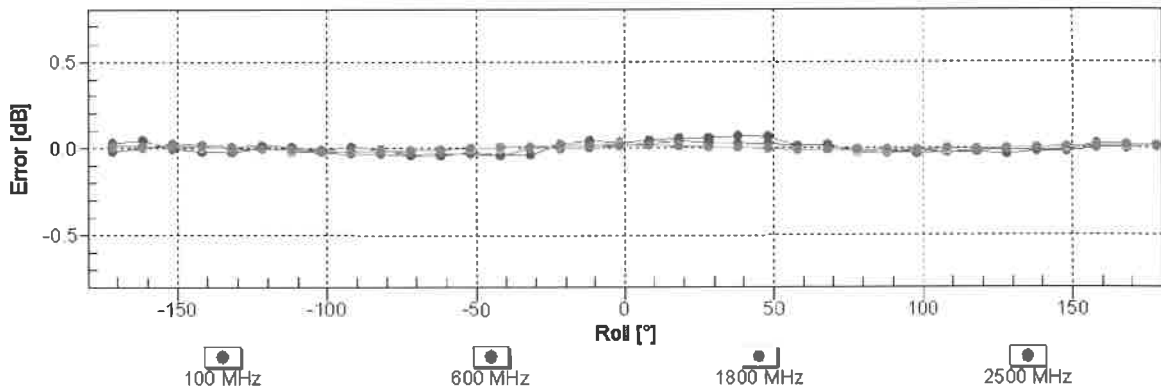
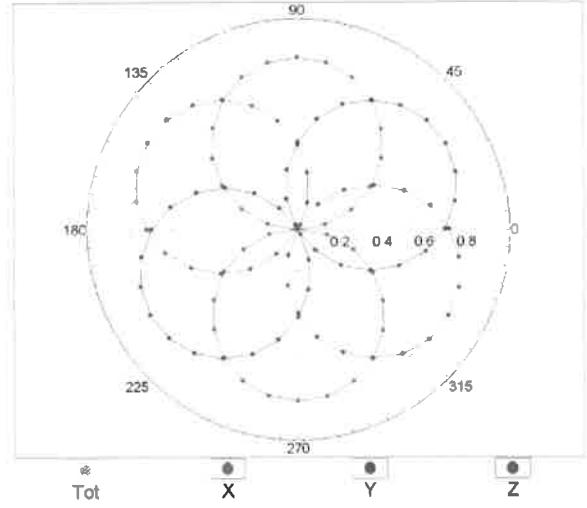

Uncertainty of Axial Isotropy Assessment: $\pm 0.5\%$ (k=2)

Dynamic Range $f(SAR_{head})$ (TEM cell , $f_{eval}= 1900$ MHz)

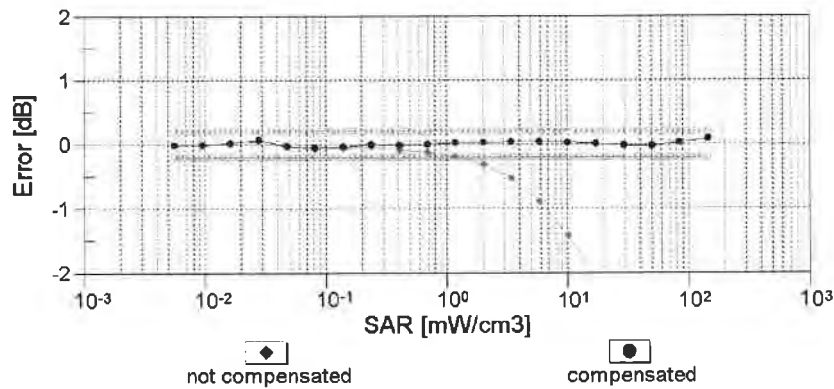
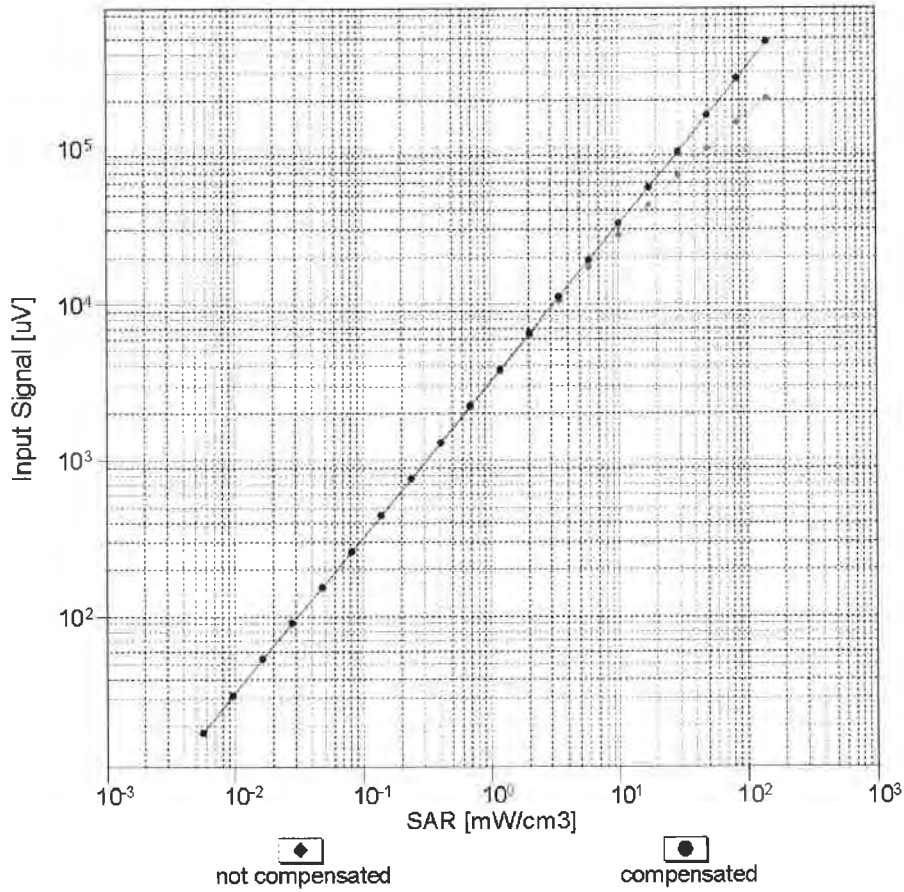

Uncertainty of Linearity Assessment: $\pm 0.6\%$ (k=2)

Conversion Factor Assessment

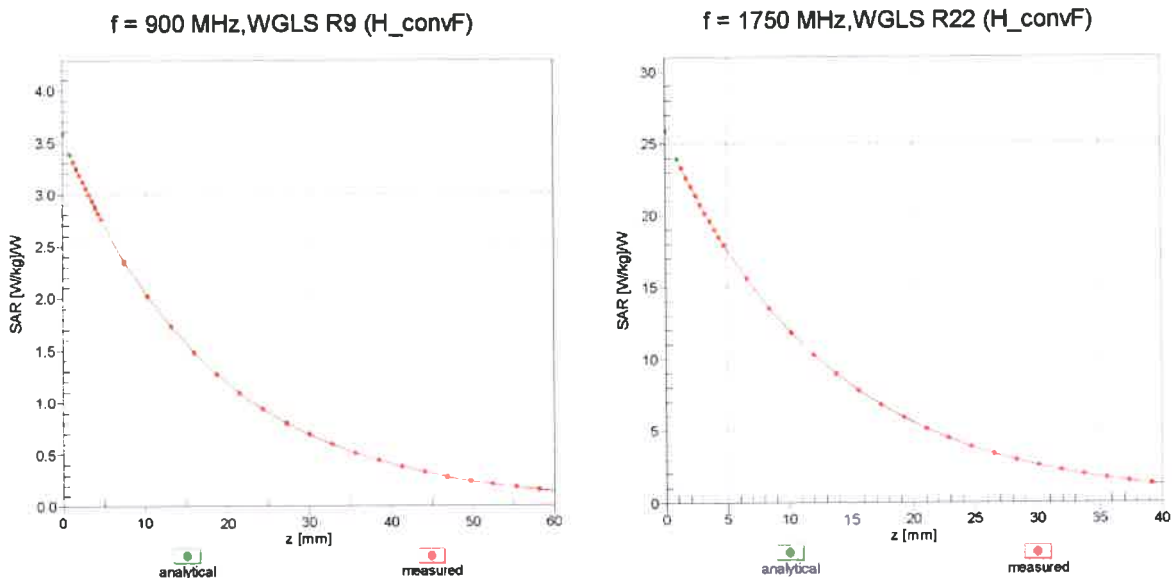

Deviation from Isotropy in Liquid Error (ϕ, ϑ), f = 900 MHz

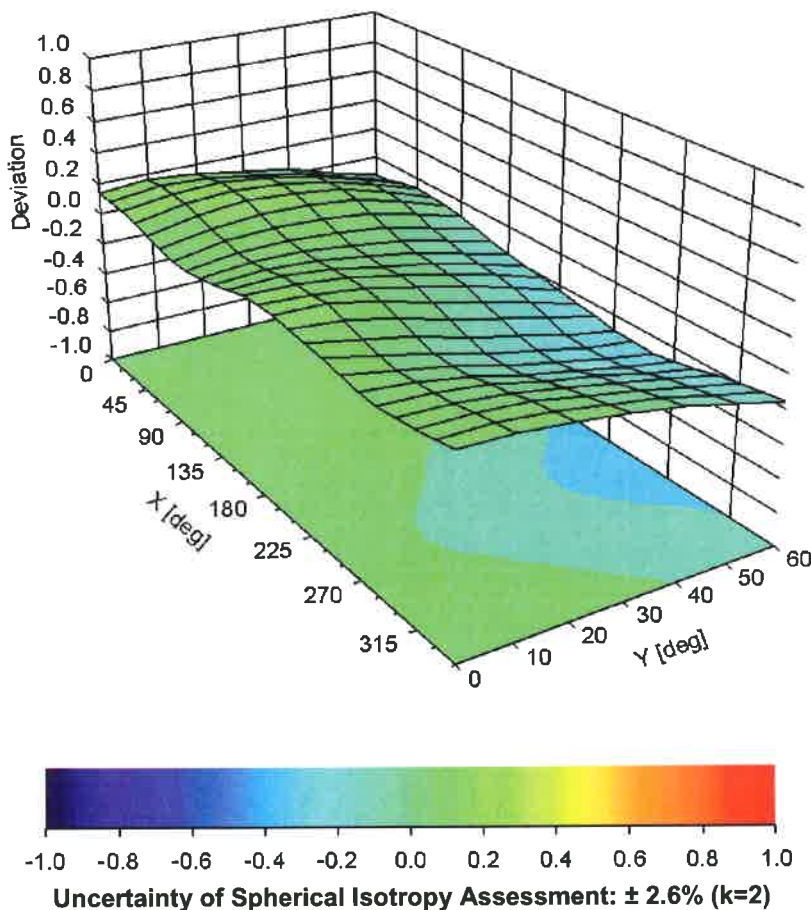

DASY/EASY - Parameters of Probe: EX3DV4 - SN:3590**Other Probe Parameters**

Sensor Arrangement	Triangular
Connector Angle (°)	-141.8
Mechanical Surface Detection Mode	enabled
Optical Surface Detection Mode	disabled
Probe Overall Length	337 mm
Probe Body Diameter	10 mm
Tip Length	9 mm
Tip Diameter	2.5 mm
Probe Tip to Sensor X Calibration Point	1 mm
Probe Tip to Sensor Y Calibration Point	1 mm
Probe Tip to Sensor Z Calibration Point	1 mm
Recommended Measurement Distance from Surface	1.4 mm



Accredited by the Swiss Accreditation Service (SAS)
The Swiss Accreditation Service is one of the signatories to the EA
Multilateral Agreement for the recognition of calibration certificates

Accreditation No.: **SCS 108**

Client **B.V.ADT (Auden)**

Certificate No: **EX3-3864_Jul14**

CALIBRATION CERTIFICATE

Object **EX3DV4 - SN:3864**

Calibration procedure(s) **QA CAL-01.v9, QA CAL-14.v4, QA CAL-23.v5, QA CAL-25.v6
Calibration procedure for dosimetric E-field probes**

Calibration date: **July 25, 2014**

This calibration certificate documents the traceability to national standards, which realize the physical units of measurements (SI).
The measurements and the uncertainties with confidence probability are given on the following pages and are part of the certificate.

All calibrations have been conducted in the closed laboratory facility: environment temperature (22 ± 3)°C and humidity < 70%.

Calibration Equipment used (M&TE critical for calibration)

Primary Standards	ID	Cal Date (Certificate No.)	Scheduled Calibration
Power meter E4419B	GB41293874	03-Apr-14 (No. 217-01911)	Apr-15
Power sensor E4412A	MY41498087	03-Apr-14 (No. 217-01911)	Apr-15
Reference 3 dB Attenuator	SN: S5054 (3c)	03-Apr-14 (No. 217-01915)	Apr-15
Reference 20 dB Attenuator	SN: S5277 (20x)	03-Apr-14 (No. 217-01919)	Apr-15
Reference 30 dB Attenuator	SN: S5129 (30b)	03-Apr-14 (No. 217-01920)	Apr-15
Reference Probe ES3DV2	SN: 3013	30-Dec-13 (No. ES3-3013_Dec13)	Dec-14
DAE4	SN: 660	13-Dec-13 (No. DAE4-660_Dec13)	Dec-14
Secondary Standards	ID	Check Date (in house)	Scheduled Check
RF generator HP 8648C	US3642U01700	4-Aug-99 (in house check Apr-13)	In house check: Apr-16
Network Analyzer HP 8753E	US37390585	18-Oct-01 (in house check Oct-13)	In house check: Oct-14

	Name	Function	Signature
Calibrated by:	Israe El-Naouq	Laboratory Technician	
Approved by:	Katja Pokovic	Technical Manager	

Issued: July 26, 2014

This calibration certificate shall not be reproduced except in full without written approval of the laboratory.



Accredited by the Swiss Accreditation Service (SAS)

Accreditation No.: **SCS 108**

The Swiss Accreditation Service is one of the signatories to the EA
Multilateral Agreement for the recognition of calibration certificates

Glossary:

TSL	tissue simulating liquid
NORM _{x,y,z}	sensitivity in free space
ConvF	sensitivity in TSL / NORM _{x,y,z}
DCP	diode compression point
CF	crest factor (1/duty_cycle) of the RF signal
A, B, C, D	modulation dependent linearization parameters
Polarization φ	φ rotation around probe axis
Polarization ϑ	ϑ rotation around an axis that is in the plane normal to probe axis (at measurement center), i.e., $\vartheta = 0$ is normal to probe axis
Connector Angle	information used in DASY system to align probe sensor X to the robot coordinate system

Calibration is Performed According to the Following Standards:

- IEEE Std 1528-2013, "IEEE Recommended Practice for Determining the Peak Spatial-Averaged Specific Absorption Rate (SAR) in the Human Head from Wireless Communications Devices: Measurement Techniques", June 2013
- IEC 62209-1, "Procedure to measure the Specific Absorption Rate (SAR) for hand-held devices used in close proximity to the ear (frequency range of 300 MHz to 3 GHz)", February 2005

Methods Applied and Interpretation of Parameters:

- NORM_{x,y,z}**: Assessed for E-field polarization $\vartheta = 0$ ($f \leq 900$ MHz in TEM-cell; $f > 1800$ MHz: R22 waveguide). NORM_{x,y,z} are only intermediate values, i.e., the uncertainties of NORM_{x,y,z} does not affect the E²-field uncertainty inside TSL (see below *ConvF*).
- NORM(f)_{x,y,z}** = NORM_{x,y,z} * *frequency_response* (see Frequency Response Chart). This linearization is implemented in DASY4 software versions later than 4.2. The uncertainty of the frequency response is included in the stated uncertainty of *ConvF*.
- DCP_{x,y,z}**: DCP are numerical linearization parameters assessed based on the data of power sweep with CW signal (no uncertainty required). DCP does not depend on frequency nor media.
- PAR**: PAR is the Peak to Average Ratio that is not calibrated but determined based on the signal characteristics
- A_{x,y,z}; B_{x,y,z}; C_{x,y,z}; D_{x,y,z}; VR_{x,y,z}; A, B, C, D** are numerical linearization parameters assessed based on the data of power sweep for specific modulation signal. The parameters do not depend on frequency nor media. VR is the maximum calibration range expressed in RMS voltage across the diode.
- ConvF and Boundary Effect Parameters**: Assessed in flat phantom using E-field (or Temperature Transfer Standard for $f \leq 800$ MHz) and inside waveguide using analytical field distributions based on power measurements for $f > 800$ MHz. The same setups are used for assessment of the parameters applied for boundary compensation (alpha, depth) of which typical uncertainty values are given. These parameters are used in DASY4 software to improve probe accuracy close to the boundary. The sensitivity in TSL corresponds to NORM_{x,y,z} * *ConvF* whereby the uncertainty corresponds to that given for *ConvF*. A frequency dependent *ConvF* is used in DASY version 4.4 and higher which allows extending the validity from ± 50 MHz to ± 100 MHz.
- Spherical isotropy (3D deviation from isotropy)**: in a field of low gradients realized using a flat phantom exposed by a patch antenna.
- Sensor Offset**: The sensor offset corresponds to the offset of virtual measurement center from the probe tip (on probe axis). No tolerance required.
- Connector Angle**: The angle is assessed using the information gained by determining the NORM_x (no uncertainty required).

Probe EX3DV4

SN:3864

Manufactured: February 2, 2012
Calibrated: July 25, 2014

Calibrated for DASY/EASY Systems
(Note: non-compatible with DASY2 system!)

DASY/EASY - Parameters of Probe: EX3DV4 - SN:3864

Basic Calibration Parameters

	Sensor X	Sensor Y	Sensor Z	Unc (k=2)
Norm ($\mu\text{V}/(\text{V}/\text{m})^2$) ^A	0.47	0.45	0.49	$\pm 10.1 \%$
DCP (mV) ^B	98.7	96.9	98.1	

Modulation Calibration Parameters

UID	Communication System Name		A dB	B dB $\sqrt{\mu\text{V}}$	C	D dB	VR mV	Unc ^E (k=2)
0	CW	X	0.0	0.0	1.0	0.00	135.4	$\pm 2.7 \%$
		Y	0.0	0.0	1.0		149.4	
		Z	0.0	0.0	1.0		144.7	

The reported uncertainty of measurement is stated as the standard uncertainty of measurement multiplied by the coverage factor $k=2$, which for a normal distribution corresponds to a coverage probability of approximately 95%.

^A The uncertainties of NormX,Y,Z do not affect the E^2 -field uncertainty inside TSL (see Pages 5 and 6).

^B Numerical linearization parameter: uncertainty not required.

^E Uncertainty is determined using the max. deviation from linear response applying rectangular distribution and is expressed for the square of the field value.

DASY/EASY - Parameters of Probe: EX3DV4 - SN:3864

Calibration Parameter Determined in Head Tissue Simulating Media

f (MHz) ^C	Relative Permittivity ^F	Conductivity (S/m) ^F	ConvF X	ConvF Y	ConvF Z	Alpha ^G	Depth ^G (mm)	Unct. (k=2)
750	41.9	0.89	10.44	10.44	10.44	0.79	0.61	± 12.0 %
835	41.5	0.90	10.03	10.03	10.03	0.79	0.58	± 12.0 %
900	41.5	0.97	9.77	9.77	9.77	0.29	0.97	± 12.0 %
1450	40.5	1.20	9.06	9.06	9.06	0.24	1.30	± 12.0 %
1640	40.3	1.29	8.49	8.49	8.49	0.74	0.56	± 12.0 %
1750	40.1	1.37	8.39	8.39	8.39	0.41	0.74	± 12.0 %
1900	40.0	1.40	8.10	8.10	8.10	0.65	0.61	± 12.0 %
2000	40.0	1.40	8.21	8.21	8.21	0.30	0.92	± 12.0 %
2300	39.5	1.67	7.80	7.80	7.80	0.31	0.87	± 12.0 %
2450	39.2	1.80	7.39	7.39	7.39	0.29	0.96	± 12.0 %
2600	39.0	1.96	7.27	7.27	7.27	0.26	1.11	± 12.0 %
3500	37.9	2.91	6.86	6.86	6.86	0.36	1.05	± 13.1 %
5200	36.0	4.66	5.35	5.35	5.35	0.35	1.80	± 13.1 %
5300	35.9	4.76	5.03	5.03	5.03	0.40	1.80	± 13.1 %
5500	35.6	4.96	4.90	4.90	4.90	0.40	1.80	± 13.1 %
5600	35.5	5.07	4.78	4.78	4.78	0.40	1.80	± 13.1 %
5800	35.3	5.27	4.75	4.75	4.75	0.40	1.80	± 13.1 %

^C Frequency validity above 300 MHz of ± 100 MHz only applies for DASY v4.4 and higher (see Page 2), else it is restricted to ± 50 MHz. The uncertainty is the RSS of the ConvF uncertainty at calibration frequency and the uncertainty for the indicated frequency band. Frequency validity below 300 MHz is ± 10, 25, 40, 50 and 70 MHz for ConvF assessments at 30, 64, 128, 150 and 220 MHz respectively. Above 5 GHz frequency validity can be extended to ± 110 MHz.

^F At frequencies below 3 GHz, the validity of tissue parameters (ϵ and σ) can be relaxed to ± 10% if liquid compensation formula is applied to measured SAR values. At frequencies above 3 GHz, the validity of tissue parameters (ϵ and σ) is restricted to ± 5%. The uncertainty is the RSS of the ConvF uncertainty for indicated target tissue parameters.

^G Alpha/Depth are determined during calibration. SPEAG warrants that the remaining deviation due to the boundary effect after compensation is always less than ± 1% for frequencies below 3 GHz and below ± 2% for frequencies between 3-6 GHz at any distance larger than half the probe tip diameter from the boundary.

DASY/EASY - Parameters of Probe: EX3DV4 - SN:3864

Calibration Parameter Determined in Body Tissue Simulating Media

f (MHz) ^C	Relative Permittivity ^F	Conductivity (S/m) ^F	ConvF X	ConvF Y	ConvF Z	Alpha ^G	Depth ^G (mm)	Unct. (k=2)
750	55.5	0.96	10.08	10.08	10.08	0.64	0.70	± 12.0 %
835	55.2	0.97	10.04	10.04	10.04	0.44	0.82	± 12.0 %
900	55.0	1.05	9.71	9.71	9.71	0.28	1.08	± 12.0 %
1450	54.0	1.30	8.18	8.18	8.18	0.33	0.98	± 12.0 %
1640	53.8	1.40	8.49	8.49	8.49	0.57	0.71	± 12.0 %
1750	53.4	1.49	8.02	8.02	8.02	0.31	0.97	± 12.0 %
1900	53.3	1.52	7.72	7.72	7.72	0.49	0.75	± 12.0 %
2000	53.3	1.52	7.80	7.80	7.80	0.46	0.75	± 12.0 %
2300	52.9	1.81	7.43	7.43	7.43	0.64	0.65	± 12.0 %
2450	52.7	1.95	7.14	7.14	7.14	0.57	0.65	± 12.0 %
2600	52.5	2.16	7.00	7.00	7.00	0.80	0.50	± 12.0 %
3500	51.3	3.31	6.42	6.42	6.42	0.41	1.07	± 13.1 %
5200	49.0	5.30	4.49	4.49	4.49	0.45	1.90	± 13.1 %
5300	48.9	5.42	4.16	4.16	4.16	0.50	1.90	± 13.1 %
5500	48.6	5.65	3.92	3.92	3.92	0.50	1.90	± 13.1 %
5600	48.5	5.77	3.77	3.77	3.77	0.50	1.90	± 13.1 %
5800	48.2	6.00	4.01	4.01	4.01	0.50	1.90	± 13.1 %

^C Frequency validity above 300 MHz of ± 100 MHz only applies for DASY v4.4 and higher (see Page 2), else it is restricted to ± 50 MHz. The uncertainty is the RSS of the ConvF uncertainty at calibration frequency and the uncertainty for the indicated frequency band. Frequency validity below 300 MHz is ± 10, 25, 40, 50 and 70 MHz for ConvF assessments at 30, 64, 128, 150 and 220 MHz respectively. Above 5 GHz frequency validity can be extended to ± 110 MHz.

^F At frequencies below 3 GHz, the validity of tissue parameters (ϵ and σ) can be relaxed to ± 10% if liquid compensation formula is applied to measured SAR values. At frequencies above 3 GHz, the validity of tissue parameters (ϵ and σ) is restricted to ± 5%. The uncertainty is the RSS of the ConvF uncertainty for indicated target tissue parameters.

^G Alpha/Depth are determined during calibration. SPEAG warrants that the remaining deviation due to the boundary effect after compensation is always less than ± 1% for frequencies below 3 GHz and below ± 2% for frequencies between 3-6 GHz at any distance larger than half the probe tip diameter from the boundary.

Frequency Response of E-Field (TEM-Cell:ifi110 EXX, Waveguide: R22)

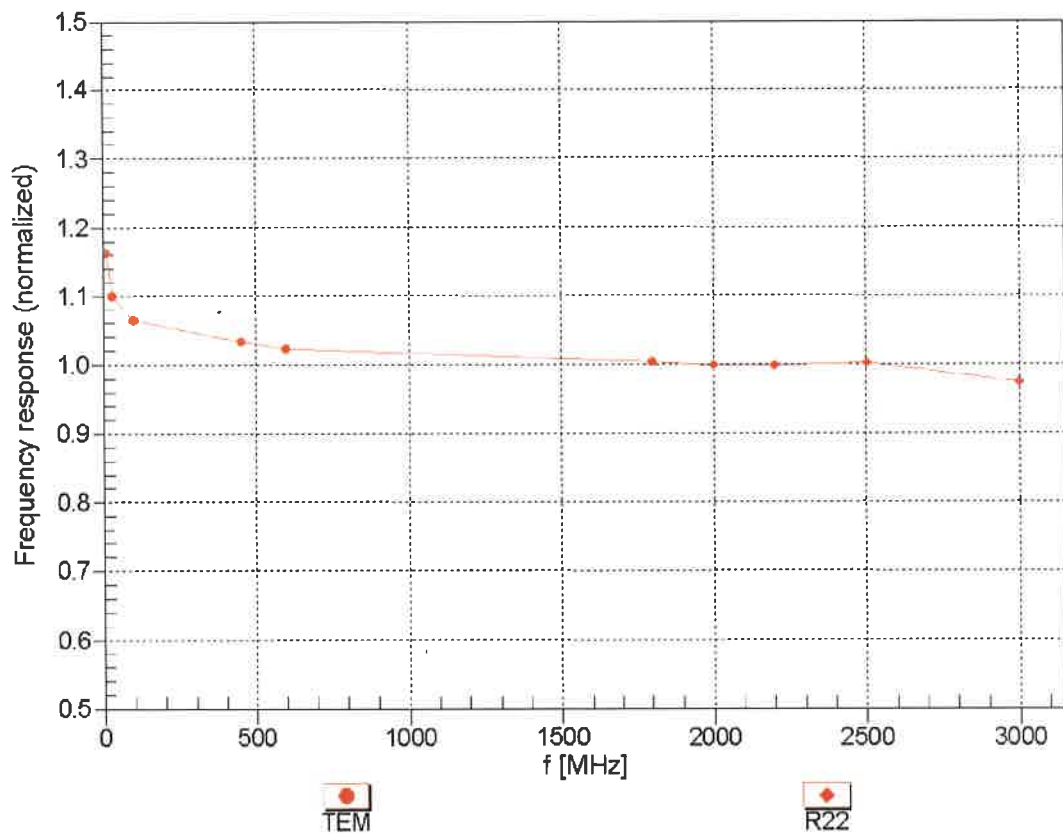

Uncertainty of Frequency Response of E-field: $\pm 6.3\%$ (k=2)

Receiving Pattern (ϕ), $\theta = 0^\circ$

f=600 MHz,TEM

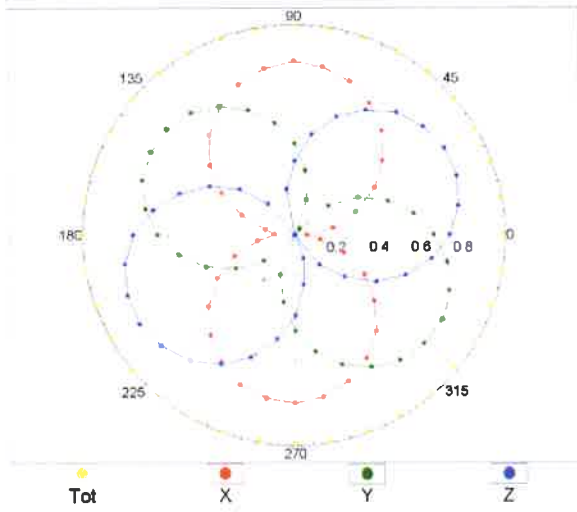

f=1800 MHz,R22

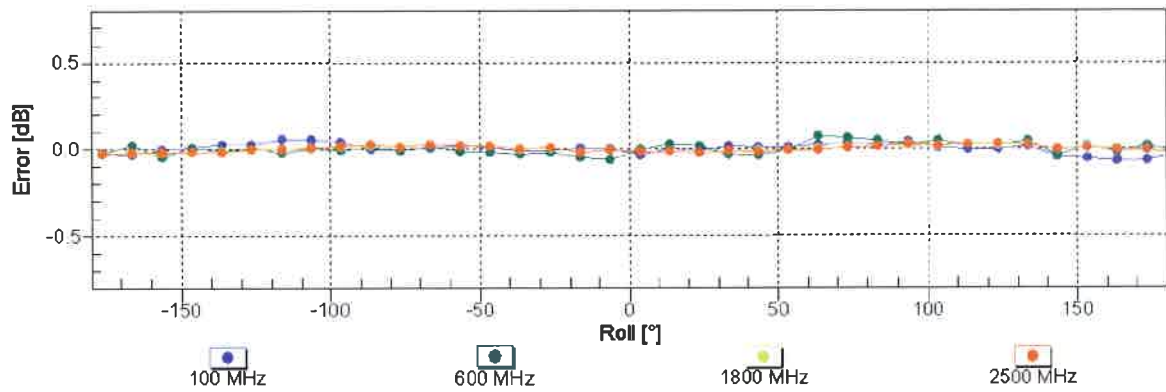
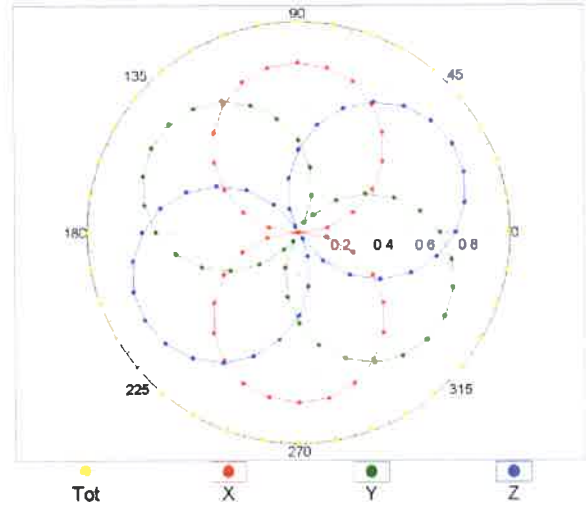

Uncertainty of Axial Isotropy Assessment: $\pm 0.5\%$ (k=2)

Dynamic Range f(SAR_{head}) (TEM cell , f_{eval}= 1900 MHz)

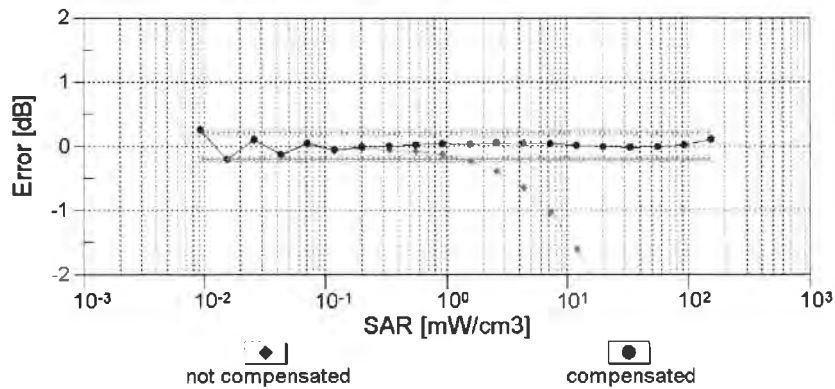
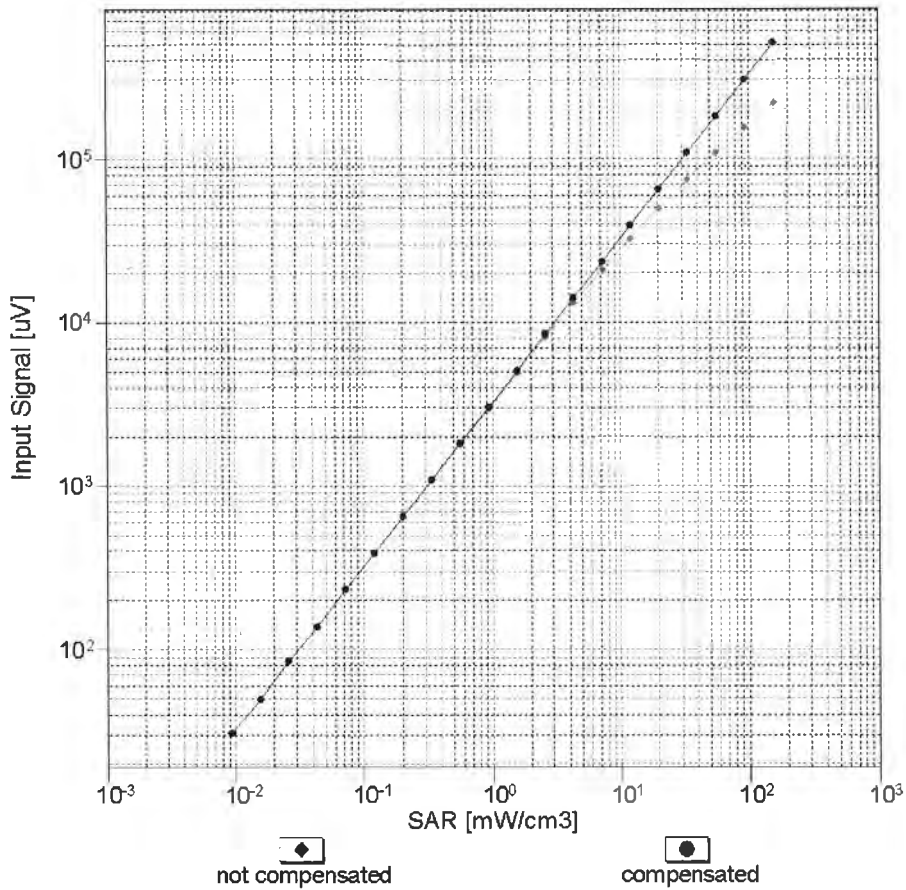

Uncertainty of Linearity Assessment: ± 0.6% (k=2)

Conversion Factor Assessment

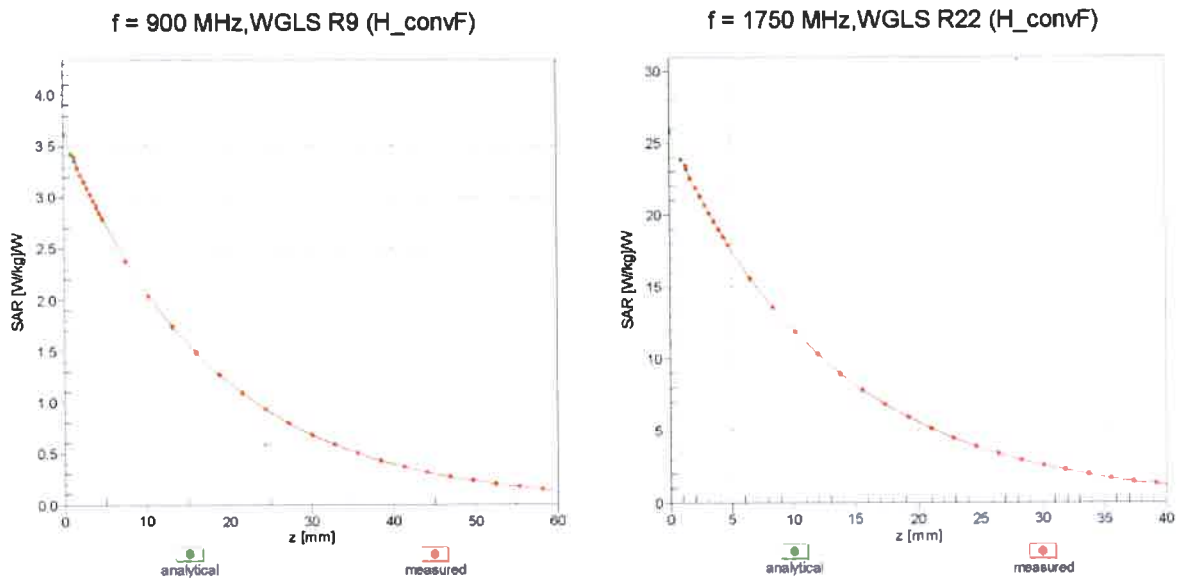

Deviation from Isotropy in Liquid Error (ϕ, θ), f = 900 MHz

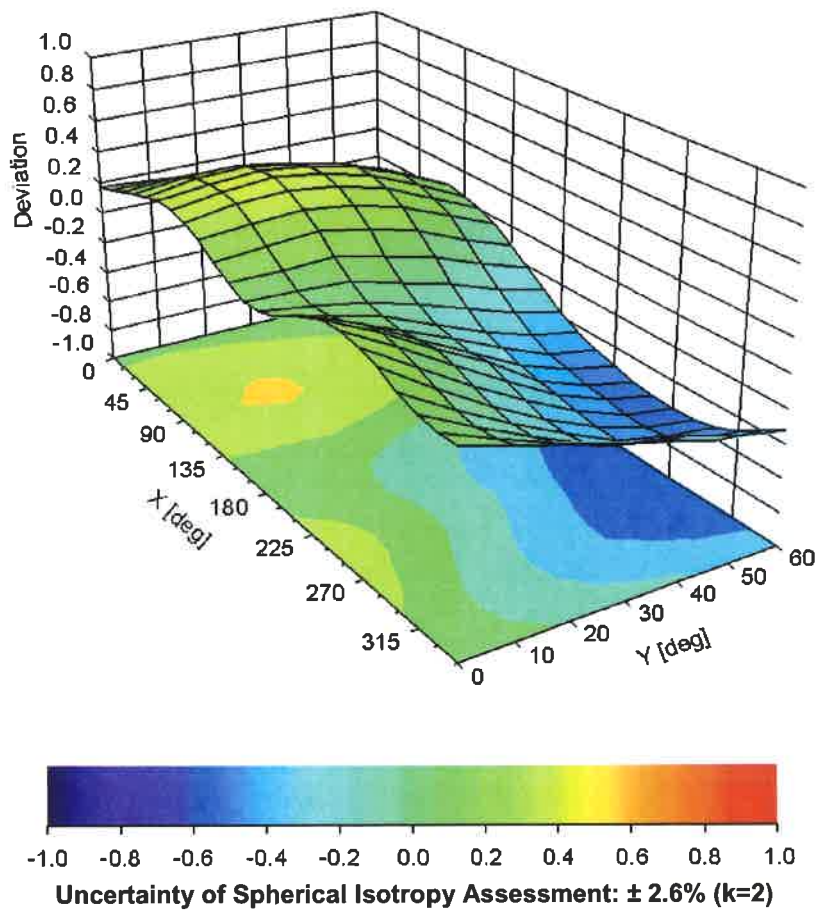

DASY/EASY - Parameters of Probe: EX3DV4 - SN:3864

Other Probe Parameters

Sensor Arrangement	Triangular
Connector Angle (°)	-116.5
Mechanical Surface Detection Mode	enabled
Optical Surface Detection Mode	disabled
Probe Overall Length	337 mm
Probe Body Diameter	10 mm
Tip Length	9 mm
Tip Diameter	2.5 mm
Probe Tip to Sensor X Calibration Point	1 mm
Probe Tip to Sensor Y Calibration Point	1 mm
Probe Tip to Sensor Z Calibration Point	1 mm
Recommended Measurement Distance from Surface	1.4 mm



Accredited by the Swiss Accreditation Service (SAS)
The Swiss Accreditation Service is one of the signatories to the EA
Multilateral Agreement for the recognition of calibration certificates

Accreditation No.: **SCS 108**

Client **B.V. ADT (Auden)**

Certificate No: **EX3-3873_Aug14**

CALIBRATION CERTIFICATE

Object **EX3DV4 - SN:3873**

Calibration procedure(s) **QA CAL-01.v9, QA CAL-14.v4, QA CAL-23.v5, QA CAL-25.v6
Calibration procedure for dosimetric E-field probes**

Calibration date: **August 26, 2014**

This calibration certificate documents the traceability to national standards, which realize the physical units of measurements (SI).
The measurements and the uncertainties with confidence probability are given on the following pages and are part of the certificate.

All calibrations have been conducted in the closed laboratory facility: environment temperature (22 ± 3)°C and humidity < 70%.

Calibration Equipment used (M&TE critical for calibration)

Primary Standards	ID	Cal Date (Certificate No.)	Scheduled Calibration
Power meter E4419B	GB41293874	03-Apr-14 (No. 217-01911)	Apr-15
Power sensor E4412A	MY41498087	03-Apr-14 (No. 217-01911)	Apr-15
Reference 3 dB Attenuator	SN: S5054 (3c)	03-Apr-14 (No. 217-01915)	Apr-15
Reference 20 dB Attenuator	SN: S5277 (20x)	03-Apr-14 (No. 217-01919)	Apr-15
Reference 30 dB Attenuator	SN: S5129 (30b)	03-Apr-14 (No. 217-01920)	Apr-15
Reference Probe ES3DV2	SN: 3013	30-Dec-13 (No. ES3-3013_Dec13)	Dec-14
DAE4	SN: 660	13-Dec-13 (No. DAE4-660_Dec13)	Dec-14
Secondary Standards	ID	Check Date (in house)	Scheduled Check
RF generator HP 8648C	US3642U01700	4-Aug-99 (in house check Apr-13)	In house check: Apr-16
Network Analyzer HP 8753E	US37390585	18-Oct-01 (in house check Oct-13)	In house check: Oct-14

	Name	Function	Signature
Calibrated by:	Israe El-Naouq	Laboratory Technician	
Approved by:	Katja Pokovic	Technical Manager	

Issued: August 26, 2014

This calibration certificate shall not be reproduced except in full without written approval of the laboratory.



Accredited by the Swiss Accreditation Service (SAS)

Accreditation No.: **SCS 108**

The Swiss Accreditation Service is one of the signatories to the EA Multilateral Agreement for the recognition of calibration certificates

Glossary:

TSL	tissue simulating liquid
NORM _{x,y,z}	sensitivity in free space
ConvF	sensitivity in TSL / NORM _{x,y,z}
DCP	diode compression point
CF	crest factor (1/duty_cycle) of the RF signal
A, B, C, D	modulation dependent linearization parameters
Polarization ϕ	ϕ rotation around probe axis
Polarization ϑ	ϑ rotation around an axis that is in the plane normal to probe axis (at measurement center), i.e., $\vartheta = 0$ is normal to probe axis
Connector Angle	information used in DASY system to align probe sensor X to the robot coordinate system

Calibration is Performed According to the Following Standards:

- IEEE Std 1528-2013, "IEEE Recommended Practice for Determining the Peak Spatial-Averaged Specific Absorption Rate (SAR) in the Human Head from Wireless Communications Devices: Measurement Techniques", June 2013
- IEC 62209-1, "Procedure to measure the Specific Absorption Rate (SAR) for hand-held devices used in close proximity to the ear (frequency range of 300 MHz to 3 GHz)", February 2005

Methods Applied and Interpretation of Parameters:

- NORM_{x,y,z}**: Assessed for E-field polarization $\vartheta = 0$ ($f \leq 900$ MHz in TEM-cell; $f > 1800$ MHz: R22 waveguide). NORM_{x,y,z} are only intermediate values, i.e., the uncertainties of NORM_{x,y,z} does not affect the E²-field uncertainty inside TSL (see below ConvF).
- NORM(f)_{x,y,z}** = NORM_{x,y,z} * frequency_response (see Frequency Response Chart). This linearization is implemented in DASY4 software versions later than 4.2. The uncertainty of the frequency response is included in the stated uncertainty of ConvF.
- DCP_{x,y,z}**: DCP are numerical linearization parameters assessed based on the data of power sweep with CW signal (no uncertainty required). DCP does not depend on frequency nor media.
- PAR**: PAR is the Peak to Average Ratio that is not calibrated but determined based on the signal characteristics
- A_{x,y,z}; B_{x,y,z}; C_{x,y,z}; D_{x,y,z}; VR_{x,y,z}; A, B, C, D** are numerical linearization parameters assessed based on the data of power sweep for specific modulation signal. The parameters do not depend on frequency nor media. VR is the maximum calibration range expressed in RMS voltage across the diode.
- ConvF and Boundary Effect Parameters**: Assessed in flat phantom using E-field (or Temperature Transfer Standard for $f \leq 800$ MHz) and inside waveguide using analytical field distributions based on power measurements for $f > 800$ MHz. The same setups are used for assessment of the parameters applied for boundary compensation (alpha, depth) of which typical uncertainty values are given. These parameters are used in DASY4 software to improve probe accuracy close to the boundary. The sensitivity in TSL corresponds to NORM_{x,y,z} * ConvF whereby the uncertainty corresponds to that given for ConvF. A frequency dependent ConvF is used in DASY version 4.4 and higher which allows extending the validity from ± 50 MHz to ± 100 MHz.
- Spherical isotropy (3D deviation from isotropy)**: in a field of low gradients realized using a flat phantom exposed by a patch antenna.
- Sensor Offset**: The sensor offset corresponds to the offset of virtual measurement center from the probe tip (on probe axis). No tolerance required.
- Connector Angle**: The angle is assessed using the information gained by determining the NORM_x (no uncertainty required).

Probe EX3DV4

SN:3873

Manufactured: March 13, 2012
Calibrated: August 26, 2014

Calibrated for DASY/EASY Systems
(Note: non-compatible with DASY2 system!)

DASY/EASY - Parameters of Probe: EX3DV4 - SN:3873

Basic Calibration Parameters

	Sensor X	Sensor Y	Sensor Z	Unc (k=2)
Norm ($\mu\text{V}/(\text{V}/\text{m})^2$) ^A	0.37	0.46	0.49	$\pm 10.1 \%$
DCP (mV) ^B	97.4	97.8	97.0	

Modulation Calibration Parameters

UID	Communication System Name		A dB	B dB $\sqrt{\mu\text{V}}$	C	D dB	VR mV	Unc ^E (k=2)
0	CW	X	0.0	0.0	1.0	0.00	133.2	$\pm 3.8 \%$
		Y	0.0	0.0	1.0		149.1	
		Z	0.0	0.0	1.0		131.6	

The reported uncertainty of measurement is stated as the standard uncertainty of measurement multiplied by the coverage factor $k=2$, which for a normal distribution corresponds to a coverage probability of approximately 95%.

^A The uncertainties of NormX,Y,Z do not affect the E^2 -field uncertainty inside TSL (see Pages 5 and 6).

^B Numerical linearization parameter: uncertainty not required.

^E Uncertainty is determined using the max. deviation from linear response applying rectangular distribution and is expressed for the square of the field value.

DASY/EASY - Parameters of Probe: EX3DV4 - SN:3873

Calibration Parameter Determined in Head Tissue Simulating Media

f (MHz) ^C	Relative Permittivity ^F	Conductivity (S/m) ^F	ConvF X	ConvF Y	ConvF Z	Alpha ^G	Depth ^G (mm)	Unct. (k=2)
750	41.9	0.89	10.11	10.11	10.11	0.80	0.61	± 12.0 %
835	41.5	0.90	9.77	9.77	9.77	0.70	0.64	± 12.0 %
900	41.5	0.97	9.62	9.62	9.62	0.52	0.74	± 12.0 %
1450	40.5	1.20	8.46	8.46	8.46	0.80	0.50	± 12.0 %
1750	40.1	1.37	8.06	8.06	8.06	0.60	0.61	± 12.0 %
1900	40.0	1.40	7.82	7.82	7.82	0.55	0.67	± 12.0 %
2300	39.5	1.67	7.50	7.50	7.50	0.32	0.82	± 12.0 %
2450	39.2	1.80	7.18	7.18	7.18	0.47	0.68	± 12.0 %
2600	39.0	1.96	7.05	7.05	7.05	0.43	0.79	± 12.0 %
5200	36.0	4.66	5.13	5.13	5.13	0.30	1.80	± 13.1 %
5300	35.9	4.76	4.84	4.84	4.84	0.30	1.80	± 13.1 %
5500	35.6	4.96	4.78	4.78	4.78	0.35	1.80	± 13.1 %
5600	35.5	5.07	4.60	4.60	4.60	0.35	1.80	± 13.1 %
5800	35.3	5.27	4.54	4.54	4.54	0.40	1.80	± 13.1 %

^C Frequency validity above 300 MHz of ± 100 MHz only applies for DASY v4.4 and higher (see Page 2), else it is restricted to ± 50 MHz. The uncertainty is the RSS of the ConvF uncertainty at calibration frequency and the uncertainty for the indicated frequency band. Frequency validity below 300 MHz is ± 10, 25, 40, 50 and 70 MHz for ConvF assessments at 30, 64, 128, 150 and 220 MHz respectively. Above 5 GHz frequency validity can be extended to ± 110 MHz.

^F At frequencies below 3 GHz, the validity of tissue parameters (ϵ and σ) can be relaxed to ± 10% if liquid compensation formula is applied to measured SAR values. At frequencies above 3 GHz, the validity of tissue parameters (ϵ and σ) is restricted to ± 5%. The uncertainty is the RSS of the ConvF uncertainty for indicated target tissue parameters.

^G Alpha/Depth are determined during calibration. SPEAG warrants that the remaining deviation due to the boundary effect after compensation is always less than ± 1% for frequencies below 3 GHz and below ± 2% for frequencies between 3-6 GHz at any distance larger than half the probe tip diameter from the boundary.

DASY/EASY - Parameters of Probe: EX3DV4 - SN:3873

Calibration Parameter Determined in Body Tissue Simulating Media

f (MHz) ^C	Relative Permittivity ^F	Conductivity (S/m) ^F	ConvF X	ConvF Y	ConvF Z	Alpha ^G	Depth ^G (mm)	Unct. (k=2)
750	55.5	0.96	9.54	9.54	9.54	0.36	0.95	± 12.0 %
835	55.2	0.97	9.50	9.50	9.50	0.34	1.00	± 12.0 %
900	55.0	1.05	9.26	9.26	9.26	0.80	0.60	± 12.0 %
1450	54.0	1.30	8.11	8.11	8.11	0.53	0.67	± 12.0 %
1750	53.4	1.49	7.72	7.72	7.72	0.41	0.81	± 12.0 %
1900	53.3	1.52	7.44	7.44	7.44	0.38	0.85	± 12.0 %
2300	52.9	1.81	7.31	7.31	7.31	0.41	0.82	± 12.0 %
2450	52.7	1.95	7.13	7.13	7.13	0.80	0.50	± 12.0 %
2600	52.5	2.16	6.94	6.94	6.94	0.80	0.50	± 12.0 %
5200	49.0	5.30	4.44	4.44	4.44	0.45	1.90	± 13.1 %
5300	48.9	5.42	4.27	4.27	4.27	0.45	1.90	± 13.1 %
5500	48.6	5.65	3.92	3.92	3.92	0.50	1.90	± 13.1 %
5600	48.5	5.77	3.83	3.83	3.83	0.50	1.90	± 13.1 %
5800	48.2	6.00	4.00	4.00	4.00	0.50	1.90	± 13.1 %

^C Frequency validity above 300 MHz of ± 100 MHz only applies for DASY v4.4 and higher (see Page 2), else it is restricted to ± 50 MHz. The uncertainty is the RSS of the ConvF uncertainty at calibration frequency and the uncertainty for the indicated frequency band. Frequency validity below 300 MHz is ± 10, 25, 40, 50 and 70 MHz for ConvF assessments at 30, 64, 128, 150 and 220 MHz respectively. Above 5 GHz frequency validity can be extended to ± 110 MHz.

^F At frequencies below 3 GHz, the validity of tissue parameters (ϵ and σ) can be relaxed to ± 10% if liquid compensation formula is applied to measured SAR values. At frequencies above 3 GHz, the validity of tissue parameters (ϵ and σ) is restricted to ± 5%. The uncertainty is the RSS of the ConvF uncertainty for indicated target tissue parameters.

^G Alpha/Depth are determined during calibration. SPEAG warrants that the remaining deviation due to the boundary effect after compensation is always less than ± 1% for frequencies below 3 GHz and below ± 2% for frequencies between 3-6 GHz at any distance larger than half the probe tip diameter from the boundary.

Frequency Response of E-Field (TEM-Cell:ifi110 EXX, Waveguide: R22)

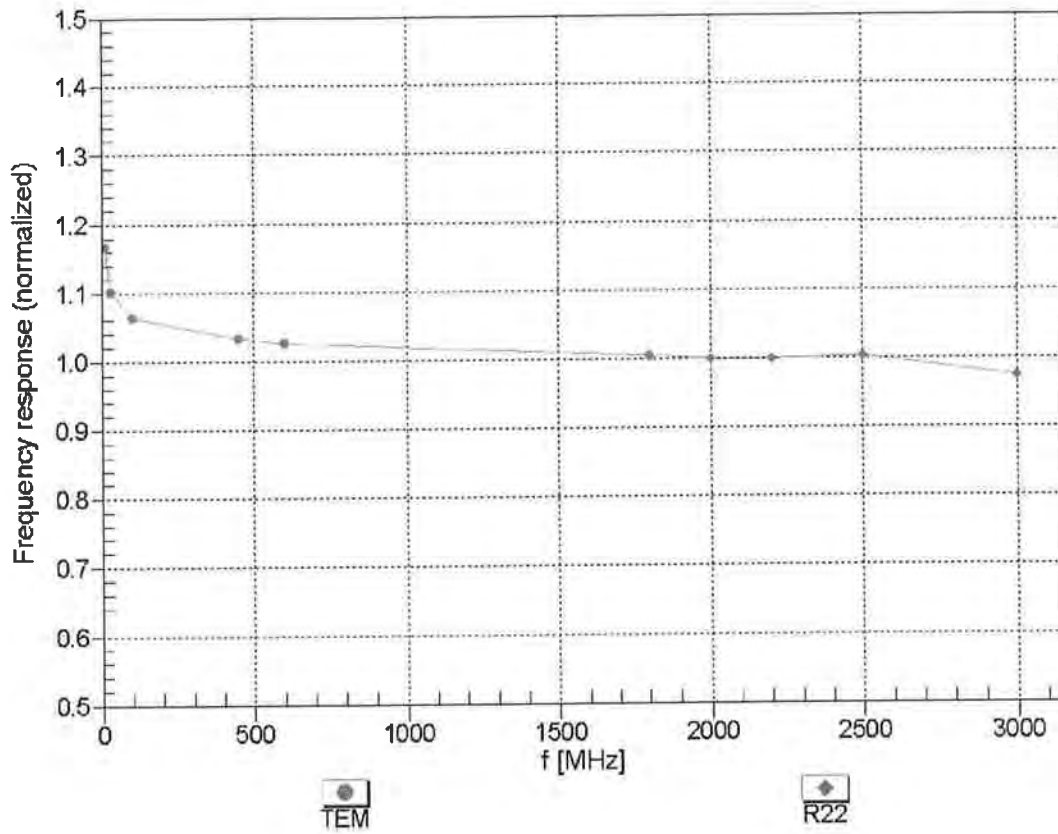

Uncertainty of Frequency Response of E-field: $\pm 6.3\%$ (k=2)

Receiving Pattern (ϕ), $\vartheta = 0^\circ$

f=600 MHz,TEM

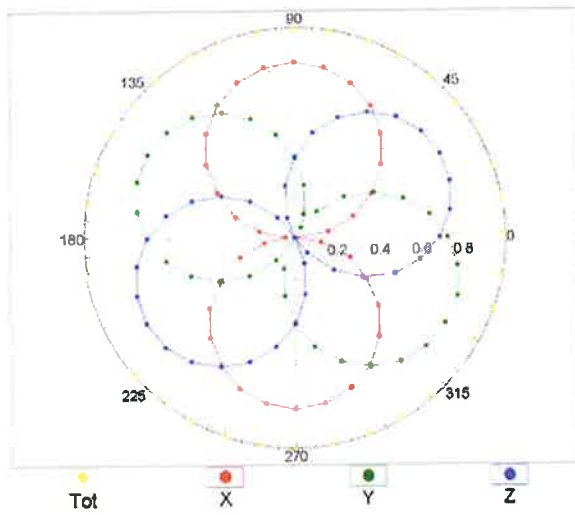

f=1800 MHz,R22

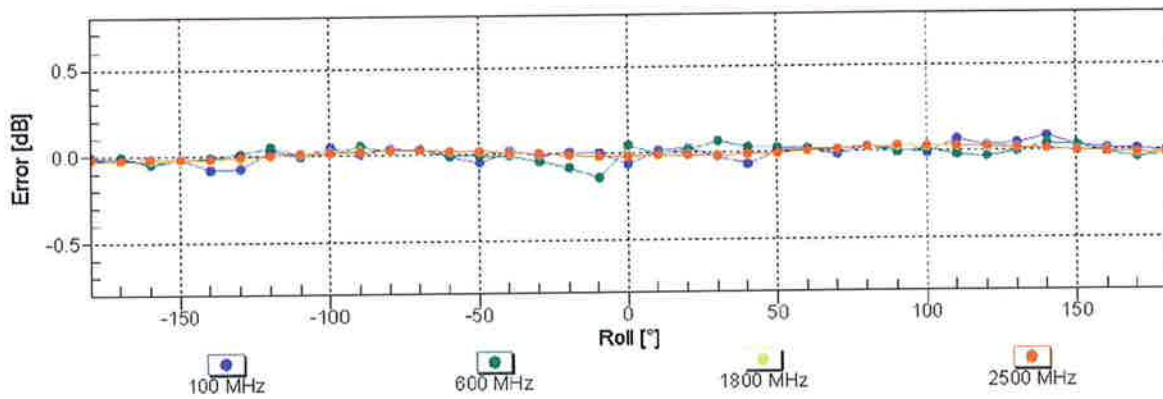
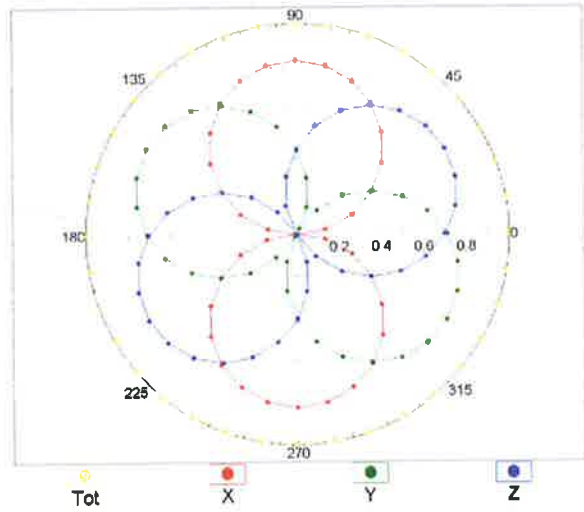

Uncertainty of Axial Isotropy Assessment: $\pm 0.5\%$ (k=2)

Dynamic Range $f(SAR_{head})$ (TEM cell , $f_{eval}= 1900$ MHz)

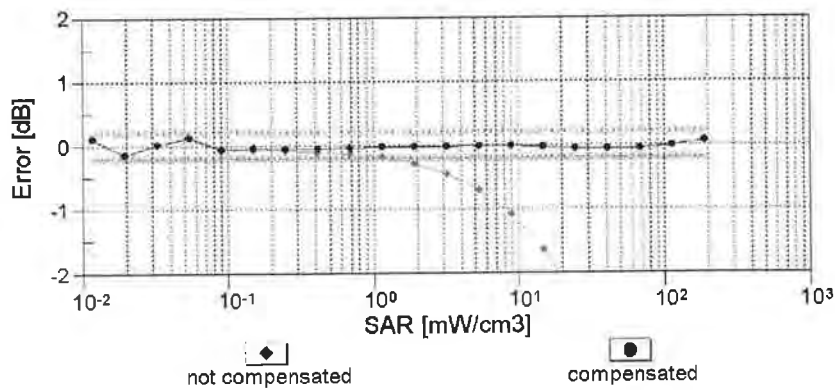
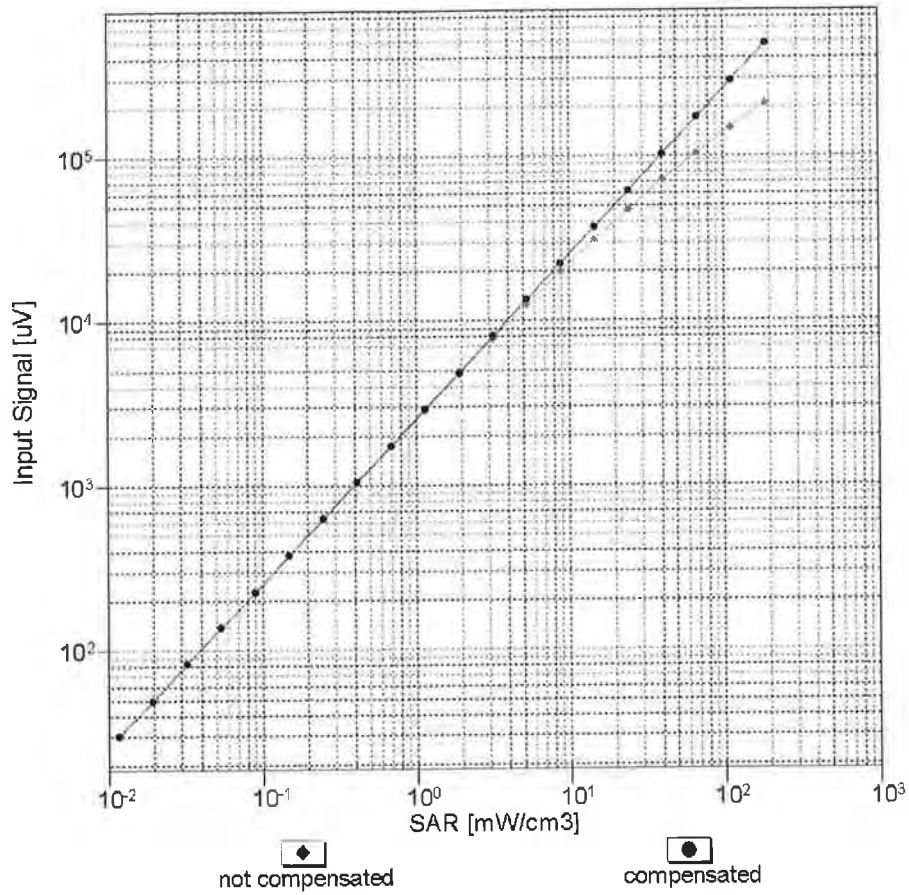

Uncertainty of Linearity Assessment: ± 0.6% (k=2)

Conversion Factor Assessment

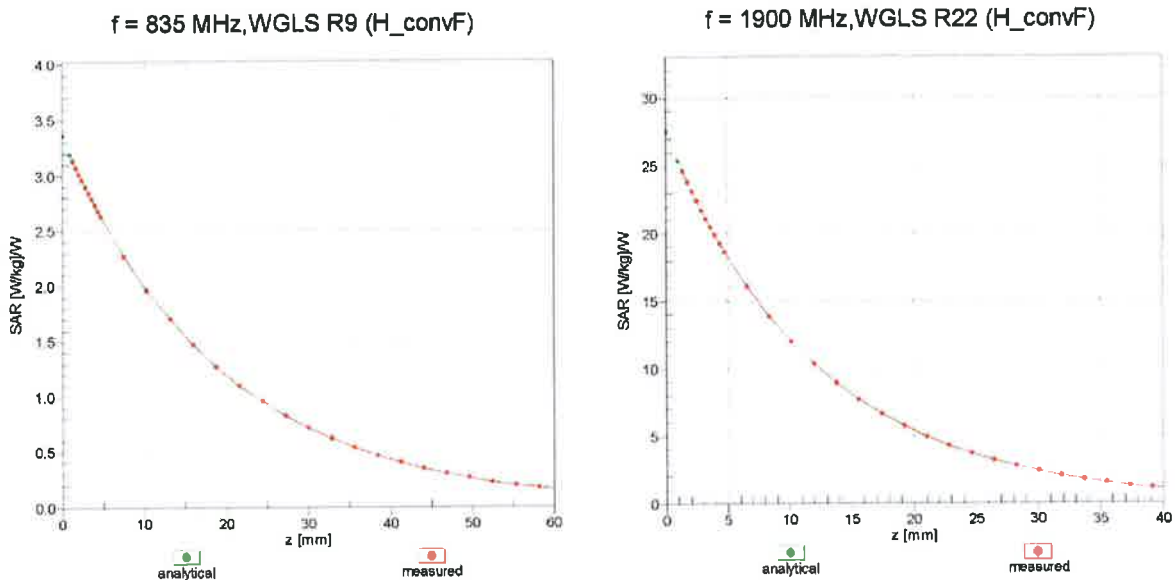

Deviation from Isotropy in Liquid Error (ϕ, ϑ), f = 900 MHz

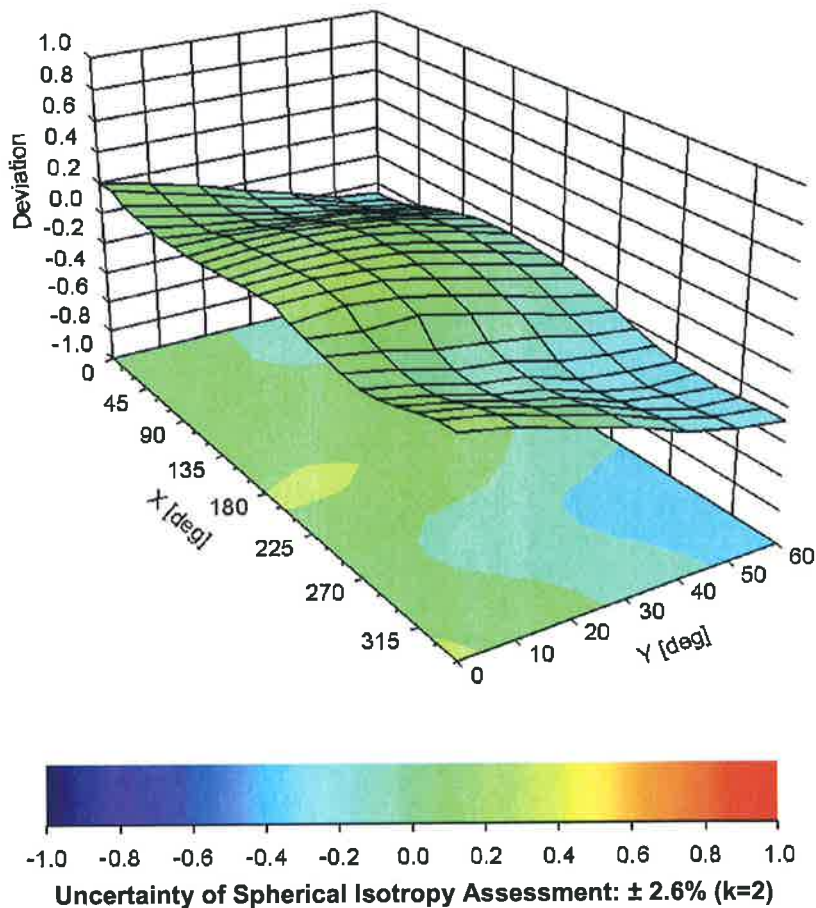

DASY/EASY - Parameters of Probe: EX3DV4 - SN:3873

Other Probe Parameters

Sensor Arrangement	Triangular
Connector Angle (°)	20.4
Mechanical Surface Detection Mode	enabled
Optical Surface Detection Mode	disabled
Probe Overall Length	337 mm
Probe Body Diameter	10 mm
Tip Length	9 mm
Tip Diameter	2.5 mm
Probe Tip to Sensor X Calibration Point	1 mm
Probe Tip to Sensor Y Calibration Point	1 mm
Probe Tip to Sensor Z Calibration Point	1 mm
Recommended Measurement Distance from Surface	1.4 mm