



**BUREAU
VERITAS**

Test Report No.: RF140801N015-5



Test Lab
Cert 2951.01

TEST REPORT



Applicant	Sonim Technologies, Inc.
Address	1825 S. Grant St., Suite 200., San Mateo, CA, 94402

Manufacturer or Supplier	Shanghai Sunrise Simcom limited
Address	No.888, Shengli Road, Qingpu Industrial Park, Shanghai, P.R.China
Product	LTE Smartphone
Brand Name	Sonim
Model	XP7700
Type Number	L12V012AA; L13V012AA
Additional Model & Model Difference	N/A
Date of tests	May. 06 ~ Jun. 06, 2014

the tests have been carried out according to the requirements of the following standard:

FCC Part 15, Subpart E, Section 15.407

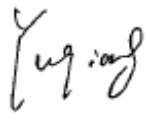
CONCLUSION: The submitted sample was found to COMPLY with the test requirement

Tested by Yuqiang Yin Project Engineer / EMC Department	Approved by Glyn He Supervisor / EMC Department
	 Date: Aug. 05, 2014

This report is for your exclusive use. Any copying or replication of this report to or for any other person or entity, or use of our name or trademark, is permitted only with our prior written permission. This report sets forth our findings solely with respect to the test samples identified herein. The results set forth in this report are not indicative or representative of the quality or characteristics of the lot from which a test sample was taken or any similar or identical product unless specifically and expressly noted. Our report includes all of the tests requested by you and the results thereof based upon the information that you provided to us. You have 60 days from date of issuance of this report to notify us of any material error or omission caused by our negligence, provided, however, that such notice shall be in writing and shall specifically address the issue you wish to raise. A failure to raise such issue within the prescribed time shall constitute your unqualified acceptance of the completeness of this report, the tests conducted and the correctness of the report contents. Unless specific mention, the uncertainty of measurement has been explicitly taken into account to declare the compliance or non-compliance to the specification



TABLE OF CONTENTS

RELEASE CONTROL RECORD 4

1 SUMMARY OF TEST RESULTS..... 5

2 MEASUREMENT UNCERTAINTY 5

3 GENERAL INFORMATION..... 6

3.1 GENERAL DESCRIPTION OF EUT..... 6

3.2 DESCRIPTION OF TEST MODES..... 8

 3.2.1 TEST MODE APPLICABILITY AND TESTED CHANNEL DETAIL..... 10

3.3 DUTY CYCLE OF TEST SIGNAL 13

3.4 DESCRIPTION OF SUPPORT UNITS..... 14

 3.4.1 CONFIGURATION OF SYSTEM UNDER TEST 15

3.5 GENERAL DESCRIPTION OF APPLIED STANDARDS..... 15

4 TEST TYPES AND RESULTS..... 16

4.1 RADIATED EMISSION AND BANDEDGE MEASUREMENT 16

 4.1.1 LIMITS OF RADIATED EMISSION AND BANDEDGE MEASUREMENT..... 16

 4.1.2 LIMITS OF UNWANTED EMISSION OUT OF THE RESTRICTED BANDS 16

 4.1.3 TEST INSTRUMENTS..... 17

 4.1.4 TEST PROCEDURES 18

 4.1.5 DEVIATION FROM TEST STANDARD 18

 4.1.6 TEST SETUP..... 19

 4.1.7 EUT OPERATING CONDITION 19

 4.1.8 TEST RESULTS 20

4.2 CONDUCTED EMISSION MEASUREMENT..... 54

 4.2.1 LIMITS OF CONDUCTED EMISSION MEASUREMENT 54

 4.2.2 TEST INSTRUMENTS..... 54

 4.2.3 TEST PROCEDURES 54

 4.2.4 DEVIATION FROM TEST STANDARD 55

 4.2.5 TEST SETUP..... 55

 4.2.6 EUT OPERATING CONDITIONS 55

 4.2.7 TEST RESULTS 56

4.3 PEAK TRANSMIT POWER MEASUREMENT 58

 4.3.1 LIMITS OF PEAK TRANSMIT POWER MEASUREMENT 58



4.3.2	TEST SETUP	58
4.3.3	TEST INSTRUMENTS.....	59
4.3.4	TEST PROCEDURE.....	59
4.3.5	DEVIATION FROM TEST STANDARD	59
4.3.6	EUT OPERATING CONDITIONS	59
4.3.7	TEST RESULTS	60
4.4	PEAK POWER SPECTRAL DENSITY MEASUREMENT.....	64
4.4.1	LIMITS OF PEAK POWER SPECTRAL DENSITY MEASUREMENT	64
4.4.2	TEST SETUP.....	64
4.4.3	TEST INSTRUMENTS.....	64
4.4.4	TEST PROCEDURES	64
4.4.5	DEVIATION FROM TEST STANDARD	65
4.4.6	EUT OPERATING CONDITIONS	65
4.4.7	TEST RESULTS	66
4.5	FREQUENCY STABILITY	69
4.5.1	LIMITS OF FREQUENCY STABILITY MEASUREMENT	69
4.5.2	TEST SETUP.....	69
4.5.3	TEST INSTRUMENTS.....	69
4.5.4	TEST PROCEDURE.....	70
4.5.5	DEVIATION FROM TEST STANDARD	70
4.5.6	EUT OPERATING CONDITION	70
4.5.7	TEST RESULTS	71
5	PHOTOGRAPHS OF THE TEST CONFIGURATION	72
6	APPENDIX A – MODIFICATIONS RECORDERS FOR ENGINEERING CHANGES TO THE EUT BY THE LAB.....	73



**BUREAU
VERITAS**

Test Report No.: RF140801N015-5

RELEASE CONTROL RECORD

ISSUE NO.	REASON FOR CHANGE	DATE ISSUED
RF140801N015-5	Original release	Aug. 05, 2014



1 SUMMARY OF TEST RESULTS

The EUT has been tested according to the following specifications:

APPLIED STANDARD: FCC PART 15, SUBPART E (SECTION 15.407)			
STANDARD SECTION	TEST TYPE AND LIMIT	RESULT	REMARK
15.407(b)(5)	AC Power Conducted Emission	PASS	Meet the requirement of limit. Minimum passing margin is -11.06dB at 0.63856MHz.
15.407(b/1/2/3)(b)(5)	Electric Field Strength Spurious Emissions, 30MHz ~ 40000MHz	PASS	Meet the requirement of limit. Minimum passing margin is -3.1dB at 5725MHz.
15.407(a/1/2/3)	Peak Transmit Power	PASS	Meet the requirement of limit.
15.407(a/1/2/3)	Peak Power Spectral Density	PASS	Meet the requirement of limit.
15.407(g)	Frequency Stability	PASS	Meet the requirement of limit.
15.203	Antenna Requirement	PASS	No antenna connector is used

2 MEASUREMENT UNCERTAINTY

Where relevant, the following measurement uncertainty levels have been estimated for tests performed on the EUT as specified in CISPR 16-4-2:

MEASUREMENT	FREQUENCY	UNCERTAINTY
Conducted emissions	9kHz~30MHz	2.66dB
Radiated emissions	9KHz ~ 30MHz	2.74dB
	30MHz ~ 1GMHz	4.06dB
	1GHz ~ 18GHz	4.58dB
	18GHz ~ 40GHz	1.94dB

This uncertainty represents an expanded uncertainty expressed at approximately the 95% confidence level using a coverage factor of k = 2.



3 GENERAL INFORMATION

3.1 GENERAL DESCRIPTION OF EUT

EUT	LTE Smartphone
MODEL NO.	XP7700
Type Number	L12V012AA;L13V012AA
FCC ID	WYPL11V012AA
POWER SUPPLY	5.0Vdc (adapter or host equipment) 3.8Vdc (Li-ion battery)
MODULATION TYPE	64QAM, 16QAM, QPSK, BPSK
MODULATION TECHNOLOGY	OFDM
TRANSFER RATE	802.11a: 54.0/ 48.0/ 36.0/ 24.0/ 18.0/ 12.0/ 9.0/ 6.0Mbps 802.11n: up to MCS7
OPERATING FREQUENCY	5180 ~ 5240MHz, 5260 ~ 5320MHz 5500 ~ 5700MHz, 5745 ~ 5805MHz
NUMBER OF CHANNEL	5180 ~ 5240MHz: 4 for 802.11a, 802.11n (20MHz) 2 for 802.11n (40MHz) 5260 ~ 5320MHz: 4 for 802.11a, 802.11n (20MHz) 2 for 802.11n (40MHz) 5500 ~ 5700MHz: 8 for 802.11a, 802.11n (20MHz) 3 for 802.11n (40MHz) 5745 ~ 5805MHz: 4 for 802.11a, 802.11n (20MHz) 2 for 802.11n (40MHz)
OUTPUT POWER	47.315mW for 5180 ~ 5240MHz 68.234mW for 5260 ~ 5320MHz 87.297mW for 5500 ~ 5700MHz 80.353mW for 5745 ~ 5805MHz
ANTENNA TYPE	5180 ~ 5240MHz: PCB antenna with 0.8dBi gain 5260 ~ 5320MHz: PCB antenna with 1.3dBi gain 5500 ~ 5700MHz: PCB antenna with 1.0dBi gain 5745 ~ 5805MHz: PCB antenna with -1.0dBi gain
DATA CABLE	USB cable: Unshielded, detachable, 1.1m Earphone cable: Unshielded, Detachable, 1.2m
I/O PORTS	Refer to user's manual



NOTE:

1. The EUT incorporates a SISO function. Physically, the EUT provides one completed transmitters and one receivers.

MODULATION MODE	TX FUNCTION
802.11a	1TX/1RX
802.11n (20MHz)	1TX/1RX
802.11n (40MHz)	1TX/1RX

2. The EUT consumes power from the following adapters:

Adapter	
BRAND:	Sonim
MODEL:	S11C02
INPUT:	AC 100-240V, 50/60Hz,450mA
OUTPUT:	DC 5V, 2100mA
DC LINE:	N/A

3. The above EUT information is declared by manufacturer and for more detailed features description, please refer to the manufacturer's specifications or user's manual.



3.2 DESCRIPTION OF TEST MODES

FOR 5150 ~ 5250MHz

4 channels are provided for 802.11a, 802.11n (20MHz):

CHANNEL	FREQUENCY	CHANNEL	FREQUENCY
36	5180 MHz	44	5220 MHz
40	5200 MHz	48	5240 MHz

2 channels are provided for 802.11n (40MHz):

CHANNEL	FREQUENCY	CHANNEL	FREQUENCY
38	5190 MHz	46	5230 MHz

FOR 5250 ~ 5350MHz

4 channels are provided for 802.11a, 802.11n (20MHz):

CHANNEL	FREQUENCY	CHANNEL	FREQUENCY
52	5260 MHz	60	5300 MHz
56	5280 MHz	64	5320 MHz

2 channels are provided for 802.11n (40MHz):

CHANNEL	FREQUENCY	CHANNEL	FREQUENCY
54	5270 MHz	62	5310 MHz



FOR 5470 ~ 5725MHz

8 channels are provided for 802.11a, 802.11n (20MHz):

CHANNEL	FREQUENCY	CHANNEL	FREQUENCY
100	5500 MHz	116	5580 MHz
104	5520 MHz	132	5660 MHz
108	5540 MHz	136	5680 MHz
112	5560 MHz	140	5700 MHz

3 channels are provided for 802.11n (40MHz):

CHANNEL	FREQUENCY	CHANNEL	FREQUENCY
102	5510 MHz	134	5670 MHz
110	5550 MHz		

FOR 5725 ~ 5850MHz

4 channels are provided for 802.11a, 802.11n (20MHz):

CHANNEL	FREQUENCY	CHANNEL	FREQUENCY
149	5745MHz	161	5805MHz
153	5765MHz		
157	5785MHz		

2 channels are provided for 802.11n (40MHz):

CHANNEL	FREQUENCY	CHANNEL	FREQUENCY
151	5755MHz	159	5795MHz



3.2.1 TEST MODE APPLICABILITY AND TESTED CHANNEL DETAIL

EUT CONFIGURE MODE	APPLICABLE TO				DESCRIPTION
	RE≥1G	RE<1G	PLC	APCM	
A	√	√	√	-	Powered by Adapter with wifi(5G) link
B	-	-	-	√	Powered by Battery with wifi(5G) link
C	-	-	-	-	Powered by USB with wifi(5G) link

Where **RE≥1G**: Radiated Emission above 1GHz **RE<1G**: Radiated Emission below 1GHz
PLC: Power Line Conducted Emission **APCM**: Antenna Port Conducted Measurement

NOTE:
The EUT had been pre-tested on the positioned of each 3 axis. The worst case was found when positioned on **Y-plane**.
NOTE: "-" means no effect.

RADIATED EMISSION TEST (ABOVE 1GHz):

- Pre-Scan has been conducted to determine the worst-case mode from all possible combinations between available modulations, data rates and antenna ports (if EUT with antenna diversity architecture).
- Following channel(s) was (were) selected for the final test as listed below.

EUT CONFIGURE MODE	MODE	FREQ. BAND (MHz)	AVAILABLE CHANNEL	TESTED CHANNEL	MODULATION TECHNOLOGY	MODULATION TYPE	DATA RATE (Mbps)
A	802.11a	5180-5240	36 to 48	36, 40, 48	OFDM	BPSK	6.0
A	802.11n (20MHz)		36 to 48	36, 40, 48	OFDM	BPSK	MCS0
A	802.11n (40MHz)		38 to 46	38, 46	OFDM	BPSK	MCS0
A	802.11a	5260-5320	52 to 64	52, 60, 64	OFDM	BPSK	6.0
A	802.11n (20MHz)		52 to 64	52, 60, 64	OFDM	BPSK	MCS0
A	802.11n (40MHz)		54 to 62	54, 62	OFDM	BPSK	MCS0
A	802.11a	5500-5700	100 to 140	100, 116, 140	OFDM	BPSK	6.0
A	802.11n (20MHz)		100 to 140	100, 116, 140	OFDM	BPSK	MCS0
A	802.11n (40MHz)		102 to 134	102, 110, 134	OFDM	BPSK	MCS0
A	802.11a	5725-5805	149 to 161	149, 157, 161	OFDM	BPSK	6.0
A	802.11n (20MHz)		149 to 161	149, 157, 161	OFDM	BPSK	MCS0
A	802.11n (40MHz)		151 to 159	151, 159	OFDM	BPSK	MCS0

RADIATED EMISSION TEST (BELOW 1GHz):

- Pre-Scan has been conducted to determine the worst-case mode from all possible combinations between available modulations, data rates and antenna ports (if EUT with antenna diversity architecture).
- Following channel(s) was (were) selected for the final test as listed below.

EUT CONFIGURE MODE	MODE	FREQ. BAND (MHz)	AVAILABLE CHANNEL	TESTED CHANNEL	MODULATION TECHNOLOGY	MODULATION TYPE	DATA RATE (Mbps)
A	802.11a	5180-5320	36 to 64	36	OFDM	BPSK	6.0



POWER LINE CONDUCTED EMISSION TEST:

- Pre-Scan has been conducted to determine the worst-case mode from all possible combinations between available modulations, data rates and antenna ports (if EUT with antenna diversity architecture).
- Following channel(s) was (were) selected for the final test as listed below.

EUT CONFIGURE MODE	MODE	FREQ. BAND (MHz)	AVAILABLE CHANNEL	TESTED CHANNEL	MODULATION TECHNOLOGY	MODULATION TYPE	DATA RATE (Mbps)
A	802.11a	5180-5320	36 to 64	36	OFDM	BPSK	6.0

BANDEDGE MEASUREMENT:

- Pre-Scan has been conducted to determine the worst-case mode from all possible combinations between available modulations, data rates and antenna ports (if EUT with antenna diversity architecture).
- Following channel(s) was (were) selected for the final test as listed below.

EUT CONFIGURE MODE	MODE	FREQ. BAND (MHz)	AVAILABLE CHANNEL	TESTED CHANNEL	MODULATION TECHNOLOGY	MODULATION TYPE	DATA RATE (Mbps)
A	802.11a	5180-5240	36 to 48	36, 48	OFDM	BPSK	6.0
A	802.11n (20MHz)		36 to 48	36, 48	OFDM	BPSK	MCS0
A	802.11n (40MHz)		38 to 46	38, 46	OFDM	BPSK	MCS0
A	802.11a	5260-5320	52 to 64	52, 64	OFDM	BPSK	6.0
A	802.11n (20MHz)		52 to 64	52, 64	OFDM	BPSK	MCS0
A	802.11n (40MHz)		54 to 62	54, 62	OFDM	BPSK	MCS0
A	802.11a	5500-5700	100 to 140	100, 140	OFDM	BPSK	6.0
A	802.11n (20MHz)		100 to 140	100, 140	OFDM	BPSK	MCS0
A	802.11n (40MHz)		102 to 134	102, 134	OFDM	BPSK	MCS0
A	802.11a	5725-5805	149 to 161	149, 161	OFDM	BPSK	6.0
A	802.11n (20MHz)		149 to 161	149, 161	OFDM	BPSK	MCS0
A	802.11n (40MHz)		151 to 159	151, 159	OFDM	BPSK	MCS0



ANTENNA PORT CONDUCTED MEASUREMENT:

- This item includes all test value of each mode, but only includes spectrum plot of worst value of each mode.
- Pre-Scan has been conducted to determine the worst-case mode from all possible combinations between available modulations, data rates and antenna ports (if EUT with antenna diversity architecture).
- Following channel(s) was (were) selected for the final test as listed below.

EUT CONFIGURE MODE	MODE	FREQ. BAND (MHz)	AVAILABLE CHANNEL	TESTED CHANNEL	MODULATION TECHNOLOGY	MODULATION TYPE	DATA RATE (Mbps)
B	802.11a	5180-5240	36 to 48	36, 40, 48	OFDM	BPSK	6.0
B	802.11n (20MHz)		36 to 48	36, 40, 48	OFDM	BPSK	MCS0
B	802.11n (40MHz)		38 to 46	38, 46	OFDM	BPSK	MCS0
B	802.11a	5260-5320	52 to 64	52, 60, 64	OFDM	BPSK	6.0
B	802.11n (20MHz)		52 to 64	52, 60, 64	OFDM	BPSK	MCS0
B	802.11n (40MHz)		54 to 62	54, 62	OFDM	BPSK	MCS0
B	802.11a	5500-5700	100 to 140	100, 116, 140	OFDM	BPSK	6.0
B	802.11n (20MHz)		100 to 140	100, 116, 140	OFDM	BPSK	MCS0
B	802.11n (40MHz)		102 to 134	102, 110, 134	OFDM	BPSK	MCS0
B	802.11a	5725-5805	149 to 161	149, 157, 161	OFDM	BPSK	6.0
B	802.11n (20MHz)		149 to 161	149, 157, 161	OFDM	BPSK	MCS0
B	802.11n (40MHz)		151 to 159	151, 159	OFDM	BPSK	MCS0

TEST CONDITION:

APPLICABLE TO	ENVIRONMENTAL CONDITIONS	INPUT POWER	TESTED BY
RE<1G	23deg. C, 62%RH	DC 5V By Adapter	Blue Zheng
RE≥1G	23deg. C, 62%RH	DC 5V By Adapter	Blue Zheng
PLC	24deg. C, 61%RH	DC 5V By Adapter	Eric
APCM	23.5deg. C, 60%RH	DC 3.8V By battery	Venless Long



3.3 DUTY CYCLE OF TEST SIGNAL

Duty cycle of test signal is < 98%, duty factor shall be considered.

802.11a: Duty cycle = 1.365/1.563 = 0.873, Duty factor = 10 * log(1/0.873) = 0.59

802.11n (20MHz): Duty cycle = 1.27/1.475 = 0.861, Duty factor = 10 * log(1/0.861) = 0.65

802.11n (40MHz): Duty cycle = 635/835 = 0.76, Duty factor = 10 * log(1/0.76) = 1.19

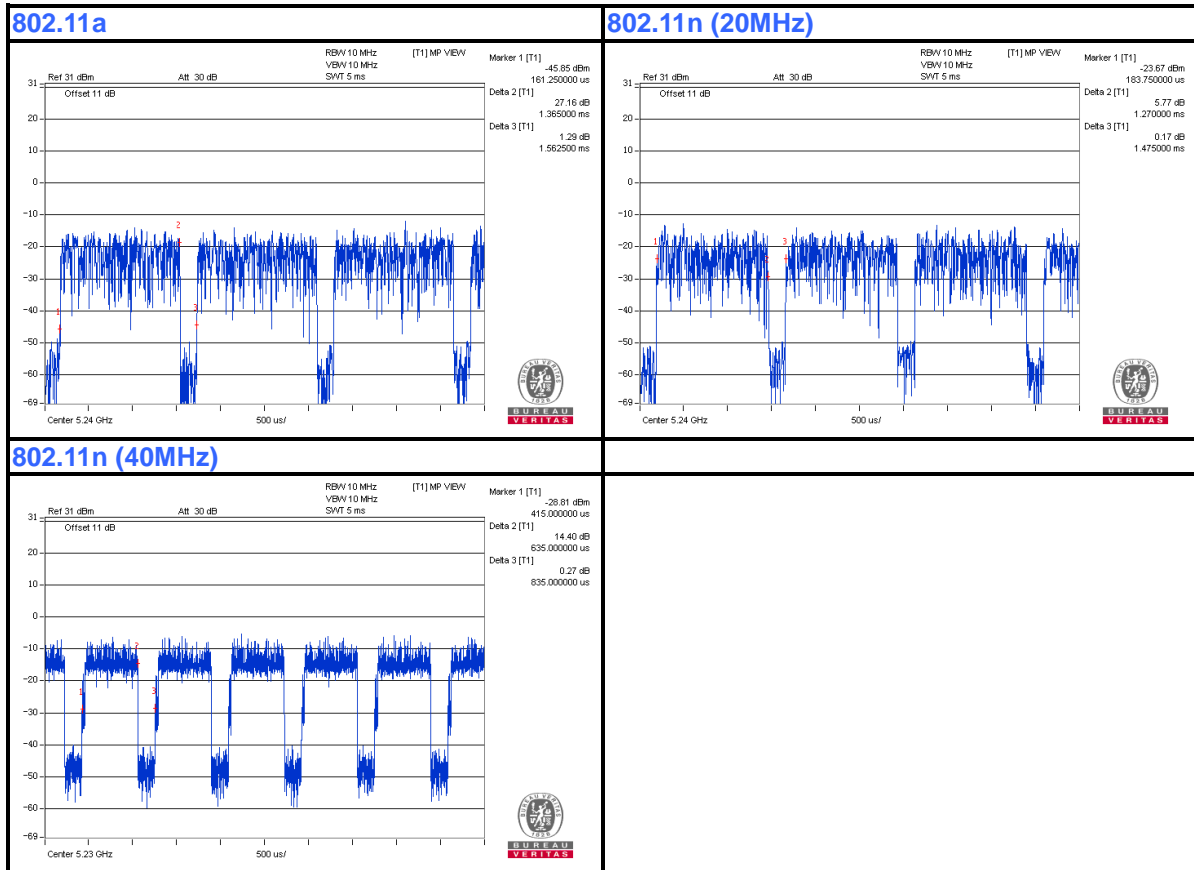



3.4 DESCRIPTION OF SUPPORT UNITS

The EUT has been tested as an independent unit together with other necessary accessories or support units. The following support units or accessories were used to form a representative test configuration during the tests.

NO.	PRODUCT	BRAND	MODEL NO.	SERIAL NO.	FCC ID
1	DC source	LONG WEI	PS-6403D	010934269	N/A
2	Notebook	HP	4431s	CNU238944Z	N/A

NO.	SIGNAL CABLE DESCRIPTION OF THE ABOVE SUPPORT UNITS
1	DC Line: Unshielded, Detachable 1.0m
2	AC Line: Unshielded, Detachable 1.5m



3.4.1 CONFIGURATION OF SYSTEM UNDER TEST

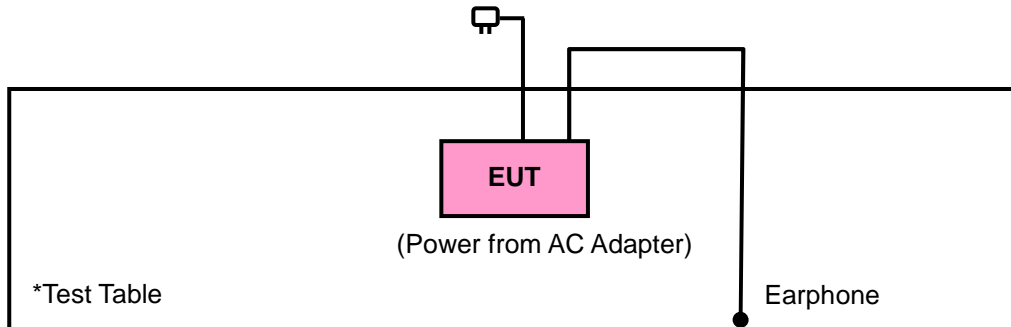

3.5 GENERAL DESCRIPTION OF APPLIED STANDARDS

The EUT is a RF Product. According to the specifications of the manufacturer, it must comply with the requirements of the following standards:

FCC Part 15, Subpart E (15.407)

KDB 905462 _Section 15.407 UNII Test Procedures

ANSI C63.10-2009

All test items have been performed and recorded as per the above standards.

NOTE: The EUT is also considered as a kind of computer peripheral, because the connection to computer is necessary for typical use. It has been verified to comply with the requirements of FCC Part 15, Subpart B, Class B (DoC). The test report has been issued separately.



4. TEST TYPES AND RESULTS

4.1 RADIATED EMISSION AND BANDEDGE MEASUREMENT

4.1.1 LIMITS OF RADIATED EMISSION AND BANDEDGE MEASUREMENT

Radiated emissions which fall in the restricted bands must comply with the radiated emission limits specified as below table:

FREQUENCIES (MHz)	FIELD STRENGTH (microvolts/meter)	MEASUREMENT DISTANCE (meters)
0.009 ~ 0.490	2400/F(kHz)	300
0.490 ~ 1.705	24000/F(kHz)	30
1.705 ~ 30.0	30	30
30 ~ 88	100	3
88 ~ 216	150	3
216 ~ 960	200	3
Above 960	500	3

NOTE:

1. The lower limit shall apply at the transition frequencies.
2. Emission level (dBuV/m) = 20 log Emission level (uV/m).
3. For frequencies above 1000MHz, the field strength limits are based on average detector, however, the peak field strength of any emission shall not exceed the maximum permitted average limits, specified above by more than 20dB under any condition of modulation.

4.1.2 LIMITS OF UNWANTED EMISSION OUT OF THE RESTRICTED BANDS

APPLICABLE TO	LIMIT	
	FIELD STRENGTH AT 3m (dBµV/m)	
	PK	AV
	74	54
√	EIRP LIMIT (dBm)	
	EQUIVALENT FIELD STRENGTH AT 3m (dBµV/m)	
	PK	PK
	-27	68.3

NOTE: The following formula is used to convert the equipment isotropic radiated power (eirp) to field strength:

$$E = \frac{1000000\sqrt{30P}}{3} \mu\text{V/m, where P is the eirp (Watts).}$$

**4.1.3 TEST INSTRUMENTS**

Equipment	Manufacturer	Model No.	Serial No.	Last Cal.	Next Cal.
Spectrum Analyzer	Agilent	E4446A	MY46180622	Apr. 29,14	Apr. 28,15
EMI Test Receiver	Rohde&Schwarz	ESVS10	841431/004	May 17,14	May 16,15
Loop antenna (9kHz~30MHz)	Daze	ZN30900A	0708	Dec. 05,13	Dec. 04,14
Bilog Antenna (20MHz -2GHz)	Teseq	CBL 6111D	30643	Jul. 27, 14	Jul. 26, 15
Horn Antenna (1GHz -18GHz)	ETS -Lindgren	3117	00062558	Oct. 18, 13	Oct. 17, 14
Horn Antenna (15GHz-40GHz)	SCHWARZBECK	BBHA 9170	BBHA9170242	Feb. 13,14	Feb. 12,15
Pre-Amplifier (9kHz~1GHz)	SONOMA	310D	186955	Mar. 05,14	Mar. 04,15
Signal Amplifier	Agilent	8447D	2944A10488	Jun. 25,14	Jun. 24,15
Pre-Amplifier (100MHz-26.5GHz)	Agilent	8449B	3008A00409	May 13,14	May 12,15
Pre-Amplifier (18GHz-40GHz)	EMCI	EMC 184045	980102	Nov. 04,13	Nov. 03,14
3m Semi-anechoic Chamber	ETS-LINDGREN	9m*6m*6m	NSEMC003	Apr. 19,14	Apr. 18,15
Digital Multimeter	FLUKE	15B	A1220010DG	Oct. 30, 13	Oct. 29, 14
Test Software	ADT	ADT_Radiated _V7.6.15.9.2	N/A	N/A	N/A

NOTE:

1. The calibration interval of the above test instruments is 12 months and the calibrations are traceable to CEPREI/CHINA, GRGT/CHINA and NIM/CHINA.
2. The test was performed in 966 Chamber.
3. The FCC Site Registration No. is 502831.



4.1.4 TEST PROCEDURES

- a. The EUT was placed on the top of a rotating table 0.8 meters above the ground at a 3 meter semi-anechoic chamber. The table was rotated 360 degrees to determine the position of the highest radiation.
- b. The EUT was set 3 meters away from the interference-receiving antenna, which was mounted on the top of a variable-height antenna tower.
- c. The antenna is a broadband antenna, and its height is varied from one meter to four meters above the ground to determine the maximum value of the field strength. Both horizontal and vertical polarizations of the antenna are set to make the measurement.
- d. For each suspected emission, the EUT was arranged to its worst case and then the antenna was tuned to heights from 1 meter to 4 meters and the rotatable table was turned from 0 degrees to 360 degrees to find the maximum reading.
- e. The test-receiver system was set to Peak Detect Function and Specified Bandwidth with Maximum Hold Mode.
- f. If the emission level of the EUT in peak mode was 10dB lower than the limit specified, then testing could be stopped and the peak values of the EUT would be reported. Otherwise the emissions that did not have 10dB margin would be re-tested one by one using peak, quasi-peak or average method as specified and then reported in a data sheet.

NOTE:

1. The resolution bandwidth and video bandwidth of test receiver/spectrum analyzer is 120kHz for Peak detection (PK) and Quasi-peak detection (QP) at frequency below 1GHz.
2. The resolution bandwidth of test receiver/spectrum analyzer is 1MHz and video bandwidth is 3MHz for Peak detection at frequency above 1GHz.
3. The resolution bandwidth of test receiver/spectrum analyzer is 1MHz and the video bandwidth is 10Hz for Average detection (AV) at frequency above 1GHz.
4. All modes of operation were investigated and the worst-case emissions are reported.

4.1.5 DEVIATION FROM TEST STANDARD

No deviation.



4.1.6 TEST SETUP

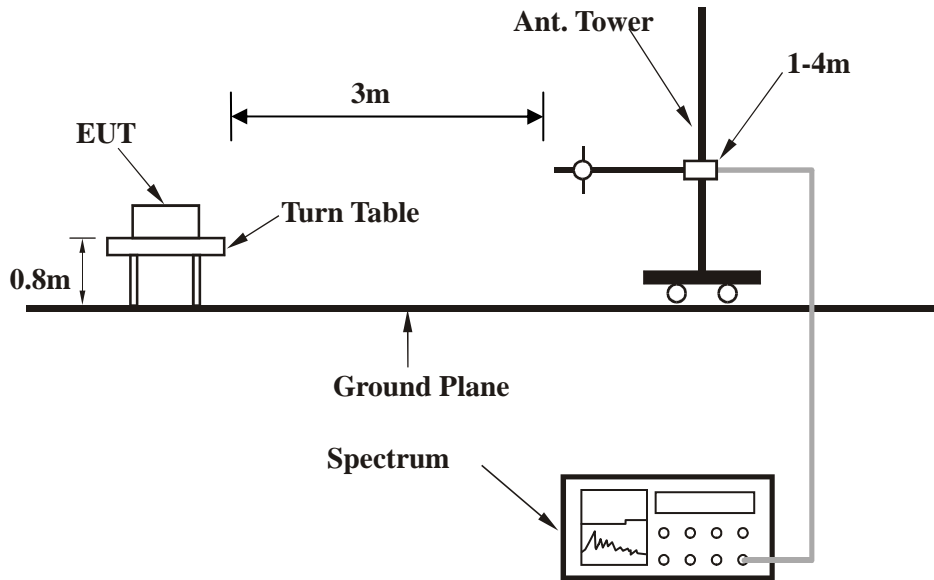

For the actual test configuration, please refer to the attached file (Test Setup Photo).

4.1.7 EUT OPERATING CONDITION

- Set the EUT under full load condition and placed them on a testing table.
- Set the transmitter part of EUT under transmission condition continuously at specific channel frequency.
- The necessary accessories enable the EUT in full functions.



4.1.8 TEST RESULTS

BELOW 1GHz WORST-CASE DATA:

802.11a

CHANNEL	Channel 36	DETECTOR FUNCTION	Quasi-Peak (QP)
FREQUENCY RANGE	30MHz ~ 1GHz		

ANTENNA POLARITY & TEST DISTANCE: HORIZONTAL AT 3 M								
NO.	FREQ. (MHz)	EMISSION LEVEL (dBuV/m)	LIMIT (dBuV/m)	MARGIN (dB)	ANTENNA HEIGHT (m)	TABLE ANGLE (Degree)	RAW VALUE (dBuV)	CORRECTION FACTOR (dB/m)
1	233.70	32.1 QP	46.0	-13.9	1.00 H	31	19.11	13.01
2	275.73	31.5 QP	46.0	-14.5	1.00 H	20	15.95	15.56
3	309.68	32.7 QP	46.0	-13.3	1.00 H	6	15.90	16.81
4	346.87	30.3 QP	46.0	-15.7	1.00 H	44	12.90	17.37
5	414.77	26.0 QP	46.0	-20.0	1.00 H	56	5.47	20.52
6	576.43	29.8 QP	46.0	-16.2	1.00 H	67	5.28	24.55

REMARKS:

1. Emission level (dBuV/m) = Raw Value (dBuV) + Correction Factor (dB/m).
2. Correction Factor (dB/m) = Antenna Factor (dB/m) + Cable Factor (dB).
3. The other emission levels were very low against the limit.
4. Margin value = Emission level – Limit value.

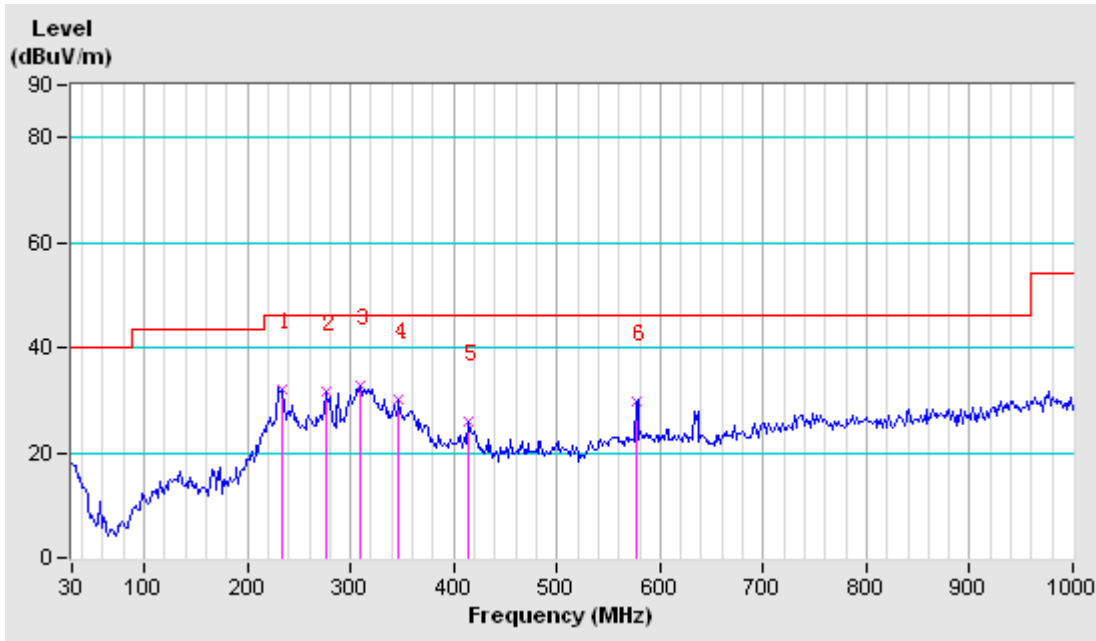



CHANNEL	Channel 36	DETECTOR FUNCTION	Quasi-Peak (QP)
FREQUENCY RANGE	30MHz ~ 1GHz		

ANTENNA POLARITY & TEST DISTANCE: VERTICAL AT 3 M								
NO.	FREQ. (MHz)	EMISSION LEVEL (dBuV/m)	LIMIT (dBuV/m)	MARGIN (dB)	ANTENNA HEIGHT (m)	TABLE ANGLE (Degree)	RAW VALUE (dBuV)	CORRECTION FACTOR (dB/m)
1	105.98	26.6 QP	43.5	-16.9	1.00 V	127	14.00	12.61
2	122.15	24.2 QP	43.5	-19.3	1.00 V	67	10.57	13.67
3	181.97	32.3 QP	43.5	-11.2	1.00 V	116	21.16	11.12
4	241.78	34.1 QP	46.0	-11.9	1.00 V	105	20.33	13.79
5	291.90	31.3 QP	46.0	-14.7	1.00 V	94	15.49	15.83
6	500.45	28.3 QP	46.0	-17.7	1.00 V	83	5.77	22.49

REMARKS:

1. Emission level (dBuV/m) = Raw Value (dBuV) + Correction Factor (dB/m).
2. Correction Factor (dB/m) = Antenna Factor (dB/m) + Cable Factor (dB).
3. The other emission levels were very low against the limit.
4. Margin value = Emission level – Limit value.

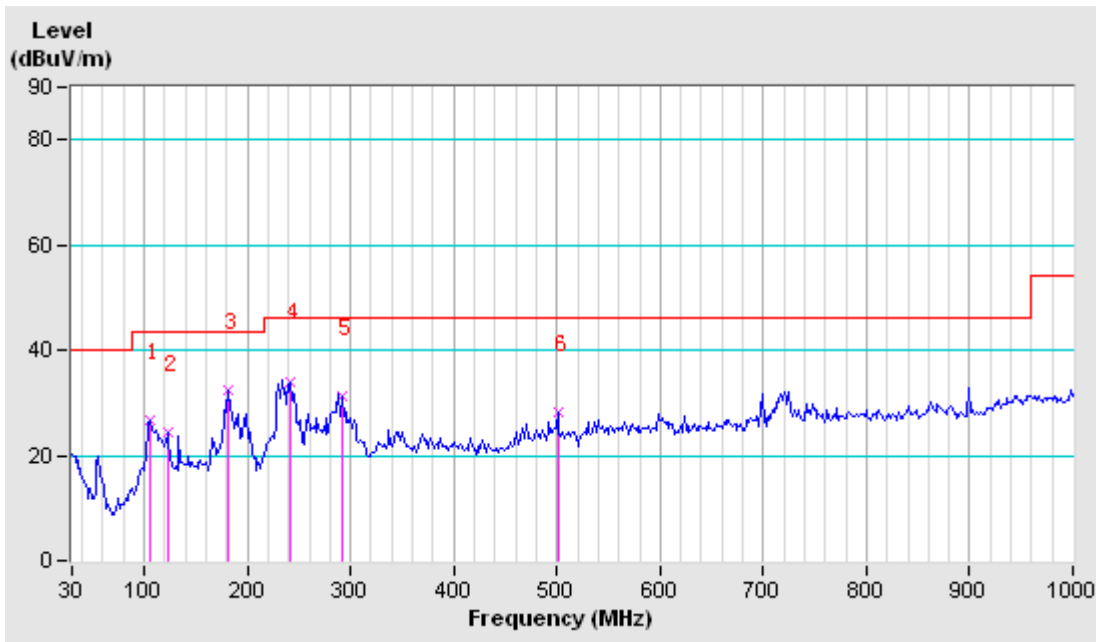



ABOVE 1GHz WORST-CASE DATA: Band 1

802.11a

CHANNEL	TX Channel 36	DETECTOR FUNCTION	Peak (PK)
FREQUENCY RANGE	1GHz ~ 40GHz		Average (AV)

ANTENNA POLARITY & TEST DISTANCE: HORIZONTAL AT 3 M								
NO.	FREQ. (MHz)	EMISSION LEVEL (dBuV/m)	LIMIT (dBuV/m)	MARGIN (dB)	ANTENNA HEIGHT (m)	TABLE ANGLE (Degree)	RAW VALUE (dBuV)	CORRECTION FACTOR (dB/m)
1	5150.00	66.7 PK	74.0	-7.3	1.14 H	360	27.01	39.65
2	5150.00	42.6 AV	54.0	-11.4	1.14 H	360	2.97	39.65
3	*5180.00	104.5 PK			1.14 H	360	64.82	39.70
4	*5180.00	86.4 AV			1.14 H	360	46.73	39.70
5	#10360.00	53.3 PK	74.0	-20.7	1.00 H	100	7.31	45.98
6	#10360.00	40.3 AV	54.0	-13.8	1.00 H	100	-5.73	45.98
ANTENNA POLARITY & TEST DISTANCE: VERTICAL AT 3 M								
NO.	FREQ. (MHz)	EMISSION LEVEL (dBuV/m)	LIMIT (dBuV/m)	MARGIN (dB)	ANTENNA HEIGHT (m)	TABLE ANGLE (Degree)	RAW VALUE (dBuV)	CORRECTION FACTOR (dB/m)
1	5150.00	61.6 PK	74.0	-12.4	1.13 V	0	21.97	39.65
2	5150.00	46.1 AV	54.0	-7.9	1.13 V	0	6.44	39.65
3	*5180.00	103.8 PK			1.13 V	0	64.07	39.70
4	*5180.00	86.6 AV			1.13 V	0	46.87	39.70
5	#10360.00	53.2 PK	74.0	-20.8	1.00 V	360	7.21	45.98
6	#10360.00	40.2 AV	54.0	-13.9	1.00 V	360	-5.83	45.98

REMARKS:

1. Emission level (dBuV/m) = Raw Value (dBuV) + Correction Factor (dB/m).
2. Correction Factor (dB/m) = Antenna Factor (dB/m) + Cable Factor (dB).
3. The other emission levels were very low against the limit.
4. Margin value = Emission level – Limit value.
5. " * ": Fundamental frequency.
6. " # ": The radiated frequency is out of the restricted band.



CHANNEL	TX Channel 44	DETECTOR FUNCTION	Peak (PK)
FREQUENCY RANGE	1GHz ~ 40GHz		Average (AV)

ANTENNA POLARITY & TEST DISTANCE: HORIZONTAL AT 3 M								
NO.	FREQ. (MHz)	EMISSION LEVEL (dBuV/m)	LIMIT (dBuV/m)	MARGIN (dB)	ANTENNA HEIGHT (m)	TABLE ANGLE (Degree)	RAW VALUE (dBuV)	CORRECTION FACTOR (dB/m)
1	*5220.00	105.3 PK			1.28 H	360	65.53	39.76
2	*5220.00	86.7 AV			1.28 H	360	46.96	39.76
3	#10440.00	52.0 PK	74.0	-22.0	1.00 H	0	5.85	46.15
4	#10440.00	39.4 AV	54.0	-14.6	1.00 H	0	-6.76	46.15
ANTENNA POLARITY & TEST DISTANCE: VERTICAL AT 3 M								
NO.	FREQ. (MHz)	EMISSION LEVEL (dBuV/m)	LIMIT (dBuV/m)	MARGIN (dB)	ANTENNA HEIGHT (m)	TABLE ANGLE (Degree)	RAW VALUE (dBuV)	CORRECTION FACTOR (dB/m)
1	*5220.00	101.7 PK			1.00 V	3	61.96	39.76
2	*5220.00	84.3 AV			1.00 V	3	44.56	39.76
3	#10440.00	52.0 PK	74.0	-22.0	1.00 V	0	5.81	46.15
4	#10440.00	38.1 AV	54.0	-15.9	1.00 V	0	-8.06	46.15

REMARKS:

1. Emission level (dBuV/m) = Raw Value (dBuV) + Correction Factor (dB/m).
2. Correction Factor (dB/m) = Antenna Factor (dB/m) + Cable Factor (dB).
3. The other emission levels were very low against the limit.
4. Margin value = Emission level – Limit value.
5. " * ": Fundamental frequency.
6. " # ": The radiated frequency is out of the restricted band.



CHANNEL	TX Channel 48	DETECTOR FUNCTION	Peak (PK)
FREQUENCY RANGE	1GHz ~ 40GHz		Average (AV)

ANTENNA POLARITY & TEST DISTANCE: HORIZONTAL AT 3 M								
NO.	FREQ. (MHz)	EMISSION LEVEL (dBuV/m)	LIMIT (dBuV/m)	MARGIN (dB)	ANTENNA HEIGHT (m)	TABLE ANGLE (Degree)	RAW VALUE (dBuV)	CORRECTION FACTOR (dB/m)
1	*5240.00	105.4 PK			1.29 H	0	65.61	39.79
2	*5240.00	86.9 AV			1.29 H	0	47.06	39.79
3	#10480.00	51.7 PK	74.0	-22.3	1.00 H	360	5.47	46.23
4	#10480.00	37.2 AV	54.0	-16.8	1.00 H	360	-9.05	46.23
ANTENNA POLARITY & TEST DISTANCE: VERTICAL AT 3 M								
NO.	FREQ. (MHz)	EMISSION LEVEL (dBuV/m)	LIMIT (dBuV/m)	MARGIN (dB)	ANTENNA HEIGHT (m)	TABLE ANGLE (Degree)	RAW VALUE (dBuV)	CORRECTION FACTOR (dB/m)
1	*5240.00	101.3 PK			1.00 V	360	61.50	39.79
2	*5240.00	84.2 AV			1.00 V	360	44.38	39.79
3	#10480.00	52.3 PK	74.0	-21.7	1.00 V	360	6.10	46.23
4	#10480.00	37.2 AV	54.0	-16.8	1.00 V	360	-9.03	46.23

REMARKS:

1. Emission level (dBuV/m) = Raw Value (dBuV) + Correction Factor (dB/m).
2. Correction Factor (dB/m) = Antenna Factor (dB/m) + Cable Factor (dB).
3. The other emission levels were very low against the limit.
4. Margin value = Emission level – Limit value.
5. " * ": Fundamental frequency.
6. " # ": The radiated frequency is out of the restricted band.



802.11n (20MHz)

CHANNEL	TX Channel 36	DETECTOR FUNCTION	Peak (PK)
FREQUENCY RANGE	1GHz ~ 40GHz		Average (AV)

ANTENNA POLARITY & TEST DISTANCE: HORIZONTAL AT 3 M								
NO.	FREQ. (MHz)	EMISSION LEVEL (dBuV/m)	LIMIT (dBuV/m)	MARGIN (dB)	ANTENNA HEIGHT (m)	TABLE ANGLE (Degree)	RAW VALUE (dBuV)	CORRECTION FACTOR (dB/m)
1	5150.00	60.9 PK	74.0	-13.1	1.14 H	360	21.21	39.65
2	5150.00	43.4 AV	54.0	-10.6	1.14 H	360	3.79	39.65
3	*5180.00	104.1 PK			1.14 H	360	64.36	39.70
4	*5180.00	86.2 AV			1.14 H	360	46.46	39.70
5	#10420.00	52.3 PK	74.0	-21.7	1.14 H	0	6.19	46.11
6	#10420.00	40.3 AV	54.0	-13.7	1.14 H	0	-5.81	46.11
ANTENNA POLARITY & TEST DISTANCE: VERTICAL AT 3 M								
NO.	FREQ. (MHz)	EMISSION LEVEL (dBuV/m)	LIMIT (dBuV/m)	MARGIN (dB)	ANTENNA HEIGHT (m)	TABLE ANGLE (Degree)	RAW VALUE (dBuV)	CORRECTION FACTOR (dB/m)
1	5150.00	58.0 PK	74.0	-16.0	1.13 V	0	18.34	39.65
2	5150.00	43.2 AV	54.0	-10.8	1.13 V	0	3.57	39.65
3	*5180.00	100.8 PK			1.13 V	0	61.09	39.70
4	*5180.00	84.2 AV			1.13 V	0	44.52	39.70
5	#10420.00	52.7 PK	74.0	-21.3	1.14 V	0	6.59	46.11
6	#10420.00	39.7 AV	54.0	-14.3	1.14 V	0	-6.41	46.11

REMARKS:

1. Emission level (dBuV/m) = Raw Value (dBuV) + Correction Factor (dB/m).
2. Correction Factor (dB/m) = Antenna Factor (dB/m) + Cable Factor (dB).
3. The other emission levels were very low against the limit.
4. Margin value = Emission level – Limit value.
5. " * ": Fundamental frequency.
6. " # ": The radiated frequency is out of the restricted band.



CHANNEL	TX Channel 44	DETECTOR FUNCTION	Peak (PK)
FREQUENCY RANGE	1GHz ~ 40GHz		Average (AV)

ANTENNA POLARITY & TEST DISTANCE: HORIZONTAL AT 3 M

NO.	FREQ. (MHz)	EMISSION LEVEL (dBuV/m)	LIMIT (dBuV/m)	MARGIN (dB)	ANTENNA HEIGHT (m)	TABLE ANGLE (Degree)	RAW VALUE (dBuV)	CORRECTION FACTOR (dB/m)
1	*5220.00	104.0 PK			1.28 H	360	64.22	39.76
2	*5220.00	86.0 AV			1.28 H	360	46.20	39.76
3	#10440.00	52.2 PK	74.0	-21.8	1.00 H	0	6.02	46.15
4	#10440.00	39.5 AV	54.0	-14.5	1.00 H	0	-6.65	46.15

ANTENNA POLARITY & TEST DISTANCE: VERTICAL AT 3 M

NO.	FREQ. (MHz)	EMISSION LEVEL (dBuV/m)	LIMIT (dBuV/m)	MARGIN (dB)	ANTENNA HEIGHT (m)	TABLE ANGLE (Degree)	RAW VALUE (dBuV)	CORRECTION FACTOR (dB/m)
1	*5220.00	101.2 PK			1.00 V	3	61.48	39.76
2	*5220.00	83.8 AV			1.00 V	3	44.08	39.76
3	#10440.00	52.2 PK	74.0	-21.8	1.00 V	0	6.05	46.15
4	#10440.00	38.2 AV	54.0	-15.8	1.00 V	0	-7.91	46.15

REMARKS:

1. Emission level (dBuV/m) = Raw Value (dBuV) + Correction Factor (dB/m).
2. Correction Factor (dB/m) = Antenna Factor (dB/m) + Cable Factor (dB).
3. The other emission levels were very low against the limit.
4. Margin value = Emission level – Limit value.
5. " * ": Fundamental frequency.
6. " # ": The radiated frequency is out of the restricted band.



CHANNEL	TX Channel 48	DETECTOR FUNCTION	Peak (PK)
FREQUENCY RANGE	1GHz ~ 40GHz		Average (AV)

ANTENNA POLARITY & TEST DISTANCE: HORIZONTAL AT 3 M

NO.	FREQ. (MHz)	EMISSION LEVEL (dBuV/m)	LIMIT (dBuV/m)	MARGIN (dB)	ANTENNA HEIGHT (m)	TABLE ANGLE (Degree)	RAW VALUE (dBuV)	CORRECTION FACTOR (dB/m)
1	*5240.00	104.5 PK			1.18 H	0	64.72	39.79
2	*5240.00	86.7 AV			1.18 H	0	46.94	39.79
3	#10480.00	53.3 PK	74.0	-20.7	1.00 H	360	7.04	46.23
4	#10480.00	39.6 AV	54.0	-14.4	1.00 H	360	-6.66	46.23

ANTENNA POLARITY & TEST DISTANCE: VERTICAL AT 3 M

NO.	FREQ. (MHz)	EMISSION LEVEL (dBuV/m)	LIMIT (dBuV/m)	MARGIN (dB)	ANTENNA HEIGHT (m)	TABLE ANGLE (Degree)	RAW VALUE (dBuV)	CORRECTION FACTOR (dB/m)
1	*5240.00	101.9 PK			1.00 V	350	62.11	39.79
2	*5240.00	83.3 AV			1.00 V	350	43.50	39.79
3	#10480.00	52.4 PK	74.0	-21.6	1.00 V	360	6.13	46.23
4	#10480.00	38.2 AV	54.0	-15.8	1.00 V	360	-8.00	46.23

REMARKS:

1. Emission level (dBuV/m) = Raw Value (dBuV) + Correction Factor (dB/m).
2. Correction Factor (dB/m) = Antenna Factor (dB/m) + Cable Factor (dB).
3. The other emission levels were very low against the limit.
4. Margin value = Emission level – Limit value.
5. " * ": Fundamental frequency.
6. " # ": The radiated frequency is out of the restricted band.



802.11n (40MHz)

CHANNEL	TX Channel 38	DETECTOR FUNCTION	Peak (PK)
FREQUENCY RANGE	1GHz ~ 40GHz		Average (AV)

ANTENNA POLARITY & TEST DISTANCE: HORIZONTAL AT 3 M								
NO.	FREQ. (MHz)	EMISSION LEVEL (dBuV/m)	LIMIT (dBuV/m)	MARGIN (dB)	ANTENNA HEIGHT (m)	TABLE ANGLE (Degree)	RAW VALUE (dBuV)	CORRECTION FACTOR (dB/m)
1	5150.00	69.4 PK	74.0	-4.6	1.29 H	0	29.75	39.65
2	5150.00	50.2 AV	54.0	-3.8	1.29 H	0	10.55	39.65
3	*5190.00	101.4 PK			1.29 H	0	61.71	39.71
4	*5190.00	78.4 AV			1.29 H	0	38.70	39.71
5	#10380.00	53.0 PK	74.0	-21.0	1.00 H	0	6.95	46.02
6	#10380.00	39.7 AV	54.0	-14.3	1.00 H	0	-6.36	46.02
ANTENNA POLARITY & TEST DISTANCE: VERTICAL AT 3 M								
NO.	FREQ. (MHz)	EMISSION LEVEL (dBuV/m)	LIMIT (dBuV/m)	MARGIN (dB)	ANTENNA HEIGHT (m)	TABLE ANGLE (Degree)	RAW VALUE (dBuV)	CORRECTION FACTOR (dB/m)
1	5150.00	70.6 PK	74.0	-3.4	1.13 V	0	30.95	39.65
2	5150.00	50.0 AV	54.0	-4.0	1.13 V	0	10.35	39.65
3	*5190.00	99.6 PK			1.13 V	0	59.84	39.71
4	*5190.00	77.2 AV			1.13 V	0	37.46	39.71
5	#10380.00	53.1 PK	74.0	-20.9	1.00 V	0	7.05	46.02
6	#10380.00	39.2 AV	54.0	-14.8	1.00 V	0	-6.80	46.02

REMARKS:

1. Emission level (dBuV/m) = Raw Value (dBuV) + Correction Factor (dB/m).
2. Correction Factor (dB/m) = Antenna Factor (dB/m) + Cable Factor (dB).
3. The other emission levels were very low against the limit.
4. Margin value = Emission level – Limit value.
5. " * ": Fundamental frequency.
6. " # ": The radiated frequency is out of the restricted band.



CHANNEL	TX Channel 46	DETECTOR FUNCTION	Peak (PK)
FREQUENCY RANGE	1GHz ~ 40GHz		Average (AV)

ANTENNA POLARITY & TEST DISTANCE: HORIZONTAL AT 3 M								
NO.	FREQ. (MHz)	EMISSION LEVEL (dBuV/m)	LIMIT (dBuV/m)	MARGIN (dB)	ANTENNA HEIGHT (m)	TABLE ANGLE (Degree)	RAW VALUE (dBuV)	CORRECTION FACTOR (dB/m)
1	*5230.00	102.2 PK			1.18 H	0	62.42	39.78
2	*5230.00	79.2 AV			1.18 H	0	39.39	39.78
3	#10460.00	52.9 PK	74.0	-21.1	1.00 H	0	6.71	46.19
4	#10460.00	39.3 AV	54.0	-14.7	1.00 H	0	-6.86	46.19
ANTENNA POLARITY & TEST DISTANCE: VERTICAL AT 3 M								
NO.	FREQ. (MHz)	EMISSION LEVEL (dBuV/m)	LIMIT (dBuV/m)	MARGIN (dB)	ANTENNA HEIGHT (m)	TABLE ANGLE (Degree)	RAW VALUE (dBuV)	CORRECTION FACTOR (dB/m)
1	*5230.00	98.7 PK			1.12 V	360	58.94	39.78
2	*5230.00	76.2 AV			1.12 V	360	36.37	39.78
3	#10460.00	52.0 PK	74.0	-22.0	1.00 V	0	5.85	46.19
4	#10460.00	38.2 AV	54.0	-15.8	1.00 V	0	-8.02	46.19

REMARKS:

1. Emission level (dBuV/m) = Raw Value (dBuV) + Correction Factor (dB/m).
2. Correction Factor (dB/m) = Antenna Factor (dB/m) + Cable Factor (dB).
3. The other emission levels were very low against the limit.
4. Margin value = Emission level – Limit value.
5. " * ": Fundamental frequency.
6. " # ": The radiated frequency is out of the restricted band.



ABOVE 1GHz WORST-CASE DATA: Band 2

802.11a

CHANNEL	TX Channel 52	DETECTOR FUNCTION	Peak (PK)
FREQUENCY RANGE	1GHz ~ 40GHz		Average (AV)

ANTENNA POLARITY & TEST DISTANCE: HORIZONTAL AT 3 M								
NO.	FREQ. (MHz)	EMISSION LEVEL (dBuV/m)	LIMIT (dBuV/m)	MARGIN (dB)	ANTENNA HEIGHT (m)	TABLE ANGLE (Degree)	RAW VALUE (dBuV)	CORRECTION FACTOR (dB/m)
1	*5260.00	104.7 PK			1.92 H	182	64.88	39.83
2	*5260.00	86.7 AV			1.92 H	182	46.89	39.83
3	#10520.00	52.4 PK	74.0	-21.6	1.00 H	360	6.09	46.29
4	#10520.00	38.1 AV	54.0	-15.9	1.00 H	360	-8.19	46.29
ANTENNA POLARITY & TEST DISTANCE: VERTICAL AT 3 M								
NO.	FREQ. (MHz)	EMISSION LEVEL (dBuV/m)	LIMIT (dBuV/m)	MARGIN (dB)	ANTENNA HEIGHT (m)	TABLE ANGLE (Degree)	RAW VALUE (dBuV)	CORRECTION FACTOR (dB/m)
1	*5260.00	103.3 PK			1.04 V	112	63.48	39.83
2	*5260.00	82.1 AV			1.04 V	112	42.27	39.83
3	#10520.00	53.4 PK	74.0	-20.6	1.00 V	360	7.13	46.29
4	#10520.00	38.5 AV	54.0	-15.5	1.00 V	360	-7.80	46.29

REMARKS:

1. Emission level (dBuV/m) = Raw Value (dBuV) + Correction Factor (dB/m).
2. Correction Factor (dB/m) = Antenna Factor (dB/m) + Cable Factor (dB).
3. The other emission levels were very low against the limit.
4. Margin value = Emission level – Limit value.
5. " * ": Fundamental frequency.
6. " # ": The radiated frequency is out of the restricted band.



CHANNEL	TX Channel 60	DETECTOR FUNCTION	Peak (PK)
FREQUENCY RANGE	1GHz ~ 40GHz		Average (AV)

ANTENNA POLARITY & TEST DISTANCE: HORIZONTAL AT 3 M								
NO.	FREQ. (MHz)	EMISSION LEVEL (dBuV/m)	LIMIT (dBuV/m)	MARGIN (dB)	ANTENNA HEIGHT (m)	TABLE ANGLE (Degree)	RAW VALUE (dBuV)	CORRECTION FACTOR (dB/m)
1	*5300.00	104.7 PK			1.57 H	228	64.76	39.89
2	*5300.00	86.4 AV			1.57 H	228	46.47	39.89
3	10600.00	52.9 PK	74.0	-21.1	1.00 H	0	6.54	46.38
4	10600.00	39.0 AV	54.0	-15.0	1.00 H	0	-7.34	46.38
ANTENNA POLARITY & TEST DISTANCE: VERTICAL AT 3 M								
NO.	FREQ. (MHz)	EMISSION LEVEL (dBuV/m)	LIMIT (dBuV/m)	MARGIN (dB)	ANTENNA HEIGHT (m)	TABLE ANGLE (Degree)	RAW VALUE (dBuV)	CORRECTION FACTOR (dB/m)
1	*5300.00	103.1 PK			1.34 V	190	63.19	39.89
2	*5300.00	84.6 AV			1.34 V	190	44.69	39.89
3	10600.00	53.2 PK	74.0	-20.8	1.00 V	0	6.82	46.38
4	10600.00	38.2 AV	54.0	-15.8	1.00 V	0	-8.15	46.38

REMARKS:

1. Emission level (dBuV/m) = Raw Value (dBuV) + Correction Factor (dB/m).
2. Correction Factor (dB/m) = Antenna Factor (dB/m) + Cable Factor (dB).
3. The other emission levels were very low against the limit.
4. Margin value = Emission level – Limit value.
5. " * ": Fundamental frequency.



CHANNEL	TX Channel 64	DETECTOR FUNCTION	Peak (PK)
FREQUENCY RANGE	1GHz ~ 40GHz		Average (AV)

ANTENNA POLARITY & TEST DISTANCE: HORIZONTAL AT 3 M

NO.	FREQ. (MHz)	EMISSION LEVEL (dBuV/m)	LIMIT (dBuV/m)	MARGIN (dB)	ANTENNA HEIGHT (m)	TABLE ANGLE (Degree)	RAW VALUE (dBuV)	CORRECTION FACTOR (dB/m)
1	*5320.00	103.6 PK			1.62 H	207	63.64	39.92
2	*5320.00	86.4 AV			1.62 H	207	46.52	39.92
3	5350.00	61.7 PK	74.0	-12.3	1.62 H	207	21.77	39.97
4	5350.00	44.3 AV	54.0	-9.7	1.62 H	207	4.33	39.97
5	10640.00	52.6 PK	74.0	-21.4	1.00 H	0	6.20	46.42
6	10640.00	38.1 AV	54.0	-15.9	1.00 H	0	-8.35	46.42

ANTENNA POLARITY & TEST DISTANCE: VERTICAL AT 3 M

NO.	FREQ. (MHz)	EMISSION LEVEL (dBuV/m)	LIMIT (dBuV/m)	MARGIN (dB)	ANTENNA HEIGHT (m)	TABLE ANGLE (Degree)	RAW VALUE (dBuV)	CORRECTION FACTOR (dB/m)
1	*5320.00	102.5 PK			1.00 V	253	62.57	39.92
2	*5320.00	83.8 AV			1.00 V	253	43.83	39.92
3	5350.00	58.6 PK	74.0	-15.4	1.00 V	253	18.65	39.97
4	5350.00	42.8 AV	54.0	-11.2	1.00 V	253	2.84	39.97
5	10640.00	53.1 PK	74.0	-20.9	1.00 V	0	6.70	46.42
6	10640.00	38.3 AV	54.0	-15.8	1.00 V	0	-8.17	46.42

REMARKS:

1. Emission level (dBuV/m) = Raw Value (dBuV) + Correction Factor (dB/m).
2. Correction Factor (dB/m) = Antenna Factor (dB/m) + Cable Factor (dB).
3. The other emission levels were very low against the limit.
4. Margin value = Emission level – Limit value.
5. " * ": Fundamental frequency.



802.11n (20MHz)

CHANNEL	TX Channel 52	DETECTOR FUNCTION	Peak (PK)
FREQUENCY RANGE	1GHz ~ 40GHz		Average (AV)

ANTENNA POLARITY & TEST DISTANCE: HORIZONTAL AT 3 M								
NO.	FREQ. (MHz)	EMISSION LEVEL (dBuV/m)	LIMIT (dBuV/m)	MARGIN (dB)	ANTENNA HEIGHT (m)	TABLE ANGLE (Degree)	RAW VALUE (dBuV)	CORRECTION FACTOR (dB/m)
1	*5260.00	102.9 PK			1.89 H	183	63.07	39.83
2	*5260.00	85.7 AV			1.89 H	183	45.86	39.83
3	#10520.00	52.6 PK	74.0	-21.4	1.00 H	0	6.33	46.29
4	#10520.00	38.2 AV	54.0	-15.8	1.00 H	0	-8.09	46.29

ANTENNA POLARITY & TEST DISTANCE: VERTICAL AT 3 M								
NO.	FREQ. (MHz)	EMISSION LEVEL (dBuV/m)	LIMIT (dBuV/m)	MARGIN (dB)	ANTENNA HEIGHT (m)	TABLE ANGLE (Degree)	RAW VALUE (dBuV)	CORRECTION FACTOR (dB/m)
1	*5260.00	100.6 PK			1.04 V	163	60.75	39.83
2	*5260.00	82.6 AV			1.04 V	163	42.74	39.83
3	#10520.00	52.8 PK	74.0	-21.3	1.00 V	0	6.46	46.29
4	#10520.00	38.0 AV	54.0	-16.0	1.00 V	0	-8.33	46.29

REMARKS:

1. Emission level (dBuV/m) = Raw Value (dBuV) + Correction Factor (dB/m).
2. Correction Factor (dB/m) = Antenna Factor (dB/m) + Cable Factor (dB).
3. The other emission levels were very low against the limit.
4. Margin value = Emission level – Limit value.
5. " * ": Fundamental frequency.
6. " # ": The radiated frequency is out of the restricted band.



CHANNEL	TX Channel 60	DETECTOR FUNCTION	Peak (PK)
FREQUENCY RANGE	1GHz ~ 40GHz		Average (AV)

ANTENNA POLARITY & TEST DISTANCE: HORIZONTAL AT 3 M								
NO.	FREQ. (MHz)	EMISSION LEVEL (dBuV/m)	LIMIT (dBuV/m)	MARGIN (dB)	ANTENNA HEIGHT (m)	TABLE ANGLE (Degree)	RAW VALUE (dBuV)	CORRECTION FACTOR (dB/m)
1	*5300.00	103.2 PK			1.57 H	63	63.27	39.89
2	*5300.00	85.1 AV			1.57 H	63	45.22	39.89
3	10600.00	52.4 PK	74.0	-21.6	1.00 H	0	6.05	46.38
4	10600.00	38.5 AV	54.0	-15.5	1.00 H	0	-7.88	46.38
ANTENNA POLARITY & TEST DISTANCE: VERTICAL AT 3 M								
NO.	FREQ. (MHz)	EMISSION LEVEL (dBuV/m)	LIMIT (dBuV/m)	MARGIN (dB)	ANTENNA HEIGHT (m)	TABLE ANGLE (Degree)	RAW VALUE (dBuV)	CORRECTION FACTOR (dB/m)
1	*5300.00	99.1 PK			1.33 V	55	59.21	39.89
2	*5300.00	80.5 AV			1.33 V	55	40.63	39.89
3	10600.00	54.0 PK	74.0	-20.0	1.00 V	0	7.65	46.38
4	10600.00	38.3 AV	54.0	-15.7	1.00 V	0	-8.08	46.38

REMARKS:

1. Emission level (dBuV/m) = Raw Value (dBuV) + Correction Factor (dB/m).
2. Correction Factor (dB/m) = Antenna Factor (dB/m) + Cable Factor (dB).
3. The other emission levels were very low against the limit.
4. Margin value = Emission level – Limit value.
5. " * ": Fundamental frequency.



CHANNEL	TX Channel 64	DETECTOR FUNCTION	Peak (PK)
FREQUENCY RANGE	1GHz ~ 40GHz		Average (AV)

ANTENNA POLARITY & TEST DISTANCE: HORIZONTAL AT 3 M								
NO.	FREQ. (MHz)	EMISSION LEVEL (dBuV/m)	LIMIT (dBuV/m)	MARGIN (dB)	ANTENNA HEIGHT (m)	TABLE ANGLE (Degree)	RAW VALUE (dBuV)	CORRECTION FACTOR (dB/m)
1	*5320.00	103.1 PK			1.57 H	65	63.19	39.92
2	*5320.00	84.7 AV			1.57 H	65	44.81	39.92
3	5350.00	60.0 PK	74.0	-14.0	1.57 H	65	19.99	39.97
4	5350.00	45.0 AV	54.0	-9.0	1.57 H	65	5.05	39.97
5	10640.00	53.6 PK	74.0	-20.4	1.00 H	360	7.18	46.42
6	10640.00	39.8 AV	54.0	-14.2	1.00 H	360	-6.59	46.42
ANTENNA POLARITY & TEST DISTANCE: VERTICAL AT 3 M								
NO.	FREQ. (MHz)	EMISSION LEVEL (dBuV/m)	LIMIT (dBuV/m)	MARGIN (dB)	ANTENNA HEIGHT (m)	TABLE ANGLE (Degree)	RAW VALUE (dBuV)	CORRECTION FACTOR (dB/m)
1	*5320.00	99.6 PK			1.68 V	67	59.67	39.92
2	*5320.00	81.8 AV			1.68 V	67	41.88	39.92
3	5350.00	57.2 PK	74.0	-16.8	1.68 V	67	17.22	39.97
4	5350.00	42.7 AV	54.0	-11.3	1.68 V	67	2.70	39.97
5	10640.00	52.5 PK	74.0	-21.5	1.00 V	360	6.07	46.42
6	10640.00	38.8 AV	54.0	-15.2	1.00 V	360	-7.66	46.42

REMARKS:

1. Emission level (dBuV/m) = Raw Value (dBuV) + Correction Factor (dB/m).
2. Correction Factor (dB/m) = Antenna Factor (dB/m) + Cable Factor (dB).
3. The other emission levels were very low against the limit.
4. Margin value = Emission level – Limit value.
5. " * ": Fundamental frequency.



802.11n (40MHz)

CHANNEL	TX Channel 54	DETECTOR FUNCTION	Peak (PK)
FREQUENCY RANGE	1GHz ~ 40GHz		Average (AV)

ANTENNA POLARITY & TEST DISTANCE: HORIZONTAL AT 3 M								
NO.	FREQ. (MHz)	EMISSION LEVEL (dBuV/m)	LIMIT (dBuV/m)	MARGIN (dB)	ANTENNA HEIGHT (m)	TABLE ANGLE (Degree)	RAW VALUE (dBuV)	CORRECTION FACTOR (dB/m)
1	*5270.00	99.2 PK			1.74 H	61	59.36	39.84
2	*5270.00	76.6 AV			1.74 H	61	36.77	39.84
3	#10540.00	52.4 PK	74.0	-21.7	1.00 H	0	6.04	46.31
4	#10540.00	38.4 AV	54.0	-15.6	1.00 H	0	-7.91	46.31

ANTENNA POLARITY & TEST DISTANCE: VERTICAL AT 3 M								
NO.	FREQ. (MHz)	EMISSION LEVEL (dBuV/m)	LIMIT (dBuV/m)	MARGIN (dB)	ANTENNA HEIGHT (m)	TABLE ANGLE (Degree)	RAW VALUE (dBuV)	CORRECTION FACTOR (dB/m)
1	*5270.00	97.7 PK			1.79 V	67	57.81	39.84
2	*5270.00	75.1 AV			1.79 V	67	35.21	39.84
3	#10540.00	53.3 PK	74.0	-20.7	1.00 V	67	6.96	46.31
4	#10540.00	38.4 AV	54.0	-15.6	1.00 V	67	-7.93	46.31

REMARKS:

1. Emission level (dBuV/m) = Raw Value (dBuV) + Correction Factor (dB/m).
2. Correction Factor (dB/m) = Antenna Factor (dB/m) + Cable Factor (dB).
3. The other emission levels were very low against the limit.
4. Margin value = Emission level – Limit value.
5. " * ": Fundamental frequency.
6. " # ": The radiated frequency is out of the restricted band.



CHANNEL	TX Channel 62	DETECTOR FUNCTION	Peak (PK)
FREQUENCY RANGE	1GHz ~ 40GHz		Average (AV)

ANTENNA POLARITY & TEST DISTANCE: HORIZONTAL AT 3 M

NO.	FREQ. (MHz)	EMISSION LEVEL (dBuV/m)	LIMIT (dBuV/m)	MARGIN (dB)	ANTENNA HEIGHT (m)	TABLE ANGLE (Degree)	RAW VALUE (dBuV)	CORRECTION FACTOR (dB/m)
1	*5310.00	99.1 PK			1.75 H	60	59.16	39.91
2	*5310.00	76.8 AV			1.75 H	60	36.89	39.91
3	5350.00	69.5 PK	74.0	-4.6	1.75 H	60	29.48	39.97
4	5350.00	50.1 AV	54.0	-3.9	1.75 H	60	10.17	39.97
5	10620.00	52.9 PK	74.0	-21.1	1.00 H	360	6.49	46.40
6	10620.00	38.2 AV	54.0	-15.8	1.00 H	360	-8.20	46.40

ANTENNA POLARITY & TEST DISTANCE: VERTICAL AT 3 M

NO.	FREQ. (MHz)	EMISSION LEVEL (dBuV/m)	LIMIT (dBuV/m)	MARGIN (dB)	ANTENNA HEIGHT (m)	TABLE ANGLE (Degree)	RAW VALUE (dBuV)	CORRECTION FACTOR (dB/m)
1	*5310.00	97.8 PK			1.39 V	61	57.84	39.91
2	*5310.00	75.1 AV			1.39 V	61	35.21	39.91
3	5350.00	68.2 PK	74.0	-5.8	1.39 V	61	28.19	39.97
4	5350.00	48.8 AV	54.0	-5.3	1.39 V	61	8.78	39.97
5	10620.00	52.4 PK	74.0	-21.6	1.00 V	0	6.03	46.40
6	10620.00	38.2 AV	54.0	-15.8	1.00 V	0	-8.16	46.40

REMARKS:

1. Emission level (dBuV/m) = Raw Value (dBuV) + Correction Factor (dB/m).
2. Correction Factor (dB/m) = Antenna Factor (dB/m) + Cable Factor (dB).
3. The other emission levels were very low against the limit.
4. Margin value = Emission level – Limit value.
5. " * ": Fundamental frequency.



ABOVE 1GHz WORST-CASE DATA: Band 3

802.11a

CHANNEL	TX Channel 100	DETECTOR FUNCTION	Peak (PK)
FREQUENCY RANGE	1GHz ~ 40GHz		Average (AV)

ANTENNA POLARITY & TEST DISTANCE: HORIZONTAL AT 3 M								
NO.	FREQ. (MHz)	EMISSION LEVEL (dBuV/m)	LIMIT (dBuV/m)	MARGIN (dB)	ANTENNA HEIGHT (m)	TABLE ANGLE (Degree)	RAW VALUE (dBuV)	CORRECTION FACTOR (dB/m)
1	#5470.00	55.8 PK	68.3	-12.5	1.00 H	228	15.63	40.17
2	*5500.00	103.0 PK			1.00 H	206	62.78	40.22
3	*5500.00	85.2 AV			1.00 H	206	44.98	40.22
4	11000.00	54.6 PK	74.0	-19.4	1.00 H	206	7.80	46.80
5	11000.00	42.5 AV	54.0	-11.5	1.00 H	206	-4.30	46.80
ANTENNA POLARITY & TEST DISTANCE: VERTICAL AT 3 M								
NO.	FREQ. (MHz)	EMISSION LEVEL (dBuV/m)	LIMIT (dBuV/m)	MARGIN (dB)	ANTENNA HEIGHT (m)	TABLE ANGLE (Degree)	RAW VALUE (dBuV)	CORRECTION FACTOR (dB/m)
1	#5470.00	64.3 PK	68.3	-4.0	1.00 V	310	39.02	25.28
2	*5500.00	115.2 PK			1.00 V	210	89.85	25.35
3	*5500.00	98.6 AV			1.00 V	210	73.25	25.35
4	11000.00	55.6 PK	74.0	-18.4	1.00 V	122	26.60	29.00
5	11000.00	44.6 AV	54.0	-9.4	1.00 V	122	15.60	29.00

REMARKS:

1. Emission level (dBuV/m) = Raw Value (dBuV) + Correction Factor (dB/m).
2. Correction Factor (dB/m) = Antenna Factor (dB/m) + Cable Factor (dB).
3. The other emission levels were very low against the limit.
4. Margin value = Emission level – Limit value.
5. " * ": Fundamental frequency.
6. " # ": The radiated frequency is out of the restricted band.



CHANNEL	TX Channel 116	DETECTOR FUNCTION	Peak (PK)
FREQUENCY RANGE	1GHz ~ 40GHz		Average (AV)

ANTENNA POLARITY & TEST DISTANCE: HORIZONTAL AT 3 M

NO.	FREQ. (MHz)	EMISSION LEVEL (dBuV/m)	LIMIT (dBuV/m)	MARGIN (dB)	ANTENNA HEIGHT (m)	TABLE ANGLE (Degree)	RAW VALUE (dBuV)	CORRECTION FACTOR (dB/m)
1	*5580.00	102.6 PK			1.00 H	332	62.17	40.43
2	*5580.00	83.4 AV			1.00 H	332	42.97	40.43
3	11160.00	53.6 PK	74.0	-20.4	1.00 H	211	6.66	46.94
4	11160.00	40.8 AV	54.0	-13.2	1.00 H	211	-6.14	46.94

ANTENNA POLARITY & TEST DISTANCE: VERTICAL AT 3 M

NO.	FREQ. (MHz)	EMISSION LEVEL (dBuV/m)	LIMIT (dBuV/m)	MARGIN (dB)	ANTENNA HEIGHT (m)	TABLE ANGLE (Degree)	RAW VALUE (dBuV)	CORRECTION FACTOR (dB/m)
1	*5580.00	98.6 PK			1.00 V	223	58.17	40.43
2	*5580.00	77.2 AV			1.00 V	223	36.77	40.43
3	11160.00	51.6 PK	74.0	-22.4	1.00 V	240	4.66	46.94
4	11160.00	39.5 AV	54.0	-14.5	1.00 V	240	-7.44	46.94

REMARKS:

1. Emission level (dBuV/m) = Raw Value (dBuV) + Correction Factor (dB/m).
2. Correction Factor (dB/m) = Antenna Factor (dB/m) + Cable Factor (dB).
3. The other emission levels were very low against the limit.
4. Margin value = Emission level – Limit value.
5. " * ": Fundamental frequency.



CHANNEL	TX Channel 140	DETECTOR FUNCTION	Peak (PK)
FREQUENCY RANGE	1GHz ~ 40GHz		Average (AV)

ANTENNA POLARITY & TEST DISTANCE: HORIZONTAL AT 3 M								
NO.	FREQ. (MHz)	EMISSION LEVEL (dBuV/m)	LIMIT (dBuV/m)	MARGIN (dB)	ANTENNA HEIGHT (m)	TABLE ANGLE (Degree)	RAW VALUE (dBuV)	CORRECTION FACTOR (dB/m)
1	*5700.00	104.9 PK			1.00 H	115	64.15	40.75
2	*5700.00	83.6 AV			1.00 H	115	42.85	40.75
3	#5725.00	65.2 PK	68.3	-3.1	1.00 H	145	24.39	40.81
4	11400.00	53.2 PK	74.0	-20.8	1.00 H	20	6.06	47.14
5	11400.00	39.6 AV	54.0	-14.4	1.00 H	20	-7.54	47.14
ANTENNA POLARITY & TEST DISTANCE: VERTICAL AT 3 M								
NO.	FREQ. (MHz)	EMISSION LEVEL (dBuV/m)	LIMIT (dBuV/m)	MARGIN (dB)	ANTENNA HEIGHT (m)	TABLE ANGLE (Degree)	RAW VALUE (dBuV)	CORRECTION FACTOR (dB/m)
1	*5700.00	96.8 PK			1.20 V	200	56.05	40.75
2	*5700.00	75.8 AV			1.20 V	200	35.05	40.75
3	#5725.00	53.6 PK	68.3	-14.7	1.00 V	214	12.79	40.81
4	11400.00	55.3 PK	74.0	-18.7	1.00 V	304	8.16	47.14
5	11400.00	40.8 AV	54.0	-13.2	1.00 V	304	-6.34	47.14

REMARKS:

1. Emission level (dBuV/m) = Raw Value (dBuV) + Correction Factor (dB/m).
2. Correction Factor (dB/m) = Antenna Factor (dB/m) + Cable Factor (dB).
3. The other emission levels were very low against the limit.
4. Margin value = Emission level – Limit value.
5. " * ": Fundamental frequency.
6. " # ": The radiated frequency is out of the restricted band.



802.11n (20MHz)

CHANNEL	TX Channel 100	DETECTOR FUNCTION	Peak (PK)
FREQUENCY RANGE	1GHz ~ 40GHz		Average (AV)

ANTENNA POLARITY & TEST DISTANCE: HORIZONTAL AT 3 M								
NO.	FREQ. (MHz)	EMISSION LEVEL (dBuV/m)	LIMIT (dBuV/m)	MARGIN (dB)	ANTENNA HEIGHT (m)	TABLE ANGLE (Degree)	RAW VALUE (dBuV)	CORRECTION FACTOR (dB/m)
1	#5470.00	58.6 PK	68.3	-9.7	1.00 H	211	18.43	40.17
2	*5500.00	102.0 PK			1.00 H	214	61.78	40.22
3	*5500.00	83.3 AV			1.00 H	214	43.08	40.22
4	11000.00	55.2 PK	74.0	-18.8	1.00 H	302	8.40	46.80
5	11000.00	41.9 AV	54.0	-12.1	1.00 H	302	-4.90	46.80
ANTENNA POLARITY & TEST DISTANCE: VERTICAL AT 3 M								
NO.	FREQ. (MHz)	EMISSION LEVEL (dBuV/m)	LIMIT (dBuV/m)	MARGIN (dB)	ANTENNA HEIGHT (m)	TABLE ANGLE (Degree)	RAW VALUE (dBuV)	CORRECTION FACTOR (dB/m)
1	#5470.00	48.2 PK	68.3	-20.1	1.02 V	211	8.03	40.17
2	*5500.00	96.6 PK			1.45 V	102	56.38	40.22
3	*5500.00	75.6 AV			1.45 V	102	35.38	40.22
4	11000.00	53.2 PK	74.0	-20.8	1.00 V	224	6.40	46.80
5	11000.00	40.6 AV	54.0	-13.4	1.00 V	224	-6.20	46.80

REMARKS:

1. Emission level (dBuV/m) = Raw Value (dBuV) + Correction Factor (dB/m).
2. Correction Factor (dB/m) = Antenna Factor (dB/m) + Cable Factor (dB).
3. The other emission levels were very low against the limit.
4. Margin value = Emission level – Limit value.
5. " * ": Fundamental frequency.
6. " # ": The radiated frequency is out of the restricted band.



CHANNEL	TX Channel 116	DETECTOR FUNCTION	Peak (PK)
FREQUENCY RANGE	1GHz ~ 40GHz		Average (AV)

ANTENNA POLARITY & TEST DISTANCE: HORIZONTAL AT 3 M								
NO.	FREQ. (MHz)	EMISSION LEVEL (dBuV/m)	LIMIT (dBuV/m)	MARGIN (dB)	ANTENNA HEIGHT (m)	TABLE ANGLE (Degree)	RAW VALUE (dBuV)	CORRECTION FACTOR (dB/m)
1	*5580.00	103.4 PK			1.00 H	221	62.97	40.43
2	*5580.00	87.3 AV			1.00 H	221	46.87	40.43
3	11160.00	54.3 PK	74.0	-19.7	1.00 H	306	7.36	46.94
4	11160.00	42.8 AV	54.0	-11.2	1.00 H	306	-4.14	46.94
ANTENNA POLARITY & TEST DISTANCE: VERTICAL AT 3 M								
NO.	FREQ. (MHz)	EMISSION LEVEL (dBuV/m)	LIMIT (dBuV/m)	MARGIN (dB)	ANTENNA HEIGHT (m)	TABLE ANGLE (Degree)	RAW VALUE (dBuV)	CORRECTION FACTOR (dB/m)
1	*5580.00	96.3 PK			1.00 V	210	55.87	40.43
2	*5580.00	74.9 AV			1.00 V	210	34.47	40.43
3	11160.00	52.1 PK	74.0	-21.9	1.00 V	142	5.16	46.94
4	11160.00	38.9 AV	54.0	-15.1	1.00 V	142	-8.04	46.94

REMARKS:

1. Emission level (dBuV/m) = Raw Value (dBuV) + Correction Factor (dB/m).
2. Correction Factor (dB/m) = Antenna Factor (dB/m) + Cable Factor (dB).
3. The other emission levels were very low against the limit.
4. Margin value = Emission level – Limit value.
5. " * ": Fundamental frequency.



CHANNEL	TX Channel 140	DETECTOR FUNCTION	Peak (PK)
FREQUENCY RANGE	1GHz ~ 40GHz		Average (AV)

ANTENNA POLARITY & TEST DISTANCE: HORIZONTAL AT 3 M								
NO.	FREQ. (MHz)	EMISSION LEVEL (dBuV/m)	LIMIT (dBuV/m)	MARGIN (dB)	ANTENNA HEIGHT (m)	TABLE ANGLE (Degree)	RAW VALUE (dBuV)	CORRECTION FACTOR (dB/m)
1	*5700.00	103.6 PK			1.42 H	201	62.85	40.75
2	*5700.00	85.6 AV			1.42 H	201	44.85	40.75
3	#5725.00	65.1 PK	68.3	-3.2	1.00 H	214	24.29	40.81
4	11400.00	54.2 PK	74.0	-19.8	1.00 H	28	7.06	47.14
5	11400.00	41.1 AV	54.0	-12.9	1.00 H	28	-6.04	47.14
ANTENNA POLARITY & TEST DISTANCE: VERTICAL AT 3 M								
NO.	FREQ. (MHz)	EMISSION LEVEL (dBuV/m)	LIMIT (dBuV/m)	MARGIN (dB)	ANTENNA HEIGHT (m)	TABLE ANGLE (Degree)	RAW VALUE (dBuV)	CORRECTION FACTOR (dB/m)
1	*5700.00	96.4 PK			1.00 V	135	55.65	40.75
2	*5700.00	45.9 AV			1.00 V	135	5.15	40.75
3	#5725.00	54.6 PK	68.3	-13.7	1.00 V	214	13.79	40.81
4	11400.00	53.8 PK	74.0	-20.2	1.00 V	360	6.66	47.14
5	11400.00	39.7 AV	54.0	-14.3	1.00 V	360	-7.44	47.14

REMARKS:

1. Emission level (dBuV/m) = Raw Value (dBuV) + Correction Factor (dB/m).
2. Correction Factor (dB/m) = Antenna Factor (dB/m) + Cable Factor (dB).
3. The other emission levels were very low against the limit.
4. Margin value = Emission level – Limit value.
5. " * ": Fundamental frequency.
6. " # ": The radiated frequency is out of the restricted band.



802.11n (40MHz)

CHANNEL	TX Channel 102	DETECTOR FUNCTION	Peak (PK)
FREQUENCY RANGE	1GHz ~ 40GHz		Average (AV)

ANTENNA POLARITY & TEST DISTANCE: HORIZONTAL AT 3 M								
NO.	FREQ. (MHz)	EMISSION LEVEL (dBuV/m)	LIMIT (dBuV/m)	MARGIN (dB)	ANTENNA HEIGHT (m)	TABLE ANGLE (Degree)	RAW VALUE (dBuV)	CORRECTION FACTOR (dB/m)
1	#5470.00	64.9 PK	68.3	-3.4	1.00 H	140	24.73	40.17
2	*5510.00	100.2 PK			1.00 H	360	59.95	40.25
3	*5510.00	74.3 AV			1.00 H	360	34.05	40.25
4	11020.00	53.2 PK	74.0	-20.8	1.00 H	26	6.38	46.82
5	11020.00	38.7 AV	54.0	-15.3	1.00 H	26	-8.12	46.82
ANTENNA POLARITY & TEST DISTANCE: VERTICAL AT 3 M								
NO.	FREQ. (MHz)	EMISSION LEVEL (dBuV/m)	LIMIT (dBuV/m)	MARGIN (dB)	ANTENNA HEIGHT (m)	TABLE ANGLE (Degree)	RAW VALUE (dBuV)	CORRECTION FACTOR (dB/m)
1	#5470.00	58.8 PK	68.3	-9.5	1.00 V	216	18.63	40.17
2	*5510.00	88.6 PK			1.00 V	214	48.35	40.25
3	*5510.00	65.6 AV			1.00 V	214	25.35	40.25
4	11020.00	52.4 PK	74.0	-21.6	1.00 V	219	5.58	46.82
5	11020.00	38.0 AV	54.0	-16.0	1.00 V	219	-8.82	46.82

REMARKS:

1. Emission level (dBuV/m) = Raw Value (dBuV) + Correction Factor (dB/m).
2. Correction Factor (dB/m) = Antenna Factor (dB/m) + Cable Factor (dB).
3. The other emission levels were very low against the limit.
4. Margin value = Emission level – Limit value.
5. " * ": Fundamental frequency.
6. " # ": The radiated frequency is out of the restricted band.



CHANNEL	TX Channel 134	DETECTOR FUNCTION	Peak (PK)
FREQUENCY RANGE	1GHz ~ 40GHz		Average (AV)

ANTENNA POLARITY & TEST DISTANCE: HORIZONTAL AT 3 M								
NO.	FREQ. (MHz)	EMISSION LEVEL (dBuV/m)	LIMIT (dBuV/m)	MARGIN (dB)	ANTENNA HEIGHT (m)	TABLE ANGLE (Degree)	RAW VALUE (dBuV)	CORRECTION FACTOR (dB/m)
1	*5670.00	102.8 PK			1.00 H	114	62.13	40.67
2	*5670.00	78.6 AV			1.00 H	114	37.93	40.67
3	#5725.00	65.1 PK	68.3	-3.2	1.00 H	211	24.29	40.81
4	11340.00	55.4 PK	74.0	-18.6	1.00 H	314	8.31	47.09
5	11340.00	43.8 AV	54.0	-10.2	1.00 H	314	-3.29	47.09
ANTENNA POLARITY & TEST DISTANCE: VERTICAL AT 3 M								
NO.	FREQ. (MHz)	EMISSION LEVEL (dBuV/m)	LIMIT (dBuV/m)	MARGIN (dB)	ANTENNA HEIGHT (m)	TABLE ANGLE (Degree)	RAW VALUE (dBuV)	CORRECTION FACTOR (dB/m)
1	*5670.00	92.8 PK			1.00 V	214	52.13	40.67
2	*5670.00	75.6 AV			1.00 V	214	34.93	40.67
3	#5725.00	54.6 PK	68.3	-13.7	1.00 V	213	13.79	40.81
4	11340.00	54.6 PK	74.0	-19.4	1.00 V	342	7.51	47.09
5	11340.00	42.8 AV	54.0	-11.2	1.00 V	342	-4.29	47.09

REMARKS:

1. Emission level (dBuV/m) = Raw Value (dBuV) + Correction Factor (dB/m).
2. Correction Factor (dB/m) = Antenna Factor (dB/m) + Cable Factor (dB).
3. The other emission levels were very low against the limit.
4. Margin value = Emission level – Limit value.
5. " * ": Fundamental frequency.
6. " # ": The radiated frequency is out of the restricted band.



ABOVE 1GHz WORST-CASE DATA: Band 4

802.11a

CHANNEL	TX Channel 149	DETECTOR FUNCTION	Peak (PK)
FREQUENCY RANGE	1GHz ~ 40GHz		Average (AV)

ANTENNA POLARITY & TEST DISTANCE: HORIZONTAL AT 3 M								
NO.	FREQ. (MHz)	EMISSION LEVEL (dBuV/m)	LIMIT (dBuV/m)	MARGIN (dB)	ANTENNA HEIGHT (m)	TABLE ANGLE (Degree)	RAW VALUE (dBuV)	CORRECTION FACTOR (dB/m)
1	#5715.00	58.6 PK	68.3	-9.7	1.00 H	0	17.81	40.79
2	#5725.00	74.8 PK	78.3	-3.5	1.00 H	200	33.99	40.81
3	*5745.00	103.6 PK			1.00 H	0	62.73	40.87
4	*5745.00	85.9 AV			1.00 H	0	45.03	40.87
ANTENNA POLARITY & TEST DISTANCE: VERTICAL AT 3 M								
NO.	FREQ. (MHz)	EMISSION LEVEL (dBuV/m)	LIMIT (dBuV/m)	MARGIN (dB)	ANTENNA HEIGHT (m)	TABLE ANGLE (Degree)	RAW VALUE (dBuV)	CORRECTION FACTOR (dB/m)
1	#5715.00	46.3 PK	68.3	-22.0	1.00 V	124	5.51	40.79
2	#5725.00	62.8 PK	78.3	-15.5	1.02 V	208	21.99	40.81
3	*5745.00	92.3 PK			1.00 V	135	51.43	40.87
4	*5745.00	64.9 AV			1.00 V	135	24.03	40.87

REMARKS:

1. Emission level (dBuV/m) = Raw Value (dBuV) + Correction Factor (dB/m).
2. Correction Factor (dB/m) = Antenna Factor (dB/m) + Cable Factor (dB).
3. The other emission levels were very low against the limit.
4. Margin value = Emission level – Limit value.
5. " * ": Fundamental frequency.
6. " # ": The radiated frequency is out of the restricted band.



CHANNEL	TX Channel 157	DETECTOR FUNCTION	Peak (PK)
FREQUENCY RANGE	1GHz ~ 40GHz		Average (AV)

ANTENNA POLARITY & TEST DISTANCE: HORIZONTAL AT 3 M								
NO.	FREQ. (MHz)	EMISSION LEVEL (dBuV/m)	LIMIT (dBuV/m)	MARGIN (dB)	ANTENNA HEIGHT (m)	TABLE ANGLE (Degree)	RAW VALUE (dBuV)	CORRECTION FACTOR (dB/m)
1	*5785.00	101.6 PK			1.00 H	326	60.46	41.14
2	*5785.00	84.7 AV			1.00 H	326	43.56	41.14
3	11700.00	54.6 PK	74.0	-19.4	1.00 H	207	7.17	47.43
4	11700.00	42.8 AV	54.0	-11.2	1.00 H	207	-4.63	47.43

ANTENNA POLARITY & TEST DISTANCE: VERTICAL AT 3 M								
NO.	FREQ. (MHz)	EMISSION LEVEL (dBuV/m)	LIMIT (dBuV/m)	MARGIN (dB)	ANTENNA HEIGHT (m)	TABLE ANGLE (Degree)	RAW VALUE (dBuV)	CORRECTION FACTOR (dB/m)
1	*5785.00	90.8 PK			1.00 V	210	49.66	41.14
2	*5785.00	63.8 AV			1.00 V	210	22.66	41.14
3	11700.00	53.4 PK	74.0	-20.6	1.00 V	210	5.97	47.43
4	11700.00	41.8 AV	54.0	-12.2	1.00 V	210	-5.63	47.43

REMARKS:

1. Emission level (dBuV/m) = Raw Value (dBuV) + Correction Factor (dB/m).
2. Correction Factor (dB/m) = Antenna Factor (dB/m) + Cable Factor (dB).
3. The other emission levels were very low against the limit.
4. Margin value = Emission level – Limit value.
5. " * ": Fundamental frequency.



CHANNEL	TX Channel 161	DETECTOR FUNCTION	Peak (PK)
FREQUENCY RANGE	1GHz ~ 40GHz		Average (AV)

ANTENNA POLARITY & TEST DISTANCE: HORIZONTAL AT 3 M								
NO.	FREQ. (MHz)	EMISSION LEVEL (dBuV/m)	LIMIT (dBuV/m)	MARGIN (dB)	ANTENNA HEIGHT (m)	TABLE ANGLE (Degree)	RAW VALUE (dBuV)	CORRECTION FACTOR (dB/m)
1	*5805.00	103.4 PK			1.00 H	218	62.37	41.03
2	*5805.00	78.9 AV			1.00 H	218	37.87	41.03
3	#5850.00	54.3 PK	78.3	-24.0	1.00 H	135	13.16	41.14
4	#5860.00	48.0 PK	68.3	-20.3	1.00 H	225	6.83	41.17
ANTENNA POLARITY & TEST DISTANCE: VERTICAL AT 3 M								
NO.	FREQ. (MHz)	EMISSION LEVEL (dBuV/m)	LIMIT (dBuV/m)	MARGIN (dB)	ANTENNA HEIGHT (m)	TABLE ANGLE (Degree)	RAW VALUE (dBuV)	CORRECTION FACTOR (dB/m)
1	*5805.00	92.5 PK			1.00 V	214	51.47	41.03
2	*5805.00	65.8 AV			1.00 V	214	24.77	41.03
3	#5850.00	48.5 PK	78.3	-29.8	1.01 V	332	7.36	41.14
4	#5860.00	47.5 PK	68.3	-20.8	1.00 V	325	6.33	41.17

REMARKS:

1. Emission level (dBuV/m) = Raw Value (dBuV) + Correction Factor (dB/m).
2. Correction Factor (dB/m) = Antenna Factor (dB/m) + Cable Factor (dB).
3. The other emission levels were very low against the limit.
4. Margin value = Emission level – Limit value.
5. " * ": Fundamental frequency.
6. " # ": The radiated frequency is out of the restricted band.



802.11n (20MHz)

CHANNEL	TX Channel 149	DETECTOR FUNCTION	Peak (PK)
FREQUENCY RANGE	1GHz ~ 40GHz		Average (AV)

ANTENNA POLARITY & TEST DISTANCE: HORIZONTAL AT 3 M								
NO.	FREQ. (MHz)	EMISSION LEVEL (dBuV/m)	LIMIT (dBuV/m)	MARGIN (dB)	ANTENNA HEIGHT (m)	TABLE ANGLE (Degree)	RAW VALUE (dBuV)	CORRECTION FACTOR (dB/m)
1	#5715.00	57.5 PK	68.3	-10.8	1.00 H	311	16.71	40.79
2	#5725.00	74.3 PK	78.3	-4.0	1.00 H	100	33.49	40.81
3	*5745.00	102.7 PK			1.02 H	304	61.83	40.87
4	*5745.00	84.9 AV			1.02 H	304	44.03	40.87

ANTENNA POLARITY & TEST DISTANCE: VERTICAL AT 3 M								
NO.	FREQ. (MHz)	EMISSION LEVEL (dBuV/m)	LIMIT (dBuV/m)	MARGIN (dB)	ANTENNA HEIGHT (m)	TABLE ANGLE (Degree)	RAW VALUE (dBuV)	CORRECTION FACTOR (dB/m)
1	#5715.00	47.6 PK	68.3	-20.7	1.00 V	305	6.81	40.79
2	#5725.00	61.9 PK	78.3	-16.4	1.00 V	141	21.09	40.81
3	*5745.00	93.5 PK			1.00 V	226	52.63	40.87
4	*5745.00	65.8 AV			1.00 V	226	24.93	40.87

REMARKS:

1. Emission level (dBuV/m) = Raw Value (dBuV) + Correction Factor (dB/m).
2. Correction Factor (dB/m) = Antenna Factor (dB/m) + Cable Factor (dB).
3. The other emission levels were very low against the limit.
4. Margin value = Emission level – Limit value.
5. " * ": Fundamental frequency.
6. " # ": The radiated frequency is out of the restricted band.



CHANNEL	TX Channel 157	DETECTOR FUNCTION	Peak (PK)
FREQUENCY RANGE	1GHz ~ 40GHz		Average (AV)

ANTENNA POLARITY & TEST DISTANCE: HORIZONTAL AT 3 M								
NO.	FREQ. (MHz)	EMISSION LEVEL (dBuV/m)	LIMIT (dBuV/m)	MARGIN (dB)	ANTENNA HEIGHT (m)	TABLE ANGLE (Degree)	RAW VALUE (dBuV)	CORRECTION FACTOR (dB/m)
1	*5785.00	91.6 PK			1.00 H	342	50.46	41.14
2	*5785.00	64.7 AV			1.00 H	342	23.56	41.14
3	11700.00	52.8 PK	74.0	-21.2	1.00 H	336	5.37	47.43
4	11700.00	40.6 AV	54.0	-13.4	1.00 H	336	-6.83	47.43

ANTENNA POLARITY & TEST DISTANCE: VERTICAL AT 3 M								
NO.	FREQ. (MHz)	EMISSION LEVEL (dBuV/m)	LIMIT (dBuV/m)	MARGIN (dB)	ANTENNA HEIGHT (m)	TABLE ANGLE (Degree)	RAW VALUE (dBuV)	CORRECTION FACTOR (dB/m)
1	*5785.00	102.3 PK			1.00 V	322	61.16	41.14
2	*5785.00	85.4 AV			1.00 V	322	44.26	41.14
3	11700.00	55.6 PK	74.0	-18.4	1.00 V	201	8.17	47.43
4	11700.00	43.1 AV	54.0	-10.9	1.00 V	201	-4.33	47.43

REMARKS:

1. Emission level (dBuV/m) = Raw Value (dBuV) + Correction Factor (dB/m).
2. Correction Factor (dB/m) = Antenna Factor (dB/m) + Cable Factor (dB).
3. The other emission levels were very low against the limit.
4. Margin value = Emission level – Limit value.
5. " * ": Fundamental frequency.



CHANNEL	TX Channel 161	DETECTOR FUNCTION	Peak (PK)
FREQUENCY RANGE	1GHz ~ 40GHz		Average (AV)

ANTENNA POLARITY & TEST DISTANCE: HORIZONTAL AT 3 M								
NO.	FREQ. (MHz)	EMISSION LEVEL (dBuV/m)	LIMIT (dBuV/m)	MARGIN (dB)	ANTENNA HEIGHT (m)	TABLE ANGLE (Degree)	RAW VALUE (dBuV)	CORRECTION FACTOR (dB/m)
1	*5805.00	102.3 PK			1.00 H	236	61.27	41.03
2	*5805.00	78.1 AV			1.00 H	236	37.07	41.03
3	#5850.00	55.4 PK	78.3	-22.9	1.00 H	120	14.26	41.14
4	#5860.00	47.9 PK	68.3	-20.4	1.00 H	330	6.73	41.17
ANTENNA POLARITY & TEST DISTANCE: VERTICAL AT 3 M								
NO.	FREQ. (MHz)	EMISSION LEVEL (dBuV/m)	LIMIT (dBuV/m)	MARGIN (dB)	ANTENNA HEIGHT (m)	TABLE ANGLE (Degree)	RAW VALUE (dBuV)	CORRECTION FACTOR (dB/m)
1	*5805.00	91.8 PK			1.04 V	55	50.77	41.03
2	*5805.00	65.0 AV			1.04 V	55	23.97	41.03
3	#5850.00	49.6 PK	78.3	-28.7	1.00 V	211	8.46	41.14
4	#5860.00	47.6 PK	68.3	-20.7	1.00 V	210	6.43	41.17

REMARKS:

1. Emission level (dBuV/m) = Raw Value (dBuV) + Correction Factor (dB/m).
2. Correction Factor (dB/m) = Antenna Factor (dB/m) + Cable Factor (dB).
3. The other emission levels were very low against the limit.
4. Margin value = Emission level – Limit value.
5. " * ": Fundamental frequency.
6. " # ": The radiated frequency is out of the restricted band.



802.11n (40MHz)

CHANNEL	TX Channel 151	DETECTOR FUNCTION	Peak (PK)
FREQUENCY RANGE	1GHz ~ 40GHz		Average (AV)

ANTENNA POLARITY & TEST DISTANCE: HORIZONTAL AT 3 M								
NO.	FREQ. (MHz)	EMISSION LEVEL (dBuV/m)	LIMIT (dBuV/m)	MARGIN (dB)	ANTENNA HEIGHT (m)	TABLE ANGLE (Degree)	RAW VALUE (dBuV)	CORRECTION FACTOR (dB/m)
1	#5715.00	64.7 PK	68.3	-3.6	1.00 H	142	23.91	40.79
2	#5725.00	70.5 PK	78.3	-7.8	1.00 H	214	29.69	40.81
3	*5755.00	100.9 PK			1.00 H	219	60.01	40.89
4	*5755.00	77.5 AV			1.00 H	219	36.61	40.89
ANTENNA POLARITY & TEST DISTANCE: VERTICAL AT 3 M								
NO.	FREQ. (MHz)	EMISSION LEVEL (dBuV/m)	LIMIT (dBuV/m)	MARGIN (dB)	ANTENNA HEIGHT (m)	TABLE ANGLE (Degree)	RAW VALUE (dBuV)	CORRECTION FACTOR (dB/m)
1	#5715.00	53.6 PK	68.3	-14.7	1.00 V	263	12.81	40.79
2	#5725.00	58.6 PK	78.3	-19.7	1.00 V	102	17.79	40.81
3	*5755.00	89.7 PK			1.00 V	113	48.81	40.89
4	*5755.00	63.8 AV			1.00 V	113	22.91	40.89

REMARKS:

1. Emission level (dBuV/m) = Raw Value (dBuV) + Correction Factor (dB/m).
2. Correction Factor (dB/m) = Antenna Factor (dB/m) + Cable Factor (dB).
3. The other emission levels were very low against the limit.
4. Margin value = Emission level – Limit value.
5. " * ": Fundamental frequency.
6. " # ": The radiated frequency is out of the restricted band.



CHANNEL	TX Channel 159	DETECTOR FUNCTION	Peak (PK)
FREQUENCY RANGE	1GHz ~ 40GHz		Average (AV)

ANTENNA POLARITY & TEST DISTANCE: HORIZONTAL AT 3 M								
NO.	FREQ. (MHz)	EMISSION LEVEL (dBuV/m)	LIMIT (dBuV/m)	MARGIN (dB)	ANTENNA HEIGHT (m)	TABLE ANGLE (Degree)	RAW VALUE (dBuV)	CORRECTION FACTOR (dB/m)
1	*5795.00	101.3 PK			1.32 H	24	60.30	41.00
2	*5795.00	78.6 AV			1.32 H	24	37.60	41.00
3	#5850.00	55.6 PK	78.3	-22.7	1.01 H	214	14.46	41.14
4	#5860.00	49.0 PK	68.3	-19.3	1.00 H	26	7.83	41.17
ANTENNA POLARITY & TEST DISTANCE: VERTICAL AT 3 M								
NO.	FREQ. (MHz)	EMISSION LEVEL (dBuV/m)	LIMIT (dBuV/m)	MARGIN (dB)	ANTENNA HEIGHT (m)	TABLE ANGLE (Degree)	RAW VALUE (dBuV)	CORRECTION FACTOR (dB/m)
1	*5795.00	90.3 PK			1.00 V	25	49.30	41.00
2	*5795.00	65.3 AV			1.00 V	25	24.30	41.00
3	#5850.00	48.3 PK	78.3	-30.0	1.00 V	142	7.16	41.14
4	#5860.00	47.1 PK	68.3	-21.2	1.00 V	336	5.93	41.17

REMARKS:

1. Emission level (dBuV/m) = Raw Value (dBuV) + Correction Factor (dB/m).
2. Correction Factor (dB/m) = Antenna Factor (dB/m) + Cable Factor (dB).
3. The other emission levels were very low against the limit.
4. Margin value = Emission level – Limit value.
5. " * ": Fundamental frequency.
6. " # ": The radiated frequency is out of the restricted band.



4.2 CONDUCTED EMISSION MEASUREMENT

4.2.1 LIMITS OF CONDUCTED EMISSION MEASUREMENT

FREQUENCY OF EMISSION (MHz)	CONDUCTED LIMIT (dBµV)	
	Quasi-peak	Average
0.15 ~ 0.5	66 to 56	56 to 46
0.5 ~ 5	56	46
5 ~ 30	60	50

- NOTE:**
1. The lower limit shall apply at the transition frequencies.
 2. The limit decreases in line with the logarithm of the frequency in the range of 0.15 to 0.50MHz.
 3. All emanations from a class A/B digital device or system, including any network of conductors and apparatus connected thereto, shall not exceed the level of field strengths specified above.

4.2.2 TEST INSTRUMENTS

Equipment	Manufacturer	Model No.	Serial No.	Last Cal.	Next Cal.
EMI Test Receiver	Rohde&Schwarz	ESCI	101418	Mar. 28,14	Mar. 27,15
Artificial Mains Network	Rohde&Schwarz	ENV216	101173	May 14,14	May 13,15
Artificial Mains Network	Rohde&Schwarz	ESH3-Z5	100317	May 14,14	May 13,15
Test software	ADT	ADT_Cond_V7.3.7	N/A	N/A	N/A

- NOTE:**
1. The test was performed in shielded room 553.
 2. The calibration interval of the above test instruments is 12 months. And the calibrations are traceable to CEPREI/CHINA, GRGT/CHINA and NIM/CHINA.

4.2.3 TEST PROCEDURES

- a. The EUT was placed 0.4 meters from the conducting wall of the shielded room with EUT being connected to the power mains through a line impedance stabilization network (LISN). Other support units were connected to the power mains through another LISN. The two LISNs provide 50 ohm/ 50uH of coupling impedance for the measuring instrument.
- b. Both lines of the power mains connected to the EUT were checked for maximum conducted interference.
- c. The frequency range from 150kHz to 30MHz was searched. Emission levels under (Limit - 20dB) was not recorded.

NOTE: All modes of operation were investigated and the worst-case emissions are reported.



4.2.4 DEVIATION FROM TEST STANDARD

No deviation.

4.2.5 TEST SETUP

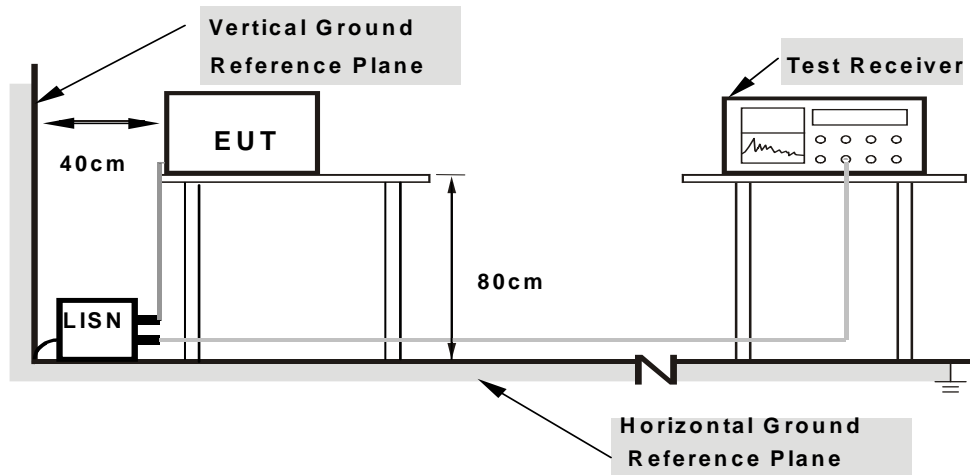

- Note:**
1. Support units were connected to second LISN.
 2. Both of LISNs (AMN) are 80 cm from EUT and at least 80 cm from other units and other metal planes

For the actual test configuration, please refer to the attached file (Test Setup Photo).

4.2.6 EUT OPERATING CONDITIONS

Same as 4.1.6.



4.2.7 TEST RESULTS

CONDUCTED WORST-CASE DATA : 802.11a

PHASE	Line	6dB BANDWIDTH	9kHz
CHANNEL	Channel 36		

No	Freq. [MHz]	Corr. Factor (dB)	Reading Value [dB (uV)]		Emission Level [dB (uV)]		Limit [dB (uV)]		Margin (dB)	
			Q.P.	AV.	Q.P.	AV.	Q.P.	AV.	Q.P.	AV.
1	0.17744	10.71	23.20	9.57	33.91	20.28	64.60	54.60	-30.69	-34.32
2	0.63856	10.46	32.99	24.48	43.45	34.94	56.00	46.00	-12.55	-11.06
3	1.27608	10.19	24.16	10.38	34.35	20.57	56.00	46.00	-21.65	-25.43
4	1.96424	10.08	21.63	8.10	31.71	18.18	56.00	46.00	-24.29	-27.82
5	3.32492	10.10	23.96	8.08	34.06	18.18	56.00	46.00	-21.94	-27.82
6	23.45751	10.66	23.81	11.52	34.47	22.18	60.00	50.00	-25.53	-27.82

- REMARKS:**
1. Q.P. and AV. are abbreviations of quasi-peak and average individually.
 2. "-": The Quasi-peak reading value also meets average limit and measurement with the average detector is unnecessary.
 3. The emission levels of other frequencies were very low against the limit.
 4. Margin value = Emission level - Limit value
 5. Correction factor = Insertion loss + Cable loss
 6. Emission Level = Correction Factor + Reading Value.

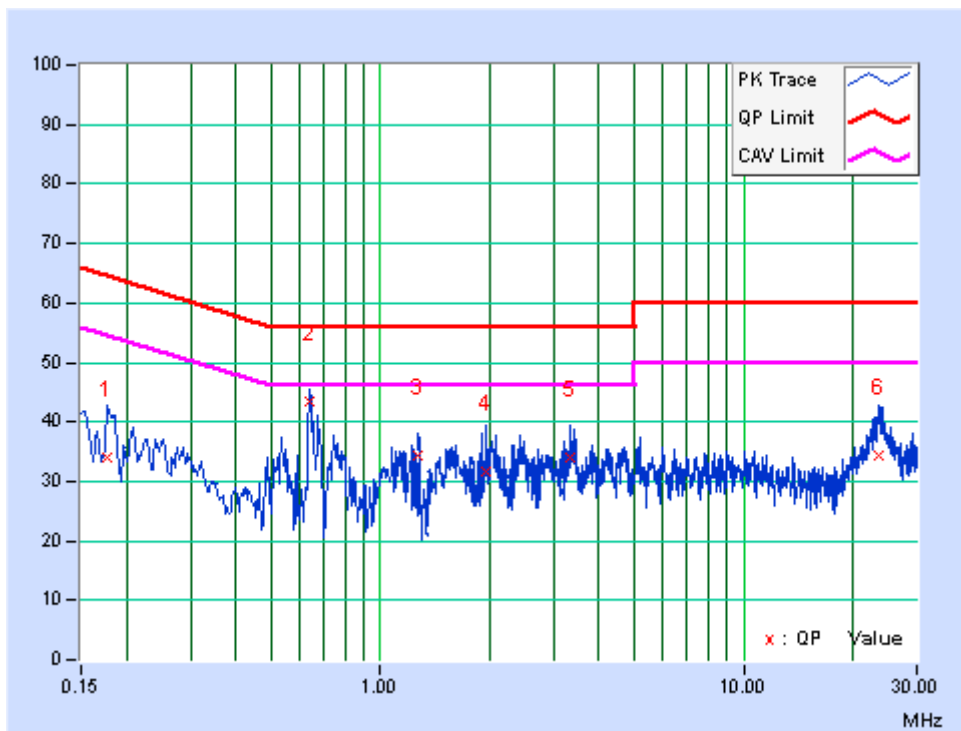



PHASE	Neutral	6dB BANDWIDTH	9kHz
CHANNEL	Channel 36		

No	Freq. [MHz]	Corr. Factor (dB)	Reading Value [dB (uV)]		Emission Level [dB (uV)]		Limit [dB (uV)]		Margin (dB)	
			Q.P.	AV.	Q.P.	AV.	Q.P.	AV.	Q.P.	AV.
1	0.15391	10.61	24.58	9.62	35.19	20.23	65.79	55.79	-30.59	-35.55
2	0.18122	10.56	22.92	7.59	33.48	18.15	64.43	54.43	-30.95	-36.28
3	0.63856	10.39	27.88	18.93	38.27	29.32	56.00	46.00	-17.73	-16.68
4	0.67394	10.35	24.71	13.05	35.06	23.40	56.00	46.00	-20.94	-22.60
5	1.52746	10.00	20.64	6.42	30.64	16.42	56.00	46.00	-25.36	-29.58
6	23.45751	10.53	29.77	10.76	40.30	21.29	60.00	50.00	-19.70	-28.71

- REMARKS:**
1. Q.P. and AV. are abbreviations of quasi-peak and average individually.
 2. "-": The Quasi-peak reading value also meets average limit and measurement with the average detector is unnecessary.
 3. The emission levels of other frequencies were very low against the limit.
 4. Margin value = Emission level - Limit value
 5. Correction factor = Insertion loss + Cable loss
 6. Emission Level = Correction Factor + Reading Value.

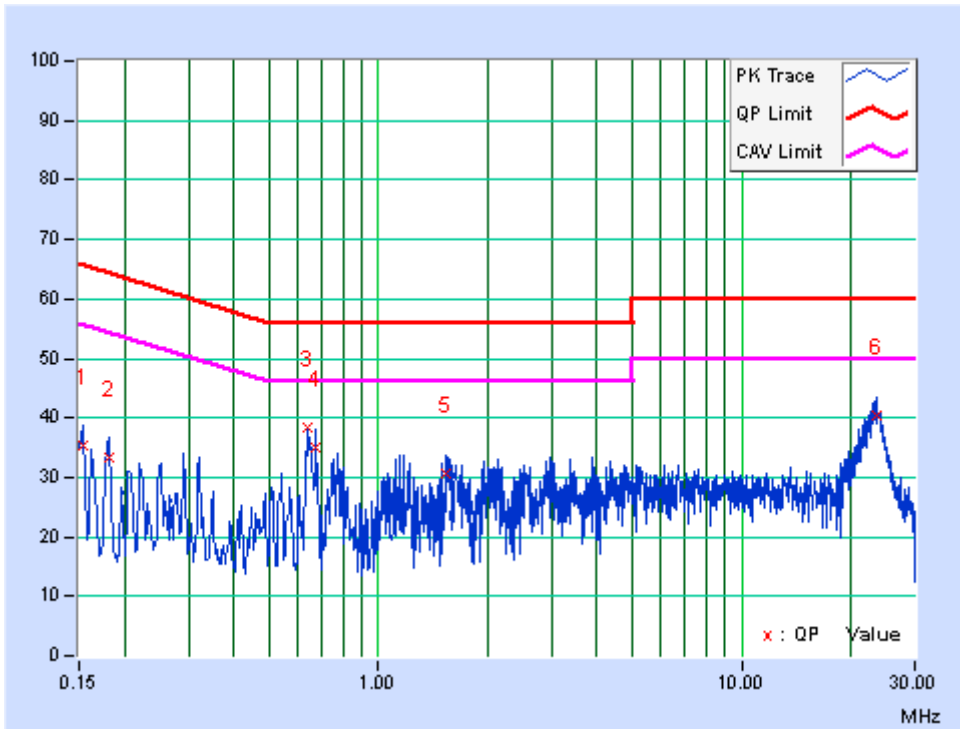



4.3 PEAK TRANSMIT POWER MEASUREMENT

4.3.1 LIMITS OF PEAK TRANSMIT POWER MEASUREMENT

Operation Band	EUT Category		LIMIT
U-NII-1		Outdoor Access Point	1 Watt (30 dBm) (Max. e.i.r.p \leq 125mW(21 dBm) at any elevation angle above 30 degrees as measured from the horizon)
		Fixed point-to-point Access Point	1 Watt (30 dBm)
		Indoor Access Point	1 Watt (30 dBm)
	√	Mobile and Portable client device	250mW (24 dBm)
U-NII-2A	---		250mW (24 dBm) or 11 dBm+10 log B*
U-NII-2C	---		250mW (24 dBm) or 11 dBm+10 log B*
U-NII-3	---		1 Watt (30 dBm)

NOTE: Where B is the 26dB emission bandwidth in MHz.

4.3.2 TEST SETUP

FOR POWER OUTPUT MEASUREMENT

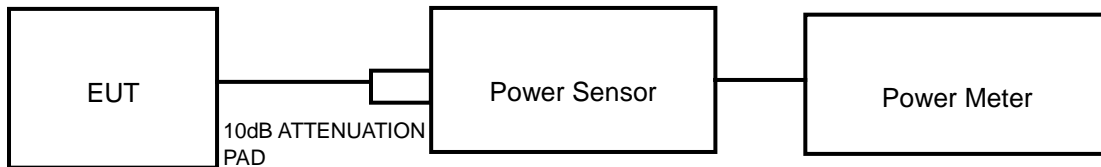

FOR 26dB BANDWIDTH

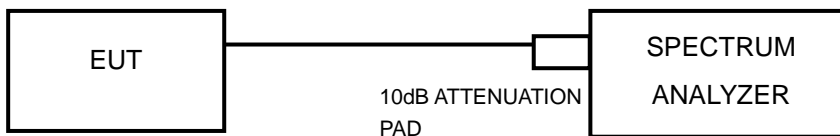



4.3.3 TEST INSTRUMENTS

Refer to section 4.1.3 to get information of above instrument.

4.3.4 TEST PROCEDURE

FOR POWER MEASUREMENT

Method PM is used to perform output power measurement, trigger and gating function of wide band power meter is enabled to measure max output power of TX on burst. Duty factor is not added to measured value.

FOR 26dB BANDWIDTH

- 1) Set RBW = approximately 1% of the emission bandwidth.
- 2) Set the VBW > RBW.
- 3) Detector = Peak.
- 4) Trace mode = max hold.
- 5) Measure the maximum width of the emission that is 26 dB down from the peak of the emission. Compare this with the RBW setting of the analyzer. Readjust RBW and repeat measurement as needed until the RBW/EBW ratio is approximately 1%.

4.3.5 DEVIATION FROM TEST STANDARD

No deviation.

4.3.6 EUT OPERATING CONDITIONS

The software provided by client to enable the EUT under transmission condition continuously at specific channel frequencies individually.



4.3.7 TEST RESULTS

OUTPUT POWER:

802.11a

CHANNEL	CHANNEL FREQUENCY (MHz)	MAX. OUTPUT POWER (mW)	MAX. OUTPUT POWER (dBm)	POWER LIMIT (dBm)	PASS/FAIL
36	5180	43.954	16.43	24	PASS
40	5200	38.637	15.87	24	PASS
48	5240	41.976	16.23	24	PASS
52	5260	66.222	18.21	24	PASS
60	5300	66.069	18.20	24	PASS
64	5320	64.269	18.08	24	PASS
100	5500	62.517	17.96	24	PASS
116	5580	53.456	17.28	24	PASS
140	5700	66.834	18.25	24	PASS
149	5745	63.533	18.03	30	PASS
153	5785	62.373	17.95	30	PASS
161	5805	64.121	18.07	30	PASS

802.11n (20MHz)

CHANNEL	CHANNEL FREQUENCY (MHz)	MAX. OUTPUT POWER (mW)	MAX. OUTPUT POWER (dBm)	POWER LIMIT (dBm)	PASS/FAIL
36	5180	44.259	16.46	24	PASS
40	5200	39.446	15.96	24	PASS
48	5240	41.495	16.18	24	PASS
52	5260	65.464	18.16	24	PASS
60	5300	65.917	18.19	24	PASS
64	5320	63.826	18.05	24	PASS
100	5500	62.087	17.93	24	PASS
116	5580	53.703	17.30	24	PASS
140	5700	67.298	18.28	24	PASS
149	5745	63.533	18.03	30	PASS
157	5785	62.517	17.96	30	PASS
161	5805	64.269	18.08	30	PASS



802.11n (40MHz)

CHANNEL	CHANNEL FREQUENCY (MHz)	MAX. OUTPUT POWER (mW)	MAX. OUTPUT POWER (dBm)	POWER LIMIT (dBm)	PASS/FAIL
38	5190	47.315	16.75	24	PASS
46	5230	41.976	16.23	24	PASS
54	5270	66.681	18.24	24	PASS
62	5310	68.234	18.34	24	PASS
102	5510	76.913	18.86	24	PASS
110	5550	68.234	18.34	24	PASS
134	5670	87.297	19.41	24	PASS
151	5755	79.433	19.00	30	PASS
159	5795	80.353	19.05	30	PASS



26dB BANDWIDTH & 6dB BANDWIDTH:

802.11a

CHANNEL	CHANNEL FREQUENCY (MHz)	26dBc BANDWIDTH (MHz)	PASS / FAIL
36	5180	20.22	PASS
40	5200	19.93	PASS
48	5240	20.38	PASS
52	5260	19.94	PASS
60	5300	20.57	PASS
64	5320	19.62	PASS
100	5500	20.57	PASS
116	5580	21.23	PASS
140	5700	20.81	PASS
CHANNEL	CHANNEL FREQUENCY (MHz)	6dBc BANDWIDTH (MHz)	PASS / FAIL
149	5745	16.38	PASS
157	5785	16.41	PASS
161	5805	16.38	PASS

802.11n (20MHz)

CHANNEL	CHANNEL FREQUENCY (MHz)	26dBc BANDWIDTH (MHz)	PASS / FAIL
36	5180	20.94	PASS
40	5200	20.70	PASS
48	5240	21.15	PASS
52	5260	21.19	PASS
60	5300	20.87	PASS
64	5320	20.58	PASS
100	5500	20.78	PASS
116	5580	21.46	PASS
140	5700	20.77	PASS
CHANNEL	CHANNEL FREQUENCY (MHz)	6dBc BANDWIDTH (MHz)	PASS / FAIL
149	5500	17.60	PASS
157	5580	17.62	PASS
161	5700	17.62	PASS



802.11n (40MHz)

CHANNEL	CHANNEL FREQUENCY (MHz)	26dBc BANDWIDTH (MHz)	PASS / FAIL
38	5190	42.95	PASS
46	5230	42.87	PASS
54	5270	43.40	PASS
62	5310	44.06	PASS
102	5510	43.19	PASS
110	5550	43.90	PASS
134	5670	42.83	PASS
CHANNEL	CHANNEL FREQUENCY (MHz)	6dBc BANDWIDTH (MHz)	PASS / FAIL
151	5755	35.27	PASS
159	5795	35.32	PASS



4.4 PEAK POWER SPECTRAL DENSITY MEASUREMENT

4.4.1 LIMITS OF PEAK POWER SPECTRAL DENSITY MEASUREMENT

Operation Band	EUT Category		LIMIT
U-NII-1		Outdoor Access Point	17dBm/ MHz
		Fixed point-to-point Access Point	
		Indoor Access Point	
	√	Mobile and Portable client device	11dBm/ MHz
U-NII-2A	---		11dBm/ MHz
U-NII-2C	---		11dBm/ MHz
U-NII-3	---		30dBm/ 500kHz

4.4.2 TEST SETUP

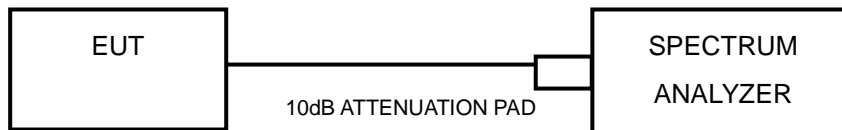

4.4.3 TEST INSTRUMENTS

Refer to section 4.1.3 to get information of above instrument.

4.4.4 TEST PROCEDURES

Using method SA-1

- 1) Set span to encompass the entire emission bandwidth (EBW) of the signal.
- 2) Set RBW = 30 KHz, Set VBW ≥ 1 MHz, Detector = RMS
- 3) Set Channel power measure = 1MHz
- 4) Sweep time = auto, trigger set to “free run”.
- 5) Trace average at least 100 traces in power averaging mode.
- 6) Record the max value



BUREAU Test Report No.: RF140801N015-5
VERITAS

4.4.5 DEVIATION FROM TEST STANDARD

No deviation.

4.4.6 EUT OPERATING CONDITIONS

Same as 4.1.6.



4.4.7 TEST RESULTS

For U-NII-1, U-NII-2A & U-NII-2C:

802.11a

CHANNEL	FREQUENCY (MHz)	PSD w/o Duty Factor (dBm/MHz)	Duty Factor	PSD with Duty Factor (dBm/MHz)	MAXIMUM LIMIT (dBm/MHz)	PASS/FAIL
36	5180	3.86	0.59	4.45	11	PASS
40	5200	3.8	0.59	4.39	11	PASS
48	5240	3.57	0.59	4.16	11	PASS
52	5260	4.32	0.59	4.91	11	PASS
60	5300	3.72	0.59	4.31	11	PASS
64	5320	3.42	0.59	4.01	11	PASS
100	5500	4.9	0.59	5.49	11	PASS
116	5580	5.73	0.59	6.32	11	PASS
140	5700	4.41	0.59	5	11	PASS

802.11n (20MHz)

CHANNEL	FREQUENCY (MHz)	PSD w/o Duty Factor (dBm/MHz)	Duty Factor	PSD with Duty Factor (dBm/MHz)	MAXIMUM LIMIT (dBm/MHz)	PASS/FAIL
36	5180	3.24	0.65	3.89	11	PASS
40	5200	2.87	0.65	3.52	11	PASS
48	5240	2.64	0.65	3.29	11	PASS
52	5260	3	0.65	3.65	11	PASS
60	5300	2.79	0.65	3.44	11	PASS
64	5320	2.65	0.65	3.3	11	PASS
100	5500	3.78	0.65	4.43	11	PASS
116	5580	4.31	0.65	4.96	11	PASS
140	5700	4.42	0.65	5.07	11	PASS



802.11n (40MHz)

CHANNEL	FREQUENCY (MHz)	PSD w/o Duty Factor (dBm/MHz)	Duty Factor	PSD with Duty Factor (dBm/MHz)	MAXIMUM LIMIT (dBm/MHz)	PASS/FAIL
38	5190	0.16	1.19	1.35	11	PASS
46	5230	-0.21	1.19	0.98	11	PASS
54	5270	0.07	1.19	1.26	11	PASS
62	5310	0.73	1.19	1.92	11	PASS
102	5510	0.84	1.19	2.03	11	PASS
110	5550	1.19	1.19	2.38	11	PASS
134	5670	0.66	1.19	1.85	11	PASS



For U-NII-3:

802.11a

CHANNEL	FREQUENCY (MHz)	PSD w/o Duty Factor (dBm/100kHz)	PSD w/o Duty Factor (dBm/500kHz)	Duty Factor	PSD with Duty Factor (dBm/500kHz)	LIMIT (dBm/500kHz)	PASS /FAIL
149	5745	-0.62	6.38	0.59	6.97	30	PASS
157	5785	-1.12	5.88	0.59	6.47	30	PASS
161	5805	-1.72	5.28	0.59	5.87	30	PASS

802.11n (20M)

CHANNEL	FREQUENCY (MHz)	PSD w/o Duty Factor (dBm/100kHz)	PSD w/o Duty Factor (dBm/500kHz)	Duty Factor	PSD with Duty Factor (dBm/500kHz)	LIMIT (dBm/500kHz)	PASS /FAIL
149	5745	-0.8	6.2	0.65	6.85	30	PASS
157	5785	-1.07	5.93	0.65	6.58	30	PASS
161	5805	-2.06	4.94	0.65	5.59	30	PASS

802.11n (40MHz)

CHANNEL	FREQUENCY (MHz)	PSD w/o Duty Factor (dBm/100kHz)	PSD w/o Duty Factor (dBm/500kHz)	Duty Factor	PSD with Duty Factor (dBm/500kHz)	LIMIT (dBm/500kHz)	PASS /FAIL
151	5755	-4.3	2.7	1.19	3.89	30	PASS
159	5795	-4.05	2.95	1.19	4.14	30	PASS



4.5 FREQUENCY STABILITY

4.5.1 LIMITS OF FREQUENCY STABILITY MEASUREMENT

The frequency of the carrier signal shall be maintained within band of operation

4.5.2 TEST SETUP

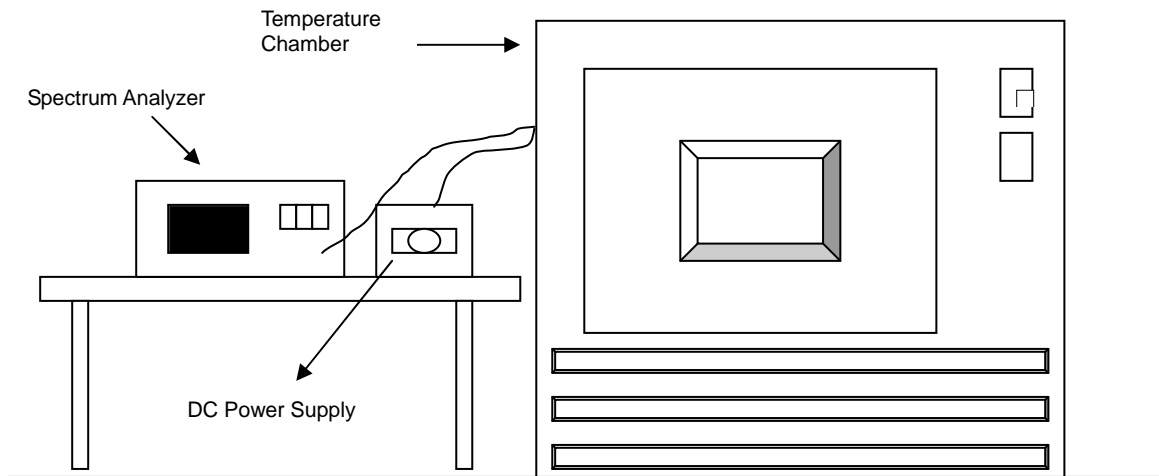

4.5.3 TEST INSTRUMENTS

Refer to section 4.1.3 to get information of above instrument.



4.5.4 TEST PROCEDURE

- a. The EUT was placed inside the environmental test chamber and powered by nominal DC voltage.
- b. Turn the EUT on and couple its output to a spectrum analyzer.
- c. Turn the EUT off and set the chamber to the highest temperature specified.
- d. Allow sufficient time (approximately 30 min) for the temperature of the chamber to stabilize, turn the EUT on and measure the operating frequency after 2, 5, and 10 minutes.
- e. Repeat step 2 and 3 with the temperature chamber set to the lowest temperature.
- f. The test chamber was allowed to stabilize at +20 degree C for a minimum of 30 minutes. The supply voltage was then adjusted on the EUT from 85% to 115% and the frequency record.

4.5.5 DEVIATION FROM TEST STANDARD

No deviation.

4.5.6 EUT OPERATING CONDITION

Set the EUT transmit at un-modulation mode to test frequency stability.



4.5.7 TEST RESULTS

FREQUENCY STABILITY VERSUS TEMP.									
OPERATING FREQUENCY: 5320MHz									
TEMP. (°C)	POWER SUPPLY (Vdc)	0 MINUTE		2 MINUTE		5 MINUTE		10 MINUTE	
		Measured Frequency (MHz)	Frequency Drift (%)	Measured Frequency (MHz)	Frequency Drift (%)	Measured Frequency (MHz)	Frequency Drift (%)	Measured Frequency (MHz)	Frequency Drift (%)
50	3.8	5320.0149	0.00028	5320.0145	0.00027	5320.015	0.00028	5320.0142	0.00027
40	3.8	5320.0156	0.00029	5320.0185	0.00035	5320.0167	0.00031	5320.0171	0.00032
30	3.8	5320.0001	0.00000	5320.0018	0.00003	5319.998	-0.00004	5320.0009	0.00002
20	3.8	5319.9984	-0.00003	5319.9941	-0.00011	5319.9935	-0.00012	5319.9958	-0.00008
10	3.8	5320.0033	0.00006	5320.0076	0.00014	5320.0074	0.00014	5320.0053	0.00010
0	3.8	5319.9774	-0.00042	5319.974	-0.00049	5319.9773	-0.00043	5319.9772	-0.00043
-10	3.8	5319.9998	0.00000	5320.0027	0.00005	5320.0029	0.00005	5320.0031	0.00006
-20	3.8	5320.0171	0.00032	5320.0175	0.00033	5320.017	0.00032	5320.0188	0.00035
-30	3.8	5319.9797	-0.00038	5319.9816	-0.00035	5319.9778	-0.00042	5319.9815	-0.00035

FREQUENCY STABILITY VERSUS VOLTAGE									
OPERATING FREQUENCY: 5320MHz									
TEMP. (°C)	POWER SUPPLY (Vdc)	0 MINUTE		2 MINUTE		5 MINUTE		10 MINUTE	
		Measured Frequency (MHz)	Frequency Drift (%)	Measured Frequency (MHz)	Frequency Drift (%)	Measured Frequency (MHz)	Frequency Drift (%)	Measured Frequency (MHz)	Frequency Drift (%)
20	4.35	5319.9993	-0.00001	5319.9935	-0.00012	5319.9937	-0.00012	5319.9957	-0.00008
	3.8	5319.9984	-0.00003	5319.9941	-0.00011	5319.9935	-0.00012	5319.9958	-0.00008
	3.5	5319.9976	-0.00005	5319.9943	-0.00011	5319.9927	-0.00014	5319.996	-0.00008



Test Report No.: RF140801N015-5

5. PHOTOGRAPHS OF THE TEST CONFIGURATION

Please refer to the attached file (Test Setup Photo).



Test Report No.: RF140801N015-5

6. APPENDIX A – MODIFICATIONS RECORDERS FOR ENGINEERING CHANGES TO THE EUT BY THE LAB

No modifications were made to the EUT by the lab during the test.

---END---