



Test Report No.: RF140722N046-1



FCC TEST REPORT (PART 27)

REPORT NO.: RF140722N046-1
MODEL NO.: XP6700
Type Number: L12V011AA, L13V011AA
FCC ID: WYPL11V011AA
RECEIVED: Jul. 22, 2014
TESTED: Jul. 22 ~ Jul. 28, 2014
ISSUED: Jul. 29, 2014

APPLICANT: Sonim Technologies, Inc.

ADDRESS: 1825 S. Grant St., Suite 200., San Mateo, CA, 94402

ISSUED BY: Bureau Veritas Shenzhen Co., Ltd. Dongguan Branch

LAB ADDRESS: No. 34, Chenwulu Section, Guantai Road, Houjie Town, Dongguan City, Guangdong 523942, China

TEST LOCATION: No. 34, Chenwulu Section, Guantai Road, Houjie Town, Dongguan City, Guangdong 523942, China

This report should not be used by the client to claim product certification, approval, or endorsement by A2LA or any government agencies.

This report is for your exclusive use. Any copying or replication of this report to or for any other person or entity, or use of our name or trademark, is permitted only with our prior written permission. This report sets forth our findings solely with respect to the test samples identified herein. The results set forth in this report are not indicative or representative of the quality or characteristics of the lot from which a test sample was taken or any similar or identical product unless specifically and expressly noted. Our report includes all of the tests requested by you and the results thereof based upon the information that you provided to us. You have 60 days from date of issuance of this report to notify us of any material error or omission caused by our negligence, provided, however, that such notice shall be in writing and shall specifically address the issue you wish to raise. A failure to raise such issue within the prescribed time shall constitute your unqualified acceptance of the completeness of this report, the tests conducted and the correctness of the report contents. Unless specific mention, the uncertainty of measurement has been explicitly taken into account to declare the compliance or non-compliance to the specification

**Bureau Veritas Shenzhen Co., Ltd.
Dongguan Branch**

No. 34, Chenwulu Section, Guantai Rd.,
Houjie Town, Dongguan City,
Guangdong 523942, China

Tel: +86 769 8593 5656
Fax: +86 769 8593 1080
Email: customerservice.dg@cn.bureauveritas.com



TABLE OF CONTENTS

RELEASE CONTROL RECORD 4

1 CERTIFICATION 5

2 SUMMARY OF TEST RESULTS 6

2.1 MEASUREMENT UNCERTAINTY 6

2.2 TEST SITE AND INSTRUMENTS 7

3 GENERAL INFORMATION 8

3.1 GENERAL DESCRIPTION OF EUT 8

3.2 CONFIGURATION OF SYSTEM UNDER TEST 11

3.3 DESCRIPTION OF SUPPORT UNITS 12

3.4 DESCRIPTION OF TEST MODES 12

3.5 GENERAL DESCRIPTION OF APPLIED STANDARDS 17

4 TEST TYPES AND RESULTS 18

4.1 OUTPUT POWER MEASUREMENT 18

4.1.1 LIMITS OF OUTPUT POWER MEASUREMENT 18

4.1.2 TEST PROCEDURES 18

4.1.3 TEST SETUP 19

4.1.4 TEST RESULTS 20

4.2 FREQUENCY STABILITY MEASUREMENT 39

4.2.1 LIMITS OF FREQUENCY STABILITY MEASUREMENT 39

4.2.2 TEST PROCEDURE 39

4.2.3 TEST SETUP 39

4.2.4 TEST RESULTS 40

4.3 OCCUPIED BANDWIDTH MEASUREMENT 43

4.3.1 LIMITS OF OCCUPIED BANDWIDTH MEASUREMENT 43

4.3.2 TEST SETUP 43

4.3.3 TEST PROCEDURES 43

4.3.4 TEST RESULTS 44

4.4 PEAK TO AVERAGE RATIO 50

4.4.1 LIMITS OF PEAK TO AVERAGE RATIO MEASUREMENT 50

4.4.2 TEST SETUP 50

4.4.3 TEST PROCEDURES 50

4.4.4 TEST RESULTS 51

4.5 BAND EDGE MEASUREMENT 63

4.5.1 LIMITS OF BAND EDGE MEASUREMENT 63

4.5.2 TEST SETUP 63

4.5.3 TEST PROCEDURES 63

4.5.4 TEST RESULTS 65

4.6 CONDUCTED SPURIOUS EMISSIONS 77

4.6.1 LIMITS OF CONDUCTED SPURIOUS EMISSIONS MEASUREMENT 77

4.6.2 TEST PROCEDURE 77

4.6.3 TEST SETUP 77

4.6.4 TEST RESULTS 78

4.7 RADIATED EMISSION MEASUREMENT 81

4.7.1 LIMITS OF RADIATED EMISSION MEASUREMENT 81

4.7.2 TEST PROCEDURES 81

4.7.3 DEVIATION FROM TEST STANDARD 81

4.7.4 TEST SETUP 82



Test Report No.: RF140722N046-1

4.7.5	TEST RESULTS	83
5	INFORMATION ON THE TESTING LABORATORIES	101
6	APPENDIX A – MODIFICATIONS RECORDERS FOR ENGINEERING CHANGES TO THE EUT BY THE LAB	102



Test Report No.: RF140722N046-1

RELEASE CONTROL RECORD

ISSUE NO.	REASON FOR CHANGE	DATE ISSUED
RF140408N042-1	Original release	Jul. 08, 2014
RF140722N046-1	Based on the original report RF140408N042-1 change the type Number. Meanwhile, LTE band 12 was switch on and added in to test report	Jul. 29, 2014



Test Report No.: RF140722N046-1

1 CERTIFICATION

PRODUCT: LTE Smartphone
MODEL NO.: XP6700
TYPE NUMBER: L12V011AA, L13V011AA
BRAND: Sonim
APPLICANT: Sonim Technologies, Inc.
TESTED: Jul. 22 ~ Jul. 28, 2014
TEST SAMPLE: ENGINEERING SAMPLE
TEST STANDARDS: **FCC Part 27, Subpart C, L**
FCC Part 2
ANSI C63.4-2003

The above equipment has been tested by **Bureau Veritas Shenzhen Co., Ltd. Dongguan Branch**, and found compliance with the requirement of the above standards. The test record, data evaluation & Equipment Under Test (EUT) configurations represented herein are true and accurate accounts of the measurements of the sample's EMC characteristics under the conditions specified in this report.

TESTED BY :  , **DATE** : Jul. 29, 2014
Glyn He/ Project Engineer

APPROVED BY :  , **DATE** : Jul. 29, 2014
Sam Tung / Technical Manager

2 SUMMARY OF TEST RESULTS

The EUT has been tested according to the following specifications:

APPLIED STANDARD: FCC Part 27 & Part 2			
STANDARD SECTION	TEST TYPE AND LIMIT	RESULT	REMARK
2.1046 27.50(d)(4)	Maximum Peak Output Power	PASS	Meet the requirement of limit.
2.1055 27.54	Frequency Stability	PASS	Meet the requirement of limit.
2.1049 27.53(h)	Occupied Bandwidth	PASS	Meet the requirement of limit.
27.50(d)(5)	Peak to average ratio	PASS	Meet the requirement of limit.
27.53(h)	Band Edge Measurements	PASS	Meet the requirement of limit.
2.1051 27.53(h)	Conducted Spurious Emissions	PASS	Meet the requirement of limit.
2.1053 27.53(h)	Radiated Spurious Emissions	PASS	Meet the requirement of limit. Minimum passing margin is -19.09dB at 8662.5MHz.

2.1 MEASUREMENT UNCERTAINTY

Where relevant, the following measurement uncertainty levels have been estimated for tests performed on the EUT as specified in CISPR 16-4-2:

MEASUREMENT	FREQUENCY	UNCERTAINTY
Conducted emissions	9kHz~30MHz	2.67dB
Radiated emissions	9KHz ~ 30MHz	2.74dB
	30MHz ~ 1GMHz	4.36dB
	1GHz ~ 18GHz	3.9dB
	18GHz ~ 40GHz	1.94dB

This uncertainty represents an expanded uncertainty expressed at approximately the 95% confidence level using a coverage factor of k=2.



2.2 TEST SITE AND INSTRUMENTS

Equipment	Manufacturer	Model No.	Serial No.	Last Cal.	Next Cal.
Spectrum Analyzer	Agilent	E4446A	MY46180622	Apr. 29,14	Apr. 28,15
Spectrum Analyzer (10Hz~40GHz)	Rohde&Schwarz	FSV40	101003	Apr. 09,14	Apr. 08,15
Signal Analyzer	Rohde&Schwarz	FSV7	102331	Nov. 25,13	Nov. 24,14
EMI Test Receiver	Rohde&Schwarz	ESVD	ESVS10	May 18,14	May 17,15
Loop antenna (9kHz~30MHz)	Daze	ZN30900A	0708	Nov. 28,13	Nov. 27,14
Bilog Antenna (20MHz~2GHz)	Teseq	CBL 6111D	30643	Jul. 27, 14	Jul. 26, 15
Horn Antenna (1GHz -18GHz)	ETS -Lindgren	3117	00062558	Oct. 18, 12	Oct. 17, 14
Horn Antenna (15GHz-40GHz)	SCHWARZBECK	BBHA 9170	BBHA9170242	Feb. 13,14	Feb. 12,15
Signal Amplifier	Agilent	8447D	2944A10488	Jun. 25,14	Jun. 24,15
Pre-Amplifier (100MHz-26.5GHz)	Agilent	8449B	3008A00409	May 13,14	May 12,15
Pre-Amplifier (18GHz-40GHz)	EMCI	EMC 184045	980102	Nov. 04,13	Nov. 03,14
Digital Multimeter	FLUKE	15B	A1220010DG	Oct. 30, 13	Oct. 29, 14
Power Sensor	Anritsu	MA2411B	1126068	Feb. 21,14	Feb. 20,15
Power Meter	Anritsu	ML2495A	1139001	Feb. 21,14	Feb. 20,15
3m Semi-anechoic Chamber	ETS-LINDGREN	9m*6m*6m	NSEMC003	Apr. 19,14	Apr. 18,15
Humid & Temp Programmable Tester	Haida	HD-2257	110807201	Sep. 17,13	Sep. 16,14
Universal Radio Communication Tester	Rohde&Schwarz	CMU 200	123259	Apr. 16,13	Apr. 15,15
RADIO COMMUNICATION ANALYZER	Anritsu	8820C	6201300716	Sep. 26,13	Sep. 26,14
Test Software	ADT	ADT_Radiated_V7.6.15.9.2	N/A	N/A	N/A

- NOTE:**
1. The calibration interval of the above test instruments is 12 months or 24 months and the calibrations are traceable to CEPREI/CHINA, GRGT/CHINA and NIM/CHINA.
 2. The test was performed in Dongguan 966 Chamber.
 3. The horn antenna are used only for the measurement of emission frequency above 1GHz if tested.
 4. The FCC Site Registration No. is 502831.



3 GENERAL INFORMATION

3.1 GENERAL DESCRIPTION OF EUT

PRODUCT	LTE Smartphone	
MODEL NO.	XP6700	
Type Number	L12V011AA, L13V011AA	
POWER SUPPLY	5Vdc (adapter or host equipment) 3.8Vdc (battery)	
MODULATION TECHNOLOGY	LTE Band 4	QPSK, 16QAM
	LTE Band 12	QPSK, 16QAM
	LTE Band 17	QPSK, 16QAM
FREQUENCY RANGE	LTE Band 4 Channel Bandwidth: 1.4MHz	1710.7MHz ~ 1754.3MHz
	LTE Band 4 Channel Bandwidth: 3MHz	1711.5MHz ~ 1753.5MHz
	LTE Band 4 Channel Bandwidth: 5MHz	1712.5MHz ~ 1752.5MHz
	LTE Band 4 Channel Bandwidth: 10MHz	1715.0MHz ~ 1750.0MHz
	LTE Band 4 Channel Bandwidth: 15MHz	1717.5MHz ~ 1747.5MHz
	LTE Band 4 Channel Bandwidth: 20MHz	1720.0MHz ~ 1745.0MHz
	LTE Band 12 Channel Bandwidth: 1.4MHz	699.7MHz ~ 715.3MHz
	LTE Band 12 Channel Bandwidth: 3MHz	700.5MHz ~ 714.5MHz
	LTE Band 12 Channel Bandwidth: 5MHz	701.5MHz ~ 713.5MHz
	LTE Band 12 Channel Bandwidth: 10MHz	704.0MHz ~ 711.0MHz
	LTE Band 17 Channel Bandwidth: 5MHz	706.5MHz ~ 713.5MHz
	LTE Band 17 Channel Bandwidth: 10MHz	709.0MHz ~ 711.0MHz
	EMISSION DESIGNATOR	LTE Band 4 Channel Bandwidth: 1.4MHz
16QAM: 1M10W7D		
LTE Band 4 Channel Bandwidth: 3MHz		QPSK: 2M70G7D
		16QAM: 2M69W7D
LTE Band 4 Channel Bandwidth: 5MHz		QPSK: 4M52G7D
		16QAM: 4M50W7D
LTE Band 4 Channel Bandwidth: 10MHz		QPSK: 9M00G7D
		16QAM: 8M97W7D



Test Report No.: RF140722N046-1

EMISSION DESIGNATOR	LTE Band 4 Channel Bandwidth: 15MHz	QPSK: 13M6G7D 16QAM: 13M6W7D
	LTE Band 4 Channel Bandwidth: 20MHz	QPSK: 18M0G7D 16QAM: 18M0W7D
	LTE Band 12 Channel Bandwidth: 1.4MHz	QPSK: 1M09G7D 16QAM: 1M09W7D
	LTE Band 12 Channel Bandwidth: 3MHz	QPSK: 2M70G7D 16QAM: 2M69W7D
	LTE Band 12 Channel Bandwidth: 5MHz	QPSK: 4M50G7D 16QAM: 4M50W7D
	LTE Band 12 Channel Bandwidth: 10MHz	QPSK: 8M97G7D 16QAM: 8M97W7D
	LTE Band 17 Channel Bandwidth: 5MHz	QPSK: 4M50G7D 16QAM: 4M49W7D
	LTE Band 17 Channel Bandwidth: 10MHz	QPSK: 8M97G7D 16QAM: 8M97W7D
	MAX. ERP/EIRP POWER	LTE Band 4 Channel Bandwidth: 1.4MHz
LTE Band 4 Channel Bandwidth: 3MHz		QPSK: 488.65mW 16QAM: 386.37mW
LTE Band 4 Channel Bandwidth: 5MHz		QPSK: 486.41mW 16QAM: 405.51mW
LTE Band 4 Channel Bandwidth: 10MHz		QPSK: 433.51mW 16QAM: 352.37mW
LTE Band 4 Channel Bandwidth: 15MHz		QPSK: 392.64mW 16QAM: 316.23mW
LTE Band 4 Channel Bandwidth: 20MHz		QPSK: 438.53mW 16QAM: 338.84mW
LTE Band 12 Channel Bandwidth: 1.4MHz		QPSK: 229.09mW 16QAM: 185.35mW
LTE Band 12 Channel Bandwidth: 3MHz		QPSK: 236.59mW 16QAM: 191.87mW
LTE Band 12 Channel Bandwidth: 5MHz		QPSK: 233.35mW 16QAM: 190.55mW
LTE Band 12 Channel Bandwidth: 10MHz		QPSK: 233.88mW 16QAM: 190.55mW
LTE Band 17 Channel Bandwidth: 5MHz		QPSK: 214.29mW 16QAM: 172.98mW
LTE Band 17 Channel Bandwidth: 10MHz		QPSK: 215.77mW 16QAM: 179.47mW

Bureau Veritas Shenzhen Co., Ltd.
Dongguan Branch

No. 34, Chenwulu Section, Guantai Rd.,
Houjie Town, Dongguan City,
Guangdong 523942, China

Tel: +86 769 8593 5656
Fax: +86 769 8593 1080
Email: customerservice.dg@cn.bureauveritas.com



Test Report No.: RF140722N046-1

ANTENNA TYPE	LTE Band 4	Fixed Internal antenna with 0.8dBi gain
	LTE Band 12	Fixed Internal antenna with -0.6dBi gain
	LTE Band 17	Fixed Internal antenna with -0.6dBi gain
HW VERSION	A	
SW VERSION	6A.0.0-00-4.4.2-10.04.18	
DATA CABLE	USB Cable: Shielded, Detachable, 1.1m Earphone Cable: Unshielded, Detachable, 1.2m	
I/O PORTS	Refer to users' manual	

NOTE:

1. The EUT consumes power from the following adapter.

ADAPTER	
BRAND:	Sonim
MODEL:	S11C02
INPUT:	100-240Vac, 50-60Hz, 450mA
OUTPUT:	5Vdc, 2100mA
DC LINE:	N/A

2. The above EUT information is declared by manufacturer and for more detailed features description, please refer to the manufacturer's specifications or User's Manual.

3.2 CONFIGURATION OF SYSTEM UNDER TEST

FOR RADIATION EMISSION TEST

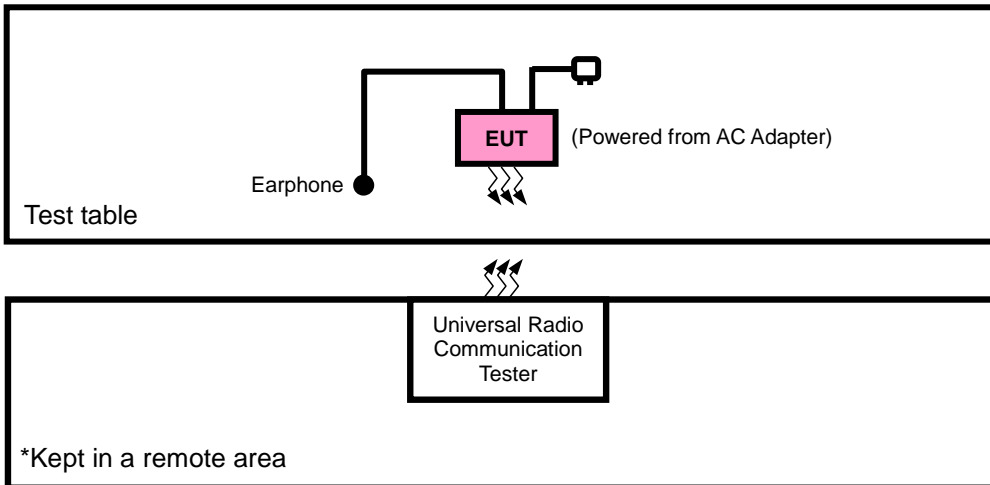

FOR E.R.P./E.I.R.P TEST

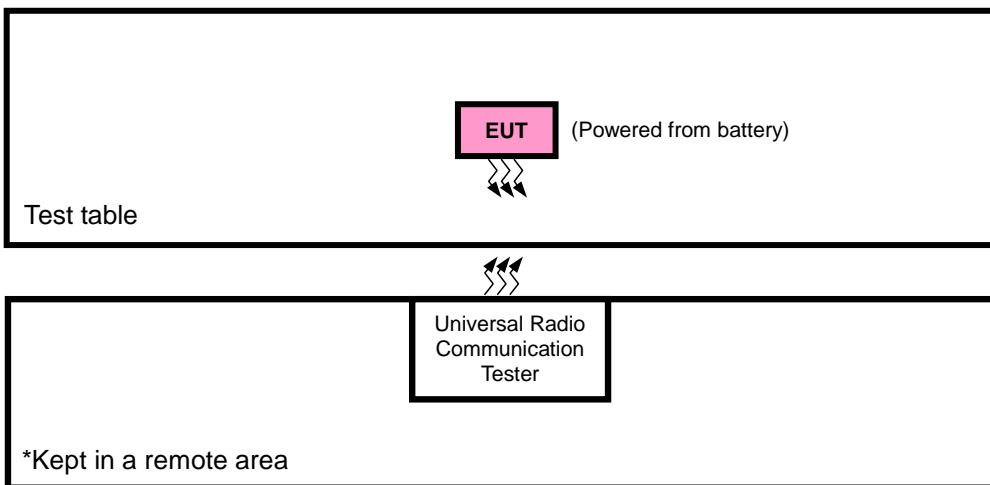



3.3 DESCRIPTION OF SUPPORT UNITS

The EUT has been tested as an independent unit together with other necessary accessories or support units. The following support units or accessories were used to form a representative test configuration during the tests.

NO.	PRODUCT	BRAND	MODEL NO.	SERIAL NO.	FCC ID
1	NA	NA	NA	NA	NA

NO.	SIGNAL CABLE DESCRIPTION OF THE ABOVE SUPPORT UNITS
1	NA

NOTE:

- 1. All power cords of the above support units are non shielded (1.8m).

3.4 DESCRIPTION OF TEST MODES

Pre-Scan has been conducted to determine the worst-case mode from all possible combinations between available modulations, data rates, XYZ axis and antenna ports. The worst case was found when positioned on Y-plane for ERP/EIRP and X-axis for radiated emission. Following channel(s) was (were) selected for the final test as listed below:

EUT CONFIGURE MODE	DESCRIPTION
A	EUT + Adapter with LTE link
B	EUT + Battery with LTE link



Test Report No.: RF140722N046-1

LTE BAND 4

EUT CONFIGURE MODE	TEST ITEM	AVAILABLE CHANNEL	TESTED CHANNEL	CHANNEL BANDWIDTH	MODULATION	MODE
B	EIRP	19957 to 20393	19957, 20175, 20393	1.4MHz	QPSK, 16QAM	1 RB / 0 RB Offset
		19965 to 20385	19965, 20175, 20385	3MHz	QPSK, 16QAM	1 RB / 14 RB Offset
		19975 to 20375	19975, 20175, 20375	5MHz	QPSK, 16QAM	1 RB / 0 RB Offset
		20000 to 20350	20000, 20175, 20350	10MHz	QPSK, 16QAM	1 RB / 0 RB Offset
		20025 to 20325	20025, 20175, 20325	15MHz	QPSK, 16QAM	1 RB / 0 RB Offset
		20050 to 20300	20050, 20175, 20300	20MHz	QPSK, 16QAM	1 RB / 50 RB Offset
B	FREQUENCY STABILITY	19957 to 20393	20175	1.4MHz	QPSK	1 RB / 0 RB Offset
		19965 to 20385	20175	3MHz	QPSK	1 RB / 14 RB Offset
		19975 to 20375	20175	5MHz	QPSK	1 RB / 0 RB Offset
		20000 to 20350	20175	10MHz	QPSK	1 RB / 0 RB Offset
		20025 to 20325	20175	15MHz	QPSK	1 RB / 0 RB Offset
		20050 to 20300	20175	20MHz	QPSK	1 RB / 50 RB Offset
B	OCCUPIED BANDWIDTH	19957 to 20393	19957, 20175, 20393	1.4MHz	QPSK, 16QAM	6 RB / 0 RB Offset
		19965 to 20385	19965, 20175, 20385	3MHz	QPSK, 16QAM	15 RB / 0 RB Offset
		19975 to 20375	19975, 20175, 20375	5MHz	QPSK, 16QAM	25 RB / 0 RB Offset
		20000 to 20350	20000, 20175, 20350	10MHz	QPSK, 16QAM	50 RB / 0 RB Offset
		20025 to 20325	20025, 20175, 20325	15MHz	QPSK, 16QAM	75 RB / 0 RB Offset
		20050 to 20300	20050, 20175, 20300	20MHz	QPSK, 16QAM	100 RB / 0 RB Offset
B	PEAK TO AVERAGE RATIO	19957 to 20393	19957, 20175, 20393	1.4MHz	QPSK, 16QAM	1 RB / 2 RB Offset
		19965 to 20385	19965, 20175, 20385	3MHz	QPSK, 16QAM	1 RB / 7 RB Offset
		19975 to 20375	19975, 20175, 20375	5MHz	QPSK, 16QAM	1 RB / 12 RB Offset
		20000 to 20350	20000, 20175, 20350	10MHz	QPSK, 16QAM	1 RB / 24 RB Offset
		20025 to 20325	20025, 20175, 20325	15MHz	QPSK, 16QAM	1 RB / 37 RB Offset
		20050 to 20300	20050, 20175, 20300	20MHz	QPSK, 16QAM	1 RB / 50 RB Offset
B	BAND EDGE	19957 to 20393	19957	1.4MHz	QPSK	1 RB / 0 RB Offset 6 RB / 0 RB Offset
			20393	1.4MHz	QPSK	1 RB / 5 RB Offset 6 RB / 0 RB Offset
		19965 to 20385	19965	3MHz	QPSK	1 RB / 0 RB Offset 15 RB / 0 RB Offset
			20385	3MHz	QPSK	1 RB / 14 RB Offset 15 RB / 0 RB Offset
		19975 to 20375	19975	5MHz	QPSK	1 RB / 0 RB Offset 25 RB / 0 RB Offset
			20375	5MHz	QPSK	1 RB / 24 RB Offset 25 RB / 0 RB Offset
		20000 to 20350	20000	10MHz	QPSK	1 RB / 0 RB Offset 50 RB / 0 RB Offset
			20350	10MHz	QPSK	1 RB / 49 RB Offset 50 RB / 0 RB Offset



Test Report No.: RF140722N046-1

B	BAND EDGE	20025 to 20325	20025	15MHz	QPSK	1 RB / 0 RB Offset
			20325	15MHz	QPSK	75 RB / 0 RB Offset
		20050 to 20300	20050	20MHz	QPSK	1 RB / 74 RB Offset
			20300	20MHz	QPSK	75 RB / 0 RB Offset
		20050 to 20300	20050	20MHz	QPSK	1 RB / 0 RB Offset
			20300	20MHz	QPSK	100 RB / 0 RB Offset
B	CONDCUDETED EMISSION	19957 to 20393	20175	1.4MHz	QPSK	1 RB / 0 RB Offset
		19965 to 20385	20175	3MHz	QPSK	1 RB / 14 RB Offset
		19975 to 20375	20175	5MHz	QPSK	1 RB / 0 RB Offset
		20000 to 20350	20175	10MHz	QPSK	1 RB / 0 RB Offset
		20025 to 20325	20175	15MHz	QPSK	1 RB / 0 RB Offset
		20050 to 20300	20175	20MHz	QPSK	1 RB / 50 RB Offset
A	RADIATED EMISSION	19957 to 20393	20175	1.4MHz	QPSK	1 RB / 0 RB Offset
		19965 to 20385	20175	3MHz	QPSK	1 RB / 14 RB Offset
		19975 to 20375	20175	5MHz	QPSK	1 RB / 0 RB Offset
		20000 to 20350	20175	10MHz	QPSK	1 RB / 0 RB Offset
		20025 to 20325	20175	15MHz	QPSK	1 RB / 0 RB Offset
		20050 to 20300	20175	20MHz	QPSK	1 RB / 50 RB Offset

Note: This device was tested under all bandwidths, RB configurations and modulations. The worst case was found in QPSK modulation.

LTE BAND 12

EUT CONFIGURE MODE	TEST ITEM	AVAILABLE CHANNEL	TESTED CHANNEL	CHANNEL BANDWIDTH	MODULATION	MODE		
B	ERP	23017 to 23173	23017, 23095 , 23173	1.4MHz	QPSK,16QAM	1 RB / 5 RB Offset		
		23025 to 23165	23025, 23095 ,23165	3MHz	QPSK,16QAM	1 RB / 14 RB Offset		
		23035 to 23155	23035, 23095 ,23155	5MHz	QPSK,16QAM	1 RB / 24 RB Offset		
		23060 to 23130	23060, 23095 ,23130	10MHz	QPSK,16QAM	1 RB / 49 RB Offset		
B	FREQUENCY STABILITY	23017 to 23173	23095	1.4MHz	QPSK	1 RB / 5 RB Offset		
		23025 to 23165	23095	3MHz	QPSK	1 RB / 14 RB Offset		
		23035 to 23155	23095	5MHz	QPSK	1 RB / 24 RB Offset		
		23060 to 23130	23095	10MHz	QPSK	1 RB / 49 RB Offset		
B	OCCUPIED BANDWIDTH	23017 to 23173	23017, 23095 , 23173	1.4MHz	QPSK,16QAM	6 RB / 0 RB Offset		
		23025 to 23165	23025, 23095 ,23165	3MHz	QPSK,16QAM	15 RB / 0 RB Offset		
		23035 to 23155	23035, 23095 ,23155	5MHz	QPSK,16QAM	25 RB / 0 RB Offset		
		23060 to 23130	23060, 23095 ,23130	10MHz	QPSK,16QAM	50 RB / 0 RB Offset		
B	PEAK TO AVERAGE RATIO	23017 to 23173	23017, 23095 , 23173	1.4MHz	QPSK, 16QAM	1 RB / 2 RB Offset		
		23025 to 23165	23025, 23095 ,23165	3MHz	QPSK, 16QAM	1 RB / 7 RB Offset		
		23035 to 23155	23035, 23095 ,23155	5MHz	QPSK, 16QAM	1 RB / 12 RB Offset		
		23060 to 23130	23060, 23095 ,23130	10MHz	QPSK, 16QAM	1 RB / 24 RB Offset		
B	BAND EDGE	23017 to 23173	23017	1.4MHz	QPSK	1 RB / 0 RB Offset 6 RB / 0 RB Offset		
			23173	1.4MHz	QPSK	1 RB / 5 RB Offset 6 RB / 0 RB Offset		
		23025 to 23165	23025	3MHz	QPSK	1 RB / 0 RB Offset 15 RB / 0 RB Offset		
			23165	3MHz	QPSK	1 RB / 14 RB Offset 15 RB / 0 RB Offset		
		23035 to 23155	23035	5MHz	QPSK	1 RB / 0 RB Offset 25 RB / 0 RB Offset		
			23155	5MHz	QPSK	1 RB / 24 RB Offset 25 RB / 0 RB Offset		
		23060 to 23130	23060	10MHz	QPSK	1 RB / 0 RB Offset 50 RB / 0 RB Offset		
			23130	10MHz	QPSK	1 RB / 49 RB Offset 50 RB / 0 RB Offset		
		B	CONDCUDED EMISSION	23017 to 23173	23095	1.4MHz	QPSK	1 RB / 5 RB Offset
				23025 to 23165	23095	3MHz	QPSK	1 RB / 14 RB Offset
				23035 to 23155	23095	5MHz	QPSK	1 RB / 24 RB Offset
				23060 to 23130	23095	10MHz	QPSK	1 RB / 49 RB Offset
A	RADIATED EMISSION	23017 to 23173	23095	1.4MHz	QPSK	1 RB / 5 RB Offset		
		23025 to 23165	23095	3MHz	QPSK	1 RB / 14 RB Offset		
		23035 to 23155	23095	5MHz	QPSK	1 RB / 24 RB Offset		
		23060 to 23130	23095	10MHz	QPSK	1 RB / 49 RB Offset		

Note: This device was tested under all bandwidths, RB configurations and modulations. The worst case was found in QPSK modulation.



Test Report No.: RF140722N046-1

LTE BAND 17

EUT CONFIGURE MODE	TEST ITEM	AVAILABLE CHANNEL	TESTED CHANNEL	CHANNEL BANDWIDTH	MODULATION	MODE		
B	ERP	23755 to 23825	23755, 23790, 23825	5MHz	QPSK, 16QAM	1 RB / 12 RB Offset		
		23780 to 23800	23780, 23790, 23800	10MHz	QPSK, 16QAM	1 RB / 24 RB Offset		
B	FREQUENCY STABILITY	23755 to 23825	23790	5MHz	QPSK	1 RB / 12 RB Offset		
		23780 to 23800	23790	10MHz	QPSK	1 RB / 24 RB Offset		
B	OCCUPIED BANDWIDTH	23755 to 23825	23755, 23790, 23825	5MHz	QPSK, 16QAM	25 RB / 0 RB Offset		
		23780 to 23800	23780, 23790, 23800	10MHz	QPSK, 16QAM	50 RB / 0 RB Offset		
B	PEAK TO AVERAGE RATIO	23755 to 23825	23755, 23790, 23825	5MHz	QPSK, 16QAM	1 RB / 0 RB Offset		
		23780 to 23800	23780, 23790, 23800	10MHz	QPSK, 16QAM	1 RB / 0 RB Offset		
B	BAND EDGE	23755 to 23825	23755	5MHz	QPSK	1 RB / 0 RB Offset 25 RB / 0 RB Offset		
			23825	5MHz	QPSK	1 RB / 24 RB Offset 25 RB / 0 RB Offset		
		23780 to 23800	23780	10MHz	QPSK	1 RB / 0 RB Offset 50 RB / 0 RB Offset		
			23800	10MHz	QPSK	1 RB / 49 RB Offset 50 RB / 0 RB Offset		
		B	CONDCUDED EMISSION	23755 to 23825	23790	5MHz	QPSK	1 RB / 12 RB Offset
				23780 to 23800	23790	10MHz	QPSK	1 RB / 24 RB Offset
A	RADIATED EMISSION	23755 to 23825	23790	5MHz	QPSK	1 RB / 12 RB Offset		
		23780 to 23800	23790	10MHz	QPSK	1 RB / 24 RB Offset		

Note: This device was tested under all bandwidths, RB configurations and modulations. The worst case was found in QPSK modulation.

TEST CONDITION:

TEST ITEM	ENVIRONMENTAL CONDITIONS	INPUT POWER	TESTED BY
EIRP(ERP)	24deg. C, 60%RH	3.8Vdc from Battery	Blue Zeng
FREQUENCY STABILITY	24deg. C, 61%RH	3.8Vdc from Battery	Venless Long
OCCUPIED BANDWIDTH	24deg. C, 61%RH	3.8Vdc from Battery	Venless Long
PEAK TO AVERAGE RATIO	24deg. C, 61%RH	3.8Vdc from Battery	Venless Long
BAND EDGE	24deg. C, 61%RH	3.8Vdc from Battery	Venless Long
CONDCUDED EMISSION	24deg. C, 61%RH	3.8Vdc from Battery	Venless Long
RADIATED EMISSION	24deg. C, 60%RH	5Vdc from adapter	Blue Zeng



Test Report No.: RF140722N046-1

3.5 GENERAL DESCRIPTION OF APPLIED STANDARDS

The EUT is a RF product. According to the specifications of the manufacturer, it must comply with the requirements of the following standards:

FCC 47 CFR Part 2

FCC 47 CFR Part 27

ANSI/TIA/EIA-603-C 2004

NOTE: All test items have been performed and recorded as per the above standards.



4 TEST TYPES AND RESULTS

4.1 OUTPUT POWER MEASUREMENT

4.1.1 LIMITS OF OUTPUT POWER MEASUREMENT

Fixed, mobile, and portable (hand-held) stations operating in the 1710–1755 MHz band are limited to 1 watt EIRP.

Portable stations (hand-held devices) operating in the 699-716 MHz band are limited to 3 watts ERP.

4.1.2 TEST PROCEDURES

EIRP / ERP MEASUREMENT:

- a. The EUT was set up for the maximum power with LTE link data modulation. The power was measured with R&S Spectrum Analyzer. All measurements were done at 3 channels (low, middle and high operational frequency range). RBW and VBW is 10MHz for LTE.
- b. E.I.R.P power measurement. In the semi-anechoic chamber, EUT placed on the 0.8m height of Turn Table, rotated the table around 360 degrees to search the maximum radiation power and receiver antenna shall be rotated vertical and horizontal polarization and moved height from 1m to 4m to find the maximum polar radiated power. The “Read Value” is the spectrum reading the maximum power value.
- c. The substitution horn antenna is substituted for EUT at the same position and signals generator export the CW signal to the substitution antenna via a TX cable. Rotated the Turn Table and moved receiving antenna to find the maximum radiation power. Adjust output power level of S.G to get a Value of spectrum reading equal to “Read Value” of step a. Record the power level of S.G
- d. $EIRP = \text{Output power level of S.G} - \text{TX cable loss} + \text{Antenna gain of substitution horn}$
- e. $E.R.P = E.I.R.P - 2.15 \text{ dB}$

CONDUCTED POWER MEASUREMENT:

- a. The EUT was set up for the maximum power with LTE link data modulation and link up with simulator.
- b. Set the EUT to transmit under low, middle and high channel and record the power level shown on simulator.

4.1.3 TEST SETUP

EIRP / ERP MEASUREMENT:

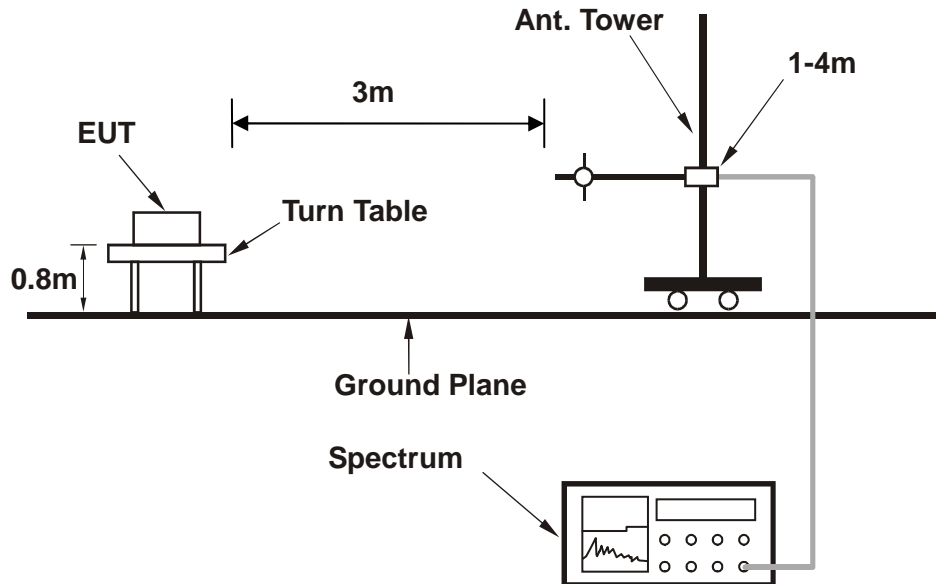

For the actual test configuration, please refer to the attached file (Test Setup Photo).

CONDUCTED POWER MEASUREMENT:

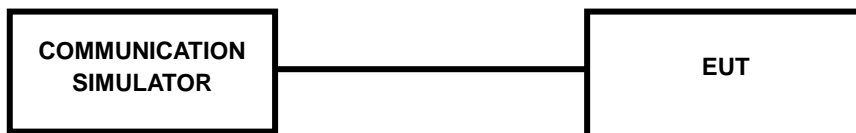

For the actual test configuration, please refer to the attached file (Test Setup Photo).



4.1.4 TEST RESULTS

AVERAGE CONDUCTED OUTPUT POWER (dBm)

LTE Band 4							
BW	Modulation	RB Size	RB Offset	Low CH 19957	Mid CH 20175	High CH 20393	MPR
				Frequency 1710.7 MHz	Frequency 1732.5 MHz	Frequency 1754.3 MHz	
1.4MHz	QPSK	1	0	23.82	23.74	23.68	0
		1	2	23.7	23.75	23.65	0
		1	5	23.67	23.63	23.75	0
		3	0	23.72	23.67	23.76	0
		3	1	23.77	23.73	23.69	0
		3	3	23.73	23.72	23.68	0
		6	0	22.62	22.7	22.76	1
	16QAM	1	0	22.74	22.81	22.84	1
		1	2	22.8	22.72	22.8	1
		1	5	22.82	22.8	22.73	1
		3	0	22.75	22.77	22.73	1
		3	1	22.8	22.7	22.7	1
		3	3	22.63	22.72	22.76	1
		6	0	21.7	21.72	21.71	2



Test Report No.: RF140722N046-1

LTE Band 4							
BW	Modulation	RB Size	RB Offset	Low CH 19965	Mid CH 20175	High CH 20385	MPR
				Frequency 1711.5 MHz	Frequency 1732.5 MHz	Frequency 1753.5 MHz	
3 MHz	QPSK	1	0	23.8	23.73	23.7	0
		1	7	23.68	23.67	23.66	0
		1	14	23.81	23.71	23.72	0
		8	0	22.71	22.64	22.83	1
		8	3	22.63	22.68	22.74	1
		8	7	22.63	22.65	22.68	1
		15	0	22.67	22.7	22.68	1
	16QAM	1	0	22.81	22.77	22.84	1
		1	7	22.71	22.82	22.72	1
		1	14	22.72	22.79	22.7	1
		8	0	21.69	21.67	21.75	2
		8	3	21.83	21.82	21.67	2
		8	7	21.68	21.69	21.74	2
		15	0	21.72	21.67	21.74	2
BW	Modulation	RB Size	RB Offset	Low CH 19975	Mid CH 20175	High CH 20375	MPR
				Frequency 1712.5 MHz	Frequency 1732.5 MHz	Frequency 1752.5 MHz	
5 MHz	QPSK	1	0	23.79	23.7	23.67	0
		1	12	23.74	23.69	23.78	0
		1	24	23.64	23.71	23.71	0
		12	0	22.69	22.65	22.65	1
		12	6	22.59	22.61	22.63	1
		12	13	22.67	22.71	22.68	1
		25	0	22.66	22.74	22.69	1
	16QAM	1	0	22.71	22.73	22.88	1
		1	12	22.8	22.75	22.83	1
		1	24	22.77	22.87	22.87	1
		12	0	21.65	21.69	21.65	2
		12	6	21.71	21.74	21.66	2
		12	13	21.72	21.69	21.76	2
		6	0	21.7	21.72	21.71	2



Test Report No.: RF140722N046-1

LTE Band 4							
BW	Modulation	RB Size	RB Offset	Low CH 20000	Mid CH 20175	High CH 20350	MPR
				Frequency 1715 MHz	Frequency 1732.5 MHz	Frequency 1750 MHz	
10 MHz	QPSK	1	0	23.63	23.6	23.75	0
		1	24	23.69	23.65	23.61	0
		1	49	23.63	23.61	23.66	0
		25	0	22.62	22.77	22.64	1
		25	12	22.67	22.7	22.61	1
		25	25	22.51	22.69	22.6	1
		50	0	22.67	22.68	22.69	1
	16QAM	1	0	22.64	22.67	22.85	1
		1	24	22.78	22.73	22.74	1
		1	49	22.62	22.75	22.77	1
		25	0	21.76	21.76	21.67	2
		25	12	21.75	21.75	21.68	2
		25	25	21.61	21.77	21.72	2
		50	0	21.78	21.73	21.7	2
BW	Modulation	RB Size	RB Offset	Low CH 20025	Mid CH 20175	High CH 20325	MPR
				Frequency 1717.5 MHz	Frequency 1732.5 MHz	Frequency 1747.5 MHz	
15 MHz	QPSK	1	0	23.66	23.71	23.74	0
		1	37	23.63	23.69	23.65	0
		1	74	23.71	23.71	23.7	0
		36	0	22.72	22.64	22.71	1
		36	19	22.56	22.67	22.6	1
		36	39	22.55	22.68	22.69	1
		75	0	22.56	22.68	22.62	1
	16QAM	1	0	22.72	22.72	22.82	1
		1	37	22.69	22.66	22.77	1
		1	74	22.88	22.79	22.79	1
		36	0	21.72	21.73	21.7	2
		36	19	21.6	21.69	21.66	2
		36	39	21.75	21.76	21.69	2
		75	0	21.72	21.79	21.67	2



Test Report No.: RF140722N046-1

LTE Band 4							
BW	Modulation	RB Size	RB Offset	Low CH 20050	Mid CH 20175	High CH 20300	MPR
				Frequency 1720 MHz	Frequency 1732.5 MHz	Frequency 1745 MHz	
20MHz	QPSK	1	0	23.67	23.65	23.7	0
		1	50	23.62	23.68	23.85	0
		1	99	23.58	23.66	23.65	0
		50	0	22.68	22.68	22.82	1
		50	25	22.64	22.68	22.72	1
		50	50	22.71	22.63	22.71	1
		100	0	22.62	22.69	22.7	1
	16QAM	1	0	22.77	22.78	22.63	1
		1	50	22.73	22.68	22.73	1
		1	99	22.89	22.61	22.7	1
		50	0	21.7	21.72	21.87	2
		50	25	21.63	21.71	21.66	2
		50	50	21.61	21.85	21.62	2
		100	0	21.76	21.73	21.8	2



Test Report No.: RF140722N046-1

LTE Band 12							
BW	Modulation	RB Size	RB Offset	Low CH 23017	Mid CH 23095	High CH 23173	MPR
				Frequency 699.7 MHz	Frequency 707.5 MHz	Frequency 715.3 MHz	
1.4 MHz	QPSK	1	0	23.74	23.74	23.7	0
		1	2	23.72	23.75	23.68	0
		1	5	23.72	23.78	23.74	0
		3	0	23.68	23.77	23.76	0
		3	1	23.74	23.71	23.74	0
		3	3	23.7	23.69	23.71	0
		6	0	22.79	22.74	22.73	1
	16QAM	1	0	22.75	22.84	22.82	1
		1	2	22.83	22.86	22.87	1
		1	5	22.7	22.86	22.77	1
		3	0	22.79	22.74	22.83	1
		3	1	22.74	22.73	22.82	1
		3	3	22.72	22.77	22.76	1
		6	0	21.64	21.8	21.76	2
BW	Modulation	RB Size	RB Offset	Low CH 23025	Mid CH 23095	High CH 23165	MPR
				Frequency 700.5 MHz	Frequency 707.5 MHz	Frequency 714.5 MHz	
3 MHz	QPSK	1	0	23.7	23.72	23.73	0
		1	7	23.65	23.7	23.77	0
		1	14	23.77	23.76	23.7	0
		8	0	22.77	22.7	22.6	1
		8	3	22.77	22.7	22.68	1
		8	7	22.8	22.68	22.66	1
		15	0	22.85	22.71	22.68	1
	16QAM	1	0	22.81	22.81	22.74	1
		1	7	22.75	22.83	22.75	1
		1	14	22.83	22.81	22.79	1
		8	0	21.68	21.77	21.68	2
		8	3	21.67	21.7	21.68	2
		8	7	21.8	21.66	21.71	2
		15	0	21.69	21.81	21.72	2



Test Report No.: RF140722N046-1

LTE Band 12							
BW	Modulation	RB Size	RB Offset	Low CH 23035	Mid CH 23095	High CH 23155	MPR
				Frequency 701.5 MHz	Frequency 707.5 MHz	Frequency 713.5 MHz	
5 MHz	QPSK	1	0	23.62	23.73	23.76	0
		1	12	23.75	23.69	23.73	0
		1	24	23.65	23.77	23.72	0
		12	0	22.84	22.67	22.78	1
		12	6	22.62	22.67	22.64	1
		12	13	22.7	22.65	22.71	1
		25	0	22.68	22.65	22.66	1
	16QAM	1	0	22.81	22.78	22.65	1
		1	12	22.87	22.73	22.72	1
		1	24	22.85	22.78	22.84	1
		12	0	21.67	21.71	21.76	2
		12	6	21.69	21.74	21.83	2
		12	13	21.79	21.76	21.8	2
		25	0	21.79	21.77	21.81	2
BW	Modulation	RB Size	RB Offset	Low CH 23060	Mid CH 23095	High CH 23130	MPR
				Frequency 704 MHz	Frequency 707.5 MHz	Frequency 711 MHz	
10 MHz	QPSK	1	0	23.69	23.76	23.7	0
		1	24	23.7	23.69	23.71	0
		1	49	23.72	23.86	23.76	0
		25	0	22.7	22.75	22.67	1
		25	12	22.72	22.67	22.79	1
		25	25	22.7	22.68	22.75	1
		50	0	22.72	22.74	22.8	1
	16QAM	1	0	22.74	22.86	22.82	1
		1	24	22.81	22.83	22.69	1
		1	49	22.81	22.73	22.87	1
		25	0	21.78	21.83	21.69	2
		25	12	21.86	21.77	21.76	2
		25	25	21.78	21.78	21.82	2
		50	0	21.75	21.84	21.8	2



**BUREAU
VERITAS**

Test Report No.: RF140722N046-1

LTE Band 17							
BW	Modulation	RB Size	RB Offset	Low CH 23755	Mid CH 23790	High CH 23825	MPR
				Frequency 706.5 MHz	Frequency 710 MHz	Frequency 713.5 MHz	
5 MHz	QPSK	1	0	23.67	23.69	23.59	0
		1	12	23.69	23.77	23.6	0
		1	24	23.62	23.72	23.67	0
		12	0	22.68	22.63	22.65	1
		12	6	22.68	22.62	22.7	1
		12	13	22.69	22.67	22.69	1
		25	0	22.73	22.64	22.66	1
	16QAM	1	0	22.7	22.69	22.78	1
		1	12	22.76	22.77	22.83	1
		1	24	22.71	22.65	22.79	1
		12	0	21.77	21.69	21.71	2
		12	6	21.75	21.67	21.72	2
		12	13	21.71	21.8	21.73	2
		25	0	21.77	21.77	21.73	2
BW	Modulation	RB Size	RB Offset	Low CH 23780	Mid CH 23790	High CH 23800	MPR
				Frequency 709 MHz	Frequency 710 MHz	Frequency 711 MHz	
10 MHz	QPSK	1	0	23.65	23.7	23.65	0
		1	24	23.71	23.79	23.6	0
		1	49	23.74	23.74	23.67	0
		25	0	22.7	22.65	22.65	1
		25	12	22.59	22.59	22.58	1
		25	25	22.82	22.7	22.71	1
		50	0	22.72	22.71	22.62	1
	16QAM	1	0	22.86	22.81	22.8	1
		1	24	22.65	22.86	22.8	1
		1	49	22.63	22.88	22.85	1
		25	0	21.76	21.74	21.76	2
		25	12	21.74	21.7	21.71	2
		25	25	21.67	21.75	21.77	2
		50	0	21.77	21.74	21.7	2

LTE BAND 4

CHANNEL BANDWIDTH: 1.4MHz QPSK

Channel	Frequency (MHz)	LVL (dBm)	Correction Factor(dB)	EIRP(dBm)	EIRP(mW)	Polarization (H/V)	LIMIT (W)
19957	1710.7	-19.71	41.17	21.46	139.96	H	1
20175	1732.5	-20.01	41.96	21.95	156.68	H	1
20393	1754.3	-21.36	42.79	21.43	139.00	H	1
19957	1710.7	-18.41	44.07	25.66	368.13	V	1
20175	1732.5	-18.93	44.76	25.83	382.82	V	1
20393	1754.3	-18.95	45.53	26.58	454.99	V	1

NOTE: EIRP (dBm) = LVL (dBm) + Correction Factor (dB)

CHANNEL BANDWIDTH: 1.4MHz 16QAM

Channel	Frequency (MHz)	LVL (dBm)	Correction Factor(dB)	EIRP(dBm)	EIRP(mW)	Polarization (H/V)	LIMIT (W)
19957	1710.7	-20.79	41.17	20.38	109.14	H	1
20175	1732.5	-20.94	41.96	21.02	126.47	H	1
20393	1754.3	-22.20	42.79	20.59	114.55	H	1
19957	1710.7	-19.49	44.07	24.58	287.08	V	1
20175	1732.5	-19.86	44.76	24.90	309.03	V	1
20393	1754.3	-19.79	45.53	25.74	374.97	V	1

NOTE: EIRP (dBm) = LVL (dBm) + Correction Factor (dB)-2.15dB.



Test Report No.: RF140722N046-1

LTE BAND 4

CHANNEL BANDWIDTH: 3MHz QPSK

Channel	Frequency (MHz)	LVL (dBm)	Correction Factor(dB)	EIRP(dBm)	EIRP(mW)	Polarization (H/V)	LIMIT (W)
19965	1711.5	-19.72	41.22	21.50	141.25	H	1
20175	1732.5	-20.04	41.96	21.92	155.60	H	1
20385	1753.5	-21.32	42.64	21.32	135.52	H	1
19965	1711.5	-18.42	44.19	25.77	377.57	V	1
20175	1732.5	-18.96	44.76	25.80	380.19	V	1
20385	1753.5	-18.91	45.80	26.89	488.65	V	1

NOTE: EIRP (dBm) = LVL (dBm) + Correction Factor (dB)

CHANNEL BANDWIDTH: 3MHz 16QAM

Channel	Frequency (MHz)	LVL (dBm)	Correction Factor(dB)	EIRP(dBm)	EIRP(mW)	Polarization (H/V)	LIMIT (W)
19965	1711.5	-20.81	41.22	20.41	109.90	H	1
20175	1732.5	-20.96	41.96	21.00	125.89	H	1
20385	1753.5	-22.34	42.64	20.30	107.15	H	1
19965	1711.5	-19.51	44.19	24.68	293.76	V	1
20175	1732.5	-19.88	44.76	24.88	307.61	V	1
20385	1753.5	-19.93	45.80	25.87	386.37	V	1

NOTE: EIRP (dBm) = LVL (dBm) + Correction Factor (dB)



Test Report No.: RF140722N046-1

LTE BAND 4

CHANNEL BANDWIDTH: 5MHz QPSK

Channel	Frequency (MHz)	LVL (dBm)	Correction Factor(dB)	EIRP(dBm)	EIRP(mW)	Polarization (H/V)	LIMIT (W)
19975	1712.5	-19.74	41.07	21.33	135.83	H	1
20175	1732.5	-20.05	41.96	21.91	155.24	H	1
20375	1752.5	-21.37	42.60	21.23	132.74	H	1
19975	1712.5	-18.44	44.27	25.83	382.82	V	1
20175	1732.5	-18.97	44.76	25.79	379.31	V	1
20375	1752.5	-18.96	45.83	26.87	486.41	V	1

NOTE: EIRP (dBm) = LVL (dBm) + Correction Factor (dB)

CHANNEL BANDWIDTH: 5MHz 16QAM

Channel	Frequency (MHz)	LVL (dBm)	Correction Factor(dB)	EIRP(dBm)	EIRP(mW)	Polarization (H/V)	LIMIT (W)
19975	1712.5	-20.82	41.07	20.25	105.93	H	1
20175	1732.5	-21.02	41.96	20.94	124.17	H	1
20375	1752.5	-22.16	42.60	20.44	110.66	H	1
19975	1712.5	-19.52	44.27	24.75	298.54	V	1
20175	1732.5	-19.94	44.76	24.82	303.39	V	1
20375	1752.5	-19.75	45.83	26.08	405.51	V	1

NOTE: EIRP (dBm) = LVL (dBm) + Correction Factor (dB)



Test Report No.: RF140722N046-1

LTE BAND 4

CHANNEL BANDWIDTH: 10MHz QPSK

Channel	Frequency (MHz)	LVL (dBm)	Correction Factor(dB)	EIRP(dBm)	EIRP(mW)	Polarization (H/V)	LIMIT (W)
20000	1715.0	-19.90	41.01	21.11	129.12	H	1
20175	1732.5	-20.15	41.96	21.81	151.71	H	1
20350	1750.0	-21.29	42.32	21.03	126.77	H	1
20000	1715.0	-18.60	44.36	25.76	376.70	V	1
20175	1732.5	-19.07	44.76	25.69	370.68	V	1
20350	1750.0	-18.88	45.25	26.37	433.51	V	1

NOTE: EIRP (dBm) = LVL (dBm) + Correction Factor (dB)

CHANNEL BANDWIDTH: 10MHz 16QAM

Channel	Frequency (MHz)	LVL (dBm)	Correction Factor(dB)	EIRP(dBm)	EIRP(mW)	Polarization (H/V)	LIMIT (W)
20000	1715.0	-20.89	41.01	20.12	102.80	H	1
20175	1732.5	-21.08	41.96	20.88	122.46	H	1
20350	1750.0	-22.19	42.32	20.13	103.04	H	1
20000	1715.0	-19.59	44.36	24.77	299.92	V	1
20175	1732.5	-20.00	44.76	24.76	299.23	V	1
20350	1750.0	-19.78	45.25	25.47	352.37	V	1

NOTE: EIRP (dBm) = LVL (dBm) + Correction Factor (dB)



Test Report No.: RF140722N046-1

LTE BAND 4

CHANNEL BANDWIDTH: 15MHz QPSK

Channel	Frequency (MHz)	LVL (dBm)	Correction Factor(dB)	EIRP(dBm)	EIRP(mW)	Polarization (H/V)	LIMIT (W)
20025	1717.5	-19.87	41.22	21.35	136.46	H	1
20175	1732.5	-20.04	41.96	21.92	155.60	H	1
20325	1747.5	-21.30	41.70	20.40	109.65	H	1
20025	1717.5	-18.57	44.51	25.94	392.64	V	1
20175	1732.5	-18.96	44.76	25.80	380.19	V	1
20325	1747.5	-18.89	44.57	25.68	369.83	V	1

NOTE: EIRP (dBm) = LVL (dBm) + Correction Factor (dB)

CHANNEL BANDWIDTH: 15MHz 16QAM

Channel	Frequency (MHz)	LVL (dBm)	Correction Factor(dB)	EIRP(dBm)	EIRP(mW)	Polarization (H/V)	LIMIT (W)
20025	1717.5	-20.81	41.22	20.41	109.90	H	1
20175	1732.5	-21.03	41.96	20.93	123.88	H	1
20325	1747.5	-22.22	41.70	19.48	88.72	H	1
20025	1717.5	-19.51	44.51	25.00	316.23	V	1
20175	1732.5	-19.95	44.76	24.81	302.69	V	1
20325	1747.5	-19.81	44.57	24.76	299.23	V	1

NOTE: EIRP (dBm) = LVL (dBm) + Correction Factor (dB)



Test Report No.: RF140722N046-1

LTE BAND 4

CHANNEL BANDWIDTH: 20MHz QPSK

Channel	Frequency (MHz)	LVL (dBm)	Correction Factor(dB)	EIRP(dBm)	EIRP(mW)	Polarization (H/V)	LIMIT (W)
20050	1720.0	-19.91	41.22	21.31	135.21	H	1
20175	1732.5	-20.07	41.96	21.89	154.53	H	1
20300	1745.0	-21.19	42.56	21.37	137.09	H	1
20050	1720.0	-18.61	44.59	25.98	396.28	V	1
20175	1732.5	-18.99	44.76	25.77	377.57	V	1
20300	1745.0	-18.78	45.20	26.42	438.53	V	1

NOTE: EIRP (dBm) = LVL (dBm) + Correction Factor (dB)

CHANNEL BANDWIDTH: 20MHz 16QAM

Channel	Frequency (MHz)	LVL (dBm)	Correction Factor(dB)	EIRP(dBm)	EIRP(mW)	Polarization (H/V)	LIMIT (W)
20050	1720.0	-20.80	41.22	20.42	110.15	H	1
20175	1732.5	-21.07	41.96	20.89	122.74	H	1
20300	1745.0	-22.31	42.56	20.25	105.93	H	1
20050	1720.0	-19.50	44.59	25.09	322.85	V	1
20175	1732.5	-19.99	44.76	24.77	299.92	V	1
20300	1745.0	-19.90	45.20	25.30	338.84	V	1

NOTE: EIRP (dBm) = LVL (dBm) + Correction Factor (dB)



Test Report No.: RF140722N046-1

ERP

LTE BAND 12

CHANNEL BANDWIDTH: 1.4MHz QPSK

Channel	Frequency (MHz)	LVL (dBm)	Correction Factor(dB)	ERP(dBm)	ERP(mW)	Polarization (H/V)	LIMIT (W)
23017	699.7	-8.01	32.68	22.52	178.65	H	3
23095	707.5	-7.66	33.41	23.60	229.09	H	3
23173	715.3	-7.51	33.18	23.52	224.91	H	3
23017	699.7	-16.80	34.9	15.95	39.36	V	3
23095	707.5	-16.20	35.33	16.98	49.89	V	3
23173	715.3	-16.52	35.35	16.68	46.56	V	3

NOTE: ERP (dBm) = LVL (dBm) + Correction Factor (dB)-2.15dB.

CHANNEL BANDWIDTH: 1.4MHz 16QAM

Channel	Frequency (MHz)	LVL (dBm)	Correction Factor(dB)	ERP(dBm)	ERP(mW)	Polarization (H/V)	LIMIT (W)
23017	699.7	-9.03	32.68	21.50	141.25	H	3
23095	707.5	-8.58	33.41	22.68	185.35	H	3
23173	715.3	-8.48	33.18	22.55	179.89	H	3
23017	699.7	-17.82	34.9	14.93	31.12	V	3
23095	707.5	-17.12	35.33	16.06	40.36	V	3
23173	715.3	-17.49	35.35	15.71	37.24	V	3

NOTE: ERP (dBm) = LVL (dBm) + Correction Factor (dB)-2.15dB.



Test Report No.: RF140722N046-1

LTE BAND 12

CHANNEL BANDWIDTH: 3MHz QPSK

Channel	Frequency (MHz)	LVL (dBm)	Correction Factor(dB)	ERP(dBm)	ERP(mW)	Polarization (H/V)	LIMIT (W)
23025	700.5	-7.96	33.15	23.04	201.37	H	3
23095	707.5	-7.68	33.41	23.58	228.03	H	3
23165	714.5	-7.55	33.44	23.74	236.59	H	3
23025	700.5	-16.75	35.46	16.56	45.29	V	3
23095	707.5	-16.22	35.33	16.96	49.66	V	3
23165	714.5	-16.56	35.99	17.28	53.46	V	3

NOTE: ERP (dBm) = LVL (dBm) + Correction Factor (dB)-2.15dB.

CHANNEL BANDWIDTH: 3MHz 16QAM

Channel	Frequency (MHz)	LVL (dBm)	Correction Factor(dB)	ERP(dBm)	ERP(mW)	Polarization (H/V)	LIMIT (W)
23025	700.5	-8.90	33.15	22.10	162.18	H	3
23095	707.5	-8.63	33.41	22.63	183.23	H	3
23165	714.5	-8.46	33.44	22.83	191.87	H	3
23025	700.5	-17.69	35.46	15.62	36.48	V	3
23095	707.5	-17.17	35.33	16.01	39.90	V	3
23165	714.5	-17.47	35.99	16.37	43.35	V	3

NOTE: ERP (dBm) = LVL (dBm) + Correction Factor (dB)-2.15dB.



Test Report No.: RF140722N046-1

LTE BAND 12

CHANNEL BANDWIDTH: 5MHz QPSK

Channel	Frequency (MHz)	LVL (dBm)	Correction Factor(dB)	ERP(dBm)	ERP(mW)	Polarization (H/V)	LIMIT (W)
23035	701.5	-8.08	33.41	23.18	207.97	H	3
23095	707.5	-7.67	33.41	23.59	228.56	H	3
23155	713.5	-7.53	33.36	23.68	233.35	H	3
23035	701.5	-16.87	35.31	16.29	42.56	V	3
23095	707.5	-16.21	35.33	16.97	49.77	V	3
23155	713.5	-16.54	35.84	17.15	51.88	V	3

NOTE: ERP (dBm) = LVL (dBm) + Correction Factor (dB)-2.15dB.

CHANNEL BANDWIDTH: 5MHz 16QAM

Channel	Frequency (MHz)	LVL (dBm)	Correction Factor(dB)	ERP(dBm)	ERP(mW)	Polarization (H/V)	LIMIT (W)
23035	701.5	-8.88	33.41	22.38	172.98	H	3
23095	707.5	-8.66	33.41	22.60	181.97	H	3
23155	713.5	-8.41	33.36	22.80	190.55	H	3
23035	701.5	-17.67	35.31	15.49	35.40	V	3
23095	707.5	-17.20	35.33	15.98	39.63	V	3
23155	713.5	-17.42	35.84	16.27	42.36	V	3

NOTE: ERP (dBm) = LVL (dBm) + Correction Factor (dB)-2.15dB.



Test Report No.: RF140722N046-1

LTE BAND 12

CHANNEL BANDWIDTH: 10MHz QPSK

Channel	Frequency (MHz)	LVL (dBm)	Correction Factor(dB)	ERP(dBm)	ERP(mW)	Polarization (H/V)	LIMIT (W)
23060	704.0	-8.01	32.9	22.74	187.93	H	3
23095	707.5	-7.58	33.41	23.68	233.35	H	3
23130	711.0	-7.49	33.33	23.69	233.88	H	3
23060	704.0	-16.80	35.71	16.76	47.42	V	3
23095	707.5	-16.12	35.33	17.06	50.82	V	3
23130	711.0	-16.50	36.15	17.50	56.23	V	3

NOTE: ERP (dBm) = LVL (dBm) + Correction Factor (dB)-2.15dB.

CHANNEL BANDWIDTH: 10MHz 16QAM

Channel	Frequency (MHz)	LVL (dBm)	Correction Factor(dB)	ERP(dBm)	ERP(mW)	Polarization (H/V)	LIMIT (W)
23060	704.0	-8.92	32.9	21.83	152.41	H	3
23095	707.5	-8.71	33.41	22.55	179.89	H	3
23130	711.0	-8.38	33.33	22.80	190.55	H	3
23060	704.0	-17.71	35.71	15.85	38.46	V	3
23095	707.5	-17.25	35.33	15.93	39.17	V	3
23130	711.0	-17.39	36.15	16.61	45.81	V	3

NOTE: ERP (dBm) = LVL (dBm) + Correction Factor (dB)-2.15dB.



Test Report No.: RF140722N046-1

LTE BAND 17

CHANNEL BANDWIDTH: 5MHz QPSK

Channel	Frequency (MHz)	LVL (dBm)	Correction Factor(dB)	ERP(dBm)	ERP(mW)	Polarization (H/V)	LIMIT (W)
23755	706.5	-7.68	33.14	23.31	214.29	H	3
23790	710.0	-7.87	33.16	23.14	206.06	H	3
23825	713.5	-7.88	33.12	23.09	203.70	H	3
23755	706.5	-17.54	35.04	15.35	34.28	V	3
23790	710.0	-17.83	35.12	15.14	32.66	V	3
23825	713.5	-17.99	35.14	15.00	31.62	V	3

NOTE: ERP (dBm) = LVL (dBm) + Correction Factor (dB)-2.15dB.

CHANNEL BANDWIDTH: 5MHz 16QAM

Channel	Frequency (MHz)	LVL (dBm)	Correction Factor(dB)	ERP(dBm)	ERP(mW)	Polarization (H/V)	LIMIT (W)
23755	706.5	-8.61	33.14	22.38	172.98	H	3
23790	710.0	-8.87	33.16	22.14	163.68	H	3
23825	713.5	-8.65	33.12	22.32	170.61	H	3
23755	706.5	-18.47	35.04	14.42	27.67	V	3
23790	710.0	-18.83	35.12	14.14	25.94	V	3
23825	713.5	-18.76	35.14	14.23	26.49	V	3

NOTE: ERP (dBm) = LVL (dBm) + Correction Factor (dB)-2.15dB.



Test Report No.: RF140722N046-1

LTE BAND 17

CHANNEL BANDWIDTH: 10MHz QPSK

Channel	Frequency (MHz)	LVL (dBm)	Correction Factor(dB)	ERP(dBm)	ERP(mW)	Polarization (H/V)	LIMIT (W)
23780	709.0	-7.66	33.04	23.23	210.38	H	3
23790	710.0	-7.85	33.16	23.16	207.01	H	3
23800	711.0	-7.88	33.37	23.34	215.77	H	3
23780	709.0	-17.52	35.17	15.50	35.48	V	3
23790	710.0	-17.81	35.12	15.16	32.81	V	3
23800	711.0	-17.99	35.31	15.17	32.89	V	3

NOTE: ERP (dBm) = LVL (dBm) + Correction Factor (dB)-2.15dB.

CHANNEL BANDWIDTH: 10MHz 16QAM

Channel	Frequency (MHz)	LVL (dBm)	Correction Factor(dB)	ERP(dBm)	ERP(mW)	Polarization (H/V)	LIMIT (W)
23780	709.0	-8.72	33.04	22.17	164.82	H	3
23790	710.0	-8.78	33.16	22.23	167.11	H	3
23800	711.0	-8.68	33.37	22.54	179.47	H	3
23780	709.0	-18.58	35.17	14.44	27.80	V	3
23790	710.0	-18.74	35.12	14.23	26.49	V	3
23800	711.0	-18.79	35.31	14.37	27.35	V	3

NOTE: ERP (dBm) = LVL (dBm) + Correction Factor (dB)-2.15dB.

4.2 FREQUENCY STABILITY MEASUREMENT

4.2.1 LIMITS OF FREQUENCY STABILITY MEASUREMENT

The frequency stability shall be sufficient to ensure that the fundamental emissions stay within the authorized bands of operation.

4.2.2 TEST PROCEDURE

- Device is placed at the oven room. The oven room could control the temperatures and humidity. Power warm up is at least 15 min and power applied should perform before recording frequency error.
- EUT is connected the external power supply to control the DC input power. The test voltage range is from minimum to maximum working voltage. Each step shall be record the frequency error rate.
- The temperature range step is 10 degrees in this test items. All temperature levels shall be hold the $\pm 0.5^{\circ}\text{C}$ during the measurement testing. The each temperature step shall be at least 0.5 hours, consider the EUT could be test under the stability condition.

NOTE: The frequency error was recorded frequency error from the communication simulator.

4.2.3 TEST SETUP

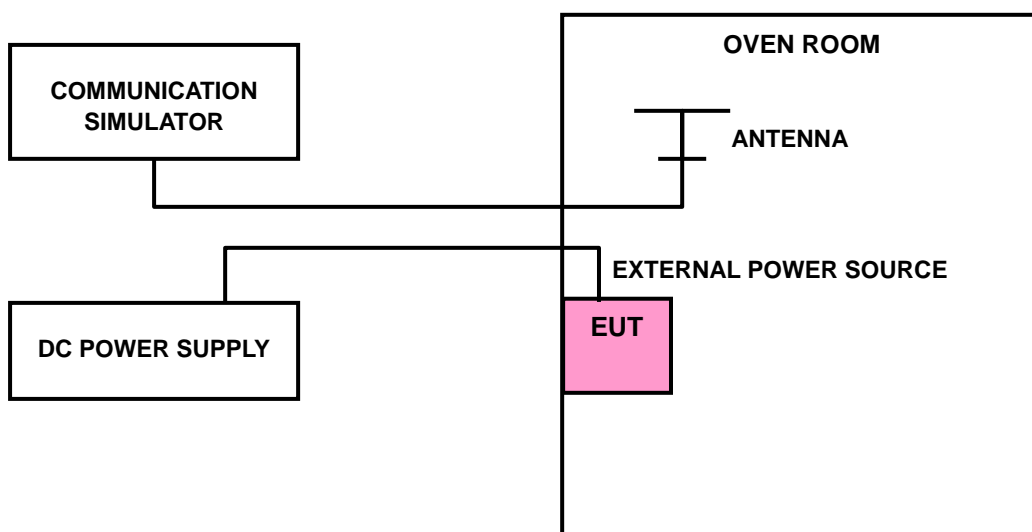



4.2.4 TEST RESULTS

LTE BAND 4

AFC FREQUENCY ERROR vs. VOLTAGE							
VOLTAGE (Volts)	FREQUENCY ERROR (ppm)						LIMIT (ppm)
	1.4MHz	3MHz	5MHz	10MHz	15MHz	20MHz	
3.8	0.010	-0.007	-0.004	-0.004	0.009	-0.004	2.5
3.5	0.008	-0.003	-0.003	-0.003	0.008	-0.005	2.5
4.35	0.008	-0.003	0.005	0.005	0.008	-0.003	2.5

NOTE: The applicant defined the normal working voltage of the battery is from 3.5Vdc to 4.35Vdc.

AFC FREQUENCY ERROR vs. TEMPERATURE							
TEMP. (°C)	FREQUENCY ERROR (ppm)						LIMIT (ppm)
	1.4MHz	3MHz	5MHz	10MHz	15MHz	20MHz	
-30	0.010	-0.013	-0.013	0.009	0.010	0.010	2.5
-20	0.008	-0.011	-0.011	0.008	0.009	0.008	2.5
-10	0.007	-0.008	-0.010	0.007	0.007	0.007	2.5
0	0.006	-0.008	-0.009	-0.006	0.005	0.006	2.5
10	0.005	-0.007	-0.008	-0.006	0.005	0.005	2.5
20	0.005	-0.005	-0.007	-0.005	0.005	0.004	2.5
30	0.005	-0.004	-0.004	-0.004	0.004	-0.003	2.5
40	0.006	0.003	-0.006	-0.005	-0.002	-0.004	2.5
50	0.007	0.005	-0.007	-0.006	-0.004	-0.005	2.5
60	0.008	0.006	-0.007	-0.007	-0.005	-0.006	2.5



Test Report No.: RF140722N046-1

LTE BAND 12

VOLTAGE (Volts)	FREQUENCY ERROR (ppm)				LIMIT (ppm)
	1.4MHz	3MHz	5MHz	10MHz	
3.8	0.018	0.012	0.008	-0.014	2.5
3.5	0.021	0.013	0.006	-0.015	2.5
4.35	0.019	0.011	0.007	-0.017	2.5

NOTE: The applicant defined the normal working voltage of the battery is from 3.5Vdc to 4.35Vdc.

VOLTAGE (Volts)	FREQUENCY ERROR (ppm)				LIMIT (ppm)
	1.4MHz	3MHz	5MHz	10MHz	
-30	0.027	0.023	0.015	-0.023	2.5
-20	0.026	0.020	0.012	-0.020	2.5
-10	0.023	0.017	0.010	-0.019	2.5
0	0.020	0.015	0.009	-0.015	2.5
10	0.019	0.012	0.009	-0.013	2.5
20	0.018	0.009	0.009	-0.012	2.5
30	0.014	0.009	0.008	-0.011	2.5
40	0.012	-0.008	-0.005	-0.012	2.5
50	-0.009	-0.012	-0.010	-0.014	2.5
60	-0.012	-0.015	-0.012	-0.012	2.5



LTE BAND 17

VOLTAGE (Volts)	FREQUENCY ERROR (ppm)		LIMIT (ppm)
	5MHz	10MHz	
3.8	0.011	0.020	2.5
3.5	0.003	0.018	2.5
4.35	0.003	0.019	2.5

NOTE: The applicant defined the normal working voltage of the battery is from 3.5Vdc to 4.35Vdc.

VOLTAGE (Volts)	FREQUENCY ERROR (ppm)		LIMIT (ppm)
	5MHz	10MHz	
-30	0.023	0.034	2.5
-20	0.021	0.031	2.5
-10	0.020	0.028	2.5
0	0.019	0.026	2.5
10	0.018	0.022	2.5
20	0.015	0.021	2.5
30	0.009	0.019	2.5
40	-0.006	0.018	2.5
50	-0.009	0.013	2.5
60	-0.012	0.008	2.5

4.3 OCCUPIED BANDWIDTH MEASUREMENT

4.3.1 LIMITS OF OCCUPIED BANDWIDTH MEASUREMENT

The width of a frequency band such that, below the lower and above the upper frequency limits, the mean powers emitted are each equal to a specified percentage 0.5 %of the total mean power of a given emission.

4.3.2 TEST SETUP

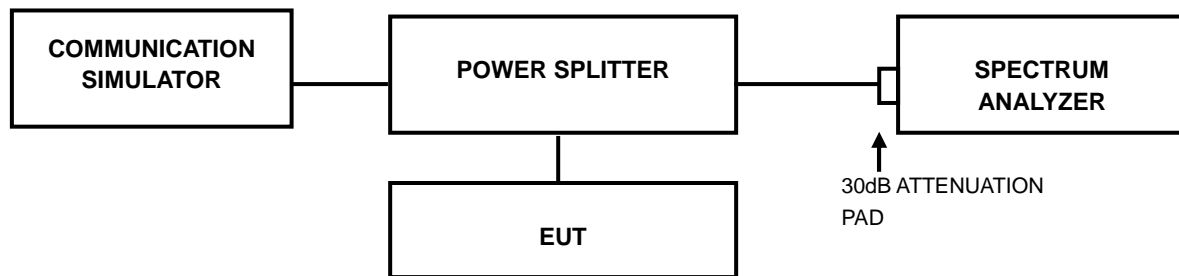

4.3.3 TEST PROCEDURES

- The conducted occupied bandwidth used the power splitter via EUT RF power connector between simulation base station and spectrum analyzer.
- Use OBW measurement function of Spectrum analyzer to measure 99 % occupied bandwidth.

4.3.4 TEST RESULTS

LTE BAND 4

CHANNEL BANDWIDTH: 1.4MHz				CHANNEL BANDWIDTH: 3MHz			
CHANNEL	FREQUENCY (MHz)	99% OCCUPIED BANDWIDTH (MHz)		CHANNEL	FREQUENCY (MHz)	99% OCCUPIED BANDWIDTH (MHz)	
		QPSK	16QAM			QPSK	16QAM
19957	1710.7	1.09	1.09	19965	1711.5	2.69	2.69
20175	1732.5	1.10	1.10	20175	1732.5	2.70	2.69
20393	1754.3	1.09	1.09	20385	1753.5	2.69	2.69

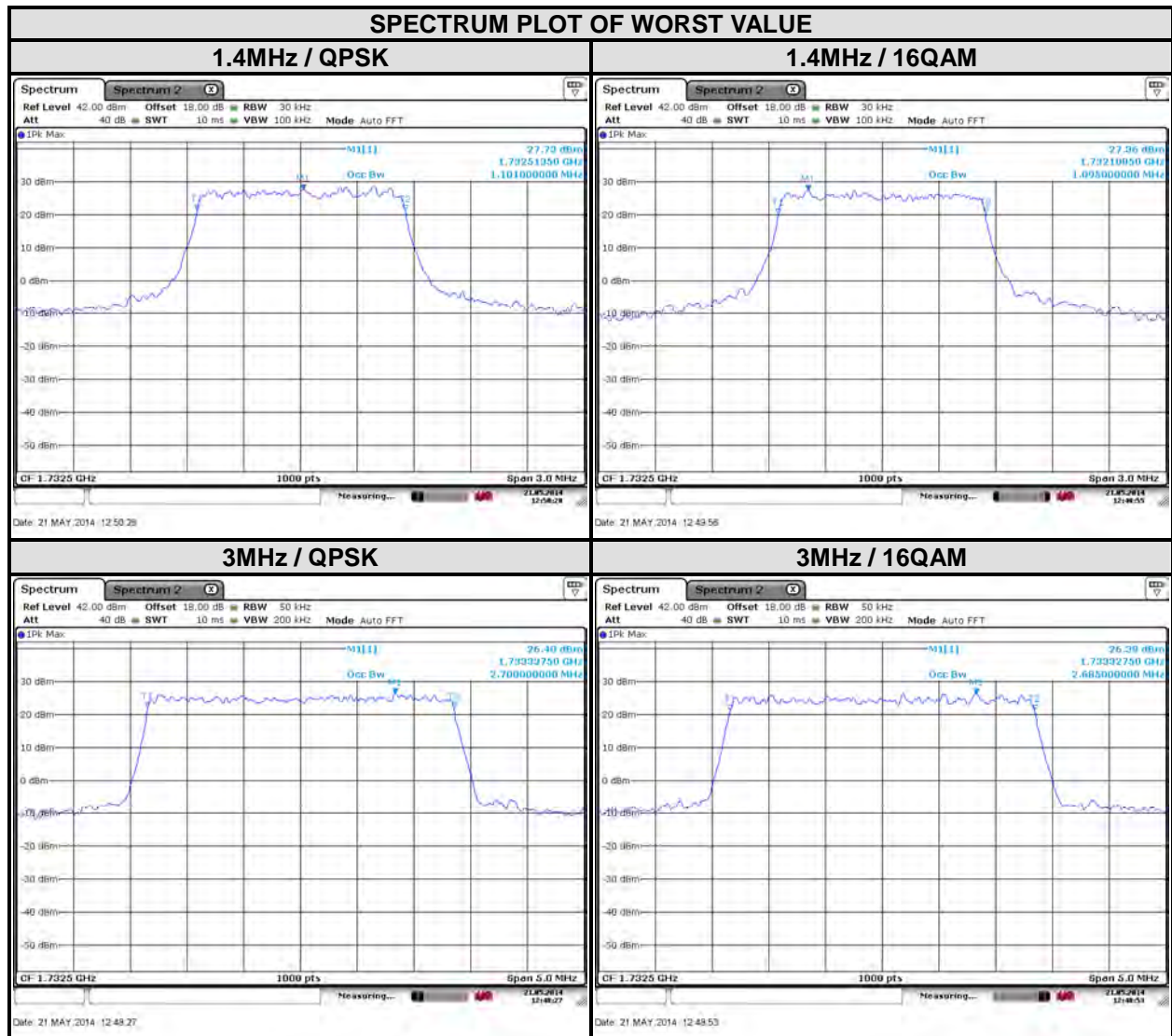



LTE BAND 4

CHANNEL BANDWIDTH: 5MHz				CHANNEL BANDWIDTH: 10MHz			
CHANNEL	FREQUENCY (MHz)	99% OCCUPIED BANDWIDTH (MHz)		CHANNEL	FREQUENCY (MHz)	99% OCCUPIED BANDWIDTH (MHz)	
		QPSK	16QAM			QPSK	16QAM
19975	1712.5	4.47	4.48	20000	1715	8.92	8.94
20175	1732.5	4.52	4.50	20175	1732.5	9.00	8.97
20375	1752.5	4.48	4.47	20350	1780	8.92	8.92

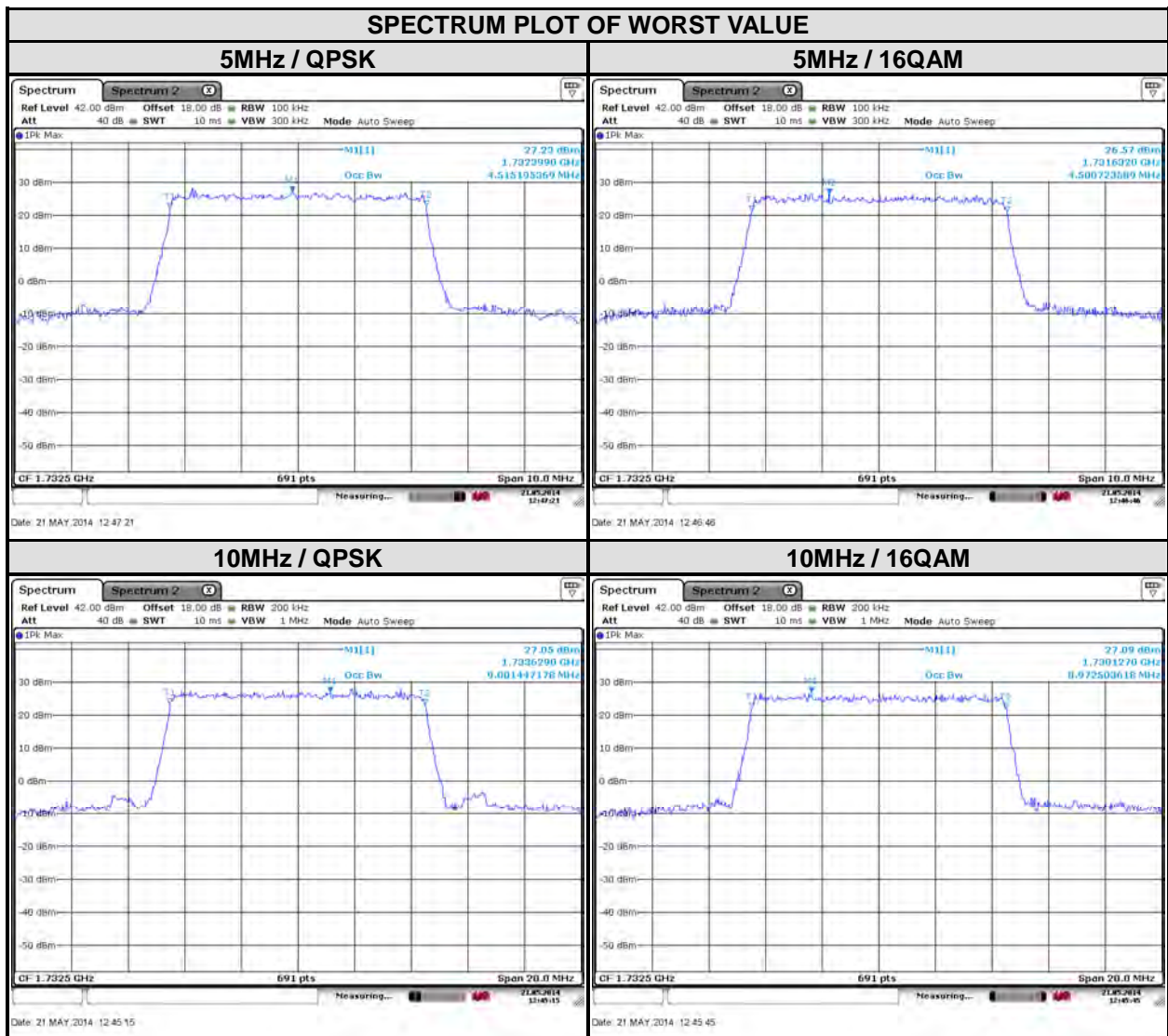



LTE BAND 4

CHANNEL BANDWIDTH: 15MHz				CHANNEL BANDWIDTH: 20MHz			
CHANNEL	FREQUENCY (MHz)	99% OCCUPIED BANDWIDTH (MHz)		CHANNEL	FREQUENCY (MHz)	99% OCCUPIED BANDWIDTH (MHz)	
		QPSK	16QAM			QPSK	16QAM
20025	1717.5	13.40	13.40	20050	1720	17.90	17.80
20175	1732.5	13.60	13.60	20175	1732.5	18.02	18.02
20325	1747.5	13.40	13.40	20300	1745	17.90	17.80

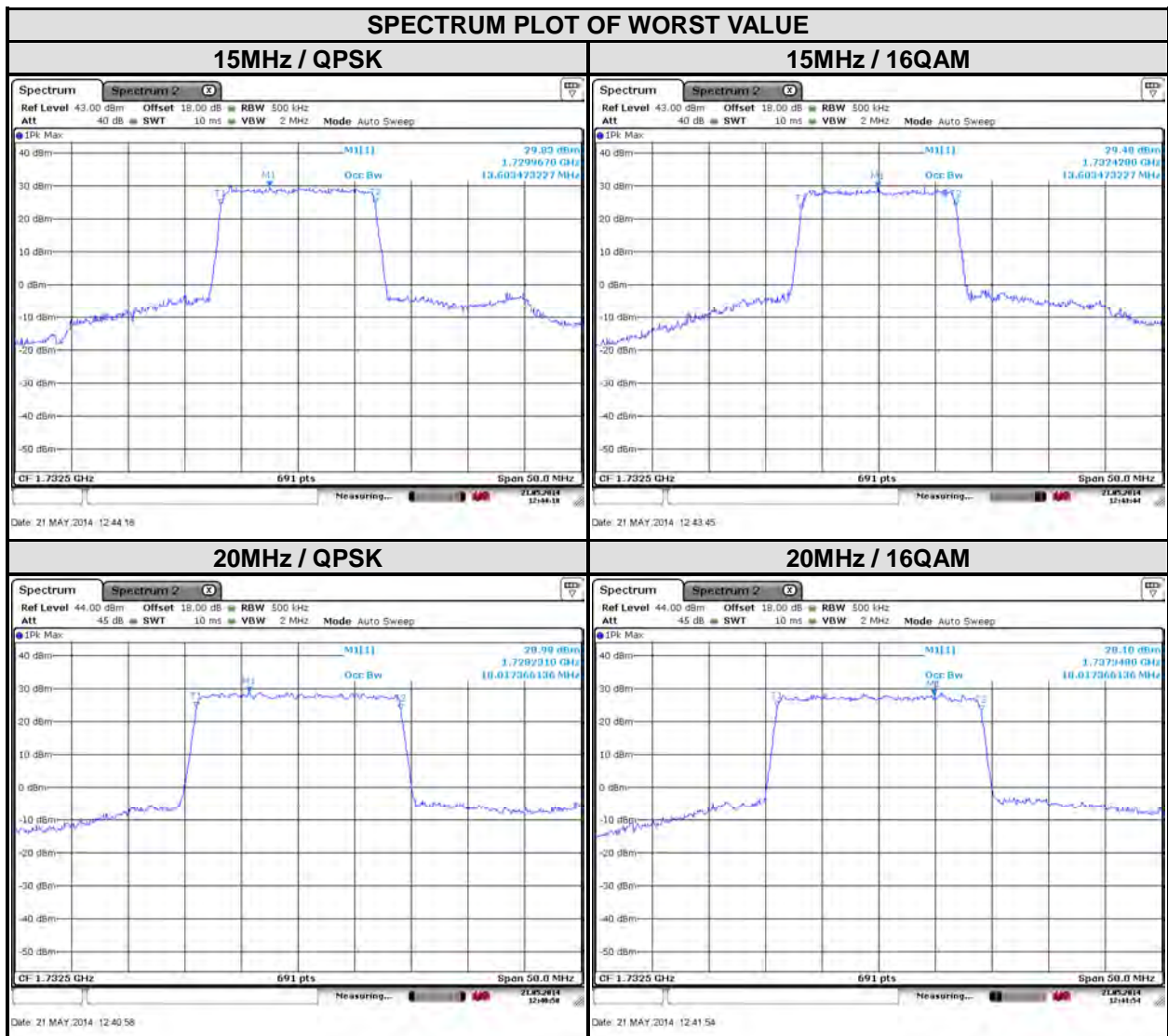



LTE BAND 12

CHANNEL BANDWIDTH: 1.4MHz				CHANNEL BANDWIDTH: 3MHz			
CHANNEL	FREQUENCY (MHz)	99% OCCUPIED BANDWIDTH (MHz)		CHANNEL	FREQUENCY (MHz)	99% OCCUPIED BANDWIDTH (MHz)	
		QPSK	16QAM			QPSK	16QAM
23017	699.7	1.09	1.09	23025	700.5	2.70	2.69
23095	707.5	1.09	1.09	23095	707.5	2.70	2.69
23173	715.3	1.09	1.09	23165	714.5	2.69	2.69

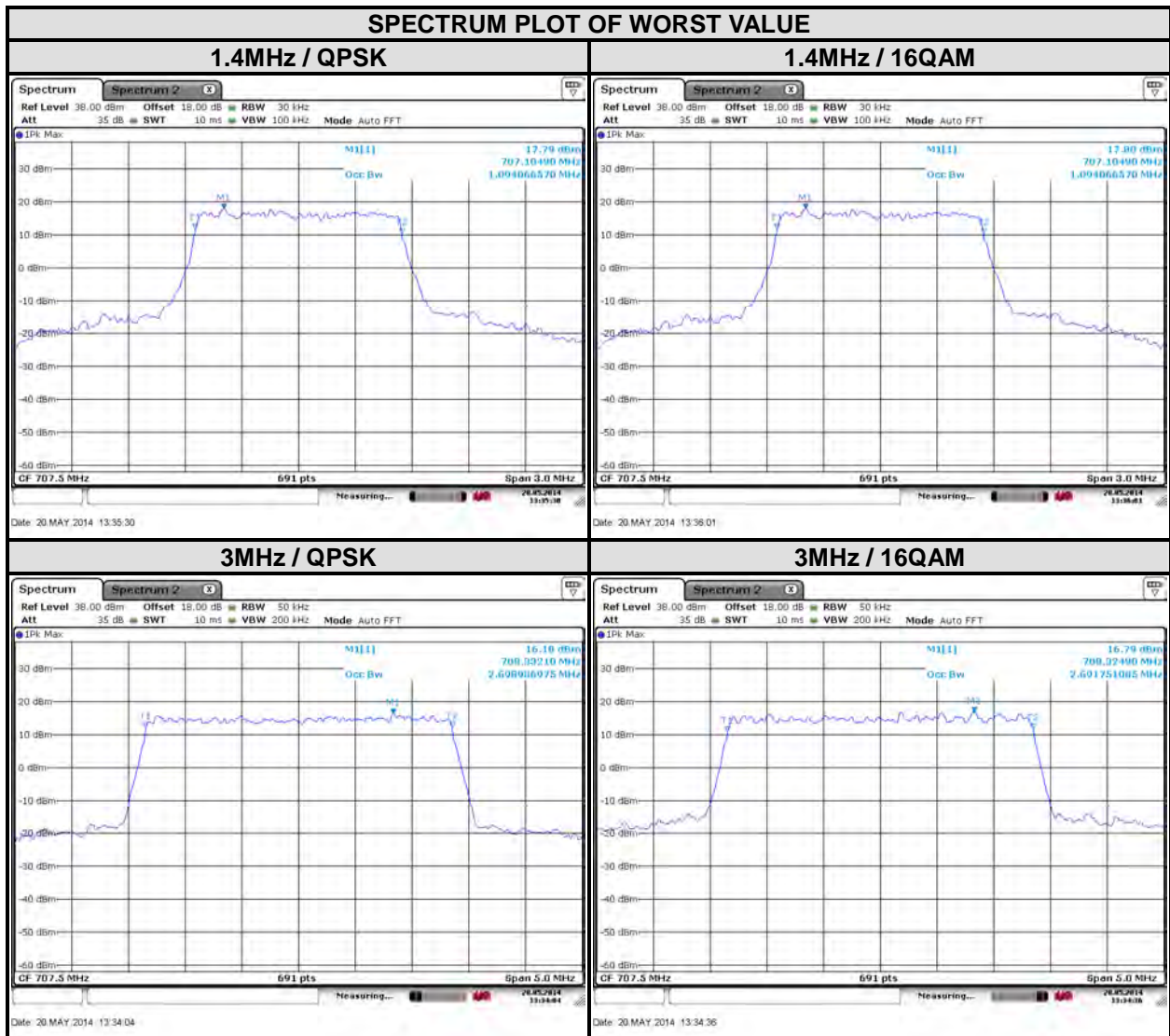



LTE BAND 12

CHANNEL BANDWIDTH: 5MHz				CHANNEL BANDWIDTH: 10MHz			
CHANNEL	FREQUENCY (MHz)	99% OCCUPIED BANDWIDTH (MHz)		CHANNEL	FREQUENCY (MHz)	99% OCCUPIED BANDWIDTH (MHz)	
		QPSK	16QAM			QPSK	16QAM
23035	701.5	4.5	4.49	23060	704	8.96	8.96
23095	707.5	4.5	4.50	23095	707.5	8.97	8.97
23155	713.5	4.49	4.49	23130	711	8.96	8.97

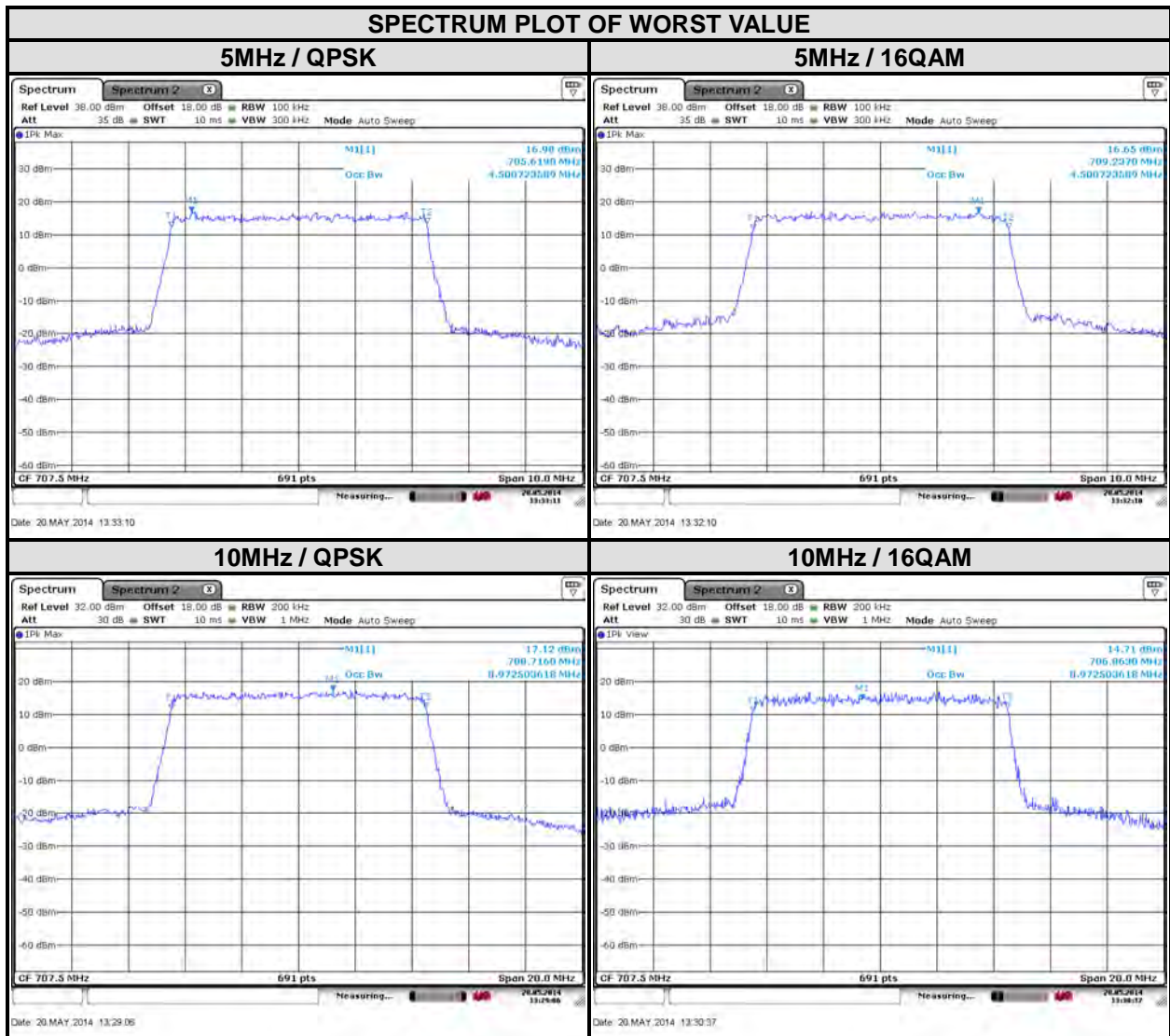



LTE BAND 17

CHANNEL BANDWIDTH: 5MHz				CHANNEL BANDWIDTH: 10MHz			
CHANNEL	FREQUENCY (MHz)	99% OCCUPIED BANDWIDTH (MHz)		CHANNEL	FREQUENCY (MHz)	99% OCCUPIED BANDWIDTH (MHz)	
		QPSK	16QAM			QPSK	16QAM
23755	706.5	4.5	4.49	23780	709	8.97	8.97
23790	710	4.48	4.48	23790	710	8.92	8.92
23825	713.5	4.48	4.48	23800	711	8.94	8.94

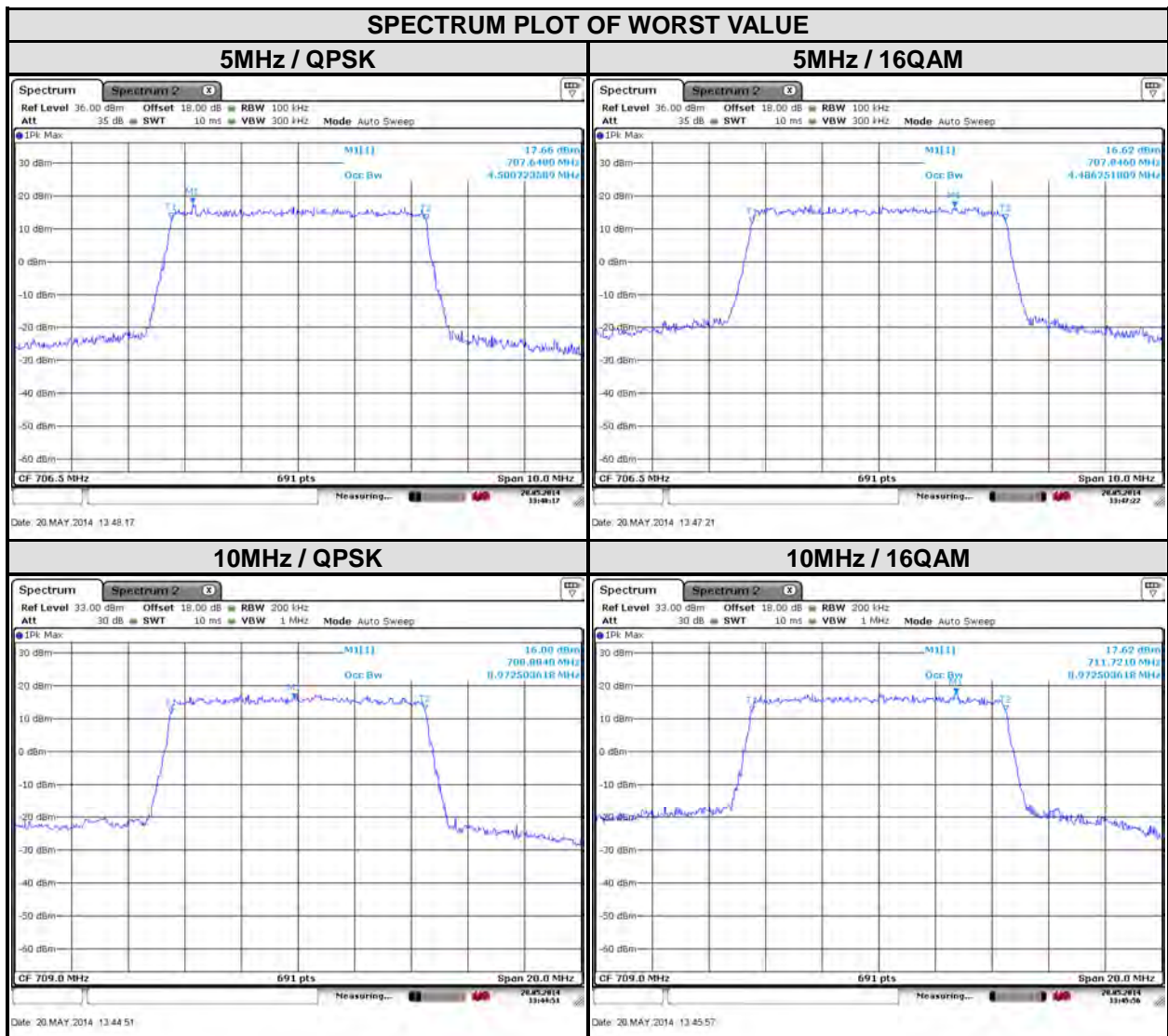

4.4 PEAK TO AVERAGE RATIO

4.4.1 LIMITS OF PEAK TO AVERAGE RATIO MEASUREMENT

In measuring transmissions in this band using an average power technique, the peak to-average ratio (PAR) of the transmission may not exceed 13 dB

4.4.2 TEST SETUP

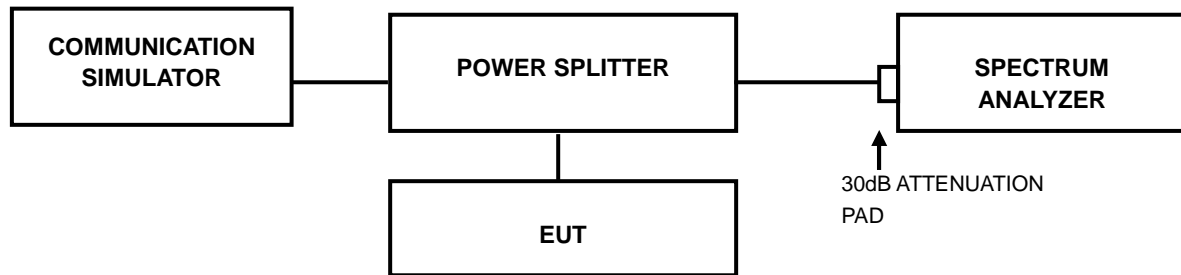

4.4.3 TEST PROCEDURES

1. Set resolution/measurement bandwidth \geq signal's occupied bandwidth;
2. Set the number of counts to a value that stabilizes the measured CCDF curve;
3. Record the maximum PAPR level associated with a probability of 0.1%.

4.4.4 TEST RESULTS

LTE BAND 4

CHANNEL BANDWIDTH: 1.4MHz			
CHANNEL	FREQUENCY (MHz)	PEAK TO AVERAGE RATIO (dB)	
		QPSK	16QAM
19957	1710.7	5.22	5.88
20175	1732.5	5.83	4.87
20393	1754.3	5.25	4.14

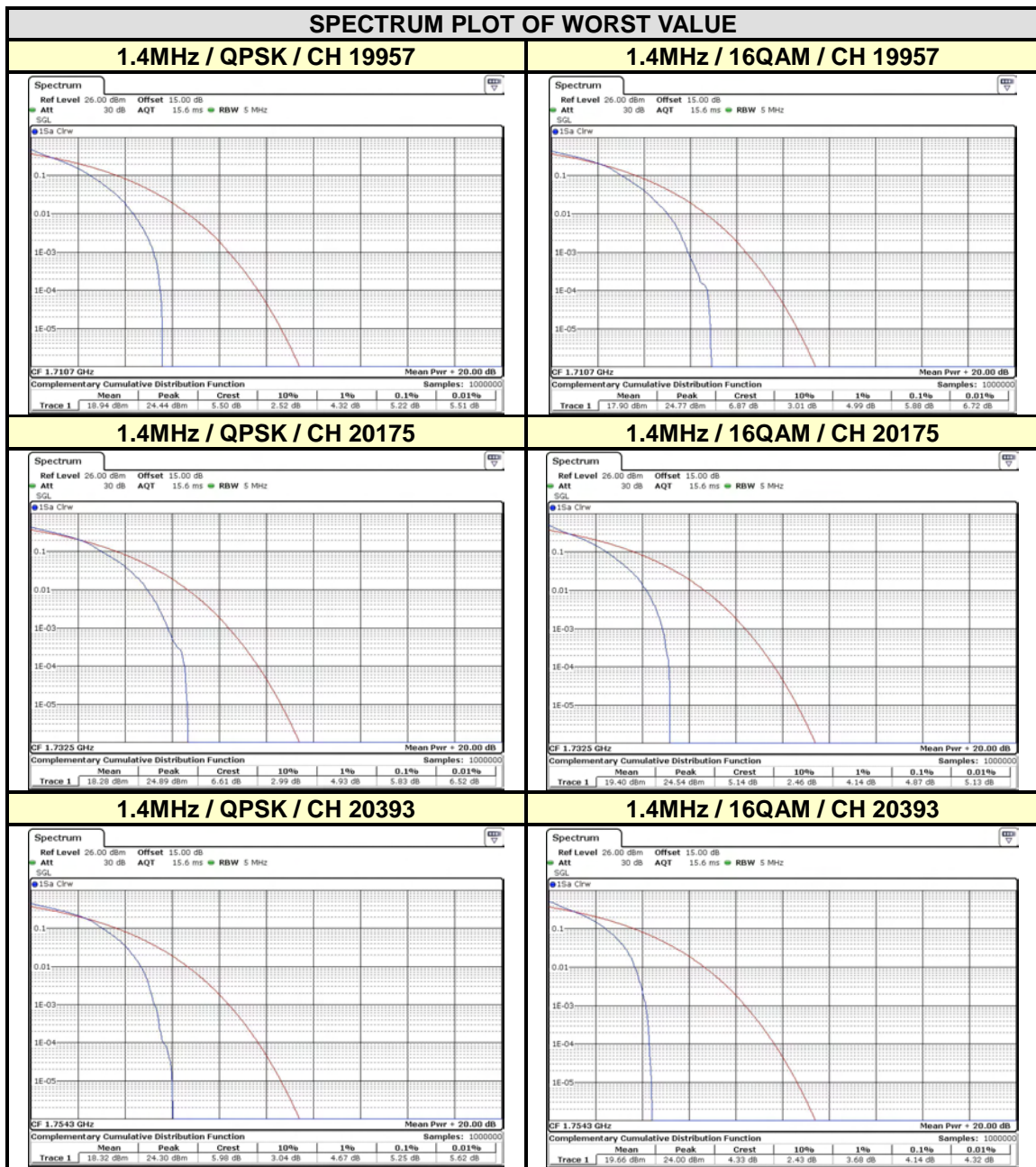



LTE BAND 4

CHANNEL BANDWIDTH: 3MHz			
CHANNEL	FREQUENCY (MHz)	PEAK TO AVERAGE RATIO (dB)	
		QPSK	16QAM
19965	1711.5	6.43	5.54
20175	1732.5	6.29	5.36
20385	1753.5	5.57	5.22

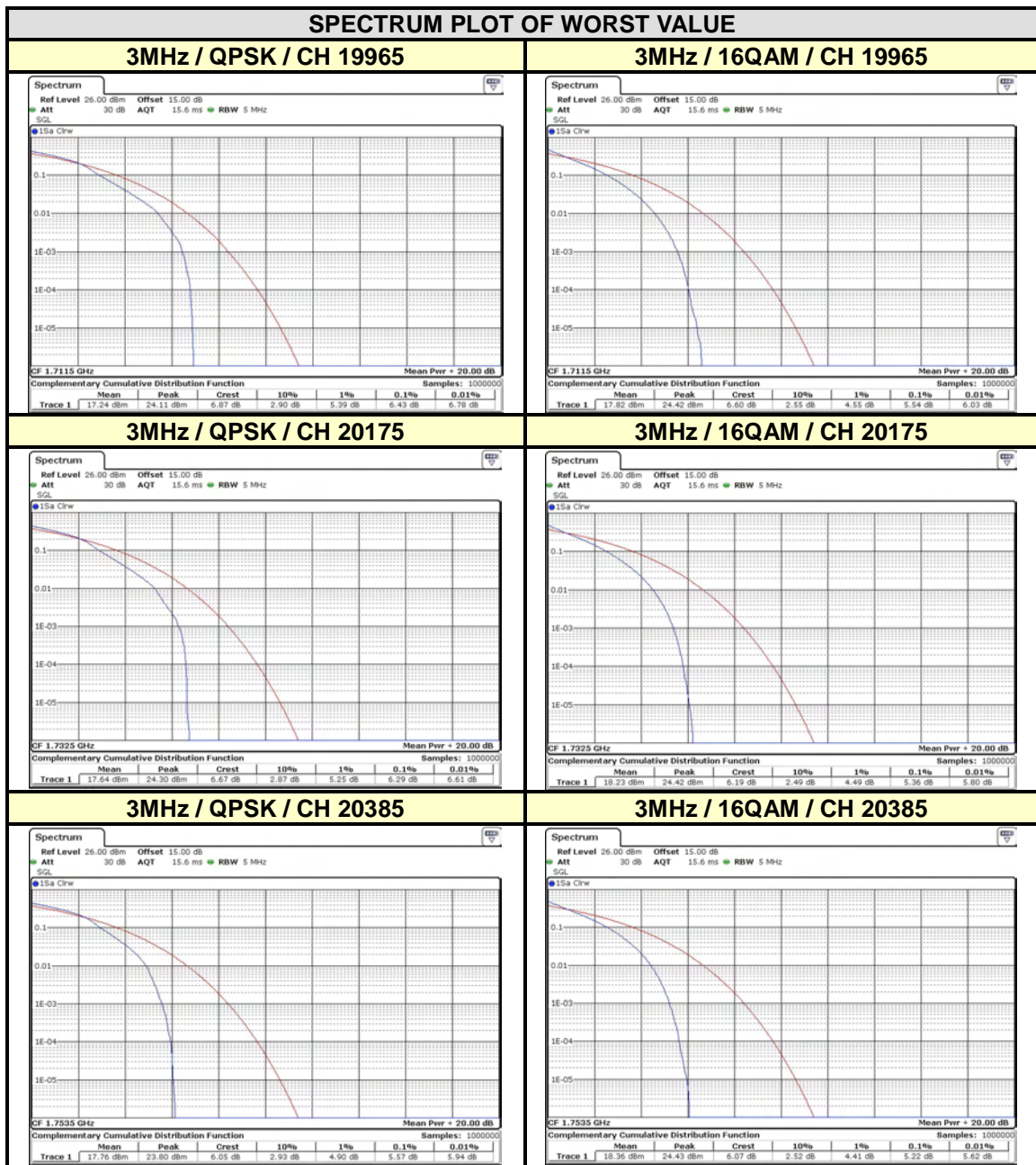



Test Report No.: RF140722N046-1

LTE BAND 4

CHANNEL BANDWIDTH: 5MHz			
CHANNEL	FREQUENCY (MHz)	PEAK TO AVERAGE RATIO (dB)	
		QPSK	16QAM
19975	1712.5	6.03	5.33
20175	1732.5	5.97	5.10
20375	1752.5	5.48	4.64

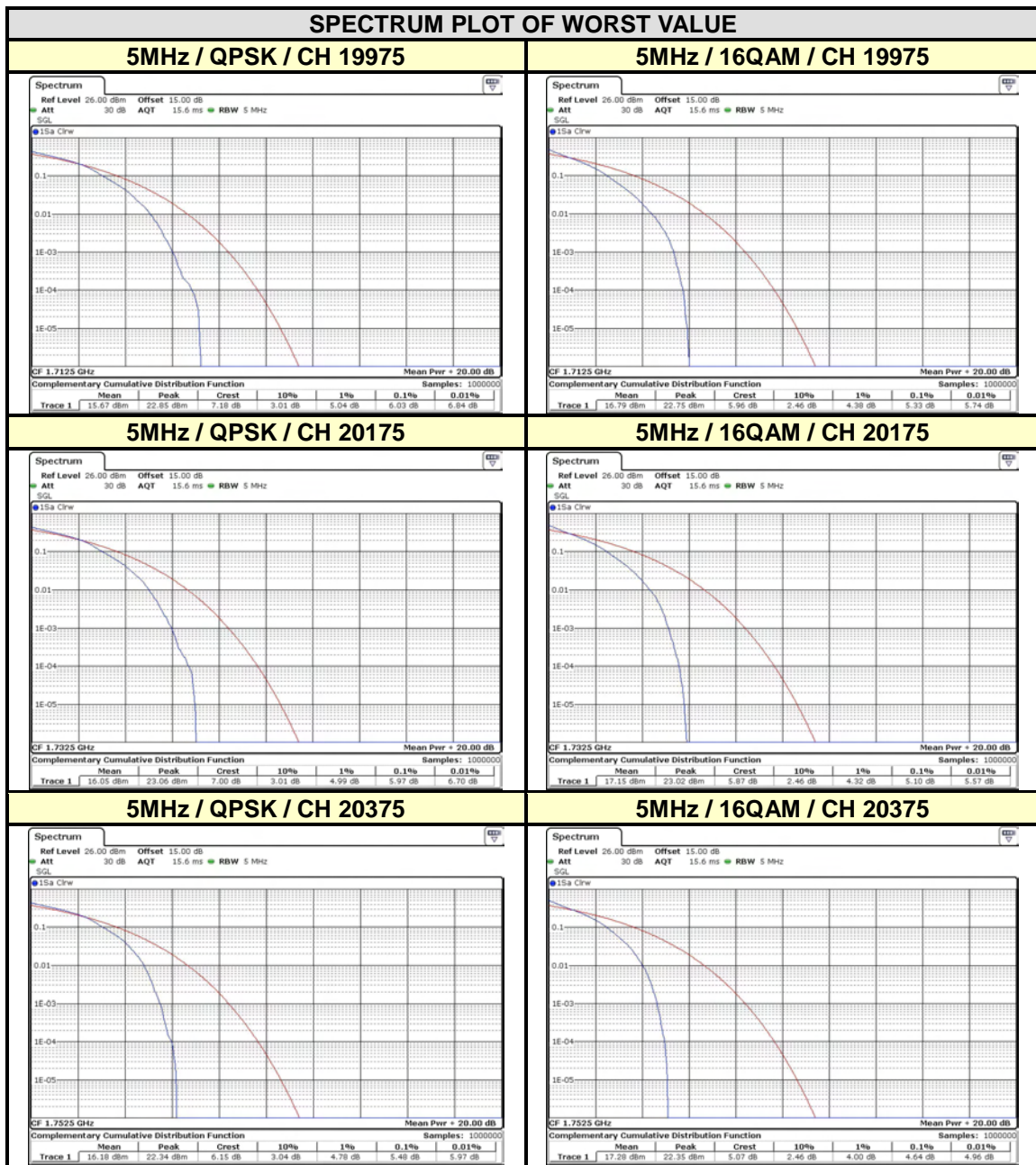



Test Report No.: RF140722N046-1

LTE BAND 4

CHANNEL BANDWIDTH: 10MHz			
CHANNEL	FREQUENCY (MHz)	PEAK TO AVERAGE RATIO (dB)	
		QPSK	16QAM
20000	1715	6.12	5.51
20175	1732.5	6.23	5.39
20350	1780	5.57	5.33

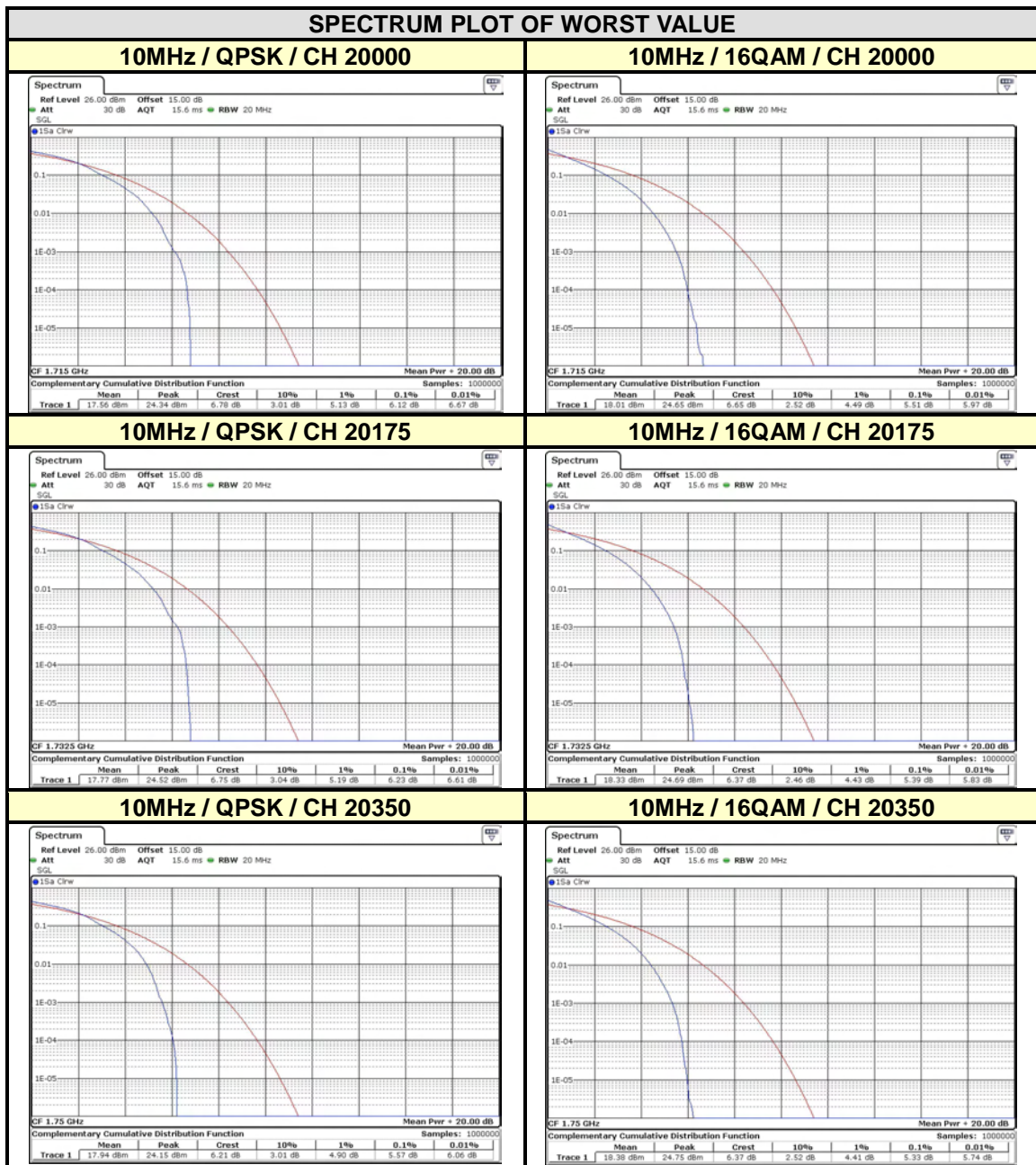



Test Report No.: RF140722N046-1

LTE BAND 4

CHANNEL BANDWIDTH: 15MHz			
CHANNEL	FREQUENCY (MHz)	PEAK TO AVERAGE RATIO (dB)	
		QPSK	16QAM
20025	1717.5	6.29	5.36
20175	1732.5	6.20	5.36
20325	1747.5	6.26	5.19

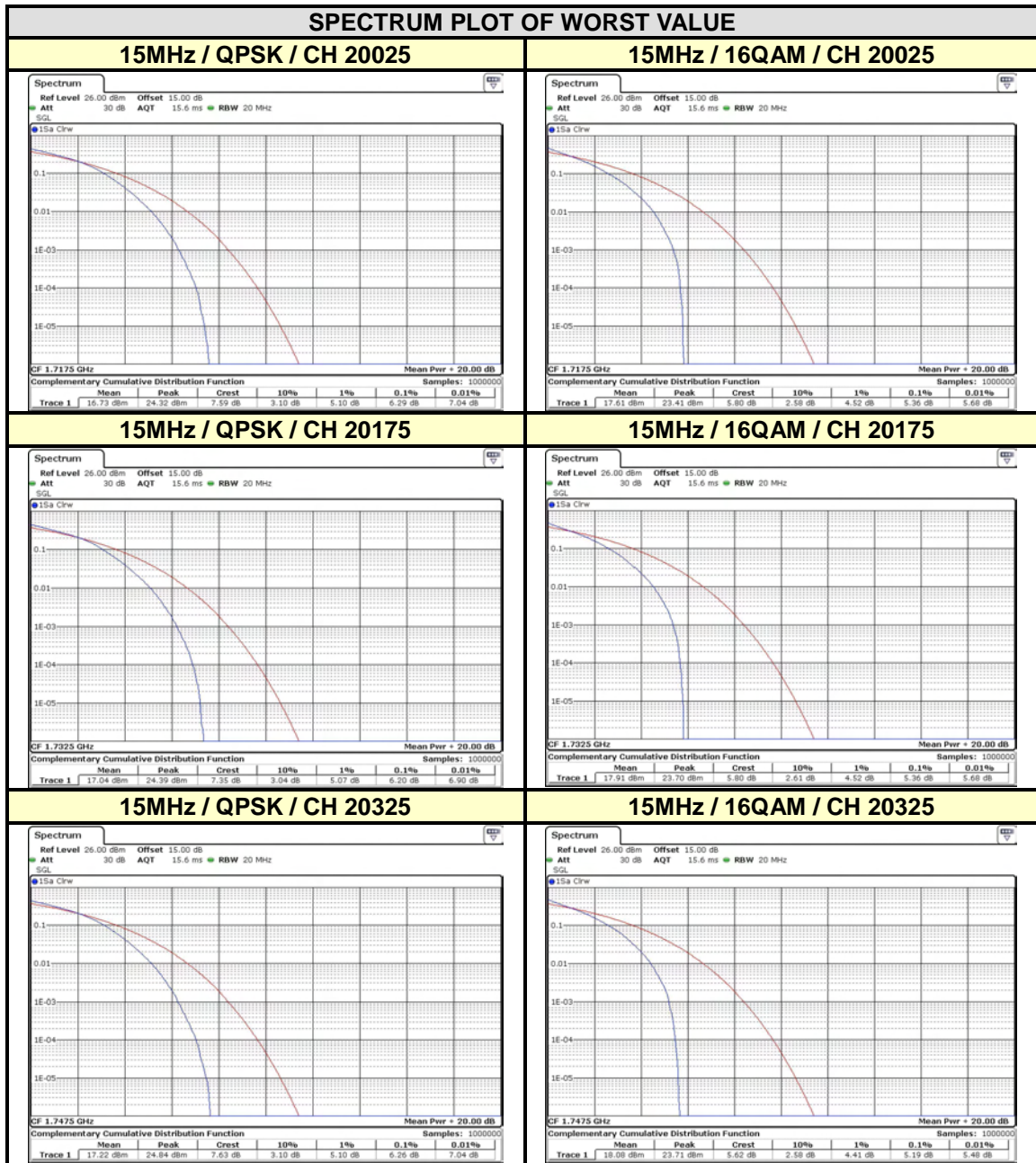



LTE BAND 4

CHANNEL BANDWIDTH: 20MHz			
CHANNEL	FREQUENCY (MHz)	PEAK TO AVERAGE RATIO (dB)	
		QPSK	16QAM
20050	1720	6.55	5.13
20175	1732.5	6.23	5.30
20300	1745	6.43	5.01

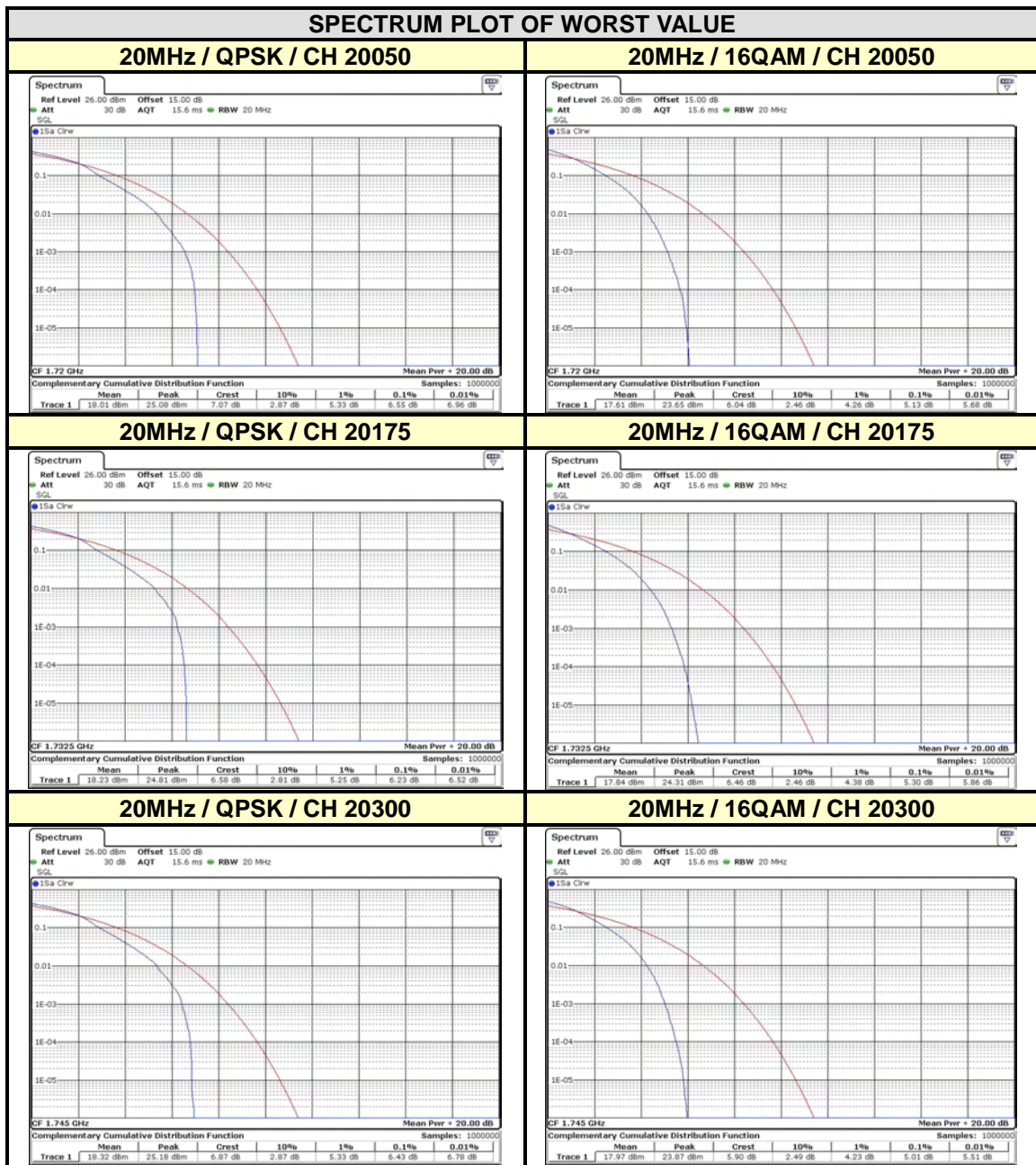



Test Report No.: RF140722N046-1

LTE BAND 12

CHANNEL BANDWIDTH: 1.4MHz			
CHANNEL	FREQUENCY (MHz)	PEAK TO AVERAGE RATIO (dB)	
		QPSK	16QAM
23017	699.7	5.01	5.88
23095	707.5	5.10	5.25
23173	715.3	4.99	5.16

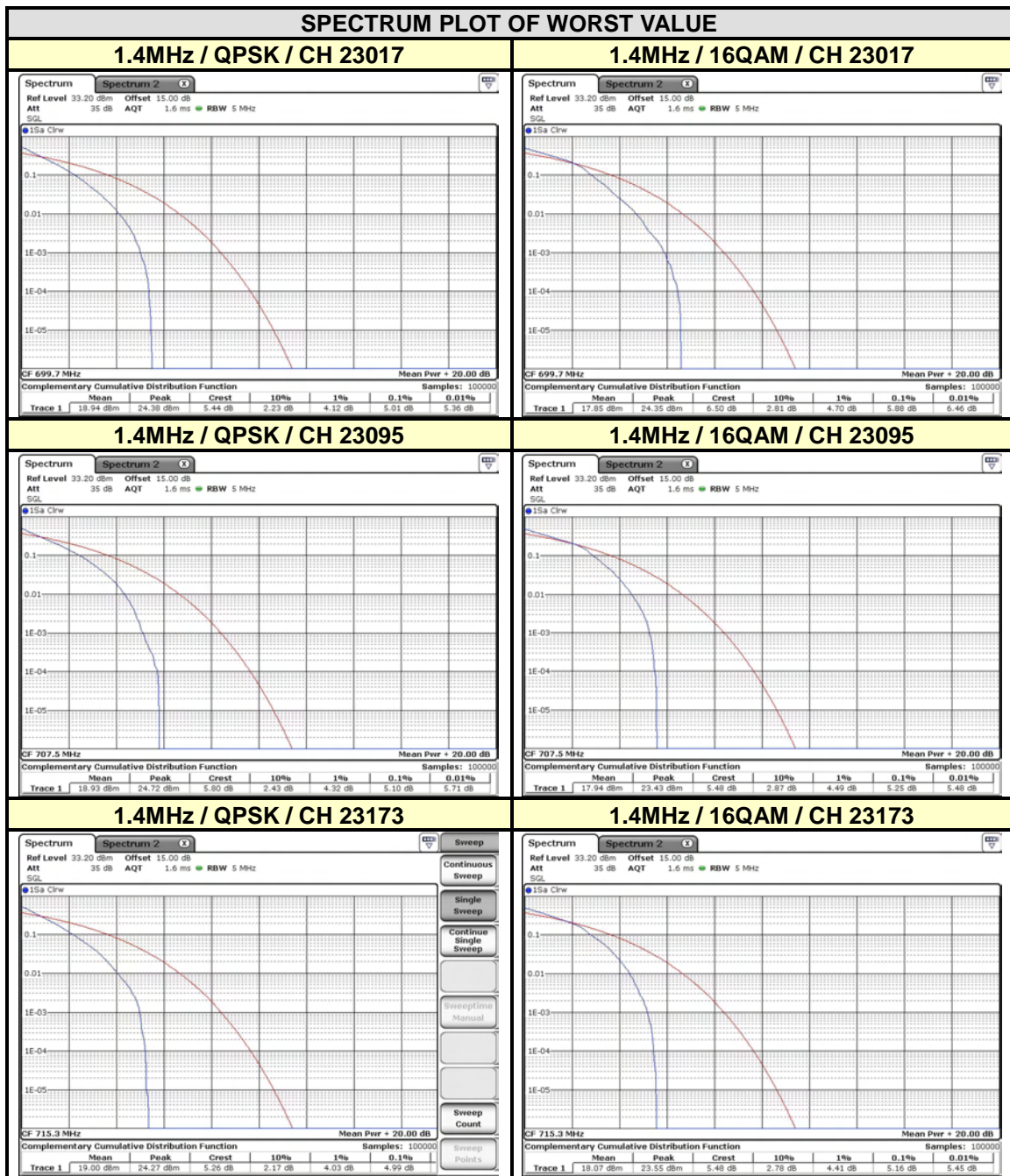



Test Report No.: RF140722N046-1

LTE BAND 12

CHANNEL BANDWIDTH: 3MHz			
CHANNEL	FREQUENCY (MHz)	PEAK TO AVERAGE RATIO (dB)	
		QPSK	16QAM
23025	700.5	5.57	6.00
23095	707.5	5.13	5.36
23165	714.5	5.10	5.51

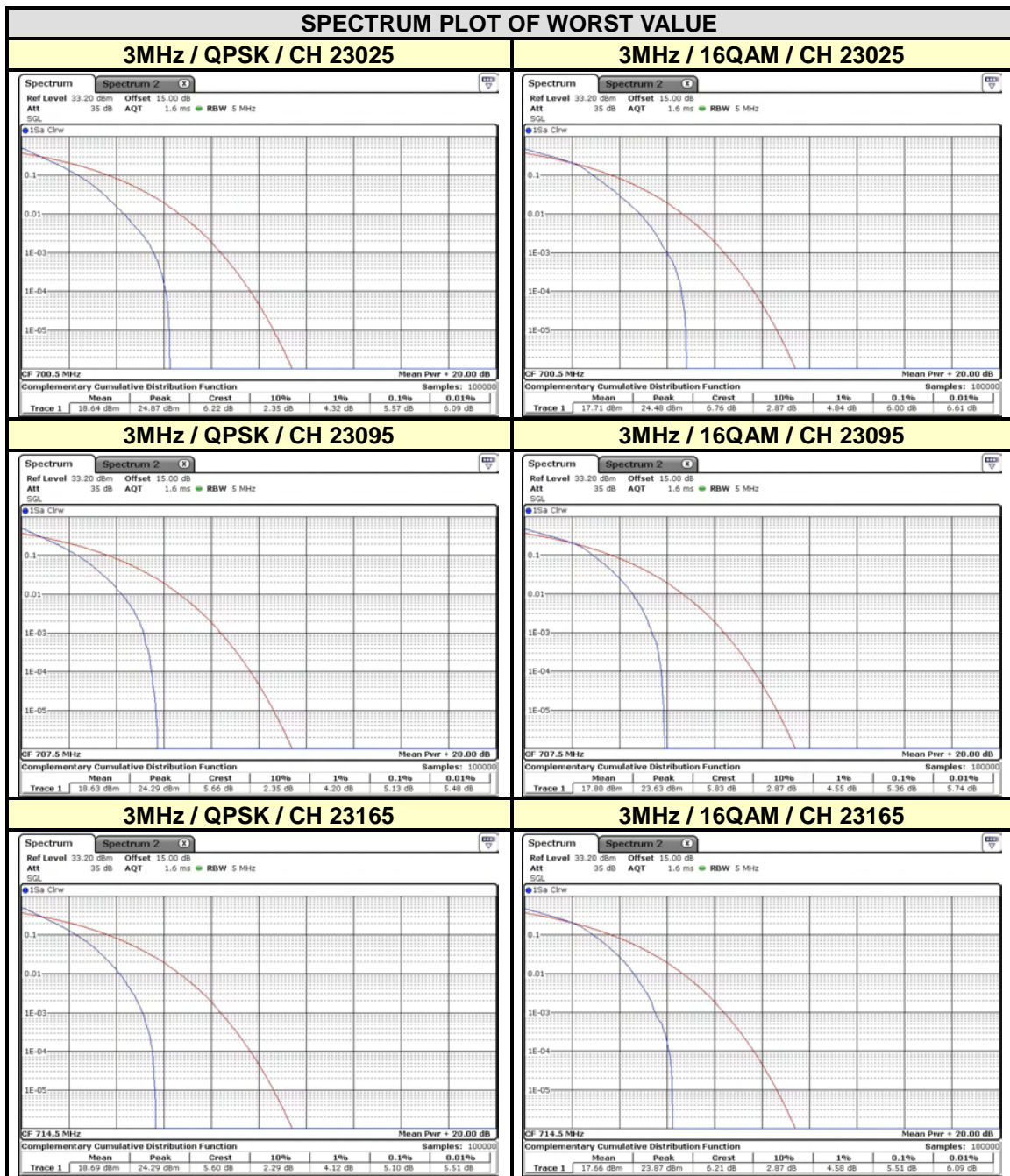



LTE BAND 12

CHANNEL BANDWIDTH: 5MHz			
CHANNEL	FREQUENCY (MHz)	PEAK TO AVERAGE RATIO (dB)	
		QPSK	16QAM
23035	701.5	5.16	5.80
23095	707.5	4.84	5.45
23155	713.5	4.87	5.51

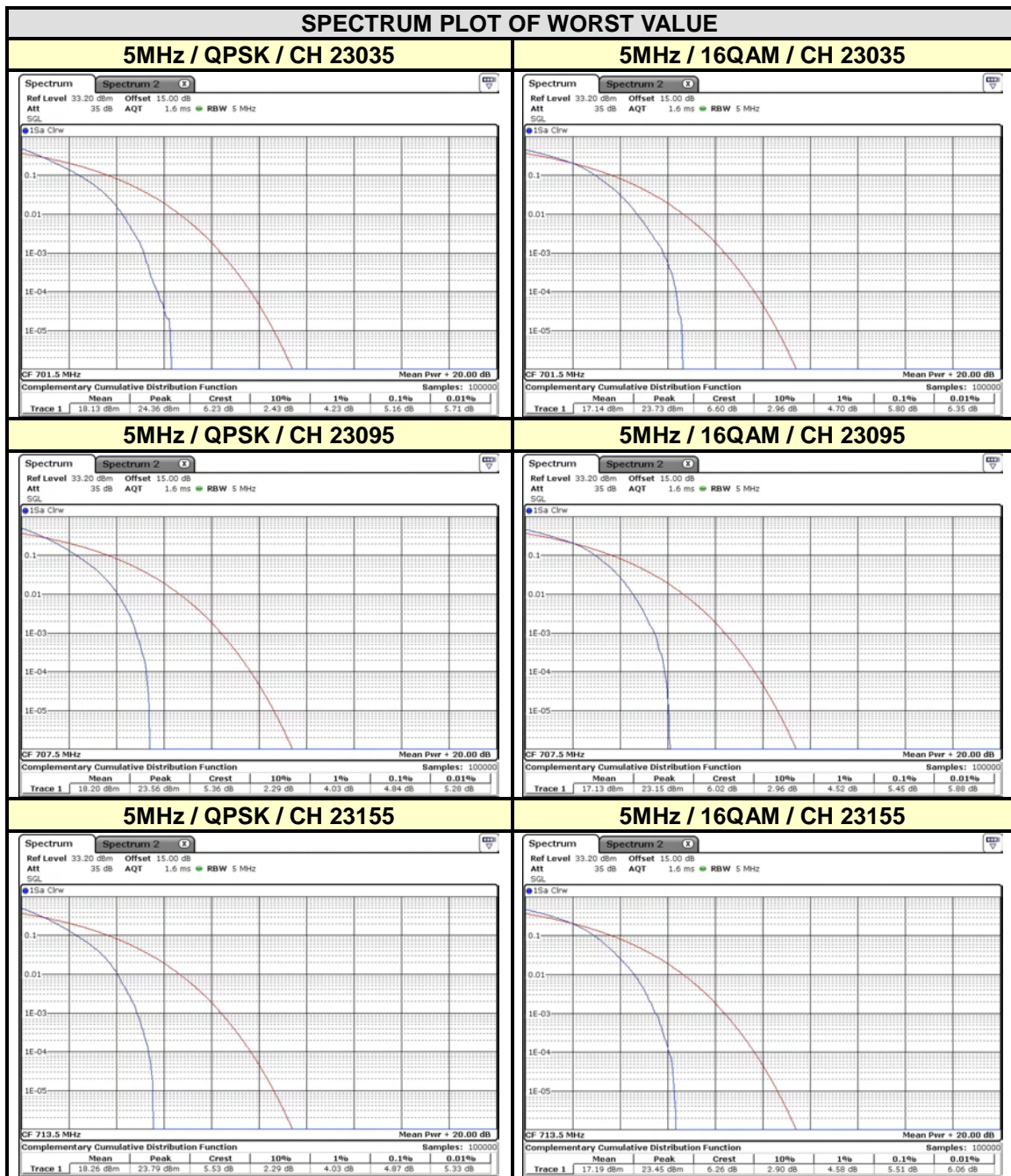



Test Report No.: RF140722N046-1

LTE BAND 12

CHANNEL BANDWIDTH: 10MHz			
CHANNEL	FREQUENCY (MHz)	PEAK TO AVERAGE RATIO (dB)	
		QPSK	16QAM
23060	704	5.10	5.51
23095	707.5	5.30	5.57
23130	711	5.01	5.48

