



**MET Laboratories, Inc.** *Safety Certification - EMI - Telecom Environmental Simulation*

914 WEST PATAPSCO AVENUE • BALTIMORE, MARYLAND 21230-3432 • PHONE (410) 354-3300 • FAX (410) 354-3313

33439 WESTERN AVENUE • UNION CITY, CALIFORNIA 94587 • PHONE (510) 489-6300 • FAX (510) 489-6372

3162 BELICK STREET • SANTA CLARA, CALIFORNIA 95054 • PHONE (408) 748-3585 • FAX (510) 489-6372

March 20, 2012

Fortress Technologies  
2 Technology Park Drive  
Westford, MA 01886

Dear John Pacheco,

Enclosed is the EMC Wireless test report for compliance testing of the Fortress Technologies, ES2440 as tested to the requirements of Title 47 of the CFR, Ch. 1 (10-1-06 ed.), Title 47 of the CFR, Part 15, Subpart B, Industry Canada ICES-003 Issue 4 February 2004 for Unintentional Radiators and Part 15.407, Industry Canada RSS-210, Issue 8, December 2010 for Intentional Radiators.

Thank you for using the services of MET Laboratories, Inc. If you have any questions regarding these results or if MET can be of further service to you, please feel free to contact me.

Sincerely yours,  
MET LABORATORIES, INC.

Jennifer Warnell  
Documentation Department

Reference: (\Fortress Technologies\EMC32466A-FCC407 Rev. 2 (UNII2))

Certificates and reports shall not be reproduced except in full, without the written permission of MET Laboratories, Inc.



**MET Laboratories, Inc.** *Safety Certification - EMI - Telecom Environmental Simulation*

914 WEST PATAPSCO AVENUE • BALTIMORE, MARYLAND 21230-3432 • PHONE (410) 354-3300 • FAX (410) 354-3313

33439 WESTERN AVENUE • UNION CITY, CALIFORNIA 94587 • PHONE (510) 489-6300 • FAX (510) 489-6372

3162 BELICK STREET • SANTA CLARA, CALIFORNIA 95054 • PHONE (408) 748-3585 • FAX (510) 489-6372

**Electromagnetic Compatibility Criteria  
Test Report**

for the

**Fortress Technologies  
Model ES2440**

**Tested under**

the Certification Rules  
contained in

Title 47 of the CFR, Part 15, Subpart B and  
ICES-003 Issue 4 February 2004  
for Unintentional Radiators

and

Title 47 of the CFR, Part 15.407 and  
Industry Canada RSS-210, Issue 8, December 2010  
for Intentional Radiators

**MET Report: EMC32466A-FCC407 Rev. 2 (UNII2)**

March 20, 2012

**Prepared For:**

**Fortress Technologies  
2 Technology Park Drive  
Westford, MA 01886**

**Prepared By:**  
**MET Laboratories, Inc.**  
914 W. Patapsco Ave.  
Baltimore, MD 21230

## Electromagnetic Compatibility Criteria Test Report

for the

### Fortress Technologies Model ES2440

the Certification Rules  
contained in  
Title 47 of the CFR, Part 15, Subpart B and  
ICES-003 Issue 4 February 2004  
for Unintentional Radiators  
and  
Title 47 of the CFR, Part 15.407 and  
Industry Canada RSS-210, Issue 8, December 2010  
for Intentional Radiators



Jeffrey Pratt, Project Engineer  
Electromagnetic Compatibility Lab



Jennifer Warnell  
Documentation Department

**Engineering Statement:** The measurements shown in this report were made in accordance with the procedures indicated, and the emissions from this equipment were found to be within the limits applicable. I assume full responsibility for the accuracy and completeness of these measurements, and for the qualifications of all persons taking them. It is further stated that upon the basis of the measurements made, the equipment tested is capable of operation in accordance with the requirements of Parts 15B, 15.407, of the FCC Rules and ICES-003 and RSS-210 of the Industry Canada rules under normal use and maintenance.



Shawn McMillen, Wireless Manager  
Electromagnetic Compatibility Lab

## Report Status Sheet

Revision	Report Date	Reason for Revision
∅	January 6, 2012	Initial Issue.
1	March 8, 2012	Revised to reflect engineer corrections.
2	March 20, 2012	Revised to reflect editorial corrections.

## Table of Contents

<b>I.</b>	<b>Executive Summary .....</b>	<b>1</b>
	A. Purpose of Test .....	2
	B. Executive Summary .....	2
<b>II.</b>	<b>Equipment Configuration .....</b>	<b>3</b>
	A. Overview.....	4
	B. References.....	5
	C. Test Site .....	5
	D. Description of Test Sample.....	6
	E. Equipment Configuration.....	7
	F. Support Equipment .....	7
	G. Ports and Cabling Information.....	7
	H. Mode of Operation.....	8
	I. Modifications .....	8
	a) Modifications to EUT.....	8
	b) Modifications to Test Standard.....	8
	J. Disposition of EUT .....	8
<b>III.</b>	<b>Electromagnetic Compatibility Criteria for Unintentional Radiators .....</b>	<b>9</b>
	§ 15.107(a) Conducted Emissions Limits.....	10
	§ 15.109(a) Radiated Emissions Limits.....	14
<b>IV.</b>	<b>Electromagnetic Compatibility Criteria for Intentional Radiators .....</b>	<b>18</b>
	§ 15.203 Antenna Requirement .....	19
	§ 15.207 Conducted Emissions Limits .....	20
	§ 15.403(c) 26dB Bandwidth.....	24
	§ 15.407(a) RF Power Output.....	46
	§ 15.407(a)(1)(2) Peak Power Spectral Density .....	69
	§ 15.407(a)(6) Peak Excursion Ratio.....	92
	§ 15.407(b) Undesirable Emissions.....	104
	a) EIRP .....	154
	b) Radiated Restricted Band .....	166
	§ 15.407(f) RF Exposure .....	178
	§ 15.407(g) Frequency Stability .....	179
	RSS-GEN Receiver Spurious Emissions.....	203
<b>V.</b>	<b>DFS Requirements and Radar Waveform Description &amp; Calibration .....</b>	<b>206</b>
	A. DFS Requirements .....	207
	B. Radar Test Waveforms .....	208
	C. Radar Waveform Calibration .....	211
<b>VI.</b>	<b>DFS Test Procedure and Test Results .....</b>	<b>214</b>
	A. DFS Test Setup .....	215
	B. Description of Master Device .....	216
	C. UNII Detection Bandwidth .....	217
	D. Initial Channel Availability Check Time .....	219
	E. Radar Burst at the Beginning of Channel Availability Check Time .....	221
	F. Radar Burst at the End of Channel Availability Check Time .....	223
	G. In-Service Monitoring for Channel Move Time, Channel Closing Time, and Non-Occupancy.....	225
	H. Statistical Performance Check .....	229
	I. DFS Setup.....	236
<b>VII.</b>	<b>Test Equipment .....</b>	<b>237</b>
<b>VIII.</b>	<b>Certification &amp; User's Manual Information .....</b>	<b>240</b>
	A. Certification Information .....	241
	B. Label and User's Manual Information .....	245
<b>IX.</b>	<b>Appendix .....</b>	<b>248</b>

## List of Tables

Table 1. Executive Summary of EMC Part 15.407 Compliance Testing .....	2
Table 2. EUT Summary.....	4
Table 3. References .....	5
Table 4. Equipment Configuration .....	7
Table 5. Support Equipment.....	7
Table 6. Ports and Cabling Information .....	7
Table 7. Conducted Limits for Radio Frequency Devices calculated from FCC Part 15 Subsections 15.107(a) (b) and 15.207(a) .....	10
Table 8. Conducted Emissions - Voltage, AC Power, Phase Line, Test Results.....	11
Table 9. Conducted Emissions - Voltage, AC Power, Neutral Line, Test Results .....	12
Table 10. Radiated Emissions Limits calculated from FCC Part 15, §15.109 (a) (b) .....	14
Table 11. Radiated Emissions, Test Results, FCC Limits, 30 MHz – 1 GHz .....	15
Table 12. Radiated Emissions, Test Results, ICES-003 Limits, 30 MHz – 1 GHz .....	16
Table 13. Conducted Limits for Intentional Radiators from FCC Part 15 § 15.207(a) .....	20
Table 14. Conducted Emissions - Voltage, AC Power, Phase Line, Test Results.....	21
Table 15. Conducted Emissions - Voltage, AC Power, Neutral Line, Test Results .....	22
Table 16. Occupied Bandwidth, Test Results, 802.11a .....	25
Table 17. Occupied Bandwidth, Test Results, 802.11n 20 MHz.....	25
Table 18. Occupied Bandwidth, Test Results, 802.11n 40 MHz.....	25
Table 19. Output Power Requirements from §15.407 .....	46
Table 20. RF Power Output, Test Results .....	47
Table 21. RF Power Output, Test Results, Sector Antenna.....	48
Table 22. Power Spectral Density, 802.11a, Test Results .....	70
Table 23. Power Spectral Density, 802.11a, Test Results, Sector Antenna .....	71
Table 24. Peak Excursion Ration, Test Results, 802.11a .....	92
Table 25. Peak Excursion Ration, Test Results, 802.11n 20 MHz.....	93
Table 26. Peak Excursion Ration, Test Results, 802.11n 40 MHz.....	93
Table 27. Restricted Bands of Operation.....	104
Table 28. Spurious Emission Limits for Receivers .....	203
Table 29. UNII Detection Bandwidth, Test Results .....	218
Table 30. Statistical Performance Check – Radar Type 1 .....	230
Table 31. Statistical Performance Check – Radar Type 2 .....	231
Table 32. Statistical Performance Check – Radar Type 3, 5580 MHz, 802.11a .....	232
Table 33. Statistical Performance Check – Radar Type 4 .....	233
Table 34. Statistical Performance Check – Radar Type 5 .....	234
Table 35. Statistical Performance Check – Radar Type 6 .....	235
Table 36. Test Equipment List .....	238
Table 37. DFS Test Equipment List .....	239

## List of Figures

Figure 1. Occupied Bandwidth Test Setup.....	24
Figure 2. Peak Power Output Test Setup.....	46
Figure 3. Peak Power Spectral Density Test Setup .....	69
Figure 4. Long Pulse Radar Test Signal Waveform .....	210
Figure 5. DFS Radar Waveform Calibration Setup .....	211
Figure 6. Test Setup Diagram.....	215

## List of Plots

Plot 1. Conducted Emission, Phase Line Plot .....	11
Plot 2. Conducted Emission, Neutral Line Plot.....	12
Plot 3. Radiated Emissions, Pre-Scan, FCC Limits, 30 MHz – 1 GHz .....	15
Plot 4. §15.207 Conducted Emissions, Phase Line Plot .....	21
Plot 5. §15.207 Conducted Emissions, Neutral Line Plot .....	22
Plot 9. Occupied Bandwidth, 802.11a, 5260 MHz .....	26
Plot 10. Occupied Bandwidth, 802.11a, 5300 MHz .....	26
Plot 11. Occupied Bandwidth, 802.11a, 5320 MHz .....	26
Plot 12. Occupied Bandwidth, 802.11a, 5500 MHz .....	27
Plot 13. Occupied Bandwidth, 802.11a, 5580 MHz .....	27
Plot 14. Occupied Bandwidth, 802.11a, 5700 MHz .....	27
Plot 18. Occupied Bandwidth, 802.11n 20 MHz, Port A, 5260 MHz .....	28
Plot 19. Occupied Bandwidth, 802.11n 20 MHz, Port A, 5300 MHz .....	28
Plot 20. Occupied Bandwidth, 802.11n 20 MHz, Port A, 5320 MHz .....	28
Plot 21. Occupied Bandwidth, 802.11n 20 MHz, Port A, 5500 MHz .....	29
Plot 22. Occupied Bandwidth, 802.11n 20 MHz, Port A, 5580 MHz .....	29
Plot 23. Occupied Bandwidth, 802.11n 20 MHz, Port A, 5700 MHz .....	29
Plot 27. Occupied Bandwidth, 802.11n 20 MHz, Port B, 5260 MHz .....	30
Plot 28. Occupied Bandwidth, 802.11n 20 MHz, Port B, 5300 MHz .....	30
Plot 29. Occupied Bandwidth, 802.11n 20 MHz, Port B, 5320 MHz .....	30
Plot 30. Occupied Bandwidth, 802.11n 20 MHz, Port B, 5500 MHz .....	31
Plot 31. Occupied Bandwidth, 802.11n 20 MHz, Port B, 5580 MHz .....	31
Plot 32. Occupied Bandwidth, 802.11n 20 MHz, Port B, 5700 MHz .....	31
Plot 36. Occupied Bandwidth, 802.11n 40 MHz, Port A, 5270 MHz .....	32
Plot 37. Occupied Bandwidth, 802.11n 40 MHz, Port A, 5300 MHz .....	32
Plot 38. Occupied Bandwidth, 802.11n 40 MHz, Port A, 5310 MHz .....	32
Plot 39. Occupied Bandwidth, 802.11n 40 MHz, Port A, 5510 MHz .....	33
Plot 40. Occupied Bandwidth, 802.11n 40 MHz, Port A, 5580 MHz .....	33
Plot 41. Occupied Bandwidth, 802.11n 40 MHz, Port A, 5690 MHz .....	33
Plot 45. Occupied Bandwidth, 802.11n 40 MHz, Port B, 5270 MHz .....	34
Plot 46. Occupied Bandwidth, 802.11n 40 MHz, Port B, 5300 MHz .....	34
Plot 47. Occupied Bandwidth, 802.11n 40 MHz, Port B, 5310 MHz .....	34
Plot 48. Occupied Bandwidth, 802.11n 40 MHz, Port B, 5510 MHz .....	35
Plot 49. Occupied Bandwidth, 802.11n 40 MHz, Port B, 5580 MHz .....	35
Plot 50. Occupied Bandwidth, 802.11n 40 MHz, Port B, 5690 MHz .....	35
Plot 54. 99% Occupied Bandwidth, 802.11a, 5260 MHz.....	36
Plot 55. 99% Occupied Bandwidth, 802.11a, 5300 MHz.....	36
Plot 56. 99% Occupied Bandwidth, 802.11a, 5320 MHz.....	36
Plot 57. 99% Occupied Bandwidth, 802.11a, 5500 MHz.....	37
Plot 58. 99% Occupied Bandwidth, 802.11a, 5580 MHz.....	37
Plot 59. 99% Occupied Bandwidth, 802.11a, 5700 MHz.....	37
Plot 63. 99% Occupied Bandwidth, 802.11n 20 MHz, Port A, 5260 MHz .....	38
Plot 64. 99% Occupied Bandwidth, 802.11n 20 MHz, Port A, 5300 MHz .....	38
Plot 65. 99% Occupied Bandwidth, 802.11n 20 MHz, Port A, 5320 MHz .....	38

Plot 66. 99% Occupied Bandwidth, 802.11n 20 MHz, Port A, 5500 MHz .....	39
Plot 67. 99% Occupied Bandwidth, 802.11n 20 MHz, Port A, 5580 MHz .....	39
Plot 68. 99% Occupied Bandwidth, 802.11n 20 MHz, Port A, 5700 MHz .....	39
Plot 72. 99% Occupied Bandwidth, 802.11n 20 MHz, Port B, 5260 MHz .....	40
Plot 73. 99% Occupied Bandwidth, 802.11n 20 MHz, Port B, 5300 MHz .....	40
Plot 74. 99% Occupied Bandwidth, 802.11n 20 MHz, Port B, 5320 MHz .....	40
Plot 75. 99% Occupied Bandwidth, 802.11n 20 MHz, Port B, 5500 MHz .....	41
Plot 76. 99% Occupied Bandwidth, 802.11n 20 MHz, Port B, 5580 MHz .....	41
Plot 77. 99% Occupied Bandwidth, 802.11n 20 MHz, Port B, 5700 MHz .....	41
Plot 81. 99% Occupied Bandwidth, 802.11n 40 MHz, Port A, 5270 MHz .....	42
Plot 82. 99% Occupied Bandwidth, 802.11n 40 MHz, Port A, 5300 MHz .....	42
Plot 83. 99% Occupied Bandwidth, 802.11n 40 MHz, Port A, 5310 MHz .....	42
Plot 84. 99% Occupied Bandwidth, 802.11n 40 MHz, Port A, 5510 MHz .....	43
Plot 85. 99% Occupied Bandwidth, 802.11n 40 MHz, Port A, 5580 MHz .....	43
Plot 86. 99% Occupied Bandwidth, 802.11n 40 MHz, Port A, 5690 MHz .....	43
Plot 90. 99% Occupied Bandwidth, 802.11n 40 MHz, Port B, 5270 MHz .....	44
Plot 91. 99% Occupied Bandwidth, 802.11n 40 MHz, Port B, 5300 MHz .....	44
Plot 92. 99% Occupied Bandwidth, 802.11n 40 MHz, Port B, 5310 MHz .....	44
Plot 93. 99% Occupied Bandwidth, 802.11n 40 MHz, Port B, 5510 MHz .....	45
Plot 94. 99% Occupied Bandwidth, 802.11n 40 MHz, Port B, 5580 MHz .....	45
Plot 95. 99% Occupied Bandwidth, 802.11n 40 MHz, Port B, 5690 MHz .....	45
Plot 99. Conducted Output Power, 802.11a, 5260 MHz .....	49
Plot 100. Conducted Output Power, 802.11a, 5300 MHz .....	49
Plot 101. Conducted Output Power, 802.11a, 5320 MHz .....	49
Plot 102. Conducted Output Power, 802.11a, 5500 MHz .....	50
Plot 103. Conducted Output Power, 802.11a, 5580 MHz .....	50
Plot 104. Conducted Output Power, 802.11a, 5700 MHz .....	50
Plot 108. Conducted Output Power, 802.11n 20 MHz, Port A, 5260 MHz .....	51
Plot 109. Conducted Output Power, 802.11n 20 MHz, Port A, 5300 MHz .....	51
Plot 110. Conducted Output Power, 802.11n 20 MHz, Port A, 5320 MHz .....	51
Plot 111. Conducted Output Power, 802.11n 20 MHz, Port A, 5500 MHz .....	52
Plot 112. Conducted Output Power, 802.11n 20 MHz, Port A, 5580 MHz .....	52
Plot 113. Conducted Output Power, 802.11n 20 MHz, Port A, 5700 MHz .....	52
Plot 117. Conducted Output Power, 802.11n 20 MHz, Port B, 5260 MHz .....	53
Plot 118. Conducted Output Power, 802.11n 20 MHz, Port B, 5300 MHz .....	53
Plot 119. Conducted Output Power, 802.11n 20 MHz, Port B, 5320 MHz .....	53
Plot 120. Conducted Output Power, 802.11n 20 MHz, Port B, 5500 MHz .....	54
Plot 121. Conducted Output Power, 802.11n 20 MHz, Port B, 5580 MHz .....	54
Plot 122. Conducted Output Power, 802.11n 20 MHz, Port B, 5700 MHz .....	54
Plot 126. Conducted Output Power, 802.11n 40 MHz, Port A, 5270 MHz .....	55
Plot 127. Conducted Output Power, 802.11n 40 MHz, Port A, 5300 MHz .....	55
Plot 128. Conducted Output Power, 802.11n 40 MHz, Port A, 5310 MHz .....	55
Plot 129. Conducted Output Power, 802.11n 40 MHz, Port A, 5510 MHz .....	56
Plot 130. Conducted Output Power, 802.11n 40 MHz, Port A, 5580 MHz .....	56
Plot 131. Conducted Output Power, 802.11n 40 MHz, Port A, 5690 MHz .....	56
Plot 135. Conducted Output Power, 802.11n 40 MHz, Port B, 5270 MHz .....	57
Plot 136. Conducted Output Power, 802.11n 40 MHz, Port B, 5300 MHz .....	57
Plot 137. Conducted Output Power, 802.11n 40 MHz, Port B, 5310 MHz .....	57
Plot 138. Conducted Output Power, 802.11n 40 MHz, Port B, 5510 MHz .....	58
Plot 139. Conducted Output Power, 802.11n 40 MHz, Port B, 5580 MHz .....	58
Plot 140. Conducted Output Power, 802.11n 40 MHz, Port B, 5690 MHz .....	58
Plot 144. Conducted Output Power, 802.11a, 5260 MHz, Sector Antenna .....	59
Plot 145. Conducted Output Power, 802.11a, 5300 MHz, Sector Antenna .....	59
Plot 146. Conducted Output Power, 802.11a, 5320 MHz, Sector Antenna .....	59
Plot 147. Conducted Output Power, 802.11a, 5500 MHz, Sector Antenna .....	60
Plot 148. Conducted Output Power, 802.11a, 5580 MHz, Sector Antenna .....	60
Plot 149. Conducted Output Power, 802.11a, 5700 MHz, Sector Antenna .....	60
Plot 153. Conducted Output Power, 802.11n 20 MHz, Port A, 5260 MHz, Sector Antenna .....	61



Plot 154. Conducted Output Power, 802.11n 20 MHz, Port A, 5300 MHz, Sector Antenna .....	61
Plot 155. Conducted Output Power, 802.11n 20 MHz, Port A, 5320 MHz, Sector Antenna .....	61
Plot 156. Conducted Output Power, 802.11n 20 MHz, Port A, 5500 MHz, Sector Antenna .....	62
Plot 157. Conducted Output Power, 802.11n 20 MHz, Port A, 5580 MHz, Sector Antenna .....	62
Plot 158. Conducted Output Power, 802.11n 20 MHz, Port A, 5700 MHz, Sector Antenna .....	62
Plot 162. Conducted Output Power, 802.11n 20 MHz, Port B, 5260 MHz, Sector Antenna .....	63
Plot 163. Conducted Output Power, 802.11n 20 MHz, Port B, 5300 MHz, Sector Antenna .....	63
Plot 164. Conducted Output Power, 802.11n 20 MHz, Port B, 5320 MHz, Sector Antenna .....	63
Plot 165. Conducted Output Power, 802.11n 20 MHz, Port B, 5500 MHz, Sector Antenna .....	64
Plot 166. Conducted Output Power, 802.11n 20 MHz, Port B, 5580 MHz, Sector Antenna .....	64
Plot 167. Conducted Output Power, 802.11n 20 MHz, Port B, 5700 MHz, Sector Antenna .....	64
Plot 171. Conducted Output Power, 802.11n 40 MHz, Port A, 5270 MHz, Sector Antenna .....	65
Plot 172. Conducted Output Power, 802.11n 40 MHz, Port A, 5300 MHz, Sector Antenna .....	65
Plot 173. Conducted Output Power, 802.11n 40 MHz, Port A, 5310 MHz, Sector Antenna .....	65
Plot 174. Conducted Output Power, 802.11n 40 MHz, Port A, 5510 MHz, Sector Antenna .....	66
Plot 175. Conducted Output Power, 802.11n 40 MHz, Port A, 5580 MHz, Sector Antenna .....	66
Plot 176. Conducted Output Power, 802.11n 40 MHz, Port A, 5690 MHz, Sector Antenna .....	66
Plot 180. Conducted Output Power, 802.11n 40 MHz, Port B, 5270 MHz, Sector Antenna .....	67
Plot 181. Conducted Output Power, 802.11n 40 MHz, Port B, 5300 MHz, Sector Antenna .....	67
Plot 182. Conducted Output Power, 802.11n 40 MHz, Port B, 5310 MHz, Sector Antenna .....	67
Plot 183. Conducted Output Power, 802.11n 40 MHz, Port B, 5510 MHz, Sector Antenna .....	68
Plot 184. Conducted Output Power, 802.11n 40 MHz, Port B, 5580 MHz, Sector Antenna .....	68
Plot 185. Conducted Output Power, 802.11n 40 MHz, Port B, 5690 MHz, Sector Antenna .....	68
Plot 189. Peak Spectral Density, 802.11a, 5260 MHz.....	72
Plot 190. Peak Spectral Density, 802.11a, 5300 MHz.....	72
Plot 191. Peak Spectral Density, 802.11a, 5320 MHz.....	72
Plot 192. Peak Spectral Density, 802.11a, 5500 MHz.....	73
Plot 193. Peak Spectral Density, 802.11a, 5580 MHz.....	73
Plot 194. Peak Spectral Density, 802.11a, 5700 MHz.....	73
Plot 198. Peak Spectral Density, 802.11n 20 MHz, Port A, 5260 MHz.....	74
Plot 199. Peak Spectral Density, 802.11n 20 MHz, Port A, 5300 MHz.....	74
Plot 200. Peak Spectral Density, 802.11n 20 MHz, Port A, 5320 MHz.....	74
Plot 201. Peak Spectral Density, 802.11n 20 MHz, Port A, 5500 MHz.....	75
Plot 202. Peak Spectral Density, 802.11n 20 MHz, Port A, 5580 MHz.....	75
Plot 203. Peak Spectral Density, 802.11n 20 MHz, Port A, 5700 MHz.....	75
Plot 207. Peak Spectral Density, 802.11n 20 MHz, Port B, 5260 MHz.....	76
Plot 208. Peak Spectral Density, 802.11n 20 MHz, Port B, 5300 MHz.....	76
Plot 209. Peak Spectral Density, 802.11n 20 MHz, Port B, 5320 MHz.....	76
Plot 210. Peak Spectral Density, 802.11n 20 MHz, Port B, 5500 MHz.....	77
Plot 211. Peak Spectral Density, 802.11n 20 MHz, Port B, 5580 MHz.....	77
Plot 212. Peak Spectral Density, 802.11n 20 MHz, Port B, 5700 MHz.....	77
Plot 216. Peak Spectral Density, 802.11n 40 MHz, Port A, 5270 MHz.....	78
Plot 217. Peak Spectral Density, 802.11n 40 MHz, Port A, 5300 MHz.....	78
Plot 218. Peak Spectral Density, 802.11n 40 MHz, Port A, 5310 MHz.....	78
Plot 219. Peak Spectral Density, 802.11n 40 MHz, Port A, 5510 MHz.....	79
Plot 220. Peak Spectral Density, 802.11n 40 MHz, Port A, 5580 MHz.....	79
Plot 221. Peak Spectral Density, 802.11n 40 MHz, Port A, 5690 MHz.....	79
Plot 225. Peak Spectral Density, 802.11n 40 MHz, Port B, 5270 MHz.....	80
Plot 226. Peak Spectral Density, 802.11n 40 MHz, Port B, 5300 MHz.....	80
Plot 227. Peak Spectral Density, 802.11n 40 MHz, Port B, 5310 MHz.....	80
Plot 228. Peak Spectral Density, 802.11n 40 MHz, Port B, 5510 MHz.....	81
Plot 229. Peak Spectral Density, 802.11n 40 MHz, Port B, 5580 MHz.....	81
Plot 230. Peak Spectral Density, 802.11n 40 MHz, Port B, 5690 MHz.....	81
Plot 234. Peak Spectral Density, 802.11a, 5260 MHz, Sector Antenna.....	82
Plot 235. Peak Spectral Density, 802.11a, 5300 MHz, Sector Antenna.....	82
Plot 236. Peak Spectral Density, 802.11a, 5320 MHz, Sector Antenna.....	82
Plot 237. Peak Spectral Density, 802.11a, 5500 MHz, Sector Antenna.....	83
Plot 238. Peak Spectral Density, 802.11a, 5580 MHz, Sector Antenna.....	83

Plot 239. Peak Spectral Density, 802.11a, 5700 MHz, Sector Antenna .....	83
Plot 243. Peak Spectral Density, 802.11n 20 MHz, Port A, 5260 MHz, Sector Antenna .....	84
Plot 244. Peak Spectral Density, 802.11n 20 MHz, Port A, 5300 MHz, Sector Antenna .....	84
Plot 245. Peak Spectral Density, 802.11n 20 MHz, Port A, 5320 MHz, Sector Antenna .....	84
Plot 246. Peak Spectral Density, 802.11n 20 MHz, Port A, 5500 MHz, Sector Antenna .....	85
Plot 247. Peak Spectral Density, 802.11n 20 MHz, Port A, 5580 MHz, Sector Antenna .....	85
Plot 248. Peak Spectral Density, 802.11n 20 MHz, Port A, 5700 MHz, Sector Antenna .....	85
Plot 252. Peak Spectral Density, 802.11n 20 MHz, Port B, 5260 MHz, Sector Antenna .....	86
Plot 253. Peak Spectral Density, 802.11n 20 MHz, Port B, 5300 MHz, Sector Antenna .....	86
Plot 254. Peak Spectral Density, 802.11n 20 MHz, Port B, 5320 MHz, Sector Antenna .....	86
Plot 255. Peak Spectral Density, 802.11n 20 MHz, Port B, 5500 MHz, Sector Antenna .....	87
Plot 256. Peak Spectral Density, 802.11n 20 MHz, Port B, 5580 MHz, Sector Antenna .....	87
Plot 257. Peak Spectral Density, 802.11n 20 MHz, Port B, 5700 MHz, Sector Antenna .....	87
Plot 261. Peak Spectral Density, 802.11n 40 MHz, Port A, 5270 MHz, Sector Antenna .....	88
Plot 262. Peak Spectral Density, 802.11n 40 MHz, Port A, 5300 MHz, Sector Antenna .....	88
Plot 263. Peak Spectral Density, 802.11n 40 MHz, Port A, 5310 MHz, Sector Antenna .....	88
Plot 264. Peak Spectral Density, 802.11n 40 MHz, Port A, 5510 MHz, Sector Antenna .....	89
Plot 265. Peak Spectral Density, 802.11n 40 MHz, Port A, 5580 MHz, Sector Antenna .....	89
Plot 266. Peak Spectral Density, 802.11n 40 MHz, Port A, 5690 MHz, Sector Antenna .....	89
Plot 270. Peak Spectral Density, 802.11n 40 MHz, Port B, 5270 MHz, Sector Antenna .....	90
Plot 271. Peak Spectral Density, 802.11n 40 MHz, Port B, 5300 MHz, Sector Antenna .....	90
Plot 272. Peak Spectral Density, 802.11n 40 MHz, Port B, 5310 MHz, Sector Antenna .....	90
Plot 273. Peak Spectral Density, 802.11n 40 MHz, Port B, 5510 MHz, Sector Antenna .....	91
Plot 274. Peak Spectral Density, 802.11n 40 MHz, Port B, 5580 MHz, Sector Antenna .....	91
Plot 275. Peak Spectral Density, 802.11n 40 MHz, Port B, 5690 MHz, Sector Antenna .....	91
Plot 279. Peak Excursion, 802.11a, 5260 MHz .....	94
Plot 280. Peak Excursion, 802.11a, 5300 MHz .....	94
Plot 281. Peak Excursion, 802.11a, 5320 MHz .....	94
Plot 282. Peak Excursion, 802.11a, 5500 MHz .....	95
Plot 283. Peak Excursion, 802.11a, 5580 MHz .....	95
Plot 284. Peak Excursion, 802.11a, 5700 MHz .....	95
Plot 288. Peak Excursion, 802.11n 20 MHz, Port A, 5260 MHz .....	96
Plot 289. Peak Excursion, 802.11n 20 MHz, Port A, 5300 MHz .....	96
Plot 290. Peak Excursion, 802.11n 20 MHz, Port A, 5320 MHz .....	96
Plot 291. Peak Excursion, 802.11n 20 MHz, Port A, 5500 MHz .....	97
Plot 292. Peak Excursion, 802.11n 20 MHz, Port A, 5580 MHz .....	97
Plot 293. Peak Excursion, 802.11n 20 MHz, Port A, 5700 MHz .....	97
Plot 297. Peak Excursion, 802.11n 20 MHz, Port B, 5260 MHz .....	98
Plot 298. Peak Excursion, 802.11n 20 MHz, Port B, 5300 MHz .....	98
Plot 299. Peak Excursion, 802.11n 20 MHz, Port B, 5320 MHz .....	98
Plot 300. Peak Excursion, 802.11n 20 MHz, Port B, 5500 MHz .....	99
Plot 301. Peak Excursion, 802.11n 20 MHz, Port B, 5580 MHz .....	99
Plot 302. Peak Excursion, 802.11n 20 MHz, Port B, 5700 MHz .....	99
Plot 306. Peak Excursion, 802.11n 40 MHz, Port A, 5270 MHz .....	100
Plot 307. Peak Excursion, 802.11n 40 MHz, Port A, 5300 MHz .....	100
Plot 308. Peak Excursion, 802.11n 40 MHz, Port A, 5310 MHz .....	100
Plot 309. Peak Excursion, 802.11n 40 MHz, Port A, 5510 MHz .....	101
Plot 310. Peak Excursion, 802.11n 40 MHz, Port A, 5580 MHz .....	101
Plot 311. Peak Excursion, 802.11n 40 MHz, Port A, 5690 MHz .....	101
Plot 315. Peak Excursion, 802.11n 40 MHz, Port B, 5270 MHz .....	102
Plot 316. Peak Excursion, 802.11n 40 MHz, Port B, 5300 MHz .....	102
Plot 317. Peak Excursion, 802.11n 40 MHz, Port B, 5310 MHz .....	102
Plot 318. Peak Excursion, 802.11n 40 MHz, Port B, 5510 MHz .....	103
Plot 319. Peak Excursion, 802.11n 40 MHz, Port B, 5580 MHz .....	103
Plot 320. Peak Excursion, 802.11n 40 MHz, Port B, 5690 MHz .....	103
Plot 333. Radiated Spurious, 802.11a, 5260 MHz, 30 MHz – 1 GHz, Omni Antenna .....	106
Plot 334. Radiated Spurious, 802.11a, 5260 MHz, 1 GHz – 7 GHz, Omni Antenna .....	106
Plot 335. Radiated Spurious, 802.11a, 5260 MHz, 7 GHz – 18 GHz, Omni Antenna .....	106

Plot 336. Radiated Spurious, 802.11a, 5260 MHz, 18 GHz – 40 GHz, Omni Antenna .....	107
Plot 337. Radiated Spurious, 802.11a, 5300 MHz, 30 MHz – 1 GHz, Omni Antenna .....	107
Plot 338. Radiated Spurious, 802.11a, 5300 MHz, 1 GHz – 7 GHz, Omni Antenna .....	107
Plot 339. Radiated Spurious, 802.11a, 5300 MHz, 7 GHz – 18 GHz, Omni Antenna .....	108
Plot 340. Radiated Spurious, 802.11a, 5300 MHz, 18 GHz – 40 GHz, Omni Antenna .....	108
Plot 341. Radiated Spurious, 802.11a, 5320 MHz, 30 MHz – 1 GHz, Omni Antenna .....	108
Plot 342. Radiated Spurious, 802.11a, 5320 MHz, 1 GHz – 7 GHz, Omni Antenna .....	109
Plot 343. Radiated Spurious, 802.11a, 5320 MHz, 7 GHz – 18 GHz, Omni Antenna .....	109
Plot 344. Radiated Spurious, 802.11a, 5320 MHz, 18 GHz – 40 GHz, Omni Antenna .....	109
Plot 345. Radiated Spurious, 802.11a, 5500 MHz, 30 MHz – 1 GHz, Omni Antenna .....	110
Plot 346. Radiated Spurious, 802.11a, 5500 MHz, 1 GHz – 7 GHz, Omni Antenna .....	110
Plot 347. Radiated Spurious, 802.11a, 5500 MHz, 7 GHz – 18 GHz, Omni Antenna .....	110
Plot 348. Radiated Spurious, 802.11a, 5500 MHz, 18 MHz – 40 GHz, Omni Antenna .....	111
Plot 349. Radiated Spurious, 802.11a, 5580 MHz, 30 MHz – 1 GHz, Omni Antenna .....	111
Plot 350. Radiated Spurious, 802.11a, 5580 MHz, 1 GHz – 7 GHz, Omni Antenna .....	111
Plot 351. Radiated Spurious, 802.11a, 5580 MHz, 7 GHz – 18 GHz, Omni Antenna .....	112
Plot 352. Radiated Spurious, 802.11a, 5580 MHz, 18 GHz – 40 GHz, Omni Antenna .....	112
Plot 353. Radiated Spurious, 802.11a, 5700 MHz, 30 MHz – 1 GHz, Omni Antenna .....	112
Plot 354. Radiated Spurious, 802.11a, 5700 MHz, 1 GHz – 7 GHz, Omni Antenna .....	113
Plot 355. Radiated Spurious, 802.11a, 5700 MHz, 7 GHz – 18 GHz, Omni Antenna .....	113
Plot 356. Radiated Spurious, 802.11a, 5700 MHz, 18 GHz – 40 GHz, Omni Antenna .....	113
Plot 369. Radiated Spurious, 802.11n 20 MHz, 5260 MHz, 30 MHz – 1 GHz, Omni Antenna .....	114
Plot 370. Radiated Spurious, 802.11n 20 MHz, 5260 MHz, 1 GHz – 7 GHz, Omni Antenna .....	114
Plot 371. Radiated Spurious, 802.11n 20 MHz, 5260 MHz, 7 GHz – 18 GHz, Omni Antenna .....	114
Plot 372. Radiated Spurious, 802.11n 20 MHz, 5260 MHz, 18 GHz – 40 GHz, Omni Antenna .....	115
Plot 373. Radiated Spurious, 802.11n 20 MHz, 5300 MHz, 30 MHz – 1 GHz, Omni Antenna .....	115
Plot 374. Radiated Spurious, 802.11n 20 MHz, 5300 MHz, 1 GHz – 7 GHz, Omni Antenna .....	115
Plot 375. Radiated Spurious, 802.11n 20 MHz, 5300 MHz, 7 GHz – 18 GHz, Omni Antenna .....	116
Plot 376. Radiated Spurious, 802.11n 20 MHz, 5300 MHz, 18 GHz – 40 GHz, Omni Antenna .....	116
Plot 377. Radiated Spurious, 802.11n 20 MHz, 5320 MHz, 30 MHz – 1 GHz, Omni Antenna .....	116
Plot 378. Radiated Spurious, 802.11n 20 MHz, 5320 MHz, 1 GHz – 7 GHz, Omni Antenna .....	117
Plot 379. Radiated Spurious, 802.11n 20 MHz, 5320 MHz, 7 GHz – 18 GHz, Omni Antenna .....	117
Plot 380. Radiated Spurious, 802.11n 20 MHz, 5320 MHz, 18 GHz – 40 GHz, Omni Antenna .....	117
Plot 381. Radiated Spurious, 802.11n 20 MHz, 5500 MHz, 30 MHz – 1 GHz, Omni Antenna .....	118
Plot 382. Radiated Spurious, 802.11n 20 MHz, 5500 MHz, 1 GHz – 7 GHz, Omni Antenna .....	118
Plot 383. Radiated Spurious, 802.11n 20 MHz, 5500 MHz, 7 GHz – 18 GHz, Omni Antenna .....	118
Plot 384. Radiated Spurious, 802.11n 20 MHz, 5500 MHz, 18 MHz – 40 GHz, Omni Antenna .....	119
Plot 385. Radiated Spurious, 802.11n 20 MHz, 5580 MHz, 30 MHz – 1 GHz, Omni Antenna .....	119
Plot 386. Radiated Spurious, 802.11n 20 MHz, 5580 MHz, 1 GHz – 7 GHz, Omni Antenna .....	119
Plot 387. Radiated Spurious, 802.11n 20 MHz, 5580 MHz, 7 GHz – 18 GHz, Omni Antenna .....	120
Plot 388. Radiated Spurious, 802.11n 20 MHz, 5580 MHz, 18 GHz – 40 GHz, Omni Antenna .....	120
Plot 389. Radiated Spurious, 802.11n 20 MHz, 5700 MHz, 30 MHz – 1 GHz, Omni Antenna .....	120
Plot 390. Radiated Spurious, 802.11n 20 MHz, 5700 MHz, 1 GHz – 7 GHz, Omni Antenna .....	121
Plot 391. Radiated Spurious, 802.11n 20 MHz, 5700 MHz, 7 GHz – 18 GHz, Omni Antenna .....	121
Plot 392. Radiated Spurious, 802.11n 20 MHz, 5700 MHz, 18 GHz – 40 GHz, Omni Antenna .....	121
Plot 405. Radiated Spurious, 802.11n 40 MHz, 5270 MHz, 30 MHz – 1 GHz, Omni Antenna .....	122
Plot 406. Radiated Spurious, 802.11n 40 MHz, 5270 MHz, 1 GHz – 7 GHz, Omni Antenna .....	122
Plot 407. Radiated Spurious, 802.11n 40 MHz, 5270 MHz, 7 GHz – 18 GHz, Omni Antenna .....	122
Plot 408. Radiated Spurious, 802.11n 40 MHz, 5270 MHz, 18 GHz – 40 GHz, Omni Antenna .....	123
Plot 409. Radiated Spurious, 802.11n 40 MHz, 5300 MHz, 30 MHz – 1 GHz, Omni Antenna .....	123
Plot 410. Radiated Spurious, 802.11n 40 MHz, 5300 MHz, 1 GHz – 7 GHz, Omni Antenna .....	123
Plot 411. Radiated Spurious, 802.11n 40 MHz, 5300 MHz, 7 GHz – 18 GHz, Omni Antenna .....	124
Plot 412. Radiated Spurious, 802.11n 40 MHz, 5300 MHz, 18 GHz – 40 GHz, Omni Antenna .....	124
Plot 413. Radiated Spurious, 802.11n 40 MHz, 5310 MHz, 30 MHz – 1 GHz, Omni Antenna .....	124
Plot 414. Radiated Spurious, 802.11n 40 MHz, 5310 MHz, 1 GHz – 7 GHz, Omni Antenna .....	125
Plot 415. Radiated Spurious, 802.11n 40 MHz, 5310 MHz, 7 GHz – 18 GHz, Omni Antenna .....	125
Plot 416. Radiated Spurious, 802.11n 40 MHz, 5310 MHz, 18 GHz – 40 GHz, Omni Antenna .....	125
Plot 417. Radiated Spurious, 802.11n 40 MHz, 5510 MHz, 30 MHz – 1 GHz, Omni Antenna .....	126



Plot 418. Radiated Spurious, 802.11n 40 MHz, 5510 MHz, 1 GHz – 7 GHz, Omni Antenna.....	126
Plot 419. Radiated Spurious, 802.11n 40 MHz, 5510 MHz, 7 GHz – 18 GHz, Omni Antenna.....	126
Plot 420. Radiated Spurious, 802.11n 40 MHz, 5510 MHz, 18 MHz – 40 GHz, Omni Antenna .....	127
Plot 421. Radiated Spurious, 802.11n 40 MHz, 5580 MHz, 30 MHz – 1 GHz, Omni Antenna .....	127
Plot 422. Radiated Spurious, 802.11n 40 MHz, 5580 MHz, 1 GHz – 7 GHz, Omni Antenna.....	127
Plot 423. Radiated Spurious, 802.11n 40 MHz, 5580 MHz, 7 GHz – 18 GHz, Omni Antenna.....	128
Plot 424. Radiated Spurious, 802.11n 40 MHz, 5580 MHz, 18 GHz – 40 GHz, Omni Antenna.....	128
Plot 425. Radiated Spurious, 802.11n 40 MHz, 5690 MHz, 30 MHz – 1 GHz, Omni Antenna .....	128
Plot 426. Radiated Spurious, 802.11n 40 MHz, 5690 MHz, 1 GHz – 7 GHz, Omni Antenna.....	129
Plot 427. Radiated Spurious, 802.11n 40 MHz, 5690 MHz, 7 GHz – 18 GHz, Omni Antenna.....	129
Plot 428. Radiated Spurious, 802.11n 40 MHz, 5690 MHz, 18 GHz – 40 GHz, Omni Antenna.....	129
Plot 441. Radiated Spurious, 802.11a, 5260 MHz, 30 MHz – 1 GHz, Sector Antenna .....	130
Plot 442. Radiated Spurious, 802.11a, 5260 MHz, 1 GHz – 7 GHz, Sector Antenna.....	130
Plot 443. Radiated Spurious, 802.11a, 5260 MHz, 7 GHz – 18 GHz, Sector Antenna.....	130
Plot 444. Radiated Spurious, 802.11a, 5260 MHz, 18 GHz – 40 GHz, Sector Antenna .....	131
Plot 445. Radiated Spurious, 802.11a, 5300 MHz, 30 MHz – 1 GHz, Sector Antenna .....	131
Plot 446. Radiated Spurious, 802.11a, 5300 MHz, 1 GHz – 7 GHz, Sector Antenna.....	131
Plot 447. Radiated Spurious, 802.11a, 5300 MHz, 7 GHz – 18 GHz, Sector Antenna.....	132
Plot 448. Radiated Spurious, 802.11a, 5300 MHz, 18 GHz – 40 GHz, Sector Antenna.....	132
Plot 449. Radiated Spurious, 802.11a, 5320 MHz, 30 MHz – 1 GHz, Sector Antenna .....	132
Plot 450. Radiated Spurious, 802.11a, 5320 MHz, 1 GHz – 7 GHz, Sector Antenna.....	133
Plot 451. Radiated Spurious, 802.11a, 5320 MHz, 7 GHz – 18 GHz, Sector Antenna.....	133
Plot 452. Radiated Spurious, 802.11a, 5320 MHz, 18 GHz – 40 GHz, Sector Antenna.....	133
Plot 453. Radiated Spurious, 802.11a, 5500 MHz, 30 MHz – 1 GHz, Sector Antenna .....	134
Plot 454. Radiated Spurious, 802.11a, 5500 MHz, 1 GHz – 7 GHz, Sector Antenna.....	134
Plot 455. Radiated Spurious, 802.11a, 5500 MHz, 7 GHz – 18 GHz, Sector Antenna.....	134
Plot 456. Radiated Spurious, 802.11a, 5500 MHz, 18 MHz – 40 GHz, Sector Antenna .....	135
Plot 457. Radiated Spurious, 802.11a, 5580 MHz, 30 MHz – 1 GHz, Sector Antenna .....	135
Plot 458. Radiated Spurious, 802.11a, 5580 MHz, 1 GHz – 7 GHz, Sector Antenna.....	135
Plot 459. Radiated Spurious, 802.11a, 5580 MHz, 7 GHz – 18 GHz, Sector Antenna.....	136
Plot 460. Radiated Spurious, 802.11a, 5580 MHz, 18 GHz – 40 GHz, Sector Antenna.....	136
Plot 461. Radiated Spurious, 802.11a, 5700 MHz, 30 MHz – 1 GHz, Sector Antenna .....	136
Plot 462. Radiated Spurious, 802.11a, 5700 MHz, 1 GHz – 7 GHz, Sector Antenna.....	137
Plot 463. Radiated Spurious, 802.11a, 5700 MHz, 7 GHz – 18 GHz, Sector Antenna.....	137
Plot 464. Radiated Spurious, 802.11a, 5700 MHz, 18 GHz – 40 GHz, Sector Antenna.....	137
Plot 477. Radiated Spurious, 802.11n 20 MHz, 5260 MHz, 30 MHz – 1 GHz, Sector Antenna .....	138
Plot 478. Radiated Spurious, 802.11n 20 MHz, 5260 MHz, 1 GHz – 7 GHz, Sector Antenna.....	138
Plot 479. Radiated Spurious, 802.11n 20 MHz, 5260 MHz, 7 GHz – 18 GHz, Sector Antenna.....	138
Plot 480. Radiated Spurious, 802.11n 20 MHz, 5260 MHz, 18 GHz – 40 GHz, Sector Antenna.....	139
Plot 481. Radiated Spurious, 802.11n 20 MHz, 5300 MHz, 30 MHz – 1 GHz, Sector Antenna .....	139
Plot 482. Radiated Spurious, 802.11n 20 MHz, 5300 MHz, 1 GHz – 7 GHz, Sector Antenna.....	139
Plot 483. Radiated Spurious, 802.11n 20 MHz, 5300 MHz, 7 GHz – 18 GHz, Sector Antenna.....	140
Plot 484. Radiated Spurious, 802.11n 20 MHz, 5300 MHz, 18 GHz – 40 GHz, Sector Antenna.....	140
Plot 485. Radiated Spurious, 802.11n 20 MHz, 5320 MHz, 30 MHz – 1 GHz, Sector Antenna .....	140
Plot 486. Radiated Spurious, 802.11n 20 MHz, 5320 MHz, 1 GHz – 7 GHz, Sector Antenna.....	141
Plot 487. Radiated Spurious, 802.11n 20 MHz, 5320 MHz, 7 GHz – 18 GHz, Sector Antenna.....	141
Plot 488. Radiated Spurious, 802.11n 20 MHz, 5320 MHz, 18 GHz – 40 GHz, Sector Antenna.....	141
Plot 489. Radiated Spurious, 802.11n 20 MHz, 5500 MHz, 30 MHz – 1 GHz, Sector Antenna .....	142
Plot 490. Radiated Spurious, 802.11n 20 MHz, 5500 MHz, 1 GHz – 7 GHz, Sector Antenna.....	142
Plot 491. Radiated Spurious, 802.11n 20 MHz, 5500 MHz, 7 GHz – 18 GHz, Sector Antenna.....	142
Plot 492. Radiated Spurious, 802.11n 20 MHz, 5500 MHz, 18 MHz – 40 GHz, Sector Antenna .....	143
Plot 493. Radiated Spurious, 802.11n 20 MHz, 5580 MHz, 30 MHz – 1 GHz, Sector Antenna .....	143
Plot 494. Radiated Spurious, 802.11n 20 MHz, 5580 MHz, 1 GHz – 7 GHz, Sector Antenna.....	143
Plot 495. Radiated Spurious, 802.11n 20 MHz, 5580 MHz, 7 GHz – 18 GHz, Sector Antenna.....	144
Plot 496. Radiated Spurious, 802.11n 20 MHz, 5580 MHz, 18 GHz – 40 GHz, Sector Antenna.....	144
Plot 497. Radiated Spurious, 802.11n 20 MHz, 5700 MHz, 30 MHz – 1 GHz, Sector Antenna .....	144
Plot 498. Radiated Spurious, 802.11n 20 MHz, 5700 MHz, 1 GHz – 7 GHz, Sector Antenna.....	145
Plot 499. Radiated Spurious, 802.11n 20 MHz, 5700 MHz, 7 GHz – 18 GHz, Sector Antenna.....	145

Plot 500. Radiated Spurious, 802.11n 20 MHz, 5700 MHz, 18 GHz – 40 GHz, Sector Antenna.....	145
Plot 513. Radiated Spurious, 802.11n 40 MHz, 5270 MHz, 30 MHz – 1 GHz, Sector Antenna.....	146
Plot 514. Radiated Spurious, 802.11n 40 MHz, 5270 MHz, 1 GHz – 7 GHz, Sector Antenna.....	146
Plot 515. Radiated Spurious, 802.11n 40 MHz, 5270 MHz, 7 GHz – 18 GHz, Sector Antenna.....	146
Plot 516. Radiated Spurious, 802.11n 40 MHz, 5270 MHz, 18 GHz – 40 GHz, Sector Antenna.....	147
Plot 517. Radiated Spurious, 802.11n 40 MHz, 5300 MHz, 30 MHz – 1 GHz, Sector Antenna.....	147
Plot 518. Radiated Spurious, 802.11n 40 MHz, 5300 MHz, 1 GHz – 7 GHz, Sector Antenna.....	147
Plot 519. Radiated Spurious, 802.11n 40 MHz, 5300 MHz, 7 GHz – 18 GHz, Sector Antenna.....	148
Plot 520. Radiated Spurious, 802.11n 40 MHz, 5300 MHz, 18 GHz – 40 GHz, Sector Antenna.....	148
Plot 521. Radiated Spurious, 802.11n 40 MHz, 5310 MHz, 30 MHz – 1 GHz, Sector Antenna.....	148
Plot 522. Radiated Spurious, 802.11n 40 MHz, 5310 MHz, 1 GHz – 7 GHz, Sector Antenna.....	149
Plot 523. Radiated Spurious, 802.11n 40 MHz, 5310 MHz, 7 GHz – 18 GHz, Sector Antenna.....	149
Plot 524. Radiated Spurious, 802.11n 40 MHz, 5310 MHz, 18 GHz – 40 GHz, Sector Antenna.....	149
Plot 525. Radiated Spurious, 802.11n 40 MHz, 5510 MHz, 30 MHz – 1 GHz, Sector Antenna.....	150
Plot 526. Radiated Spurious, 802.11n 40 MHz, 5510 MHz, 1 GHz – 7 GHz, Sector Antenna.....	150
Plot 527. Radiated Spurious, 802.11n 40 MHz, 5510 MHz, 7 GHz – 18 GHz, Sector Antenna.....	150
Plot 528. Radiated Spurious, 802.11n 40 MHz, 5510 MHz, 18 MHz – 40 GHz, Sector Antenna.....	151
Plot 529. Radiated Spurious, 802.11n 40 MHz, 5580 MHz, 30 MHz – 1 GHz, Sector Antenna.....	151
Plot 530. Radiated Spurious, 802.11n 40 MHz, 5580 MHz, 1 GHz – 7 GHz, Sector Antenna.....	151
Plot 531. Radiated Spurious, 802.11n 40 MHz, 5580 MHz, 7 GHz – 18 GHz, Sector Antenna.....	152
Plot 532. Radiated Spurious, 802.11n 40 MHz, 5580 MHz, 18 GHz – 40 GHz, Sector Antenna.....	152
Plot 533. Radiated Spurious, 802.11n 40 MHz, 5690 MHz, 30 MHz – 1 GHz, Sector Antenna.....	152
Plot 534. Radiated Spurious, 802.11n 40 MHz, 5690 MHz, 1 GHz – 7 GHz, Sector Antenna.....	153
Plot 535. Radiated Spurious, 802.11n 40 MHz, 5690 MHz, 7 GHz – 18 GHz, Sector Antenna.....	153
Plot 536. Radiated Spurious, 802.11n 40 MHz, 5690 MHz, 18 GHz – 40 GHz, Sector Antenna.....	153
Plot 539. EIRP, 802.11a, 5260 MHz, Band Edge, Omni Antenna.....	154
Plot 540. EIRP, 802.11a, 5320 MHz, Band Edge, Omni Antenna.....	154
Plot 541. EIRP, 802.11a, 5500 MHz, Band Edge, Omni Antenna.....	154
Plot 542. EIRP, 802.11a, 5700 MHz, Band Edge, Omni Antenna.....	155
Plot 545. EIRP, 802.11n 20 MHz, 5260 MHz, Band Edge, Omni Antenna.....	156
Plot 546. EIRP, 802.11n 20 MHz, 5320 MHz, Band Edge, Omni Antenna.....	156
Plot 547. EIRP, 802.11n 20 MHz, 5500 MHz, Band Edge, Omni Antenna.....	156
Plot 548. EIRP, 802.11n 20 MHz, 5700 MHz, Band Edge, Omni Antenna.....	157
Plot 551. EIRP, 802.11n 40 MHz, 5270 MHz, Band Edge, Omni Antenna.....	158
Plot 552. EIRP, 802.11n 40 MHz, 5310 MHz, Band Edge, Omni Antenna.....	158
Plot 553. EIRP, 802.11n 40 MHz, 5510 MHz, Band Edge, Omni Antenna.....	158
Plot 554. EIRP, 802.11n 40 MHz, 5690 MHz, Band Edge, Omni Antenna.....	159
Plot 557. EIRP, 802.11a, 5260 MHz, Band Edge, Sector Antenna.....	160
Plot 558. EIRP, 802.11a, 5320 MHz, Band Edge, Sector Antenna.....	160
Plot 559. EIRP, 802.11a, 5500 MHz, Band Edge, Sector Antenna.....	160
Plot 560. EIRP, 802.11a, 5700 MHz, Band Edge, Sector Antenna.....	161
Plot 563. EIRP, 802.11n 20 MHz, 5260 MHz, Band Edge, Sector Antenna.....	162
Plot 564. EIRP, 802.11n 20 MHz, 5320 MHz, Band Edge, Sector Antenna.....	162
Plot 565. EIRP, 802.11n 20 MHz, 5500 MHz, Band Edge, Sector Antenna.....	162
Plot 566. EIRP, 802.11n 20 MHz, 5700 MHz, Band Edge, Sector Antenna.....	163
Plot 569. EIRP, 802.11n 40 MHz, 5270 MHz, Band Edge, Sector Antenna.....	164
Plot 570. EIRP, 802.11n 40 MHz, 5310 MHz, Band Edge, Sector Antenna.....	164
Plot 571. EIRP, 802.11n 40 MHz, 5510 MHz, Band Edge, Sector Antenna.....	164
Plot 572. EIRP, 802.11n 40 MHz, 5690 MHz, Band Edge, Sector Antenna.....	165
Plot 575. Restricted Band, 802.11a, 5320 MHz, Average, Omni Antenna.....	166
Plot 576. Restricted Band, 802.11a, 5320 MHz, Peak, Omni Antenna.....	166
Plot 577. Restricted Band, 802.11a, 5500 MHz, Average, Omni Antenna.....	166
Plot 578. Restricted Band, 802.11a, 5500 MHz, Peak, Omni Antenna.....	167
Plot 581. Restricted Band, 802.11n 20 MHz, 5320 MHz, Average, Omni Antenna.....	168
Plot 582. Restricted Band, 802.11n 20 MHz, 5320 MHz, Peak, Omni Antenna.....	168
Plot 583. Restricted Band, 802.11n 20 MHz, 5500 MHz, Average, Omni Antenna.....	168
Plot 584. Restricted Band, 802.11n 20 MHz, 5500 MHz, Peak, Omni Antenna.....	169
Plot 587. Restricted Band, 802.11n 40 MHz, 5310 MHz, Average, Omni Antenna.....	170

Plot 588. Restricted Band, 802.11n 40 MHz, 5310 MHz, Peak, Omni Antenna.....	170
Plot 589. Restricted Band, 802.11n 40 MHz, 5510 MHz, Average, Omni Antenna .....	170
Plot 590. Restricted Band, 802.11n 40 MHz, 5510 MHz, Peak, Omni Antenna.....	171
Plot 593. Restricted Band, 802.11a, 5320 MHz, Average, Sector Antenna .....	172
Plot 594. Restricted Band, 802.11a, 5320 MHz, Peak, Sector Antenna .....	172
Plot 595. Restricted Band, 802.11a, 5500 MHz, Average, Sector Antenna .....	172
Plot 596. Restricted Band, 802.11a, 5500 MHz, Peak, Sector Antenna .....	173
Plot 599. Restricted Band, 802.11n 20 MHz, 5320 MHz, Average, Sector Antenna .....	174
Plot 600. Restricted Band, 802.11n 20 MHz, 5320 MHz, Peak, Sector Antenna.....	174
Plot 601. Restricted Band, 802.11n 20 MHz, 5500 MHz, Average, Sector Antenna .....	174
Plot 602. Restricted Band, 802.11n 20 MHz, 5500 MHz, Peak, Sector Antenna.....	175
Plot 605. Restricted Band, 802.11n 40 MHz, 5310 MHz, Average, Sector Antenna .....	176
Plot 606. Restricted Band, 802.11n 40 MHz, 5310 MHz, Peak, Sector Antenna.....	176
Plot 607. Restricted Band, 802.11n 40 MHz, 5510 MHz, Average, Sector Antenna .....	176
Plot 608. Restricted Band, 802.11n 40 MHz, 5510 MHz, Peak, Sector Antenna.....	177
Plot 621. Frequency Stability, 802.11a, 5250 MHz – 5350 MHz @ -10°C, 120 V .....	180
Plot 622. Frequency Stability, 802.11a, 5250 MHz – 5350 MHz @ 0°C, 120 V.....	180
Plot 623. Frequency Stability, 802.11a, 5250 MHz – 5350 MHz @ 10°C, 120 V.....	180
Plot 624. Frequency Stability, 802.11a, 5250 MHz – 5350 MHz @ 20°C, 108 V.....	181
Plot 625. Frequency Stability, 802.11a, 5250 MHz – 5350 MHz @ 20°C, 120 V.....	181
Plot 626. Frequency Stability, 802.11a, 5250 MHz – 5350 MHz @ 20°C, 132 V.....	181
Plot 627. Frequency Stability, 802.11a, 5250 MHz – 5350 MHz @ 30°C, 120 V.....	182
Plot 628. Frequency Stability, 802.11a, 5250 MHz – 5350 MHz @ 40°C, 120 V.....	182
Plot 629. Frequency Stability, 802.11a, 5250 MHz – 5350 MHz @ 50°C, 120 V.....	182
Plot 630. Frequency Stability, 802.11a, 5250 MHz – 5350 MHz @ 55°C, 120 V.....	183
Plot 631. Frequency Stability, 802.11a, 5470 MHz – 5725 MHz @ -20°C, 120 V .....	183
Plot 632. Frequency Stability, 802.11a, 5470 MHz – 5725 MHz @ -10°C, 120 V .....	183
Plot 633. Frequency Stability, 802.11a, 5470 MHz – 5725 MHz @ 0°C, 120 V.....	184
Plot 634. Frequency Stability, 802.11a, 5470 MHz – 5725 MHz @ 10°C, 120 V.....	184
Plot 635. Frequency Stability, 802.11a, 5470 MHz – 5725 MHz @ 20°C, 108 V.....	184
Plot 636. Frequency Stability, 802.11a, 5470 MHz – 5725 MHz @ 20°C, 120 V.....	185
Plot 637. Frequency Stability, 802.11a, 5470 MHz – 5725 MHz @ 20°C, 132 V.....	185
Plot 638. Frequency Stability, 802.11a, 5470 MHz – 5725 MHz @ 30°C, 120 V.....	185
Plot 639. Frequency Stability, 802.11a, 5470 MHz – 5725 MHz @ 40°C, 120 V.....	186
Plot 640. Frequency Stability, 802.11a, 5470 MHz – 5725 MHz @ 50°C, 120 V.....	186
Plot 641. Frequency Stability, 802.11a, 5470 MHz – 5725 MHz @ 55°C, 120 V.....	186
Plot 653. Frequency Stability, 802.11n 20 MHz, 5250 MHz – 5350 MHz @ -20°C, 120 V .....	187
Plot 654. Frequency Stability, 802.11n 20 MHz, 5250 MHz – 5350 MHz @ -10°C, 120 V .....	187
Plot 655. Frequency Stability, 802.11n 20 MHz, 5250 MHz – 5350 MHz @ 0°C, 120 V .....	187
Plot 656. Frequency Stability, 802.11n 20 MHz, 5250 MHz – 5350 MHz @ 10°C, 120 V .....	188
Plot 657. Frequency Stability, 802.11n 20 MHz, 5250 MHz – 5350 MHz @ 20°C, 108 V .....	188
Plot 658. Frequency Stability, 802.11n 20 MHz, 5250 MHz – 5350 MHz @ 20°C, 120 V .....	188
Plot 659. Frequency Stability, 802.11n 20 MHz, 5250 MHz – 5350 MHz @ 20°C, 132 V .....	189
Plot 660. Frequency Stability, 802.11n 20 MHz, 5250 MHz – 5350 MHz @ 30°C, 120 V .....	189
Plot 661. Frequency Stability, 802.11n 20 MHz, 5250 MHz – 5350 MHz @ 40°C, 120 V .....	189
Plot 662. Frequency Stability, 802.11n 20 MHz, 5250 MHz – 5350 MHz @ 50°C, 120 V .....	190
Plot 663. Frequency Stability, 802.11n 20 MHz, 5250 MHz – 5350 MHz @ 55°C, 120 V .....	190
Plot 664. Frequency Stability, 802.11n 20 MHz, 5470 MHz – 5725 MHz @ -20°C, 120 V .....	190
Plot 665. Frequency Stability, 802.11n 20 MHz, 5470 MHz – 5725 MHz @ -10°C, 120 V .....	191
Plot 666. Frequency Stability, 802.11n 20 MHz, 5470 MHz – 5725 MHz @ 0°C, 120 V .....	191
Plot 667. Frequency Stability, 802.11n 20 MHz, 5470 MHz – 5725 MHz @ 10°C, 120 V .....	191
Plot 668. Frequency Stability, 802.11n 20 MHz, 5470 MHz – 5725 MHz @ 20°C, 108 V .....	192
Plot 669. Frequency Stability, 802.11n 20 MHz, 5470 MHz – 5725 MHz @ 20°C, 120 V .....	192
Plot 670. Frequency Stability, 802.11n 20 MHz, 5470 MHz – 5725 MHz @ 20°C, 132 V .....	192
Plot 671. Frequency Stability, 802.11n 20 MHz, 5470 MHz – 5725 MHz @ 30°C, 120 V .....	193
Plot 672. Frequency Stability, 802.11n 20 MHz, 5470 MHz – 5725 MHz @ 40°C, 120 V .....	193
Plot 673. Frequency Stability, 802.11n 20 MHz, 5470 MHz – 5725 MHz @ 50°C, 120 V .....	193
Plot 674. Frequency Stability, 802.11n 20 MHz, 5470 MHz – 5725 MHz @ 55°C, 120 V .....	194

Plot 686. Frequency Stability, 802.11n 40 MHz, 5250 MHz – 5350 MHz @ -20°C, 120 V .....	195
Plot 687. Frequency Stability, 802.11n 40 MHz, 5250 MHz – 5350 MHz @ -10°C, 120 V .....	195
Plot 688. Frequency Stability, 802.11n 40 MHz, 5250 MHz – 5350 MHz @ 0°C, 120 V .....	195
Plot 689. Frequency Stability, 802.11n 40 MHz, 5250 MHz – 5350 MHz @ 10°C, 120 V .....	196
Plot 690. Frequency Stability, 802.11n 40 MHz, 5250 MHz – 5350 MHz @ 20°C, 108 V .....	196
Plot 691. Frequency Stability, 802.11n 40 MHz, 5250 MHz – 5350 MHz @ 20°C, 120 V .....	196
Plot 692. Frequency Stability, 802.11n 40 MHz, 5250 MHz – 5350 MHz @ 20°C, 132 V .....	197
Plot 693. Frequency Stability, 802.11n 40 MHz, 5250 MHz – 5350 MHz @ 30°C, 120 V .....	197
Plot 694. Frequency Stability, 802.11n 40 MHz, 5250 MHz – 5350 MHz @ 40°C, 120 V .....	197
Plot 695. Frequency Stability, 802.11n 40 MHz, 5250 MHz – 5350 MHz @ 50°C, 120 V .....	198
Plot 696. Frequency Stability, 802.11n 40 MHz, 5250 MHz – 5350 MHz @ 55°C, 120 V .....	198
Plot 697. Frequency Stability, 802.11n 40 MHz, 5470 MHz – 5725 MHz @ -20°C, 120 V .....	198
Plot 698. Frequency Stability, 802.11n 40 MHz, 5470 MHz – 5725 MHz @ -10°C, 120 V .....	199
Plot 699. Frequency Stability, 802.11n 40 MHz, 5470 MHz – 5725 MHz @ 0°C, 120 V .....	199
Plot 700. Frequency Stability, 802.11n 40 MHz, 5470 MHz – 5725 MHz @ 10°C, 120 V .....	199
Plot 701. Frequency Stability, 802.11n 40 MHz, 5470 MHz – 5725 MHz @ 20°C, 108 V .....	200
Plot 702. Frequency Stability, 802.11n 40 MHz, 5470 MHz – 5725 MHz @ 20°C, 120 V .....	200
Plot 703. Frequency Stability, 802.11n 40 MHz, 5470 MHz – 5725 MHz @ 20°C, 132 V .....	200
Plot 704. Frequency Stability, 802.11n 40 MHz, 5470 MHz – 5725 MHz @ 30°C, 120 V .....	201
Plot 705. Frequency Stability, 802.11n 40 MHz, 5470 MHz – 5725 MHz @ 40°C, 120 V .....	201
Plot 706. Frequency Stability, 802.11n 40 MHz, 5470 MHz – 5725 MHz @ 50°C, 120 V .....	201
Plot 707. Frequency Stability, 802.11n 40 MHz, 5470 MHz – 5725 MHz @ 55°C, 120 V .....	202
Plot 708. Receiver Spurious Emission, 5.8 GHz, 30 MHz – 1 GHz, Port A .....	204
Plot 709. Receiver Spurious Emission, 5.8 GHz, 1 GHz – 18 GHz, Port A .....	204
Plot 710. Receiver Spurious Emission, 5.8 GHz, 30 MHz – 1 GHz, Port B .....	204
Plot 711. Receiver Spurious Emission, 5.8 GHz, 1 GHz – 18 GHz, Port B .....	205
Plot 712. Radar Calibration, Bin 1 .....	212
Plot 713. Radar Calibration, Bin 2 .....	212
Plot 714. Radar Calibration, Bin 3 .....	212
Plot 715. Radar Calibration, Bin 4 .....	213
Plot 716. Radar Calibration, Bin 5 .....	213
Plot 717. Radar Calibration, Bin 6 .....	213
Plot 718. Initial Channel Availability Check Time .....	220
Plot 719. Radar Burst at the Beginning of CACT .....	222
Plot 720. Radar Burst at the End of CACT .....	224
Plot 721. Channel Move Time.....	226
Plot 722. Channel Move Time, Bin 5.....	226
Plot 723. Channel Closing Transmission Time, 1 .....	227
Plot 724. Channel Closing Transmission Time, 2 .....	227
Plot 725. Channel Closing Transmission Time, 3 .....	227
Plot 726. Non-Occupancy Period.....	228

## List of Terms and Abbreviations

AC	Alternating Current
ACF	Antenna Correction Factor
Cal	Calibration
<i>d</i>	Measurement Distance
dB	Decibels
dB $\mu$ A	Decibels above one <b>microamp</b>
dB $\mu$ V	Decibels above one <b>microvolt</b>
dB $\mu$ A/m	Decibels above one <b>microamp per meter</b>
dB $\mu$ V/m	Decibels above one <b>microvolt per meter</b>
DC	Direct Current
E	Electric Field
DSL	Digital Subscriber Line
ESD	Electrostatic Discharge
EUT	Equipment Under Test
<i>f</i>	Frequency
FCC	Federal Communications Commission
GRP	Ground Reference Plane
H	Magnetic Field
HCP	Horizontal Coupling Plane
Hz	Hertz
IEC	International Electrotechnical Commission
kHz	kilohertz
kPa	kilopascal
kV	kilovolt
LISN	Line Impedance Stabilization Network
MHz	Megahertz
$\mu$ H	microhenry
$\mu$	microfarad
$\mu$ s	microseconds
PRF	Pulse Repetition Frequency
RF	Radio Frequency
RMS	Root-Mean-Square
TWT	Traveling Wave Tube
V/m	Volts per meter
VCP	Vertical Coupling Plane



# I. Executive Summary

## A. Purpose of Test

An EMC evaluation was performed to determine compliance of the Fortress Technologies ES2440, with the requirements of Part 15, §15.407. All references are to the most current version of Title 47 of the Code of Federal Regulations in effect. In accordance with §2.1033, the following data is presented in support of the Certification of the ES2440. Fortress Technologies should retain a copy of this document which should be kept on file for at least two years after the manufacturing of the ES2440, has been **permanently** discontinued.

## B. Executive Summary

The following tests were conducted on a sample of the equipment for the purpose of demonstrating compliance with Part 15, §15.407, in accordance with Fortress Technologies, purchase order number 0003235. All tests were conducted using measurement procedure ANSI C63.4-2003.

FCC Reference	Industry Canada Reference	Description	Results
15.107	ICES-003 Issue 4 February 2004	Conducted Emissions	Compliant
15.109		Radiated Emissions	Compliant
15.203	RSS-GEN 7.1.4	Antenna Requirements	Compliant
15.205/15.209	2.2	General Field Strength Limits (Restricted Bands and Radiated Emission Limits)	Compliant
15.207	RSS-GEN 7.2.2; RSS-210 2.2	AC Conducted Emissions 150KHz – 30MHz	Compliant
15.403 (c)	A8.2	26dB Occupied Bandwidth	Compliant
15.407 (a)(1), (2), (3)	A9.2(3)	Conducted Transmitter Output Power	Compliant
15.407 (a)(1), (2), (3), (5)	A9.2(3)	Power Spectral Density	Compliant
15.407 (a)(6)	A8.2	Peak Excursion	Compliant
15.407 (b)(1), (2), (5), (6)	A9.3(4)	Undesirable Emissions	Compliant
15.407(f)	RSS-GEN	RF Exposure	Compliant
15.407(g)	2.1	Frequency Stability	Compliant
15.407 (h)(1)	A9.4	Transmit Power Control (TPC) and Dynamic Frequency Selection (DFS)	Compliant
15.407 (h)(2)	A9.4	Channel Availability Check Time	Compliant
15.407 (h)(2)(ii)	A9.4	Channel Move Time and Channel Closing Time	Compliant
15.407 (h)(2)(iii)	A9.4	Non-Occupancy Period	Compliant
15.407 (h)(2)(iv)	A9.4	Radar Detection Function of Dynamic Frequency Selection (DFS)	Compliant

**Table 1. Executive Summary of EMC Part 15.407 Compliance Testing**

## II. Equipment Configuration

## A. Overview

MET Laboratories, Inc. was contracted by Fortress Technologies to perform testing on the ES2440, under Fortress Technologies's purchase order number 0003235.

This document describes the test setups, test methods, required test equipment, and the test limit criteria used to perform compliance testing of the Fortress Technologies ES2440.

The results obtained relate only to the item(s) tested.

<b>Model(s) Tested:</b>	ES2440		
<b>Model(s) Covered:</b>	ES2440		
<b>EUT Specifications:</b>	Primary Power: 120 VAC, 60Hz		
	FCC ID: WYK-ES2440 IC: 8190A-ES2440		
	Type of Modulations:	OFDM	
	Equipment Code:	NII	
	Peak RF Output Power:	<b>MHz</b>	<b>Power</b>
		5300 MHz	19.91 dBm
EUT Frequency Ranges:	5150 – 5350 MHz 5470 – 5725 MHz		
<b>Analysis:</b>	The results obtained relate only to the item(s) tested.		
<b>Environmental Test Conditions:</b>	Temperature: 15-35° C		
	Relative Humidity: 30-60%		
	Barometric Pressure: 860-1060 mbar		
<b>Evaluated by:</b>	Jeff Pratt		
<b>Report Date(s):</b>	March 20, 2012		

**Table 2. EUT Summary**

## B. References

<b>CFR 47, Part 15, Subpart B</b>	Electromagnetic Compatibility: Criteria for Radio Frequency Devices
<b>CFR 47, Part 15, Subpart E</b>	Unlicensed National Information Infrastructure Devices (UNII)
<b>RSS-210, Issue 8, December 2010</b>	Low-power License-exempt Radiocommunications Devices (All Frequency Bands): Category I Equipment
<b>ICES-003, Issue 4 February 2004</b>	Electromagnetic Compatibility: Criteria for Radio Frequency Devices
<b>ANSI C63.4:2003</b>	Methods and Measurements of Radio-Noise Emissions from Low-Voltage Electrical And Electronic Equipment in the Range of 9 kHz to 40 GHz
<b>ANSI/NCSL Z540-1-1994</b>	Calibration Laboratories and Measuring and Test Equipment - General Requirements
<b>ANSI/ISO/IEC 17025:2000</b>	General Requirements for the Competence of Testing and Calibration Laboratories

**Table 3. References**

## C. Test Site

All testing was performed at MET Laboratories, Inc., 914 W. Patapsco Ave., Baltimore, MD 21230. All equipment used in making physical determinations is accurate and bears recent traceability to the National Institute of Standards and Technology.

Radiated Emissions measurements were performed in a 3 meter semi-anechoic chamber (equivalent to an Open Area Test Site). In accordance with §2.948(a)(3), a complete site description is contained at MET Laboratories.

#### **D. Description of Test Sample**

four COTS high power radios and three Ethernet ports in a ruggedized enclosure. The radios operate in accordance to the 802.11a, 802.11b, 802.11g, and 802.11n standards.

The ES2440 is intended to provide outdoor mobile connectivity in a secure manner both wired and wirelessly.



**Photograph 1. Fortress Technologies ES2440**

## E. Equipment Configuration

Ref. ID	Name / Description	Model Number	Serial Number
1	Fortress High Capacity Infrastructure Mesh Point	ES2440	11022261

**Table 4. Equipment Configuration**

## F. Support Equipment

Fortress Technologies supplied support equipment necessary for the operation and testing of the ES2440. All support equipment supplied is listed in the following Support Equipment List.

Ref. ID	Name / Description	Manufacturer	Model Number
1	PoE Adapter	Phihong	POE61U-560DG
2	2.4GHz Omni Antenna	Ubiquiti	AMO-2G10
3	2.4GHz Sector Antenna	PCTel	SP2327 15XP90
4	2.4GHz Dish Antenna	Ubiquiti	RD-2G-24
5	5.8GHz Omni Antenna	Ubiquiti	AMO-5G10
6	5.8GHz Sector Antenna	PCTel	SP4959 16XP90
7	5.8GHz Dish Antenna	Ubiquiti	RD-5G-30

**Table 5. Support Equipment**

## G. Ports and Cabling Information

Ref. ID	Port Name on EUT	Cable Description	Qty.	Length (m)	Shielded (Y/N)	Termination Point
1	ANT1A, ANT1B, ANT2A, ANT2B, ANT3A, ANT3B, ANT4A, ANT4B	Antenna	8	-	Y	-
2	DC Power	Provides power	1	-	N	-
3	Ethernet1/WAN/POE Ethernet 2 Ethernet 3	Standard RJ45 CAT5 Ethernet Cable	3	-	N	-
4	Serial	Standard RJ45 serial cable	1	-	N	-
	GPS	GPS antenna	1	-	N	-

**Table 6. Ports and Cabling Information**

## **H. Mode of Operation**

The ES2440 can operate in 802.11a, 802.11b, 802.11g, and 802.11n modes. These modes may be configured using the UI of the product. Additionally, these modes may be entered by using ART, the Atheros Radio Test tool. This is a standard tool provide by Atheros for directly manipulating and configuring their chips during testing and manufacturing.

## **I. Modifications**

### **a) Modifications to EUT**

No modifications were made to the EUT.

### **b) Modifications to Test Standard**

No modifications were made to the test standard.

## **J. Disposition of EUT**

The test sample including all support equipment submitted to the Electro-Magnetic Compatibility Lab for testing was returned to Fortress Technologies upon completion of testing.



## **III. Electromagnetic Compatibility Criteria for Unintentional Radiators**

## Electromagnetic Compatibility Criteria

### § 15.107 Conducted Emissions Limits

**Test Requirement(s):** **15.107 (a)** Except for Class A digital devices, for equipment that is designed to be connected to the public utility (AC) power line, the radio frequency voltage that is conducted back onto the AC power line on any frequency or frequencies within the band 150 kHz to 30 MHz shall not exceed the limits in Table 7. Compliance with this provision shall be based on the measurement of the radio frequency voltage between each power line and ground at the power terminals.

**15.107 (b)** For a Class A digital device that is designed to be connected to the public utility (AC) power line, the radio frequency voltage that is conducted back onto the AC power line on any frequency or frequencies within the band 150 kHz to 30 MHz shall not exceed the limits in Table 7. Compliance with this provision shall be based on the measurement of the radio frequency voltage between each power line and ground at the power terminals. The lower limit applies at the band edges.

Frequency range (MHz)	Class A Conducted Limits (dB $\mu$ V)		*Class B Conducted Limits (dB $\mu$ V)	
	Quasi-Peak	Average	Quasi-Peak	Average
* 0.15- 0.45	79	66	66 - 56	56 - 46
0.45 - 0.5	79	66	56	46
0.5 - 30	73	60	60	50
Note 1 — The lower limit shall apply at the transition frequencies.				
Note 2 — The limit decreases linearly with the logarithm if the frequency in the range 0.15 MHz to 0.5 MHz.				
* -- Limits per Subsection 15.207(a).				

**Table 7. Conducted Limits for Radio Frequency Devices calculated from FCC Part 15 Subsections 15.107(a) (b) and 15.207(a)**

**Test Results:** The EUT was compliant with the Class A requirement(s) of this section. Measured emissions were below applicable limits.

**Test Engineer(s):** Jeff Pratt

**Test Date(s):** 10/26/11

### Conducted Emissions - Voltage, AC Power

Frequency (MHz)	Uncorrected Meter Reading (dBuV) QP	Cable Loss (dB)	Corrected Measurement (dBuV) QP	Limit (dBuV) QP	Margin (dB) QP	Uncorrected Meter Reading (dBuV) Avg.	Cable Loss (dB)	Corrected Measurement (dBuV) AVG	Limit (dBuV) AVG	Margin (dB) AVG
0.158	50.21	0	50.21	79	-28.79	42.13	0	42.13	66	-23.87
0.238	43.17	0.01	43.18	79	-35.82	37.86	0.01	37.87	66	-28.13
0.476	42.62	0	42.62	79	-36.38	37.98	0	37.98	66	-28.02
0.715	38.38	0	38.38	73	-34.62	33.1	0	33.1	60	-26.9
0.318	39.87	0	39.87	79	-39.13	34.91	0	34.91	66	-31.09
0.635	37.81	0	37.81	73	-35.19	33.36	0	33.36	60	-26.64

Table 8. Conducted Emissions - Voltage, AC Power, Phase Line, Test Results

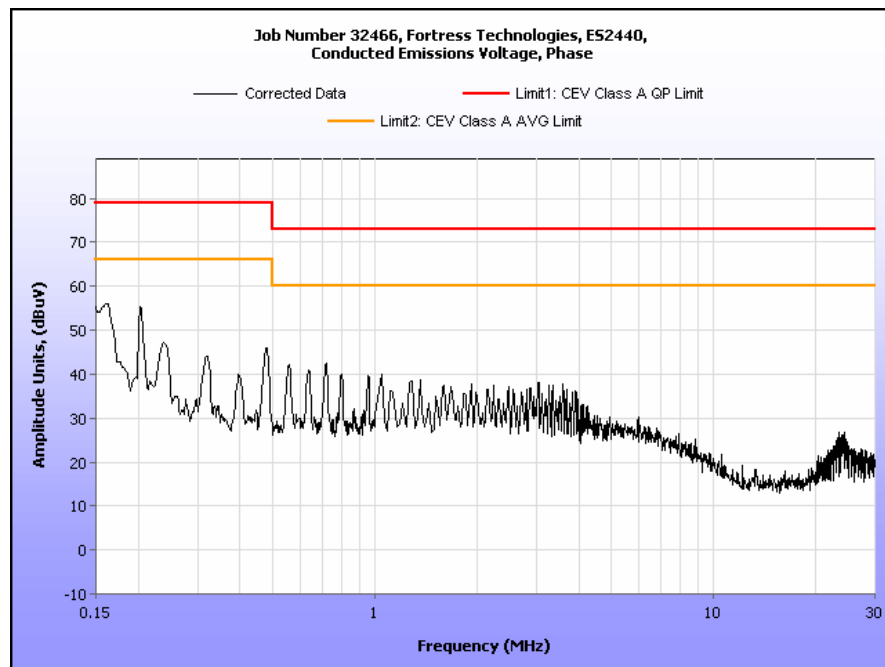

Plot 1. Conducted Emission, Phase Line Plot

### Conducted Emissions - Voltage, AC Power

Frequency (MHz)	Uncorrected Meter Reading (dBuV) QP	Cable Loss (dB)	Corrected Measurement (dBuV) QP	Limit (dBuV) QP	Margin (dB) QP	Uncorrected Meter Reading (dBuV) Avg.	Cable Loss (dB)	Corrected Measurement (dBuV) AVG	Limit (dBuV) AVG	Margin (dB) AVG
0.238	41.73	0.01	41.74	79	-37.26	38.52	0.01	38.53	66	-27.47
0.477	42.14	0	42.14	79	-36.86	41.22	0	41.22	66	-24.78
0.158	50.36	0	50.36	79	-28.64	43.74	0	43.74	66	-22.26
0.557	38.85	0	38.85	73	-34.15	37.66	0	37.66	60	-22.34
0.634	38.48	0	38.48	73	-34.52	37.08	0	37.08	60	-22.92
0.318	39.36	0	39.36	79	-39.64	37.3	0	37.3	66	-28.7

Table 9. Conducted Emissions - Voltage, AC Power, Neutral Line, Test Results

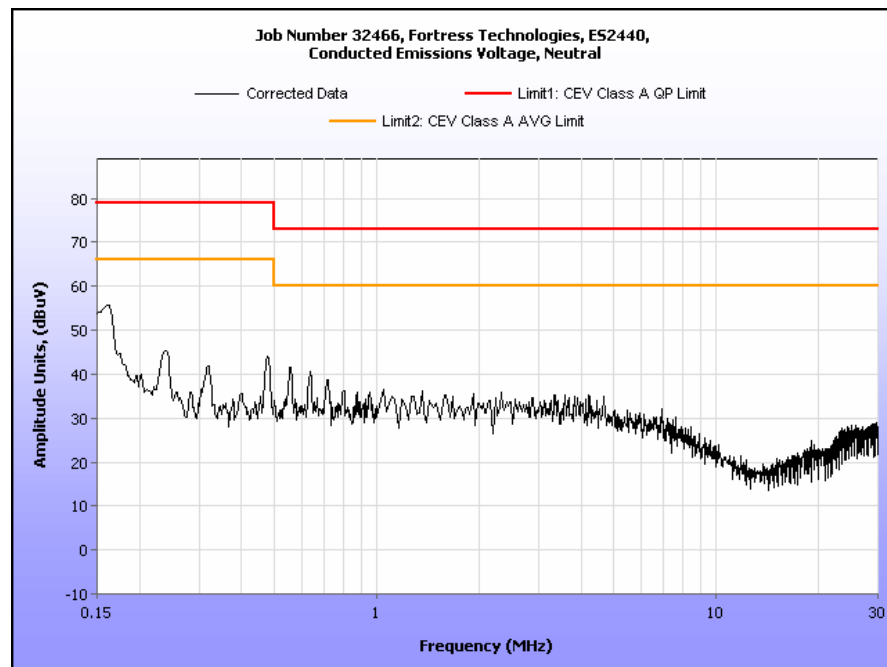

Plot 2. Conducted Emission, Neutral Line Plot

## Conducted Emission Limits Test Setup



**Photograph 2. Conducted Emissions, Test Setup**

## Radiated Emission Limits

### § 15.109 Radiated Emissions Limits

**Test Requirement(s):** **15.109 (a)** Except for Class A digital devices, the field strength of radiated emissions from unintentional radiators at a distance of 3 meters shall not exceed the Class B limits expressed in Table 10.

**15.109 (b)** The field strength of radiated emissions from a Class A digital device, as determined at a distance of 10 meters, shall not exceed the Class A limits expressed in Table 10.

Frequency (MHz)	Field Strength (dB $\mu$ V/m)	
	§15.109 (b), Class A Limit (dB $\mu$ V) @ 10m	§15.109 (a), Class B Limit (dB $\mu$ V) @ 3m
30 - 88	39.00	40.00
88 - 216	43.50	43.50
216 - 960	46.40	46.00
Above 960	49.50	54.00

**Table 10. Radiated Emissions Limits calculated from FCC Part 15, §15.109 (a) (b)**

**Test Procedures:** The EUT was placed on a non-metallic table, 80 cm above the ground plane inside a semi-anechoic chamber. The method of testing and test conditions of ANSI C63.4 were used. An antenna was located 3 m from the EUT on an adjustable mast. A pre-scan was first performed in order to find prominent radiated emissions. For final emissions measurements at each frequency of interest, the EUT was rotated and the antenna height was varied between 1 m and 4 m in order to maximize the emission. Measurements in both horizontal and vertical polarities were made and the data was recorded. Unless otherwise specified, measurements were made using a quasi-peak detector with a 120 kHz bandwidth.

**Test Results:** The EUT was compliant with the Class A requirement(s) of this section. Measured emissions were below applicable limits.

**Test Engineer(s):** Ben Taylor

**Test Date(s):** 08/17/11

### Radiated Emissions Limits Test Results, Class A

Frequency (MHz)	EUT Azimuth (Degrees)	Antenna Polarity (H/V)	Antenna HEIGHT (m)	Uncorrected Amplitude (dBuV)	Antenna Correction Factor (dB) (+)	Cable Loss (dB) (+)	Distance Correction Factor (dB) (-)	Corrected Amplitude (dBuV/m)	Limit (dBuV/m)	Margin (dB)
55.791583	109	H	3.17	18.18	7.44	0.23	10.46	15.39	39.00	-23.61
55.791583	11	V	1.02	36.23	7.44	0.23	10.46	33.44	39.00	-5.56
200.04008	158	H	1.39	14.54	12.99	0.23	10.46	17.30	43.50	-26.20
200.04008	207	V	1.06	25.18	12.99	0.23	10.46	27.94	43.50	-15.56
600.05078	81	H	1.17	26.84	19.50	1.17	10.46	37.05	46.40	-9.35
600.05078	89	V	1.05	26.07	19.50	1.17	10.46	36.28	46.40	-10.12
639.40882	349	H	1.45	17.26	19.99	1.17	10.46	27.96	46.40	-18.44
639.40882	253	V	1.05	18.79	19.99	1.17	10.46	29.49	46.40	-16.91
733.38482	59	H	1.34	27.58	20.90	1.50	10.46	39.52	46.40	-6.88
733.38482	89	V	1.02	24.75	20.90	1.50	10.46	36.69	46.40	-9.71
957.56513	202	H	1.01	17.42	23.10	1.72	10.46	31.78	46.40	-14.62
957.56513	350	V	1.05	13.38	23.10	1.72	10.46	27.74	46.40	-18.66

Table 11. Radiated Emissions, Test Results, FCC Limits, 30 MHz – 1 GHz

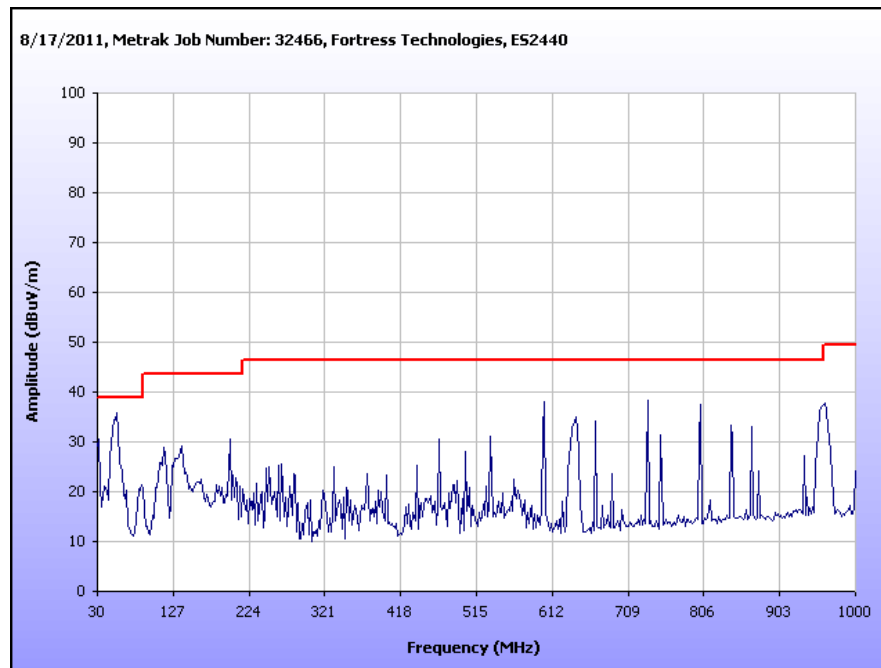

Plot 3. Radiated Emissions, Pre-Scan, FCC Limits, 30 MHz – 1 GHz

Frequency (MHz)	EUT Azimuth (Degrees)	Antenna Polarity (H/V)	Antenna HEIGHT (m)	Uncorrected Amplitude (dBuV)	Antenna Correction Factor (dB) (+)	Cable Loss (dB) (+)	Distance Correction Factor (dB) (-)	Corrected Amplitude (dBuV/m)	Limit (dBuV/m)	Margin (dB)
55.791583	109	H	3.17	18.18	7.44	0.23	10.46	15.39	40.00	-24.61
55.791583	11	V	1.02	36.23	7.44	0.23	10.46	33.44	40.00	-6.56
200.04008	158	H	1.39	14.54	12.99	0.23	10.46	17.30	40.00	-22.70
200.04008	207	V	1.06	25.18	12.99	0.23	10.46	27.94	40.00	-12.06
600.05078	81	H	1.17	26.84	19.50	1.17	10.46	37.05	47.00	-9.95
600.05078	89	V	1.05	26.07	19.50	1.17	10.46	36.28	47.00	-10.72
639.40882	349	H	1.45	17.26	19.99	1.17	10.46	27.96	47.00	-19.04
639.40882	253	V	1.05	18.79	19.99	1.17	10.46	29.49	47.00	-17.51
733.38482	59	H	1.34	27.58	20.90	1.50	10.46	39.52	47.00	-7.48
733.38482	89	V	1.02	24.75	20.90	1.50	10.46	36.69	47.00	-10.31
957.56513	202	H	1.01	17.42	23.10	1.72	10.46	31.78	47.00	-15.22
957.56513	350	V	1.05	13.38	23.10	1.72	10.46	27.74	47.00	-19.26

**Table 12. Radiated Emissions, Test Results, ICES-003 Limits, 30 MHz – 1 GHz**



## Radiated Emission Limits Test Setup



**Photograph 3. Radiated Emission, Test Setup**

## **IV. Electromagnetic Compatibility Criteria for Intentional Radiators**

## Electromagnetic Compatibility Criteria for Intentional Radiators

### § 15.203 Antenna Requirement

**Test Requirement:** § 15.203: An intentional radiator shall be designed to ensure that no antenna other than that furnished by the responsible party shall be used with the device. The use of a permanently attached antenna or of an antenna that uses a unique coupling to the intentional radiator shall be considered sufficient to comply with the provisions of this section. The manufacturer may design the unit so that a broken antenna can be replaced by the user, but the use of a standard antenna jack or electrical connector is prohibited.

The structure and application of the EUT were analyzed to determine compliance with Section 15.203 of the Rules. Section 15.203 states that the subject device must meet at least one of the following criteria:

- a.) Antenna must be permanently attached to the unit.
- b.) Antenna must use a unique type of connector to attach to the EUT.
- c.) Unit must be professionally installed. Installer shall be responsible for verifying that the correct antenna is employed with the unit.

**Results:** The EUT as tested is compliant the criteria of §15.203. The unit will be professionally installed.

**Test Engineer(s):** Jeff Pratt

**Test Date(s):** 10/18/11

Type	Gain	Manufacturer	Model
Omni	10 dBi	Ubiquiti Networks	AMO-5G10
Sector	15.5 dBi	PCTEL, Inc.	SP4959-16XP90

## Electromagnetic Compatibility Criteria for Intentional Radiators

### § 15.207 Conducted Emissions Limits

**Test Requirement(s):** § 15.207 (a): For an intentional radiator that is designed to be connected to the public utility (AC) power line, the radio frequency voltage that is conducted back onto the AC power line on any frequency or frequencies, within the band 150 kHz to 30MHz, shall not exceed the limits in the following table, as measured using a 50  $\mu$ H/50  $\Omega$  line impedance stabilization network (LISN). Compliance with the provisions of this paragraph shall be based on the measurement of the radio frequency voltage between each power line and ground at the power terminal. The lower limit applies at the boundary between the frequency ranges.

Frequency range (MHz)	§ 15.207(a), Conducted Limit (dB $\mu$ V)	
	Quasi-Peak	Average
* 0.15- 0.45	66 - 56	56 - 46
0.45 - 0.5	56	46
0.5 - 30	60	50

**Table 13. Conducted Limits for Intentional Radiators from FCC Part 15 § 15.207(a)**

**Test Procedure:** The EUT was placed on a 0.8 m-high wooden table inside a semi-anechoic chamber. The EUT was situated such that the back of the EUT was 0.4 m from one wall of the vertical ground plane, and the remaining sides of the EUT were no closer than 0.8 m from any other conductive surface. The EUT was powered from a 50  $\Omega$ /50  $\mu$ H Line Impedance Stabilization Network (LISN). The EMC receiver scanned the frequency range from 150 kHz to 30 MHz. Conducted Emissions measurements were made in accordance with *ANSI C63.4-1992 "Methods and Measurements of Radio-Noise Emissions from Low-Voltage Electrical and Electronic Equipment in the Range of 9kHz to 40 GHz"*. The measurements were performed over the frequency range of 0.15 MHz to 30 MHz using a 50  $\Omega$ /50  $\mu$ H LISN as the input transducer to an EMC/field intensity meter.

**Test Results:** The EUT was found to comply with the requirement(s) of this section. Measured emissions were below applicable limits.

**Test Engineer(s):** Ben Taylor

**Test Date(s):** 10/26/11

### Conducted Emissions - Voltage, AC Power

Frequency (MHz)	Uncorrected Meter Reading (dBuV) QP	Cable Loss (dB)	Corrected Measurement (dBuV) QP	Limit (dBuV) QP	Margin (dB) QP	Uncorrected Meter Reading (dBuV) Avg.	Cable Loss (dB)	Corrected Measurement (dBuV) AVG	Limit (dBuV) AVG	Margin (dB) AVG
0.1569	53.36	0	53.36	65.63	-12.27	43.66	0	43.66	55.63	-11.97
0.3995	43.6	0	43.6	57.86	-14.26	38.08	0	38.08	47.86	-9.78
0.5584	41	0	41	56	-15	35.6	0	35.6	46	-10.4
0.7148	39.1	0	39.1	56	-16.9	33.57	0	33.57	46	-12.43
3.66	42.31	0.03	42.34	56	-13.66	37.52	0.03	37.55	46	-8.45
4.475	42.82	0.08	42.9	56	-13.1	39.42	0.08	39.5	46	-6.5

Table 14. Conducted Emissions - Voltage, AC Power, Phase Line, Test Results

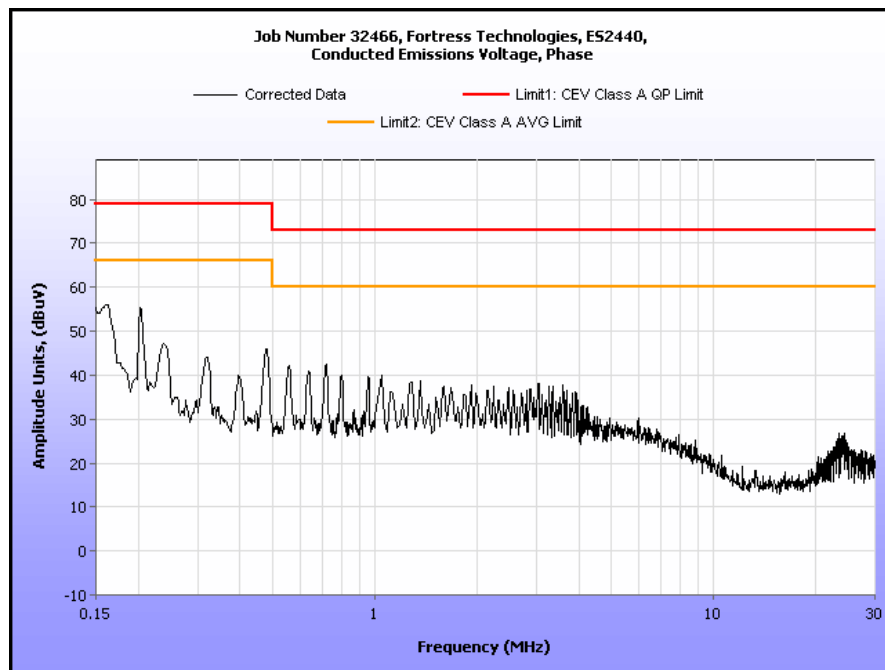

Plot 4. §15.207 Conducted Emissions, Phase Line Plot

Frequency (MHz)	Uncorrected Meter Reading (dBuV) QP	Cable Loss (dB)	Corrected Measurement (dBuV) QP	Limit (dBuV) QP	Margin (dB) QP	Uncorrected Meter Reading (dBuV) Avg.	Cable Loss (dB)	Corrected Measurement (dBuV) AVG	Limit (dBuV) AVG	Margin (dB) AVG
0.1584	53.42	0	53.42	65.55	-12.13	44.62	0	44.62	55.55	-10.93
0.2385	44.18	0.01	44.19	62.15	-17.96	38.39	0.01	38.4	52.15	-13.75
0.398	42.8	0	42.8	57.9	-15.1	41	0	41	47.9	-6.9
0.5568	39.35	0	39.35	56	-16.65	39.44	0	39.44	46	-6.56
3.66	43.13	0.03	43.16	56	-12.84	42.03	0.03	42.06	46	-3.94
4.881	42.25	0.1	42.35	56	-13.65	41.96	0.1	42.06	46	-3.94

**Table 15. Conducted Emissions - Voltage, AC Power, Neutral Line, Test Results**

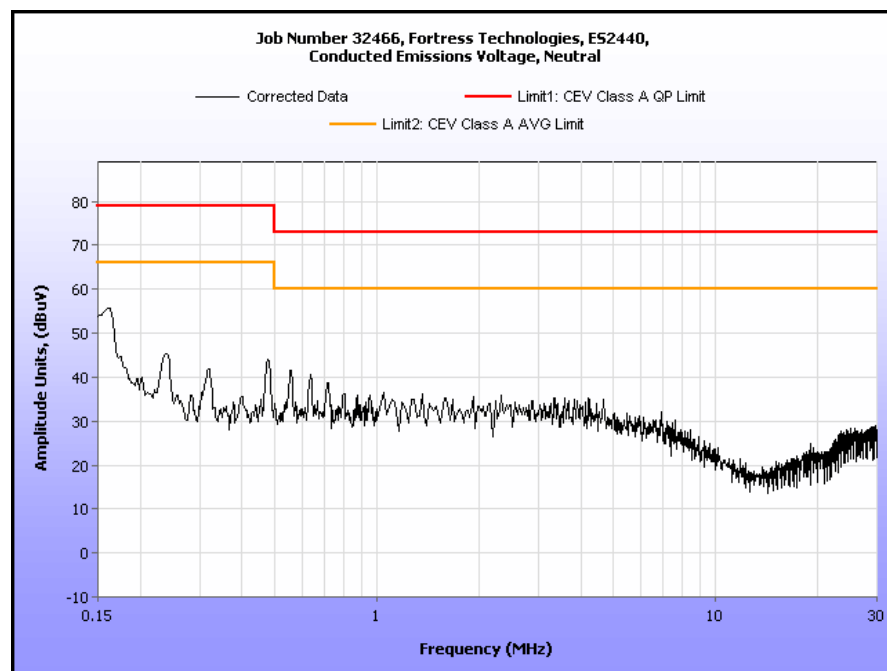

**Plot 5. §15.207 Conducted Emissions, Neutral Line Plot**



**Photograph 4. §15.207 Conducted Emissions, Test Setup**

## Electromagnetic Compatibility Criteria for Intentional Radiators

### § 15.403(c) 26dB Bandwidth

<b>Test Requirements:</b>	§ 15.403 (c): Operation under the provisions of this section is limited to frequency hopping and digitally modulated intentional radiators that comply with the following provisions:
<b>Test Procedure:</b>	The transmitter was set to the mid channel at the highest output power and connected to the spectrum analyzer through an attenuator. The bandwidth of the fundamental frequency was measured with the spectrum analyzer using a RBW approximately equal to 1% of the total emission bandwidth, VBW > RBW. The 26 dB Bandwidth was measured and recorded. The measurements were repeated at the low and high channels.
<b>Test Results</b>	Equipment complies with § 15.407 (c). The 26 dB Bandwidth was determined from the plots on the following pages.
<b>Test Engineer(s):</b>	Jeff Pratt
<b>Test Date(s):</b>	09/14/11

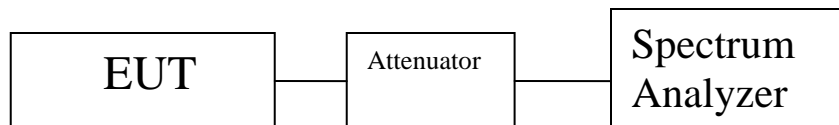

**Figure 1. Occupied Bandwidth Test Setup**



Occupied Bandwidth			
Mode	Frequency (MHz)	Measured 26 dB Bandwidth (MHz)	99 % Bandwidth (MHz)
802.11a	5260	21.632	16.5091
	5300	20.552	16.6387
	5320	21.219	16.5916
	5500	21.274	16.5821
	5580	21.106	16.5516
	5700	20.373	16.5334

Table 16. Occupied Bandwidth, Test Results, 802.11a

Occupied Bandwidth			
Mode	Frequency (MHz)	Measured 26 dB Bandwidth (MHz)	99 % Bandwidth (MHz)
802.11n 20MHz Port A	5260	22.498	17.7768
	5300	21.197	17.9270
	5320	21.817	17.7319
	5500	20.961	17.7182
	5580	21.084	17.7441
	5700	20.853	17.7943
802.11n 20MHz Port B	5260	21.470	17.8149
	5300	21.903	17.6458
	5320	20.854	17.7435
	5500	22.052	17.7711
	5580	21.950	17.7685
	5700	21.922	17.7365

Table 17. Occupied Bandwidth, Test Results, 802.11n 20 MHz

Occupied Bandwidth			
Mode	Frequency (MHz)	Measured 26 dB Bandwidth (MHz)	99 % Bandwidth (MHz)
802.11n 40MHz Port A	5270	43.681	36.1454
	5300	42.182	36.1687
	5310	41.528	36.2170
	5510	42.221	36.2411
	5580	41.687	36.2251
	5690	41.634	36.2444
802.11n 40MHz Port B	5270	43.149	36.0822
	5300	42.892	36.0426
	5310	43.545	36.1029
	5510	40.956	36.3308
	5580	44.542	36.2600
	5690	41.620	36.2095

Table 18. Occupied Bandwidth, Test Results, 802.11n 40 MHz

## Occupied Bandwidth, 802.11a

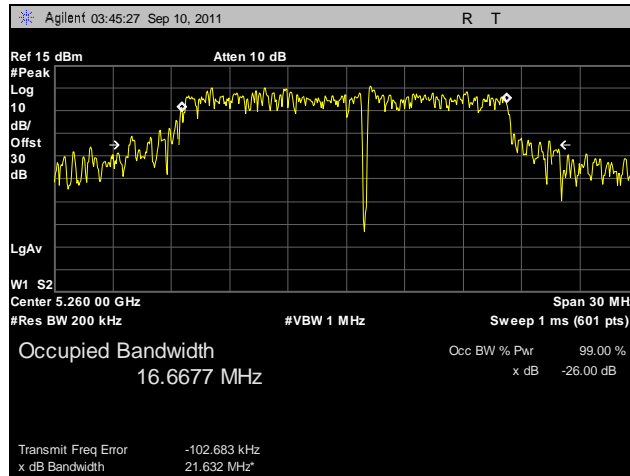

**Plot 6. Occupied Bandwidth, 802.11a, 5260 MHz**

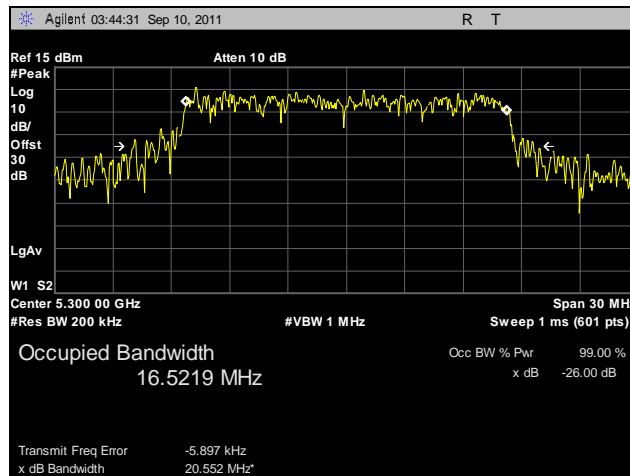

**Plot 7. Occupied Bandwidth, 802.11a, 5300 MHz**

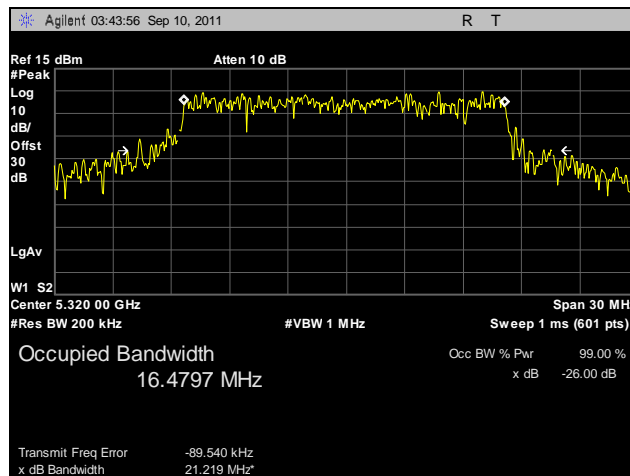

**Plot 8. Occupied Bandwidth, 802.11a, 5320 MHz**

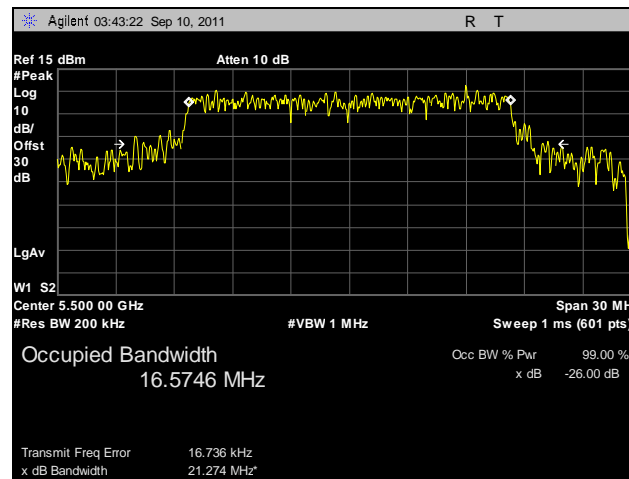

**Plot 9. Occupied Bandwidth, 802.11a, 5500 MHz**

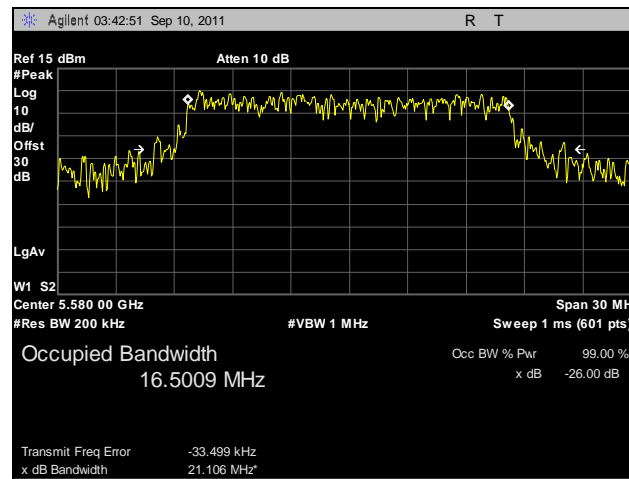

**Plot 10. Occupied Bandwidth, 802.11a, 5580 MHz**

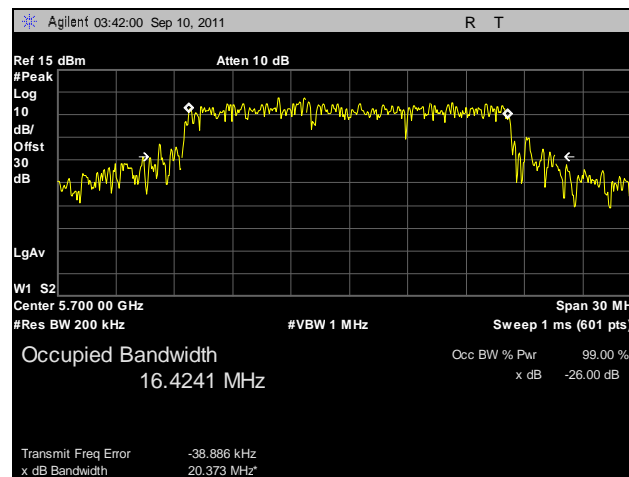

**Plot 11. Occupied Bandwidth, 802.11a, 5700 MHz**

## Occupied Bandwidth, 802.11n 20 MHz, Port A

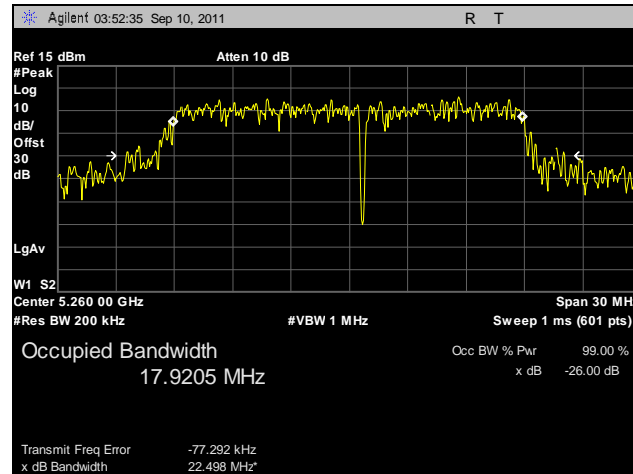

Plot 12. Occupied Bandwidth, 802.11n 20 MHz, Port A, 5260 MHz

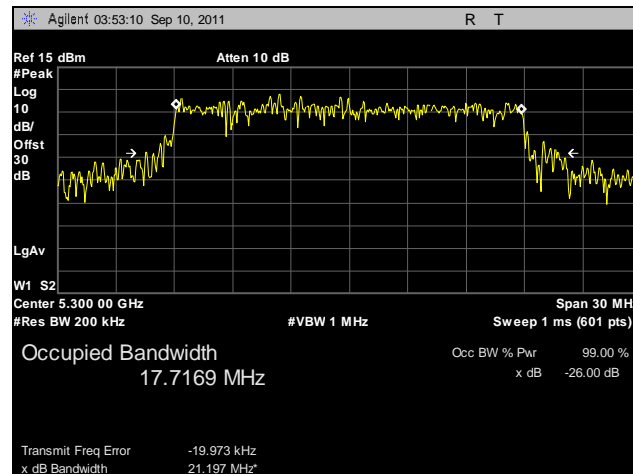

Plot 13. Occupied Bandwidth, 802.11n 20 MHz, Port A, 5300 MHz

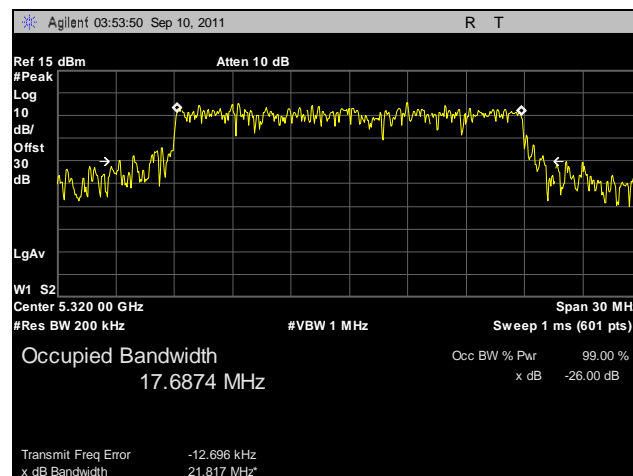

Plot 14. Occupied Bandwidth, 802.11n 20 MHz, Port A, 5320 MHz

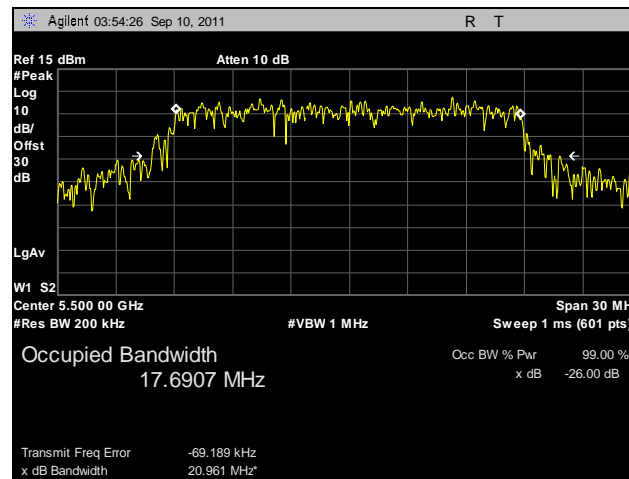

Plot 15. Occupied Bandwidth, 802.11n 20 MHz, Port A, 5500 MHz

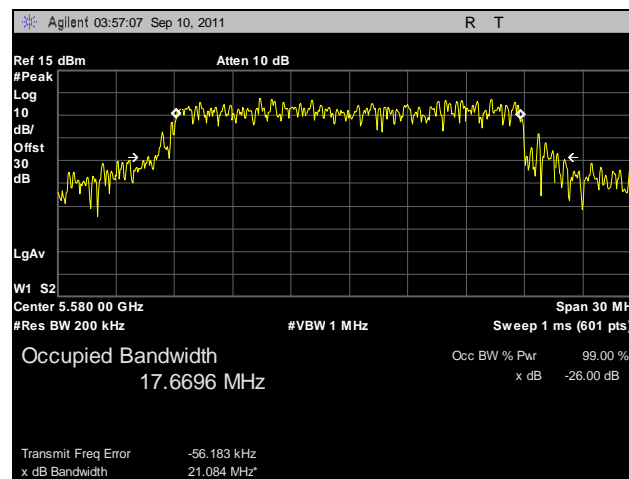

Plot 16. Occupied Bandwidth, 802.11n 20 MHz, Port A, 5580 MHz

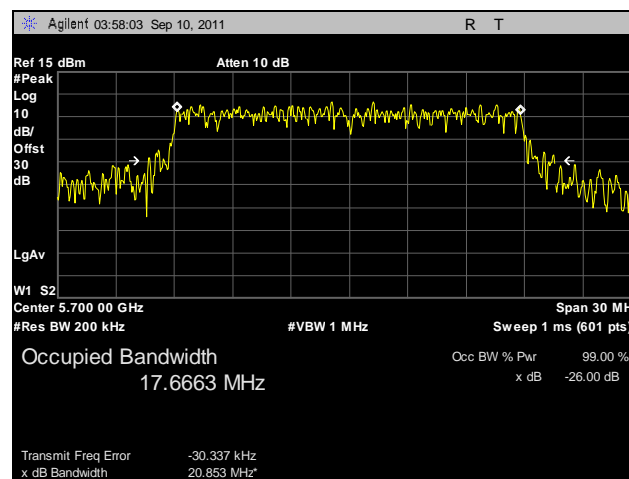

Plot 17. Occupied Bandwidth, 802.11n 20 MHz, Port A, 5700 MHz

## Occupied Bandwidth, 802.11n 20 MHz, Port B

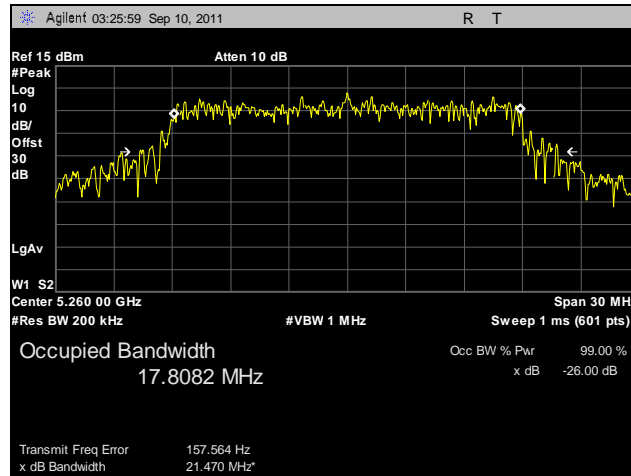

Plot 18. Occupied Bandwidth, 802.11n 20 MHz, Port B, 5260 MHz

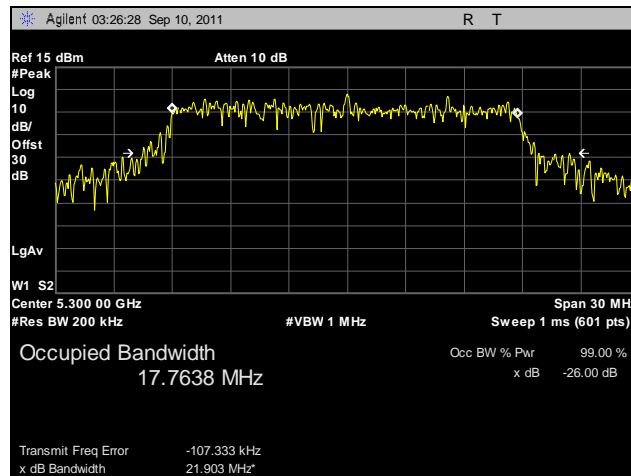

Plot 19. Occupied Bandwidth, 802.11n 20 MHz, Port B, 5300 MHz

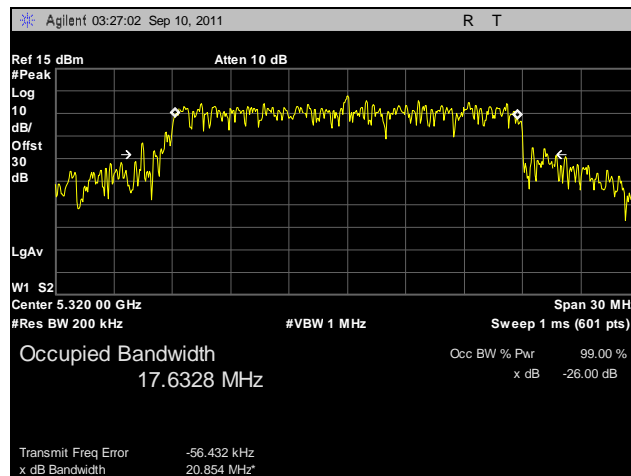

Plot 20. Occupied Bandwidth, 802.11n 20 MHz, Port B, 5320 MHz

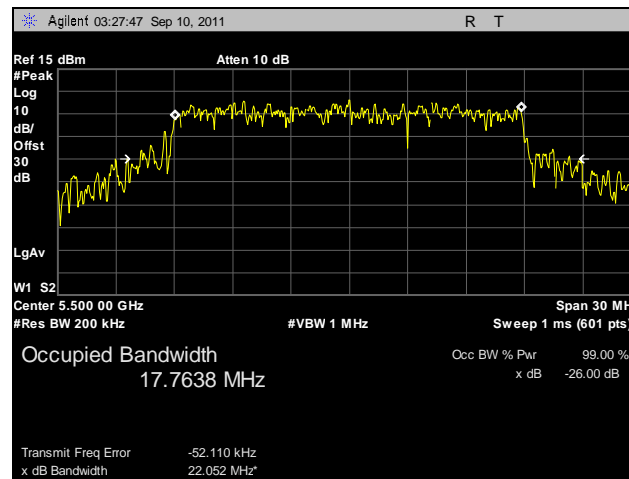

Plot 21. Occupied Bandwidth, 802.11n 20 MHz, Port B, 5500 MHz

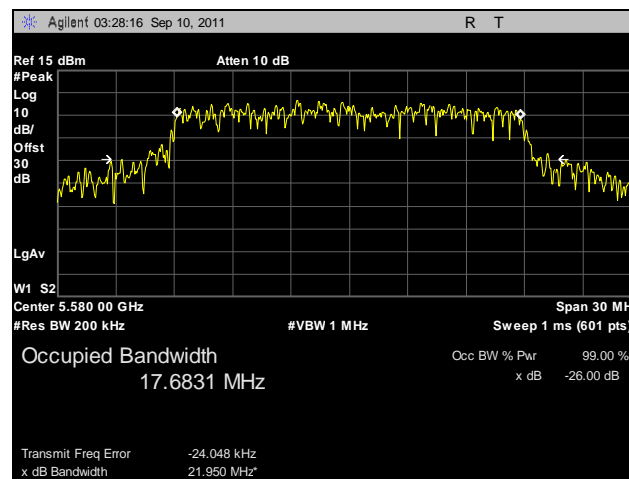

Plot 22. Occupied Bandwidth, 802.11n 20 MHz, Port B, 5580 MHz

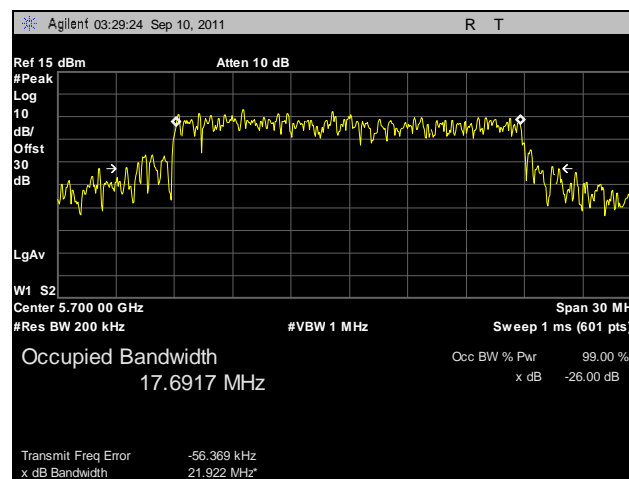

Plot 23. Occupied Bandwidth, 802.11n 20 MHz, Port B, 5700 MHz

## Occupied Bandwidth, 802.11n 40 MHz, Port A

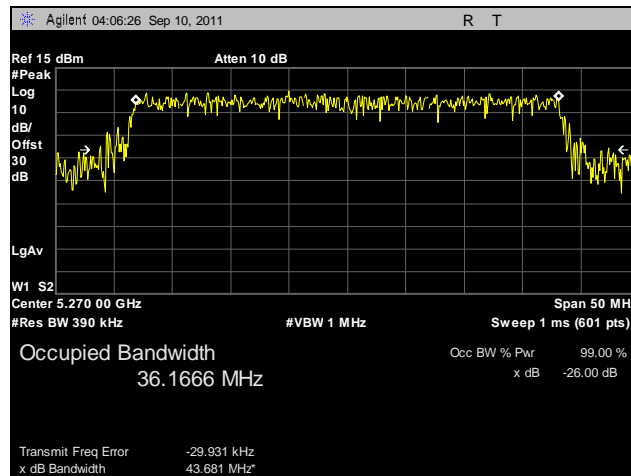

Plot 24. Occupied Bandwidth, 802.11n 40 MHz, Port A, 5270 MHz

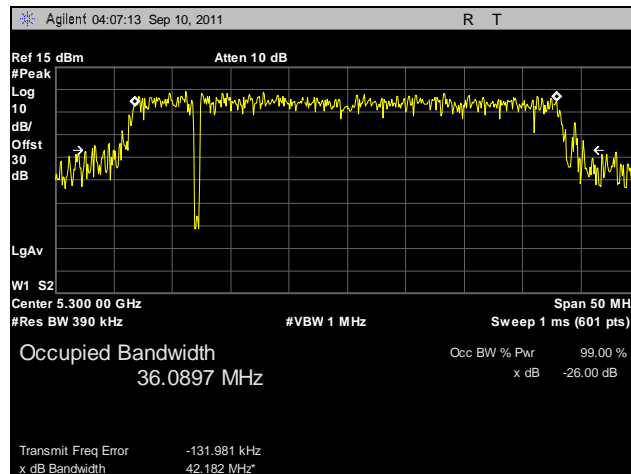

Plot 25. Occupied Bandwidth, 802.11n 40 MHz, Port A, 5300 MHz

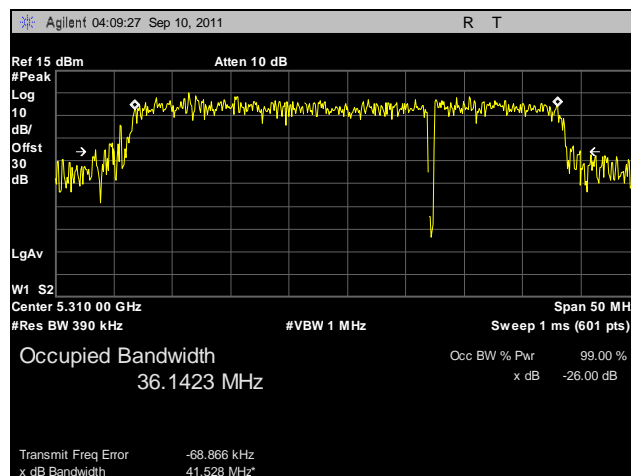

Plot 26. Occupied Bandwidth, 802.11n 40 MHz, Port A, 5310 MHz



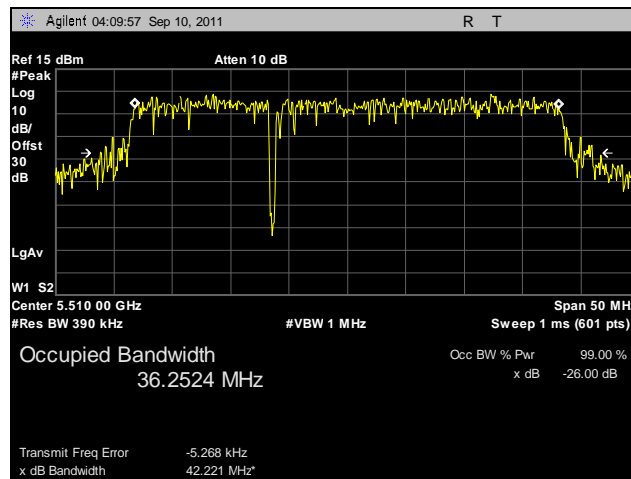

Plot 27. Occupied Bandwidth, 802.11n 40 MHz, Port A, 5510 MHz

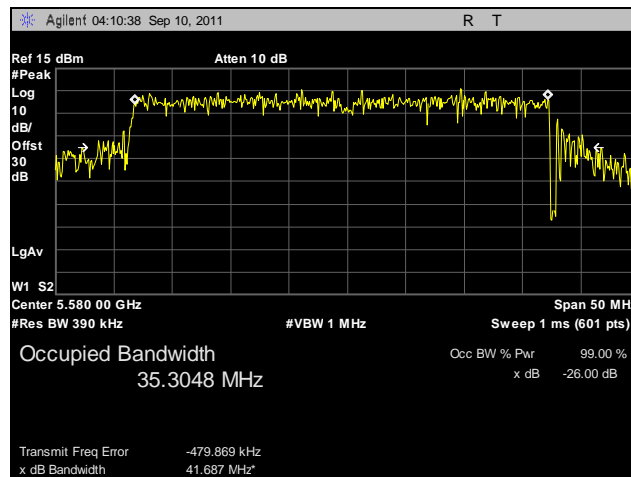

Plot 28. Occupied Bandwidth, 802.11n 40 MHz, Port A, 5580 MHz

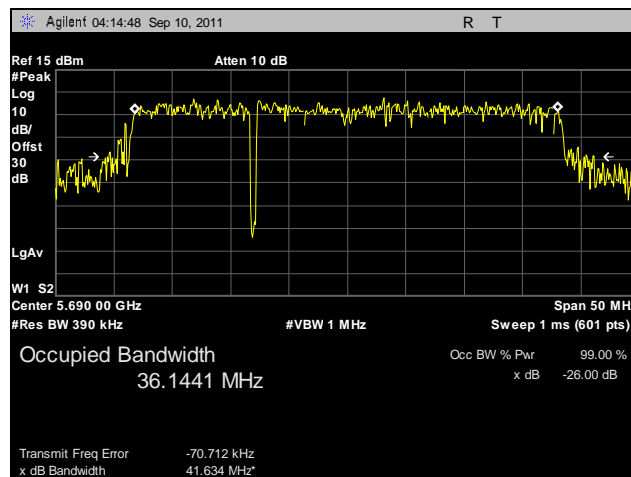

Plot 29. Occupied Bandwidth, 802.11n 40 MHz, Port A, 5690 MHz

## Occupied Bandwidth, 802.11n 40 MHz, Port B

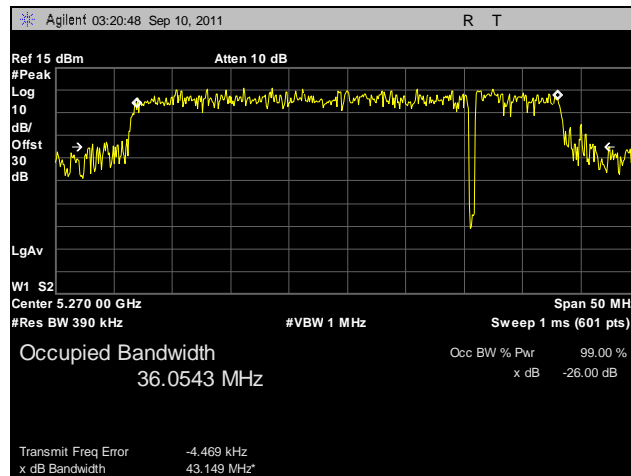

Plot 30. Occupied Bandwidth, 802.11n 40 MHz, Port B, 5270 MHz

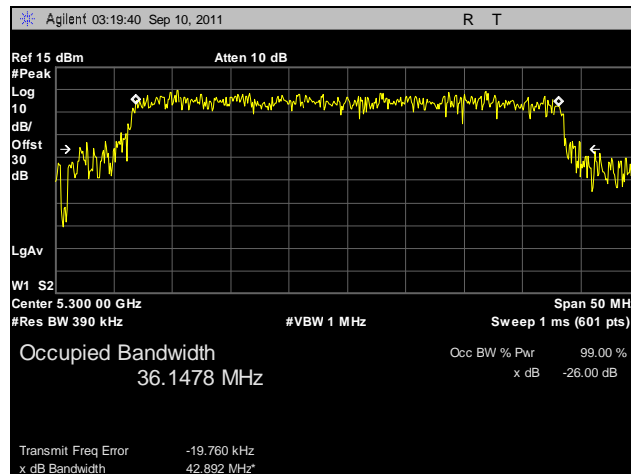

Plot 31. Occupied Bandwidth, 802.11n 40 MHz, Port B, 5300 MHz

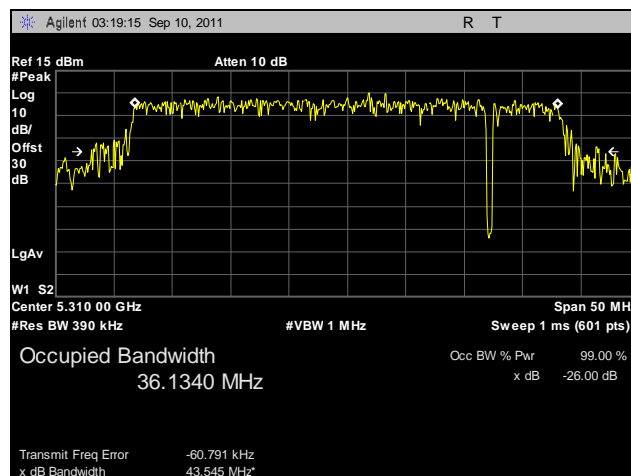

Plot 32. Occupied Bandwidth, 802.11n 40 MHz, Port B, 5310 MHz



**99% Occupied Bandwidth, 802.11a**

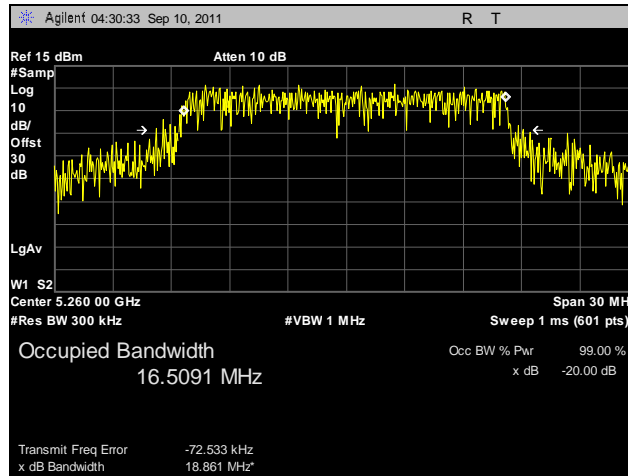

**Plot 36. 99% Occupied Bandwidth, 802.11a, 5260 MHz**

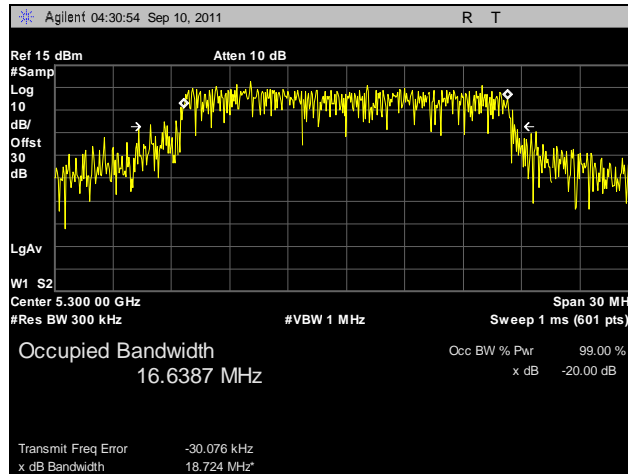

**Plot 37. 99% Occupied Bandwidth, 802.11a, 5300 MHz**

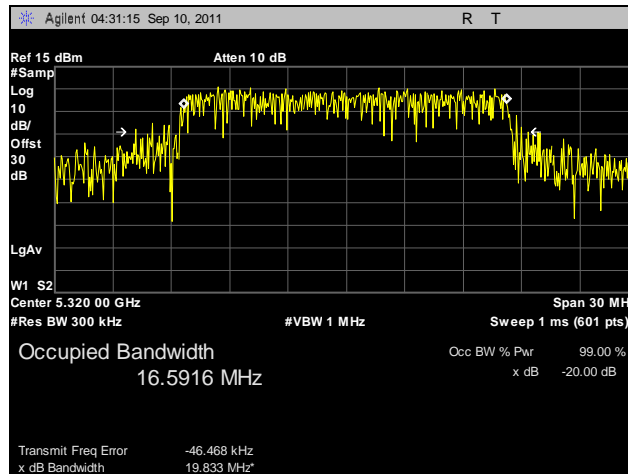

**Plot 38. 99% Occupied Bandwidth, 802.11a, 5320 MHz**

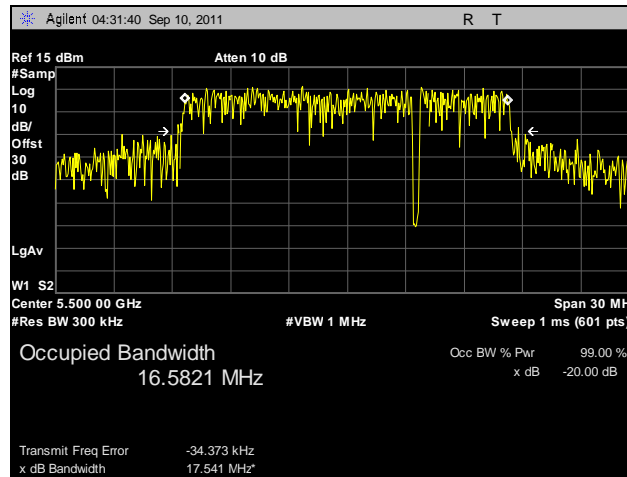

**Plot 39. 99% Occupied Bandwidth, 802.11a, 5500 MHz**

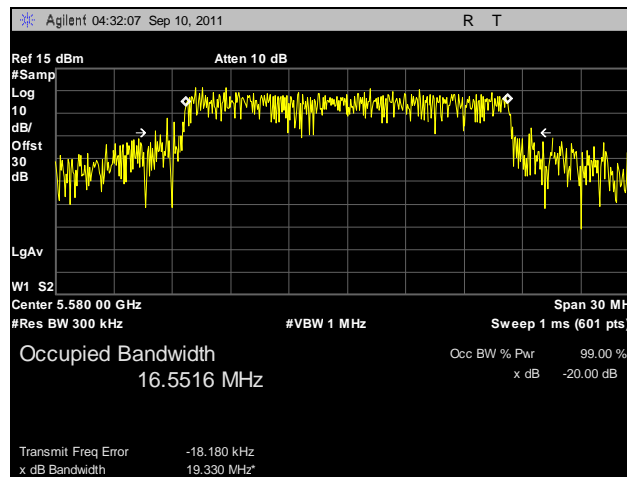

**Plot 40. 99% Occupied Bandwidth, 802.11a, 5580 MHz**

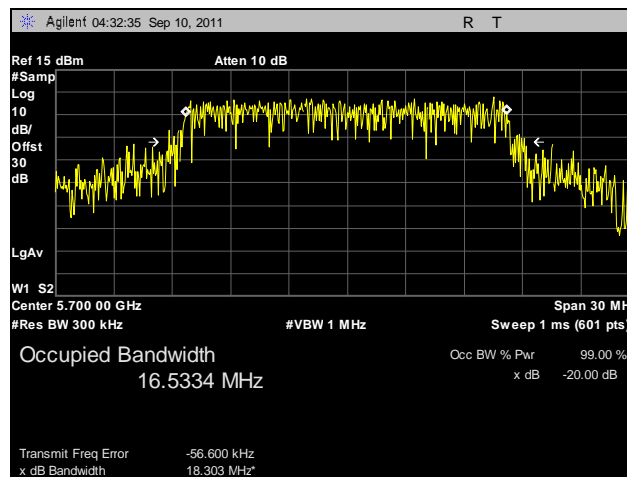

**Plot 41. 99% Occupied Bandwidth, 802.11a, 5700 MHz**

**99% Occupied Bandwidth, 802.11n 20 MHz, Port A**

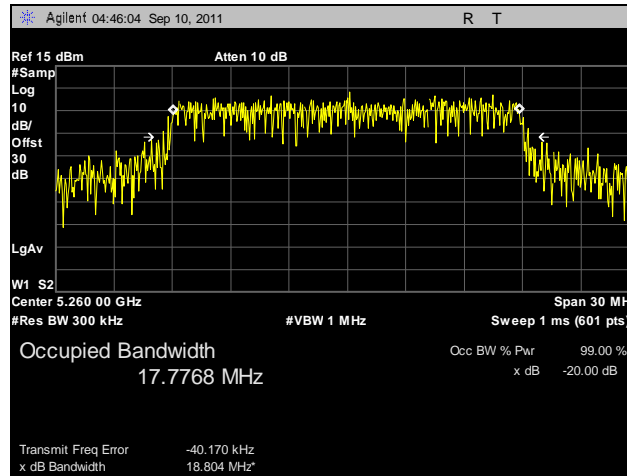

**Plot 42. 99% Occupied Bandwidth, 802.11n 20 MHz, Port A, 5260 MHz**

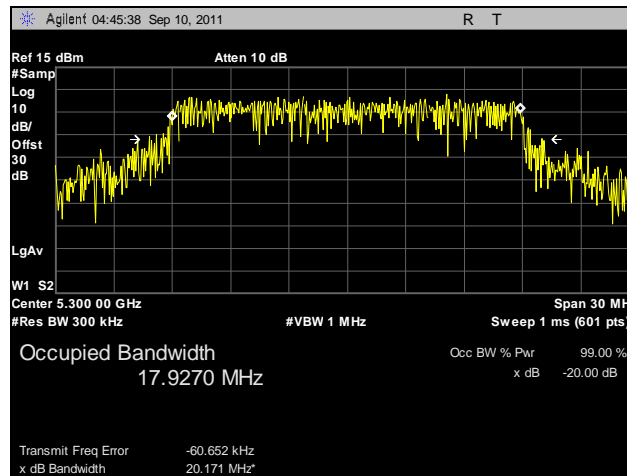

**Plot 43. 99% Occupied Bandwidth, 802.11n 20 MHz, Port A, 5300 MHz**

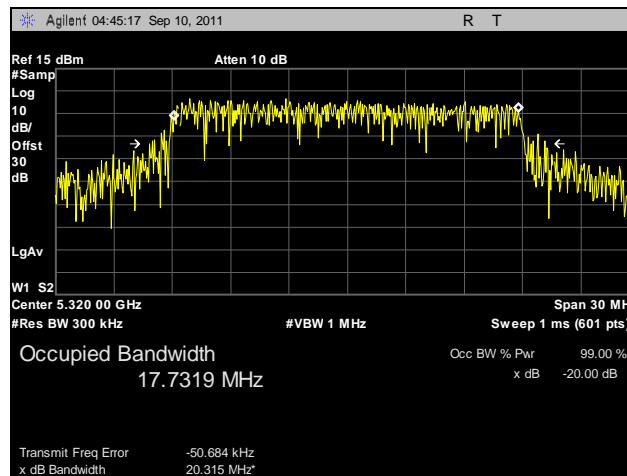

**Plot 44. 99% Occupied Bandwidth, 802.11n 20 MHz, Port A, 5320 MHz**

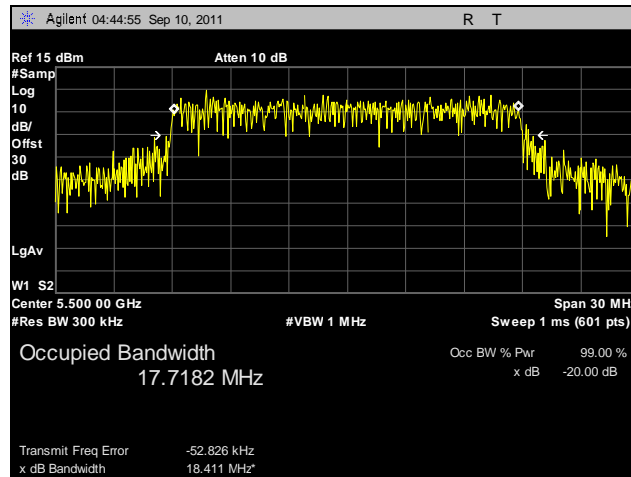

**Plot 45. 99% Occupied Bandwidth, 802.11n 20 MHz, Port A, 5500 MHz**

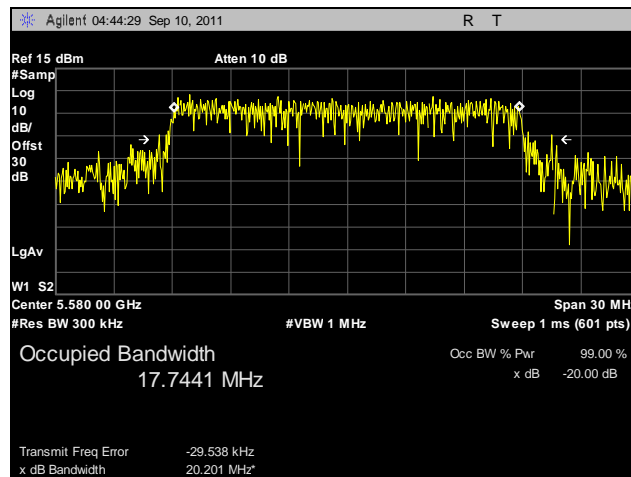

**Plot 46. 99% Occupied Bandwidth, 802.11n 20 MHz, Port A, 5580 MHz**

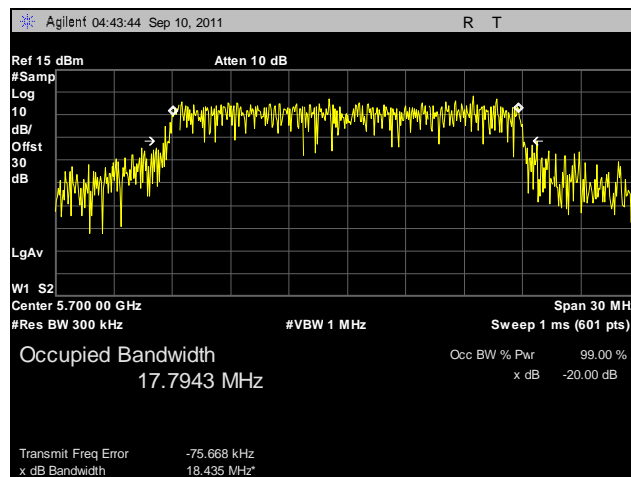

**Plot 47. 99% Occupied Bandwidth, 802.11n 20 MHz, Port A, 5700 MHz**

**99% Occupied Bandwidth, 802.11n 20 MHz, Port B**

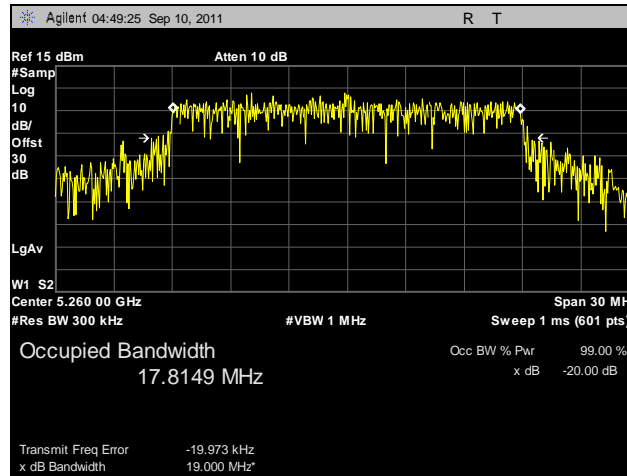

**Plot 48. 99% Occupied Bandwidth, 802.11n 20 MHz, Port B, 5260 MHz**

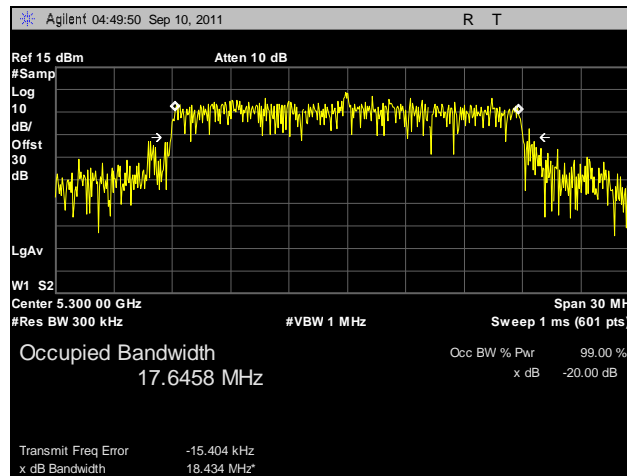

**Plot 49. 99% Occupied Bandwidth, 802.11n 20 MHz, Port B, 5300 MHz**

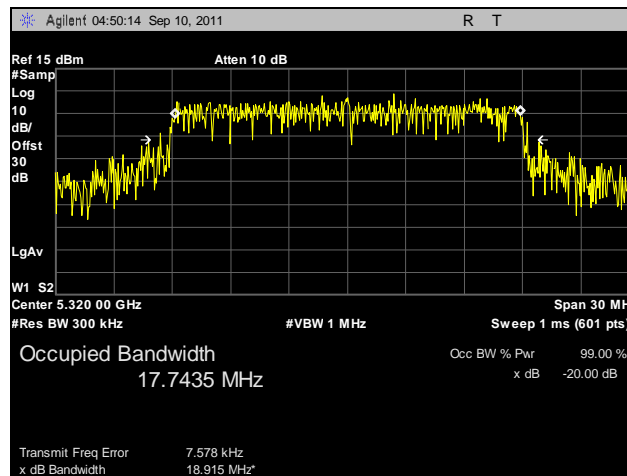

**Plot 50. 99% Occupied Bandwidth, 802.11n 20 MHz, Port B, 5320 MHz**



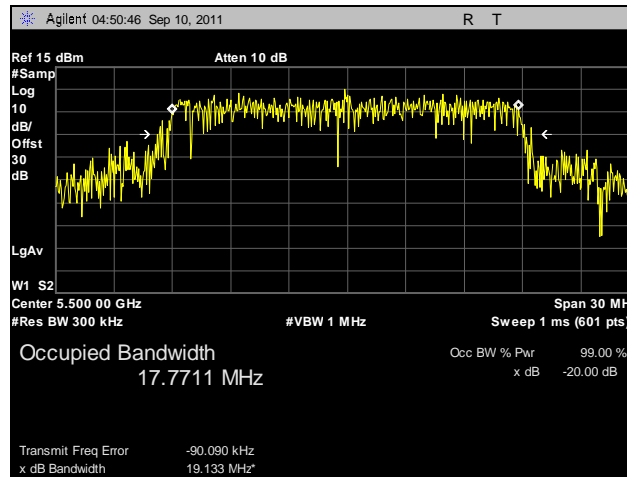

**Plot 51. 99% Occupied Bandwidth, 802.11n 20 MHz, Port B, 5500 MHz**

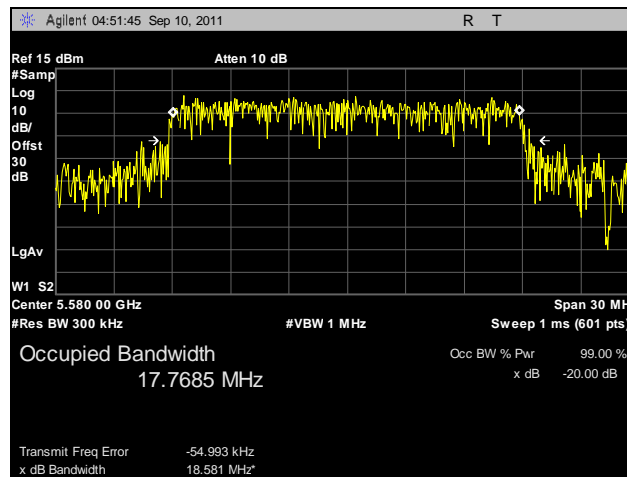

**Plot 52. 99% Occupied Bandwidth, 802.11n 20 MHz, Port B, 5580 MHz**

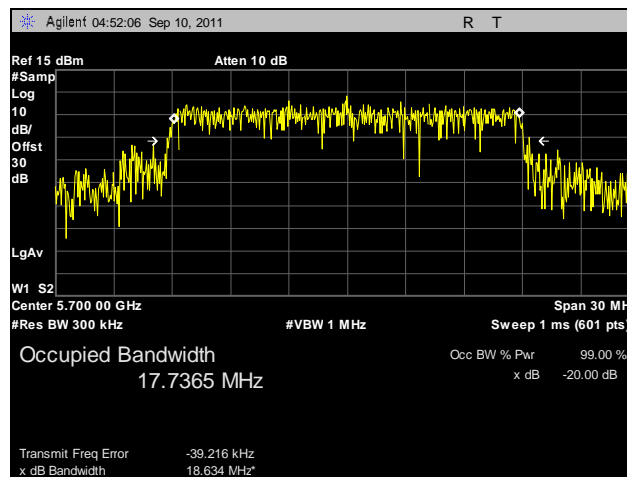

**Plot 53. 99% Occupied Bandwidth, 802.11n 20 MHz, Port B, 5700 MHz**

**99% Occupied Bandwidth, 802.11n 40 MHz, Port A**

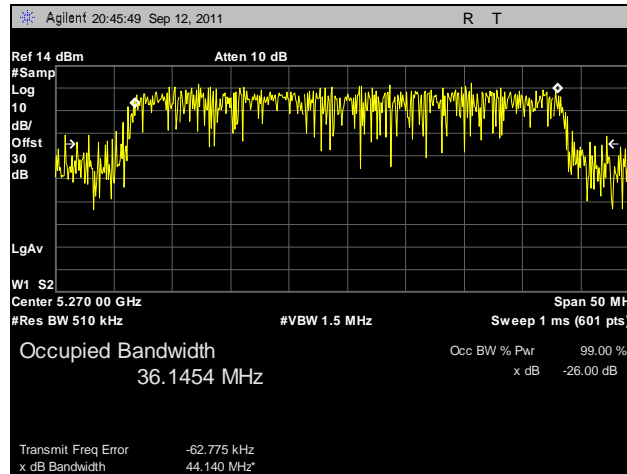

**Plot 54. 99% Occupied Bandwidth, 802.11n 40 MHz, Port A, 5270 MHz**

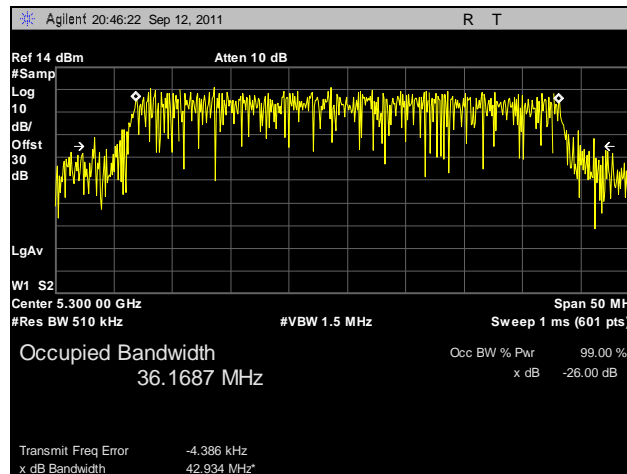

**Plot 55. 99% Occupied Bandwidth, 802.11n 40 MHz, Port A, 5300 MHz**

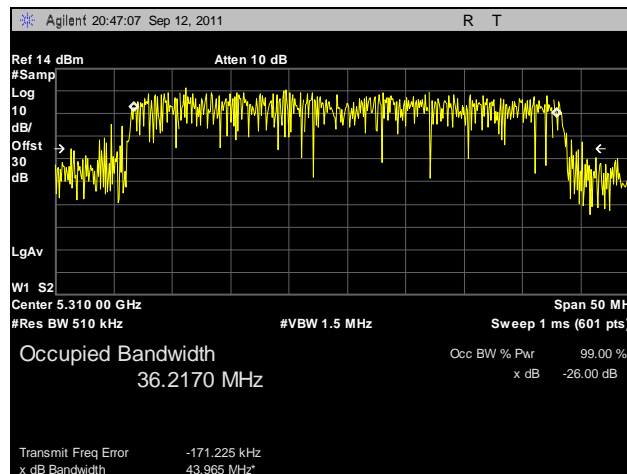

**Plot 56. 99% Occupied Bandwidth, 802.11n 40 MHz, Port A, 5310 MHz**

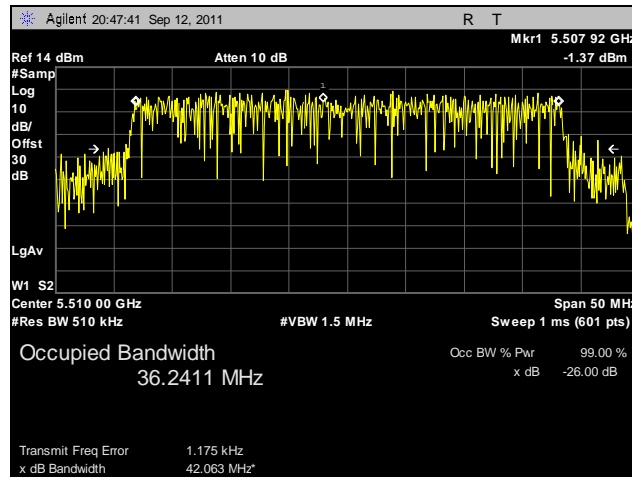

Plot 57. 99% Occupied Bandwidth, 802.11n 40 MHz, Port A, 5510 MHz

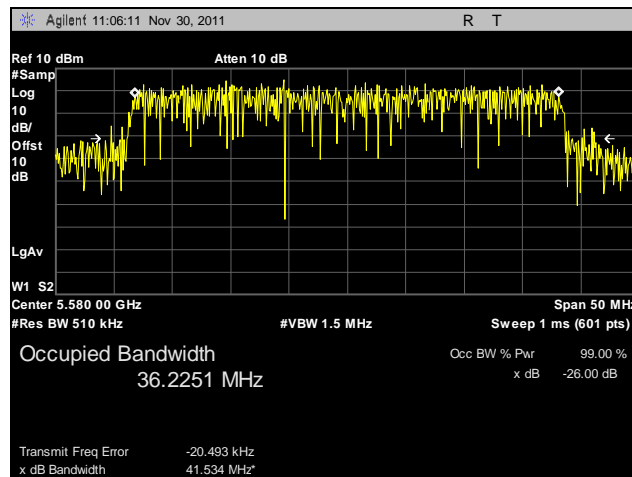

Plot 58. 99% Occupied Bandwidth, 802.11n 40 MHz, Port A, 5580 MHz

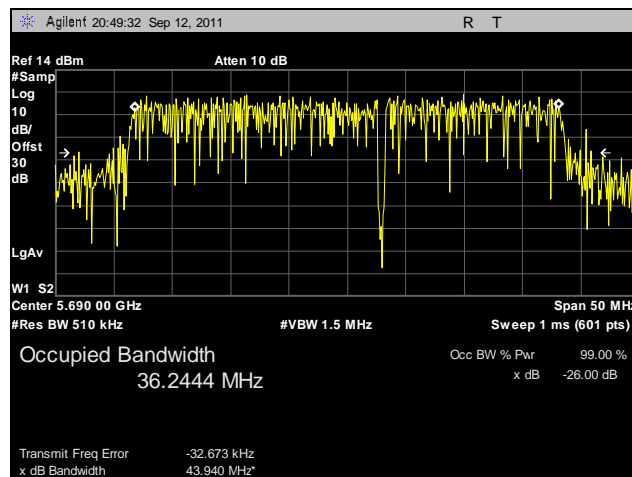

Plot 59. 99% Occupied Bandwidth, 802.11n 40 MHz, Port A, 5690 MHz

**99% Occupied Bandwidth, 802.11n 40 MHz, Port B**

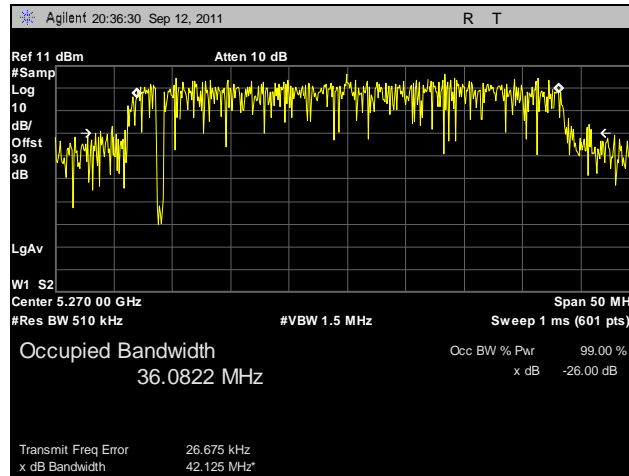

**Plot 60. 99% Occupied Bandwidth, 802.11n 40 MHz, Port B, 5270 MHz**

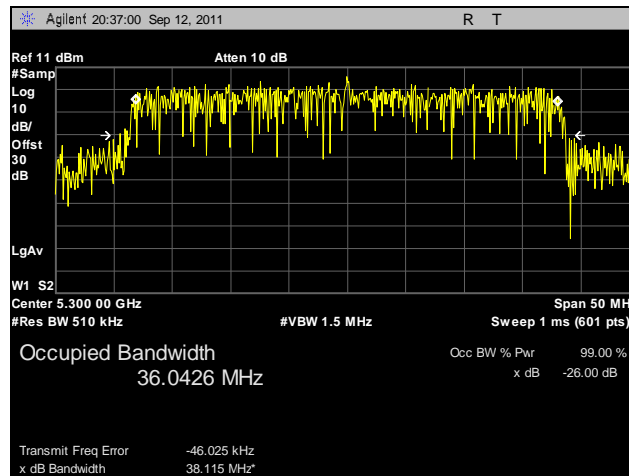

**Plot 61. 99% Occupied Bandwidth, 802.11n 40 MHz, Port B, 5300 MHz**

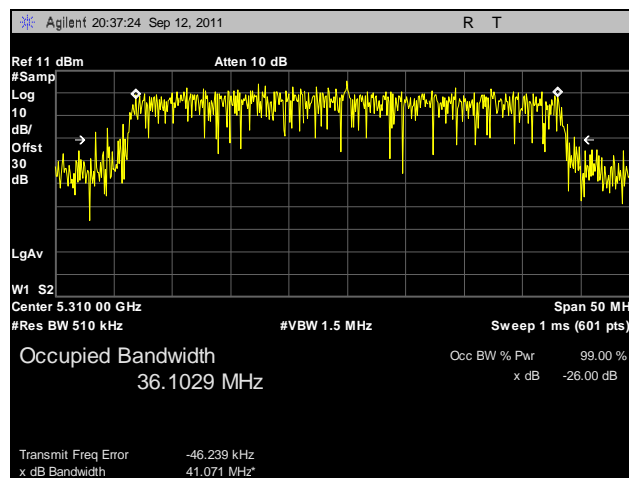

**Plot 62. 99% Occupied Bandwidth, 802.11n 40 MHz, Port B, 5310 MHz**

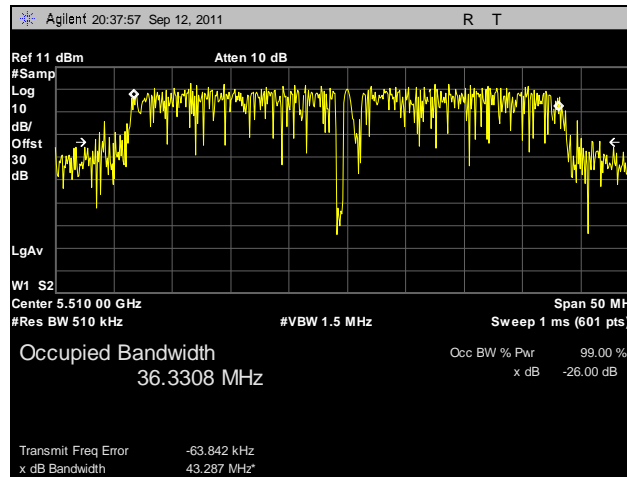

Plot 63. 99% Occupied Bandwidth, 802.11n 40 MHz, Port B, 5510 MHz

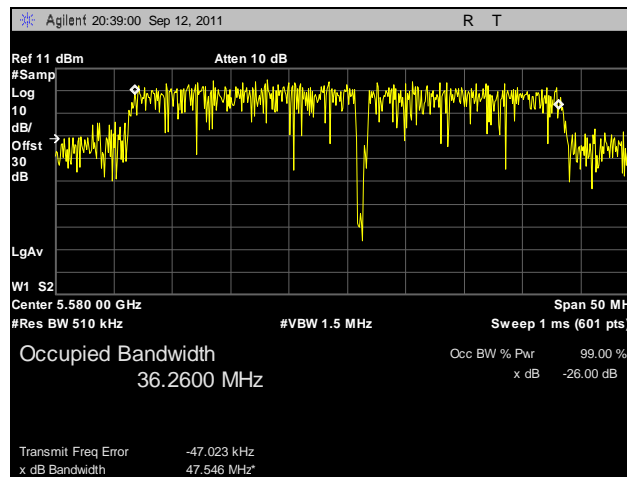

Plot 64. 99% Occupied Bandwidth, 802.11n 40 MHz, Port B, 5580 MHz

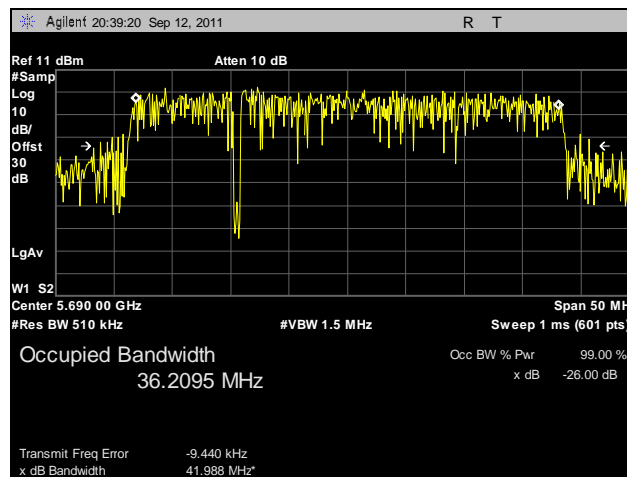

Plot 65. 99% Occupied Bandwidth, 802.11n 40 MHz, Port B, 5690 MHz

## Electromagnetic Compatibility Criteria for Intentional Radiators

### § 15.407(a) (1), (2) RF Power Output

**Test Requirements:** §15.407(a) (1), (2): The maximum output power of the intentional radiator shall not exceed the following:

Digital Transmission Systems (MHz)	Output Limit (mW)
5150-5250	50
5250-5350	250

**Table 19. Output Power Requirements from §15.407**

§15.407(a) (1): For the band 5.15-5.25 GHz the peak transmit power over the frequency band of operation shall not exceed the lesser 50mW or  $4\text{dBm} + 10\log B$ , where B is the 26-dB emission bandwidth in MHz.

§15.407(a) (2): For the band 5.25-5.35GHz & 5.470-5.72GHz the peak transmit power over the frequency band of operation shall not exceed the lesser of 250mW or  $11\text{dBm} + 10\log B$ , where B is the 26-dB emission bandwidth in MHz.

**Test Procedure:** The transmitter was connected to a calibrated Spectrum analyzer. The EUT was measured at the low, mid and high channels of each band with the data rate that produced the highest output power.

**Test Results:** Equipment complies with the Peak Power Output limits of § 15.401(a) (2)

**Test Engineer(s):** Jeff Pratt

**Test Date(s):** 09/09/11

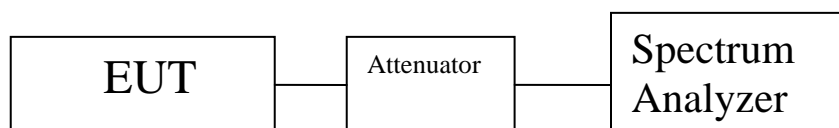

**Figure 2. Peak Power Output Test Setup**

Channel (MHz)	Mode / Mod. Type	Port 1A Conducted Power (dBm)	Port 1A Conducted Power (mW)	Port 1B Conducted Power (dBm)	Port 1B Conducted Power (mW)	Summed Conducted Power (mW)	Summed Conducted Power (dBm)	Antenna Gain (dBi)	Limit (dBm)	Margin (dB)
5260	802.11a	17.91	61.80164	-	-	61.80164	17.91	10	19.9794001	-2.06940009
5300	802.11a	17.91	61.80164	-	-	61.80164	17.91	10	19.9794001	-2.06940009
5320	802.11a	18.01	63.2411851	-	-	63.241185	18.01	10	19.9794001	-1.96940009
5500	802.11a	17.95	62.3734835	-	-	62.373484	17.95	10	19.9794001	-2.02940009
5580	802.11a	17.86	61.0942025	-	-	61.094202	17.86	10	19.9794001	-2.11940009
5700	802.11a	16.54	45.0816705	-	-	45.08167	16.54	10	19.9794001	-3.43940009
5260	802.11n HT20	14.43	27.733201	13.68	23.3345806	51.067782	17.0814699	10	19.9794001	-2.89793016
5300	802.11n HT20	14.91	30.974193	14.51	28.2487997	59.222993	17.7249035	10	19.9794001	-2.25449659
5320	802.11n HT20	14.22	26.4240876	14.01	25.1767693	51.600857	17.1265691	10	19.9794001	-2.85283095
5500	802.11n HT20	15	31.6227766	14.81	30.2691343	61.891911	17.9163389	10	19.9794001	-2.06306117
5580	802.11n HT20	14.89	30.8318795	14.82	30.3389118	61.170791	17.865441	10	19.9794001	-2.1139591
5700	802.11n HT20	14.71	29.5801247	13.94	24.7742206	54.354345	17.3523427	10	19.9794001	-2.6270574
5270	802.11n HT40	16.05	40.2717034	17.21	52.6017266	92.87343	19.6789149	10	19.9794001	-0.30048523
5300	802.11n HT40	16.67	46.4515275	17.12	51.5228645	97.974392	19.9111258	10	19.9794001	-0.06827432
5310	802.11n HT40	16.53	44.9779855	16.67	46.4515275	91.429513	19.6108641	10	19.9794001	-0.36853602
5510	802.11n HT40	16.07	40.4575892	16.9	48.9778819	89.435471	19.515098	10	19.9794001	-0.4643021
5580	802.11n HT40	14.78	30.060763	16.14	41.1149721	71.175735	18.5233196	10	19.9794001	-1.45608047
5690	802.11n HT40	14.73	29.7166603	14.55	28.5101827	58.226843	17.6512324	10	19.9794001	-2.32816765

**Table 20. RF Power Output, Test Results**

Channel (MHz)	Mode / Mod. Type	Port 1A Conducted Power (dBm)	Port 1A Conducted Power (mW)	Port 1B Conducted Power (dBm)	Port 1B Conducted Power (mW)	Summed Conducted Power (mW)	Summed Conducted Power (dBm)	Antenna Gain (dBi)	Limit (dBm)	Margin (dB)
5260	802.11a	11.43	13.8995263			13.899526	11.43	15.5	14.4794001	-3.04940009
5300	802.11a	11.74	14.9279441			14.927944	11.74	15.5	14.4794001	-2.73940009
5320	802.11a	12.08	16.1435856			16.143586	12.08	15.5	14.4794001	-2.39940009
5500	802.11a	12.32	17.0608239			17.060824	12.32	15.5	14.4794001	-2.15940009
5580	802.11a	12.15	16.4058977			16.405898	12.15	15.5	14.4794001	-2.32940009
5700	802.11a	11.64	14.5881426			14.588143	11.64	15.5	14.4794001	-2.83940009
5260	802.11n HT20	9.02	7.97994687	8.75	7.49894209	15.478889	11.8973978	15.5	14.4794001	-2.58200224
5300	802.11n HT20	9.7	9.33254301	9.8	9.54992586	18.882469	12.7605878	15.5	14.4794001	-1.71881231
5320	802.11n HT20	9.42	8.74983775	9.32	8.55066713	17.300505	12.3805878	15.5	14.4794001	-2.09881231
5500	802.11n HT20	8.29	6.74528028	9.24	8.39459987	15.13988	11.8012244	15.5	14.4794001	-2.67817572
5580	802.11n HT20	9.1	8.12830516	8.15	6.53130553	14.659611	11.6612244	15.5	14.4794001	-2.81817572
5700	802.11n HT20	9.7	9.33254301	8.63	7.2945751	16.627118	12.2081698	15.5	14.4794001	-2.27123027
5270	802.11n HT40	9.57	9.05732601	11.51	14.1579378	23.215264	13.6577362	15.5	14.4794001	-0.82166386
5300	802.11n HT40	9.19	8.29850768	8.67	7.36207097	15.660579	11.948078	15.5	14.4794001	-2.53132204
5310	802.11n HT40	9.55	9.01571138	9.7	9.33254301	18.348254	12.6359475	15.5	14.4794001	-1.84345256
5510	802.11n HT40	11.52	14.1905752	11.91	15.5238701	29.714445	14.7296763	15.5	14.4794001	0.25027619
5580	802.11n HT40	10.98	12.5314117	11.38	13.7404198	26.271831	14.1949035	15.5	14.4794001	-0.28449659
5690	802.11n HT40	11.05	12.7350308	11.04	12.7057411	25.440772	14.0553028	15.5	14.4794001	-0.42409725

**Table 21. RF Power Output, Test Results, Sector Antenna**



## Conducted Output Power, 802.11a

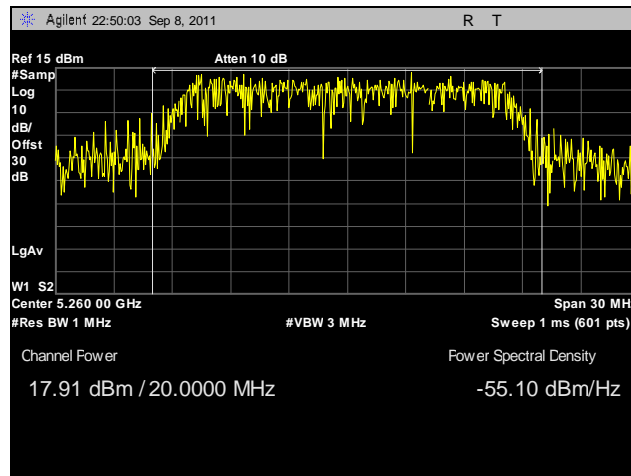

**Plot 66. Conducted Output Power, 802.11a, 5260 MHz**

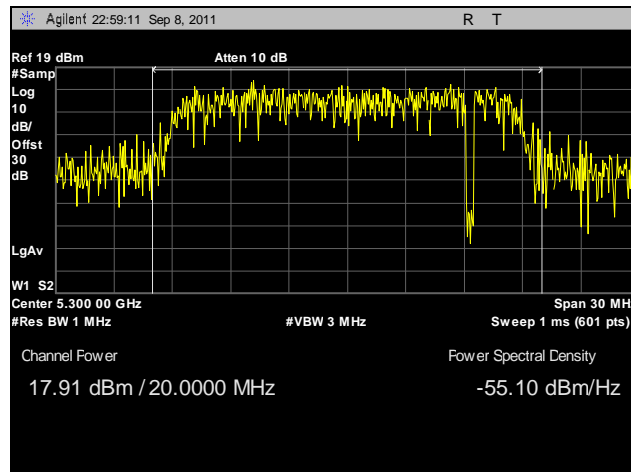

**Plot 67. Conducted Output Power, 802.11a, 5300 MHz**

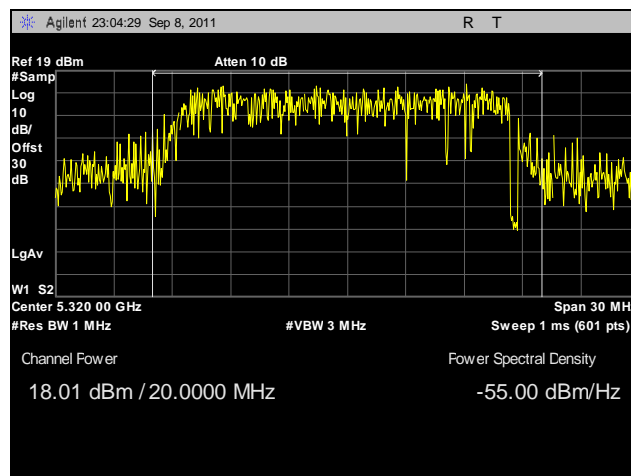

**Plot 68. Conducted Output Power, 802.11a, 5320 MHz**

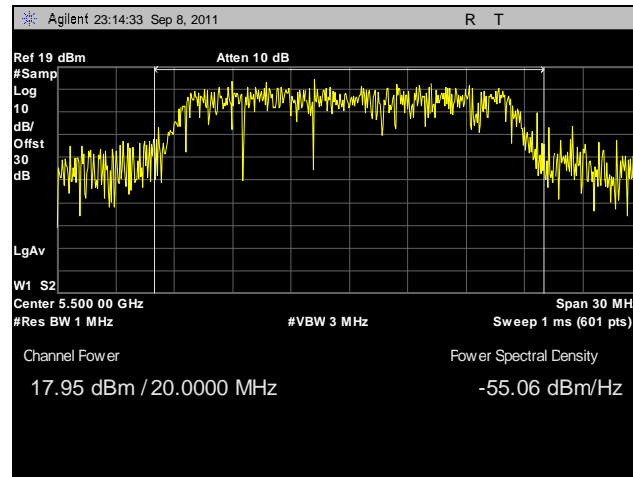

**Plot 69. Conducted Output Power, 802.11a, 5500 MHz**

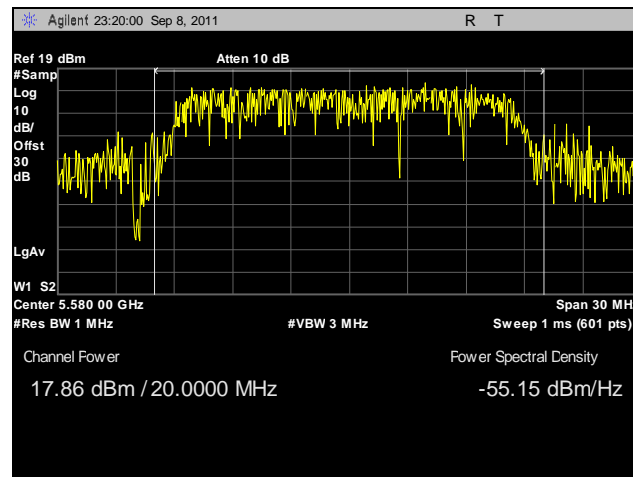

**Plot 70. Conducted Output Power, 802.11a, 5580 MHz**

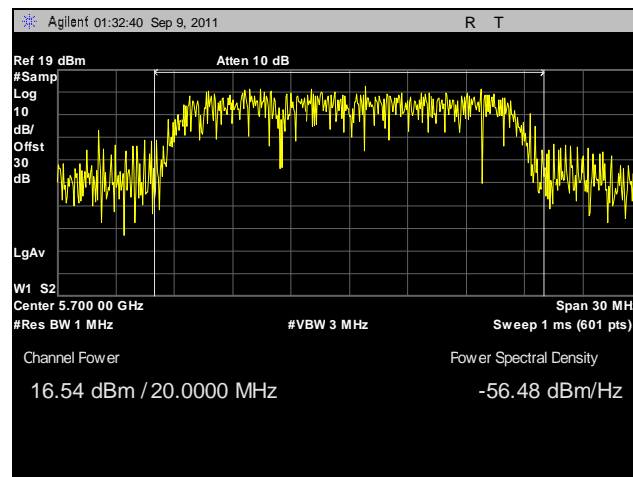

**Plot 71. Conducted Output Power, 802.11a, 5700 MHz**

### Conducted Output Power, 802.11n 20 MHz, Port A

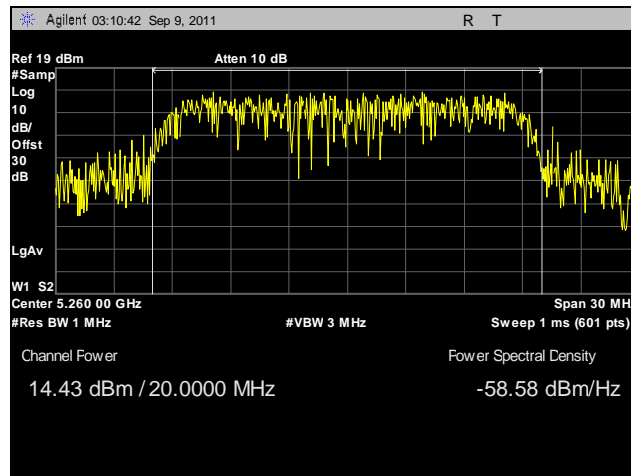

**Plot 72. Conducted Output Power, 802.11n 20 MHz, Port A, 5260 MHz**

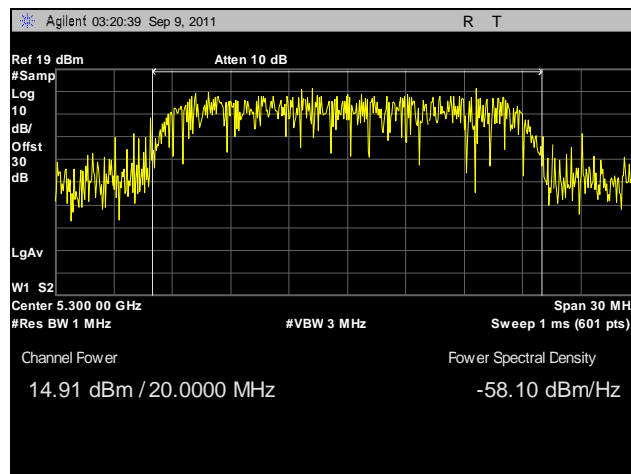

**Plot 73. Conducted Output Power, 802.11n 20 MHz, Port A, 5300 MHz**

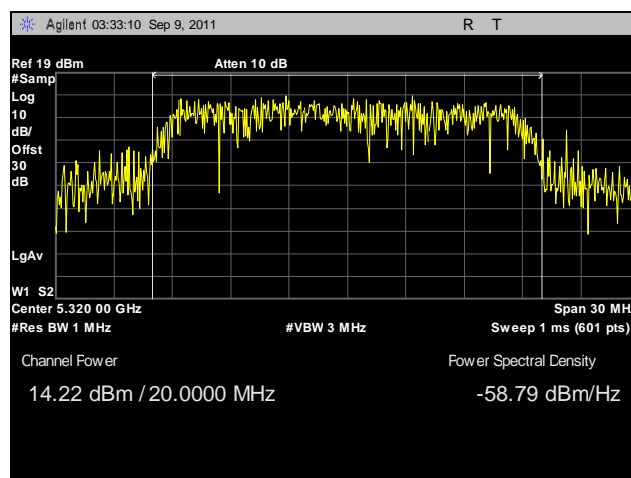

**Plot 74. Conducted Output Power, 802.11n 20 MHz, Port A, 5320 MHz**

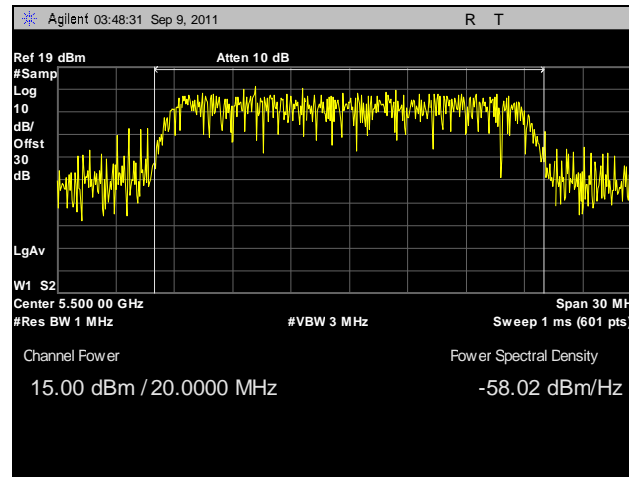

**Plot 75. Conducted Output Power, 802.11n 20 MHz, Port A, 5500 MHz**

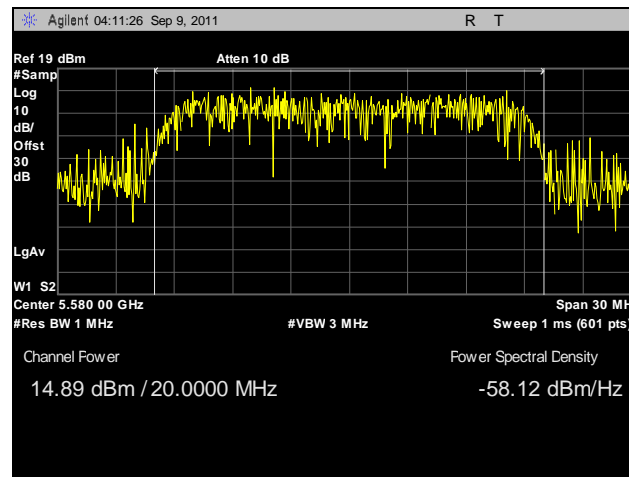

**Plot 76. Conducted Output Power, 802.11n 20 MHz, Port A, 5580 MHz**

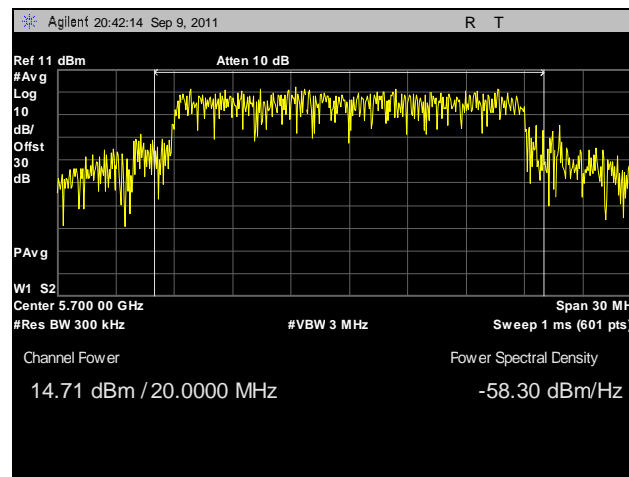

**Plot 77. Conducted Output Power, 802.11n 20 MHz, Port A, 5700 MHz**

### Conducted Output Power, 802.11n 20 MHz, Port B

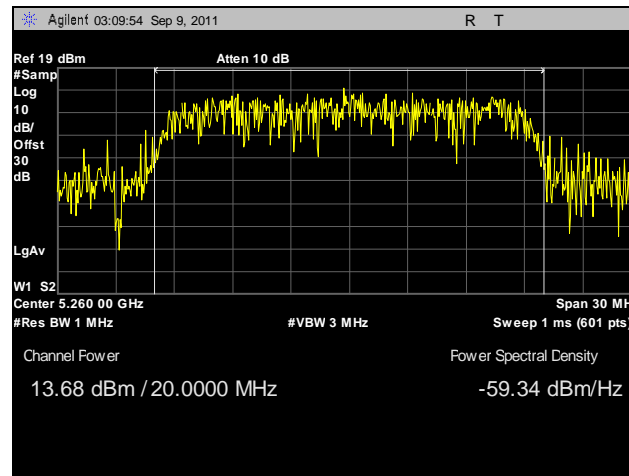

**Plot 78. Conducted Output Power, 802.11n 20 MHz, Port B, 5260 MHz**

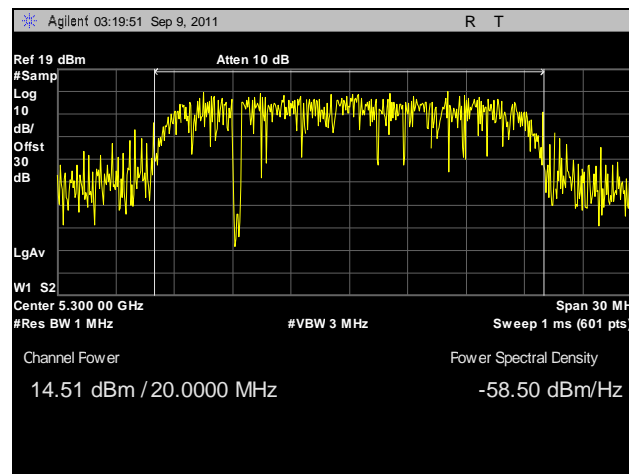

**Plot 79. Conducted Output Power, 802.11n 20 MHz, Port B, 5300 MHz**

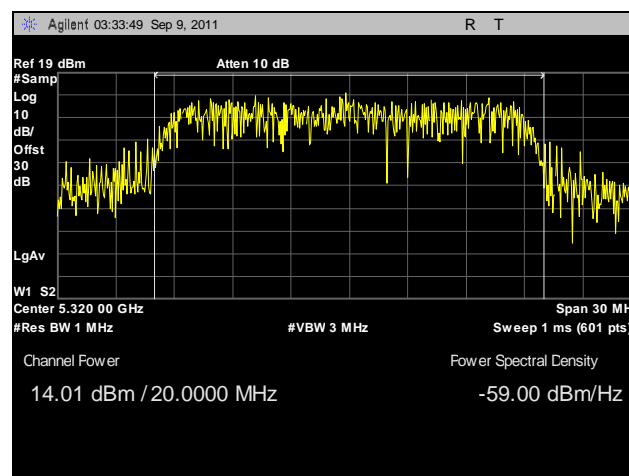

**Plot 80. Conducted Output Power, 802.11n 20 MHz, Port B, 5320 MHz**

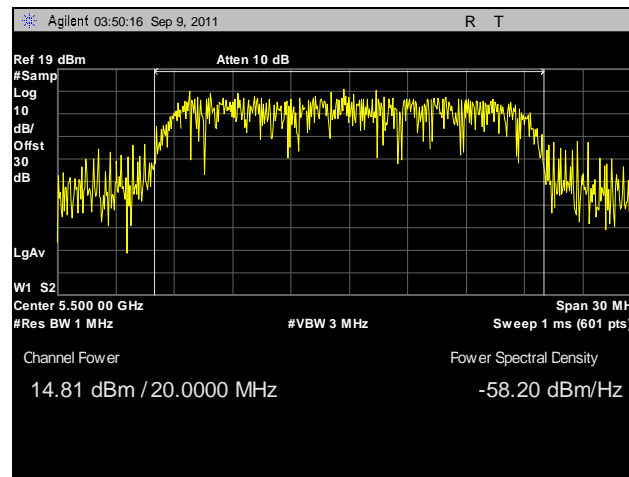

**Plot 81. Conducted Output Power, 802.11n 20 MHz, Port B, 5500 MHz**

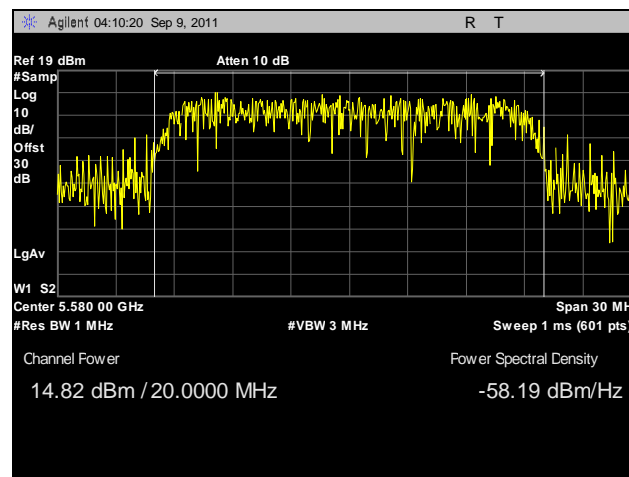

**Plot 82. Conducted Output Power, 802.11n 20 MHz, Port B, 5580 MHz**

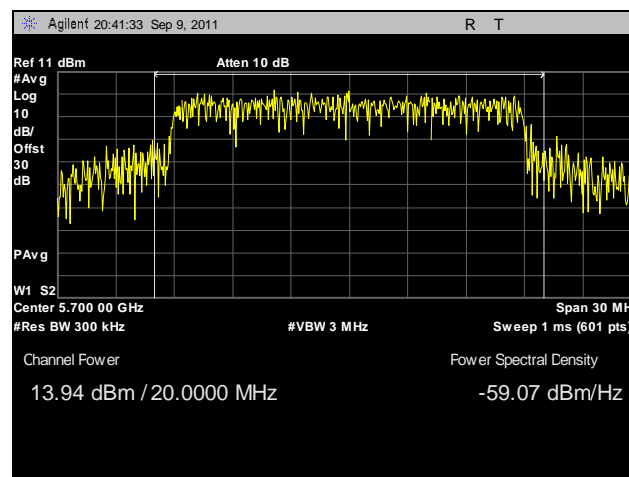

**Plot 83. Conducted Output Power, 802.11n 20 MHz, Port B, 5700 MHz**

### Conducted Output Power, 802.11n 40 MHz, Port A

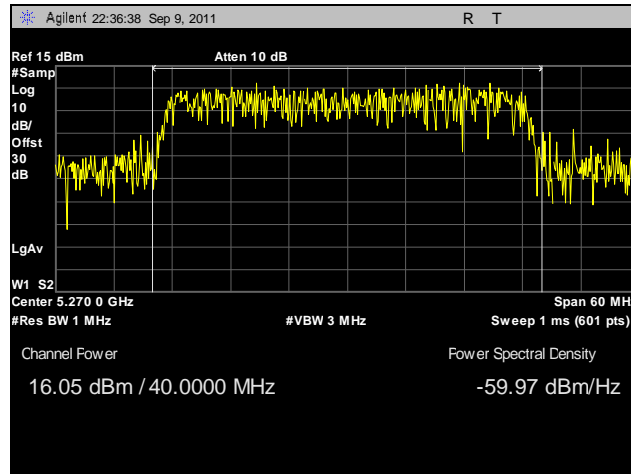

**Plot 84. Conducted Output Power, 802.11n 40 MHz, Port A, 5270 MHz**

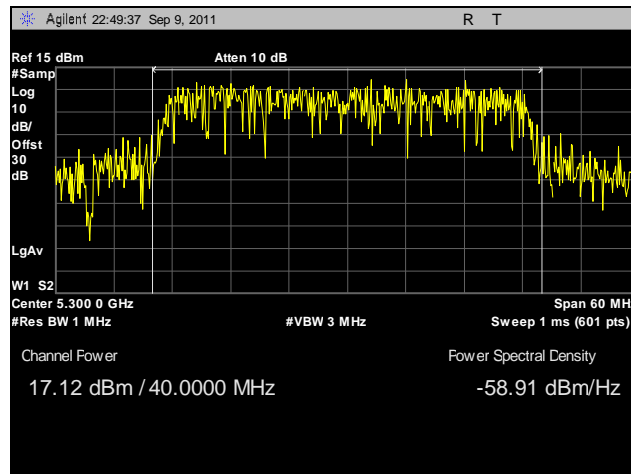

**Plot 85. Conducted Output Power, 802.11n 40 MHz, Port A, 5300 MHz**

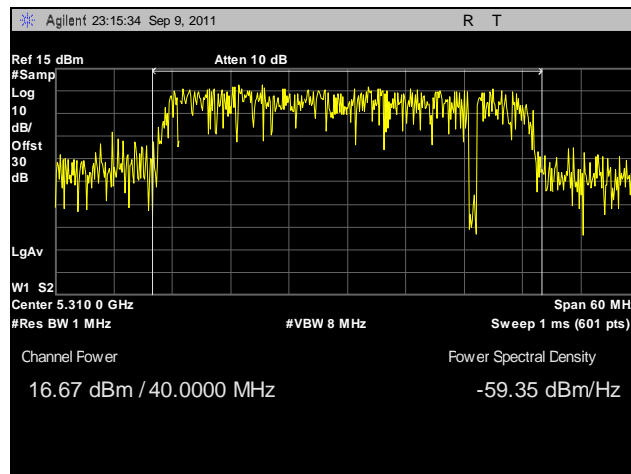

**Plot 86. Conducted Output Power, 802.11n 40 MHz, Port A, 5310 MHz**

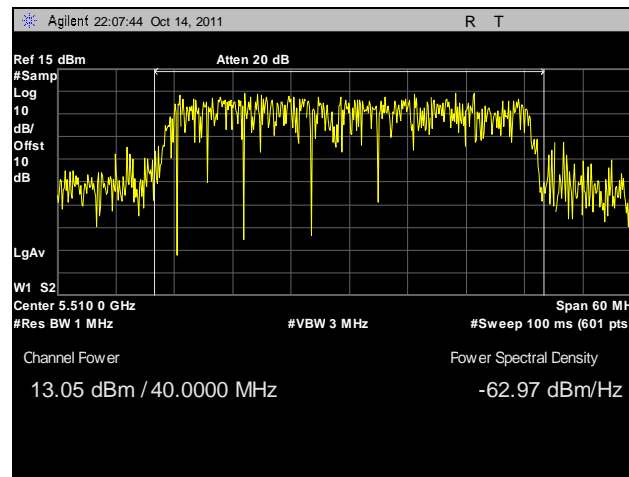

**Plot 87. Conducted Output Power, 802.11n 40 MHz, Port A, 5510 MHz**

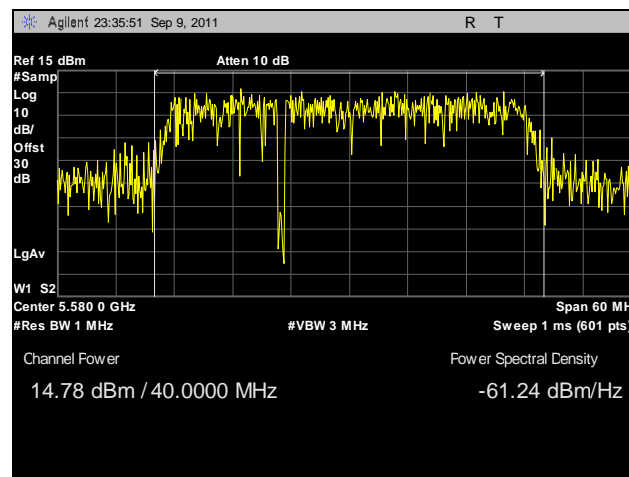

**Plot 88. Conducted Output Power, 802.11n 40 MHz, Port A, 5580 MHz**

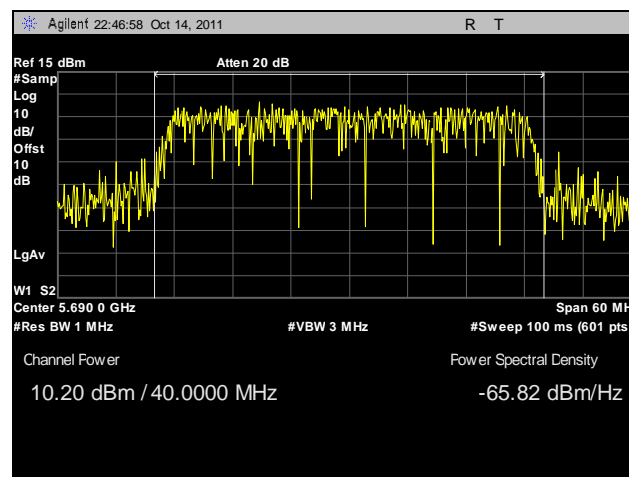

**Plot 89. Conducted Output Power, 802.11n 40 MHz, Port A, 5690 MHz**



### Conducted Output Power, 802.11n 40 MHz, Port B

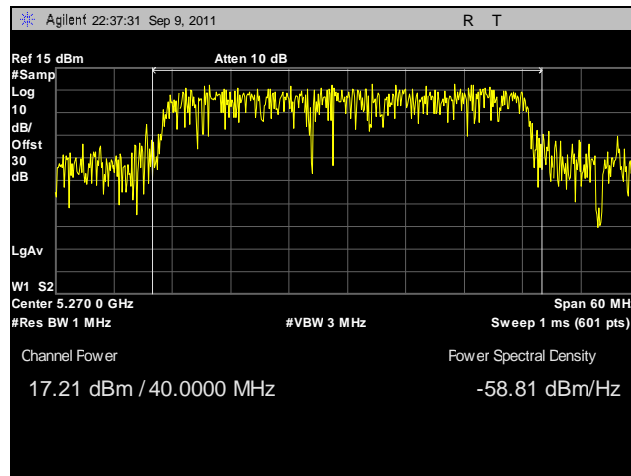

**Plot 90. Conducted Output Power, 802.11n 40 MHz, Port B, 5270 MHz**

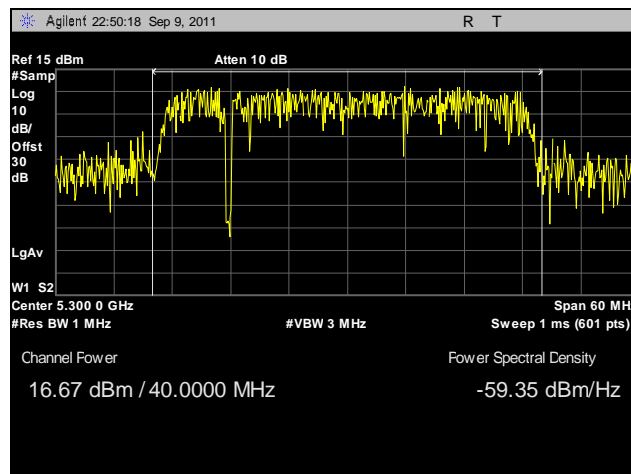

**Plot 91. Conducted Output Power, 802.11n 40 MHz, Port B, 5300 MHz**

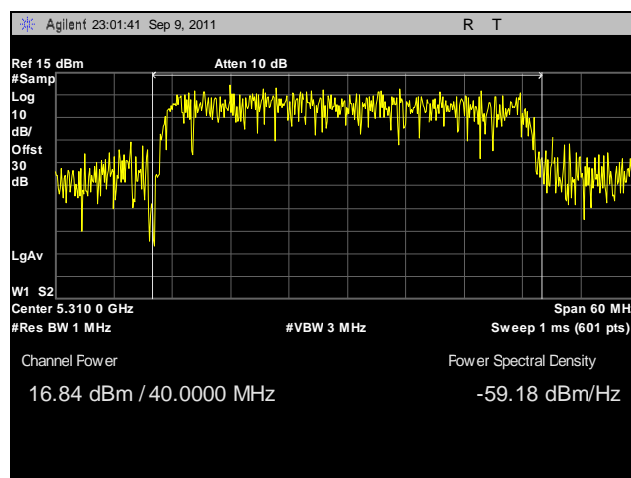

**Plot 92. Conducted Output Power, 802.11n 40 MHz, Port B, 5310 MHz**

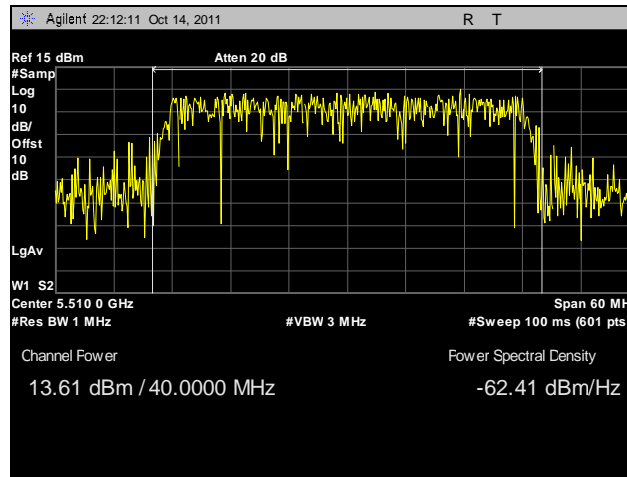

**Plot 93. Conducted Output Power, 802.11n 40 MHz, Port B, 5510 MHz**

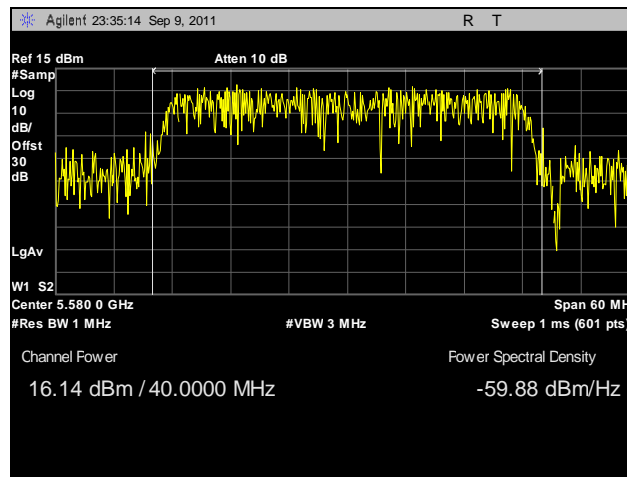

**Plot 94. Conducted Output Power, 802.11n 40 MHz, Port B, 5580 MHz**

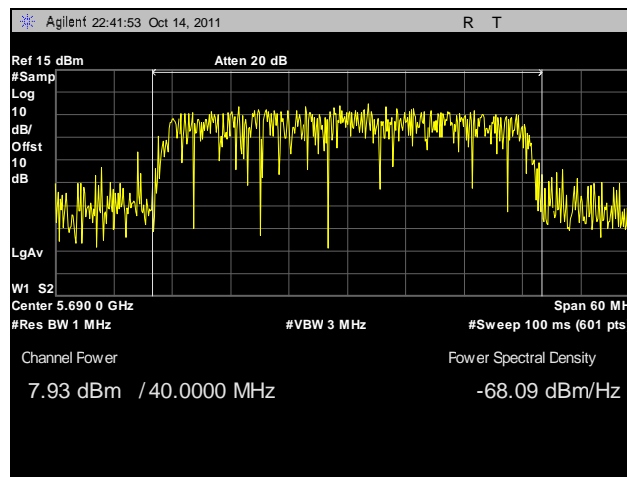

**Plot 95. Conducted Output Power, 802.11n 40 MHz, Port B, 5690 MHz**

## Conducted Output Power, 802.11a, Sector Antenna

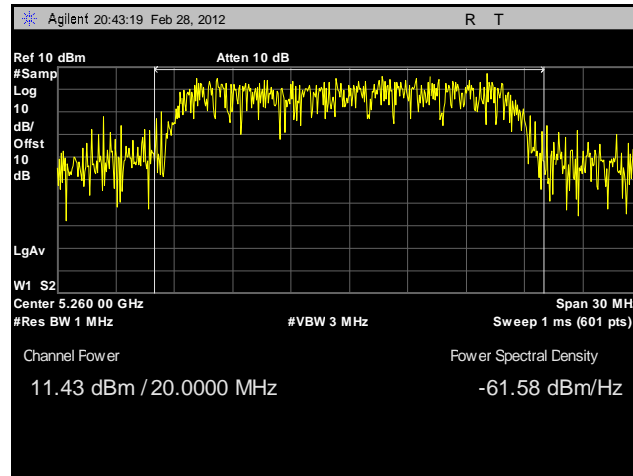

Plot 96. Conducted Output Power, 802.11a, 5260 MHz, Sector Antenna

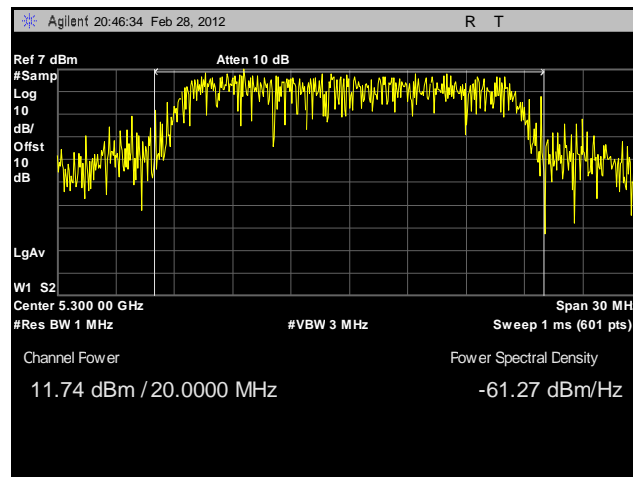

Plot 97. Conducted Output Power, 802.11a, 5300 MHz, Sector Antenna

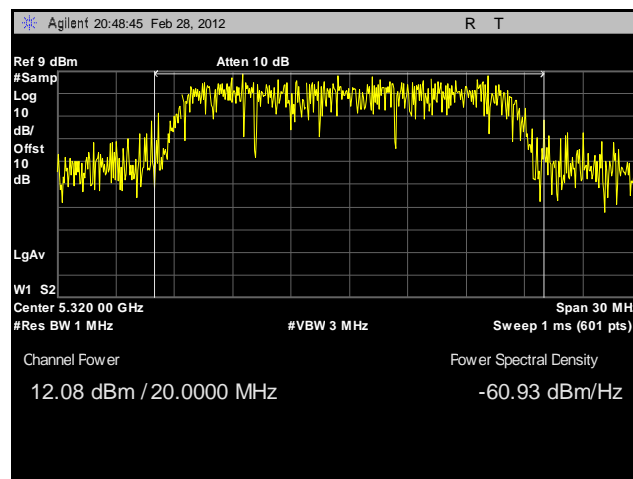

Plot 98. Conducted Output Power, 802.11a, 5320 MHz, Sector Antenna

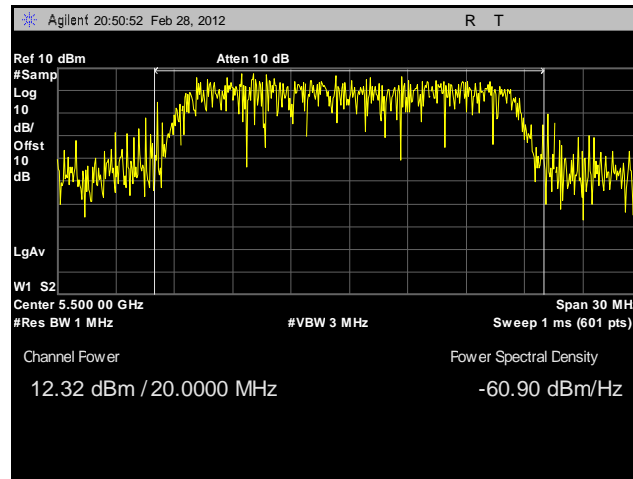

**Plot 99. Conducted Output Power, 802.11a, 5500 MHz, Sector Antenna**

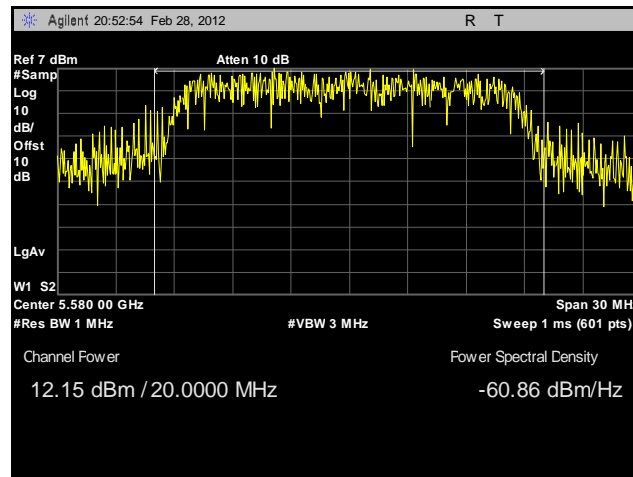

**Plot 100. Conducted Output Power, 802.11a, 5580 MHz, Sector Antenna**

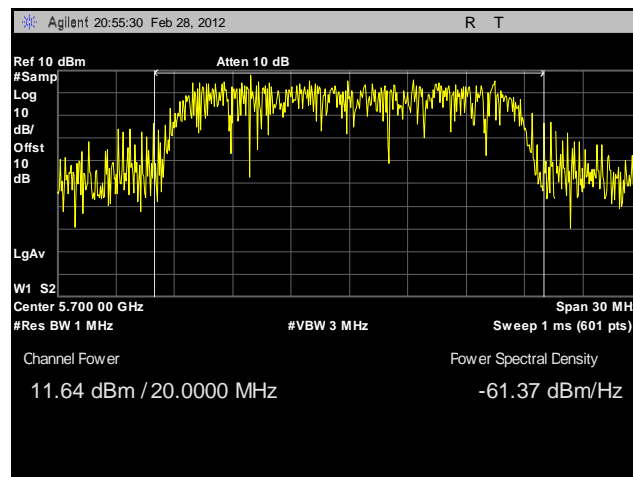

**Plot 101. Conducted Output Power, 802.11a, 5700 MHz, Sector Antenna**

### Conducted Output Power, 802.11n 20 MHz, Port A, Sector Antenna

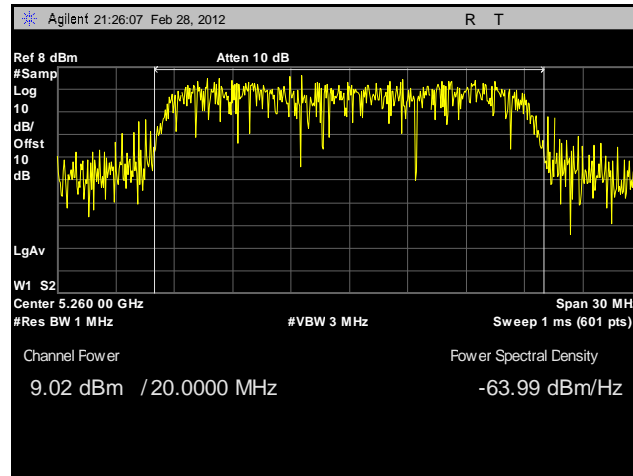

Plot 102. Conducted Output Power, 802.11n 20 MHz, Port A, 5260 MHz, Sector Antenna

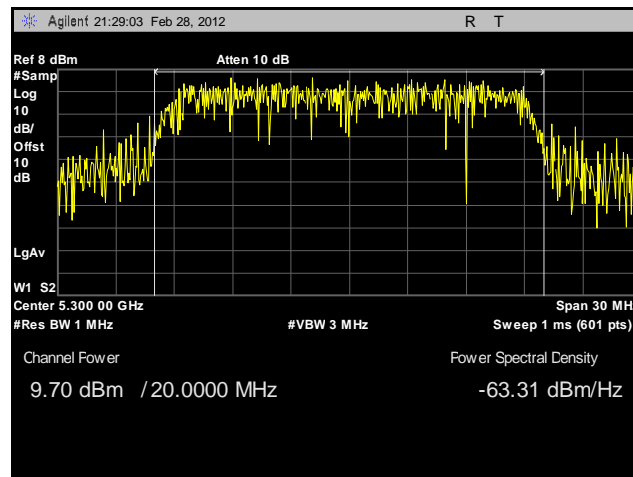

Plot 103. Conducted Output Power, 802.11n 20 MHz, Port A, 5300 MHz, Sector Antenna

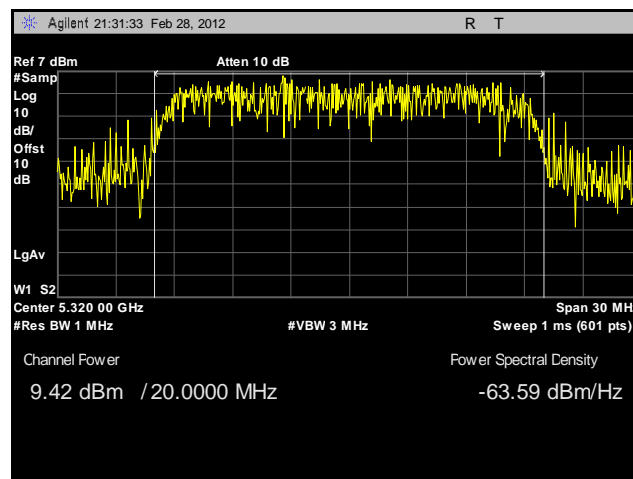

Plot 104. Conducted Output Power, 802.11n 20 MHz, Port A, 5320 MHz, Sector Antenna

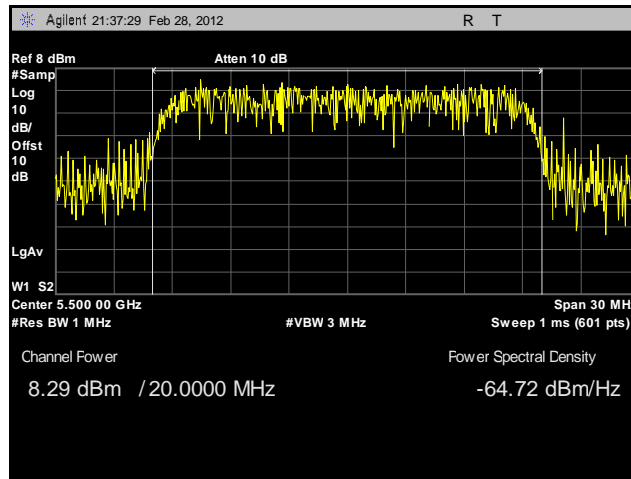

**Plot 105. Conducted Output Power, 802.11n 20 MHz, Port A, 5500 MHz, Sector Antenna**

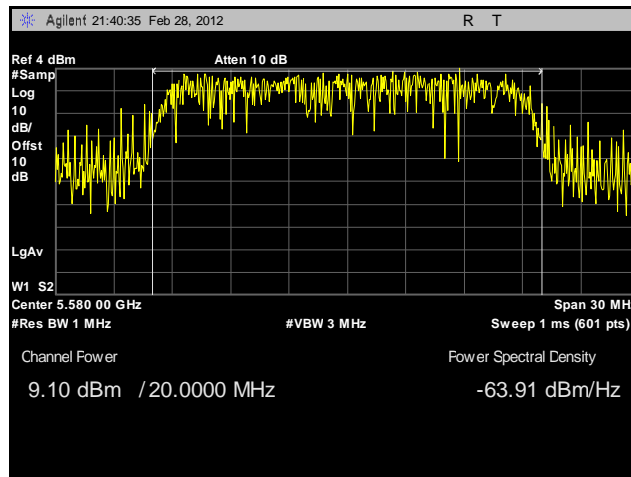

**Plot 106. Conducted Output Power, 802.11n 20 MHz, Port A, 5580 MHz, Sector Antenna**

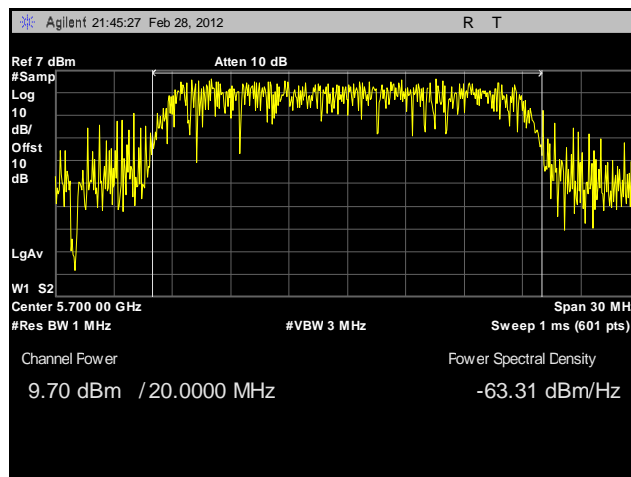

**Plot 107. Conducted Output Power, 802.11n 20 MHz, Port A, 5700 MHz, Sector Antenna**

### Conducted Output Power, 802.11n 20 MHz, Port B, Sector Antenna

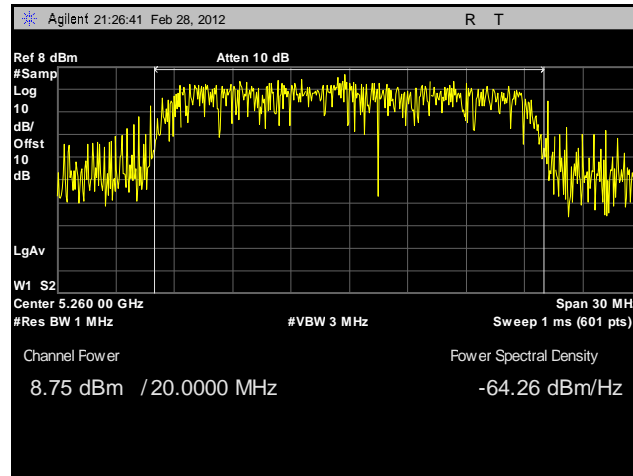

Plot 108. Conducted Output Power, 802.11n 20 MHz, Port B, 5260 MHz, Sector Antenna

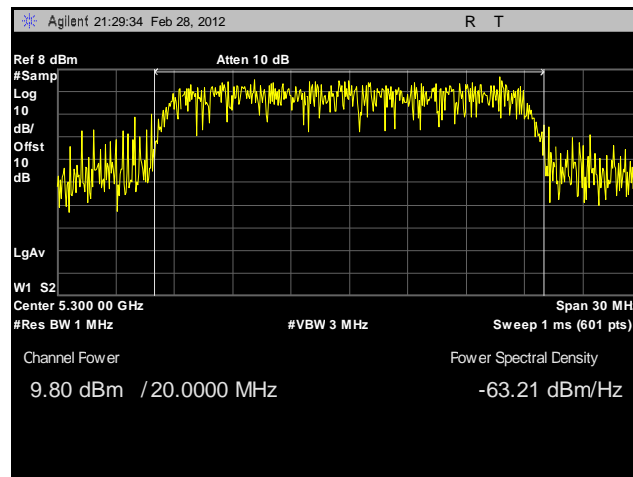

Plot 109. Conducted Output Power, 802.11n 20 MHz, Port B, 5300 MHz, Sector Antenna

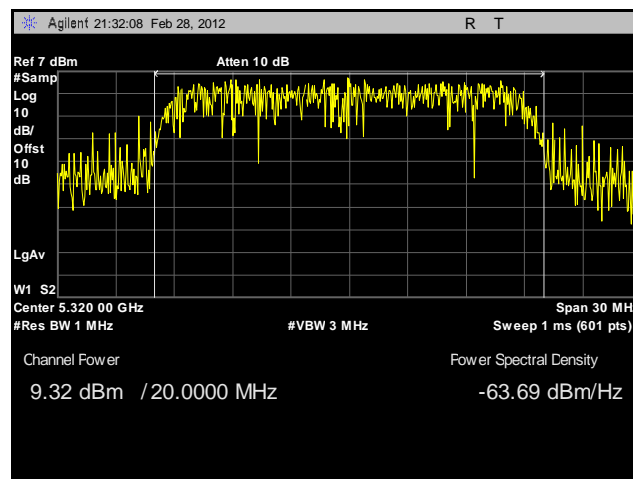

Plot 110. Conducted Output Power, 802.11n 20 MHz, Port B, 5320 MHz, Sector Antenna

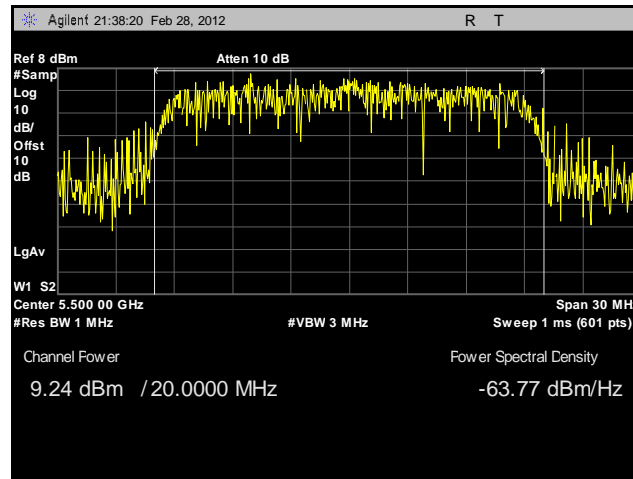

**Plot 111. Conducted Output Power, 802.11n 20 MHz, Port B, 5500 MHz, Sector Antenna**

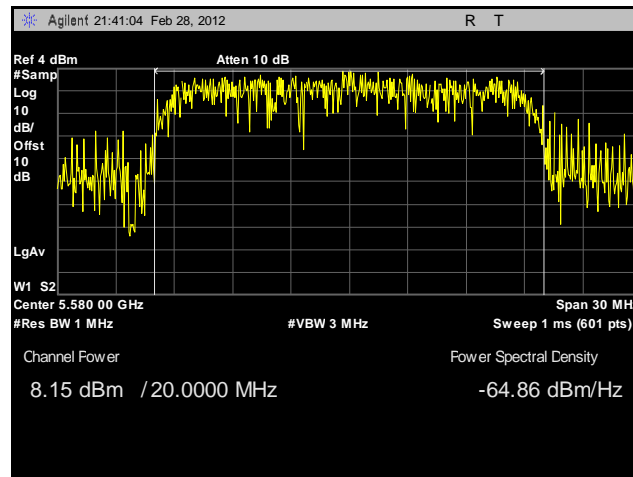

**Plot 112. Conducted Output Power, 802.11n 20 MHz, Port B, 5580 MHz, Sector Antenna**

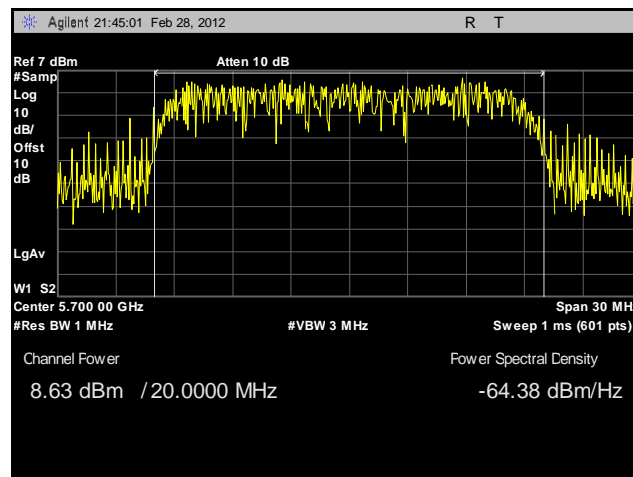

**Plot 113. Conducted Output Power, 802.11n 20 MHz, Port B, 5700 MHz, Sector Antenna**



### Conducted Output Power, 802.11n 40 MHz, Port A, Sector Antenna

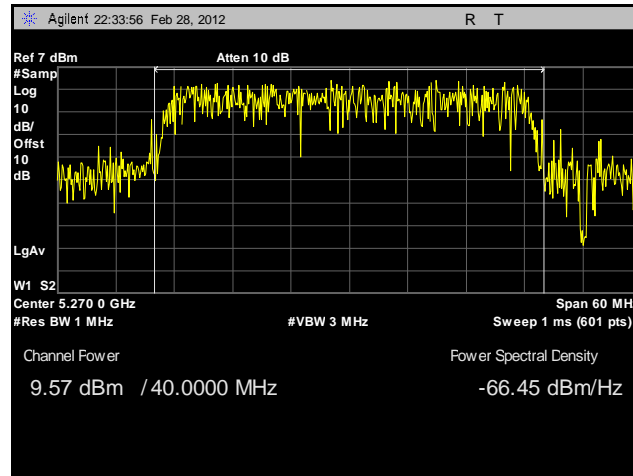

Plot 114. Conducted Output Power, 802.11n 40 MHz, Port A, 5270 MHz, Sector Antenna

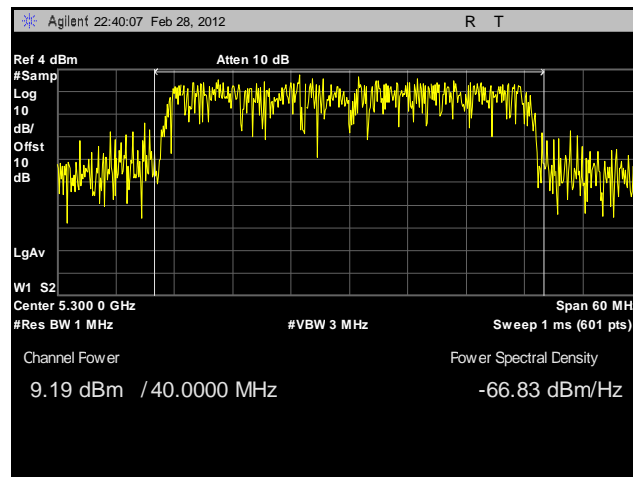

Plot 115. Conducted Output Power, 802.11n 40 MHz, Port A, 5300 MHz, Sector Antenna

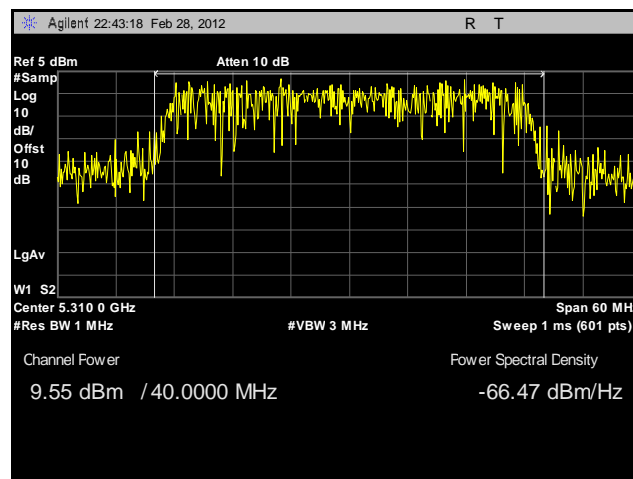

Plot 116. Conducted Output Power, 802.11n 40 MHz, Port A, 5310 MHz, Sector Antenna

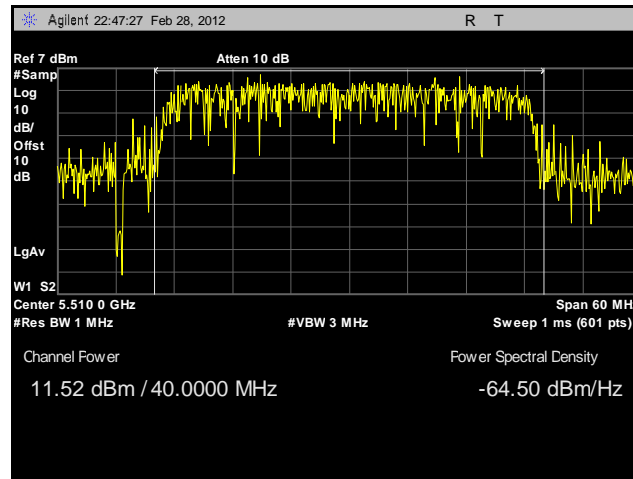

Plot 117. Conducted Output Power, 802.11n 40 MHz, Port A, 5510 MHz, Sector Antenna

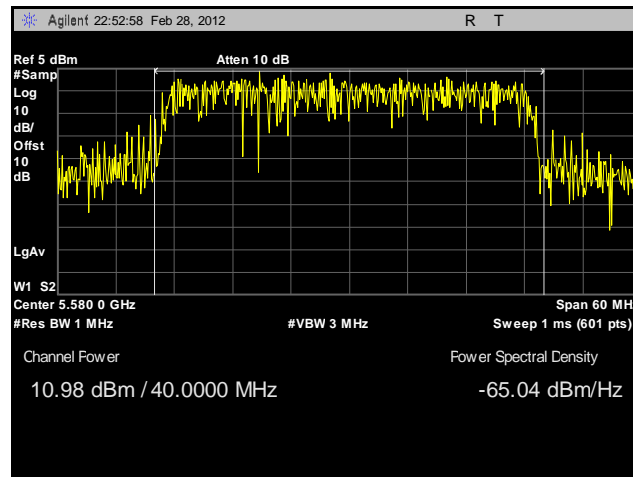

Plot 118. Conducted Output Power, 802.11n 40 MHz, Port A, 5580 MHz, Sector Antenna

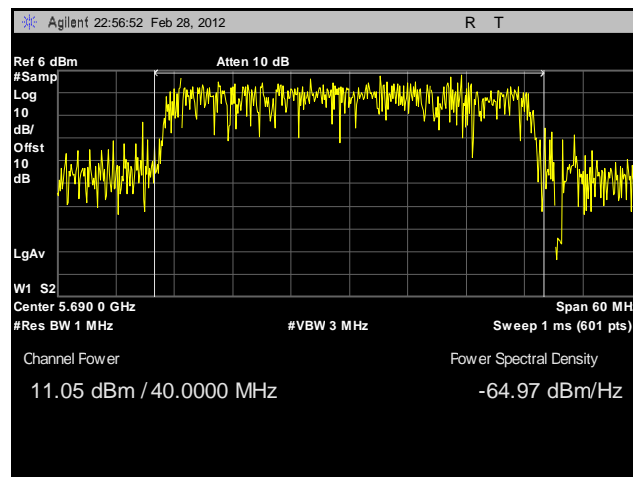

Plot 119. Conducted Output Power, 802.11n 40 MHz, Port A, 5690 MHz, Sector Antenna

### Conducted Output Power, 802.11n 40 MHz, Port B, Sector Antenna

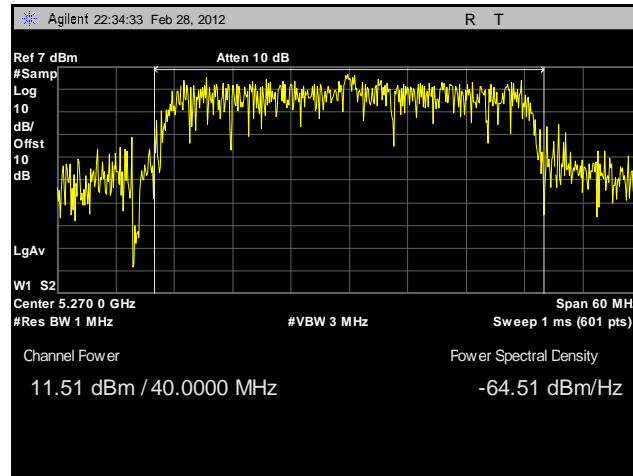

Plot 120. Conducted Output Power, 802.11n 40 MHz, Port B, 5270 MHz, Sector Antenna

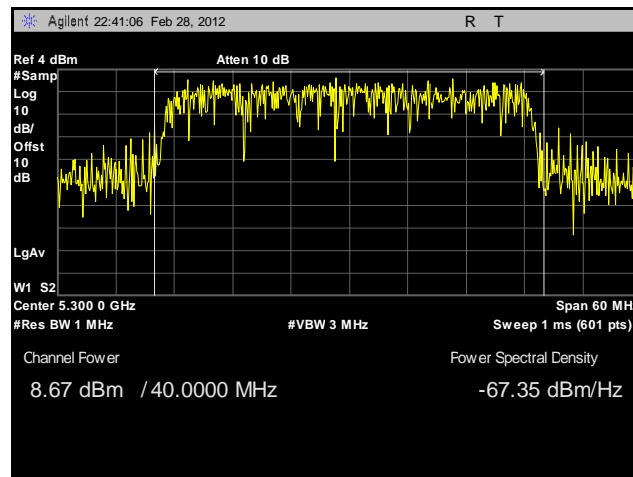

Plot 121. Conducted Output Power, 802.11n 40 MHz, Port B, 5300 MHz, Sector Antenna

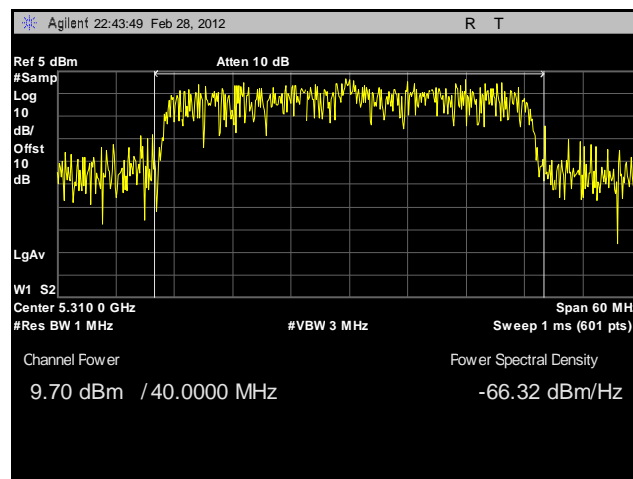

Plot 122. Conducted Output Power, 802.11n 40 MHz, Port B, 5310 MHz, Sector Antenna

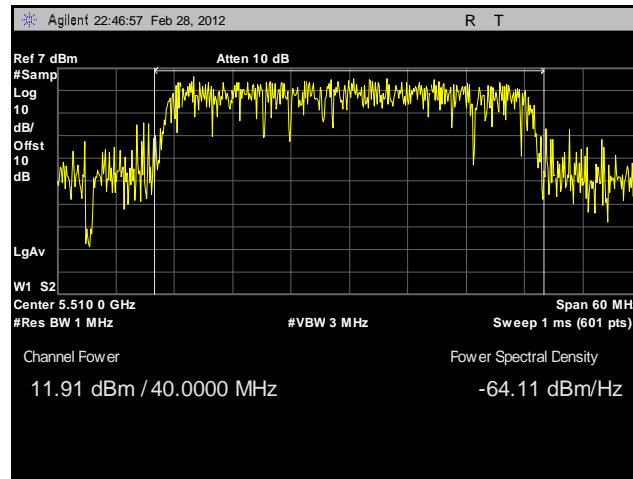

**Plot 123. Conducted Output Power, 802.11n 40 MHz, Port B, 5510 MHz, Sector Antenna**

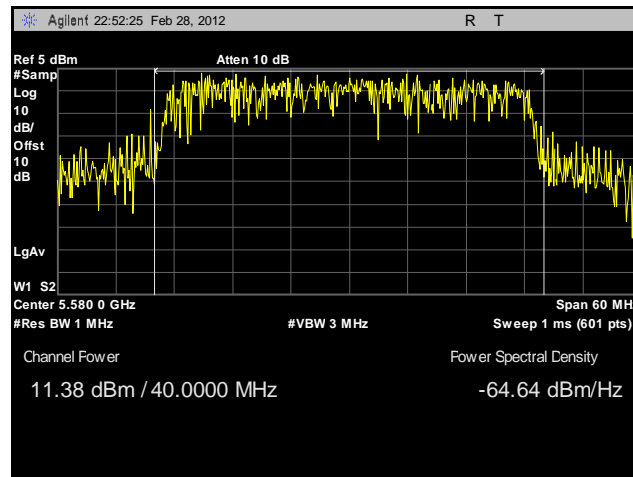

**Plot 124. Conducted Output Power, 802.11n 40 MHz, Port B, 5580 MHz, Sector Antenna**

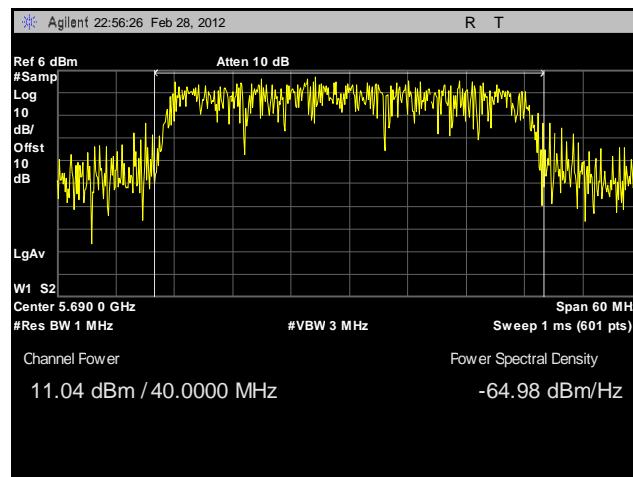

**Plot 125. Conducted Output Power, 802.11n 40 MHz, Port B, 5690 MHz, Sector Antenna**

## Electromagnetic Compatibility Criteria for Intentional Radiators

### § 15.407(a)(1), (a)(2) Peak Power Spectral Density

- Test Requirements:** § 15.407(a)(1), (a)(2): For digitally modulated systems, the conducted peak power spectral density from the intentional radiator to the antenna shall not be greater than 4dBm/MHz in the frequency band 5.15-5.25 GHz and 11dBm/MHz in the frequency band 5.25-5.35GHz.
- Test Procedure:** The transmitter was connected directly to a Spectrum Analyzer through an attenuator. The power level was set to the maximum level on the EUT. The RBW was set to 1MHz and the VBW was set to 3MHz. The method of measurement SA-1 from 789033 D01 UNII General Test Procedures v01 was used.
- Test Results:** Equipment complies with the peak power spectral density limits of § 15.407(a)(1), (a)(2). The peak power spectral density was determined from plots on the following page(s).
- Test Engineer(s):** Jeff Pratt
- Test Date(s):** 09/09/11

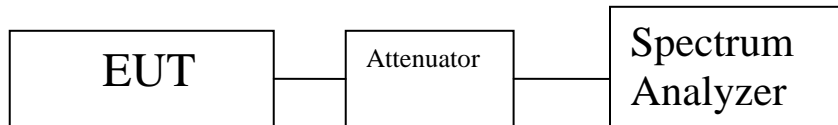

Figure 3. Peak Power Spectral Density Test Setup

Channel (MHz)	Mode/Modulation Type	Port 1A Spectral Density (dBm)	Port 1A Spectral Density (mW)	Port 1B Spectral Density (dBm)	Port 1B Spectral Density (mW)	Summed Spectral Density (mW)	Summed Spectral Density (dBm)	Antenna Gain (dBi)	Limit (dBm)	Margin (dB)
5260	802.11a	6.662	4.636604	-	-	4.636604	6.662	10	7	-0.338
5300	802.11a	6.669	4.644083	-	-	4.644083	6.669	10	7	-0.331
5320	802.11a	6.723	4.702188	-	-	4.702188	6.723	10	7	-0.277
5500	802.11a	6.674	4.649433	-	-	4.649433	6.674	10	7	-0.326
5580	802.11a	6.715	4.693534	-	-	4.693534	6.715	10	7	-0.285
5700	802.11a	5.458	3.513986	-	-	3.513986	5.458	10	7	-1.542
5260	802.11n HT20	2.733	1.87629	4.722	2.966197	4.842487	6.850685	10	7	-0.14932
5300	802.11n HT20	3.145	2.063004	4.589	2.876736	4.93974	6.937041	10	7	-0.06296
5320	802.11n HT20	2.579	1.810923	4.122	2.58345	4.394373	6.428969	10	7	-0.57103
5500	802.11n HT20	3.238	2.107657	3.635	2.309404	4.417062	6.451335	10	7	-0.54867
5580	802.11n HT20	3.542	2.260477	3.776	2.385613	4.64609	6.670876	10	7	-0.32912
5700	802.11n HT20	3.47	2.22331	2.833	1.919995	4.143304	6.173468	10	7	-0.82653
5270	802.11n HT40	2.02	1.592209	4.299	2.690915	4.283124	6.317606	10	7	-0.68239
5300	802.11n HT40	2.169	1.647783	2.535	1.792669	3.440451	5.366154	10	7	-1.63385
5310	802.11n HT40	2.281	1.69083	1.973	1.575071	3.265901	5.14003	10	7	-1.85997
5510	802.11n HT40	1.932	1.560271	3.601	2.291395	3.851666	5.856486	10	7	-1.14351
5580	802.11n HT40	1.828	1.523351	2.149	1.640212	3.163563	5.001765	10	7	-1.99823
5690	802.11n HT40	-0.863	0.819785	0.045	1.010416	1.830201	2.624987	10	7	-4.37501

**Table 22. Power Spectral Density, 802.11a, Test Results**

Channel (MHz)	Mode/Modulation Type	Port 1A Spectral Density (dBm)	Port 1A Spectral Density (mW)	Port 1B Spectral Density (dBm)	Port 1B Spectral Density (mW)	Summed Spectral Density (mW)	Summed Spectral Density (dBm)	Antenna Gain (dBi)	Limit (dBm)	Margin (dB)
5260	802.11a	0.298	1.071026			1.071026	0.298	15.5	1.5	-1.202
5300	802.11a	0.729	1.182769			1.182769	0.729	15.5	1.5	-0.771
5320	802.11a	0.567	1.139462			1.139462	0.567	15.5	1.5	-0.933
5500	802.11a	1.055	1.27497			1.27497	1.055	15.5	1.5	-0.445
5580	802.11a	1.02	1.264736			1.264736	1.02	15.5	1.5	-0.48
5700	802.11a	0.6	1.148154			1.148154	0.6	15.5	1.5	-0.9
5260	802.11n HT20	-2.53	0.55847	-2.416	0.573324	1.131794	0.537674	15.5	1.5	-0.96233
5300	802.11n HT20	-2.366	0.579963	-1.79	0.662217	1.242179	0.941842	15.5	1.5	-0.55816
5320	802.11n HT20	-2.532	0.558213	-1.989	0.632557	1.190771	0.758281	15.5	1.5	-0.74172
5500	802.11n HT20	-3.405	0.456562	-0.255	0.942975	1.399537	1.459843	15.5	1.5	-0.04016
5580	802.11n HT20	-3.476	0.449159	-1.417	0.721606	1.170765	0.684696	15.5	1.5	-0.8153
5700	802.11n HT20	-2.222	0.599515	-2.029	0.626758	1.226273	0.885872	15.5	1.5	-0.61413
5270	802.11n HT40	-3.925	0.405042	-1.459	0.714661	1.119703	0.491028	15.5	1.5	-1.00897
5300	802.11n HT40	-5.198	0.302134	-1.185	0.761202	1.063336	0.266707	15.5	1.5	-1.23329
5310	802.11n HT40	-5.018	0.31492	-0.546	0.881861	1.196781	0.780145	15.5	1.5	-0.71985
5510	802.11n HT40	-3.062	0.494083	-0.805	0.830807	1.32489	1.221798	15.5	1.5	-0.2782
5580	802.11n HT40	-2.884	0.514754	-0.656	0.859805	1.374559	1.381635	15.5	1.5	-0.11836
5690	802.11n HT40	-2.975	0.504081	-1.693	0.677174	1.181254	0.723434	15.5	1.5	-0.77657

**Table 23. Power Spectral Density, 802.11a, Test Results, Sector Antenna**

## Peak Power Spectral Density, 802.11a

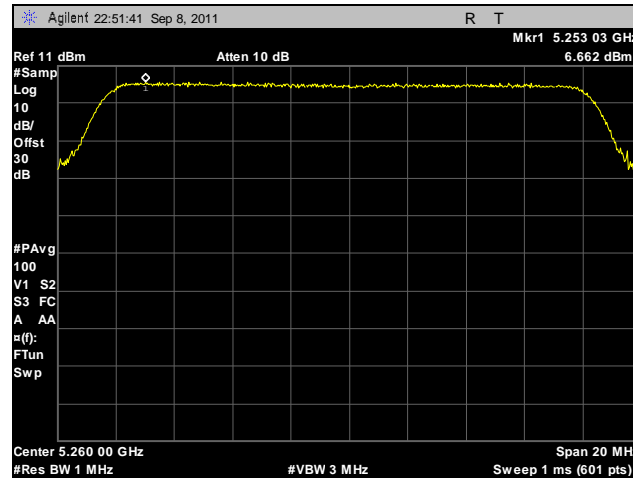

Plot 126. Peak Spectral Density, 802.11a, 5260 MHz

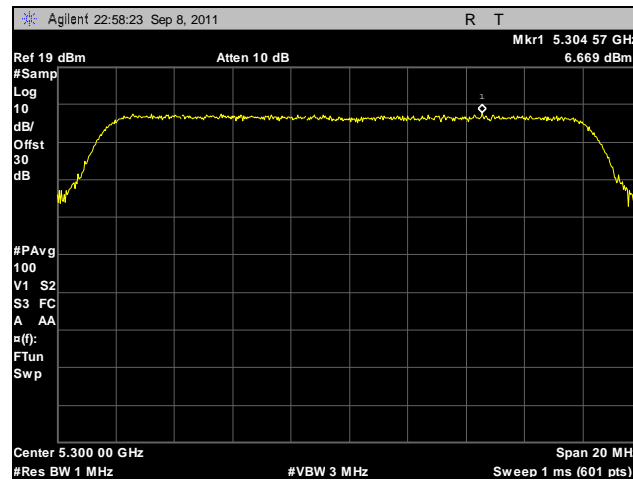

Plot 127. Peak Spectral Density, 802.11a, 5300 MHz

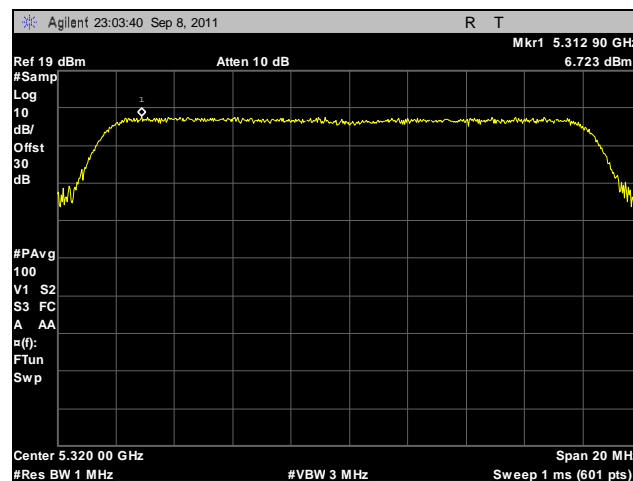

Plot 128. Peak Spectral Density, 802.11a, 5320 MHz



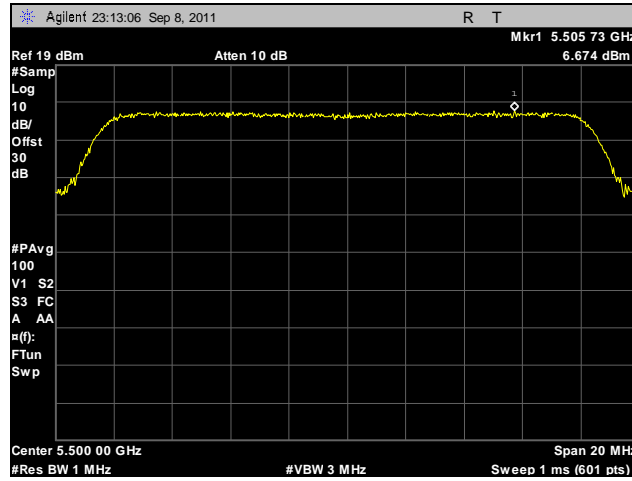

**Plot 129. Peak Spectral Density, 802.11a, 5500 MHz**

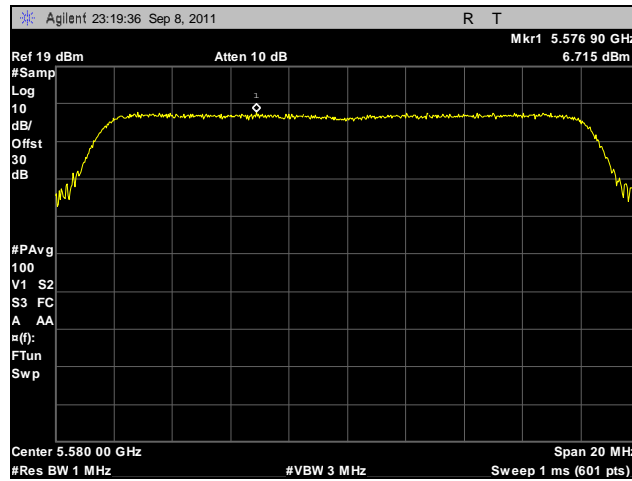

**Plot 130. Peak Spectral Density, 802.11a, 5580 MHz**

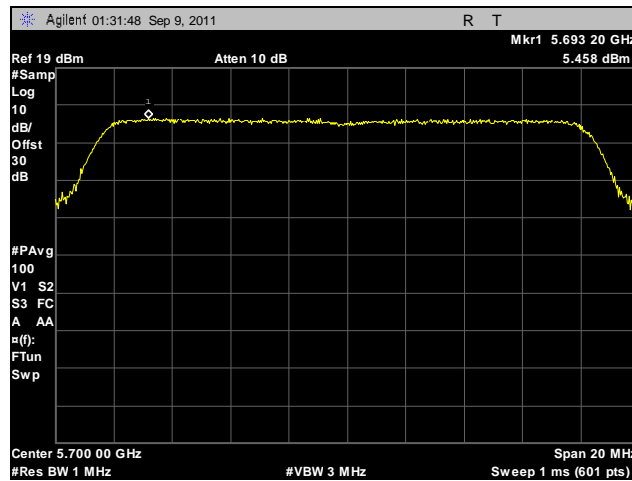

**Plot 131. Peak Spectral Density, 802.11a, 5700 MHz**

### Peak Power Spectral Density, 802.11n 20 MHz, Port A

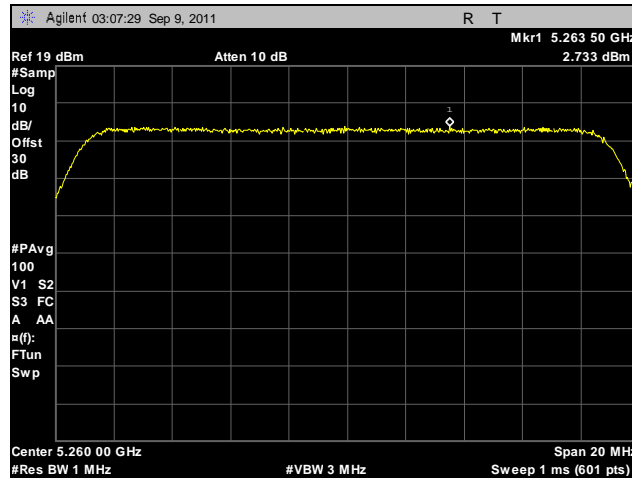

Plot 132. Peak Spectral Density, 802.11n 20 MHz, Port A, 5260 MHz

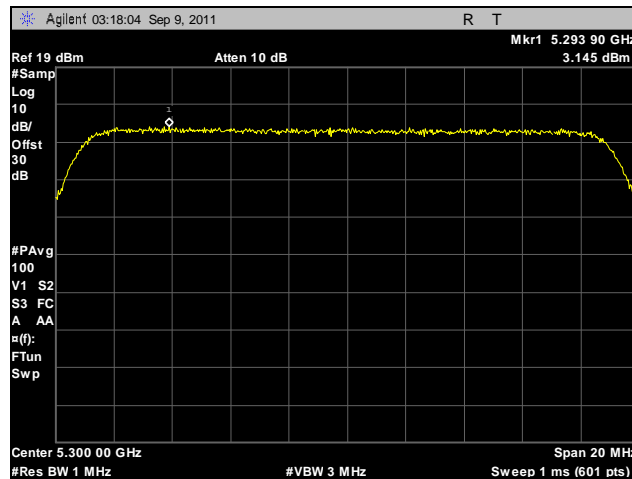

Plot 133. Peak Spectral Density, 802.11n 20 MHz, Port A, 5300 MHz

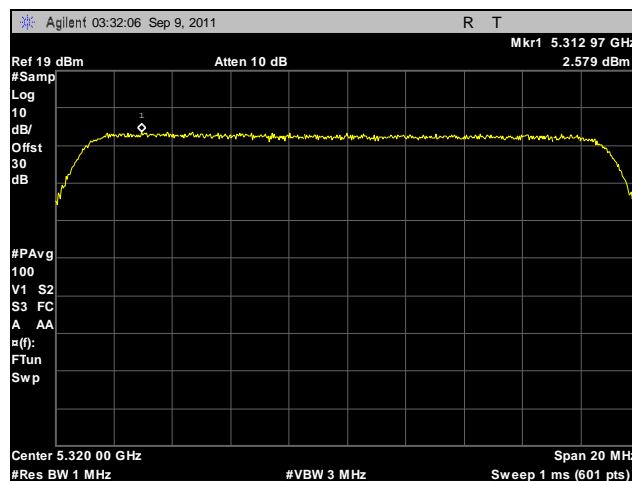

Plot 134. Peak Spectral Density, 802.11n 20 MHz, Port A, 5320 MHz

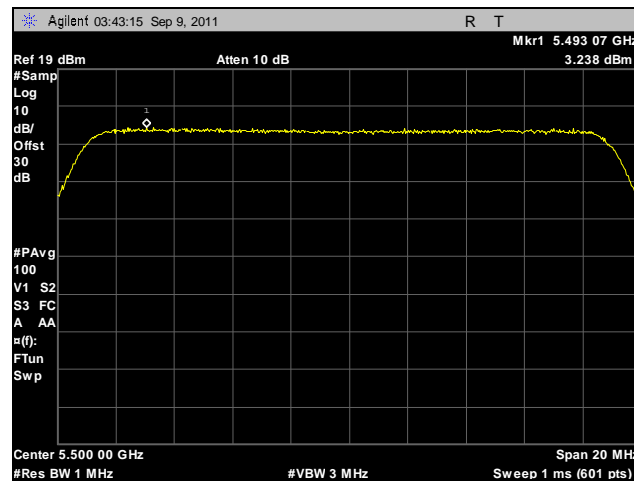

Plot 135. Peak Spectral Density, 802.11n 20 MHz, Port A, 5500 MHz

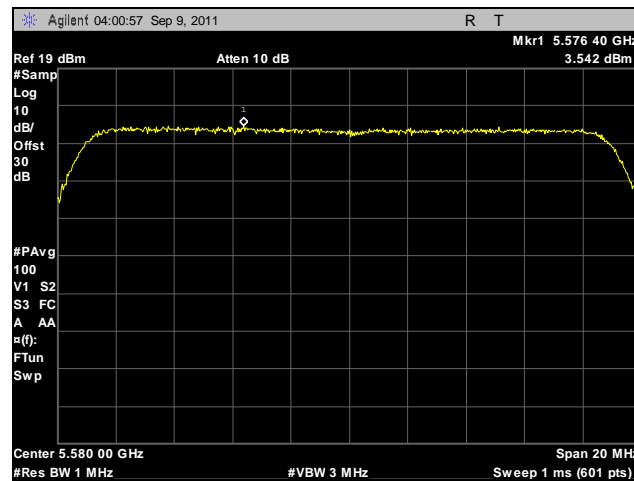

Plot 136. Peak Spectral Density, 802.11n 20 MHz, Port A, 5580 MHz

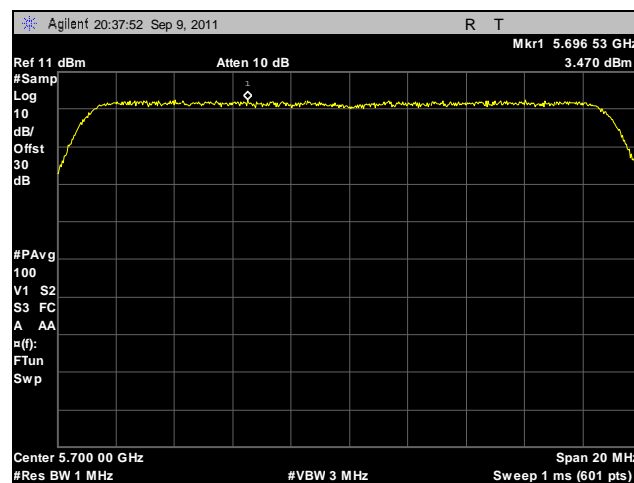

Plot 137. Peak Spectral Density, 802.11n 20 MHz, Port A, 5700 MHz

**Peak Power Spectral Density, 802.11n 20 MHz, Port B**

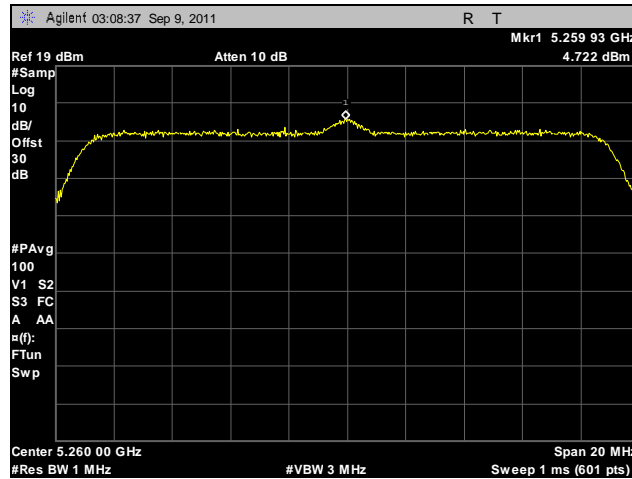

**Plot 138. Peak Spectral Density, 802.11n 20 MHz, Port B, 5260 MHz**

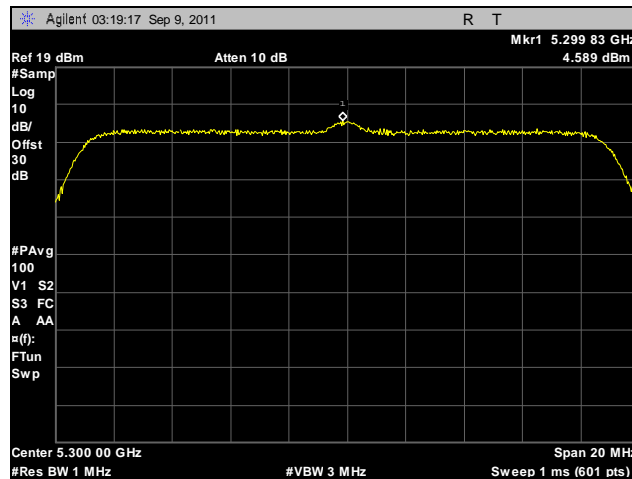

**Plot 139. Peak Spectral Density, 802.11n 20 MHz, Port B, 5300 MHz**

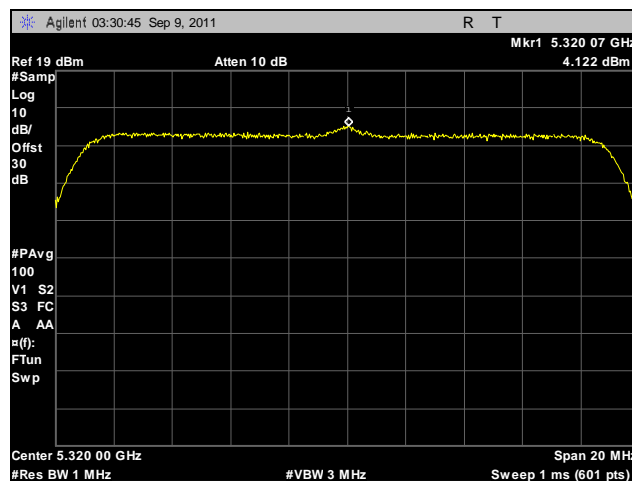

**Plot 140. Peak Spectral Density, 802.11n 20 MHz, Port B, 5320 MHz**

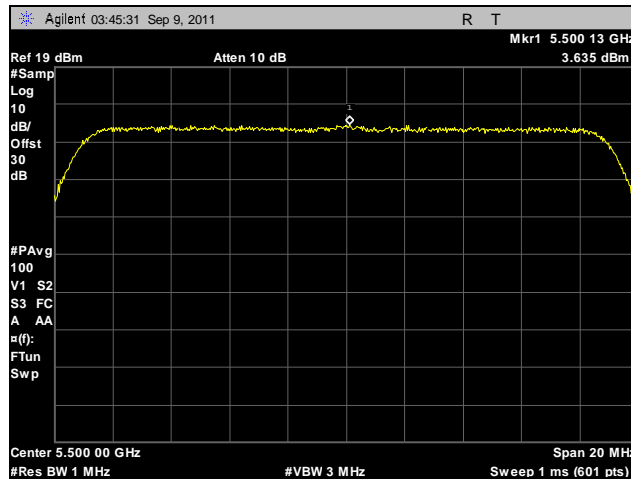

Plot 141. Peak Spectral Density, 802.11n 20 MHz, Port B, 5500 MHz

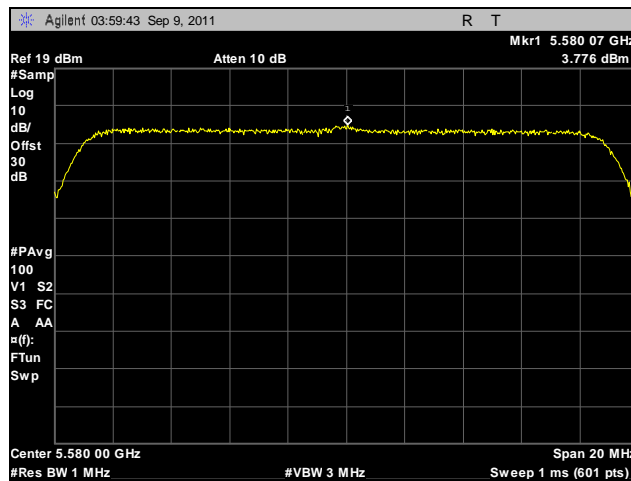

Plot 142. Peak Spectral Density, 802.11n 20 MHz, Port B, 5580 MHz

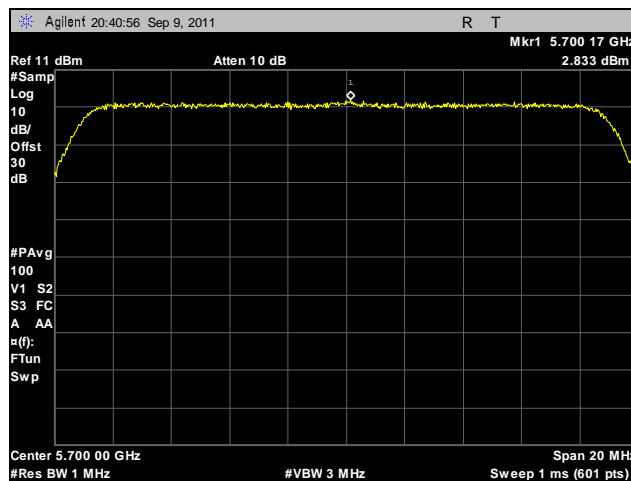

Plot 143. Peak Spectral Density, 802.11n 20 MHz, Port B, 5700 MHz

## Peak Power Spectral Density, 802.11n 40 MHz, Port A

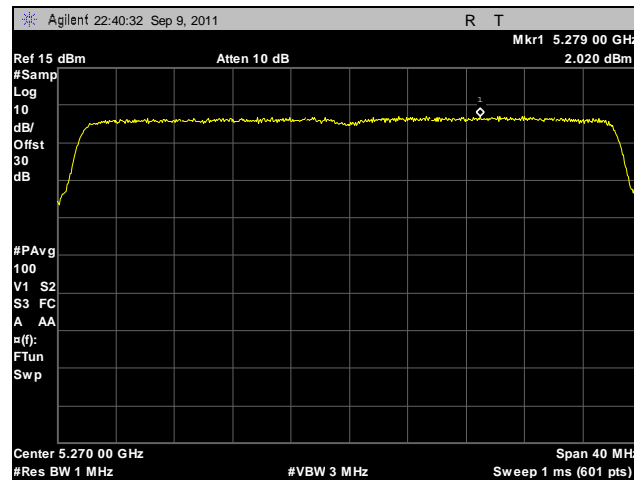

Plot 144. Peak Spectral Density, 802.11n 40 MHz, Port A, 5270 MHz

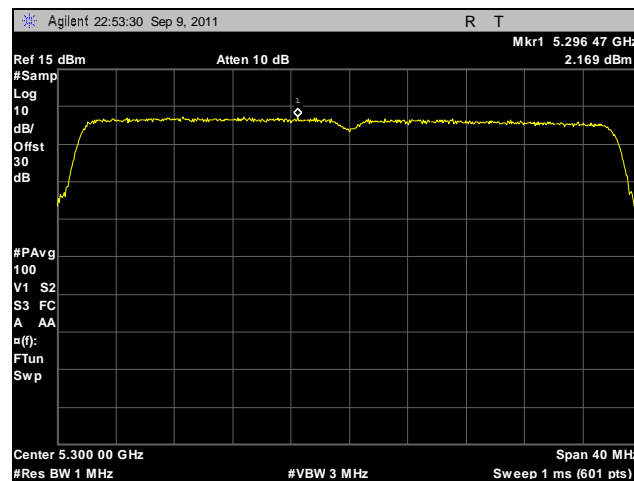

Plot 145. Peak Spectral Density, 802.11n 40 MHz, Port A, 5300 MHz

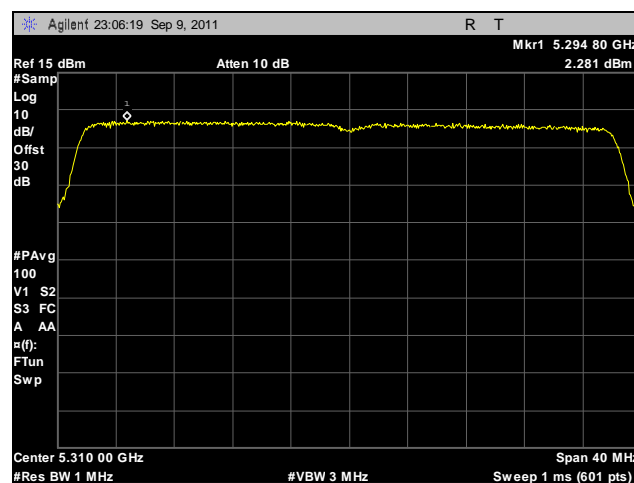

Plot 146. Peak Spectral Density, 802.11n 40 MHz, Port A, 5310 MHz

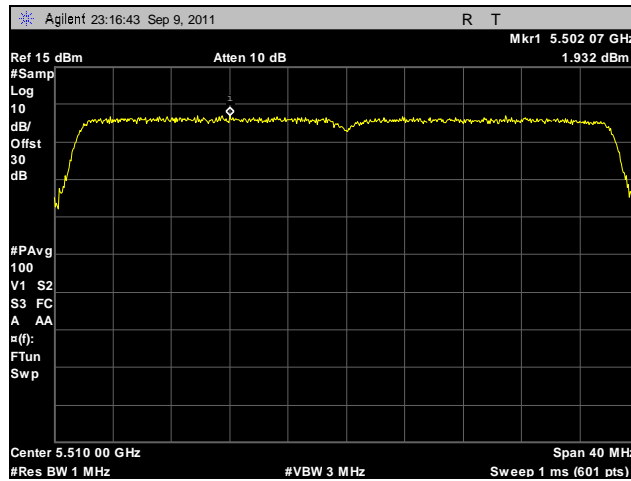

Plot 147. Peak Spectral Density, 802.11n 40 MHz, Port A, 5510 MHz

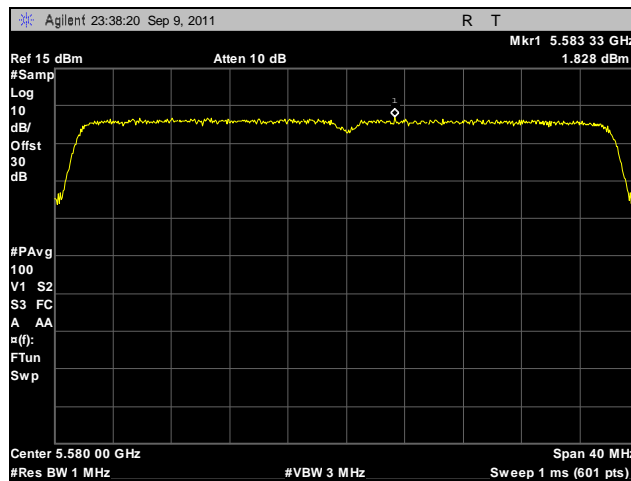

Plot 148. Peak Spectral Density, 802.11n 40 MHz, Port A, 5580 MHz

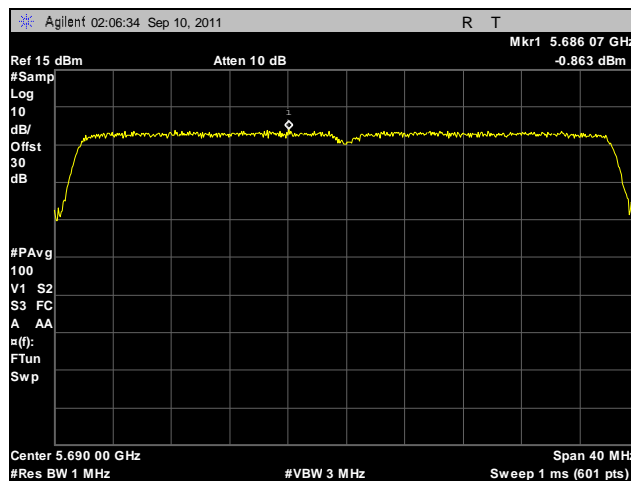

Plot 149. Peak Spectral Density, 802.11n 40 MHz, Port A, 5690 MHz

### Peak Power Spectral Density, 802.11n 40 MHz, Port B

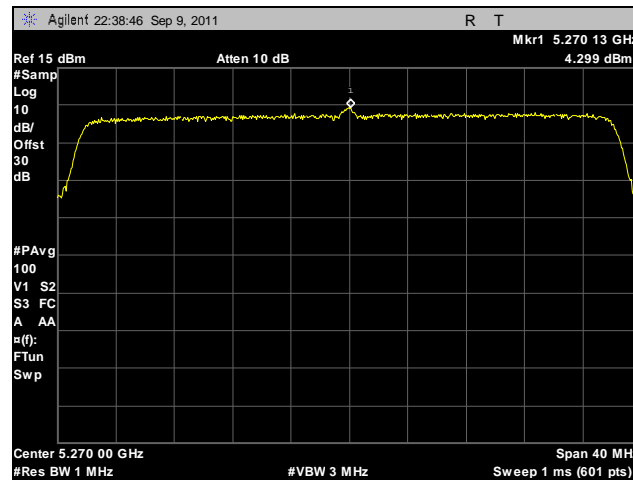

Plot 150. Peak Spectral Density, 802.11n 40 MHz, Port B, 5270 MHz

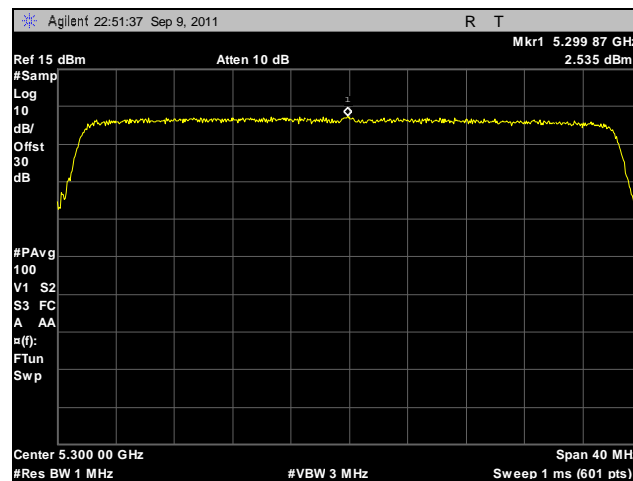

Plot 151. Peak Spectral Density, 802.11n 40 MHz, Port B, 5300 MHz

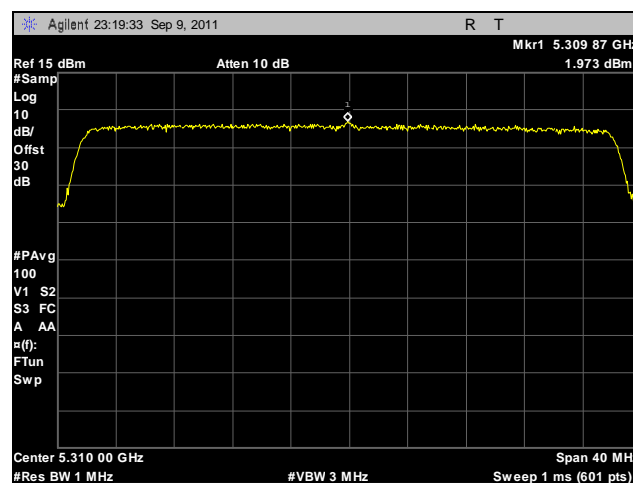

Plot 152. Peak Spectral Density, 802.11n 40 MHz, Port B, 5310 MHz



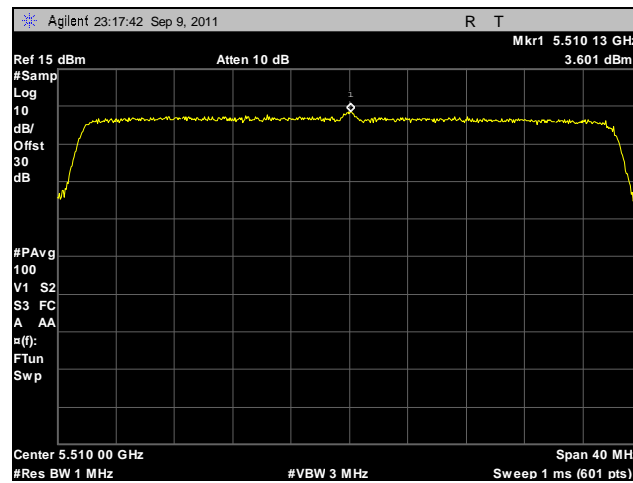

Plot 153. Peak Spectral Density, 802.11n 40 MHz, Port B, 5510 MHz

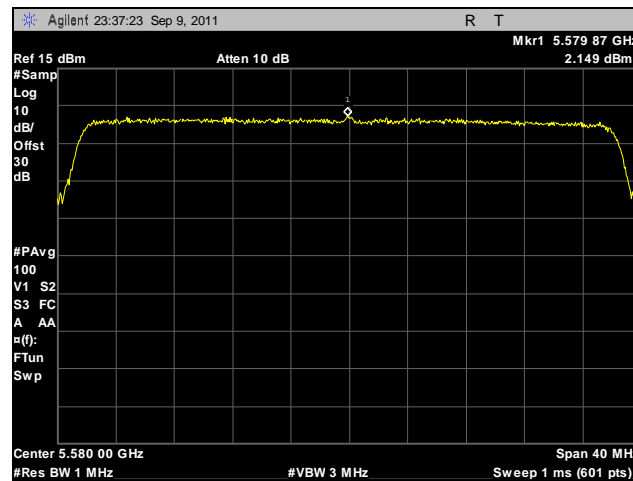

Plot 154. Peak Spectral Density, 802.11n 40 MHz, Port B, 5580 MHz

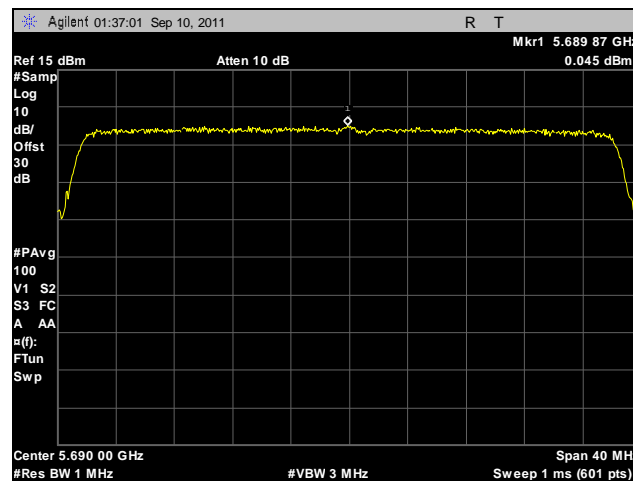

Plot 155. Peak Spectral Density, 802.11n 40 MHz, Port B, 5690 MHz

## Peak Power Spectral Density, 802.11a, Sector Antenna

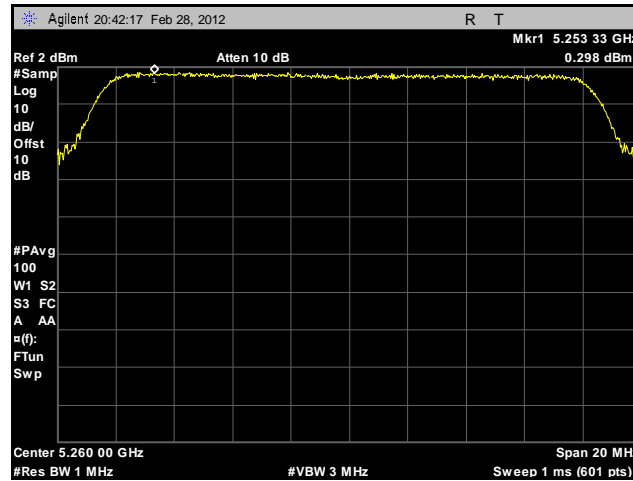

Plot 156. Peak Spectral Density, 802.11a, 5260 MHz, Sector Antenna

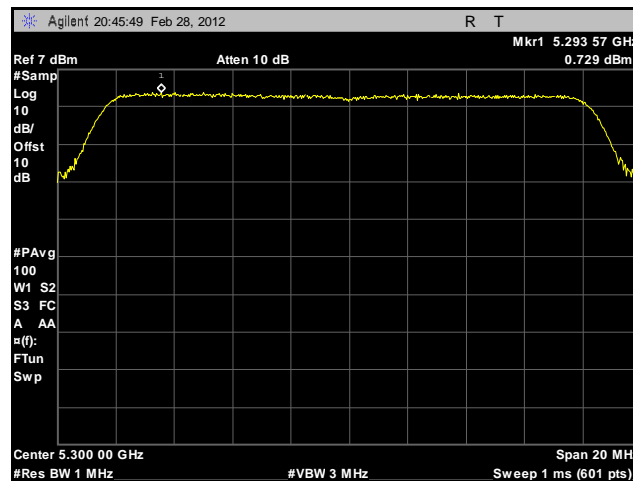

Plot 157. Peak Spectral Density, 802.11a, 5300 MHz, Sector Antenna

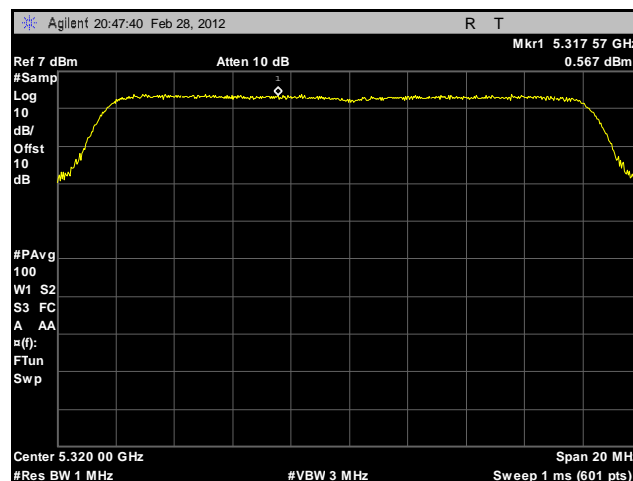

Plot 158. Peak Spectral Density, 802.11a, 5320 MHz, Sector Antenna

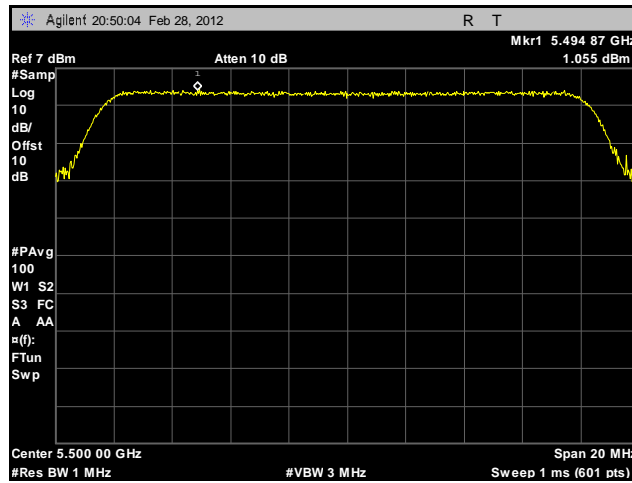

Plot 159. Peak Spectral Density, 802.11a, 5500 MHz, Sector Antenna

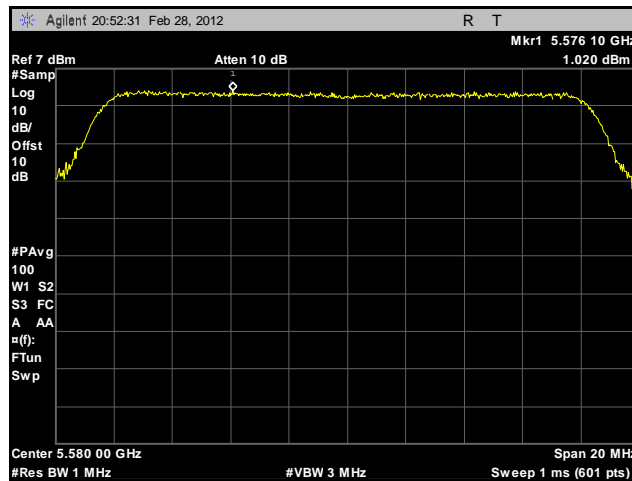

Plot 160. Peak Spectral Density, 802.11a, 5580 MHz, Sector Antenna

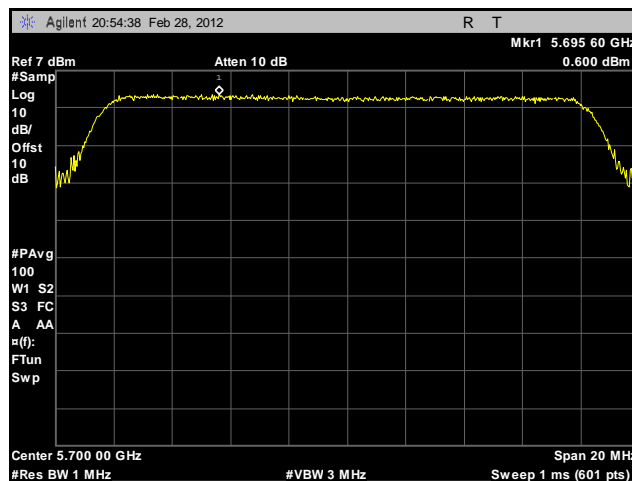

Plot 161. Peak Spectral Density, 802.11a, 5700 MHz, Sector Antenna

**Peak Power Spectral Density, 802.11n 20 MHz, Port A, Sector Antenna**

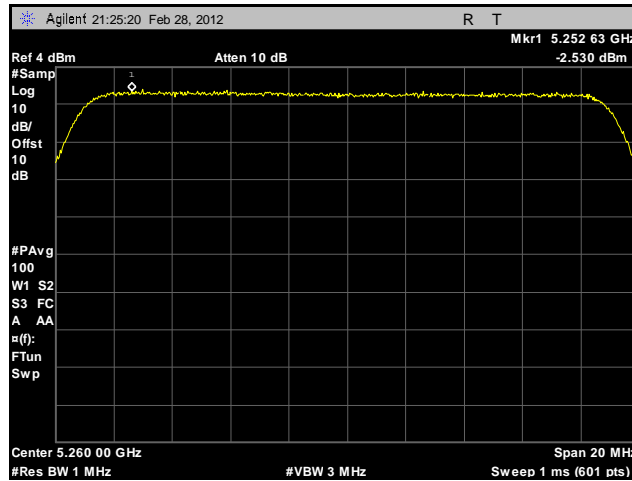

**Plot 162. Peak Spectral Density, 802.11n 20 MHz, Port A, 5260 MHz, Sector Antenna**

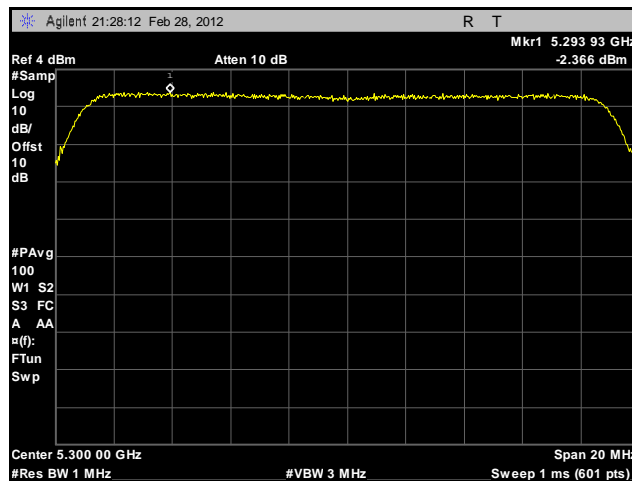

**Plot 163. Peak Spectral Density, 802.11n 20 MHz, Port A, 5300 MHz, Sector Antenna**

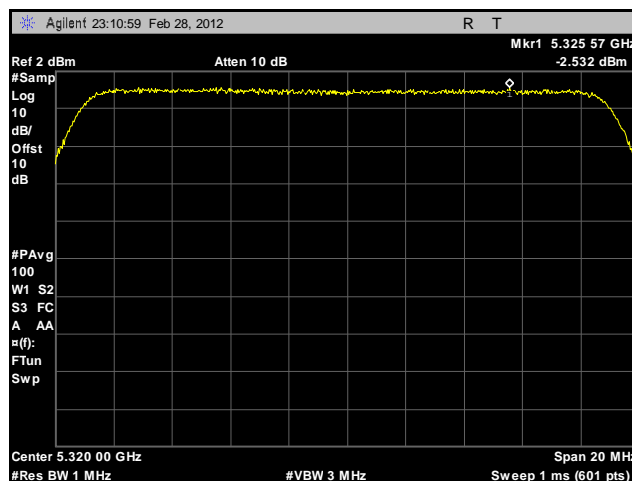

**Plot 164. Peak Spectral Density, 802.11n 20 MHz, Port A, 5320 MHz, Sector Antenna**

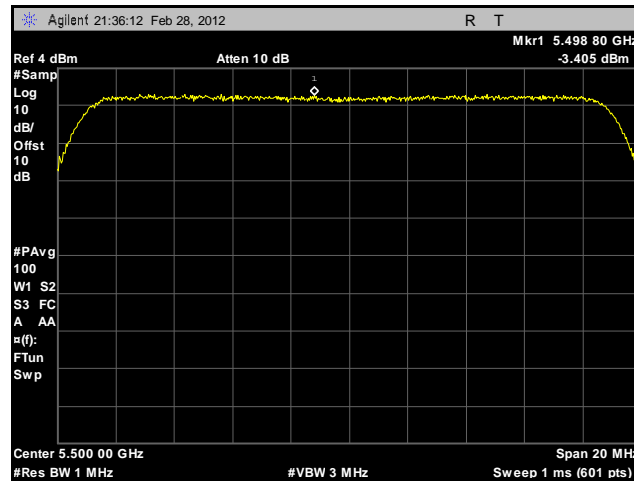

Plot 165. Peak Spectral Density, 802.11n 20 MHz, Port A, 5500 MHz, Sector Antenna

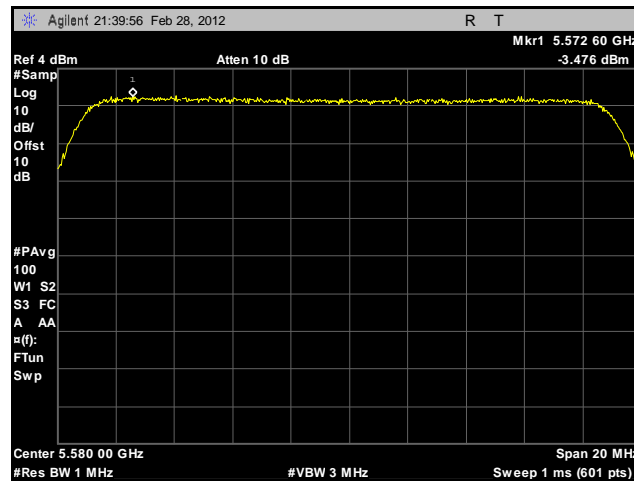

Plot 166. Peak Spectral Density, 802.11n 20 MHz, Port A, 5580 MHz, Sector Antenna

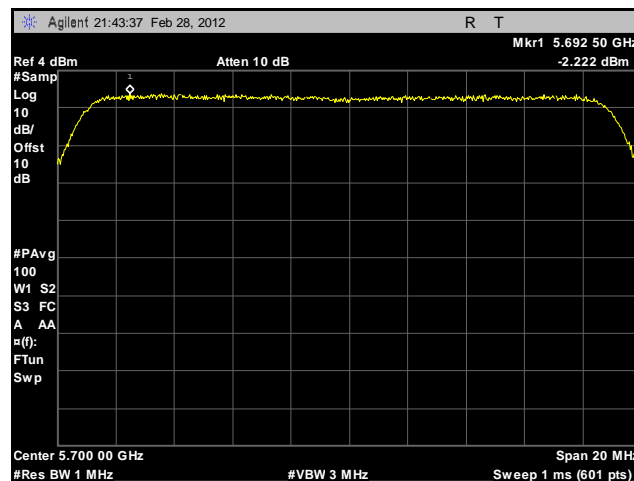

Plot 167. Peak Spectral Density, 802.11n 20 MHz, Port A, 5700 MHz, Sector Antenna

**Peak Power Spectral Density, 802.11n 20 MHz, Port B, Sector Antenna**

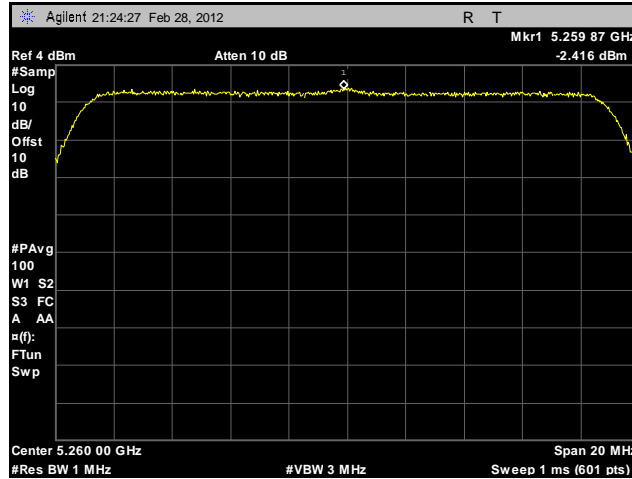

**Plot 168. Peak Spectral Density, 802.11n 20 MHz, Port B, 5260 MHz, Sector Antenna**

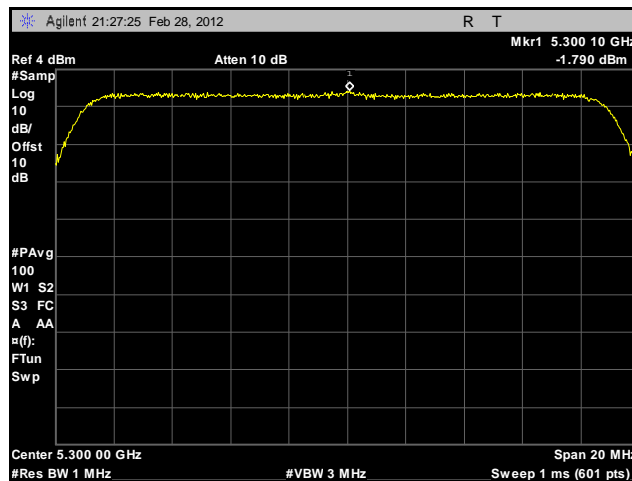

**Plot 169. Peak Spectral Density, 802.11n 20 MHz, Port B, 5300 MHz, Sector Antenna**

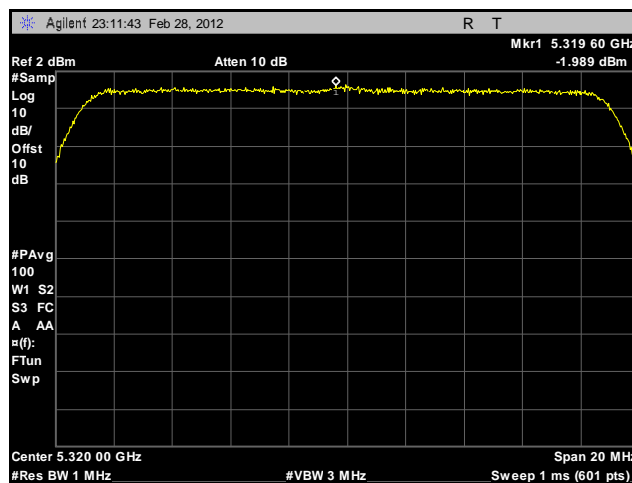

**Plot 170. Peak Spectral Density, 802.11n 20 MHz, Port B, 5320 MHz, Sector Antenna**

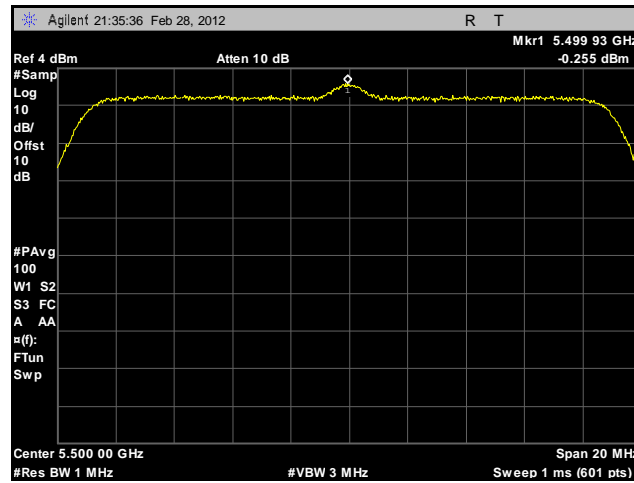

Plot 171. Peak Spectral Density, 802.11n 20 MHz, Port B, 5500 MHz, Sector Antenna

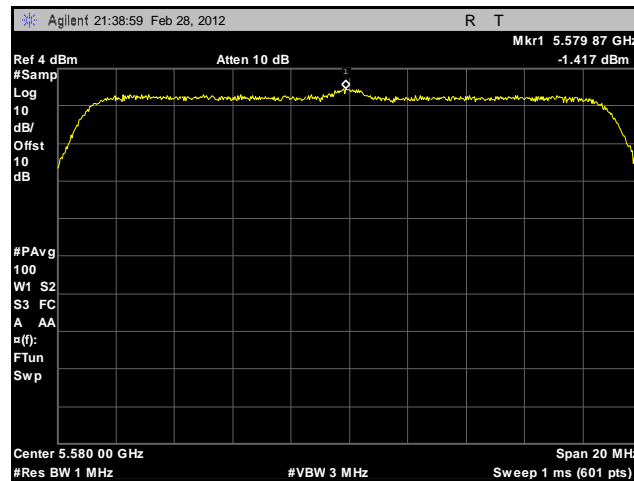

Plot 172. Peak Spectral Density, 802.11n 20 MHz, Port B, 5580 MHz, Sector Antenna

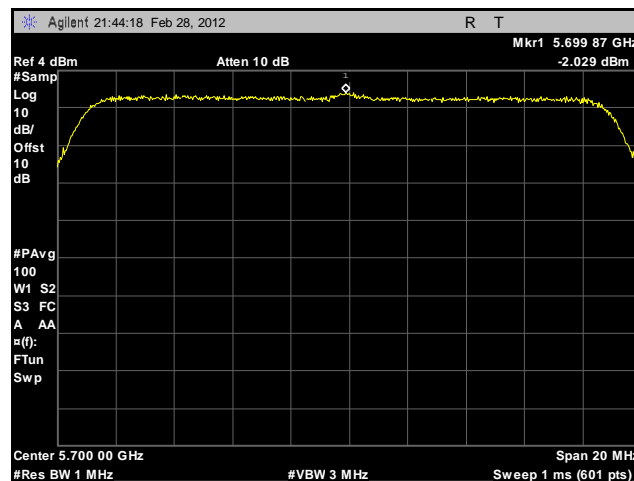

Plot 173. Peak Spectral Density, 802.11n 20 MHz, Port B, 5700 MHz, Sector Antenna

**Peak Power Spectral Density, 802.11n 40 MHz, Port A, Sector Antenna**

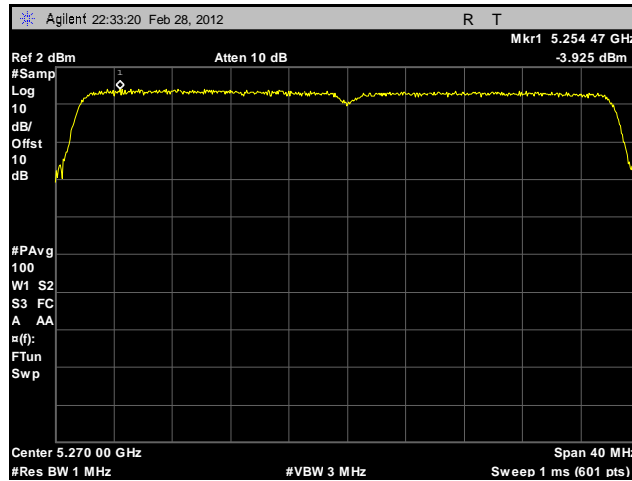

**Plot 174. Peak Spectral Density, 802.11n 40 MHz, Port A, 5270 MHz, Sector Antenna**

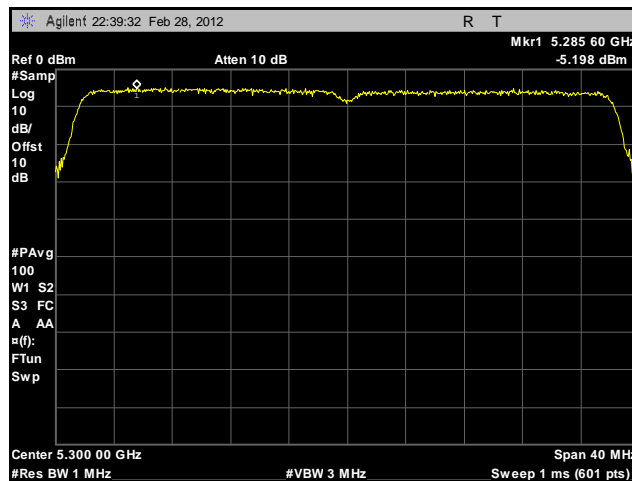

**Plot 175. Peak Spectral Density, 802.11n 40 MHz, Port A, 5300 MHz, Sector Antenna**

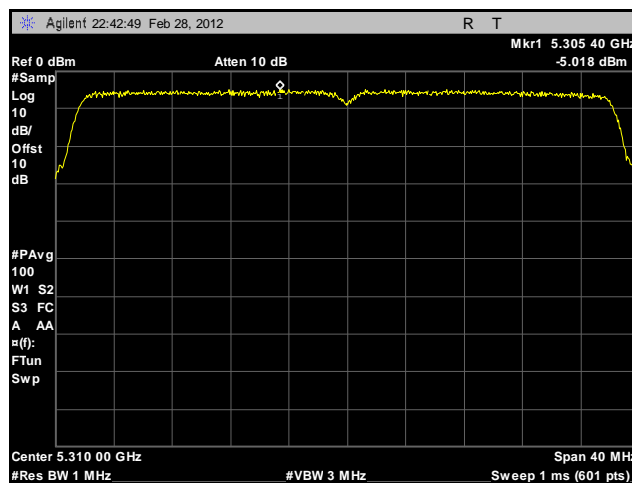

**Plot 176. Peak Spectral Density, 802.11n 40 MHz, Port A, 5310 MHz, Sector Antenna**



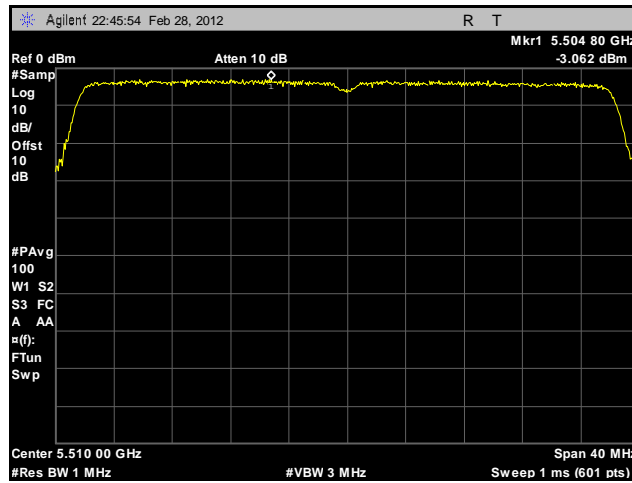

Plot 177. Peak Spectral Density, 802.11n 40 MHz, Port A, 5510 MHz, Sector Antenna

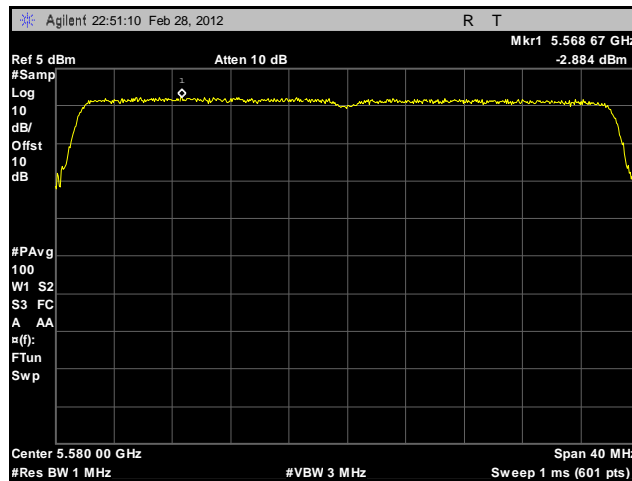

Plot 178. Peak Spectral Density, 802.11n 40 MHz, Port A, 5580 MHz, Sector Antenna

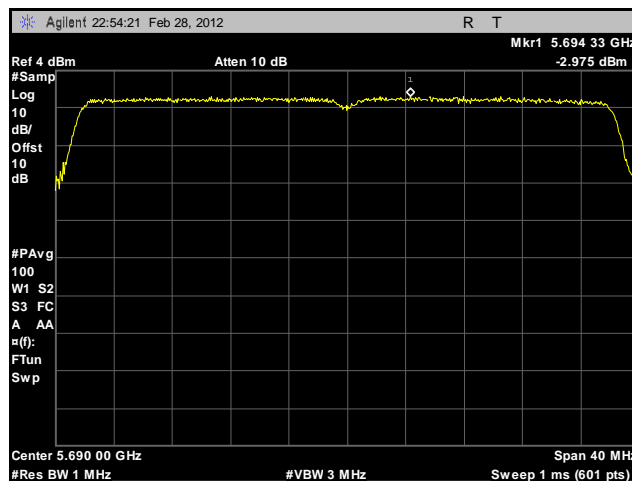

Plot 179. Peak Spectral Density, 802.11n 40 MHz, Port A, 5690 MHz, Sector Antenna

**Peak Power Spectral Density, 802.11n 40 MHz, Port B, Sector Antenna**

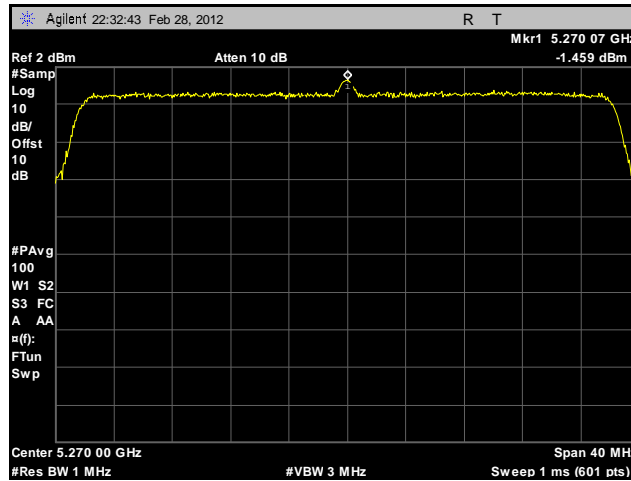

**Plot 180. Peak Spectral Density, 802.11n 40 MHz, Port B, 5270 MHz, Sector Antenna**

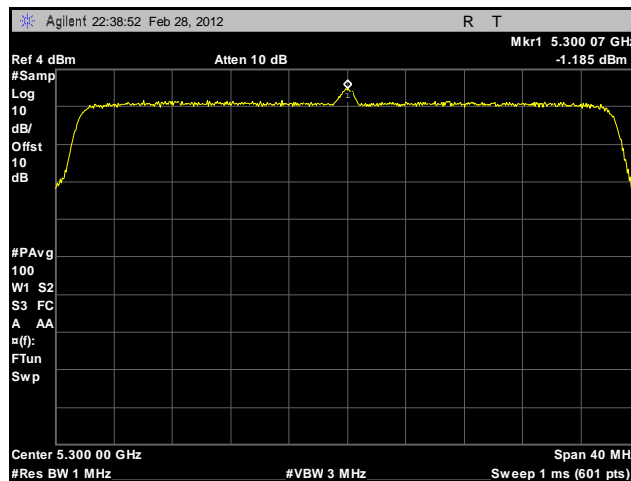

**Plot 181. Peak Spectral Density, 802.11n 40 MHz, Port B, 5300 MHz, Sector Antenna**

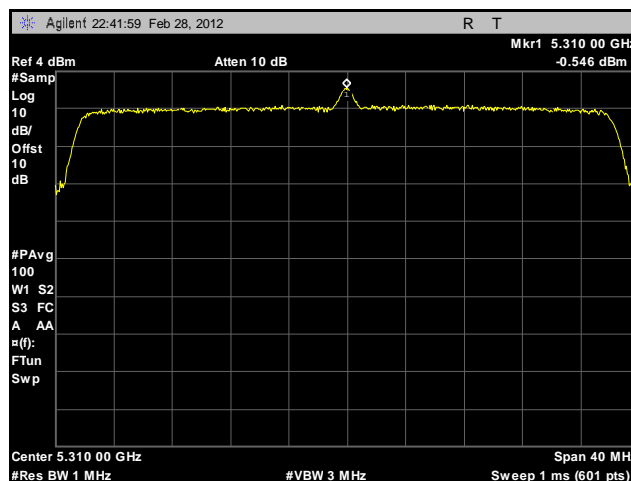

**Plot 182. Peak Spectral Density, 802.11n 40 MHz, Port B, 5310 MHz, Sector Antenna**

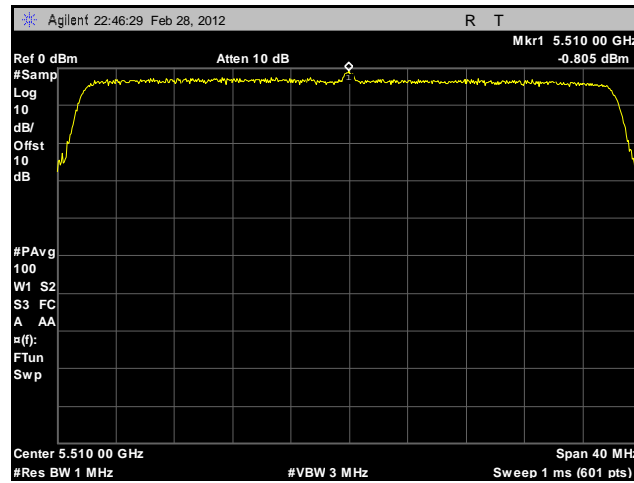

Plot 183. Peak Spectral Density, 802.11n 40 MHz, Port B, 5510 MHz, Sector Antenna

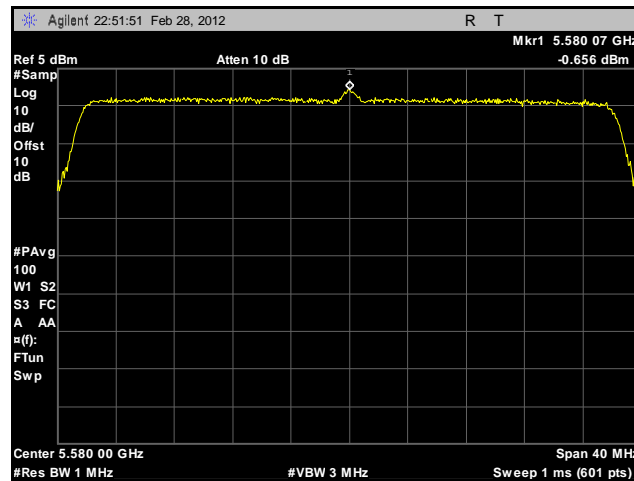

Plot 184. Peak Spectral Density, 802.11n 40 MHz, Port B, 5580 MHz, Sector Antenna

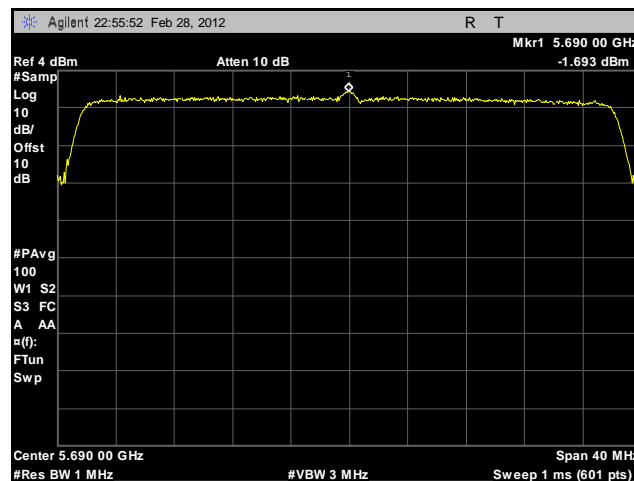

Plot 185. Peak Spectral Density, 802.11n 40 MHz, Port B, 5690 MHz, Sector Antenna

## Electromagnetic Compatibility Criteria for Intentional Radiators

### § 15.407(a)(6) Peak Excursion Ratio

**Test Requirements:** § 15.407(a)(6): For digitally modulated systems, the peak excursion of the modulation envelope to the peak transmit power shall not exceed 13dB across any 1MHz bandwidth of the emission bandwidth whichever is less.

**Test Procedure:** The method of measurement from 789033 D01 UNII General Test Procedures v01 was used. The EUT was connected directly to the spectrum analyzer through cabling and attenuation. The 1<sup>st</sup> trace on the spectrum analyzer was set to RBW=1MHz, VBW=3MHz. The peak detector mode was used and the trace max held. The 2<sup>nd</sup> trace on the spectrum analyzer was set to a RBW=1MHz, VBW=30 KHz. The detector mode was set to sample detector.

The Peak Excursion Ratio was determined from the difference between the maximum found in each trace.

**Test Results:** Equipment complies with the peak excursion ratio limits of § 15.407(a)(6). The peak excursion ratio was determined from plots on the following page(s).

**Test Engineer(s):** Jeff Pratt

**Test Date(s):** 09/09/11

Peak Excursion Ration				
Mode	Frequency (MHz)	Excursion Ratio (dB)	Limit (dBm)	Margin (dB)
802.11a	5260	10.362	13	2.638
	5300	11.082	13	1.918
	5320	10.408	13	2.592
	5500	10.747	13	2.253
	5580	10.025	13	2.975
	5700	9.917	13	3.083

**Table 24. Peak Excursion Ration, Test Results, 802.11a**

Peak Excursion Ration				
Mode	Frequency (MHz)	Excursion Ratio (dB)	Limit (dBm)	Margin (dB)
802.11n 20MHz Port A	5260	10.704	13	2.296
	5300	10.602	13	2.398
	5320	9.814	13	3.186
	5500	11.131	13	1.869
	5580	9.283	13	3.717
	5700	10.479	13	2.521
802.11n 20MHz Port B	5260	11.159	13	1.841
	5300	10.655	13	2.345
	5320	11.125	13	1.875
	5500	10.451	13	2.549
	5580	10.388	13	2.612
	5700	10.533	13	2.467

Table 25. Peak Excursion Ration, Test Results, 802.11n 20 MHz

Peak Excursion Ration				
Mode	Frequency (MHz)	Excursion Ratio (dB)	Limit (dBm)	Margin (dB)
802.11n 40MHz Port A	5270	9.893	13	3.107
	5300	10.235	13	2.765
	5310	10.126	13	2.874
	5510	10.016	13	2.984
	5580	10.202	13	2.798
	5690	10.376	13	2.624
802.11n 40MHz Port B	5270	11.093	13	1.907
	5300	10.201	13	2.799
	5310	10.112	13	2.888
	5510	11.228	13	1.772
	5580	11.197	13	1.803
	5690	10.047	13	2.953

Table 26. Peak Excursion Ration, Test Results, 802.11n 40 MHz

## Peak Excursion Ratio, 802.11a

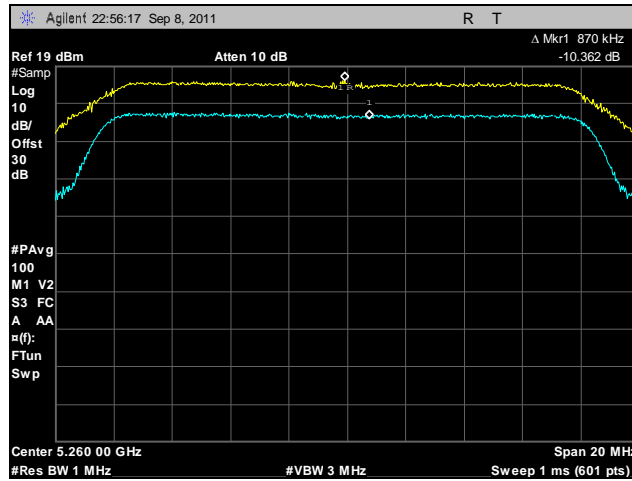

Plot 186. Peak Excursion, 802.11a, 5260 MHz

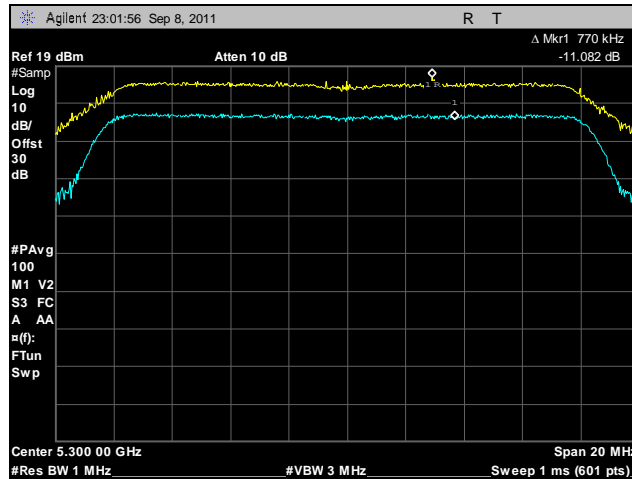

Plot 187. Peak Excursion, 802.11a, 5300 MHz

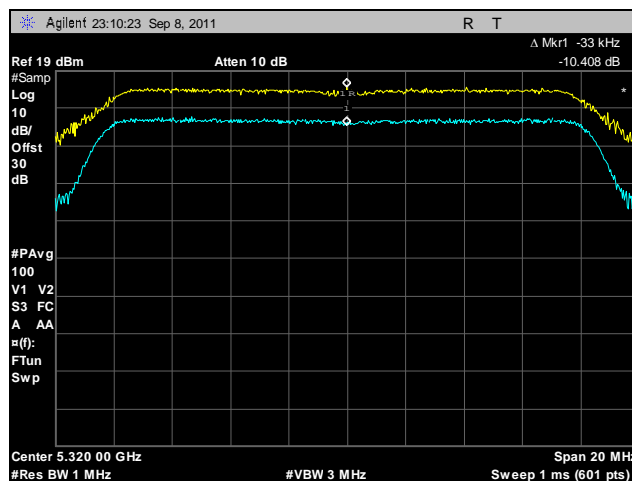

Plot 188. Peak Excursion, 802.11a, 5320 MHz

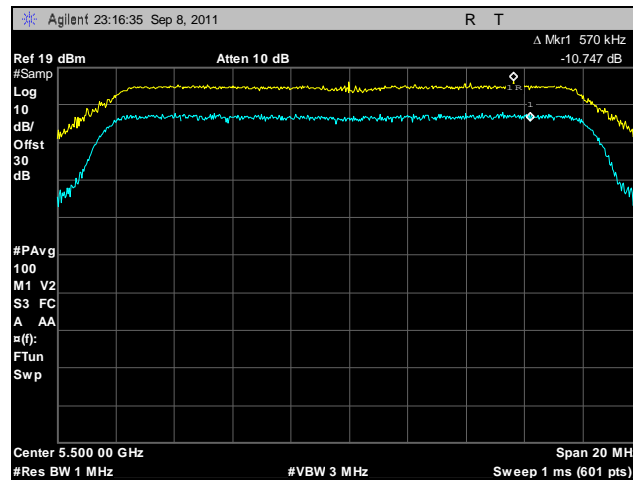

**Plot 189. Peak Excursion, 802.11a, 5500 MHz**

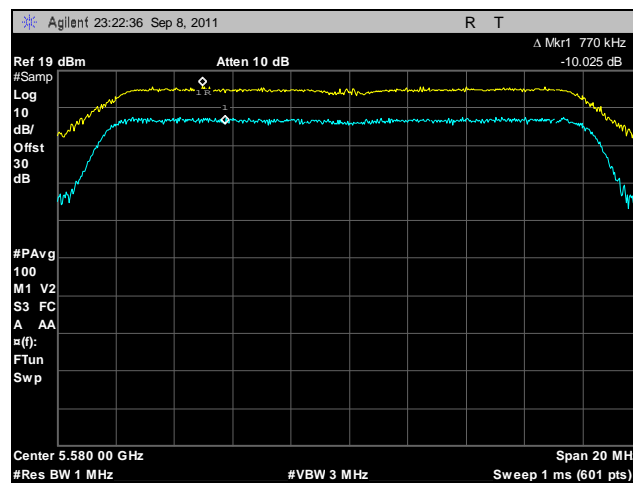

**Plot 190. Peak Excursion, 802.11a, 5580 MHz**

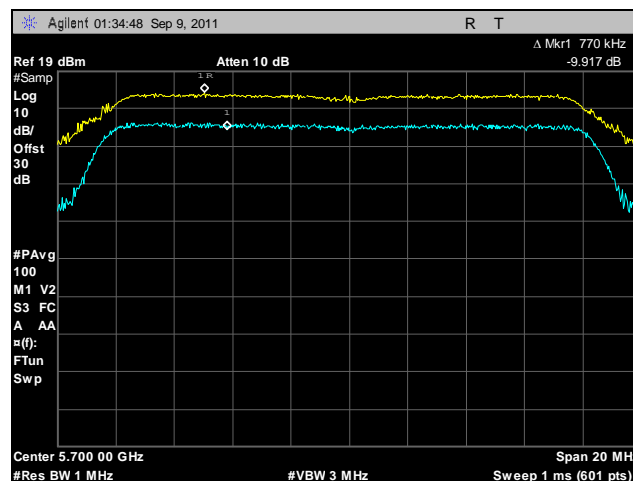

**Plot 191. Peak Excursion, 802.11a, 5700 MHz**

**Peak Excursion Ratio, 802.11n 20 MHz, Port A**

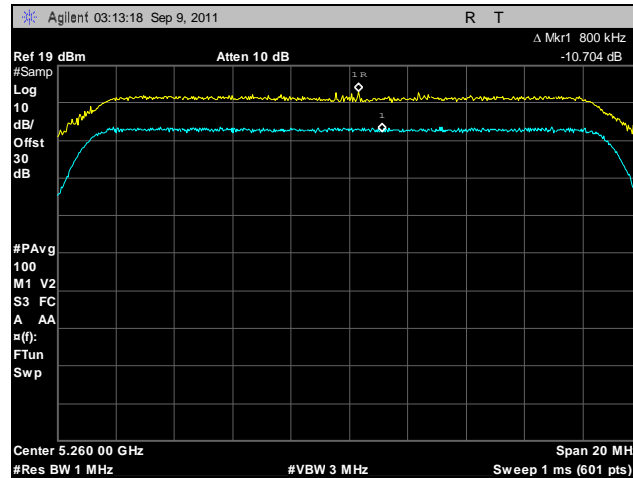

**Plot 192. Peak Excursion, 802.11n 20 MHz, Port A, 5260 MHz**

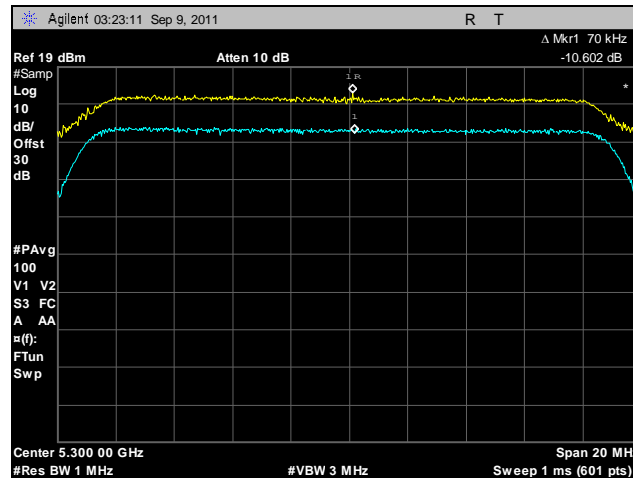

**Plot 193. Peak Excursion, 802.11n 20 MHz, Port A, 5300 MHz**

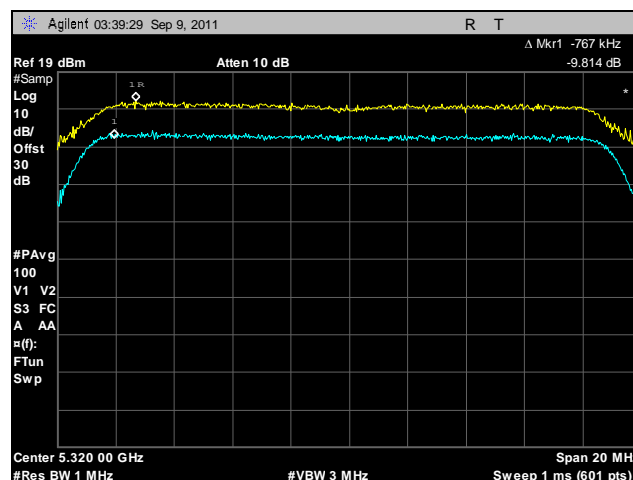

**Plot 194. Peak Excursion, 802.11n 20 MHz, Port A, 5320 MHz**



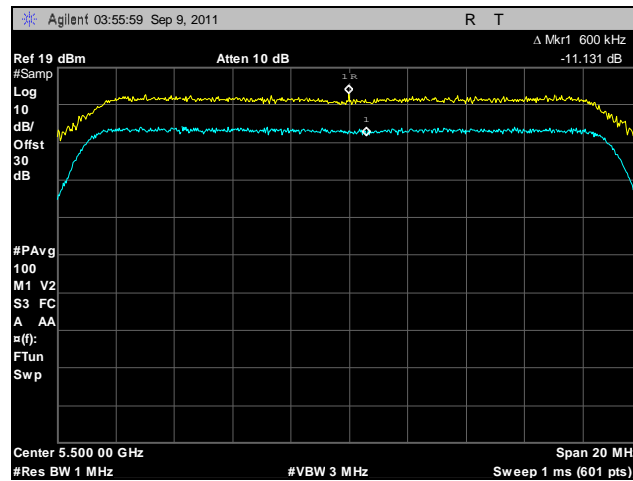

Plot 195. Peak Excursion, 802.11n 20 MHz, Port A, 5500 MHz

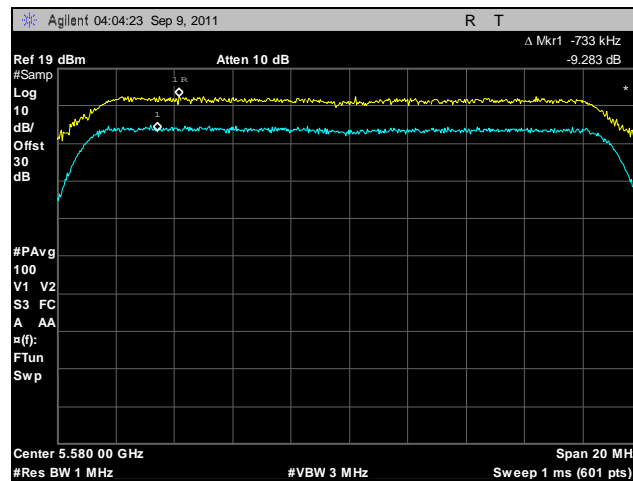

Plot 196. Peak Excursion, 802.11n 20 MHz, Port A, 5580 MHz

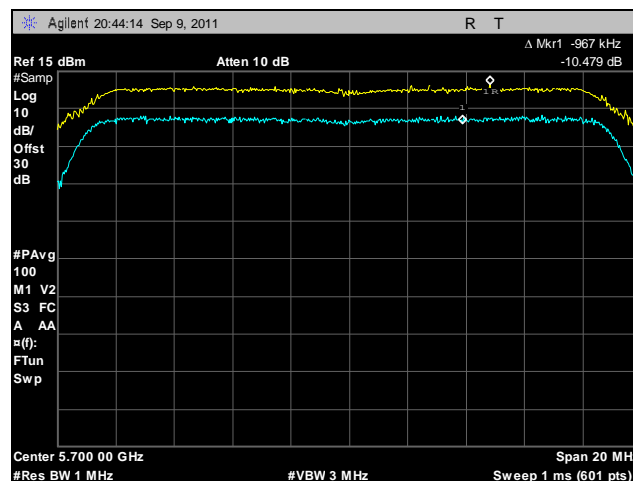

Plot 197. Peak Excursion, 802.11n 20 MHz, Port A, 5700 MHz

**Peak Excursion Ratio, 802.11n 20 MHz, Port B**

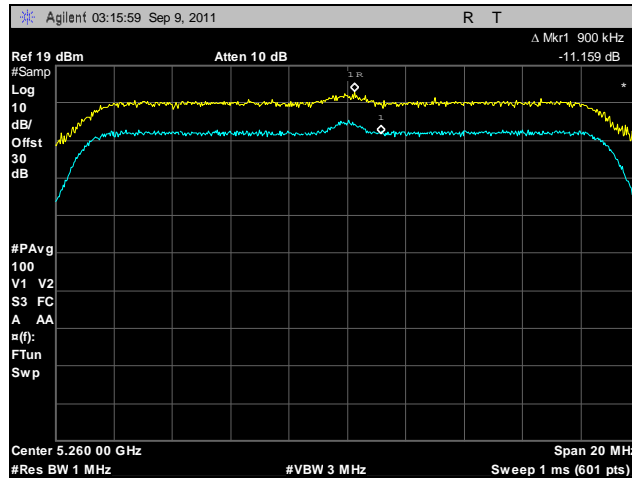

**Plot 198. Peak Excursion, 802.11n 20 MHz, Port B, 5260 MHz**

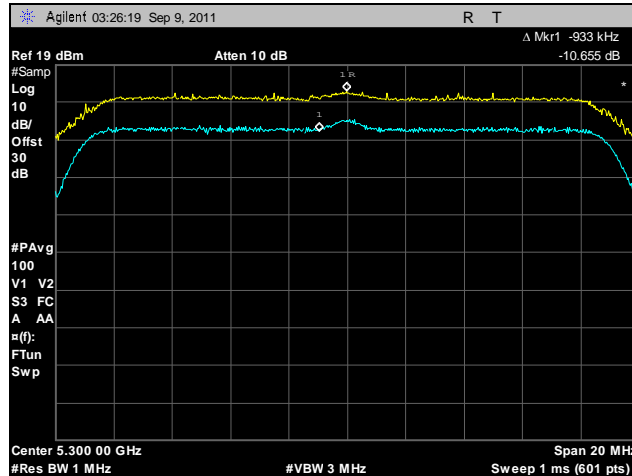

**Plot 199. Peak Excursion, 802.11n 20 MHz, Port B, 5300 MHz**

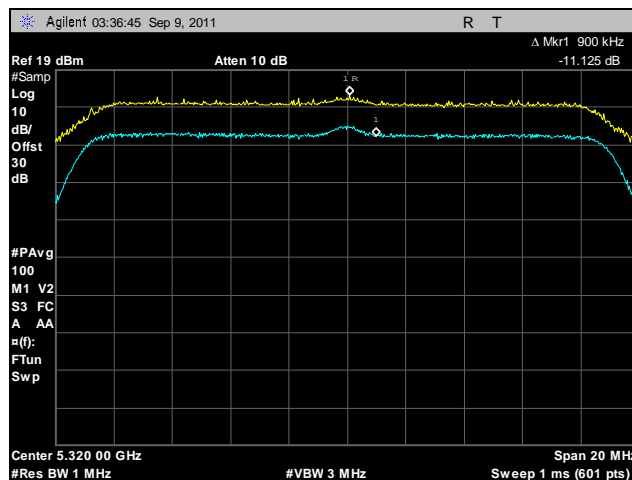

**Plot 200. Peak Excursion, 802.11n 20 MHz, Port B, 5320 MHz**

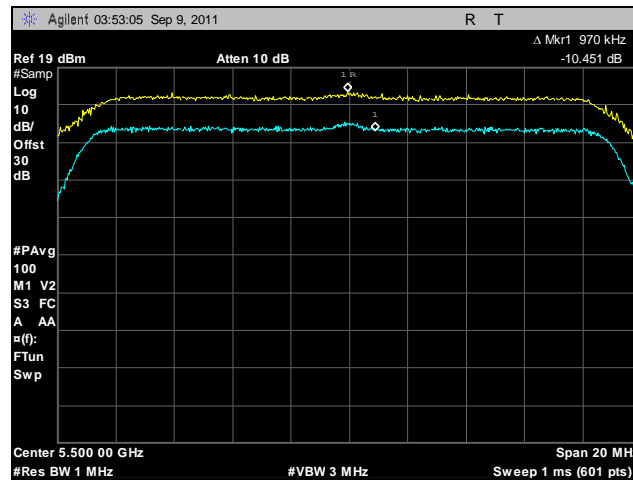

Plot 201. Peak Excursion, 802.11n 20 MHz, Port B, 5500 MHz

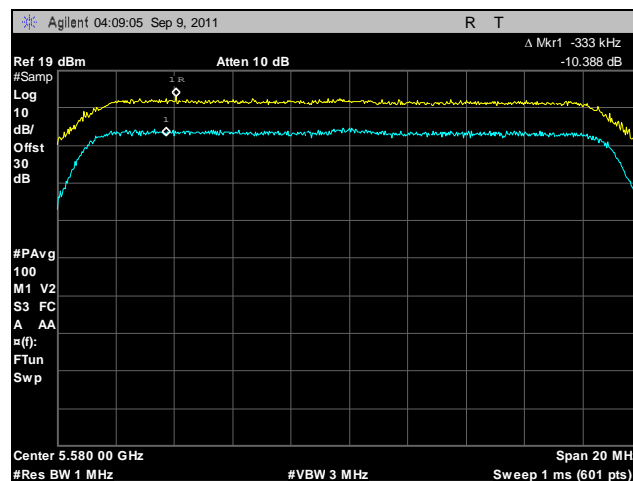

Plot 202. Peak Excursion, 802.11n 20 MHz, Port B, 5580 MHz

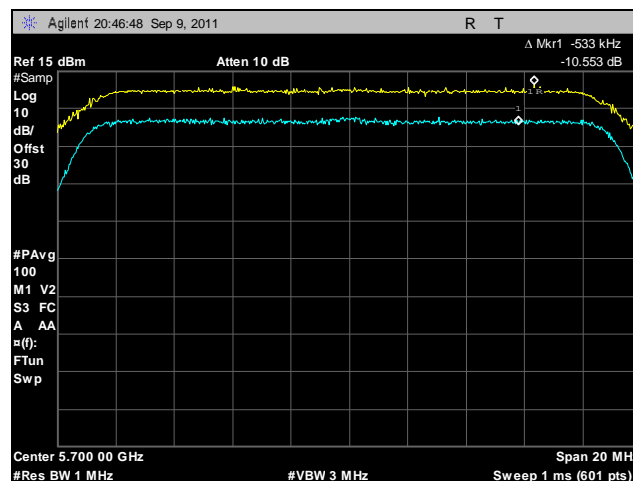

Plot 203. Peak Excursion, 802.11n 20 MHz, Port B, 5700 MHz

**Peak Excursion Ratio, 802.11n 40 MHz, Port A**

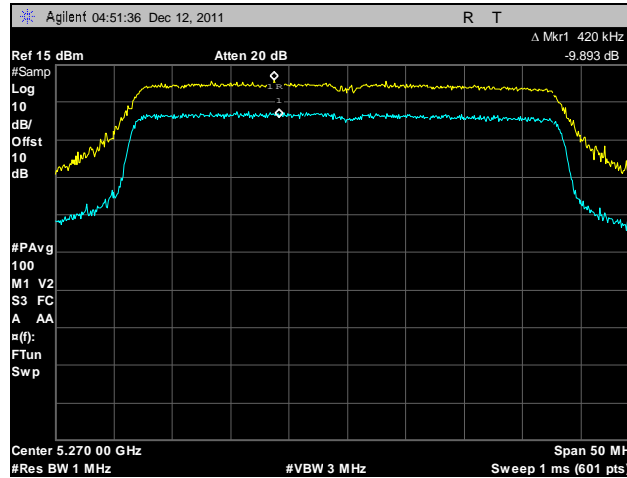

**Plot 204. Peak Excursion, 802.11n 40 MHz, Port A, 5270 MHz**

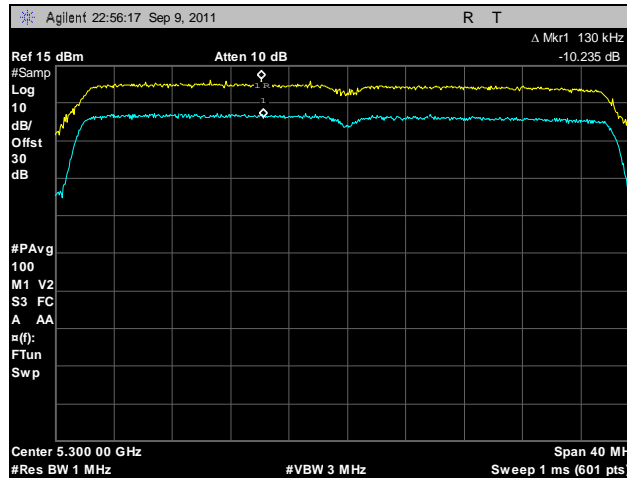

**Plot 205. Peak Excursion, 802.11n 40 MHz, Port A, 5300 MHz**

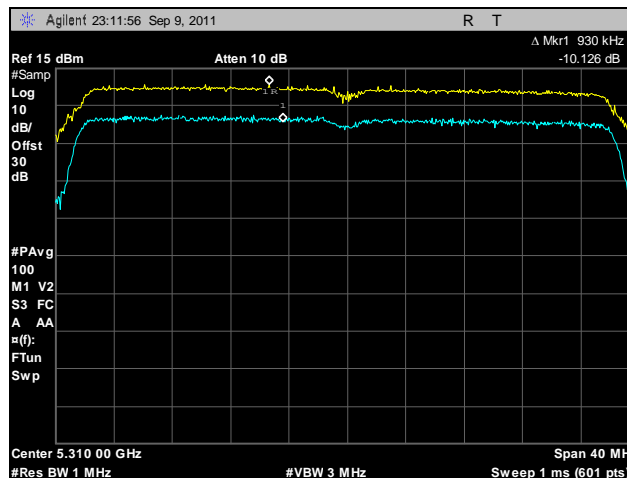

**Plot 206. Peak Excursion, 802.11n 40 MHz, Port A, 5310 MHz**

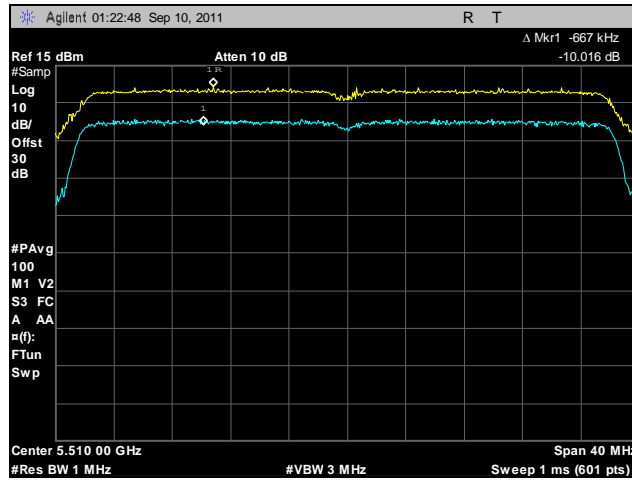

Plot 207. Peak Excursion, 802.11n 40 MHz, Port A, 5510 MHz

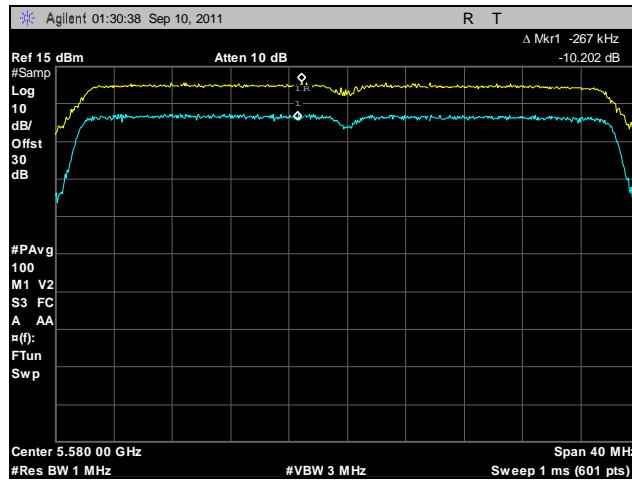

Plot 208. Peak Excursion, 802.11n 40 MHz, Port A, 5580 MHz

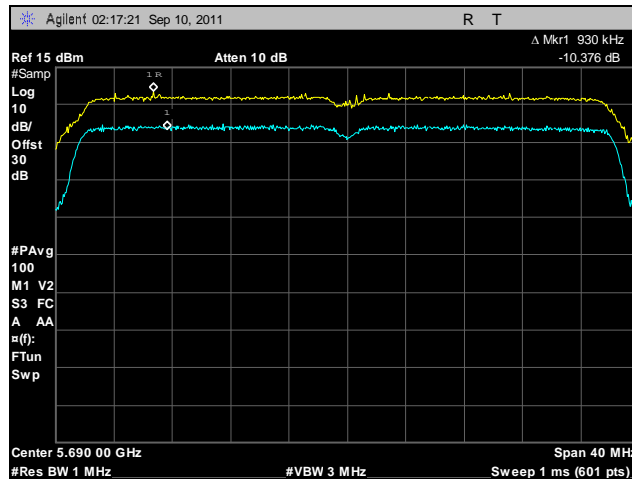

Plot 209. Peak Excursion, 802.11n 40 MHz, Port A, 5690 MHz

**Peak Excursion Ratio, 802.11n 40 MHz, Port B**

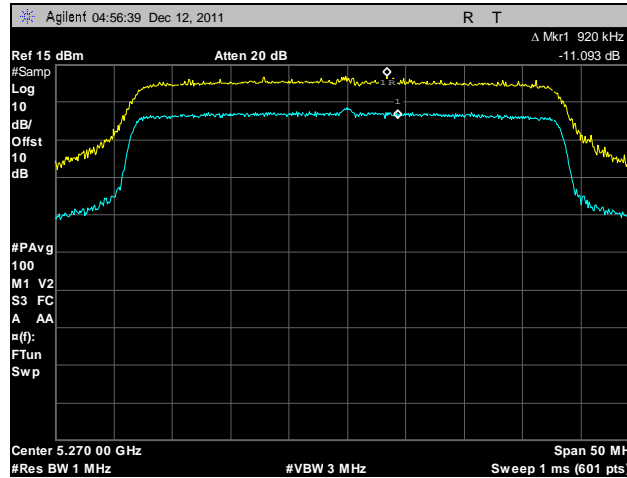

**Plot 210. Peak Excursion, 802.11n 40 MHz, Port B, 5270 MHz**

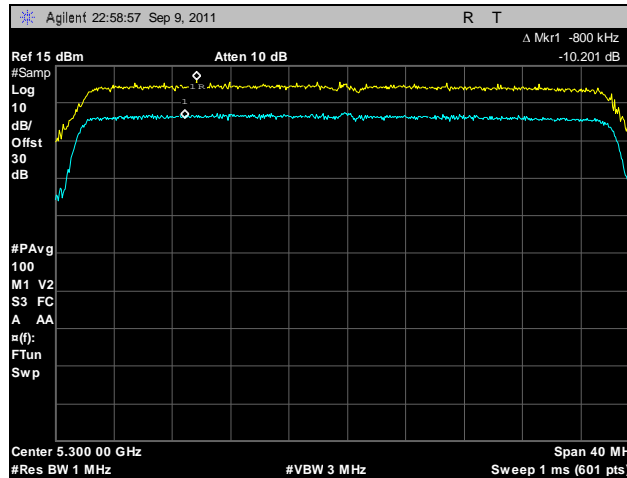

**Plot 211. Peak Excursion, 802.11n 40 MHz, Port B, 5300 MHz**

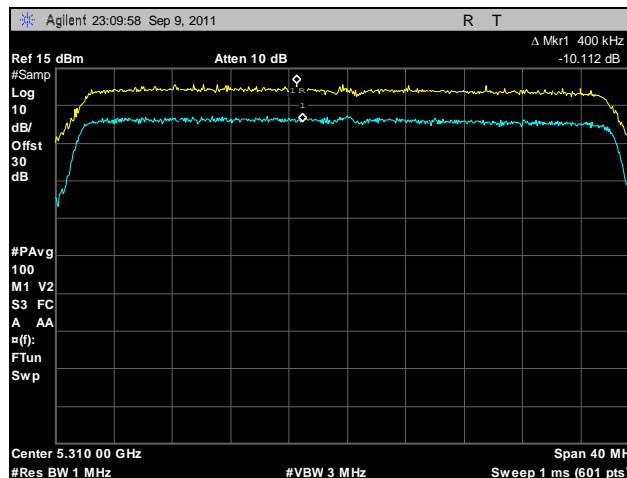

**Plot 212. Peak Excursion, 802.11n 40 MHz, Port B, 5310 MHz**

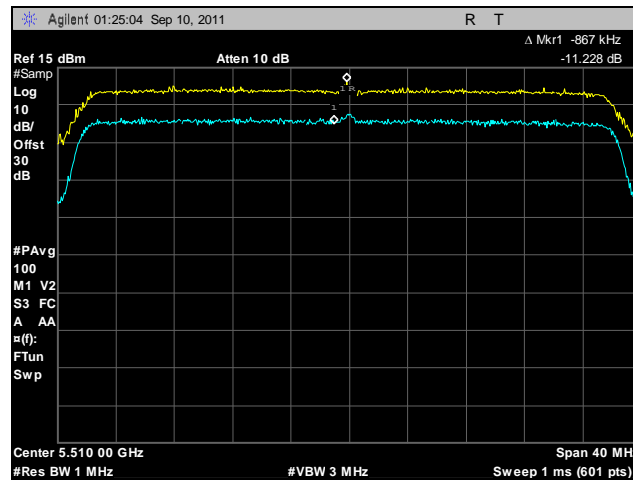

Plot 213. Peak Excursion, 802.11n 40 MHz, Port B, 5510 MHz

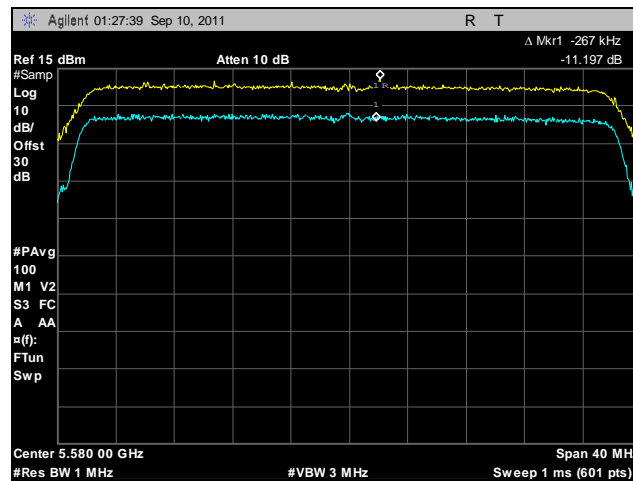

Plot 214. Peak Excursion, 802.11n 40 MHz, Port B, 5580 MHz

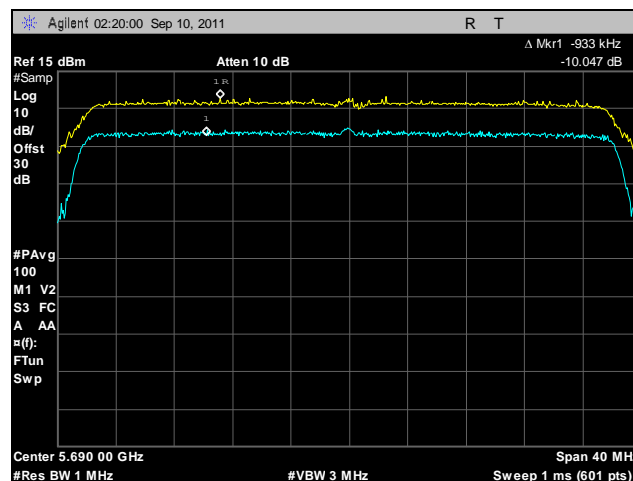

Plot 215. Peak Excursion, 802.11n 40 MHz, Port B, 5690 MHz

## Electromagnetic Compatibility Criteria for Intentional Radiators

### § 15.407(b)(1),(2), (5), (6) Undesirable Emissions

**Test Requirements:** § 15.407(b)(1),(2), (5), (6); §15.205: Emissions outside the frequency band.

**§ 15.407(b)(1):** In any 1MHz bandwidth outside the frequency band 5.15-5.25GHz in which the spread spectrum or digitally modulated intentional radiator is operating, the radio frequency power shall not exceed -27dBm.

**§ 15.407(b)(2):** In any 1MHz bandwidth outside the frequency band 5.25-5.35GHz in which the spread spectrum or digitally modulated intentional radiator is operating, the radio frequency power shall not exceed -27dBm.

**§ 15.407(b)(6):** Radiated emissions which fall in the restricted bands, as defined in § 15.205(a), must also comply with the radiated emission limits specified in § 15.209(a).

**§15.205(a):** Except as shown in paragraph (d) of this section, only spurious emissions are permitted in any of the frequency bands listed below:

MHz	MHz	MHz	GHz
0.090–0.110-----	16.42–16.423	399.9–410	4.5–5.15
<sup>1</sup> 0.495–0.505-----	16.69475–16.69525	608–614	5.35–5.46
2.1735–2.1905-----	16.80425–16.80475	960–1240	7.25–7.75
4.125–4.128-----	25.5–25.67	1300–1427	8.025–8.5
4.17725–4.17775-----	37.5–38.25	1435–1626.5	9.0–9.2
4.20725–4.20775-----	73–74.6	1645.5–1646.5	9.3–9.5
6.215–6.218-----	74.8–75.2	1660–1710	10.6–12.7
6.26775–6.26825-----	108–121.94	1718.8–1722.2	13.25–13.4
6.31175–6.31225-----	123–138	2200–2300	14.47–14.5
8.291–8.294-----	149.9–150.05	2310–2390	15.35–16.2
8.362–8.366-----	156.52475–156.52525	2483.5–2500	17.7–21.4
8.37625–8.38675-----	156.7–156.9	2655–2900	22.01–23.12
8.41425–8.41475-----	162.0125–167.17	3260–3267	23.6–24.0
12.29–12.293-----	167.72–173.2	3332–3339	31.2–31.8
12.51975–12.52025-----	240–285	3345.8–3358 36.	43–36.5
12.57675–12.57725-----	322–335.4	3600–4400	( <sup>2</sup> )

**Table 27. Restricted Bands of Operation**



**Test Procedure:** The EUT was placed on a 0.8m acrylic table inside a semi-anechoic chamber. The transmitter was set to transmit on low, mid, and high channels. The table was rotated 360 degrees and the height of the receiving antenna was varied between 1m and 4m to maximize spurious emissions.

For frequencies between 30 MHz and 1 GHz, a peak detector was used with a resolution bandwidth of 100 kHz. For frequencies above 1 GHz, an average detector was used with a resolution bandwidth of 1 MHz. Measurements were made on frequencies up to 40 GHz. When emissions were found within restricted bands, their field strength was measured to determine compliance with the 15.209 limit.

The equation  $EIRP = E + 20 \log D - 104.77$  was used to convert between field strength and equivalent isotropic radiated power (EIRP), where E is the measured field strength in dBuV/m and d was the measurement distance in meters.

**Test Results:** The EUT was found compliant with the requirement(s) of this section. Measured emissions were below applicable limits.

**Test Engineer(s):** Jeff Pratt

**Test Date(s):** 10/1/11

## Radiated Spurious Emissions Limits, 802.11a, Omni Antenna

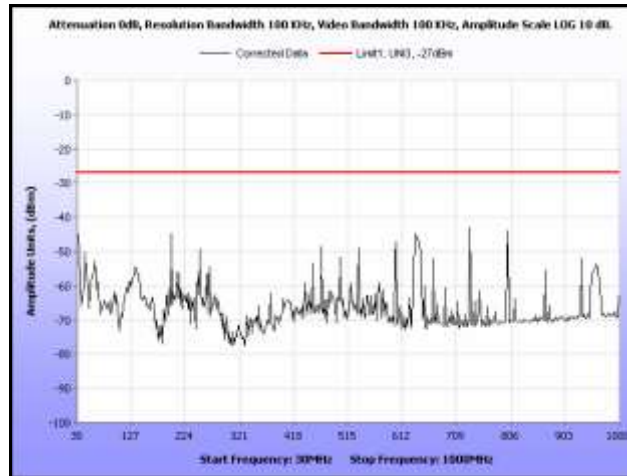

Plot 216. Radiated Spurious, 802.11a, 5260 MHz, 30 MHz – 1 GHz, Omni Antenna

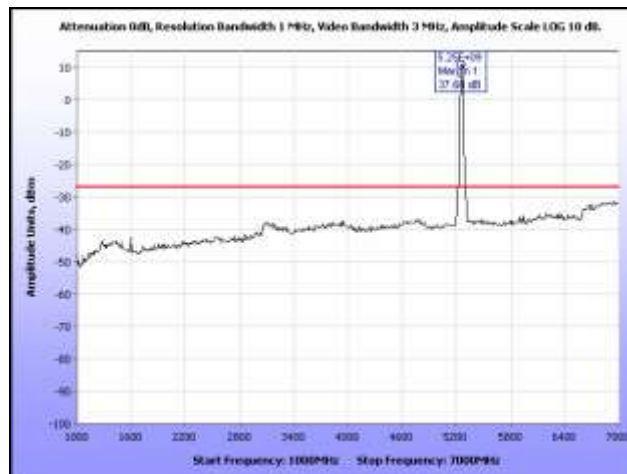

Plot 217. Radiated Spurious, 802.11a, 5260 MHz, 1 GHz – 7 GHz, Omni Antenna

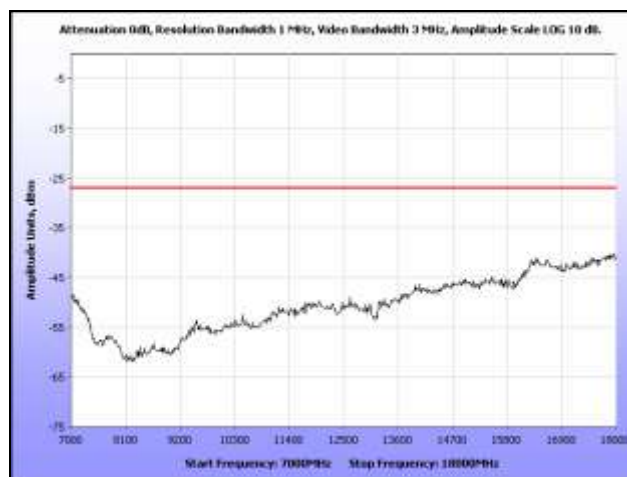

Plot 218. Radiated Spurious, 802.11a, 5260 MHz, 7 GHz – 18 GHz, Omni Antenna



Plot 219. Radiated Spurious, 802.11a, 5260 MHz, 18 GHz – 40 GHz, Omni Antenna

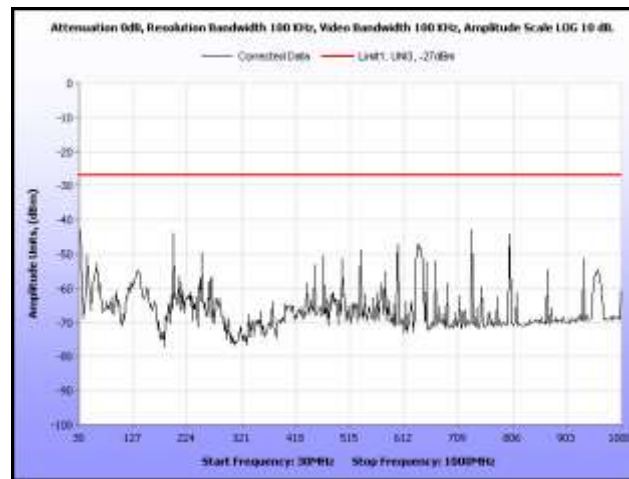

Plot 220. Radiated Spurious, 802.11a, 5300 MHz, 30 MHz – 1 GHz, Omni Antenna

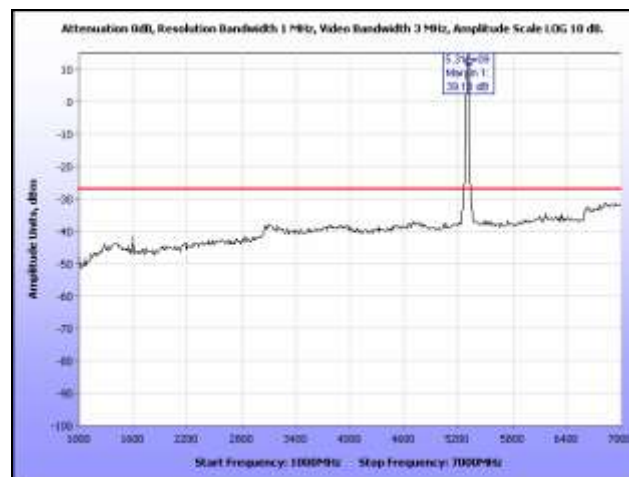

Plot 221. Radiated Spurious, 802.11a, 5300 MHz, 1 GHz – 7 GHz, Omni Antenna



Plot 222. Radiated Spurious, 802.11a, 5300 MHz, 7 GHz – 18 GHz, Omni Antenna



Plot 223. Radiated Spurious, 802.11a, 5300 MHz, 18 GHz – 40 GHz, Omni Antenna

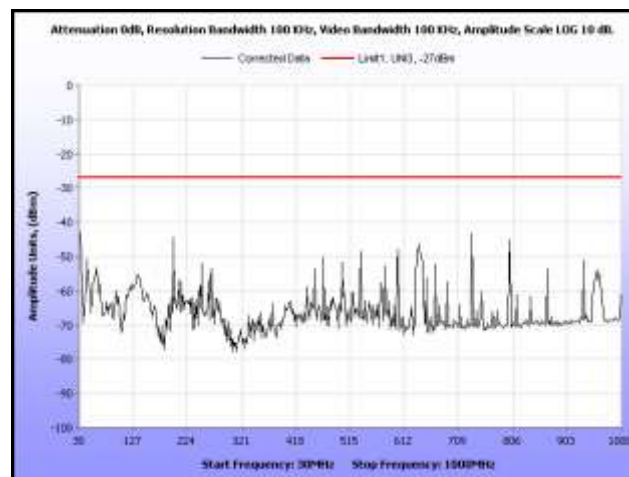

Plot 224. Radiated Spurious, 802.11a, 5320 MHz, 30 MHz – 1 GHz, Omni Antenna

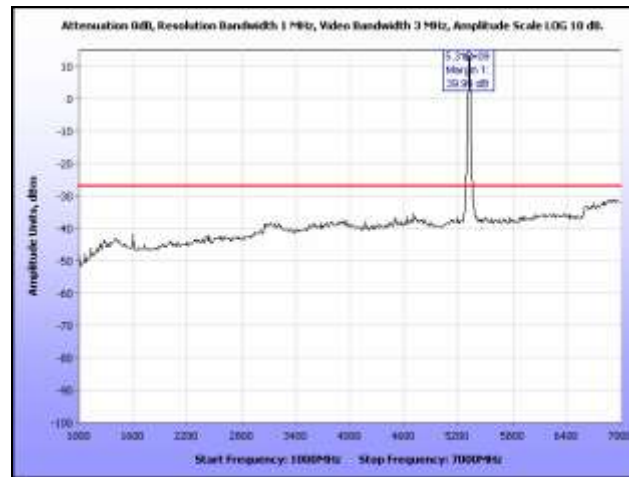

Plot 225. Radiated Spurious, 802.11a, 5320 MHz, 1 GHz – 7 GHz, Omni Antenna

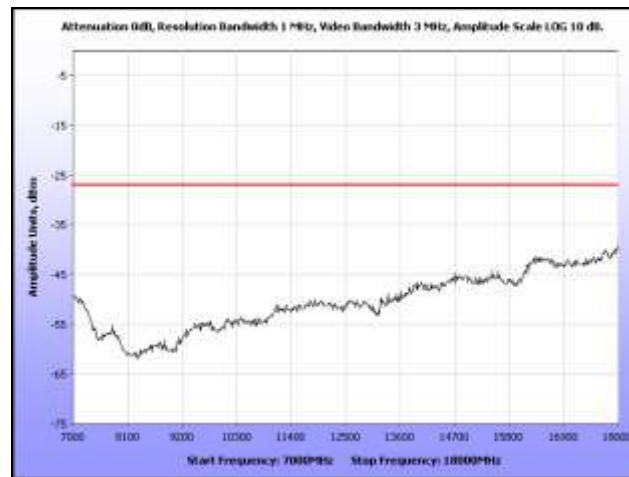

Plot 226. Radiated Spurious, 802.11a, 5320 MHz, 7 GHz – 18 GHz, Omni Antenna



Plot 227. Radiated Spurious, 802.11a, 5320 MHz, 18 GHz – 40 GHz, Omni Antenna

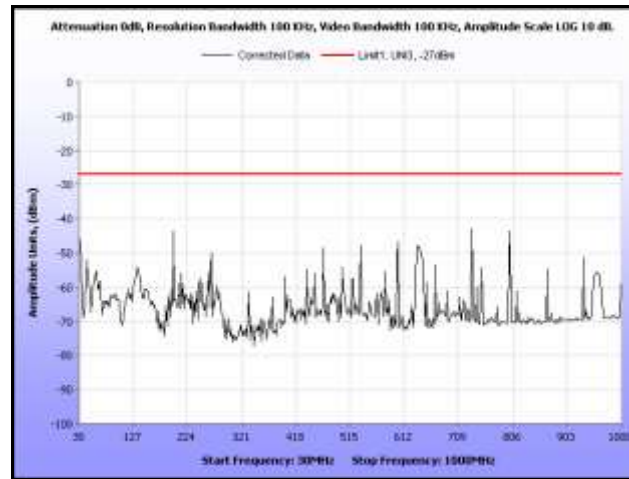

Plot 228. Radiated Spurious, 802.11a, 5500 MHz, 30 MHz – 1 GHz, Omni Antenna

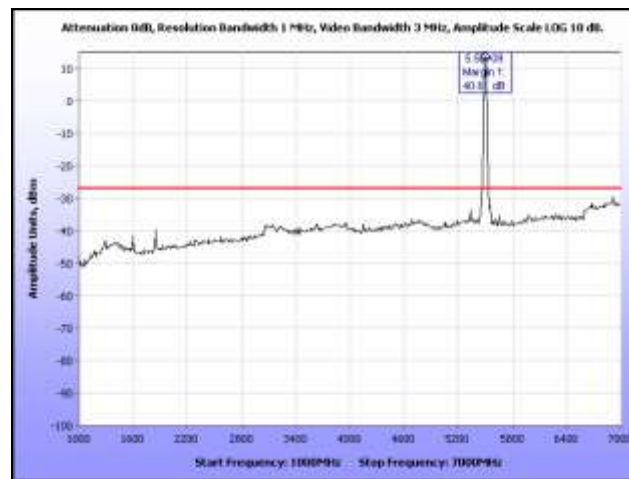

Plot 229. Radiated Spurious, 802.11a, 5500 MHz, 1 GHz – 7 GHz, Omni Antenna

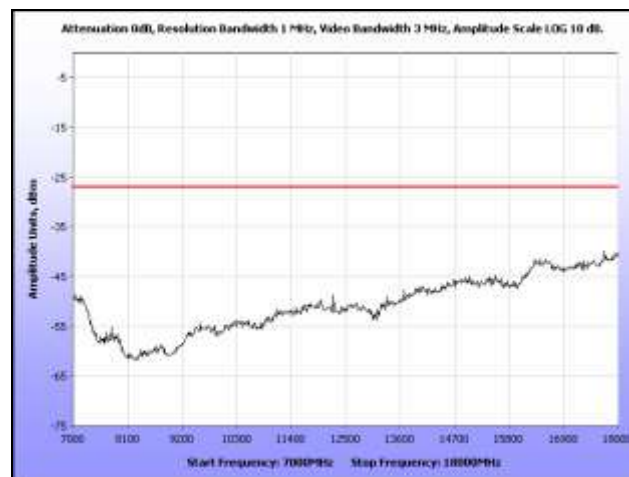

Plot 230. Radiated Spurious, 802.11a, 5500 MHz, 7 GHz – 18 GHz, Omni Antenna



Plot 231. Radiated Spurious, 802.11a, 5500 MHz, 18 MHz – 40 GHz, Omni Antenna

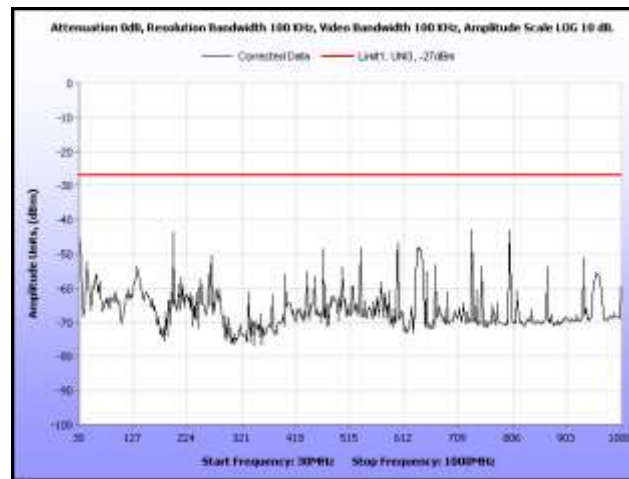

Plot 232. Radiated Spurious, 802.11a, 5580 MHz, 30 MHz – 1 GHz, Omni Antenna

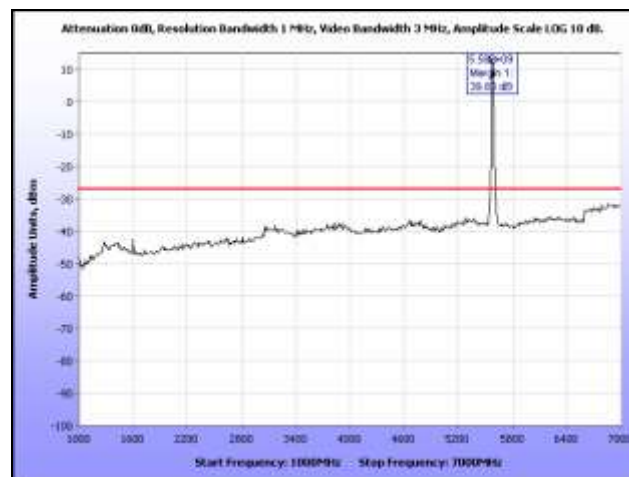

Plot 233. Radiated Spurious, 802.11a, 5580 MHz, 1 GHz – 7 GHz, Omni Antenna



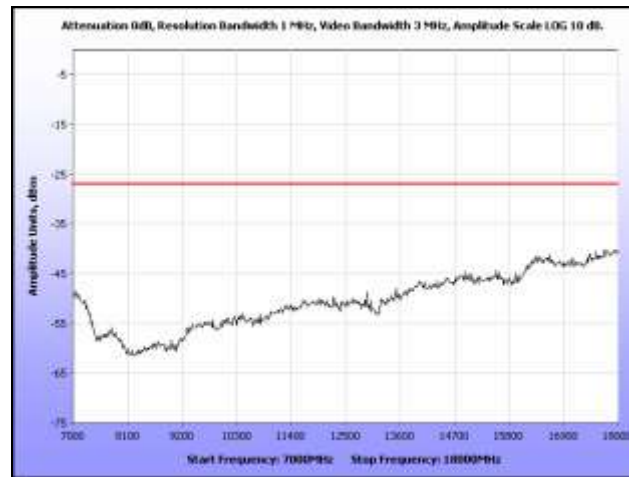

Plot 234. Radiated Spurious, 802.11a, 5580 MHz, 7 GHz – 18 GHz, Omni Antenna



Plot 235. Radiated Spurious, 802.11a, 5580 MHz, 18 GHz – 40 GHz, Omni Antenna

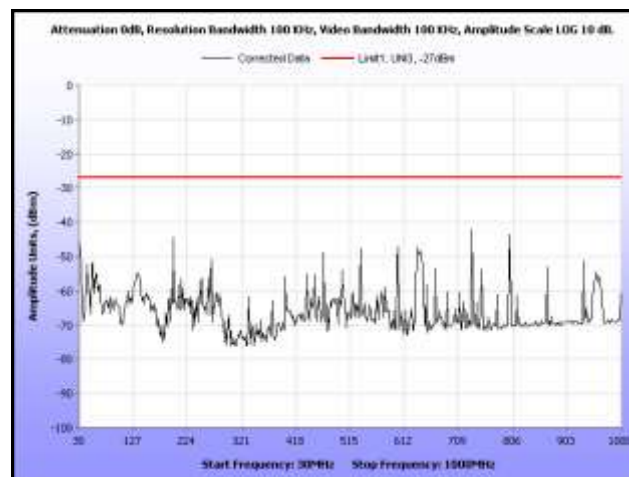

Plot 236. Radiated Spurious, 802.11a, 5700 MHz, 30 MHz – 1 GHz, Omni Antenna



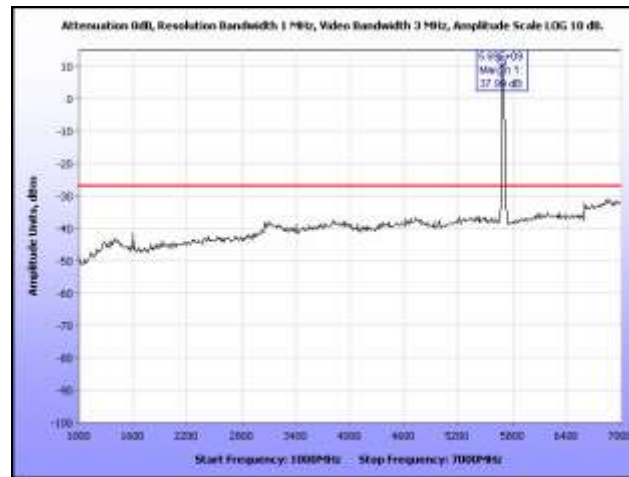

Plot 237. Radiated Spurious, 802.11a, 5700 MHz, 1 GHz – 7 GHz, Omni Antenna



Plot 238. Radiated Spurious, 802.11a, 5700 MHz, 7 GHz – 18 GHz, Omni Antenna



Plot 239. Radiated Spurious, 802.11a, 5700 MHz, 18 GHz – 40 GHz, Omni Antenna

### Radiated Spurious Emissions Limits, 802.11n 20 MHz, Omni Antenna

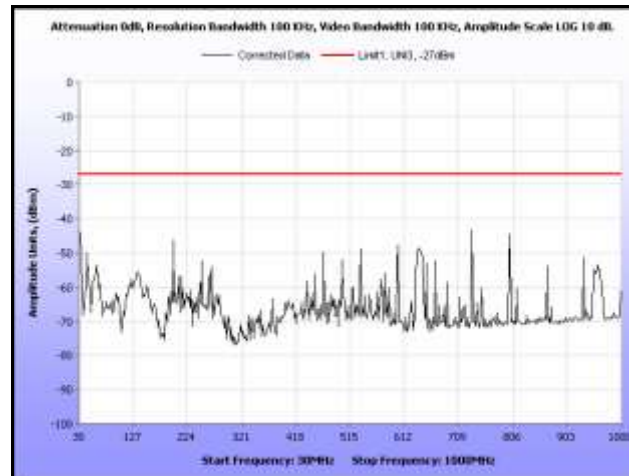

Plot 240. Radiated Spurious, 802.11n 20 MHz, 5260 MHz, 30 MHz – 1 GHz, Omni Antenna

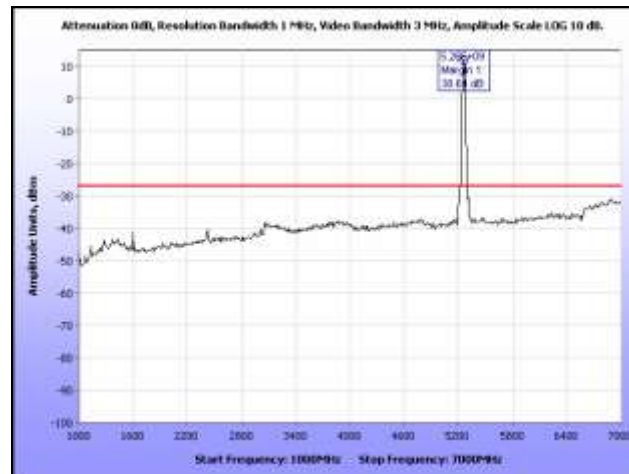

Plot 241. Radiated Spurious, 802.11n 20 MHz, 5260 MHz, 1 GHz – 7 GHz, Omni Antenna

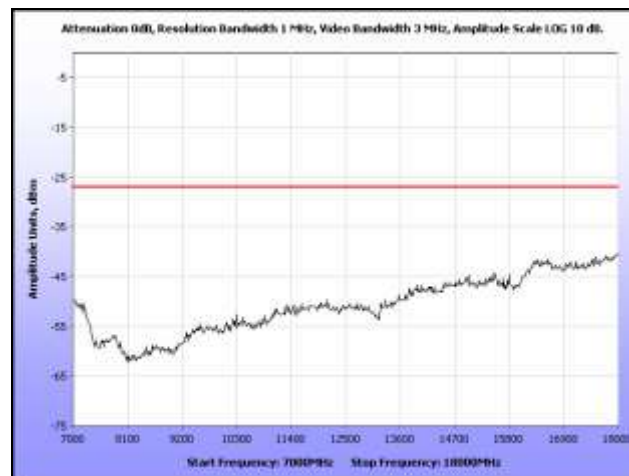

Plot 242. Radiated Spurious, 802.11n 20 MHz, 5260 MHz, 7 GHz – 18 GHz, Omni Antenna



Plot 243. Radiated Spurious, 802.11n 20 MHz, 5260 MHz, 18 GHz – 40 GHz, Omni Antenna

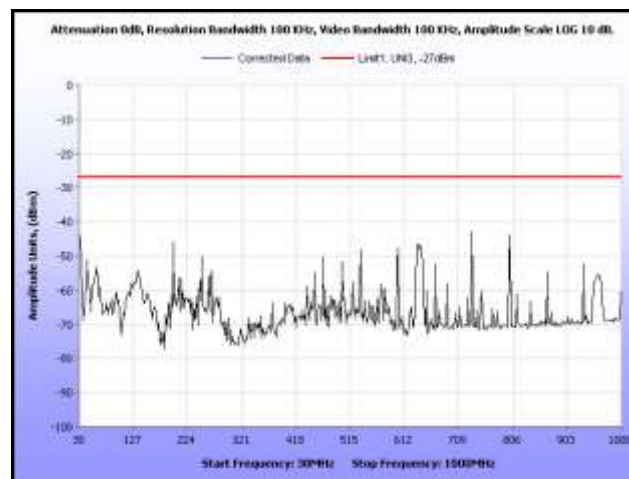

Plot 244. Radiated Spurious, 802.11n 20 MHz, 5300 MHz, 30 MHz – 1 GHz, Omni Antenna



Plot 245. Radiated Spurious, 802.11n 20 MHz, 5300 MHz, 1 GHz – 7 GHz, Omni Antenna

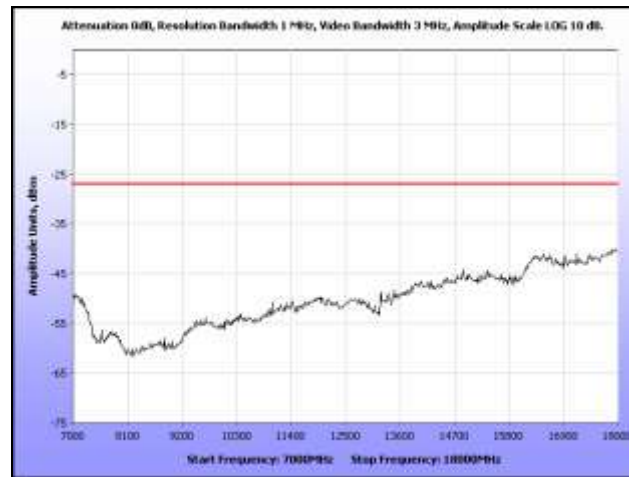

Plot 246. Radiated Spurious, 802.11n 20 MHz, 5300 MHz, 7 GHz – 18 GHz, Omni Antenna

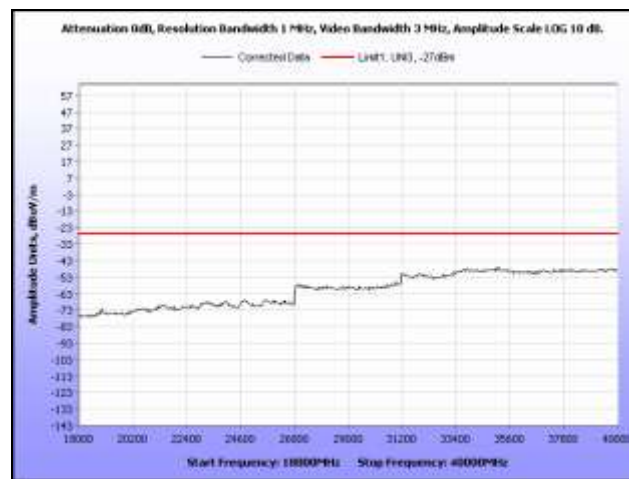

Plot 247. Radiated Spurious, 802.11n 20 MHz, 5300 MHz, 18 GHz – 40 GHz, Omni Antenna

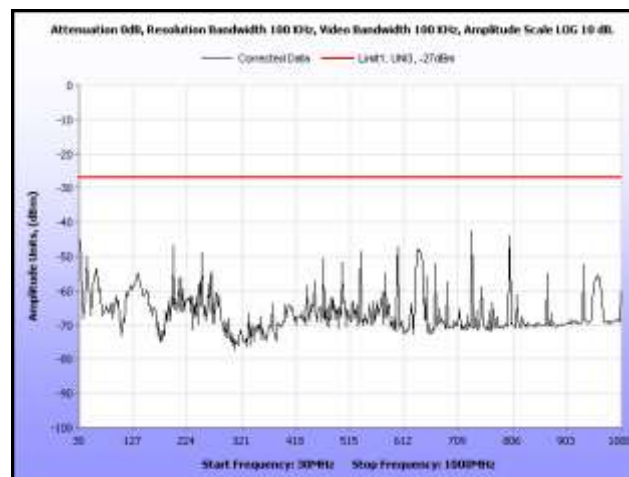

Plot 248. Radiated Spurious, 802.11n 20 MHz, 5320 MHz, 30 MHz – 1 GHz, Omni Antenna



Plot 249. Radiated Spurious, 802.11n 20 MHz, 5320 MHz, 1 GHz – 7 GHz, Omni Antenna

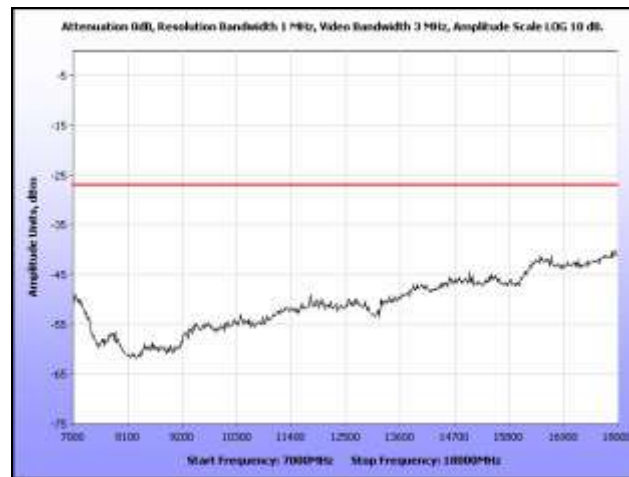

Plot 250. Radiated Spurious, 802.11n 20 MHz, 5320 MHz, 7 GHz – 18 GHz, Omni Antenna



Plot 251. Radiated Spurious, 802.11n 20 MHz, 5320 MHz, 18 GHz – 40 GHz, Omni Antenna

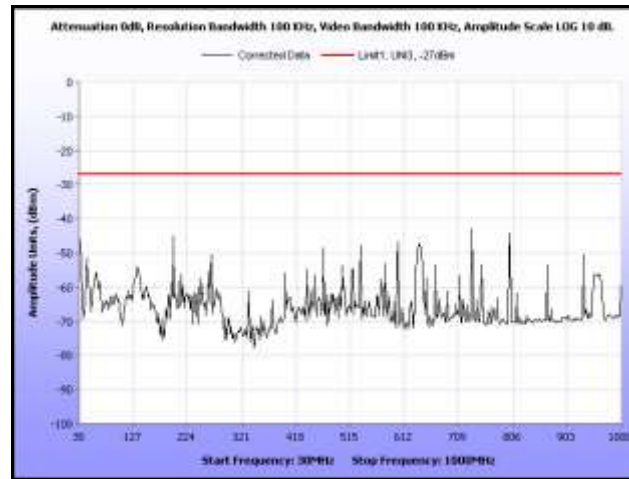

Plot 252. Radiated Spurious, 802.11n 20 MHz, 5500 MHz, 30 MHz – 1 GHz, Omni Antenna

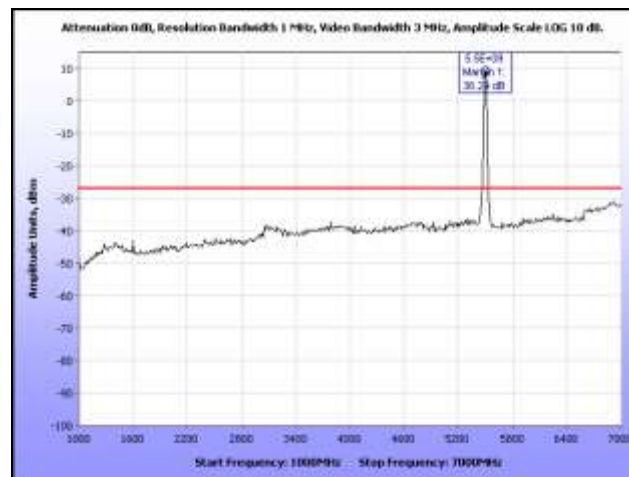

Plot 253. Radiated Spurious, 802.11n 20 MHz, 5500 MHz, 1 GHz – 7 GHz, Omni Antenna

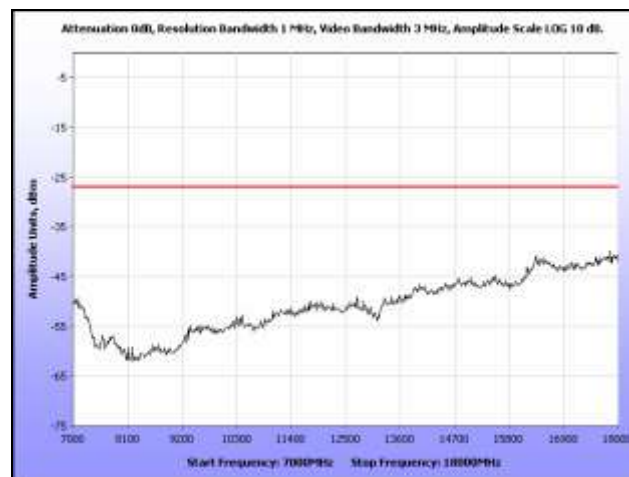

Plot 254. Radiated Spurious, 802.11n 20 MHz, 5500 MHz, 7 GHz – 18 GHz, Omni Antenna





Plot 255. Radiated Spurious, 802.11n 20 MHz, 5500 MHz, 18 MHz – 40 GHz, Omni Antenna

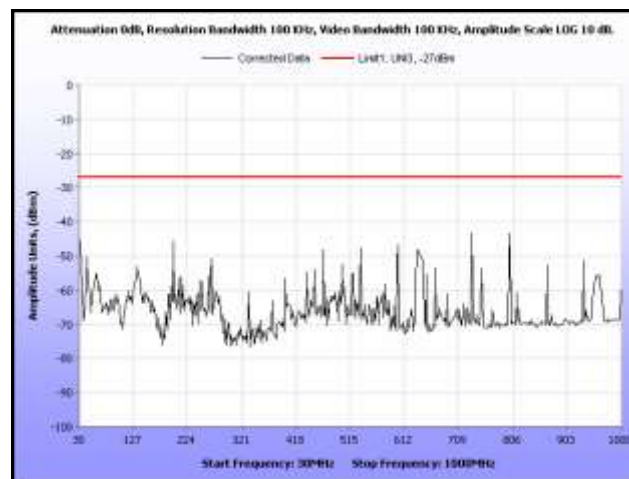

Plot 256. Radiated Spurious, 802.11n 20 MHz, 5580 MHz, 30 MHz – 1 GHz, Omni Antenna

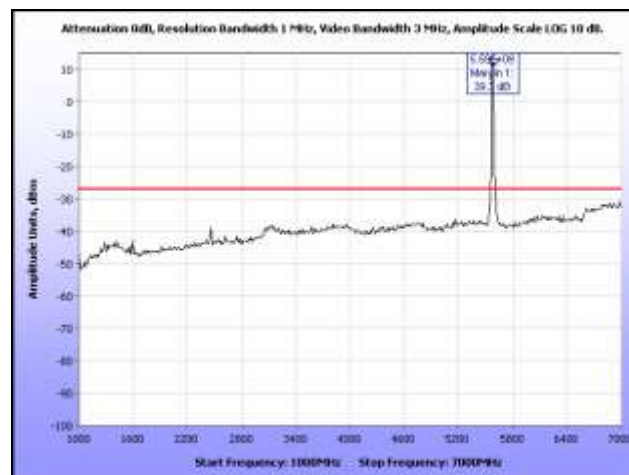

Plot 257. Radiated Spurious, 802.11n 20 MHz, 5580 MHz, 1 GHz – 7 GHz, Omni Antenna

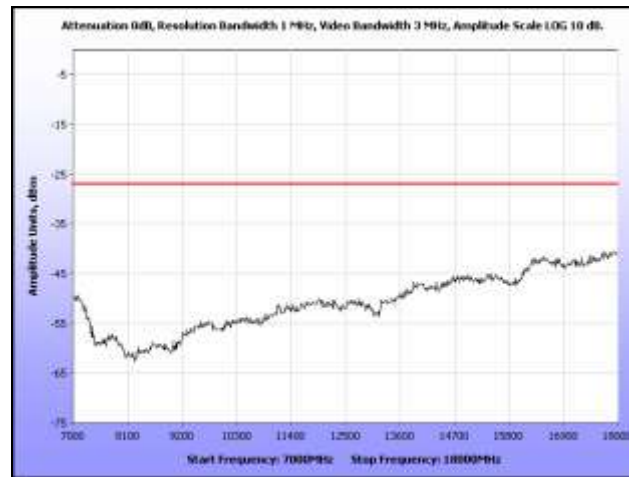

Plot 258. Radiated Spurious, 802.11n 20 MHz, 5580 MHz, 7 GHz – 18 GHz, Omni Antenna

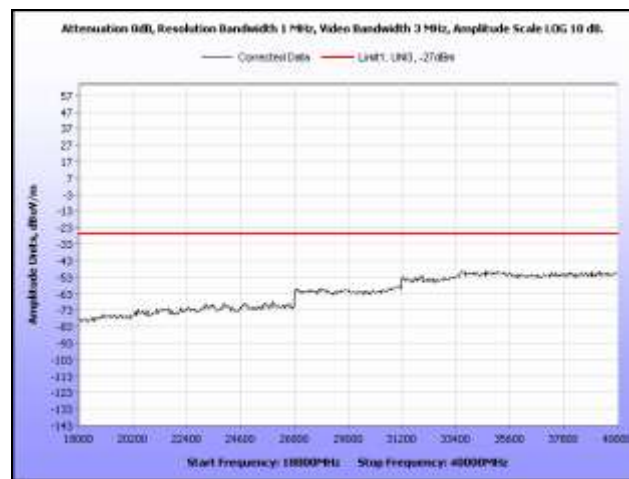

Plot 259. Radiated Spurious, 802.11n 20 MHz, 5580 MHz, 18 GHz – 40 GHz, Omni Antenna

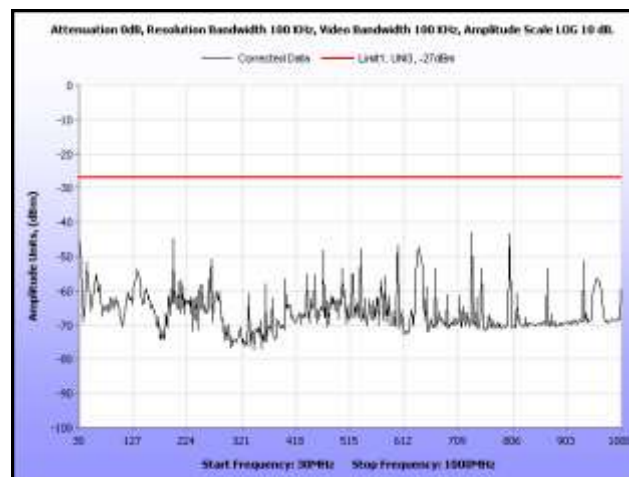

Plot 260. Radiated Spurious, 802.11n 20 MHz, 5700 MHz, 30 MHz – 1 GHz, Omni Antenna





Plot 261. Radiated Spurious, 802.11n 20 MHz, 5700 MHz, 1 GHz – 7 GHz, Omni Antenna

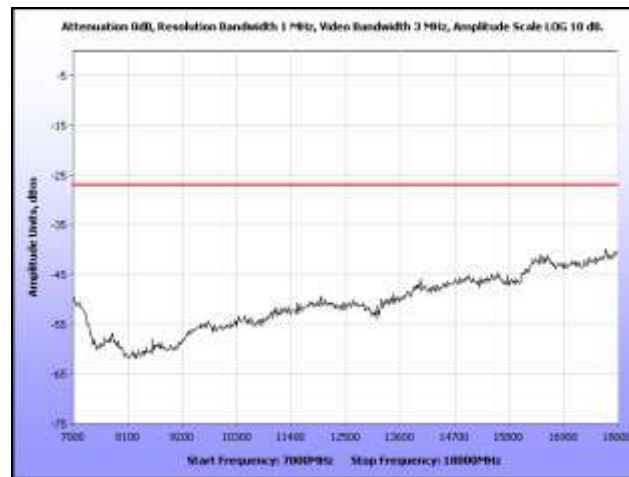

Plot 262. Radiated Spurious, 802.11n 20 MHz, 5700 MHz, 7 GHz – 18 GHz, Omni Antenna



Plot 263. Radiated Spurious, 802.11n 20 MHz, 5700 MHz, 18 GHz – 40 GHz, Omni Antenna

**Radiated Spurious Emissions Limits, 802.11n 40 MHz, Omni Antenna**

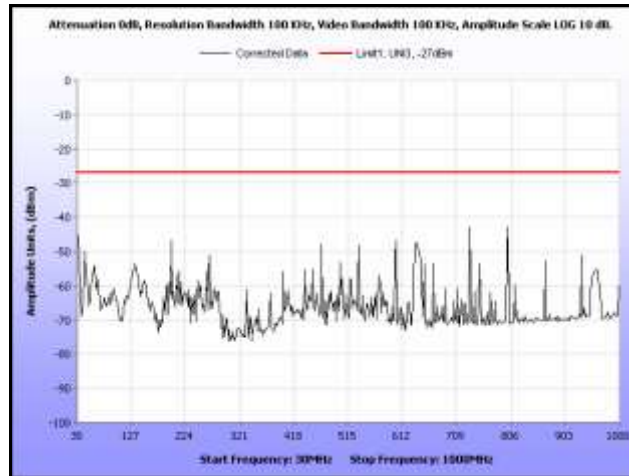

**Plot 264. Radiated Spurious, 802.11n 40 MHz, 5270 MHz, 30 MHz – 1 GHz, Omni Antenna**

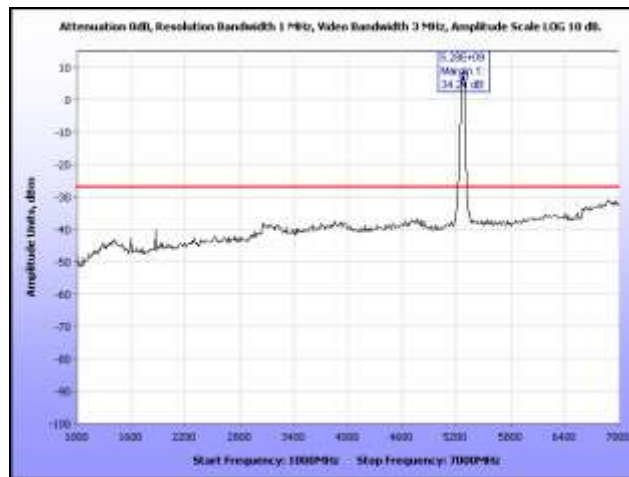

**Plot 265. Radiated Spurious, 802.11n 40 MHz, 5270 MHz, 1 GHz – 7 GHz, Omni Antenna**

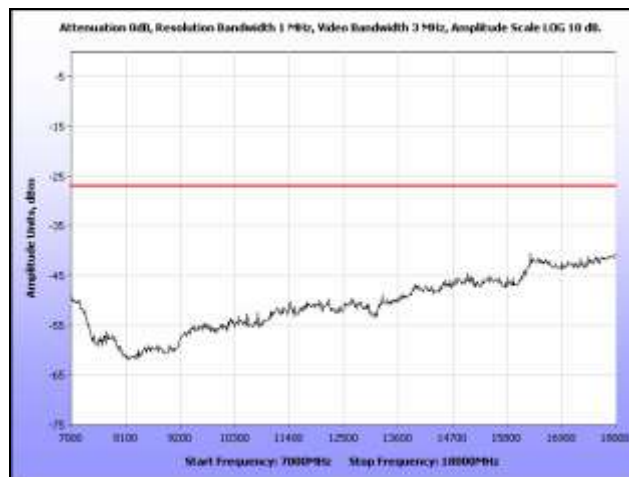

**Plot 266. Radiated Spurious, 802.11n 40 MHz, 5270 MHz, 7 GHz – 18 GHz, Omni Antenna**

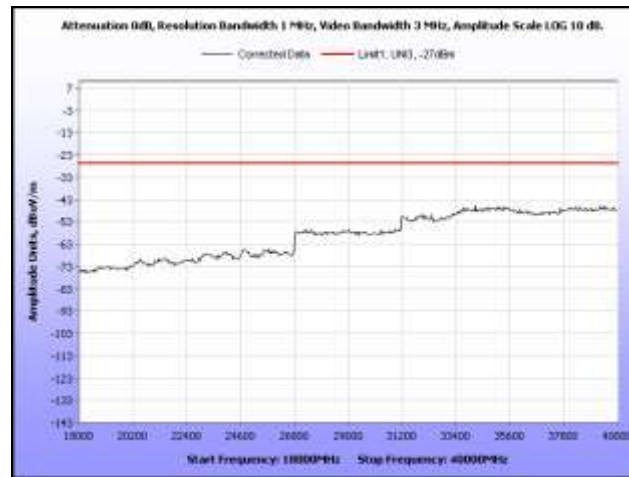

Plot 267. Radiated Spurious, 802.11n 40 MHz, 5270 MHz, 18 GHz – 40 GHz, Omni Antenna

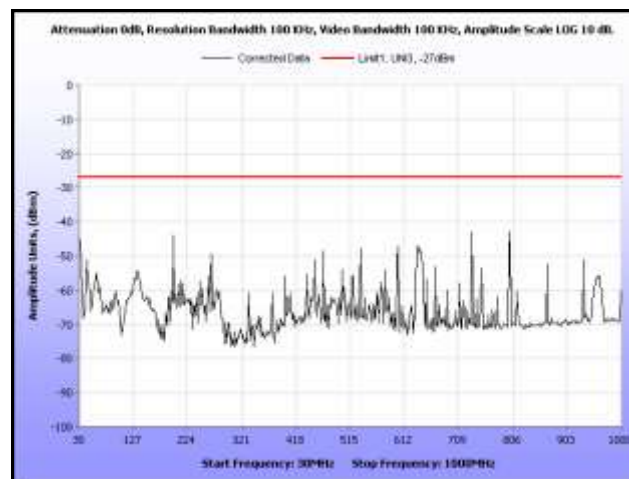

Plot 268. Radiated Spurious, 802.11n 40 MHz, 5300 MHz, 30 MHz – 1 GHz, Omni Antenna

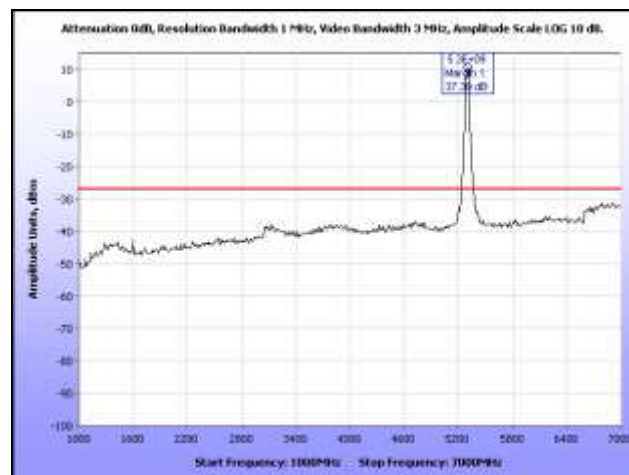

Plot 269. Radiated Spurious, 802.11n 40 MHz, 5300 MHz, 1 GHz – 7 GHz, Omni Antenna

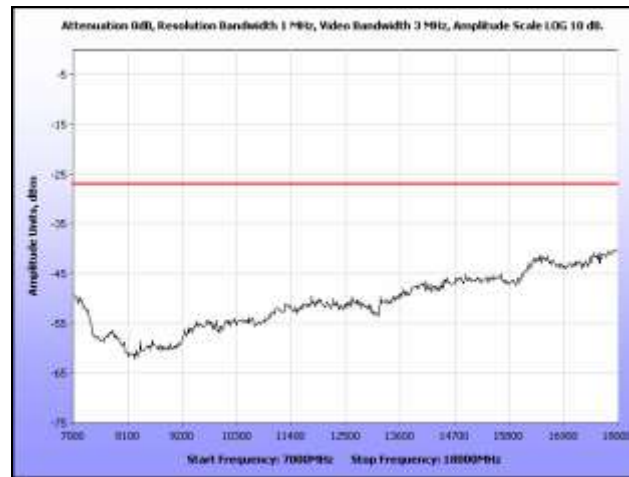

Plot 270. Radiated Spurious, 802.11n 40 MHz, 5300 MHz, 7 GHz – 18 GHz, Omni Antenna



Plot 271. Radiated Spurious, 802.11n 40 MHz, 5300 MHz, 18 GHz – 40 GHz, Omni Antenna

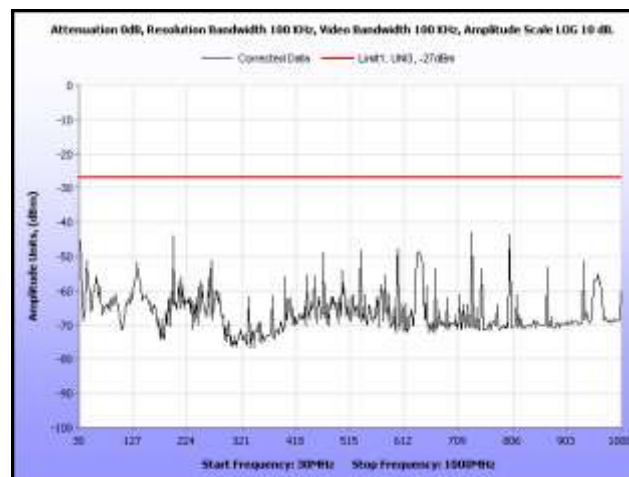

Plot 272. Radiated Spurious, 802.11n 40 MHz, 5310 MHz, 30 MHz – 1 GHz, Omni Antenna

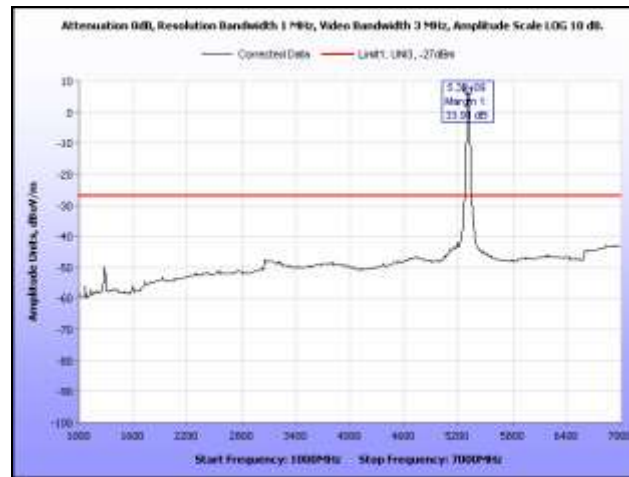

Plot 273. Radiated Spurious, 802.11n 40 MHz, 5310 MHz, 1 GHz – 7 GHz, Omni Antenna

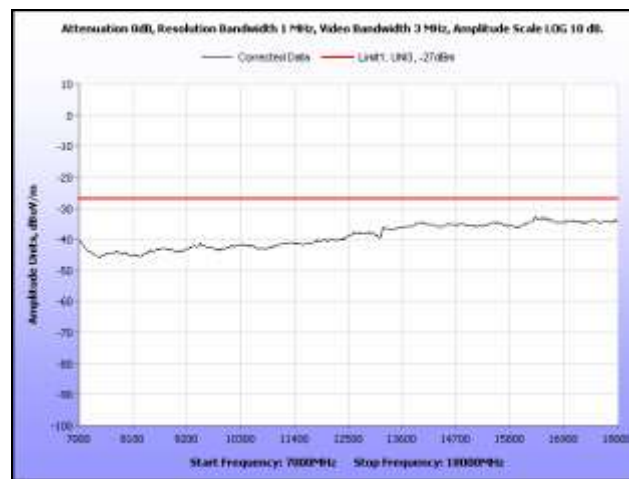

Plot 274. Radiated Spurious, 802.11n 40 MHz, 5310 MHz, 7 GHz – 18 GHz, Omni Antenna

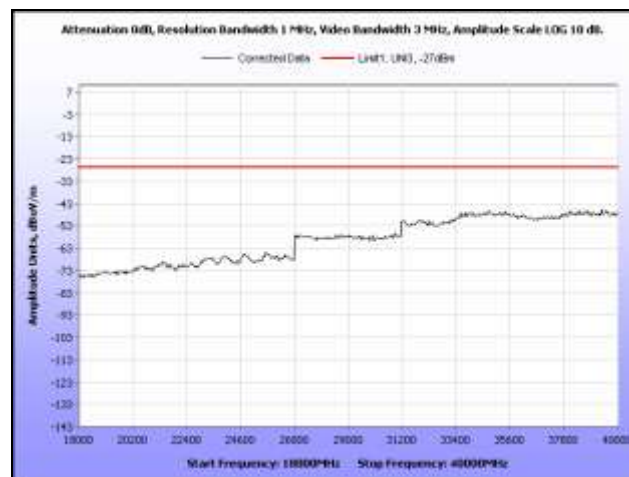

Plot 275. Radiated Spurious, 802.11n 40 MHz, 5310 MHz, 18 GHz – 40 GHz, Omni Antenna

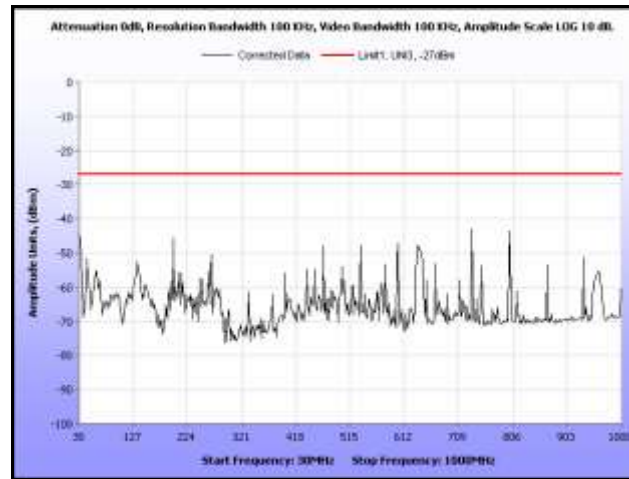

Plot 276. Radiated Spurious, 802.11n 40 MHz, 5510 MHz, 30 MHz – 1 GHz, Omni Antenna



Plot 277. Radiated Spurious, 802.11n 40 MHz, 5510 MHz, 1 GHz – 7 GHz, Omni Antenna

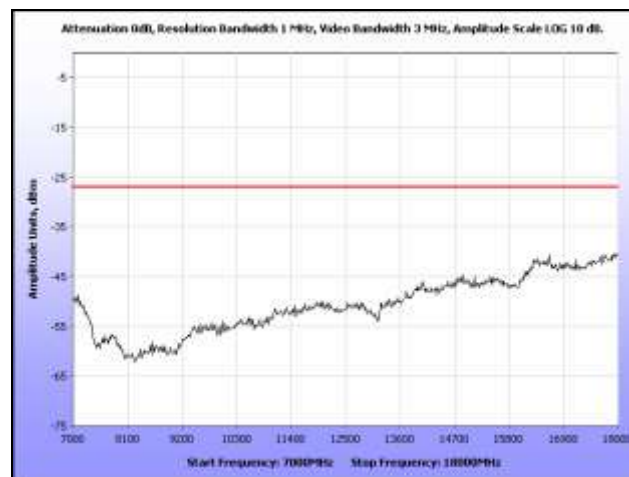

Plot 278. Radiated Spurious, 802.11n 40 MHz, 5510 MHz, 7 GHz – 18 GHz, Omni Antenna



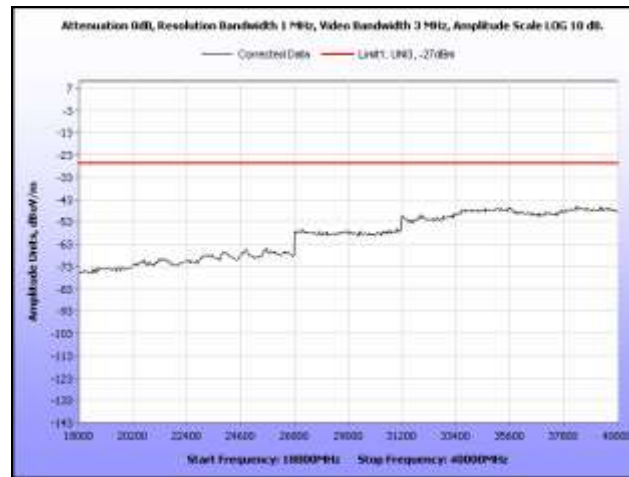

Plot 279. Radiated Spurious, 802.11n 40 MHz, 5510 MHz, 18 MHz – 40 GHz, Omni Antenna

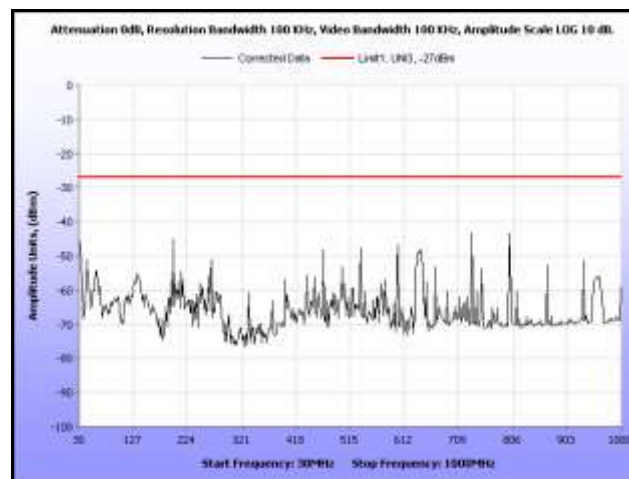

Plot 280. Radiated Spurious, 802.11n 40 MHz, 5580 MHz, 30 MHz – 1 GHz, Omni Antenna

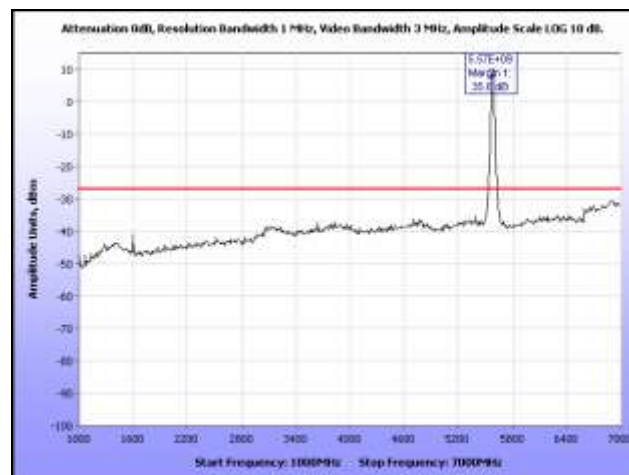

Plot 281. Radiated Spurious, 802.11n 40 MHz, 5580 MHz, 1 GHz – 7 GHz, Omni Antenna

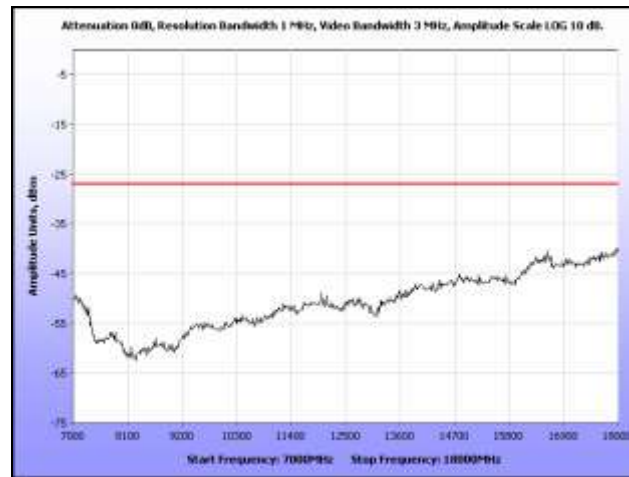

Plot 282. Radiated Spurious, 802.11n 40 MHz, 5580 MHz, 7 GHz – 18 GHz, Omni Antenna

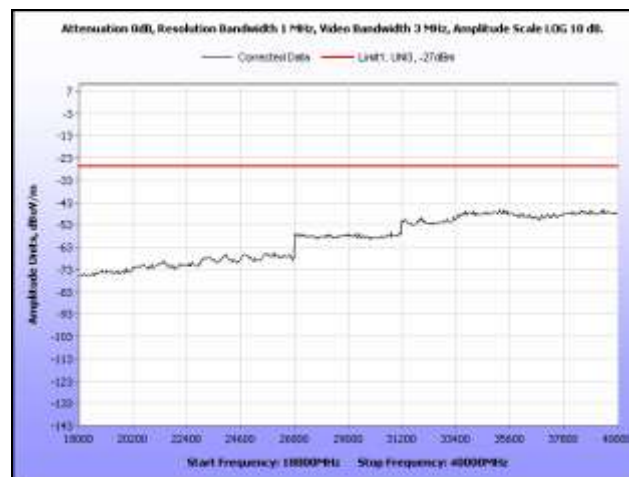

Plot 283. Radiated Spurious, 802.11n 40 MHz, 5580 MHz, 18 GHz – 40 GHz, Omni Antenna

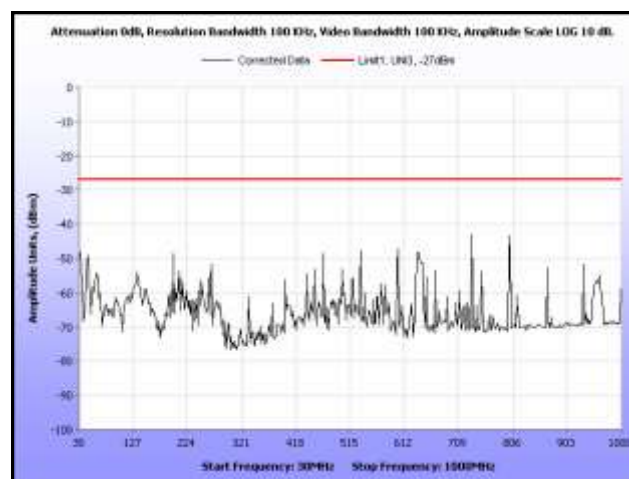

Plot 284. Radiated Spurious, 802.11n 40 MHz, 5690 MHz, 30 MHz – 1 GHz, Omni Antenna



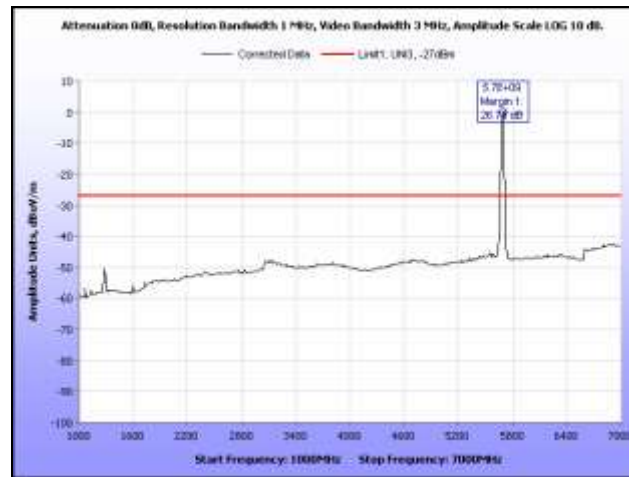

Plot 285. Radiated Spurious, 802.11n 40 MHz, 5690 MHz, 1 GHz – 7 GHz, Omni Antenna

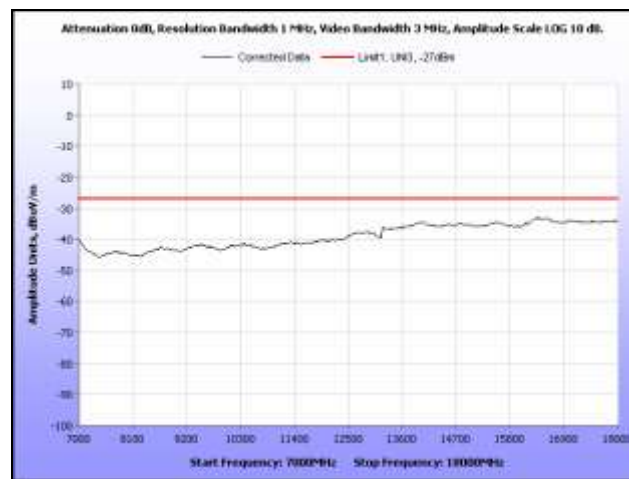

Plot 286. Radiated Spurious, 802.11n 40 MHz, 5690 MHz, 7 GHz – 18 GHz, Omni Antenna

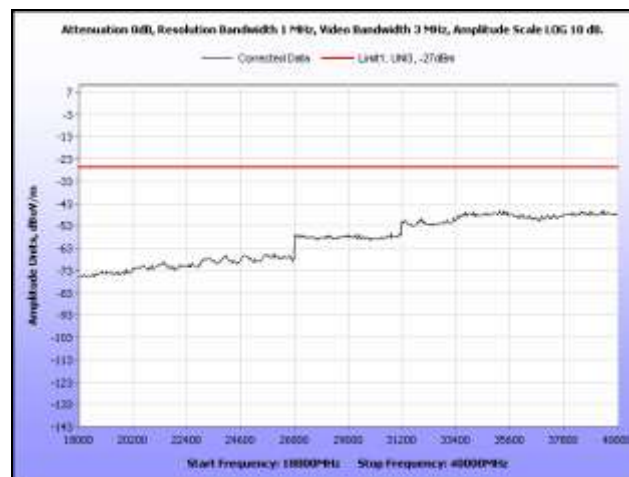

Plot 287. Radiated Spurious, 802.11n 40 MHz, 5690 MHz, 18 GHz – 40 GHz, Omni Antenna

## Radiated Spurious Emissions Limits, 802.11a, Sector Antenna

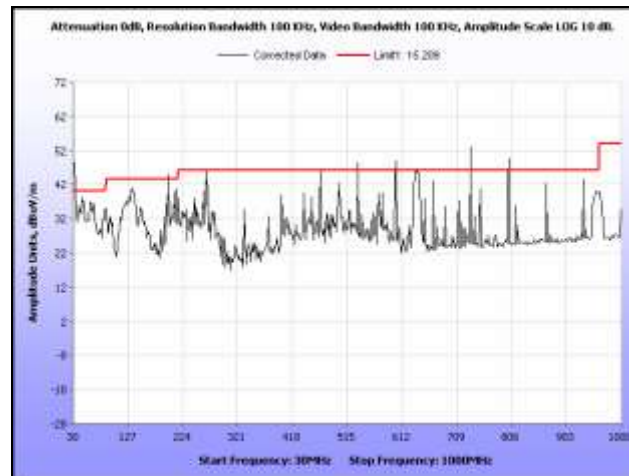

Plot 288. Radiated Spurious, 802.11a, 5260 MHz, 30 MHz – 1 GHz, Sector Antenna

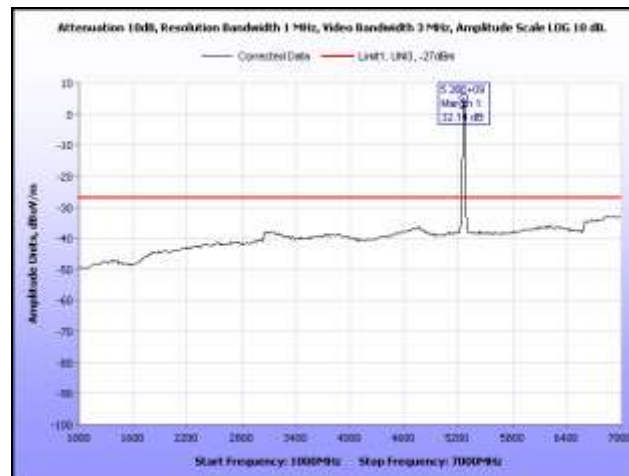

Plot 289. Radiated Spurious, 802.11a, 5260 MHz, 1 GHz – 7 GHz, Sector Antenna

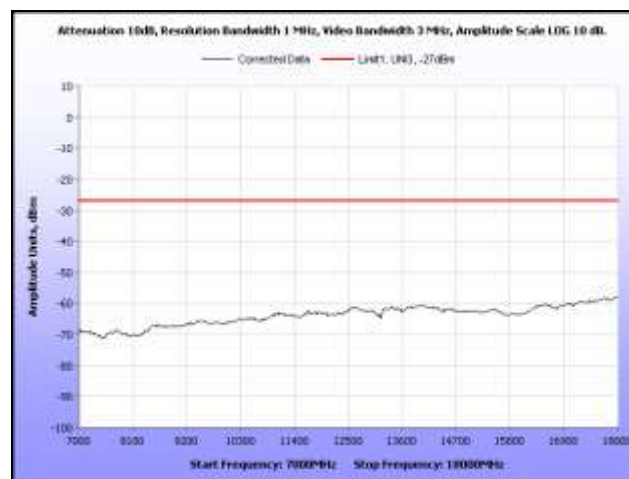

Plot 290. Radiated Spurious, 802.11a, 5260 MHz, 7 GHz – 18 GHz, Sector Antenna



Plot 291. Radiated Spurious, 802.11a, 5260 MHz, 18 GHz – 40 GHz, Sector Antenna

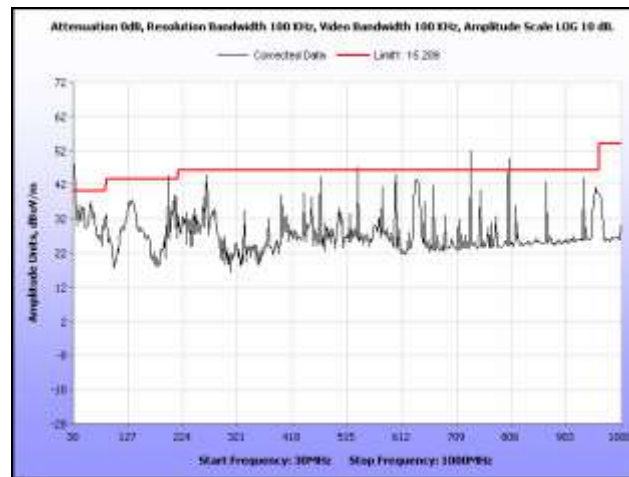

Plot 292. Radiated Spurious, 802.11a, 5300 MHz, 30 MHz – 1 GHz, Sector Antenna

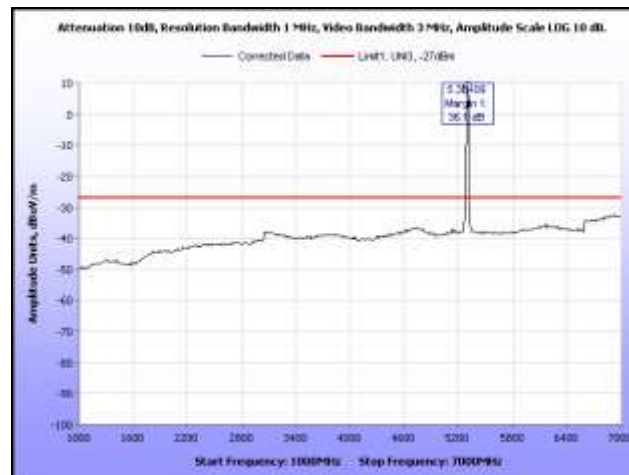

Plot 293. Radiated Spurious, 802.11a, 5300 MHz, 1 GHz – 7 GHz, Sector Antenna

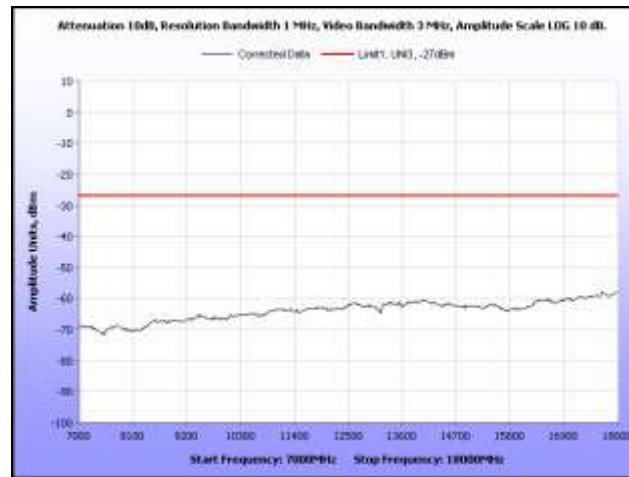

Plot 294. Radiated Spurious, 802.11a, 5300 MHz, 7 GHz – 18 GHz, Sector Antenna



Plot 295. Radiated Spurious, 802.11a, 5300 MHz, 18 GHz – 40 GHz, Sector Antenna

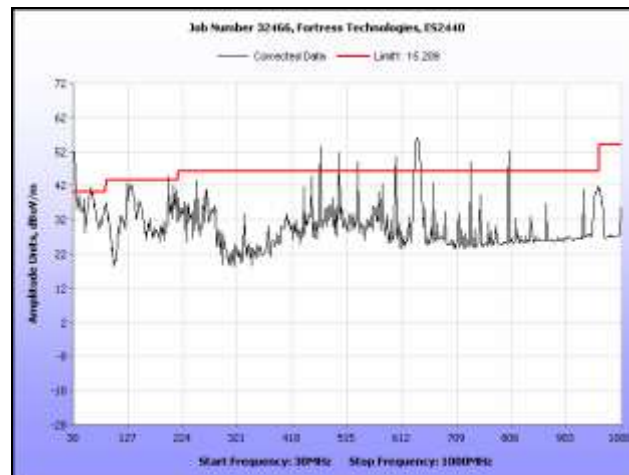

Plot 296. Radiated Spurious, 802.11a, 5320 MHz, 30 MHz – 1 GHz, Sector Antenna

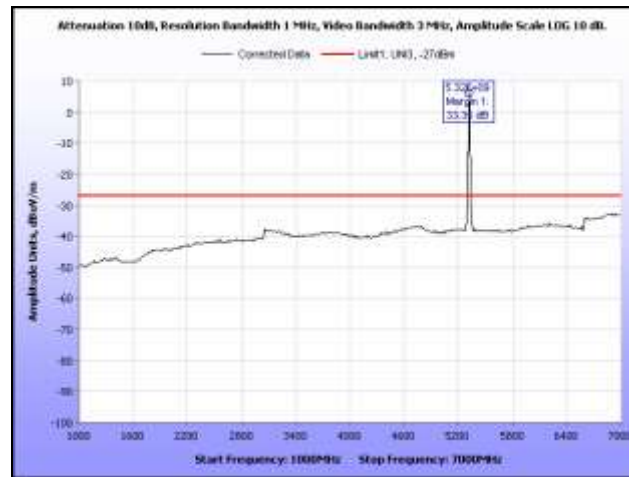

Plot 297. Radiated Spurious, 802.11a, 5320 MHz, 1 GHz – 7 GHz, Sector Antenna

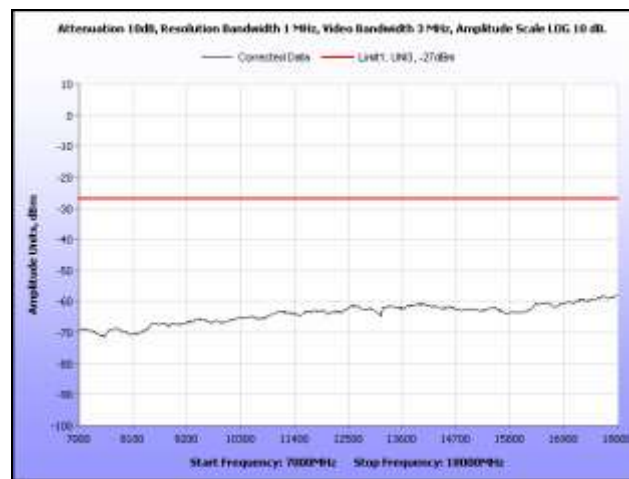

Plot 298. Radiated Spurious, 802.11a, 5320 MHz, 7 GHz – 18 GHz, Sector Antenna



Plot 299. Radiated Spurious, 802.11a, 5320 MHz, 18 GHz – 40 GHz, Sector Antenna

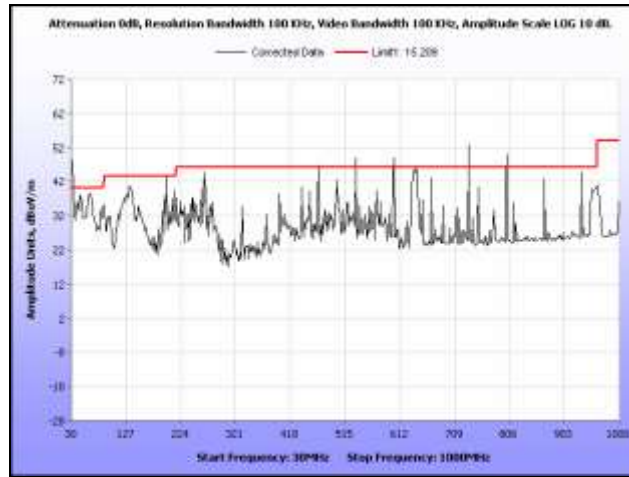

Plot 300. Radiated Spurious, 802.11a, 5500 MHz, 30 MHz – 1 GHz, Sector Antenna

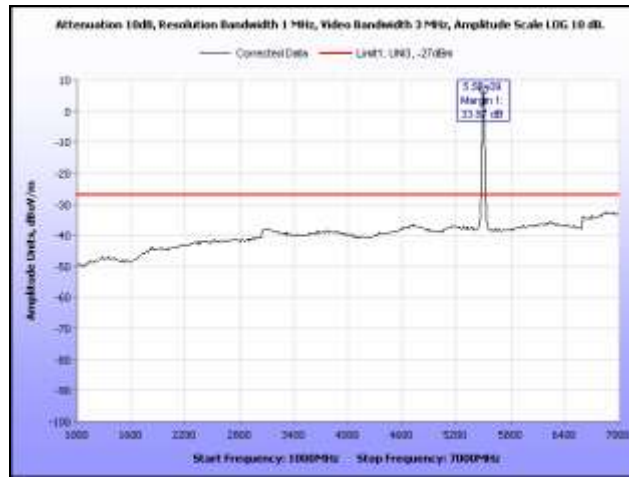

Plot 301. Radiated Spurious, 802.11a, 5500 MHz, 1 GHz – 7 GHz, Sector Antenna

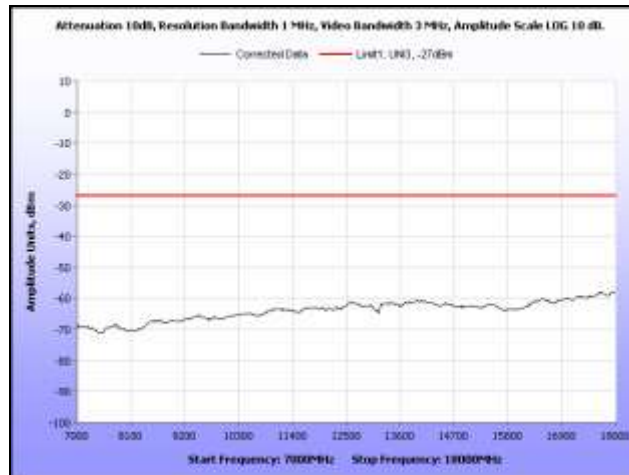

Plot 302. Radiated Spurious, 802.11a, 5500 MHz, 7 GHz – 18 GHz, Sector Antenna





Plot 303. Radiated Spurious, 802.11a, 5500 MHz, 18 MHz – 40 GHz, Sector Antenna

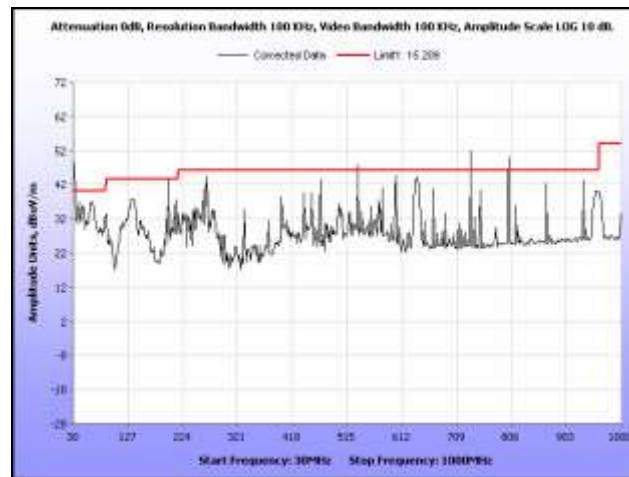

Plot 304. Radiated Spurious, 802.11a, 5580 MHz, 30 MHz – 1 GHz, Sector Antenna



Plot 305. Radiated Spurious, 802.11a, 5580 MHz, 1 GHz – 7 GHz, Sector Antenna

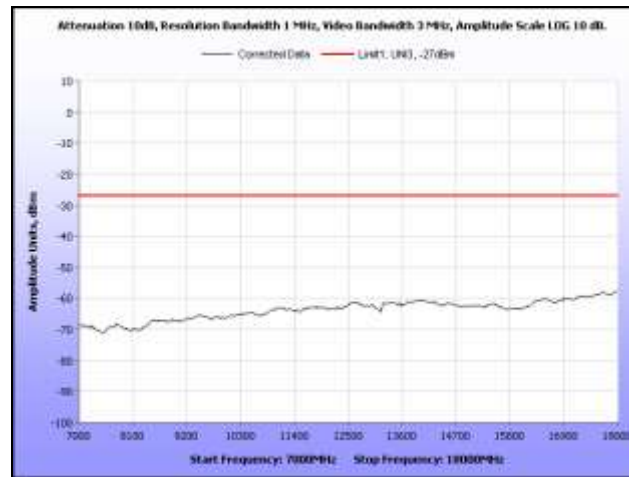

Plot 306. Radiated Spurious, 802.11a, 5580 MHz, 7 GHz – 18 GHz, Sector Antenna



Plot 307. Radiated Spurious, 802.11a, 5580 MHz, 18 GHz – 40 GHz, Sector Antenna

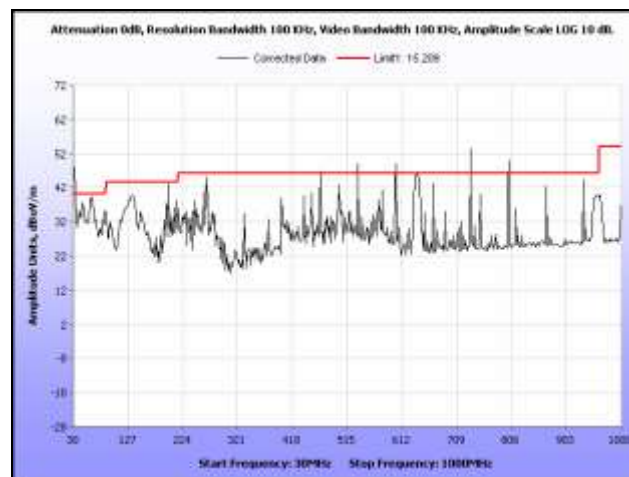

Plot 308. Radiated Spurious, 802.11a, 5700 MHz, 30 MHz – 1 GHz, Sector Antenna



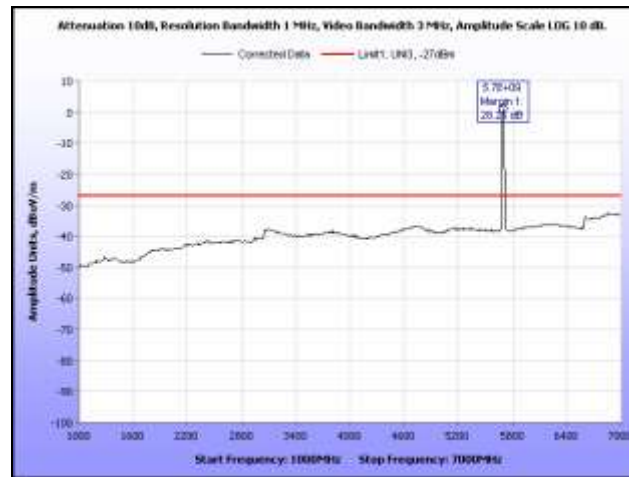

Plot 309. Radiated Spurious, 802.11a, 5700 MHz, 1 GHz – 7 GHz, Sector Antenna

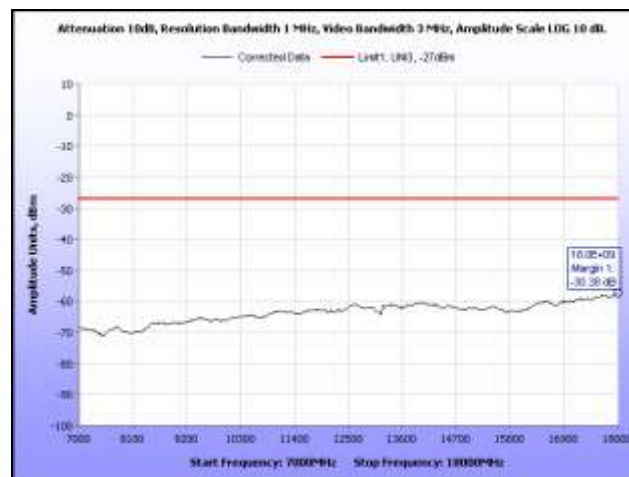

Plot 310. Radiated Spurious, 802.11a, 5700 MHz, 7 GHz – 18 GHz, Sector Antenna



Plot 311. Radiated Spurious, 802.11a, 5700 MHz, 18 GHz – 40 GHz, Sector Antenna

**Radiated Spurious Emissions Limits, 802.11n 20 MHz, Sector Antenna**

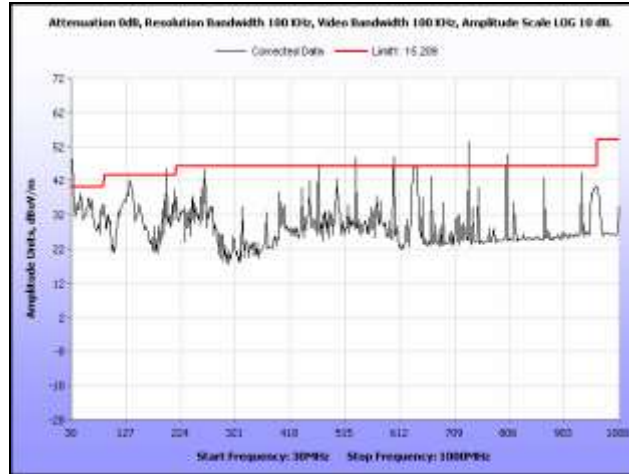

**Plot 312. Radiated Spurious, 802.11n 20 MHz, 5260 MHz, 30 MHz – 1 GHz, Sector Antenna**

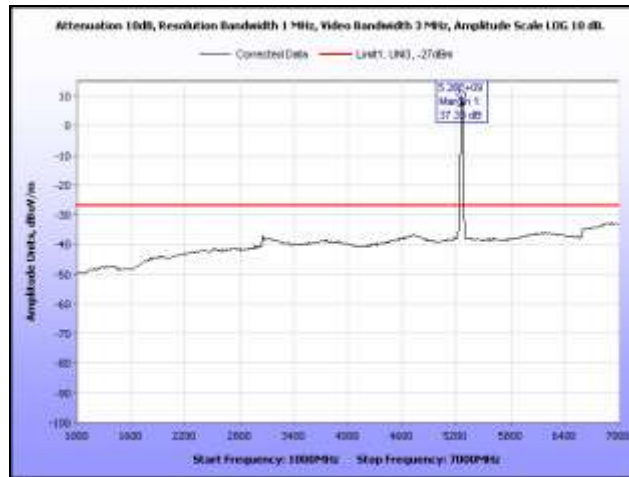

**Plot 313. Radiated Spurious, 802.11n 20 MHz, 5260 MHz, 1 GHz – 7 GHz, Sector Antenna**

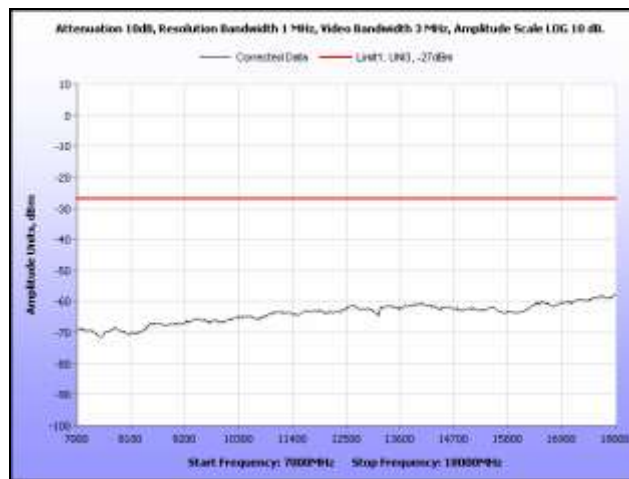

**Plot 314. Radiated Spurious, 802.11n 20 MHz, 5260 MHz, 7 GHz – 18 GHz, Sector Antenna**

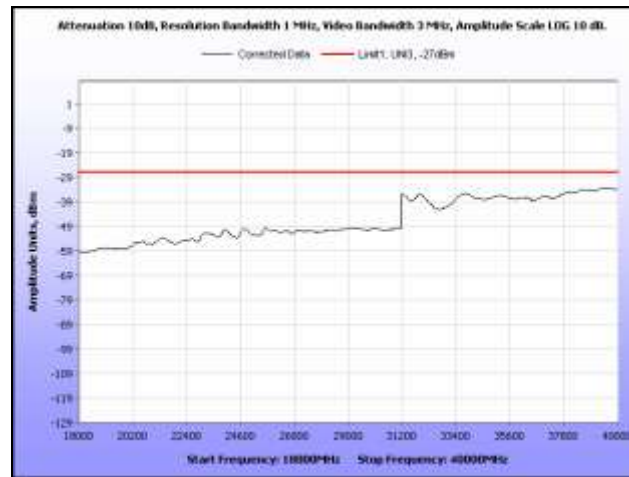

Plot 315. Radiated Spurious, 802.11n 20 MHz, 5260 MHz, 18 GHz – 40 GHz, Sector Antenna

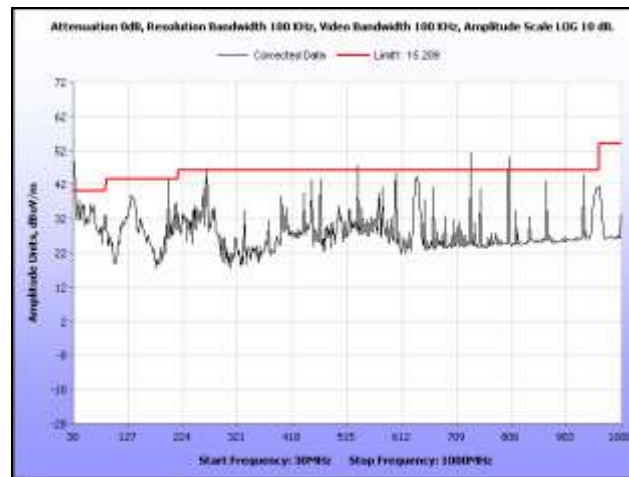

Plot 316. Radiated Spurious, 802.11n 20 MHz, 5300 MHz, 30 MHz – 1 GHz, Sector Antenna



Plot 317. Radiated Spurious, 802.11n 20 MHz, 5300 MHz, 1 GHz – 7 GHz, Sector Antenna

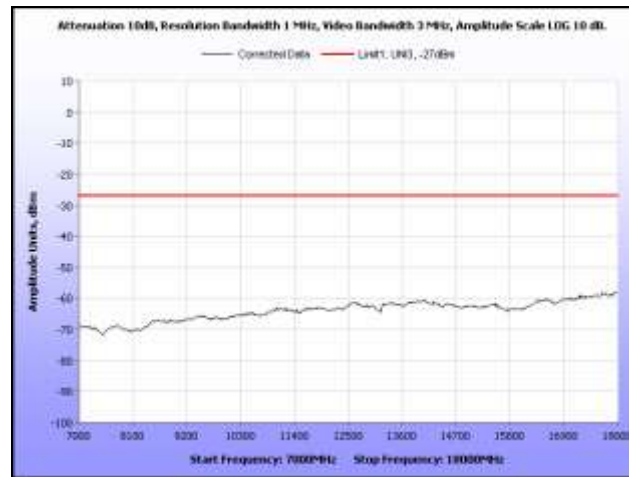

Plot 318. Radiated Spurious, 802.11n 20 MHz, 5300 MHz, 7 GHz – 18 GHz, Sector Antenna

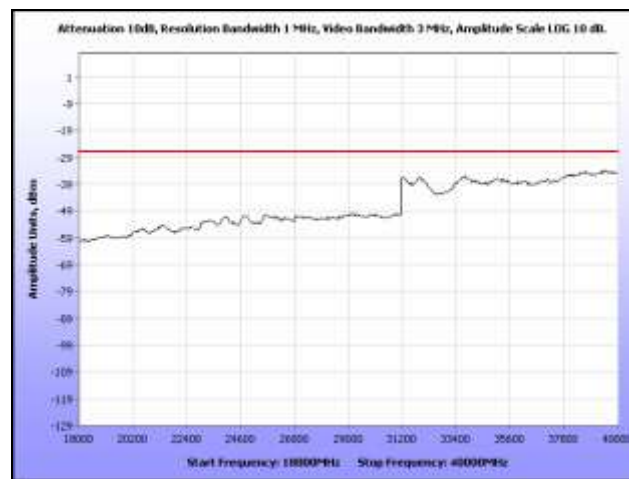

Plot 319. Radiated Spurious, 802.11n 20 MHz, 5300 MHz, 18 GHz – 40 GHz, Sector Antenna

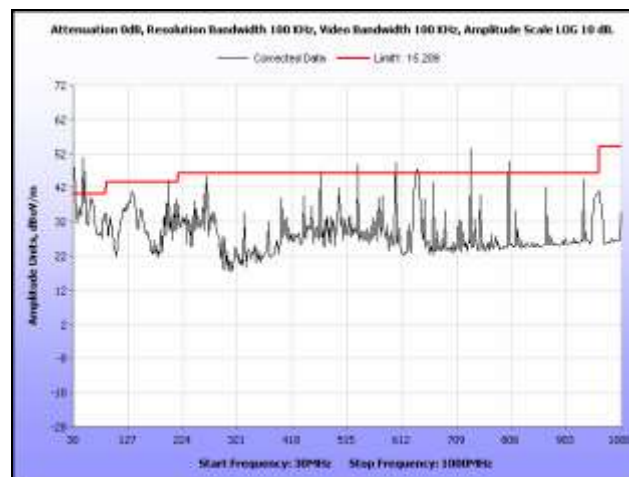

Plot 320. Radiated Spurious, 802.11n 20 MHz, 5320 MHz, 30 MHz – 1 GHz, Sector Antenna

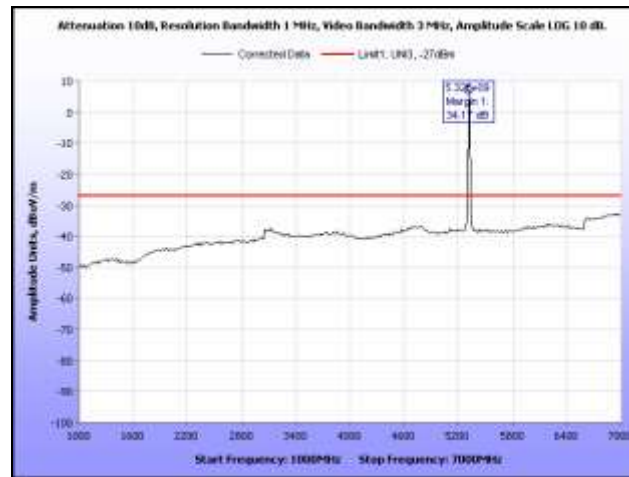

Plot 321. Radiated Spurious, 802.11n 20 MHz, 5320 MHz, 1 GHz – 7 GHz, Sector Antenna

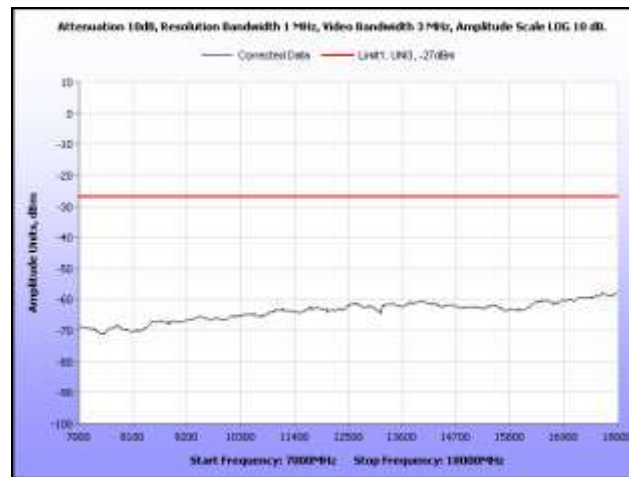

Plot 322. Radiated Spurious, 802.11n 20 MHz, 5320 MHz, 7 GHz – 18 GHz, Sector Antenna

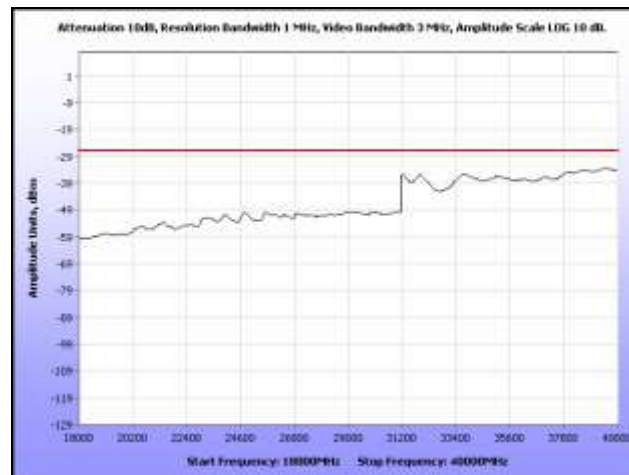

Plot 323. Radiated Spurious, 802.11n 20 MHz, 5320 MHz, 18 GHz – 40 GHz, Sector Antenna

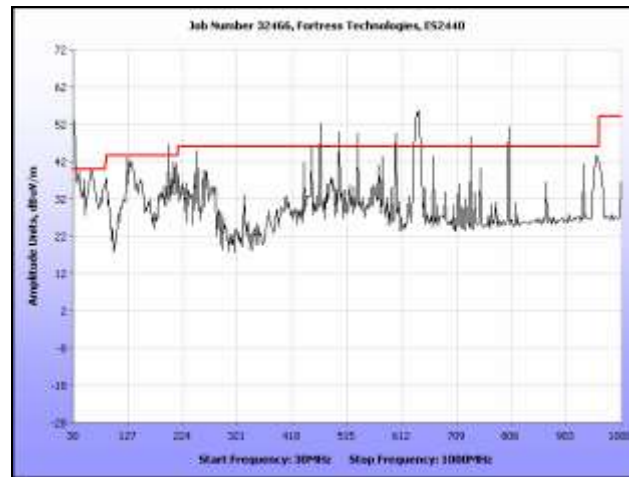

Plot 324. Radiated Spurious, 802.11n 20 MHz, 5500 MHz, 30 MHz – 1 GHz, Sector Antenna

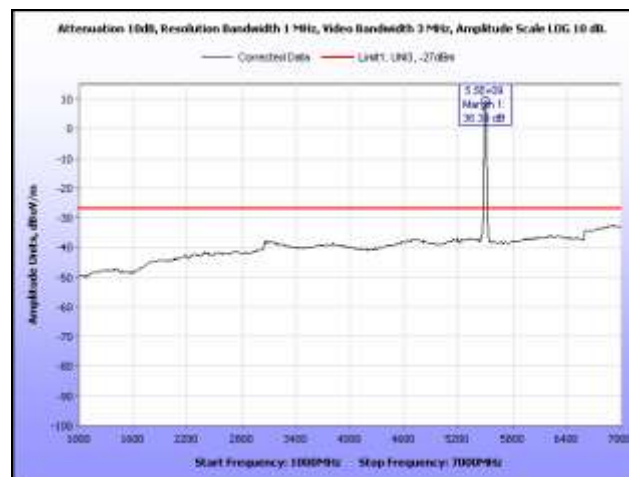

Plot 325. Radiated Spurious, 802.11n 20 MHz, 5500 MHz, 1 GHz – 7 GHz, Sector Antenna

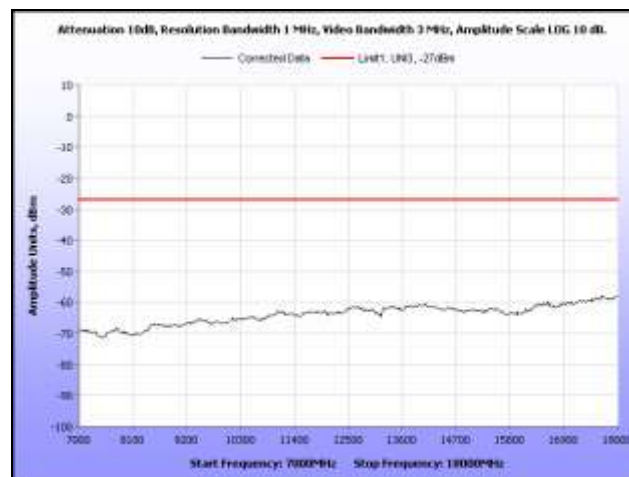

Plot 326. Radiated Spurious, 802.11n 20 MHz, 5500 MHz, 7 GHz – 18 GHz, Sector Antenna



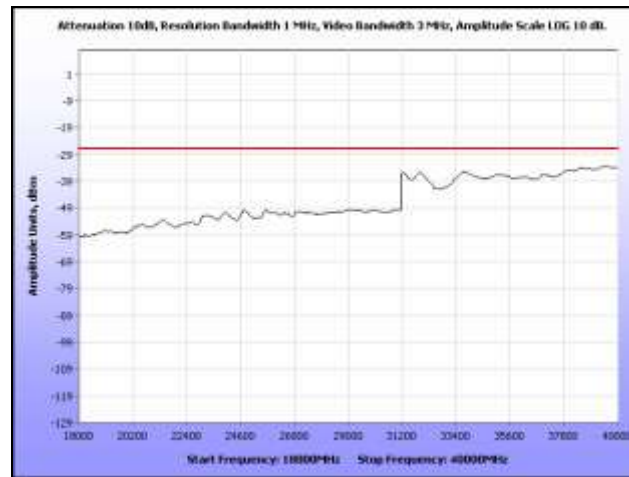

Plot 327. Radiated Spurious, 802.11n 20 MHz, 5500 MHz, 18 MHz – 40 GHz, Sector Antenna

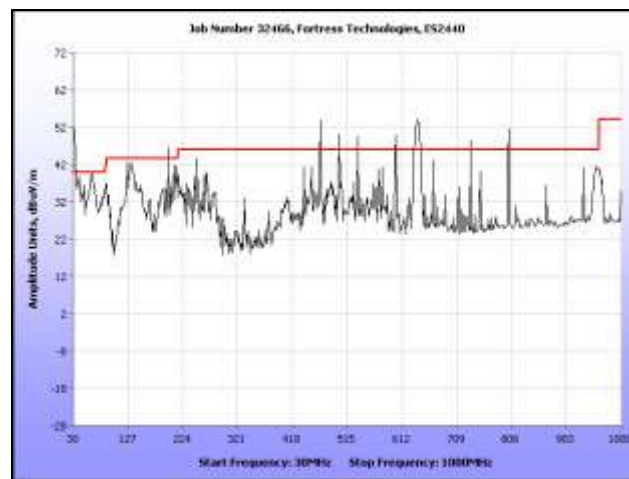

Plot 328. Radiated Spurious, 802.11n 20 MHz, 5580 MHz, 30 MHz – 1 GHz, Sector Antenna



Plot 329. Radiated Spurious, 802.11n 20 MHz, 5580 MHz, 1 GHz – 7 GHz, Sector Antenna

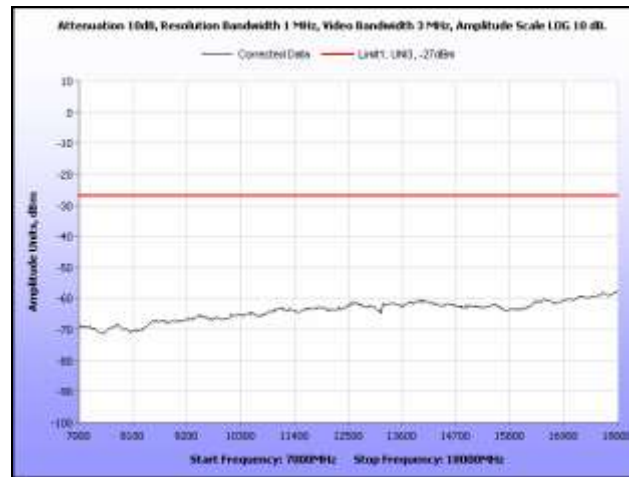

Plot 330. Radiated Spurious, 802.11n 20 MHz, 5580 MHz, 7 GHz – 18 GHz, Sector Antenna

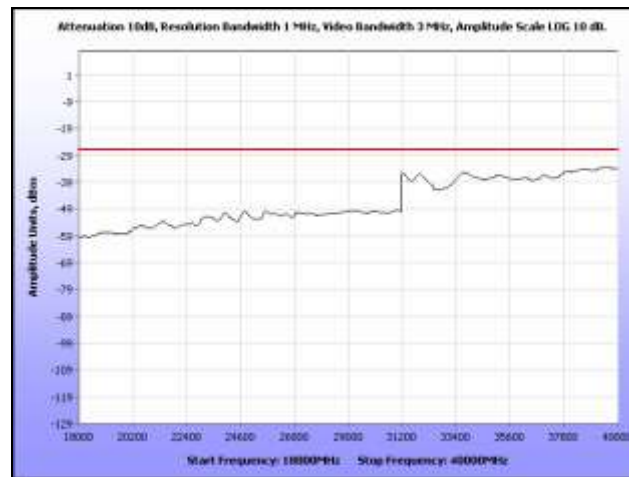

Plot 331. Radiated Spurious, 802.11n 20 MHz, 5580 MHz, 18 GHz – 40 GHz, Sector Antenna

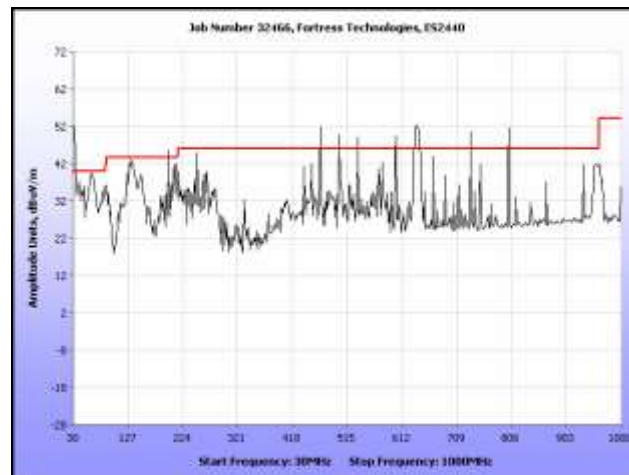

Plot 332. Radiated Spurious, 802.11n 20 MHz, 5700 MHz, 30 MHz – 1 GHz, Sector Antenna



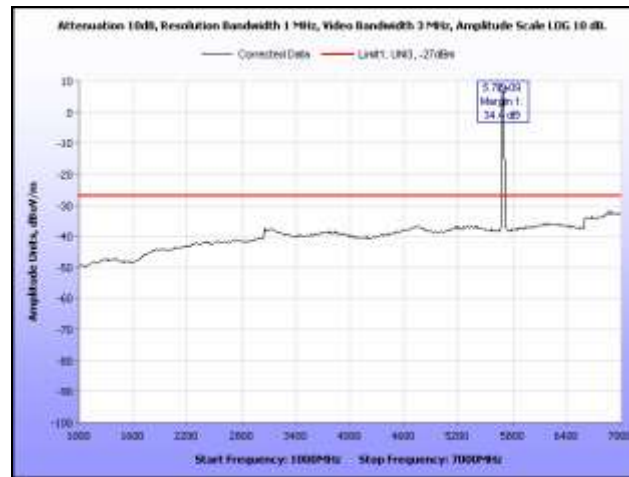

Plot 333. Radiated Spurious, 802.11n 20 MHz, 5700 MHz, 1 GHz – 7 GHz, Sector Antenna

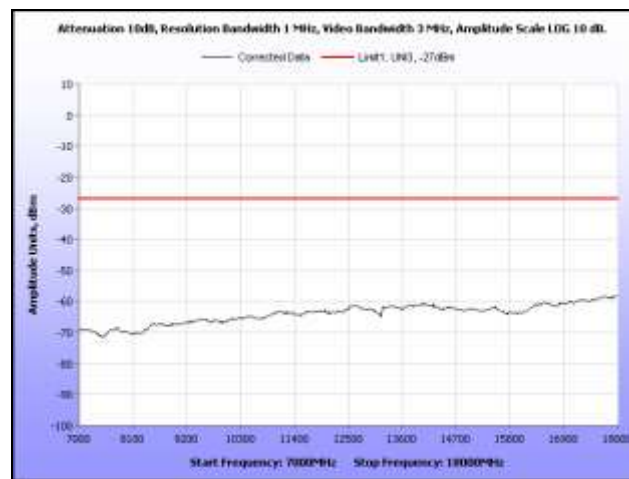

Plot 334. Radiated Spurious, 802.11n 20 MHz, 5700 MHz, 7 GHz – 18 GHz, Sector Antenna

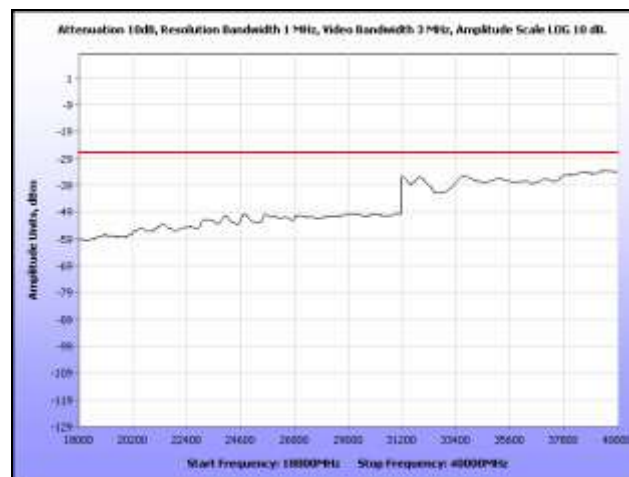

Plot 335. Radiated Spurious, 802.11n 20 MHz, 5700 MHz, 18 GHz – 40 GHz, Sector Antenna

### Radiated Spurious Emissions Limits, 802.11n 40 MHz, Sector Antenna

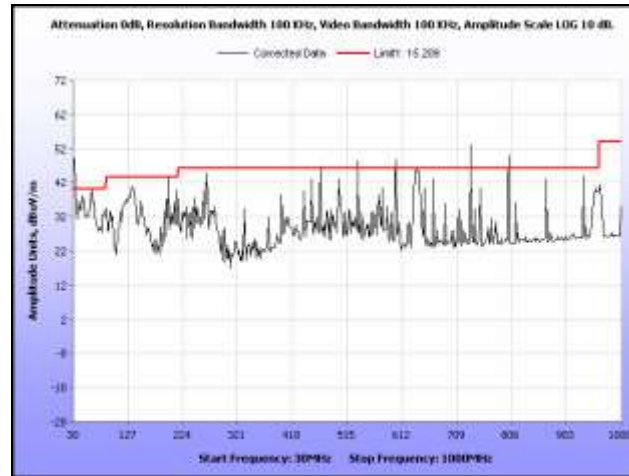

Plot 336. Radiated Spurious, 802.11n 40 MHz, 5270 MHz, 30 MHz – 1 GHz, Sector Antenna

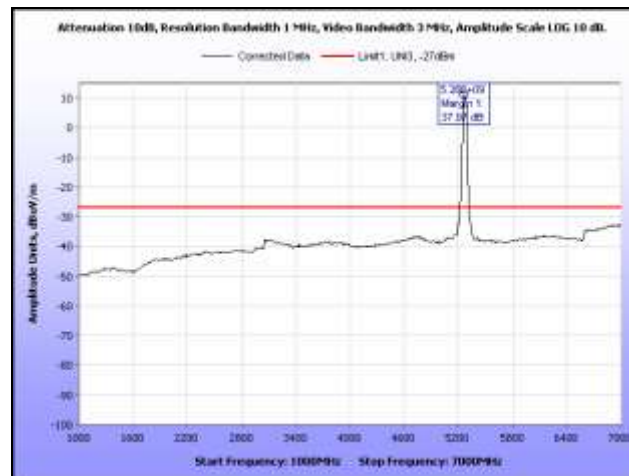

Plot 337. Radiated Spurious, 802.11n 40 MHz, 5270 MHz, 1 GHz – 7 GHz, Sector Antenna

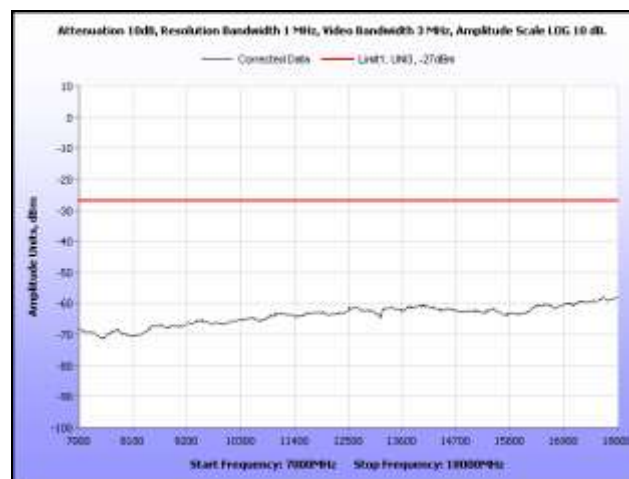

Plot 338. Radiated Spurious, 802.11n 40 MHz, 5270 MHz, 7 GHz – 18 GHz, Sector Antenna

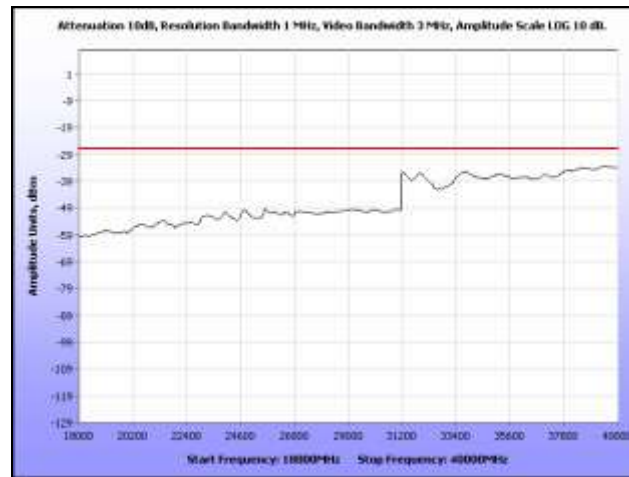

Plot 339. Radiated Spurious, 802.11n 40 MHz, 5270 MHz, 18 GHz – 40 GHz, Sector Antenna

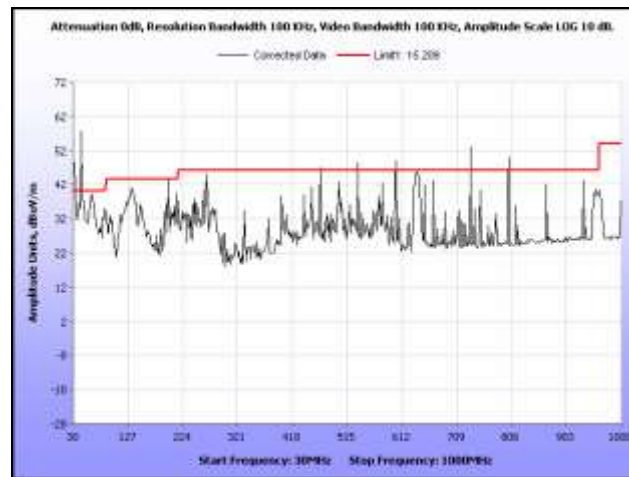

Plot 340. Radiated Spurious, 802.11n 40 MHz, 5300 MHz, 30 MHz – 1 GHz, Sector Antenna

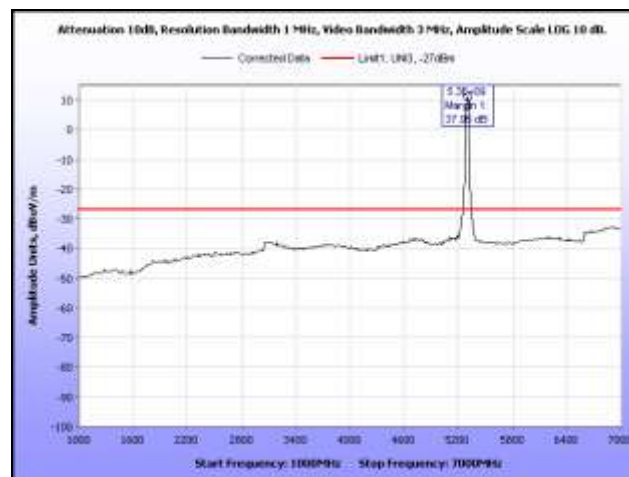

Plot 341. Radiated Spurious, 802.11n 40 MHz, 5300 MHz, 1 GHz – 7 GHz, Sector Antenna

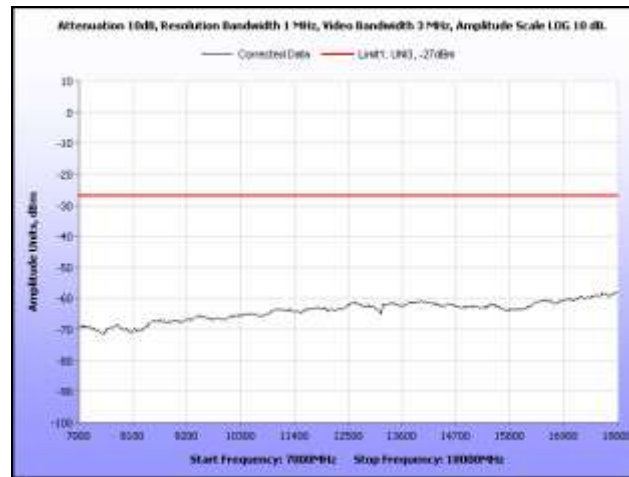

Plot 342. Radiated Spurious, 802.11n 40 MHz, 5300 MHz, 7 GHz – 18 GHz, Sector Antenna

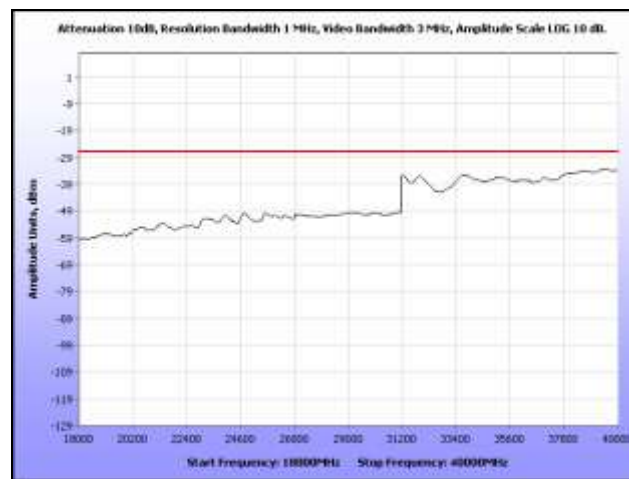

Plot 343. Radiated Spurious, 802.11n 40 MHz, 5300 MHz, 18 GHz – 40 GHz, Sector Antenna

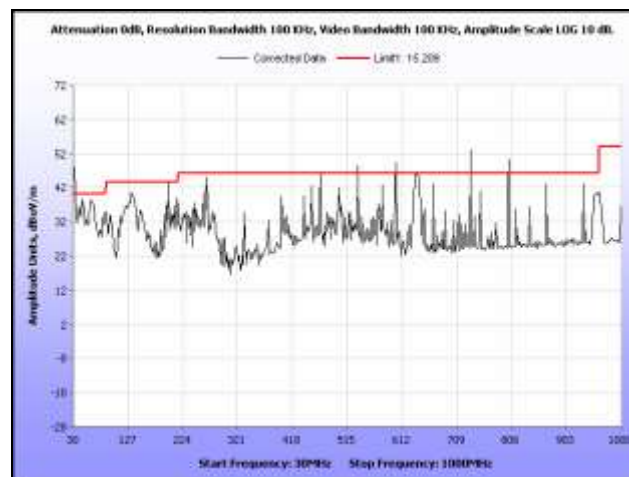

Plot 344. Radiated Spurious, 802.11n 40 MHz, 5310 MHz, 30 MHz – 1 GHz, Sector Antenna

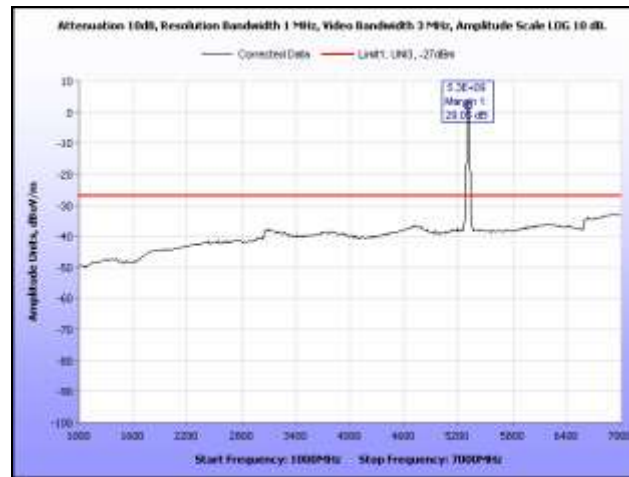

Plot 345. Radiated Spurious, 802.11n 40 MHz, 5310 MHz, 1 GHz – 7 GHz, Sector Antenna

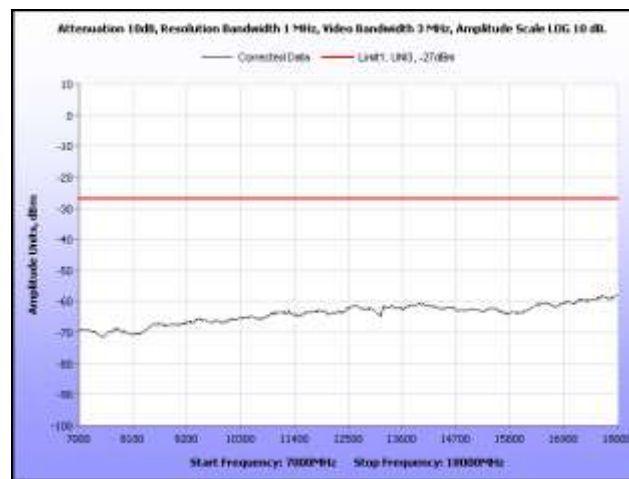

Plot 346. Radiated Spurious, 802.11n 40 MHz, 5310 MHz, 7 GHz – 18 GHz, Sector Antenna

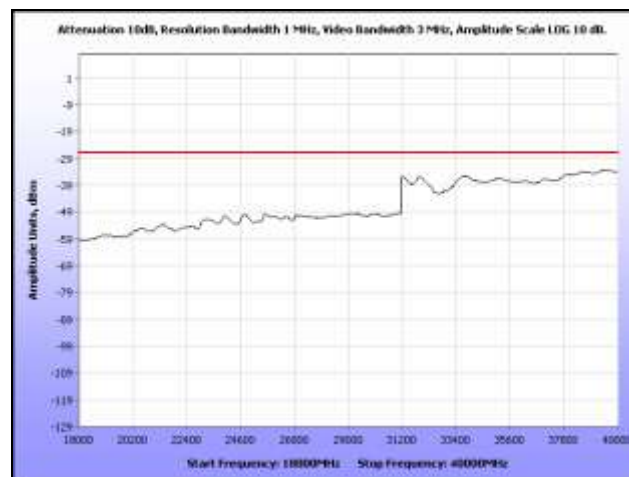

Plot 347. Radiated Spurious, 802.11n 40 MHz, 5310 MHz, 18 GHz – 40 GHz, Sector Antenna

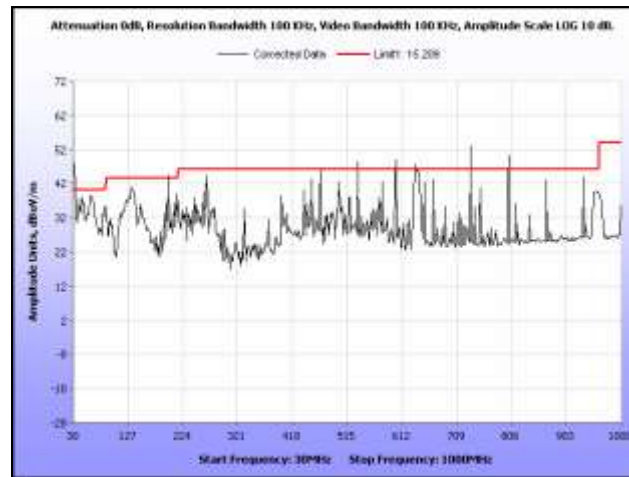

Plot 348. Radiated Spurious, 802.11n 40 MHz, 5510 MHz, 30 MHz – 1 GHz, Sector Antenna

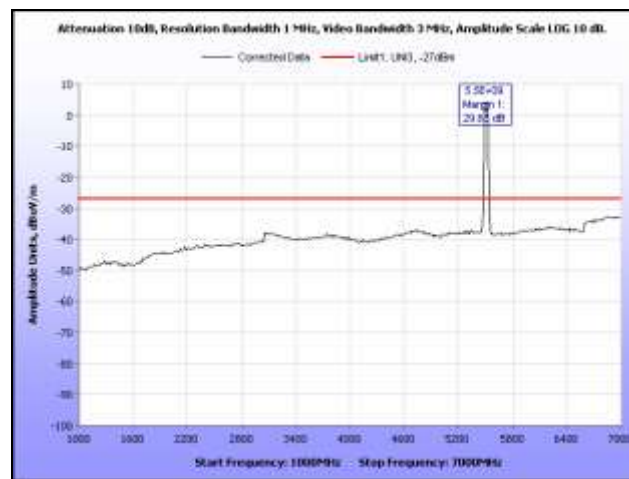

Plot 349. Radiated Spurious, 802.11n 40 MHz, 5510 MHz, 1 GHz – 7 GHz, Sector Antenna

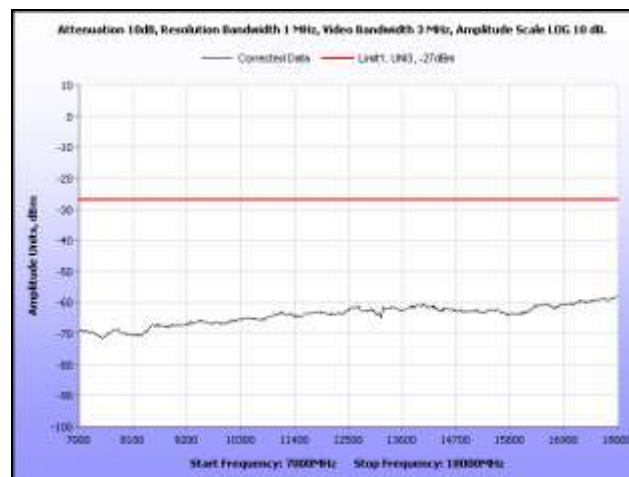

Plot 350. Radiated Spurious, 802.11n 40 MHz, 5510 MHz, 7 GHz – 18 GHz, Sector Antenna



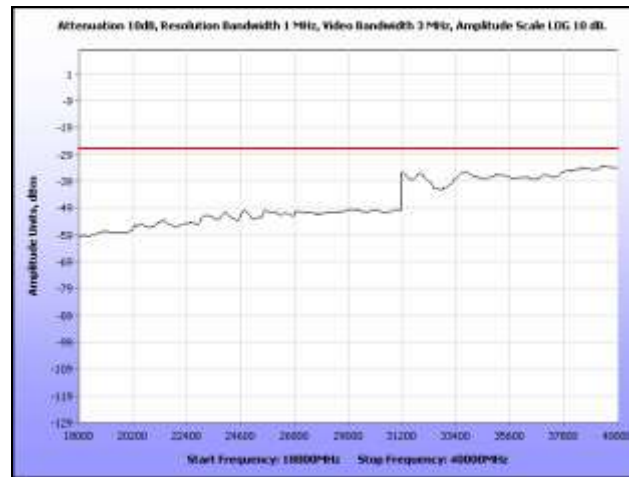

Plot 351. Radiated Spurious, 802.11n 40 MHz, 5510 MHz, 18 MHz – 40 GHz, Sector Antenna

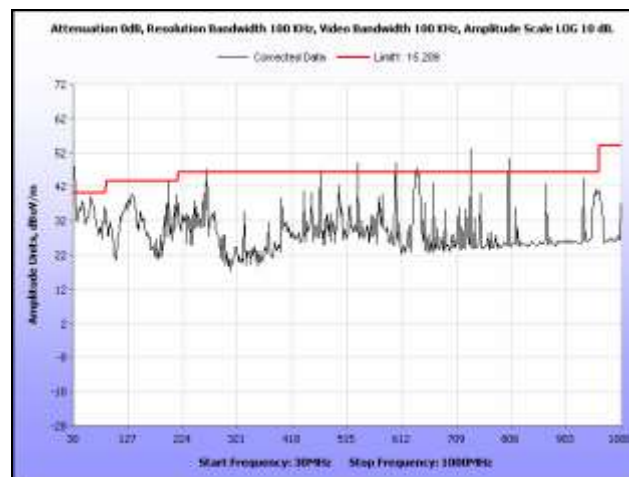

Plot 352. Radiated Spurious, 802.11n 40 MHz, 5580 MHz, 30 MHz – 1 GHz, Sector Antenna



Plot 353. Radiated Spurious, 802.11n 40 MHz, 5580 MHz, 1 GHz – 7 GHz, Sector Antenna

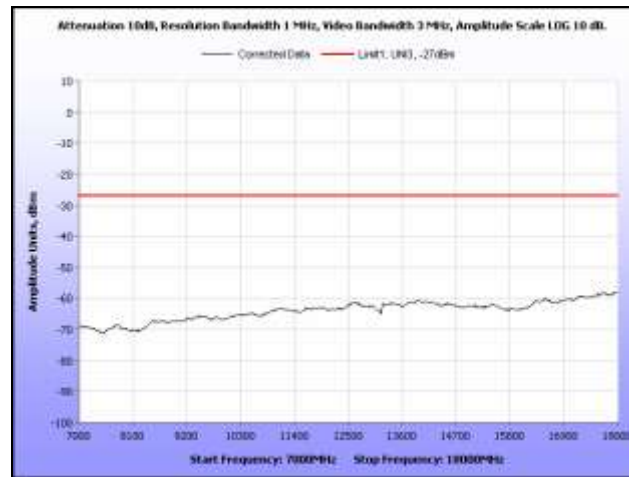

Plot 354. Radiated Spurious, 802.11n 40 MHz, 5580 MHz, 7 GHz – 18 GHz, Sector Antenna

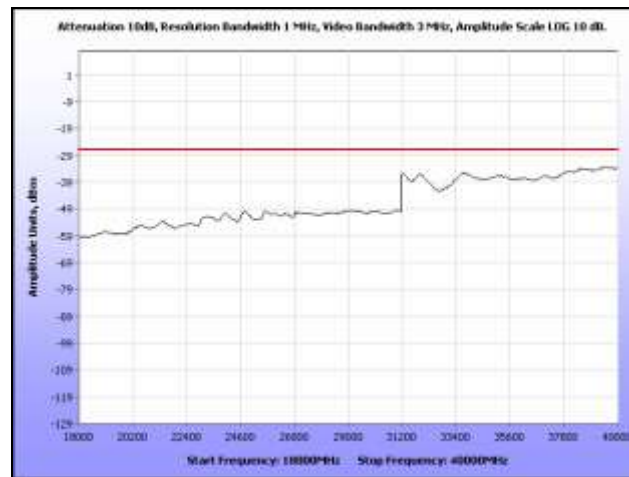

Plot 355. Radiated Spurious, 802.11n 40 MHz, 5580 MHz, 18 GHz – 40 GHz, Sector Antenna

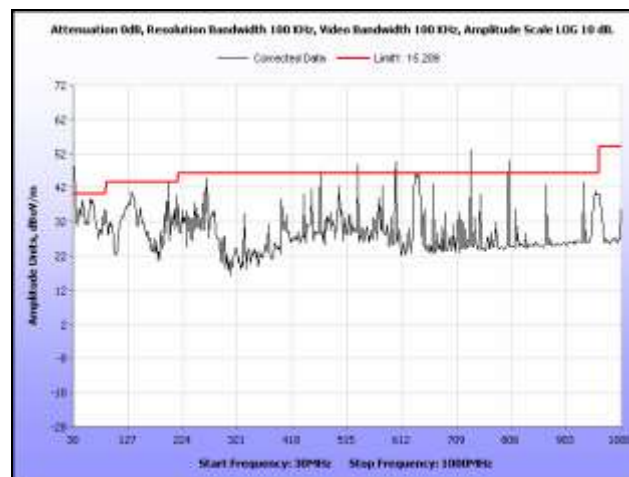

Plot 356. Radiated Spurious, 802.11n 40 MHz, 5690 MHz, 30 MHz – 1 GHz, Sector Antenna



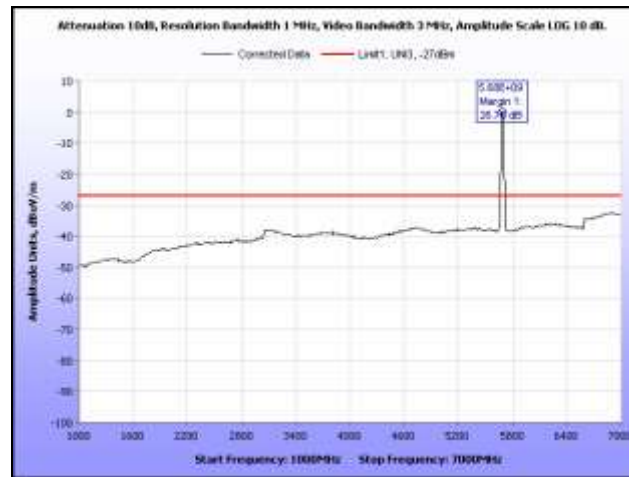

Plot 357. Radiated Spurious, 802.11n 40 MHz, 5690 MHz, 1 GHz – 7 GHz, Sector Antenna

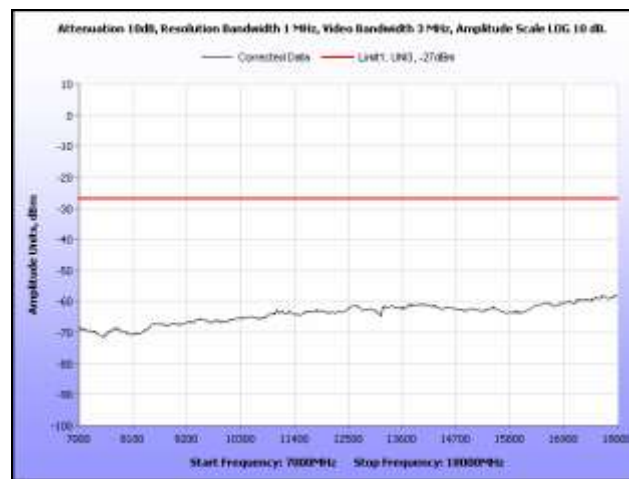

Plot 358. Radiated Spurious, 802.11n 40 MHz, 5690 MHz, 7 GHz – 18 GHz, Sector Antenna

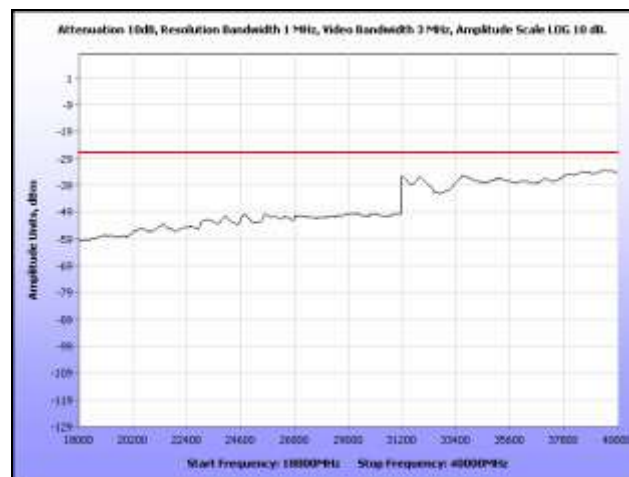

Plot 359. Radiated Spurious, 802.11n 40 MHz, 5690 MHz, 18 GHz – 40 GHz, Sector Antenna

**EIRP**  
**EIRP, 802.11a, Omni Antenna**

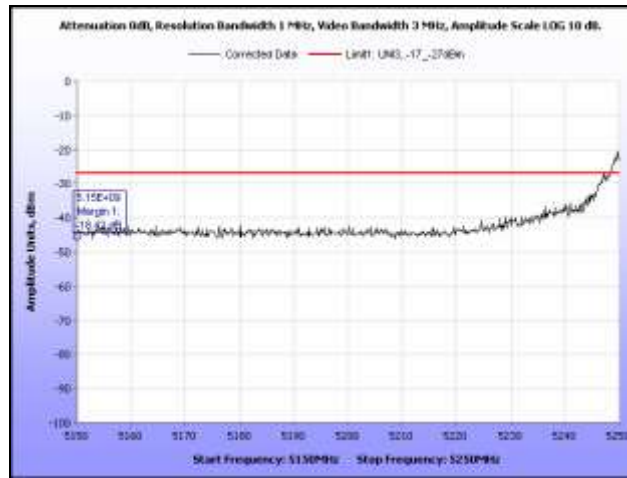

**Plot 360. EIRP, 802.11a, 5260 MHz, Band Edge, Omni Antenna**

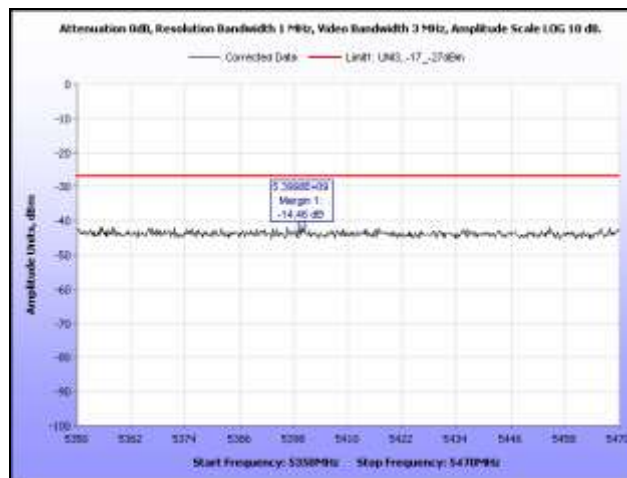

**Plot 361. EIRP, 802.11a, 5320 MHz, Band Edge, Omni Antenna**

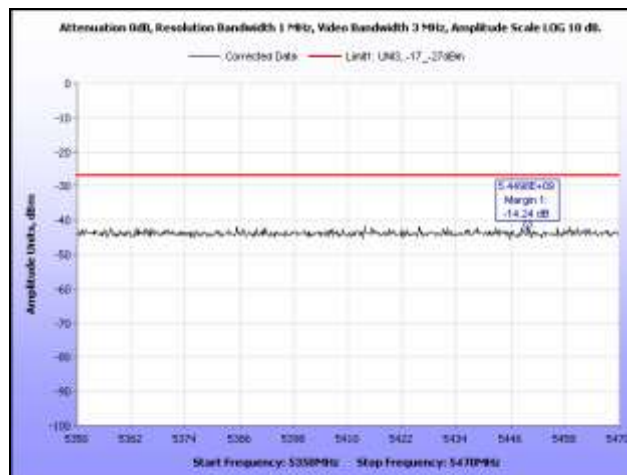

**Plot 362. EIRP, 802.11a, 5500 MHz, Band Edge, Omni Antenna**

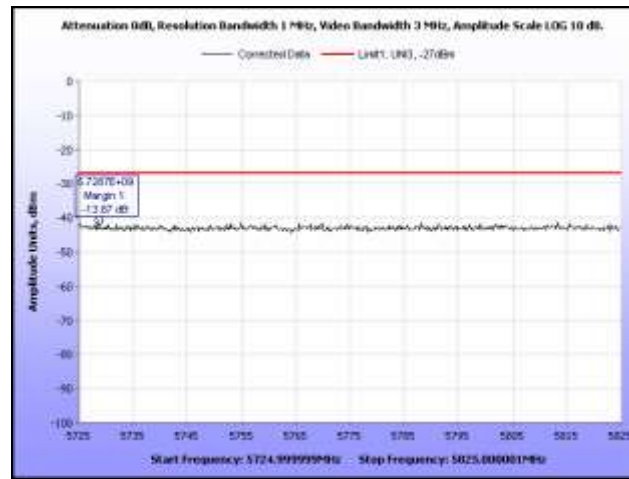

Plot 363. EIRP, 802.11a, 5700 MHz, Band Edge, Omni Antenna

**EIRP, 802.11n 20 MHz, Omni Antenna**

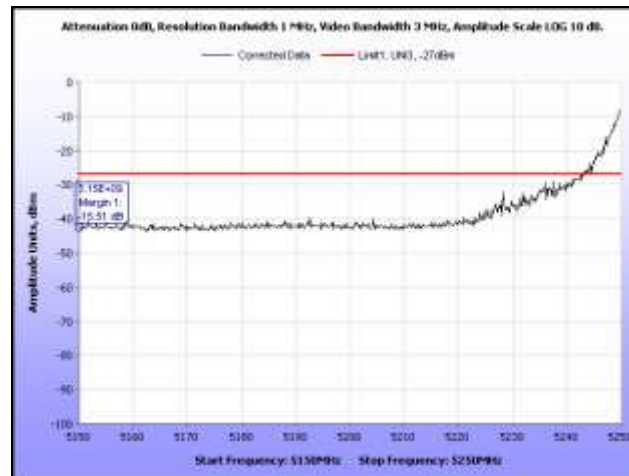

**Plot 364. EIRP, 802.11n 20 MHz, 5260 MHz, Band Edge, Omni Antenna**

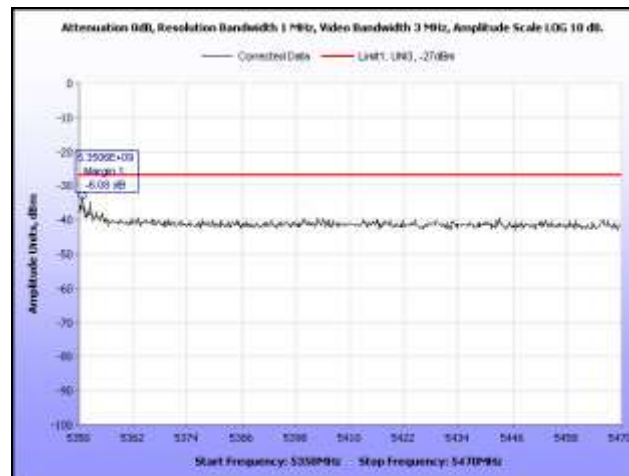

**Plot 365. EIRP, 802.11n 20 MHz, 5320 MHz, Band Edge, Omni Antenna**

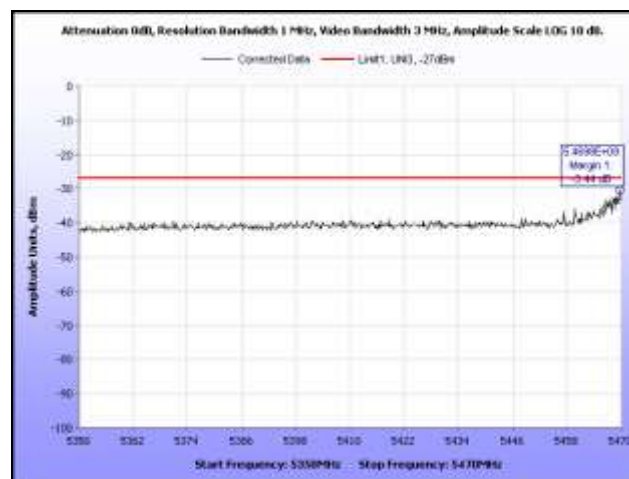

**Plot 366. EIRP, 802.11n 20 MHz, 5500 MHz, Band Edge, Omni Antenna**

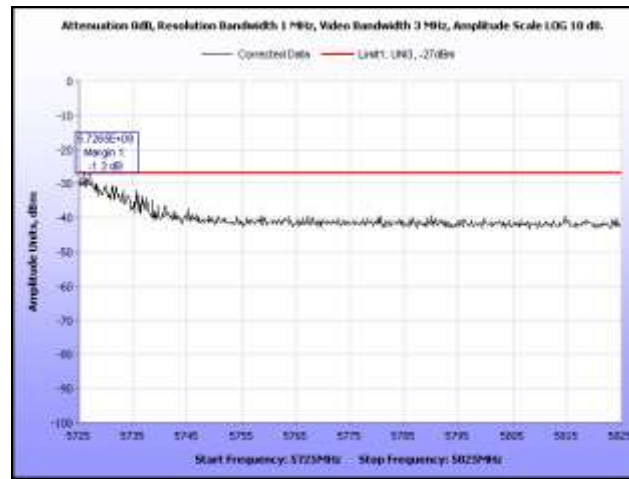

Plot 367. EIRP, 802.11n 20 MHz, 5700 MHz, Band Edge, Omni Antenna

**EIRP, 802.11n 40 MHz, Omni Antenna**

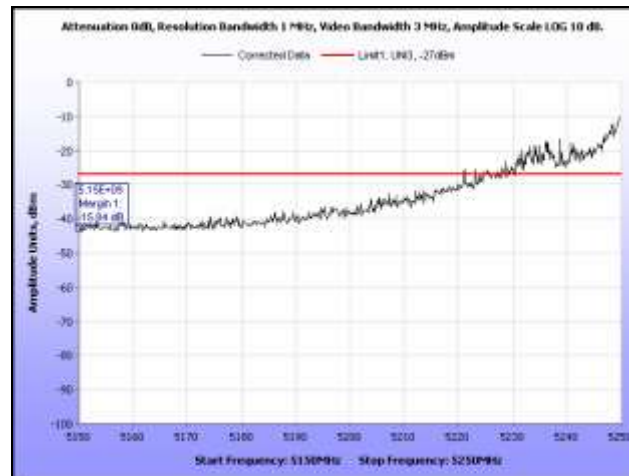

**Plot 368. EIRP, 802.11n 40 MHz, 5270 MHz, Band Edge, Omni Antenna**

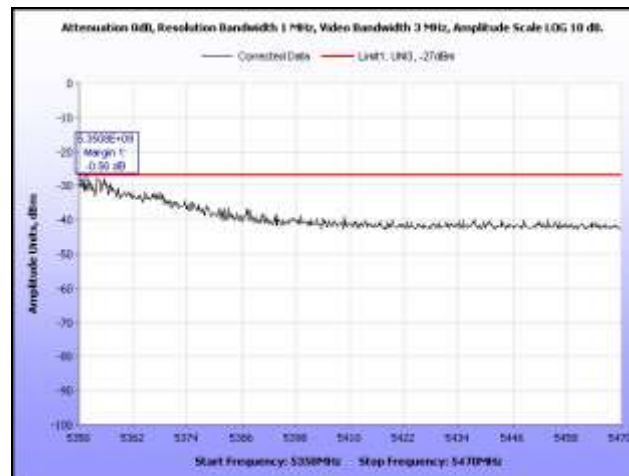

**Plot 369. EIRP, 802.11n 40 MHz, 5310 MHz, Band Edge, Omni Antenna**

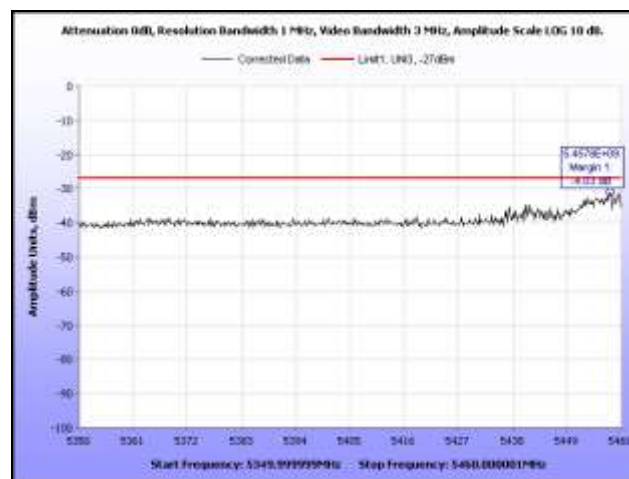

**Plot 370. EIRP, 802.11n 40 MHz, 5510 MHz, Band Edge, Omni Antenna**

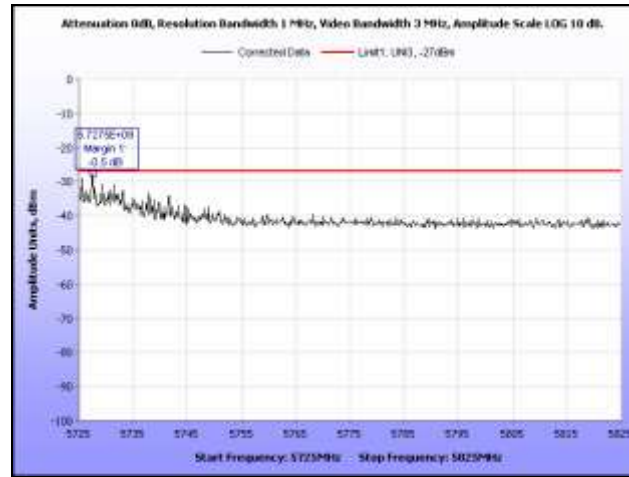

Plot 371. EIRP, 802.11n 40 MHz, 5690 MHz, Band Edge, Omni Antenna

**EIRP, 802.11a, Sector Antenna**

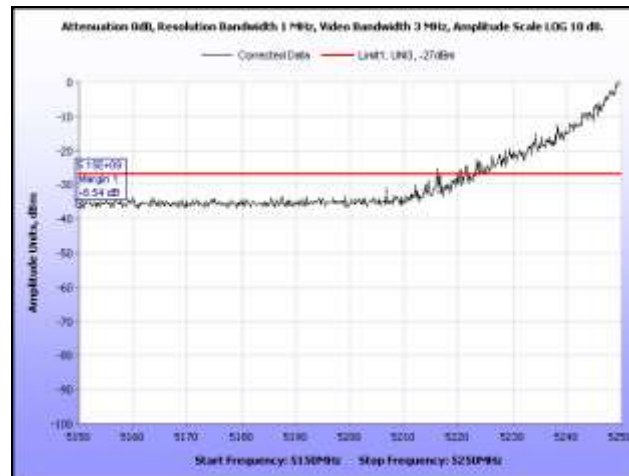

**Plot 372. EIRP, 802.11a, 5260 MHz, Band Edge, Sector Antenna**

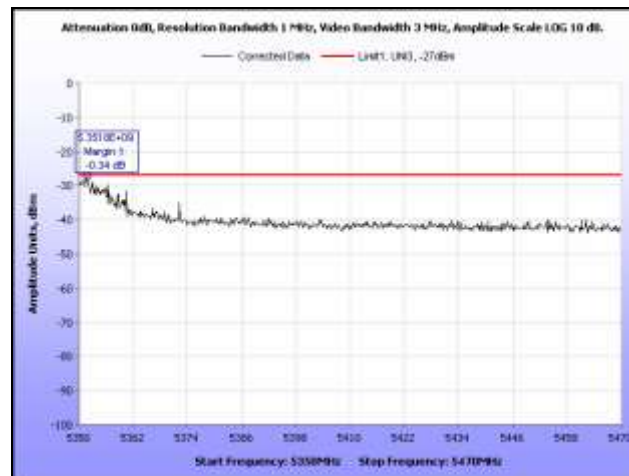

**Plot 373. EIRP, 802.11a, 5320 MHz, Band Edge, Sector Antenna**

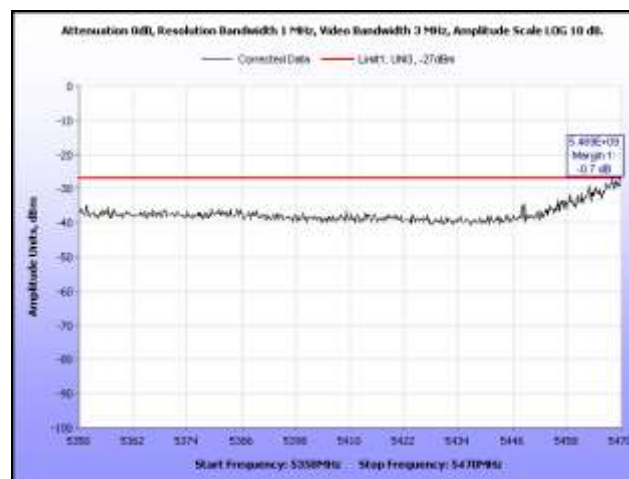

**Plot 374. EIRP, 802.11a, 5500 MHz, Band Edge, Sector Antenna**





**EIRP, 802.11n 20 MHz, Sector Antenna**

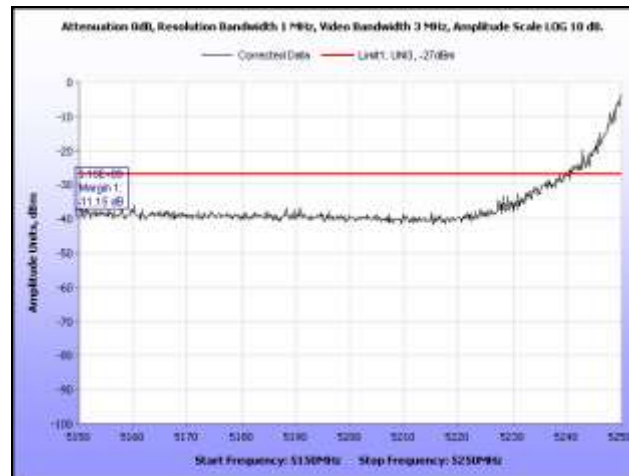

**Plot 376. EIRP, 802.11n 20 MHz, 5260 MHz, Band Edge, Sector Antenna**

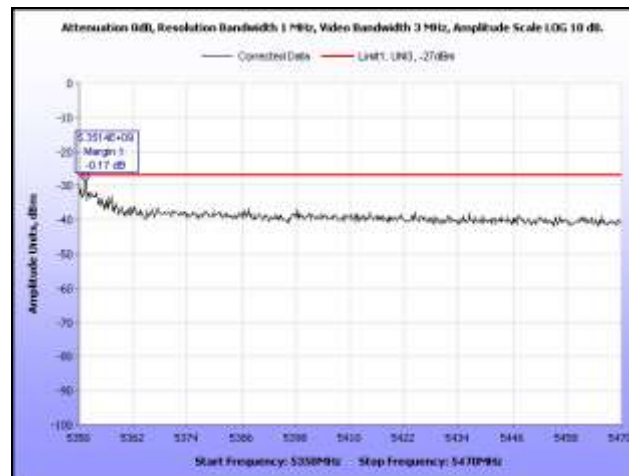

**Plot 377. EIRP, 802.11n 20 MHz, 5320 MHz, Band Edge, Sector Antenna**

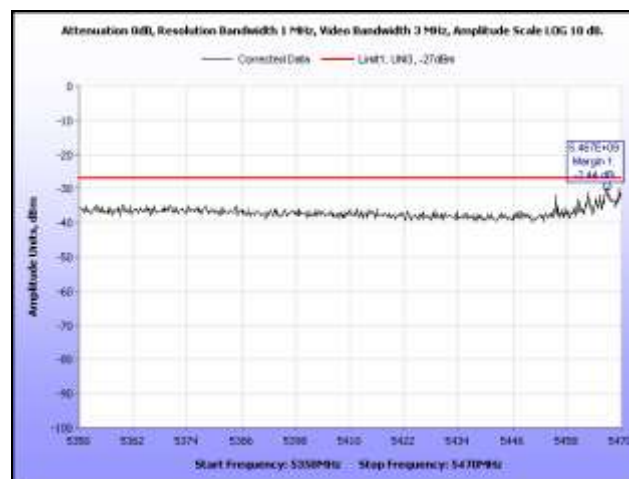

**Plot 378. EIRP, 802.11n 20 MHz, 5500 MHz, Band Edge, Sector Antenna**

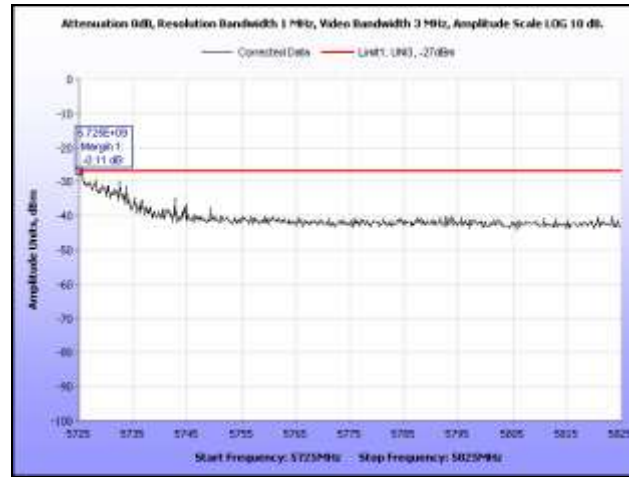

Plot 379. EIRP, 802.11n 20 MHz, 5700 MHz, Band Edge, Sector Antenna

**EIRP, 802.11n 40 MHz, Sector Antenna**

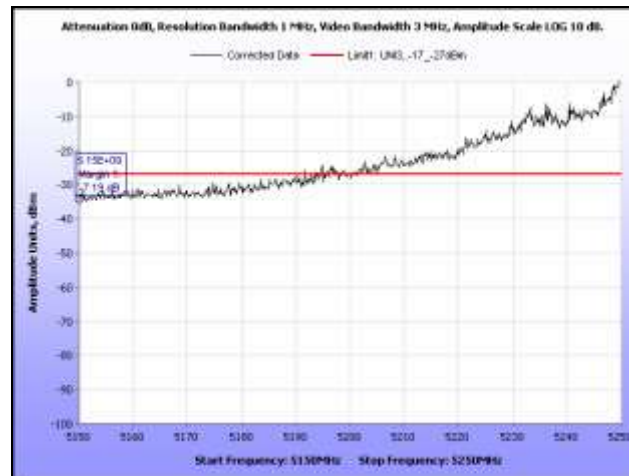

**Plot 380. EIRP, 802.11n 40 MHz, 5270 MHz, Band Edge, Sector Antenna**

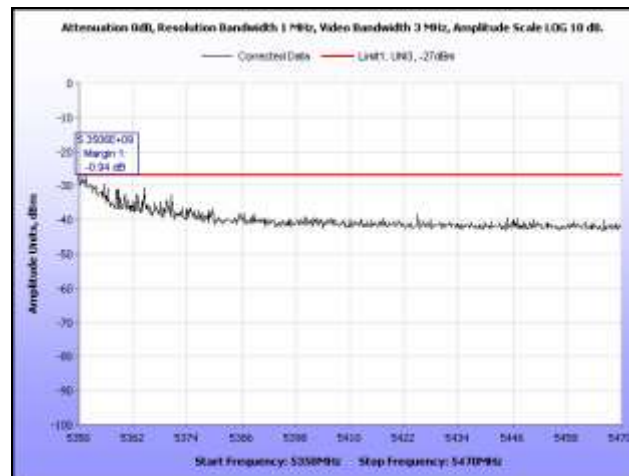

**Plot 381. EIRP, 802.11n 40 MHz, 5310 MHz, Band Edge, Sector Antenna**

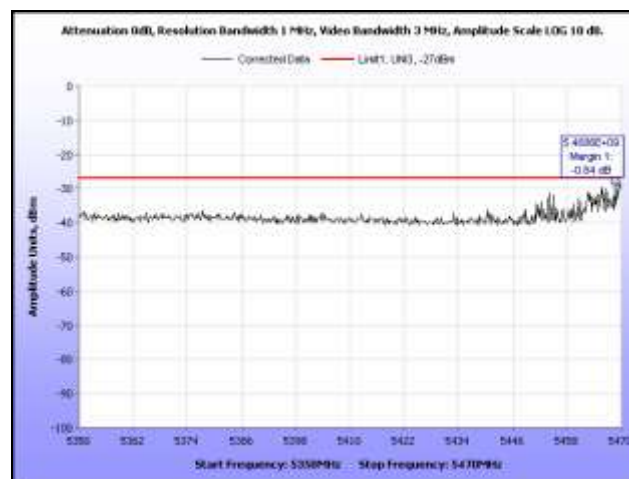

**Plot 382. EIRP, 802.11n 40 MHz, 5510 MHz, Band Edge, Sector Antenna**

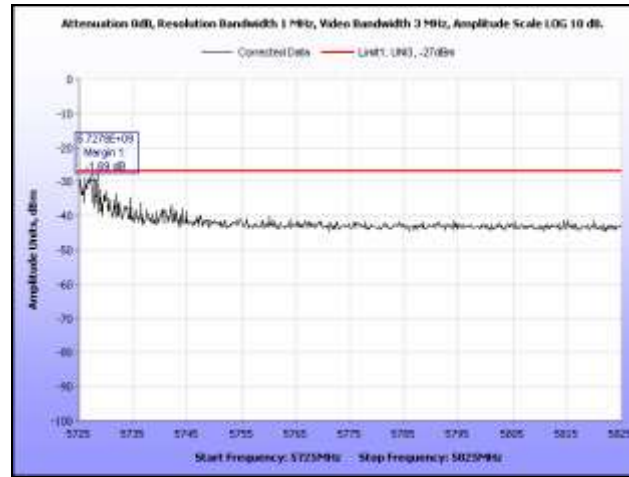

Plot 383. EIRP, 802.11n 40 MHz, 5690 MHz, Band Edge, Sector Antenna

**Restricted Band  
Restricted Band, 802.11a, Omni Antenna**

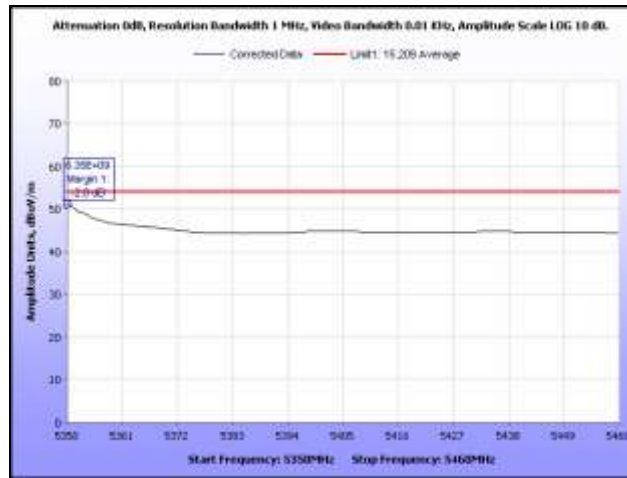

**Plot 384. Restricted Band, 802.11a, 5320 MHz, Average, Omni Antenna**

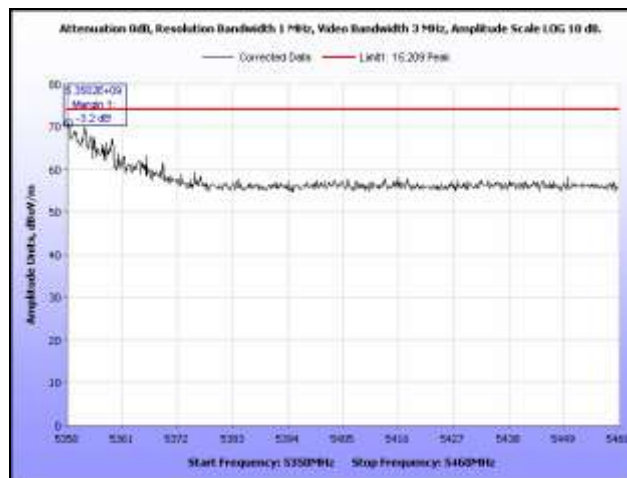

**Plot 385. Restricted Band, 802.11a, 5320 MHz, Peak, Omni Antenna**

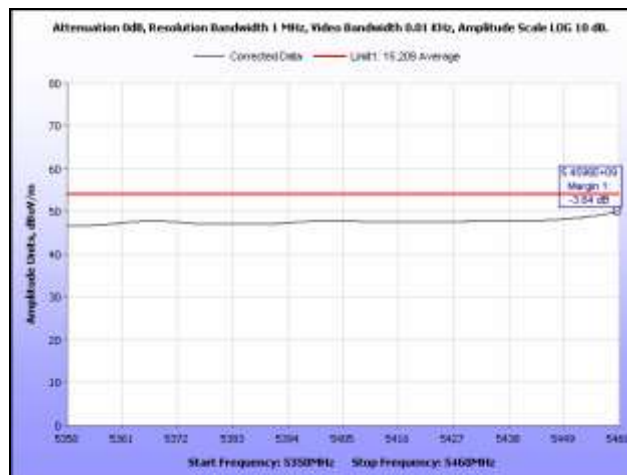

**Plot 386. Restricted Band, 802.11a, 5500 MHz, Average, Omni Antenna**

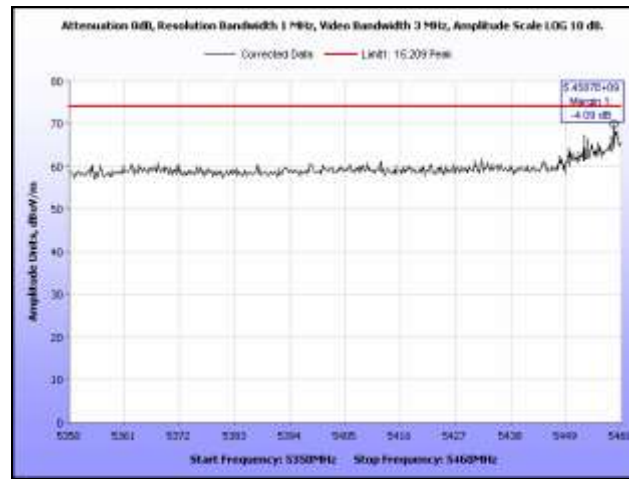

Plot 387. Restricted Band, 802.11a, 5500 MHz, Peak, Omni Antenna

## Restricted Band, 802.11n 20 MHz, Omni Antenna

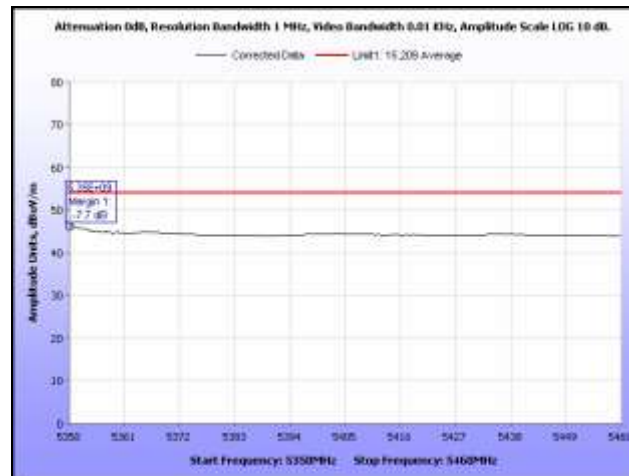

Plot 388. Restricted Band, 802.11n 20 MHz, 5320 MHz, Average, Omni Antenna

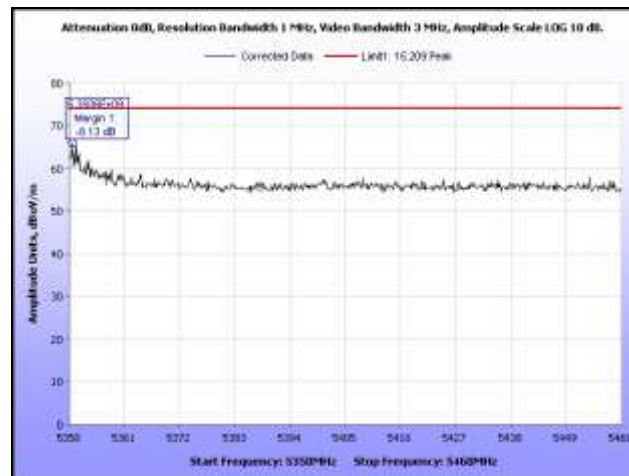

Plot 389. Restricted Band, 802.11n 20 MHz, 5320 MHz, Peak, Omni Antenna

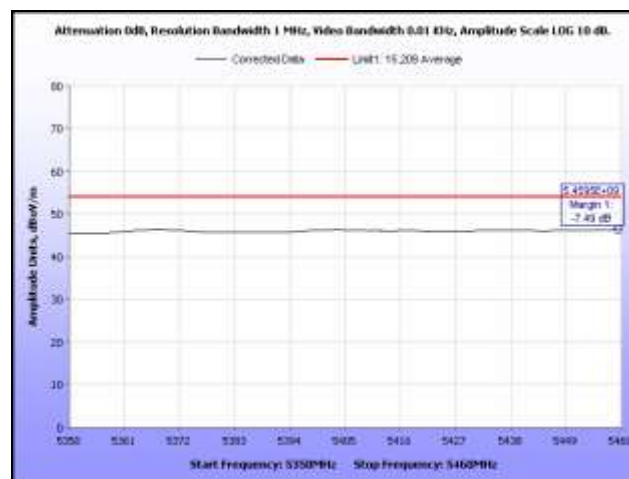

Plot 390. Restricted Band, 802.11n 20 MHz, 5500 MHz, Average, Omni Antenna



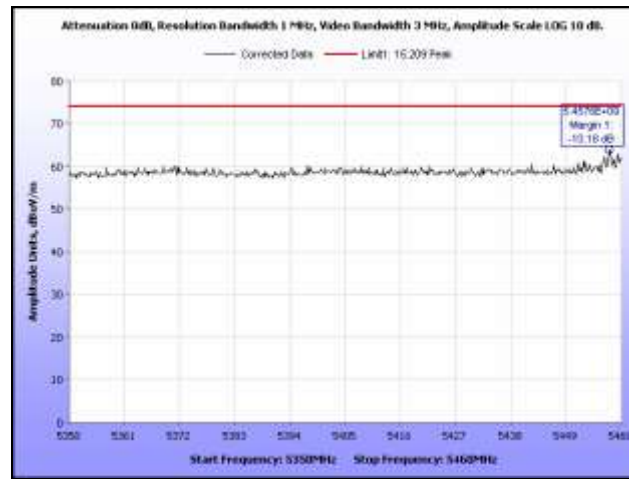

Plot 391. Restricted Band, 802.11n 20 MHz, 5500 MHz, Peak, Omni Antenna

### Restricted Band, 802.11n 40 MHz, Omni Antenna

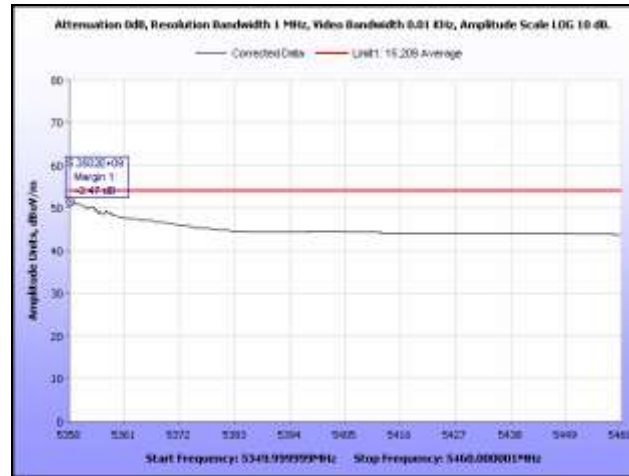

Plot 392. Restricted Band, 802.11n 40 MHz, 5310 MHz, Average, Omni Antenna

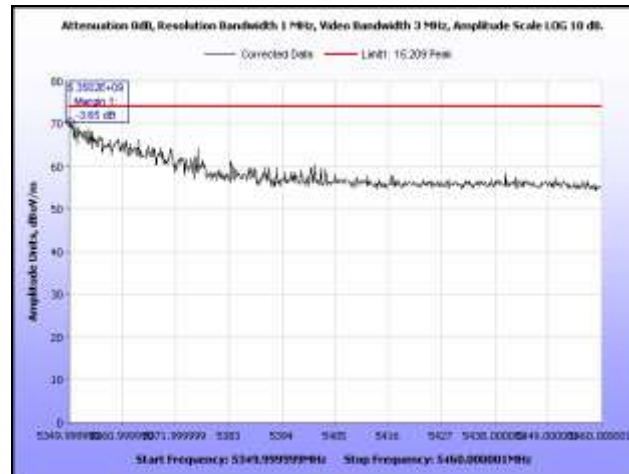

Plot 393. Restricted Band, 802.11n 40 MHz, 5310 MHz, Peak, Omni Antenna

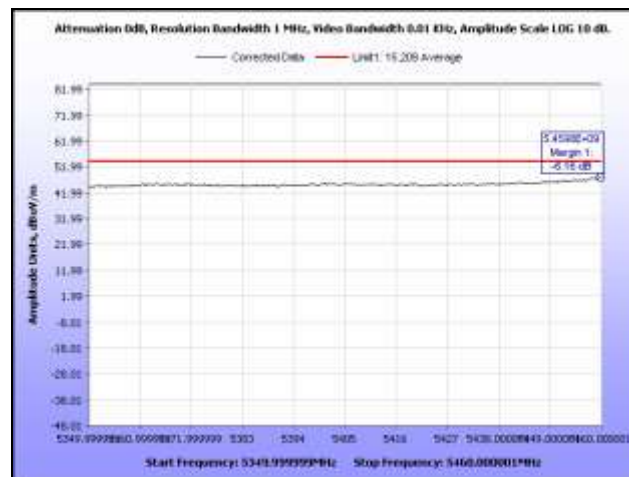

Plot 394. Restricted Band, 802.11n 40 MHz, 5510 MHz, Average, Omni Antenna

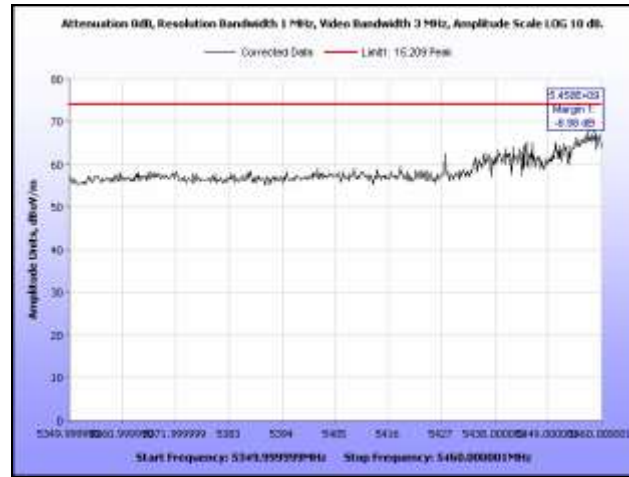

Plot 395. Restricted Band, 802.11n 40 MHz, 5510 MHz, Peak, Omni Antenna

## Restricted Band, 802.11a, Sector Antenna

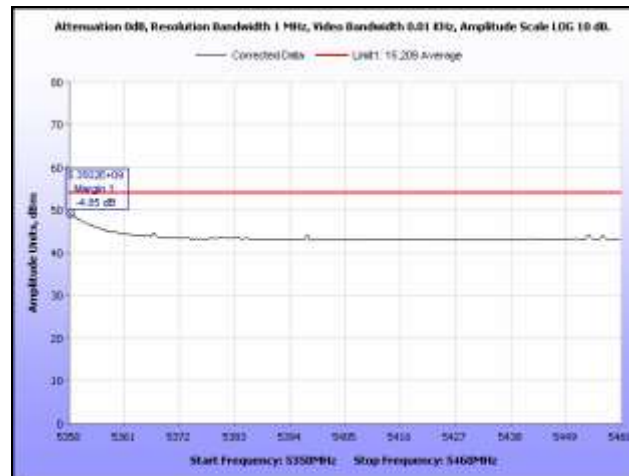

Plot 396. Restricted Band, 802.11a, 5320 MHz, Average, Sector Antenna

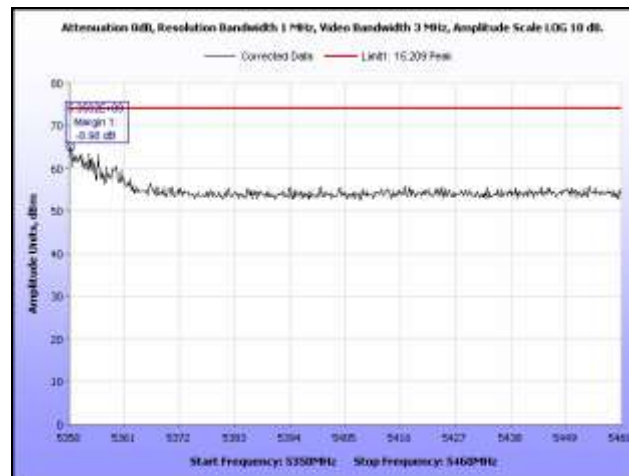

Plot 397. Restricted Band, 802.11a, 5320 MHz, Peak, Sector Antenna

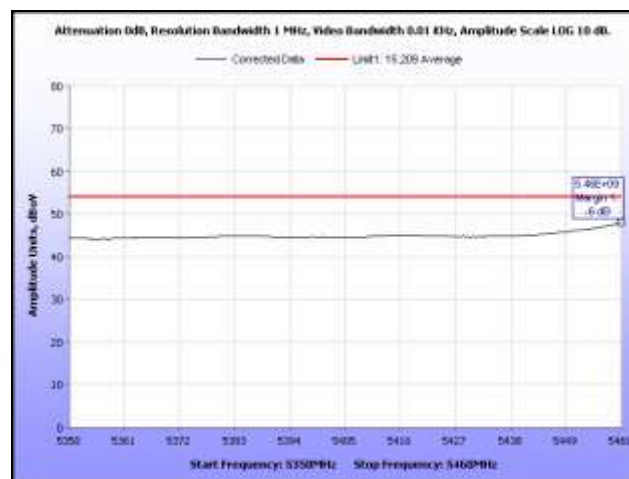

Plot 398. Restricted Band, 802.11a, 5500 MHz, Average, Sector Antenna

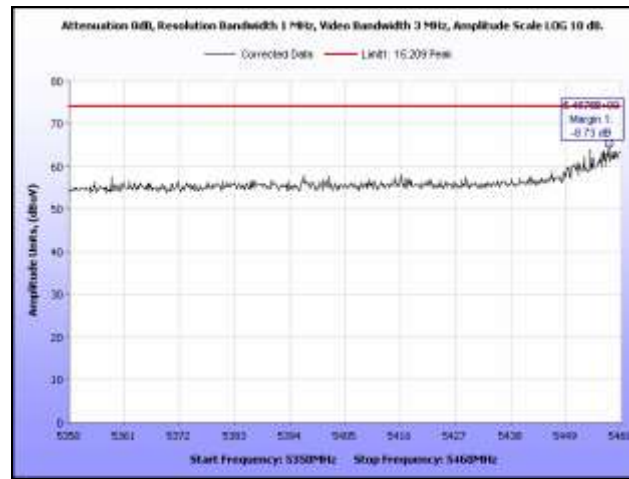

Plot 399. Restricted Band, 802.11a, 5500 MHz, Peak, Sector Antenna

### Restricted Band, 802.11n 20 MHz, Sector Antenna

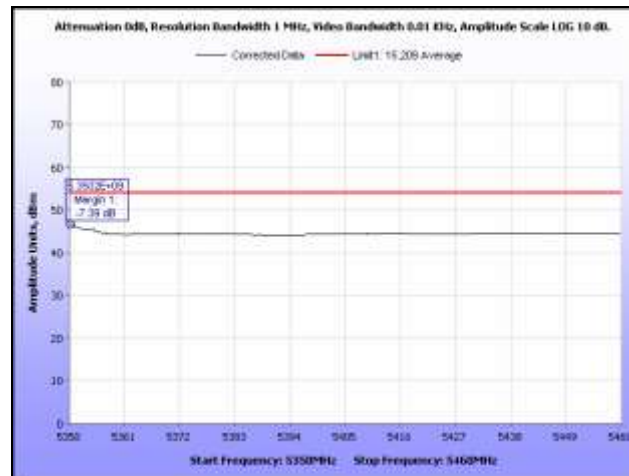

Plot 400. Restricted Band, 802.11n 20 MHz, 5320 MHz, Average, Sector Antenna

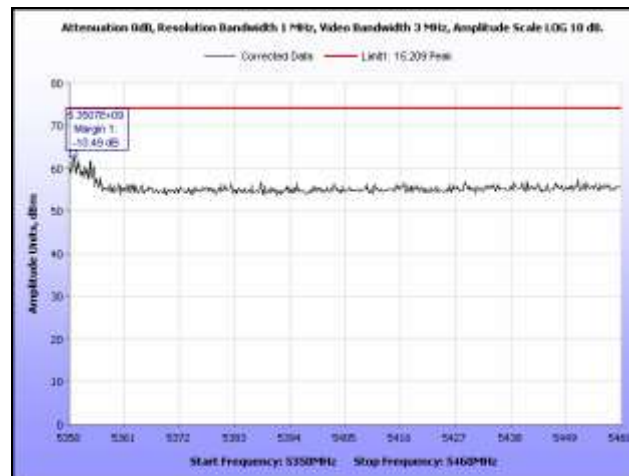

Plot 401. Restricted Band, 802.11n 20 MHz, 5320 MHz, Peak, Sector Antenna

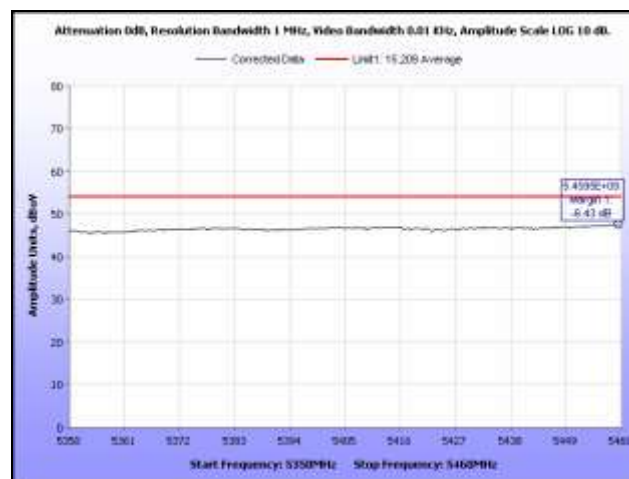

Plot 402. Restricted Band, 802.11n 20 MHz, 5500 MHz, Average, Sector Antenna

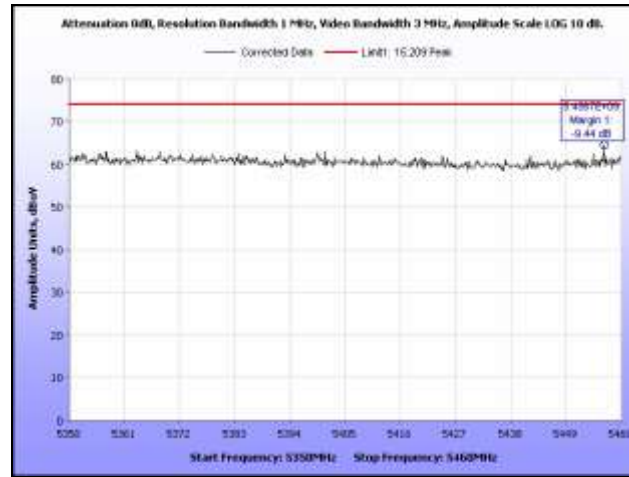

Plot 403. Restricted Band, 802.11n 20 MHz, 5500 MHz, Peak, Sector Antenna

### Restricted Band, 802.11n 40 MHz, Sector Antenna

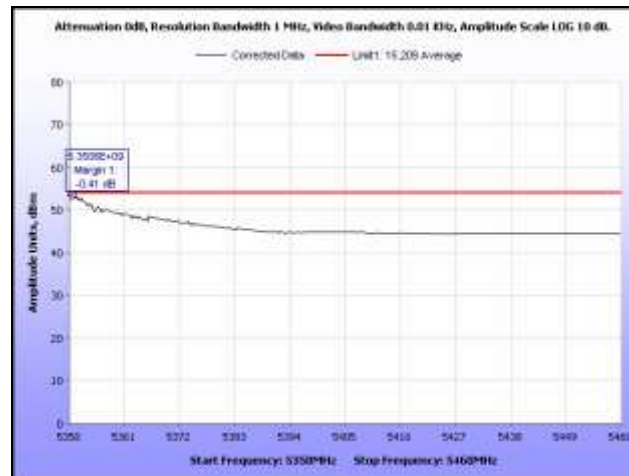

Plot 404. Restricted Band, 802.11n 40 MHz, 5310 MHz, Average, Sector Antenna

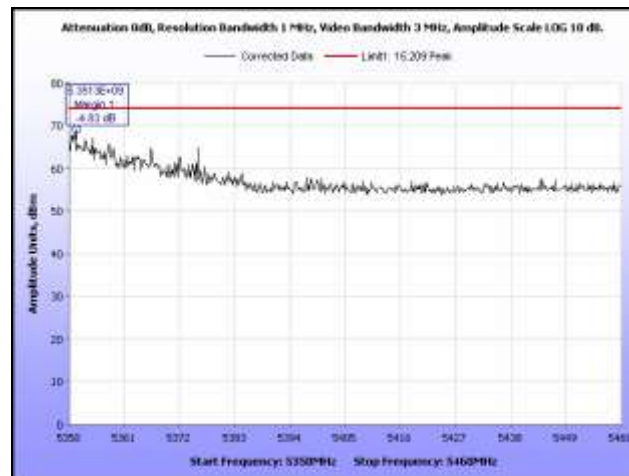

Plot 405. Restricted Band, 802.11n 40 MHz, 5310 MHz, Peak, Sector Antenna

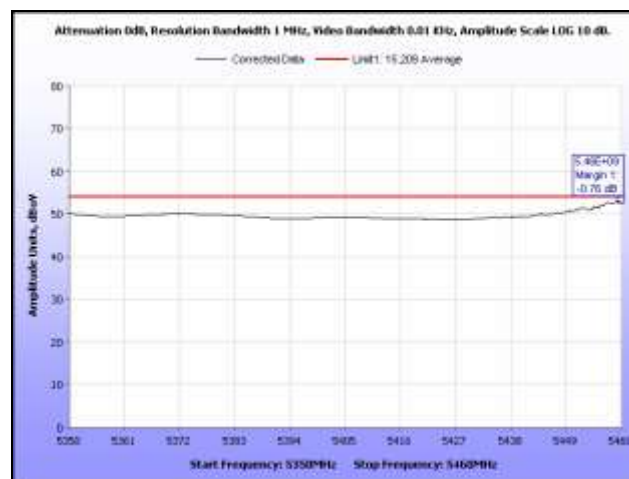

Plot 406. Restricted Band, 802.11n 40 MHz, 5510 MHz, Average, Sector Antenna



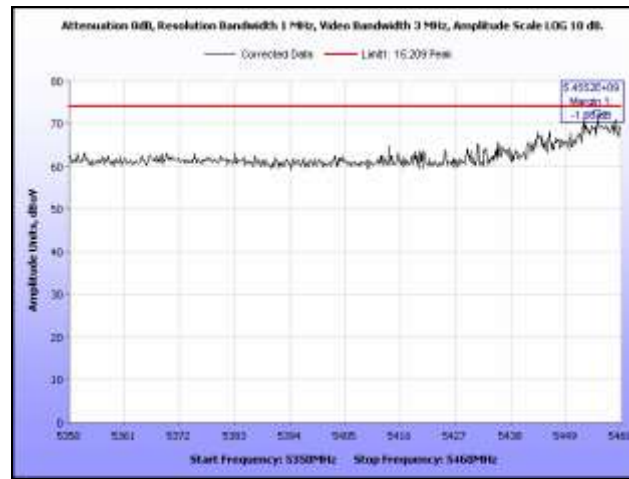

Plot 407. Restricted Band, 802.11n 40 MHz, 5510 MHz, Peak, Sector Antenna

## Electromagnetic Compatibility Criteria for Intentional Radiators

### § 15.407(f) RF Exposure

**RF Exposure Requirements:** §1.1307(b)(1) and §1.1307(b)(2): Systems operating under the provisions of this section shall be operated in a manner that ensures that the public is not exposed to radio frequency energy levels in excess of the Commission's guidelines.

**RF Radiation Exposure Limit:** §1.1310: As specified in this section, the Maximum Permissible Exposure (MPE) Limit shall be used to evaluate the environmental impact of human exposure to radiofrequency (RF) radiation as specified in Sec. 1.1307(b), except in the case of portable devices which shall be evaluated according to the provisions of Sec. 2.1093 of this chapter.

MPE Limit Calculation: EUT's operating frequencies @ 5150-5350, 5470-5825 MHz; highest conducted power = 19.911 dBm (peak) therefore, **Limit for Uncontrolled exposure: 1 mW/cm<sup>2</sup> or 10 W/m<sup>2</sup>**

Gain of Omni Antenna @ 5GHz = 10 dBi

Equation from page 18 of OET 65, Edition 97-01

$$S = PG / 4\pi R^2 \quad \text{or} \quad R = \sqrt{PG / 4\pi S}$$

where, S = Power Density (mW/cm<sup>2</sup>)  
P = Power Input to antenna (97.974mW)  
G = Antenna Gain (10 numeric)  
R = Radius (20 cm)

$$S = (97.974 * 10) / (4 * 3.14 * 20^2) = 0.195 \text{ mW/cm}^2$$

Gain of Sector Antenna @ 5GHz = 15.5 dBi

High Conducted Power with Sector Antenna = 15.49 dBm

S = Power Density (mW/cm<sup>2</sup>)  
P = Power Input to Antenna (35.4 mW)  
G = Numeric Antenna Gain (35.48)  
R = Radius (20 cm)

$$S = (35.4 * 35.48) / (4 * 3.14 * 20^2) = 0.25 \text{ mW/cm}^2$$

## Electromagnetic Compatibility Criteria for Intentional Radiators

### § 15.407(g) Frequency Stability

<b>Test Requirements:</b>	§ 15.407(g): Manufacturers of U-NII devices are responsible for ensuring frequency stability such that an emission is maintained within the band of operation under all conditions of normal operation as specified in the user's manual.
<b>Test Procedure:</b>	The EUT was placed in a temperature chamber and connected directly to a spectrum analyzer through an attenuator. The resolution bandwidth was set to 1 MHz with an average detector and the span was set to encompass the complete frequency band. The transmitter was set to transmit on the low and high channels. Markers were used to measure the channels to ensure that the entire emission was contained within the frequency band. The temperature was varied between the minimum and maximum temperature (-20°C and +55°C) at increments of 10°C and the measurements were repeated. At ambient temperature (+20°C), the input voltage was varied between +/- 10% of the nominal input voltage and the measurements were repeated. Measurements were repeated for each frequency band.
<b>Test Results:</b>	The EUT was found compliant with the requirements of §15.407(g).
<b>Test Engineer(s):</b>	Jeff Pratt
<b>Test Date(s):</b>	09/20/11

## Frequency Stability, 802.11a

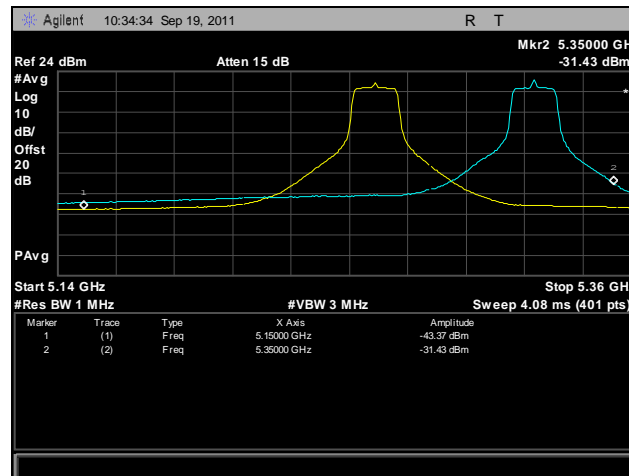

Plot 408. Frequency Stability, 802.11a, 5250 MHz – 5350 MHz @ -10°C, 120 V

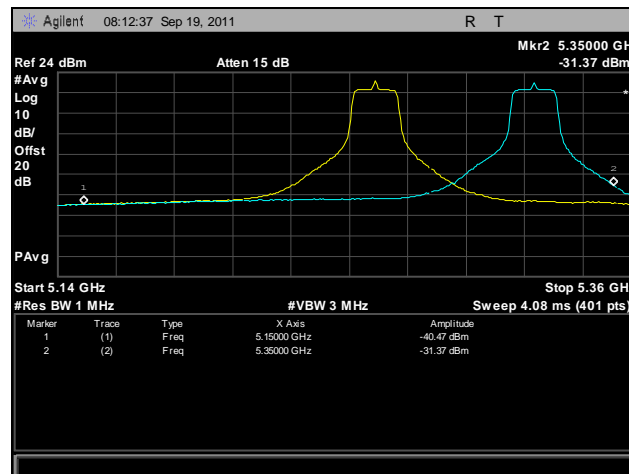

Plot 409. Frequency Stability, 802.11a, 5250 MHz – 5350 MHz @ 0°C, 120 V

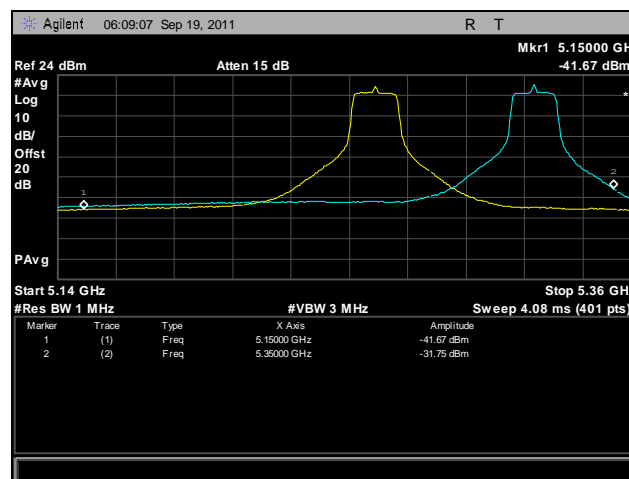

Plot 410. Frequency Stability, 802.11a, 5250 MHz – 5350 MHz @ 10°C, 120 V

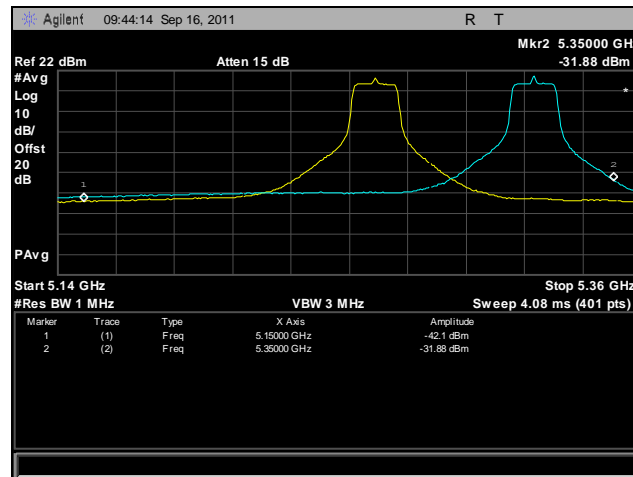

Plot 411. Frequency Stability, 802.11a, 5250 MHz – 5350 MHz @ 20°C, 108 V

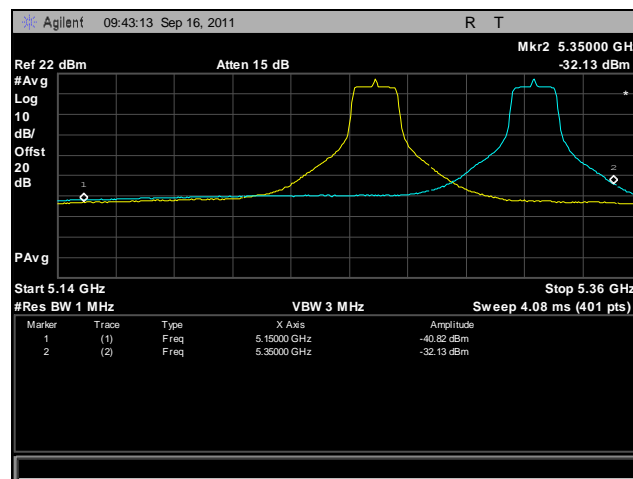

Plot 412. Frequency Stability, 802.11a, 5250 MHz – 5350 MHz @ 20°C, 120 V

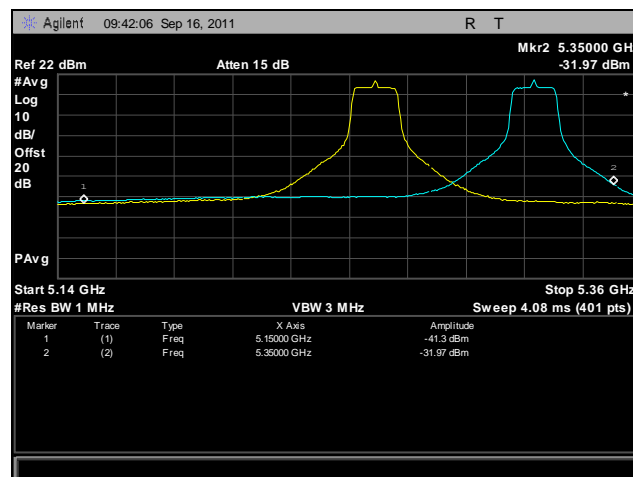

Plot 413. Frequency Stability, 802.11a, 5250 MHz – 5350 MHz @ 20°C, 132 V

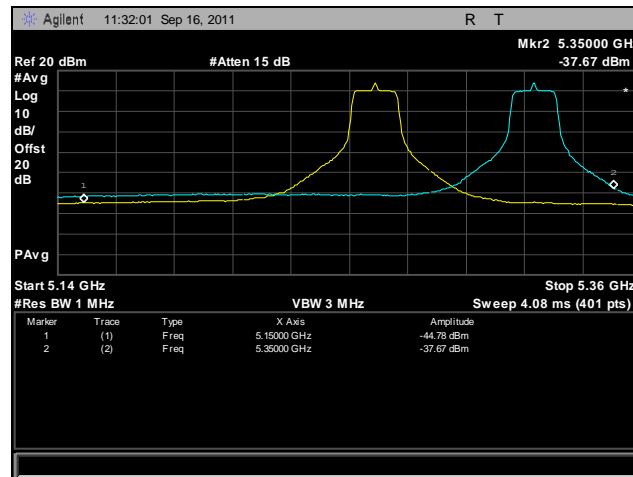

Plot 414. Frequency Stability, 802.11a, 5250 MHz – 5350 MHz @ 30°C, 120 V

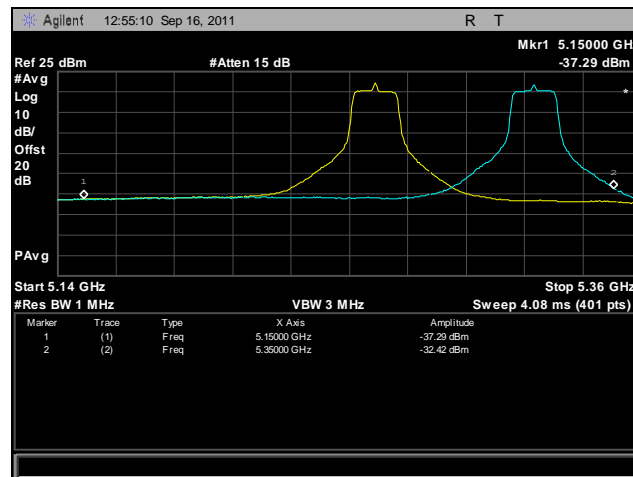

Plot 415. Frequency Stability, 802.11a, 5250 MHz – 5350 MHz @ 40°C, 120 V

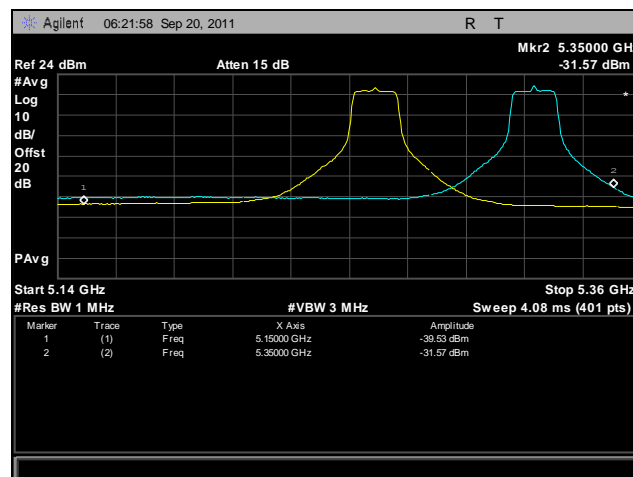

Plot 416. Frequency Stability, 802.11a, 5250 MHz – 5350 MHz @ 50°C, 120 V

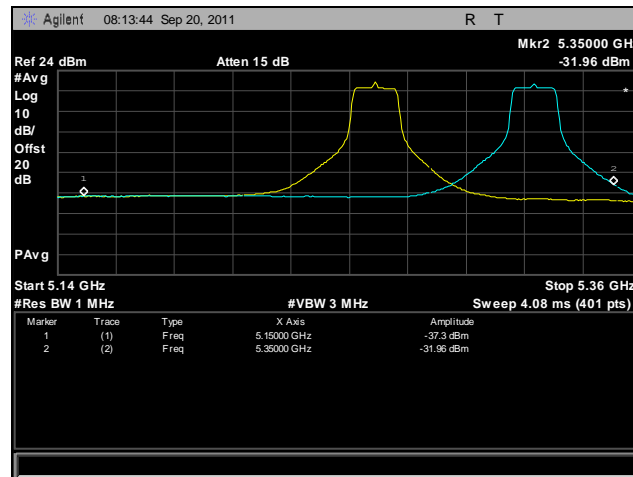

Plot 417. Frequency Stability, 802.11a, 5250 MHz – 5350 MHz @ 55°C, 120 V

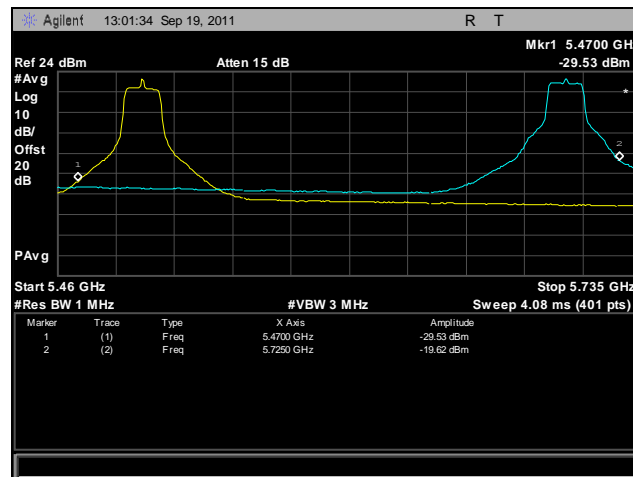

Plot 418. Frequency Stability, 802.11a, 5470 MHz – 5725 MHz @ -20°C, 120 V

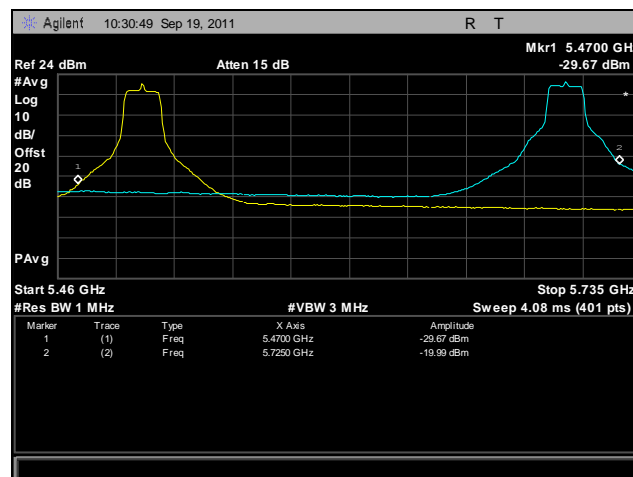

Plot 419. Frequency Stability, 802.11a, 5470 MHz – 5725 MHz @ -10°C, 120 V

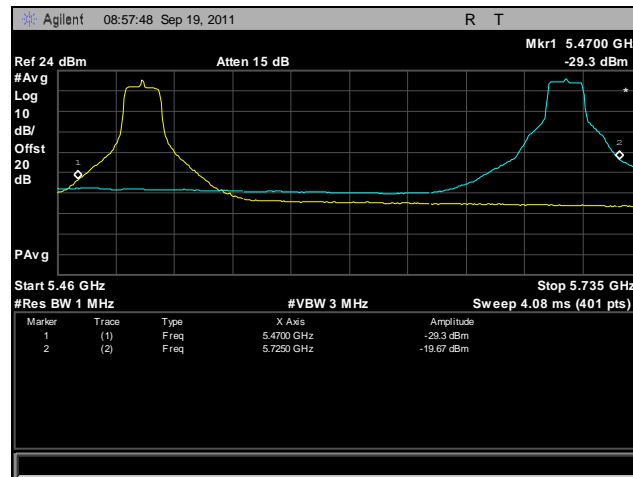

Plot 420. Frequency Stability, 802.11a, 5470 MHz – 5725 MHz @ 0°C, 120 V

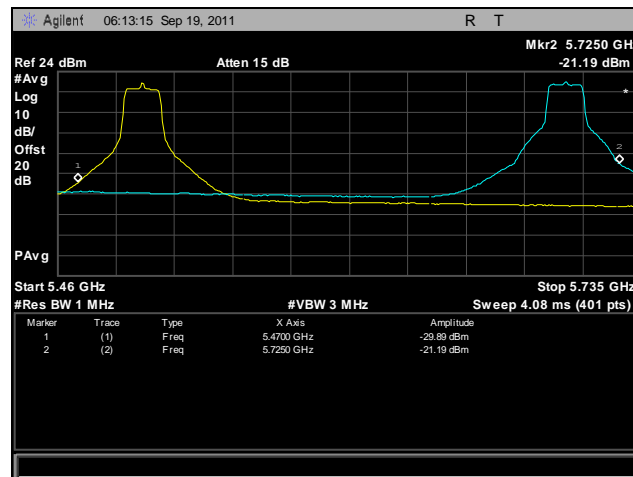

Plot 421. Frequency Stability, 802.11a, 5470 MHz – 5725 MHz @ 10°C, 120 V

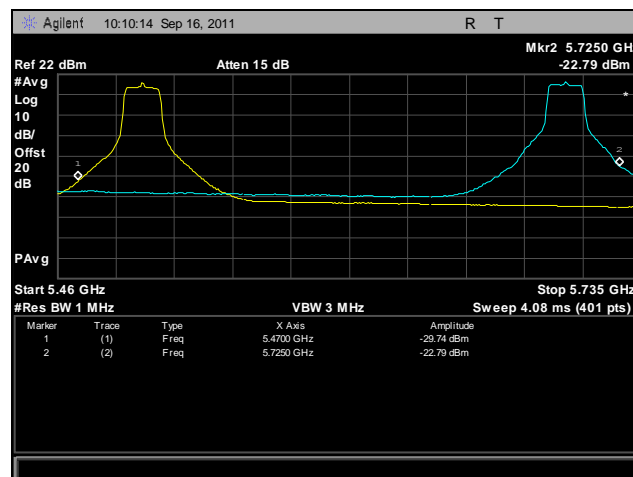

Plot 422. Frequency Stability, 802.11a, 5470 MHz – 5725 MHz @ 20°C, 108 V



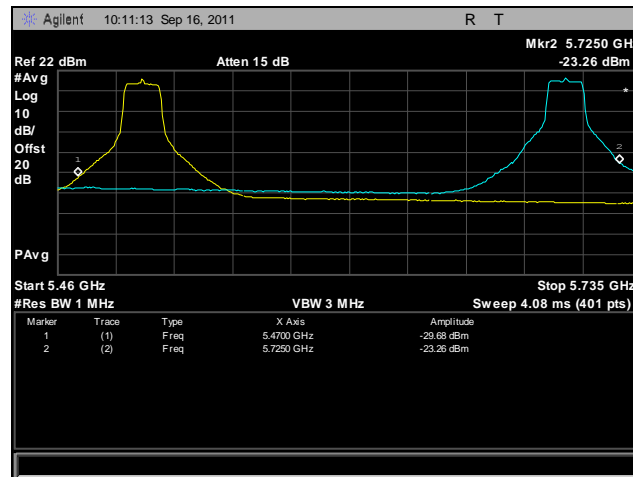

Plot 423. Frequency Stability, 802.11a, 5470 MHz – 5725 MHz @ 20°C, 120 V

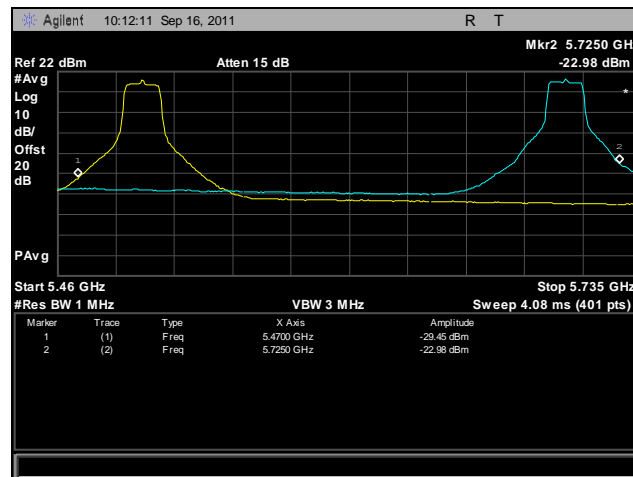

Plot 424. Frequency Stability, 802.11a, 5470 MHz – 5725 MHz @ 20°C, 132 V

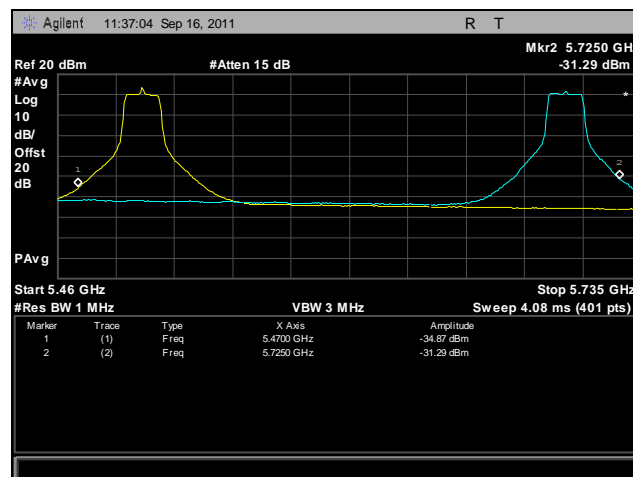

Plot 425. Frequency Stability, 802.11a, 5470 MHz – 5725 MHz @ 30°C, 120 V

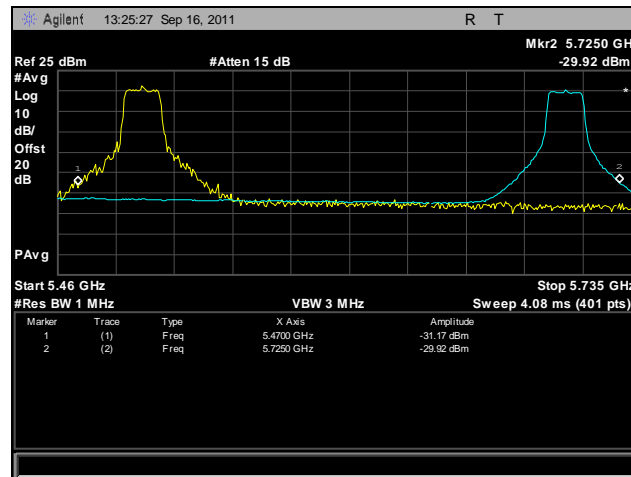

Plot 426. Frequency Stability, 802.11a, 5470 MHz – 5725 MHz @ 40°C, 120 V

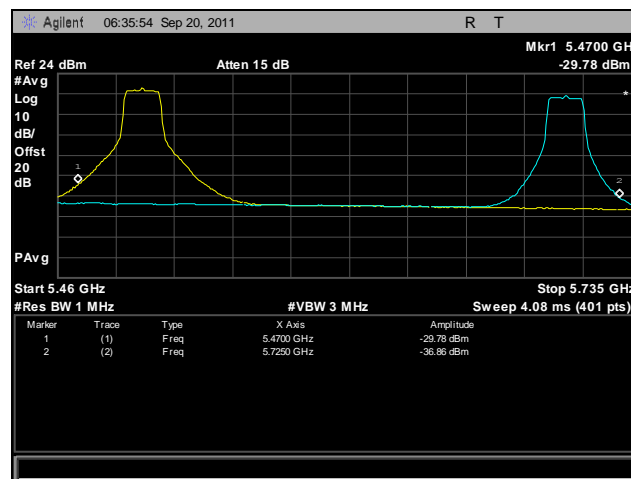

Plot 427. Frequency Stability, 802.11a, 5470 MHz – 5725 MHz @ 50°C, 120 V

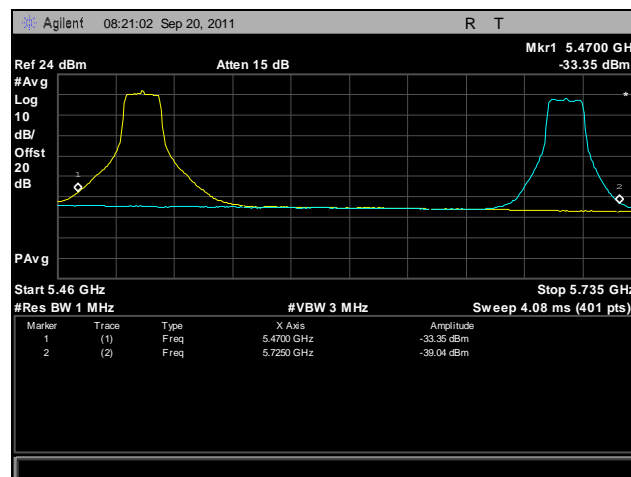

Plot 428. Frequency Stability, 802.11a, 5470 MHz – 5725 MHz @ 55°C, 120 V

### Frequency Stability, 802.11n 20 MHz

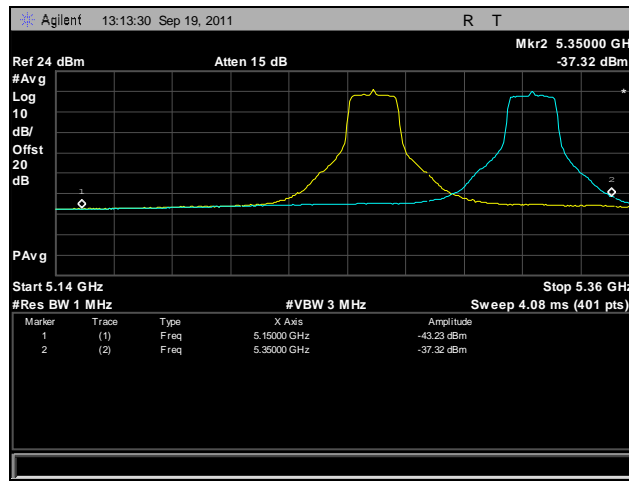

Plot 429. Frequency Stability, 802.11n 20 MHz, 5250 MHz – 5350 MHz @ -20°C, 120 V

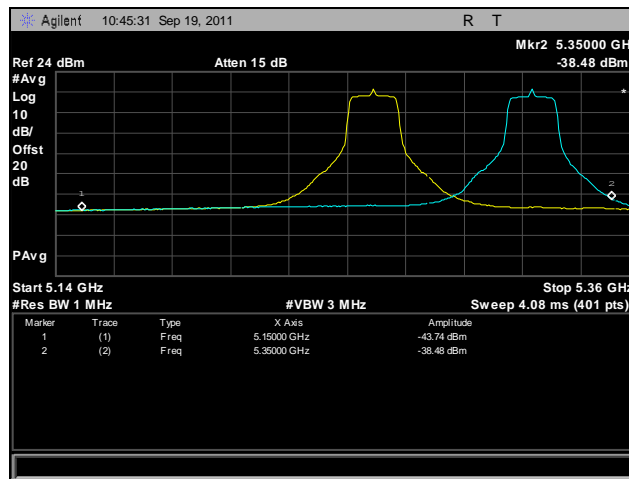

Plot 430. Frequency Stability, 802.11n 20 MHz, 5250 MHz – 5350 MHz @ -10°C, 120 V

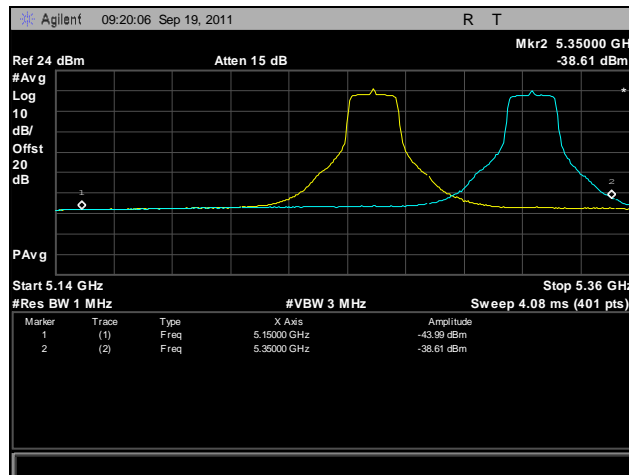

Plot 431. Frequency Stability, 802.11n 20 MHz, 5250 MHz – 5350 MHz @ 0°C, 120 V

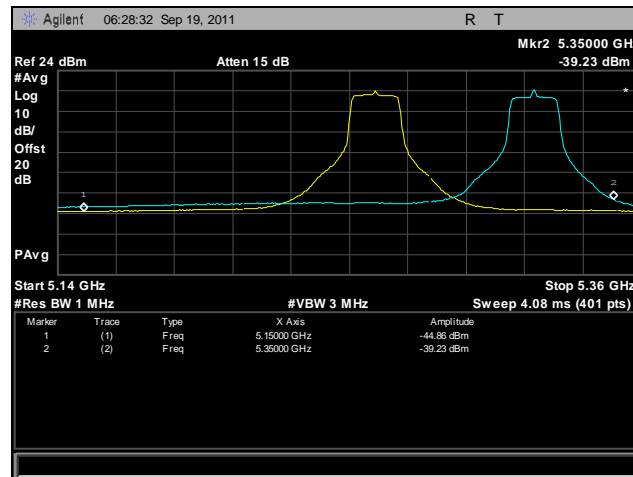

Plot 432. Frequency Stability, 802.11n 20 MHz, 5250 MHz – 5350 MHz @ 10°C, 120 V

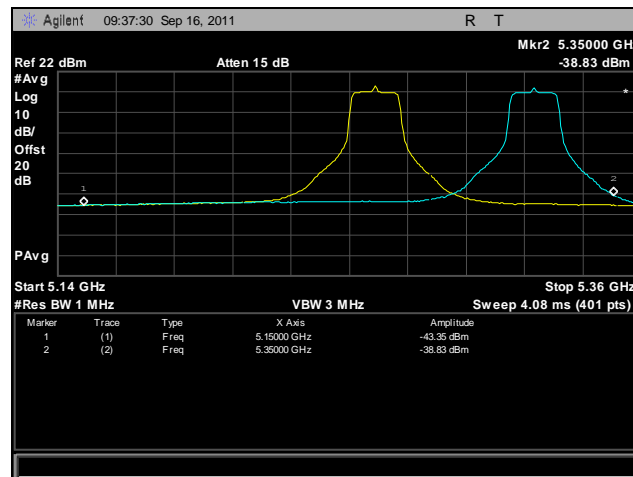

Plot 433. Frequency Stability, 802.11n 20 MHz, 5250 MHz – 5350 MHz @ 20°C, 108 V

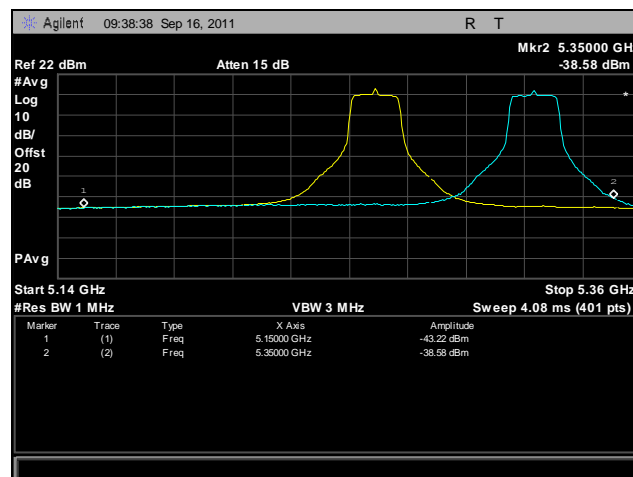

Plot 434. Frequency Stability, 802.11n 20 MHz, 5250 MHz – 5350 MHz @ 20°C, 120 V

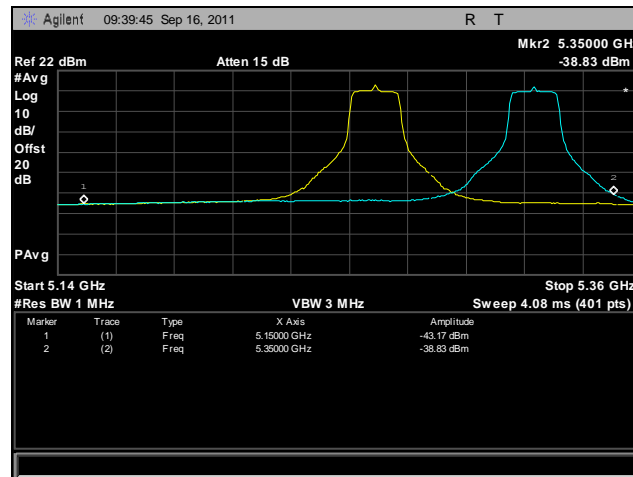

Plot 435. Frequency Stability, 802.11n 20 MHz, 5250 MHz – 5350 MHz @ 20°C, 132 V

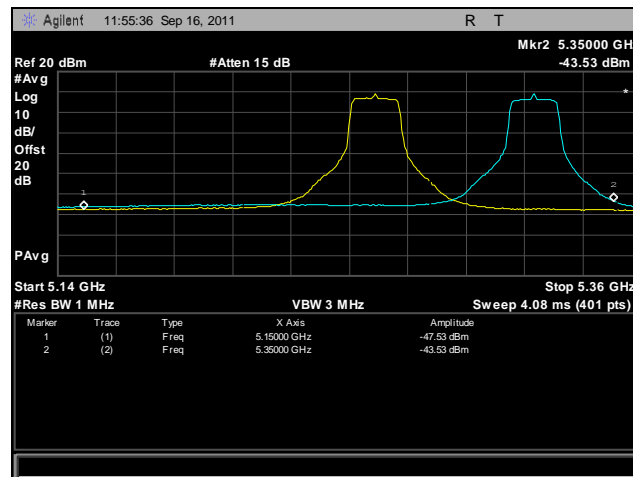

Plot 436. Frequency Stability, 802.11n 20 MHz, 5250 MHz – 5350 MHz @ 30°C, 120 V

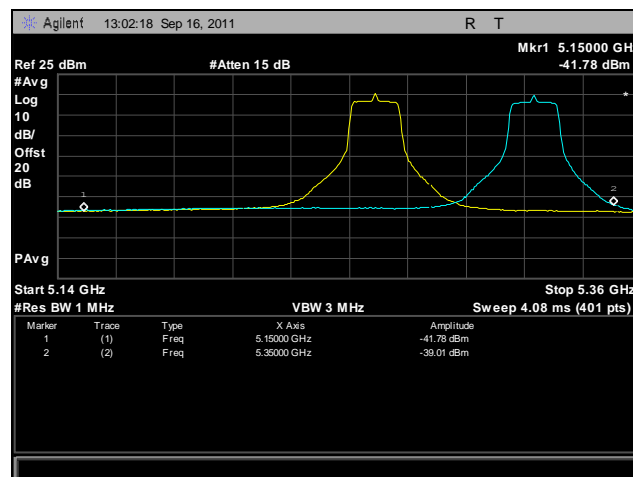

Plot 437. Frequency Stability, 802.11n 20 MHz, 5250 MHz – 5350 MHz @ 40°C, 120 V

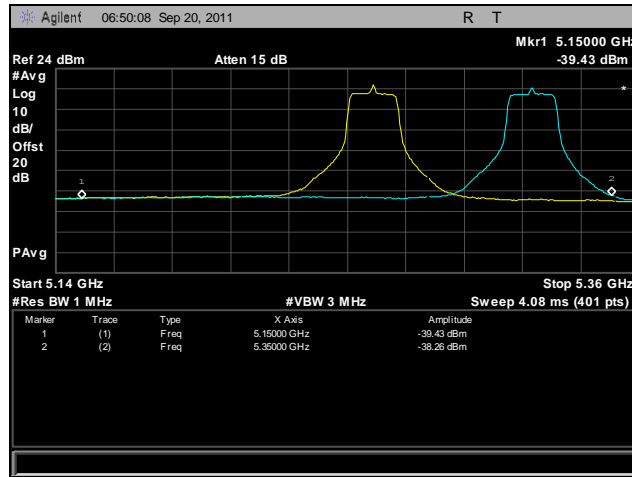

Plot 438. Frequency Stability, 802.11n 20 MHz, 5250 MHz – 5350 MHz @ 50°C, 120 V

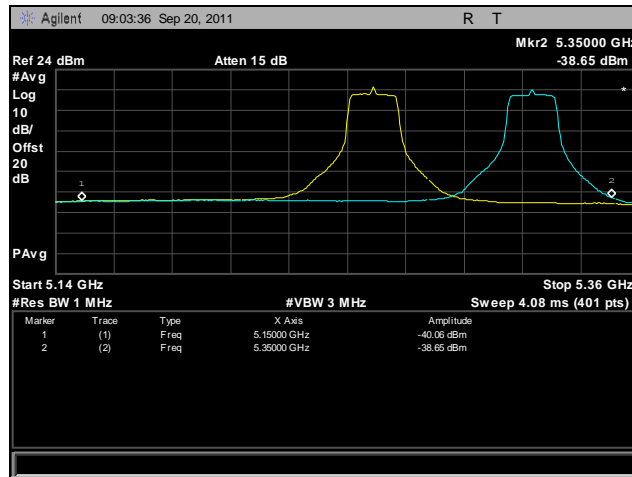

Plot 439. Frequency Stability, 802.11n 20 MHz, 5250 MHz – 5350 MHz @ 55°C, 120 V

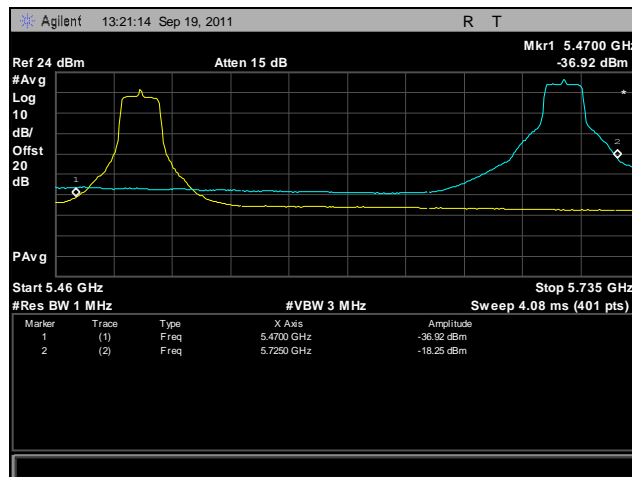

Plot 440. Frequency Stability, 802.11n 20 MHz, 5470 MHz – 5725 MHz @ -20°C, 120 V

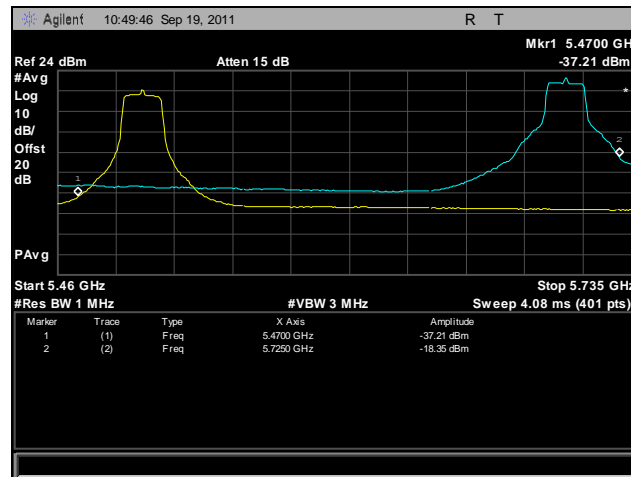

Plot 441. Frequency Stability, 802.11n 20 MHz, 5470 MHz – 5725 MHz @ -10°C, 120 V

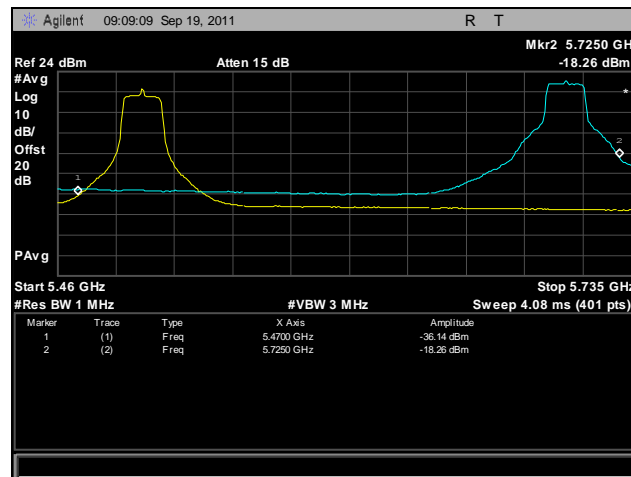

Plot 442. Frequency Stability, 802.11n 20 MHz, 5470 MHz – 5725 MHz @ 0°C, 120 V

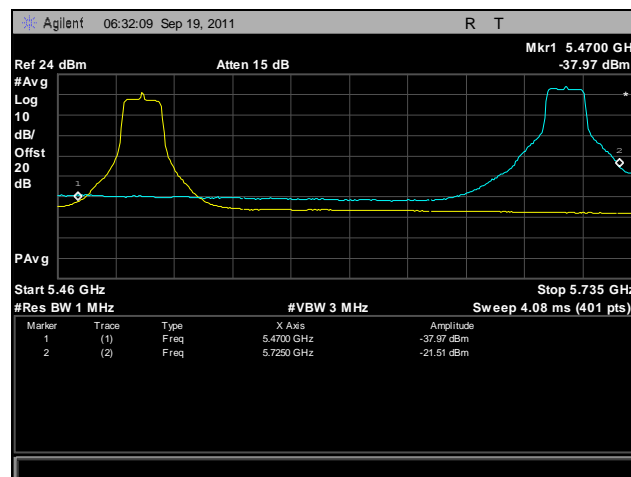

Plot 443. Frequency Stability, 802.11n 20 MHz, 5470 MHz – 5725 MHz @ 10°C, 120 V

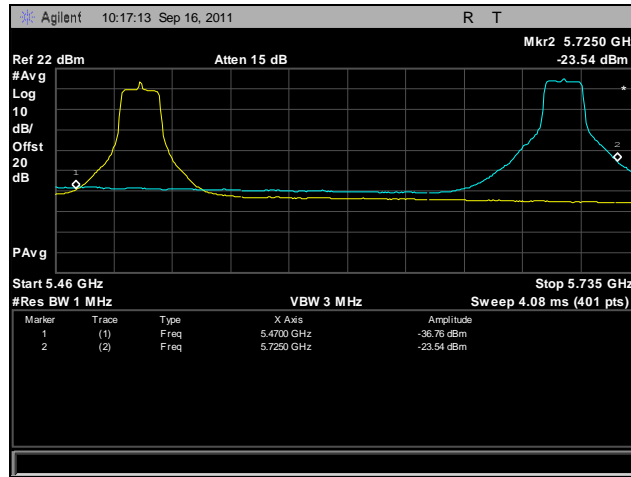

Plot 444. Frequency Stability, 802.11n 20 MHz, 5470 MHz – 5725 MHz @ 20°C, 108 V

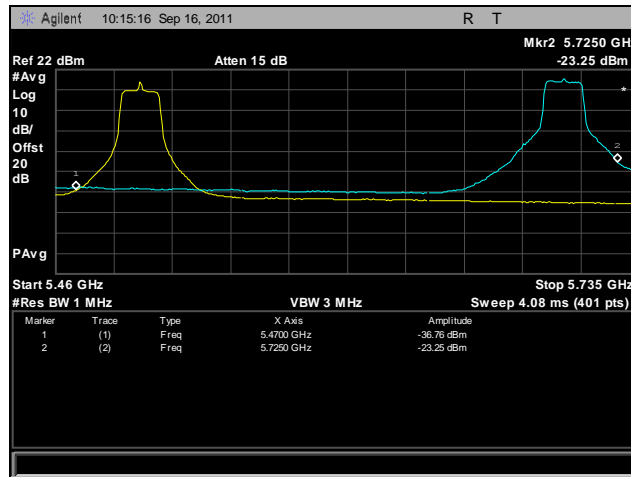

Plot 445. Frequency Stability, 802.11n 20 MHz, 5470 MHz – 5725 MHz @ 20°C, 120 V

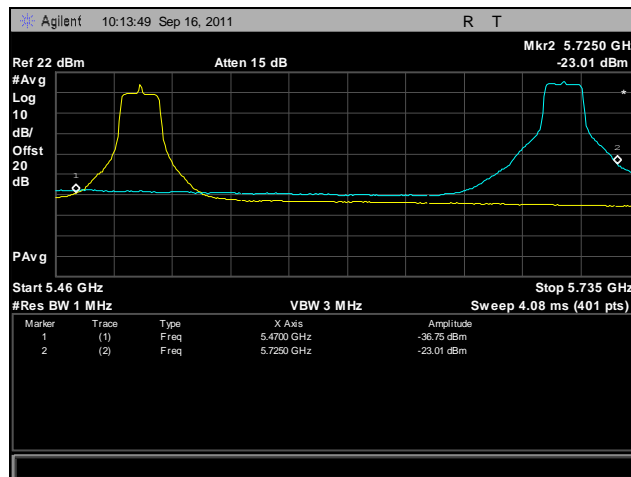

Plot 446. Frequency Stability, 802.11n 20 MHz, 5470 MHz – 5725 MHz @ 20°C, 132 V



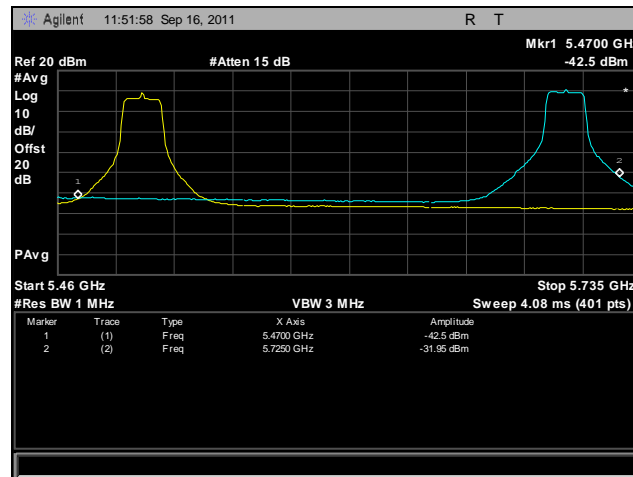

Plot 447. Frequency Stability, 802.11n 20 MHz, 5470 MHz – 5725 MHz @ 30°C, 120 V

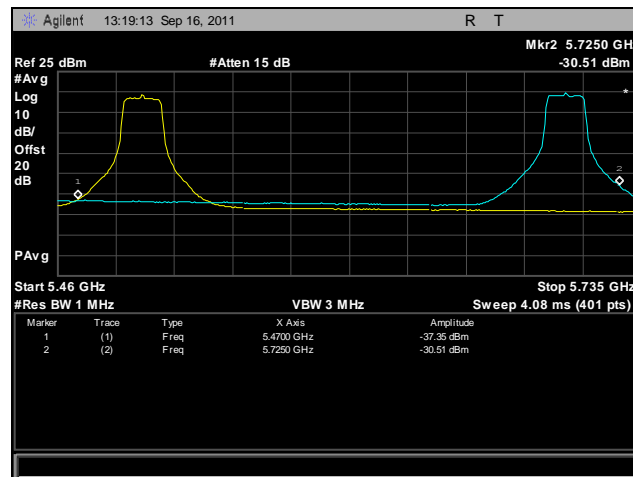

Plot 448. Frequency Stability, 802.11n 20 MHz, 5470 MHz – 5725 MHz @ 40°C, 120 V

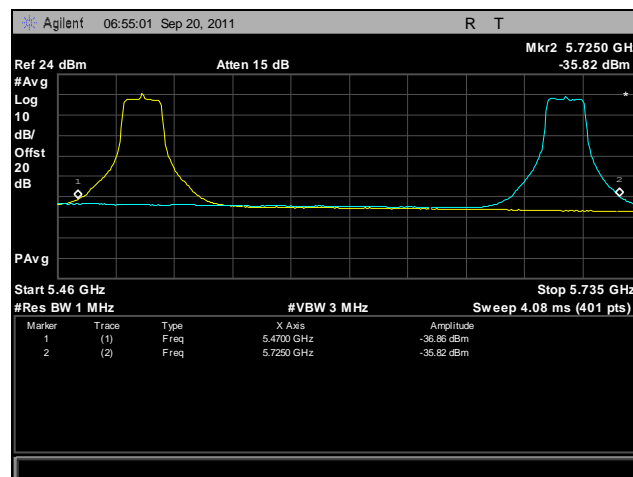

Plot 449. Frequency Stability, 802.11n 20 MHz, 5470 MHz – 5725 MHz @ 50°C, 120 V

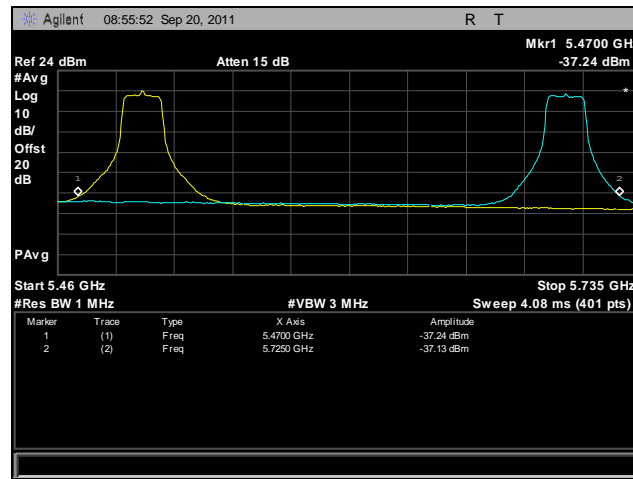

Plot 450. Frequency Stability, 802.11n 20 MHz, 5470 MHz – 5725 MHz @ 55°C, 120 V

## Frequency Stability, 802.11n 40 MHz

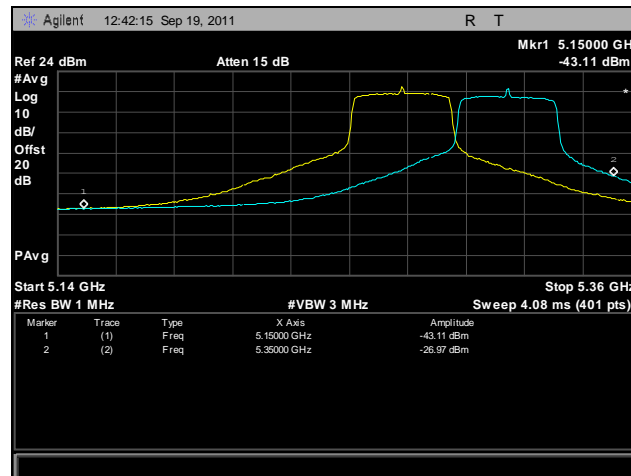

Plot 451. Frequency Stability, 802.11n 40 MHz, 5250 MHz – 5350 MHz @ -20°C, 120 V

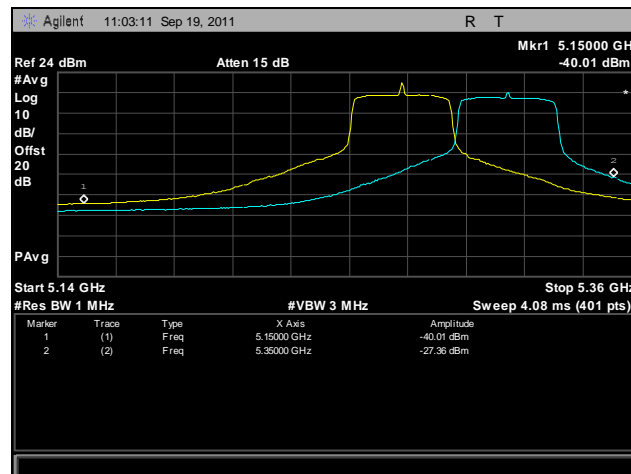

Plot 452. Frequency Stability, 802.11n 40 MHz, 5250 MHz – 5350 MHz @ -10°C, 120 V

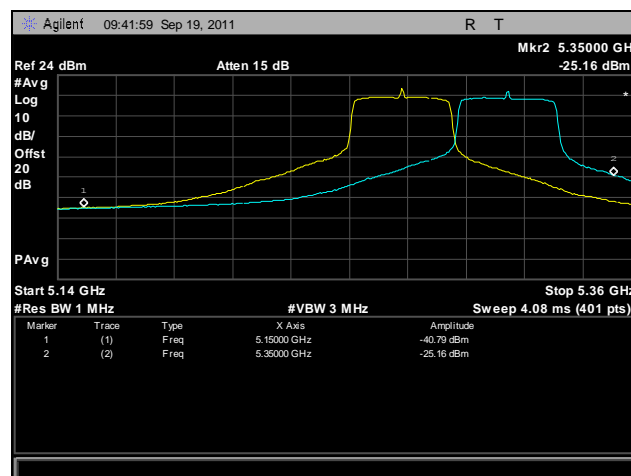

Plot 453. Frequency Stability, 802.11n 40 MHz, 5250 MHz – 5350 MHz @ 0°C, 120 V

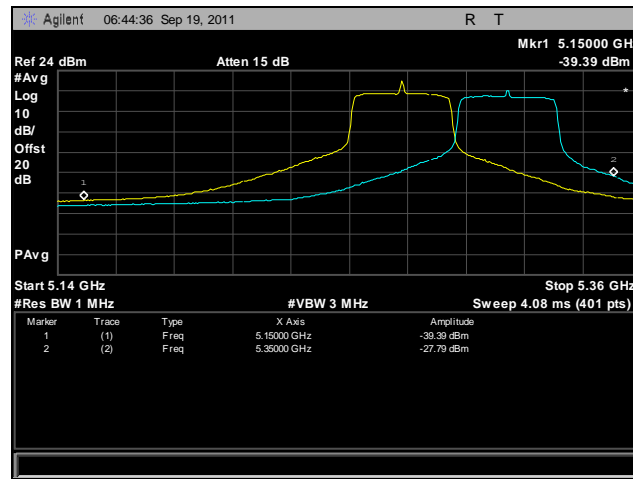

Plot 454. Frequency Stability, 802.11n 40 MHz, 5250 MHz – 5350 MHz @ 10°C, 120 V

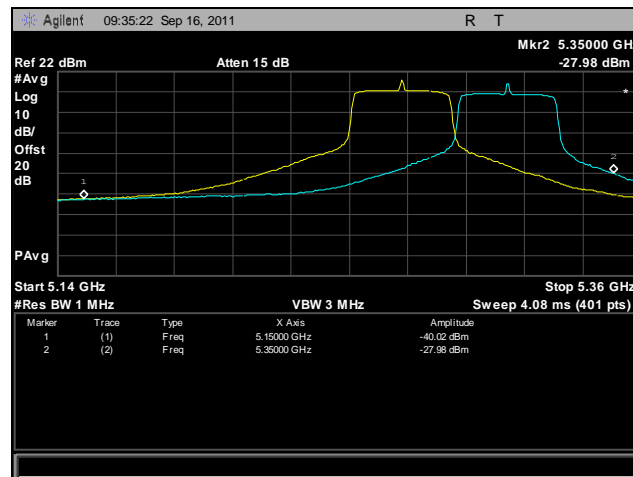

Plot 455. Frequency Stability, 802.11n 40 MHz, 5250 MHz – 5350 MHz @ 20°C, 108 V

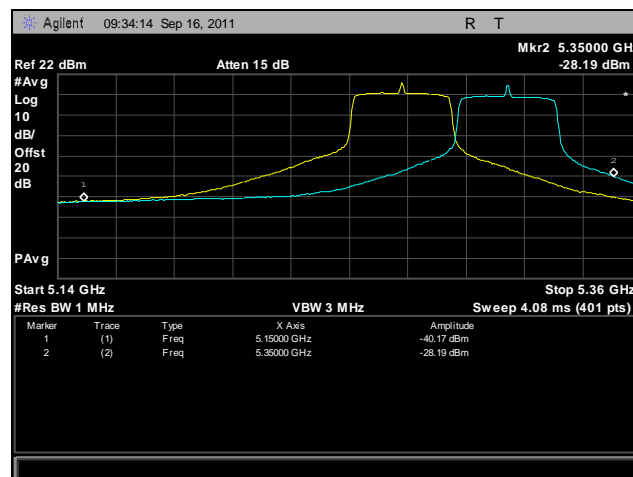

Plot 456. Frequency Stability, 802.11n 40 MHz, 5250 MHz – 5350 MHz @ 20°C, 120 V

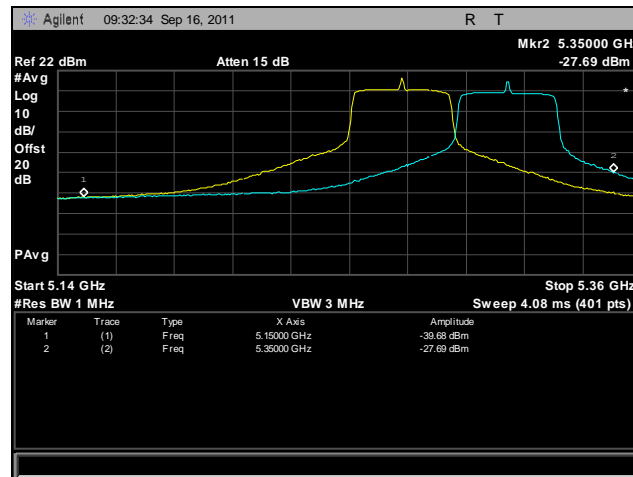

Plot 457. Frequency Stability, 802.11n 40 MHz, 5250 MHz – 5350 MHz @ 20°C, 132 V

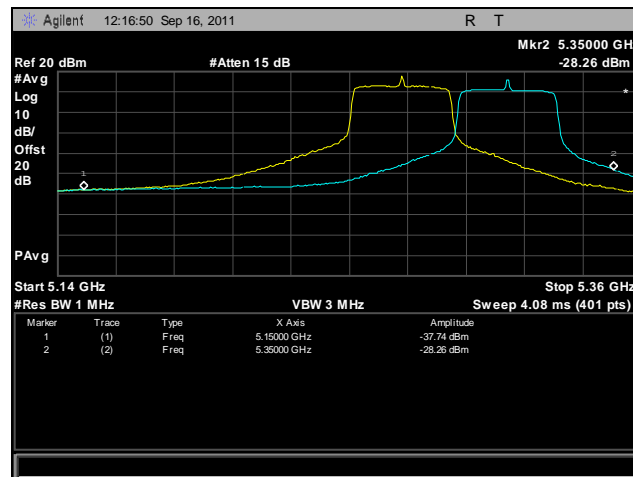

Plot 458. Frequency Stability, 802.11n 40 MHz, 5250 MHz – 5350 MHz @ 30°C, 120 V

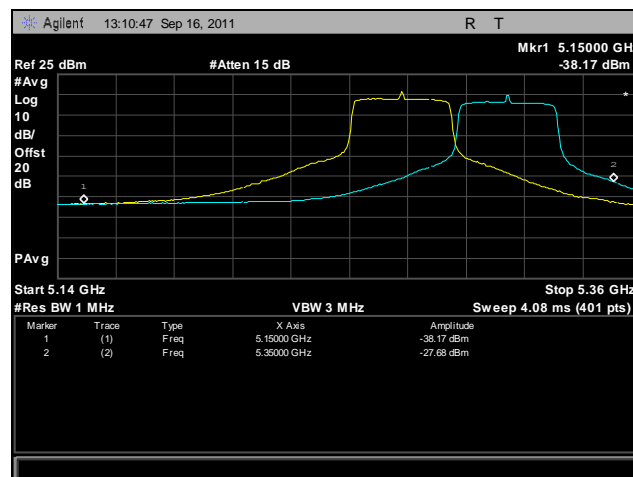

Plot 459. Frequency Stability, 802.11n 40 MHz, 5250 MHz – 5350 MHz @ 40°C, 120 V

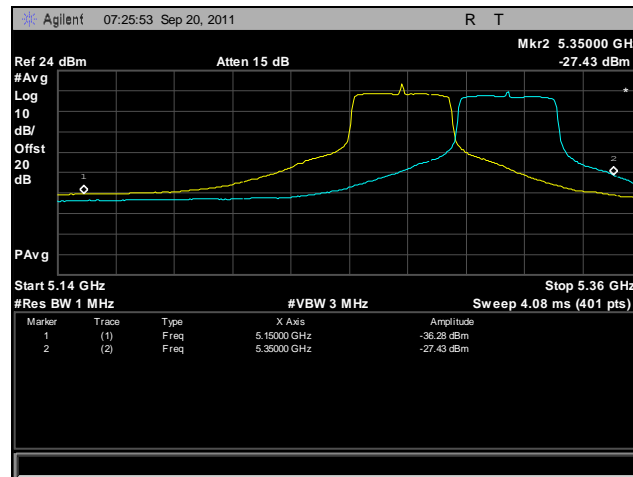

Plot 460. Frequency Stability, 802.11n 40 MHz, 5250 MHz – 5350 MHz @ 50°C, 120 V

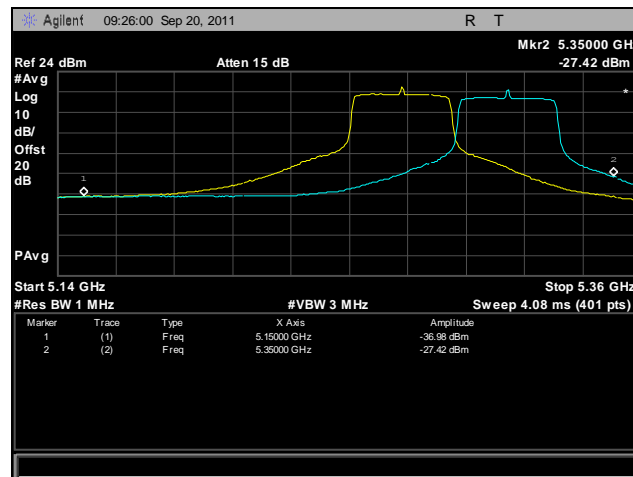

Plot 461. Frequency Stability, 802.11n 40 MHz, 5250 MHz – 5350 MHz @ 55°C, 120 V

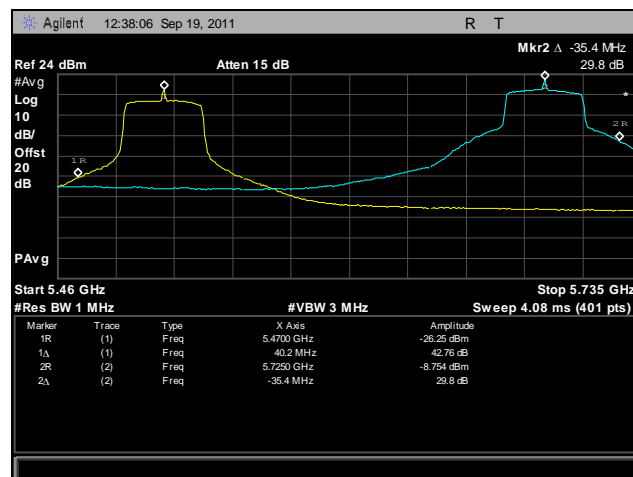

Plot 462. Frequency Stability, 802.11n 40 MHz, 5470 MHz – 5725 MHz @ -20°C, 120 V

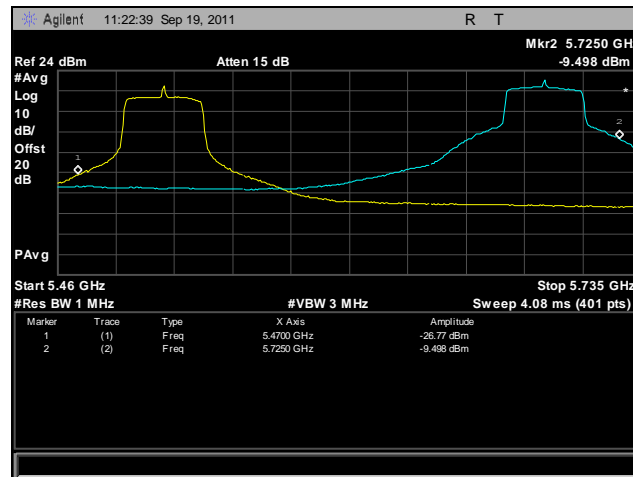

Plot 463. Frequency Stability, 802.11n 40 MHz, 5470 MHz – 5725 MHz @ -10°C, 120 V

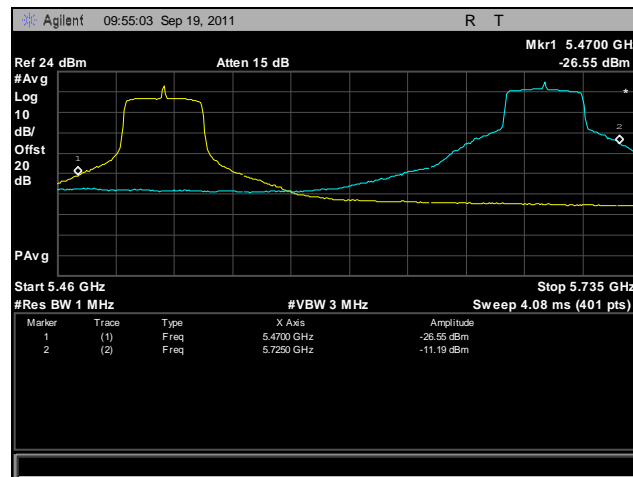

Plot 464. Frequency Stability, 802.11n 40 MHz, 5470 MHz – 5725 MHz @ 0°C, 120 V

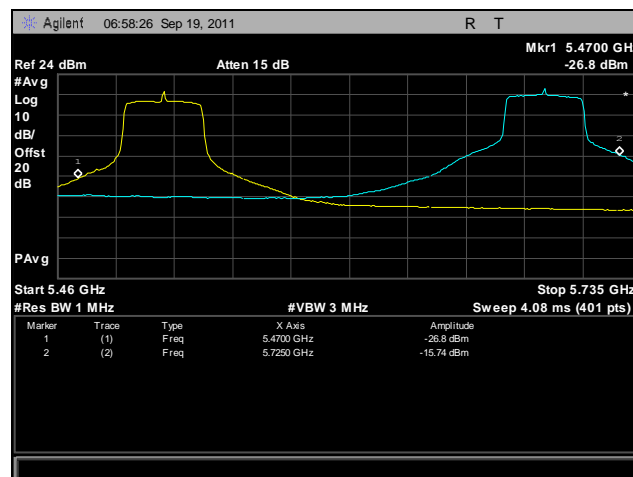

Plot 465. Frequency Stability, 802.11n 40 MHz, 5470 MHz – 5725 MHz @ 10°C, 120 V

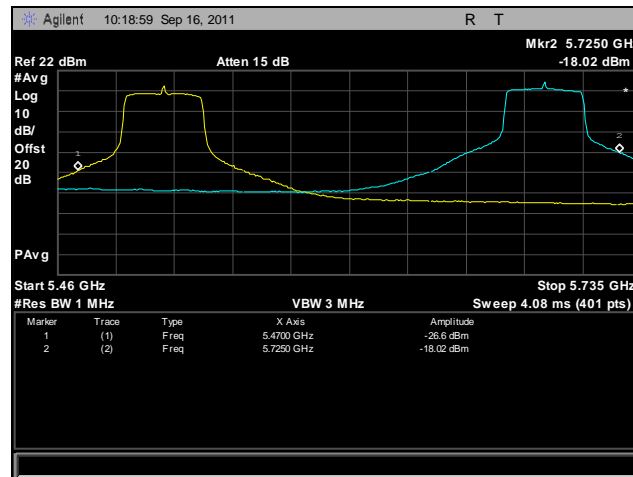

Plot 466. Frequency Stability, 802.11n 40 MHz, 5470 MHz – 5725 MHz @ 20°C, 108 V

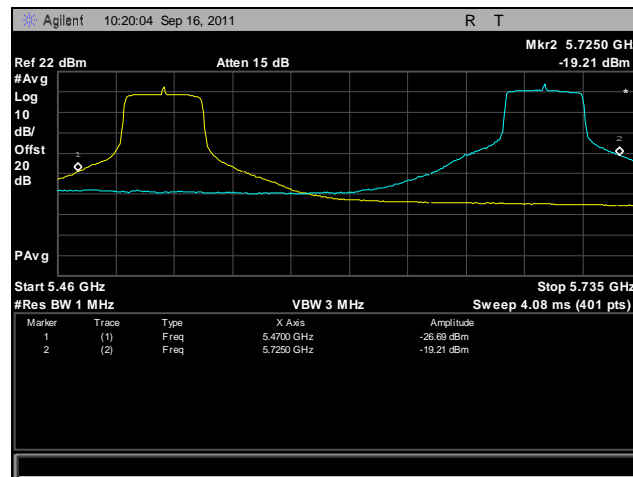

Plot 467. Frequency Stability, 802.11n 40 MHz, 5470 MHz – 5725 MHz @ 20°C, 120 V

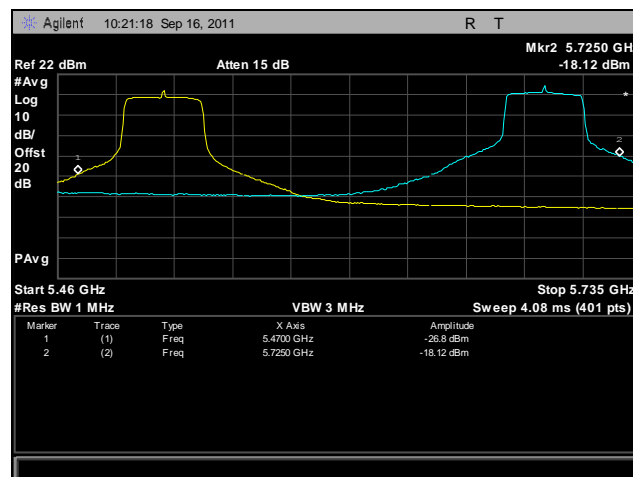

Plot 468. Frequency Stability, 802.11n 40 MHz, 5470 MHz – 5725 MHz @ 20°C, 132 V



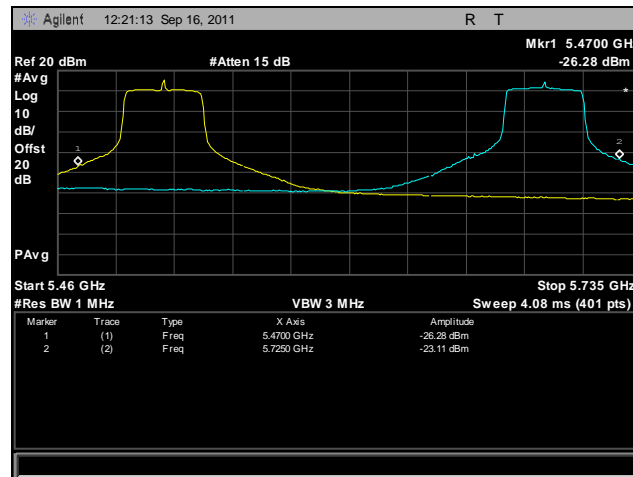

Plot 469. Frequency Stability, 802.11n 40 MHz, 5470 MHz – 5725 MHz @ 30°C, 120 V

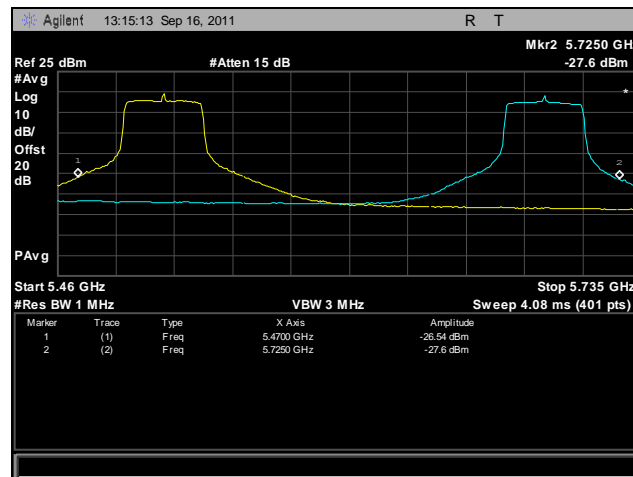

Plot 470. Frequency Stability, 802.11n 40 MHz, 5470 MHz – 5725 MHz @ 40°C, 120 V

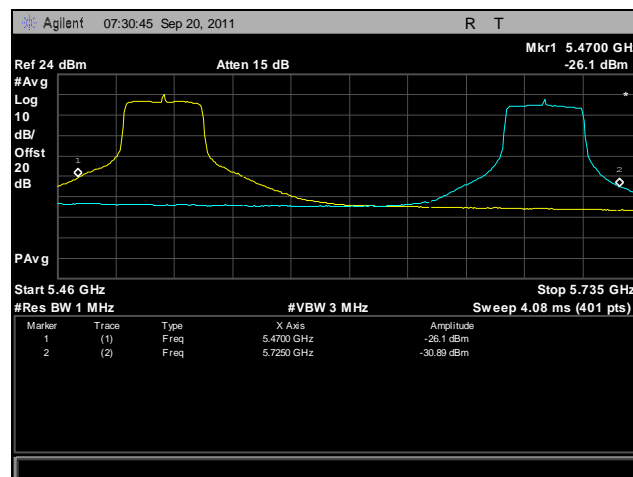

Plot 471. Frequency Stability, 802.11n 40 MHz, 5470 MHz – 5725 MHz @ 50°C, 120 V

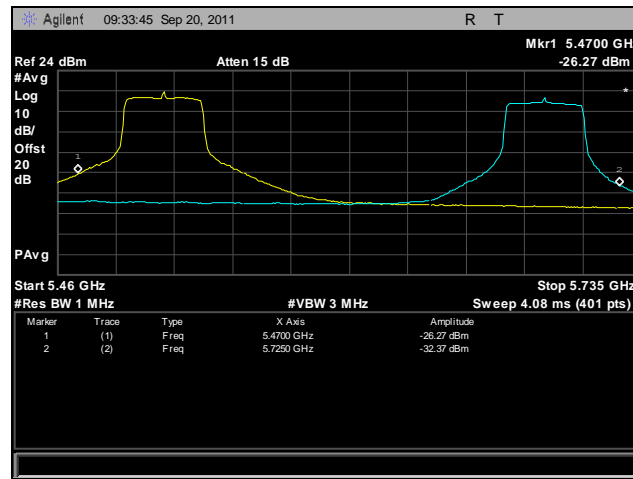

Plot 472. Frequency Stability, 802.11n 40 MHz, 5470 MHz – 5725 MHz @ 55°C, 120 V

## Electromagnetic Compatibility Criteria for Intentional Radiators

### RSS-GEN Receiver Spurious Emissions

**Test Requirement:** The following receiver spurious emission limits shall be complied with:

- a) If a radiated measurement is made, all spurious emissions shall comply with the limits of Table 28.

Spurious Frequency (MHz)	Field Strength (microvolt/m at 3 metres)
30-88	100
88-216	150
216-960	200
Above 960	500

**Table 28. Spurious Emission Limits for Receivers**

- b) If a conducted measurement is made, no spurious output signals appearing at the antenna terminals shall exceed 2 nanowatts per any 4 kHz spurious frequency in the band 30-1000 MHz, or 5 nanowatts above 1 GHz.

**Test Procedure:** The receiver spurious emissions were tested in compliance with the limits of Table 12. The testing was performed conducted.

**Test Results:** The EUT was compliant with the Receiver Spurious Emission limits of this requirement.

**Test Engineer(s):** Jeff Pratt

**Test Date(s):** 10/04/11

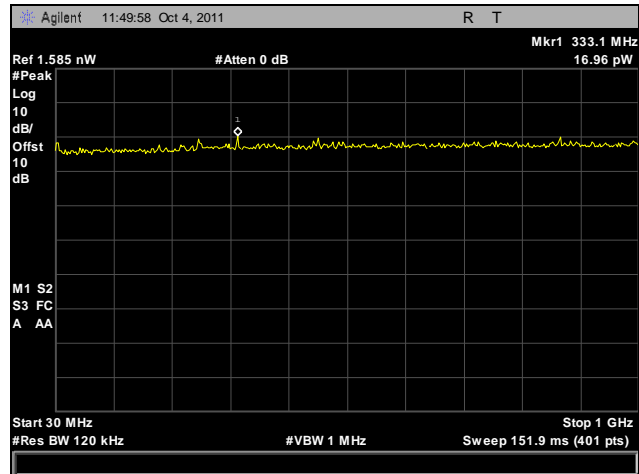

**Plot 473. Receiver Spurious Emission, 5.8 GHz, 30 MHz – 1 GHz, Port A**

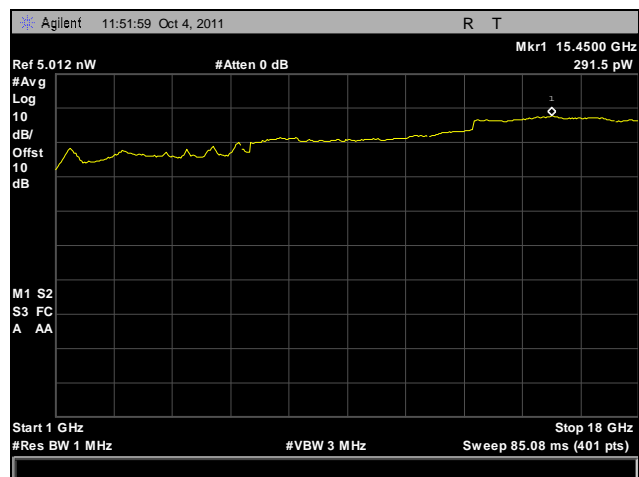

**Plot 474. Receiver Spurious Emission, 5.8 GHz, 1 GHz – 18 GHz, Port A**

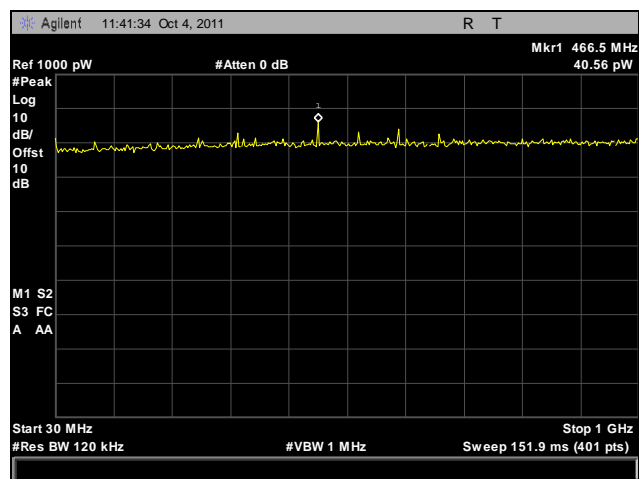

**Plot 475. Receiver Spurious Emission, 5.8 GHz, 30 MHz – 1 GHz, Port B**

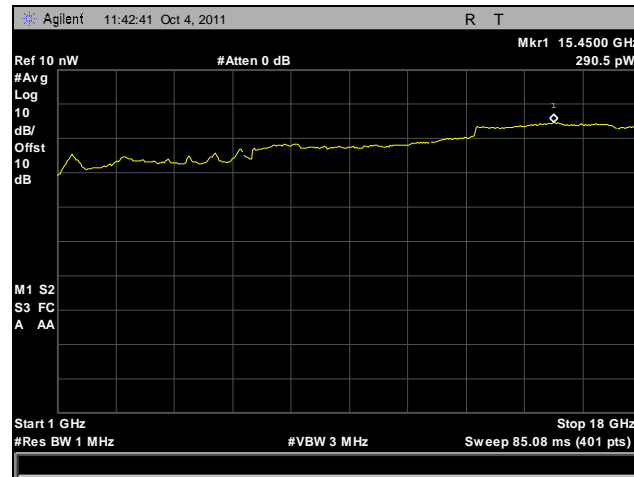

Plot 476. Receiver Spurious Emission, 5.8 GHz, 1 GHz – 18 GHz, Port B

## **V. DFS Requirements and Radar Waveform Description & Calibration**

## A. DFS Requirements

### DFS Detection Thresholds for Master or Client Devices Incorporating DFS

Maximum Transmit Power	Value
≥ 200 milliwatt	-64 dBm
< 200 milliwatt	-62 dBm

**Note 1:** This is the level at the input of the receiver assuming a 0 dBi receive antenna  
**Note 2:** Throughout these test procedures an additional 1 dB has been added to the amplitude of the test transmission waveforms to account for variations in measurement equipment. This will ensure that the test signal is at or above the detection threshold level to trigger a DFS response.

### DFS Response Requirement Values

Parameter	Value
<i>Non-occupancy period</i>	Minimum 30 minutes
<i>Channel Availability Check Time</i>	60 seconds
<i>Channel Move Time</i>	10 seconds See Note 1
<i>Channel Closing Transmission Time</i>	200 milliseconds + an aggregate of 60 milliseconds over remaining 10 second period. See Notes 1 and 2
<i>U-NII Detection Bandwidth</i>	Minimum 80% of the 99% power bandwidth. See Note 3.

**Note 1:** The instant that the *Channel Move Time* and the *Channel Closing Transmission Time* begins is as follows:

- For the Short pulse radar Test Signals this instant is the end of the *Burst*.
- For the Frequency Hopping radar Test Signal, this instant is the end of the last radar *Burst* generated.
- For the Long Pulse radar Test Signal this instant is the end of the 12 second period defining the radar transmission.

**Note 2:** The *Channel Closing Transmission Time* is comprised of 200 milliseconds starting at the beginning of the *Channel Move Time* plus any additional intermittent control signals required facilitating *Channel* changes (an aggregate of 60 milliseconds) during the remainder of the 10 second period. The aggregate duration of control signals will not count quiet periods in between transmissions.

**Note 3:** During the *U-NII Detection Bandwidth* detection test, radar type 1 is used and for each frequency step the minimum percentage of detection is 90%. Measurements are performed with no data traffic.

## B. Radar Test Waveforms

This section provides the parameters for required test waveforms, minimum percentage of successful detections, and the minimum number of trials that must be used for determining DFS conformance. Step intervals of 0.1 microsecond for Pulse Width, 1 microsecond for PRI, 1 MHz for chirp width and 1 for the number of pulses will be utilized for the random determination of specific test waveforms.

### Short Pulse Radar Test Waveforms

Radar Type	Pulse Width (μsec)	PRI (μsec)	Number of Pulses	Minimum Percentage of Successful Detection	Minimum Trials
1	1	1428	18	60%	30
2	1-5	150-230	23-29	60%	30
3	6-10	200-500	16-18	60%	30
4	11-20	200-500	12-16	60%	30
Aggregate (Radar Types 1-4)				80%	120

A minimum of 30 unique waveforms are required for each of the short pulse radar types 2 through 4. For short pulse radar type 1, the same waveform is used a minimum of 30 times. If more than 30 waveforms are used for short pulse radar types 2 through 4, then each additional waveform must also be unique and not repeated from the previous waveforms. The aggregate is the average of the percentage of successful detections of short pulse radar types 1-4.

### Long Pulse Radar Test Waveform

Radar Type	Pulse Width (μsec)	Chirp Width (MHz)	PRI (μsec)	Number of Pulses per Bursts	Number of Bursts	Minimum Percentage of Successful Detection	Minimum Trials
5	50-100	5-20	1000-2000	1-3	8-20	80%	30

The parameters for this waveform are randomly chosen. Thirty unique waveforms are required for the Long Pulse radar test signal. If more than 30 waveforms are used for the Long Pulse radar test signal, then each additional waveform must also be unique and not repeated from the previous waveforms.



Each waveform is defined as follows:

- 1) The transmission period for the Long Pulse Radar test signal is 12 seconds.
- 2) There are a total of 8 to 20 Bursts in the 12 second period, with the number of Bursts being randomly chosen. This number is Burst\_Count.
- 3) Each Burst consists of 1 to 3 pulses, with the number of pulses being randomly chosen. Each Burst within the 12 second sequence may have a different number of pulses.
- 4) The pulse width is between 50 and 100 microseconds, with the pulse width being randomly chosen. Each pulse within a Burst will have the same pulse width. Pulses in different Bursts may have different pulse widths.
- 5) Each pulse has a linear FM chirp between 5 and 20 MHz, with the chirp width being randomly chosen. Each pulse within a Burst will have the same chirp width. Pulses in different Bursts may have different chirp widths. The chirp is centered on the pulse. For example, with radar frequency of 5300 MHz and a 20 MHz chirped signal, the chirp starts at 5290 MHz and ends at 5310 MHz.
- 6) If more than one pulse is present in a Burst, the time between the pulses will be between 1000 and 2000 microseconds, with the time being randomly chosen. If three pulses are present in a Burst, the time between the first and second pulses is chosen independently of the time between the second and third pulses.
- 7) The 12 second transmission period is divided into even intervals. The number of intervals is equal to Burst\_Count. Each interval is of length  $(12,000,000 / \text{Burst\_Count})$  microseconds. Each interval contains one Burst. The start time for the Burst, relative to the beginning of the interval, is between 1 and  $[(12,000,000 / \text{Burst\_Count}) - (\text{Total Burst Length}) + (\text{One Random PRI Interval})]$  microseconds, with the start time being randomly chosen. The step interval for the start time is 1 microsecond. The start time for each Burst is chosen independently.

**A representative example of a Long Pulse radar test waveform:**

- 1) The total test signal length is 12 seconds.
- 2) 8 Bursts are randomly generated for the Burst\_Count.
- 3) Burst 1 has 2 randomly generated pulses.
- 4) The pulse width (for both pulses) is randomly selected to be 75 microseconds.
- 5) The PRI is randomly selected to be at 1213 microseconds.
- 6) Bursts 2 through 8 are generated using steps 3 – 5.
- 7) Each Burst is contained in even intervals of 1,500,000 microseconds. The starting location for Pulse 1, Burst 1 is randomly generated (1 to 1,500,000 minus the total Burst 1 length + 1 random PRI interval) at the 325,001 microsecond step. Bursts 2 through 8 randomly fall in successive 1,500,000 microsecond intervals (i.e. Burst 2 falls in the 1,500,001 – 3,000,000 microsecond range).

## Graphical Representation of a Long Pulse radar Test Waveform

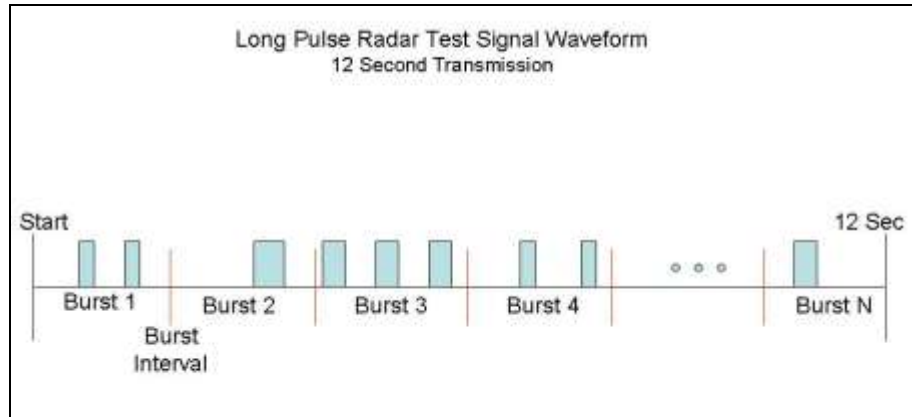

Figure 4. Long Pulse Radar Test Signal Waveform

### Frequency Hopping Radar Test Waveform

Radar Type	Pulse Width (μsec)	PRI (μsec)	Pulses per Hop	Hopping Rate (kHz)	Hopping Sequence Length (msec)	Minimum Percentage of Successful Detection	Minimum Trials
6	1	333	9	.333	300	70%	30

For the Frequency Hopping Radar Type, the same *Burst* parameters are used for each waveform. The hopping sequence is different for each waveform and a 100-length segment is selected from the hopping sequence defined by the following algorithm:

The first frequency in a hopping sequence is selected randomly from the group of 475 integer frequencies from 5250 – 5724 MHz. Next, the frequency that was just chosen is removed from the group and a frequency is randomly selected from the remaining 474 frequencies in the group. This process continues until all 475 frequencies are chosen for the set. For selection of a random frequency, the frequencies remaining within the group are always treated as equally likely.

### C. Radar Waveform Calibration

The following equipment setup was used to calibrate the conducted Radar Waveform. A spectrum analyzer was used to establish the test signal level for each radar type. During this process there were no transmissions by either the Master or Client Device. The spectrum analyzer was switched to the zero span (Time Domain) mode at the frequency of the Radar Waveform generator. Peak detection was utilized. The spectrum analyzer's resolution bandwidth (RBW) was set to 3 MHz and the video bandwidth (VBW) was set to 3 MHz. The calibration setup is diagrammed in Figure 5, and the radar test signal generator is shown in Figure 5.

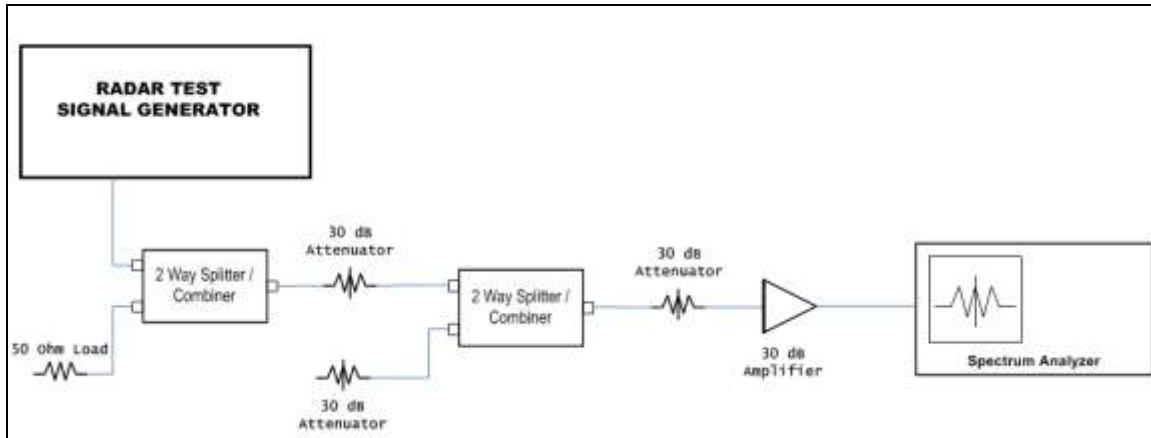
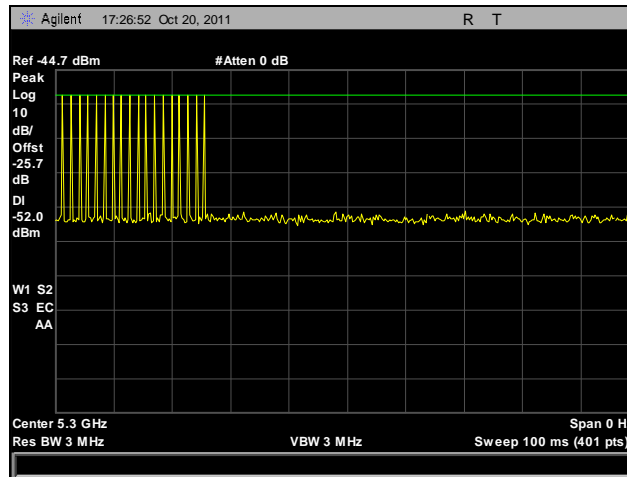
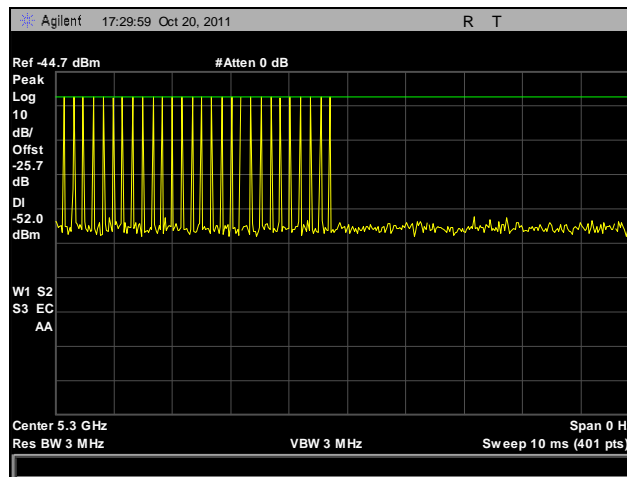

Figure 5. DFS Radar Waveform Calibration Setup

## Radar Waveform Calibration



Plot 477. Radar Calibration, Bin 1



Plot 478. Radar Calibration, Bin 2

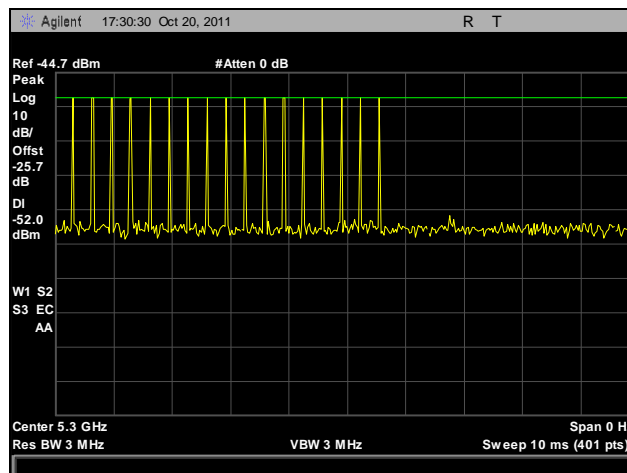

Plot 479. Radar Calibration, Bin 3

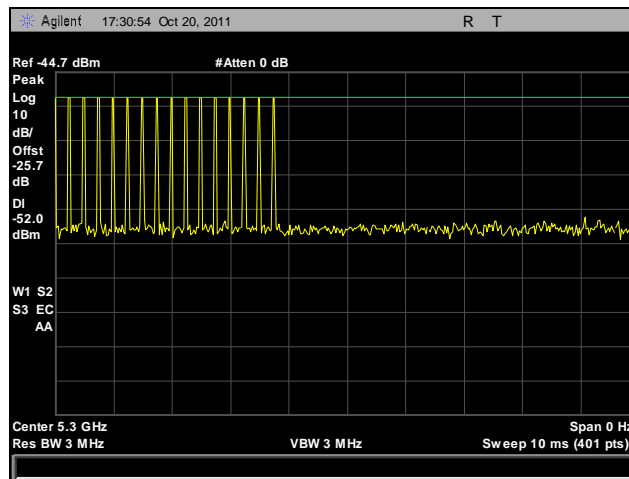

**Plot 480. Radar Calibration, Bin 4**

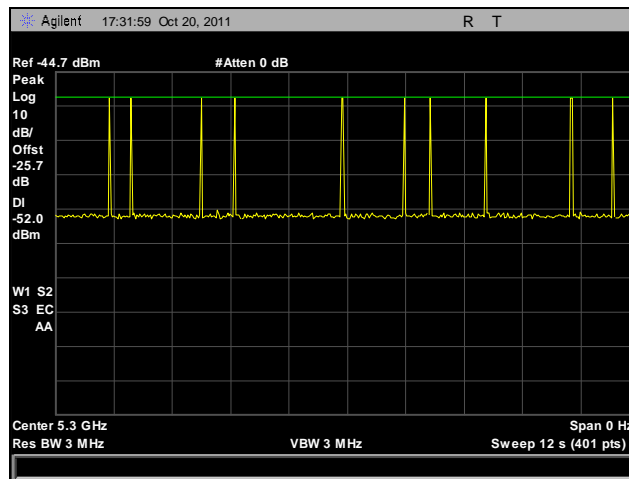

**Plot 481. Radar Calibration, Bin 5**

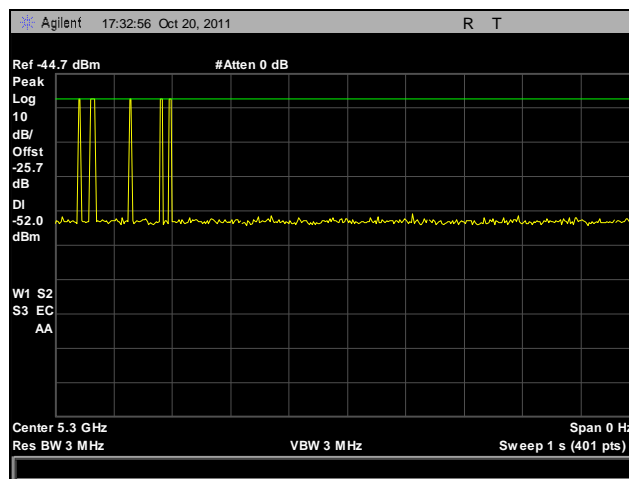

**Plot 482. Radar Calibration, Bin 6**

## **VI. DFS Test Procedure and Test Results**

## A. DFS Test Setup

1. A spectrum analyzer is used as a monitor to verify that the Unit Under Test (UUT) has vacated the Channel within the Channel Closing Transmission Time and Channel Move Time, and does not transmit on a Channel during the Non-Occupancy Period after the detection and subsequent Channel move. It is also used to monitor UUT transmissions during the Channel Availability Check Time.
2. The test setup, which consists of test equipment and equipment under test (EUT), is diagrammed in Figure 6 and pictured in Figure 6. Test Setup Diagram.

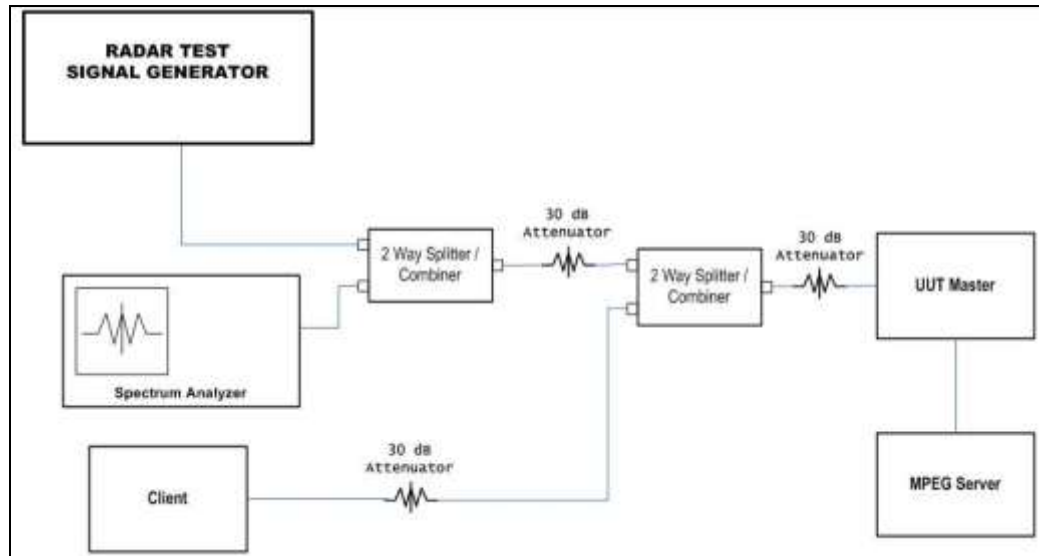

Figure 6. Test Setup Diagram

## **B. Description of Master Device**

1. Operating Frequency Range – 5250-5350 MHz; 5500-5700 MHz
2. Modes of Operation – 802.11a/802.11n
3. Highest and Lowest EIRP – Highest: 30 dBm; Lowest: 26.54 dBm
4. List all antennas and associated gains –
  - PCTel SP4959 16XP90 4.9-5.9GHz MIMO Sector Antenna  
Gain is 16
  
  - AirMax 5G10 Omni 5GHz MIMO Antenna  
Gain is 10
5. List output power ranges – 16.54 dBm - 19.91 dBm
6. List antenna impedance – 50 ohms
7. Antenna gain verification - Use antenna data sheet
8. State test file that is transmitted – 6 and ½ Magic Hours
9. Time for master to complete its power-on-cycle – 92 seconds



### C. UNII Detection Bandwidth

**Test Requirement(s):** § 15.407 A minimum 80% detection rate is required across an EUT's 99% bandwidth.

**Test Procedure:** All UNII channels for this device have two channel bandwidths. Therefore, DFS testing was done at 20 MHz bandwidth at 5580 MHz and 40 MHz bandwidth at 5310 MHz.

A single burst of the short pulse radar type 1 is produced at 5580 and 5310 MHz, at the -63dBm test level. The UUT is set up as a standalone device (no associated client, and no data traffic).

A single radar burst is generated for a minimum of 10 trials, and the response of the UUT is recorded. The UUT must detect the radar waveform 90% or more of the time.

The radar frequency is increased in 1 MHz steps, repeating the above test sequence, until the detection rate falls below 90%. The highest frequency at which detection is greater than or equal to 90% is denoted  $F_H$ .

The radar frequency is decreased in 1 MHz steps, repeating the above test sequence, until the detection rate falls below 90%. The lowest frequency at which detection is greater than or equal to 90% is denoted  $F_L$ .

The U-NII Detection Bandwidth is calculated as follows:

$$\text{U-NII Detection Bandwidth} = F_H - F_L$$

Test was truncated after U-NII Detection Bandwidth was found to be greater than the 99% Power Bandwidth.

**Test Results:** The EUT was compliant with this requirement.

**Test Engineer:** Jeff Pratt

**Test Date:** 10/17/11

## UNII Detection Bandwidth – Test Results

EUT Frequency- 5300MHz												
Radar Frequency (MHz)	DFS Detection Trials (1=Detection, 0= No Detection)										Detection Rate (%)	
	1	2	3	4	5	6	7	8	9	10		
5288	0	1	1	1	1	1	1	0	0	1	1	70
5289	1	1	1	1	1	1	1	1	1	1	1	100
5290	1	1	1	1	1	1	1	1	1	1	1	100
5291	1	1	1	1	1	1	1	1	1	1	1	100
5292	1	1	1	1	1	1	1	1	1	1	1	100
5293	1	1	1	1	1	1	1	1	1	1	1	100
5294	1	1	1	1	1	1	1	1	1	1	1	100
5295	1	1	1	1	1	1	1	1	1	1	1	100
5296	1	1	1	1	1	1	1	1	1	1	1	100
5297	1	1	1	1	1	1	1	1	1	1	1	100
5298	1	1	1	1	1	1	1	1	1	1	1	100
5299	1	1	1	1	1	1	1	1	1	1	1	100
5300	1	1	1	1	1	1	1	1	1	1	1	100
5301	1	1	1	1	1	1	1	1	1	1	1	100
5302	1	1	1	1	1	1	1	1	1	1	1	100
5303	1	1	1	1	1	1	1	1	1	1	1	100
5304	1	1	1	1	1	1	1	1	1	1	1	100
5305	1	1	1	1	1	1	1	1	1	1	1	100
5306	1	1	1	1	1	1	1	1	1	1	1	100
5307	1	1	1	1	1	1	1	1	1	1	1	100
5308	1	1	1	1	1	1	1	1	1	1	1	100
5309	1	1	1	1	1	1	1	1	1	1	1	100
5310	1	1	1	1	1	1	1	1	1	1	1	100
5311	1	1	1	1	1	1	1	1	1	1	1	100
5312	1	1	1	1	1	1	1	1	1	1	1	100
5313	1	1	1	1	1	1	1	1	1	1	1	100
5314	1	1	1	1	1	1	1	1	1	1	1	100
5315	1	1	1	1	1	1	1	1	1	1	1	100
5316	1	1	1	1	1	1	1	1	1	1	1	100
5317	1	1	1	1	1	1	1	1	1	1	1	100
5318	1	1	1	1	1	1	1	1	1	1	1	100
5319	1	1	1	1	1	1	1	1	1	1	1	100
5320	1	1	1	1	1	1	1	1	1	1	1	100
5321	1	1	1	1	1	1	1	1	1	1	1	100
5322	1	1	1	1	1	1	1	1	1	1	1	100
5323	1	1	1	1	1	1	1	1	1	1	1	100
5324	1	1	1	1	1	1	1	1	1	1	1	100
5325	1	1	1	1	1	1	1	1	1	1	1	100
5326	0	1	1	1	1	1	1	1	1	1	1	90
5327	1	1	1	1	1	1	1	1	1	1	1	100
5328	1	1	1	1	1	1	1	1	1	1	1	100
5329	1	1	1	1	1	1	1	1	1	1	1	100
5330	1	1	1	1	1	1	1	1	1	1	1	100
5331	1	1	1	1	1	1	1	1	1	1	1	100
Overall Detection Percentage											99.1%	
Detection Bandwidth = $f_h - f_l = 5331\text{MHz} - 5288\text{MHz} = 43\text{MHz}$												
EUT 99% Bandwidth = 36.17MHz												
OBW* 80% = 28.936MHz												

**Table 29. UNII Detection Bandwidth, Test Results**

## **D. Initial Channel Availability Check Time**

**Test Requirements:** § 15.407 The Initial Channel Availability Check Time tests that the UUT does not emit beacon, control, or data signals on the test channel until the power-up sequence has been completed and the U-NII device has checked for radar waveforms, for one minute, on the test channel. This test does not use any of the radar waveforms and only needs to be performed once.

The UUT should not make any transmissions over the test channel, for at least 1 minute after completion of its power-on cycle.

**Test Procedure:** The U-NII device is powered on and instructed to operate at 5580 MHz. At the same time the UUT is powered on, the spectrum analyzer is set to 5580MHz with a zero span and a 2.5 minute sweep time. The analyzer is triggered at the same time power is applied to the U-NII device.

**Test Results:** The initial power up time of the EUT is indicated by marker 1R on Plot 483. Initial beacon/data transmission is indicated by marker 1.

The Equipment complies with § 15.407 Initial Channel Availability Check Time.

**Test Engineer:** Jeff Pratt

**Test Date:** 10/18/11

### Initial Channel Availability Check Time – Plot

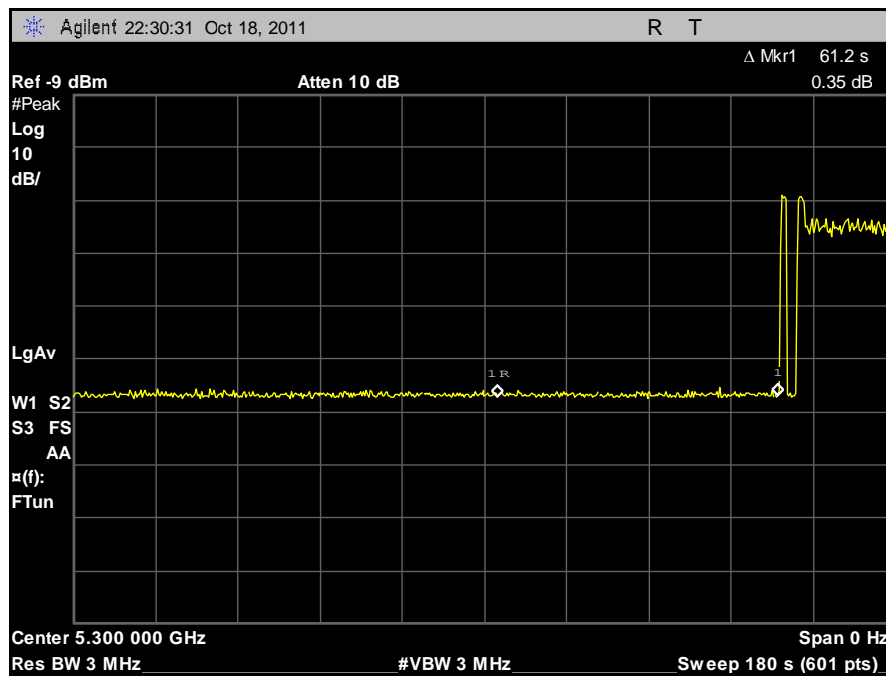

Plot 483. Initial Channel Availability Check Time

## **E. Radar Burst at the Beginning of Channel Availability Check Time**

**Test Requirements:** § 15.407 A Radar Burst at the Beginning of the Channel Availability Check Time tests that the UUT does not emit beacon, control, or data signals on the test Channel if it has detected a radar burst during that time period until the power-up sequence has been completed and the U-NII device checks for Radar Waveforms for one minute on the test Channel. The steps below define the procedure to verify successful radar detection on the selected Channel during a period equal to the Channel Availability Check Time and avoidance of operation on that Channel when a radar Burst with a level equal to the DFS Detection Threshold + 1 dB (-63dBm) occurs at the beginning of the Channel Availability Check Time.

**Test Procedure:** The UUT is powered on at T0. T1 denotes the instant when the UUT has completed its power-up sequence. The Channel Availability Check Time commences at instant T1 and will end no sooner than T1 + 60 seconds.

A single Burst of short pulse radar type 1, at -63 dBm, will commence within a 6 second window starting at T1.

Visual indication of the UUT of successful detection of the radar Burst will be recorded and reported. Observation of transmission at 5580MHz will continue for 2.5 minutes after the radar Burst has been generated.

Verify that during the 2.5 minute measurement window, no UUT transmissions occur at 5580MHz.

**Test Results:** Plot 484 below indicates that there were no UUT transmissions during the 2.5 minute measurement window. Marker 1R indicates completion of the power-on cycle. Marker 1 indicates the end of the 60-second channel availability check time.

The equipment complies with § 15.407 Radar Burst at the Beginning of the Channel Availability Check Time.

**Test Engineer:** Jeff Pratt

**Test Date:** 10/18/11

### Radar Burst at the Beginning of Channel Availability Check Time – Plot

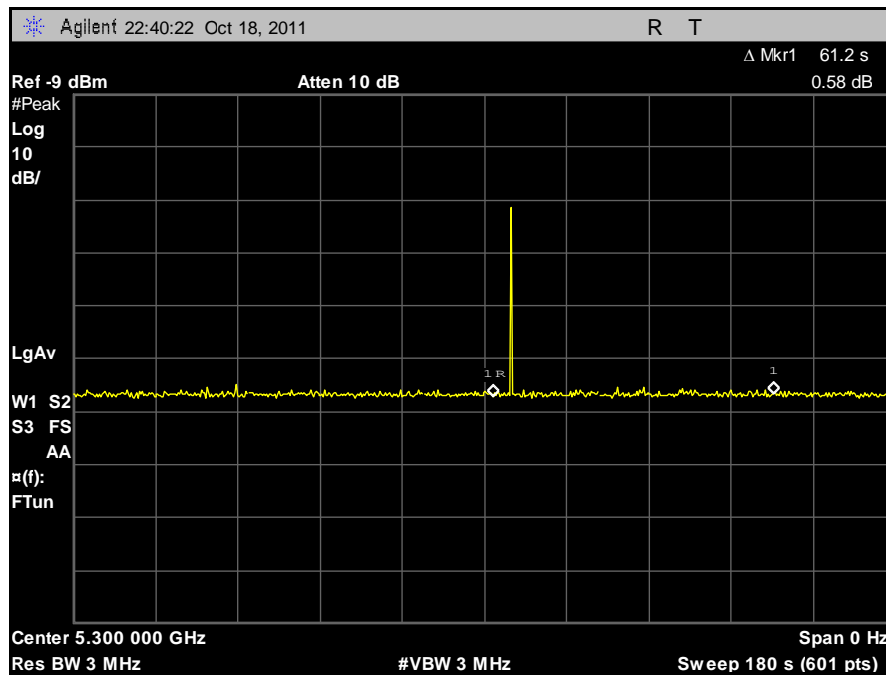

**Plot 484. Radar Burst at the Beginning of CACT**

## F. Radar Burst at the End of Channel Availability Check Time

**Test Requirements:** § 15.407 A Radar Burst at the End of the Channel Availability Check Time tests that the UUT does not emit beacon, control, or data signals on the test Channel if it has detected a radar burst during that time period until the power-up sequence has been completed and the U-NII device checks for Radar Waveforms for one minute on the test Channel. The steps below define the procedure to verify successful radar detection on the selected Channel during a period equal to the Channel Availability Check Time and avoidance of operation on that Channel when a radar Burst with a level equal to the DFS Detection Threshold + 1 dB (-63dBm) occurs at the end of the Channel Availability Check Time.

**Test Procedure:** The steps below define the procedure to verify successful radar detection on the selected Channel during a period equal to the Channel Availability Check Time and avoidance of operation on that Channel when a radar Burst with a level equal to the DFS Detection Threshold + 1 dB (-63dBm) occurs at the end of the Channel Availability Check Time.

The UUT is powered on at T0. T1 denotes the instant when the UUT has completed its power-up sequence. The Channel Availability Check Time commences at instant T1 and will end no sooner than T1 + 60 seconds.

A single Burst of short pulse of radar type 1 at -63 dBm will commence within a 6 second window starting at T1+ 54 seconds.

Visual indication on the UUT of successful detection of the radar Burst will be recorded and reported. Observation of emissions at 5580 MHz will continue for 2.5 minutes after the radar Burst has been generated.

Verify that during the 2.5 minute measurement window no UUT transmissions occurred at 5580MHz.

**Test Results:** Plot 485 indicates that no UUT transmissions occurred during the 2.5 minute measurement window. Marker 1R indicates completion of the power-on cycle. Marker 1 indicates the end of the 60-second channel availability check time.

The equipment complies with § 15.407 Radar Burst at the End of the Channel Availability Check Time.

**Test Engineer:** Jeff Pratt

**Test Date:** 10/18/11

### Radar Burst at the End of Channel Availability Check Time – Plot

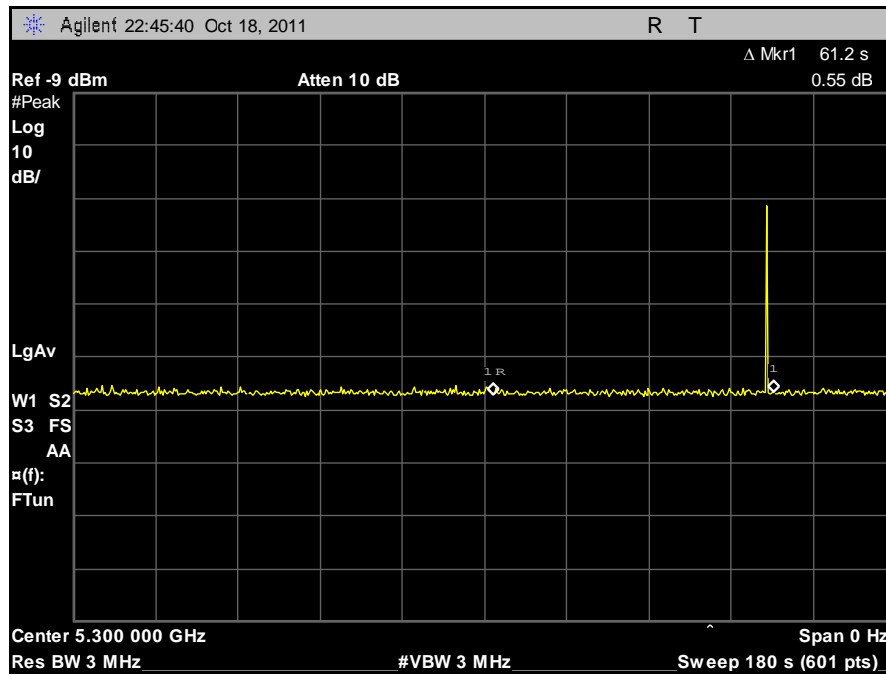

Plot 485. Radar Burst at the End of CACT



## **G. In-Service Monitoring for Channel Move Time, Channel Closing Transmission Time, and Non-Occupancy Period**

**Test Requirements:** § 15.407 (Refer to DFS Response Requirement Values table in section III-A of this report.) The UUT shall continuously monitor for radar transmissions in the operating test channel. When a radar burst occurs in the test channel, it has 10 seconds to move to another channel. This 10 second window is termed Channel Move Time (CMT).

When a radar burst occurs, the UUT has 200 milliseconds, plus an aggregate of 60 milliseconds, to cease transmission in the operating test channel. This 200 ms + 60 ms requirement is termed Channel Closing Transmission Time (CCT).

After radar burst and subsequent move to another channel, the UUT shall not resume transmission, on the channel it moved from, for a period of 30 minutes. This requirement is termed Non-Occupancy Period (NOP).

**Test Procedure:** These tests define how the following DFS parameters are verified during In-Service Monitoring: Channel Closing Transmission Time, Channel Move Time, and Non-Occupancy Period.

The steps below define the procedure to determine the above mentioned parameters when a radar Burst with a level equal to the DFS Detection Threshold + 1dB (-63dBm) is generated on the Operating Channel of the U-NII device.

A U-NII device operating as a Client Device will associate with the UUT (Master) at 5580MHz. Stream the MPEG test file from the Master Device to the Client Device on the selected Channel for the entire period of the test.

At time T0 the Radar Waveform generator sends a Burst of pulses for each of the radar types at -63dBm.

Observe the transmissions of the UUT at the end of the radar Burst on the Operating Channel for duration greater than 10 seconds. Measure and record the transmissions from the UUT during the observation time (Channel Move Time). Compare the Channel Move Time and Channel Closing Transmission Time results to the limits defined in the *DFS Response Requirement Values table*.

**Test Results:** Plot 486 and Plot 487 indicate cessation of transmission for more than 10 seconds after a radar burst (marker 1). Plot 488 depicts the 200 ms closing time window (marker 1), and Plot 489 depicts post 200 ms aggregate transmissions. Finally, Plot 491 shows that transmissions have not resumed within 30 minutes of channel move.

The UUT complies with § 15.407 In-Service Monitoring for Channel Move Time, Channel Closing Transmission Time, and Non-Occupancy Period.

**Test Engineer:** Jeff Pratt

**Test Date:** 10/17/11

### In-Service Monitoring for Channel Move Time – Plots

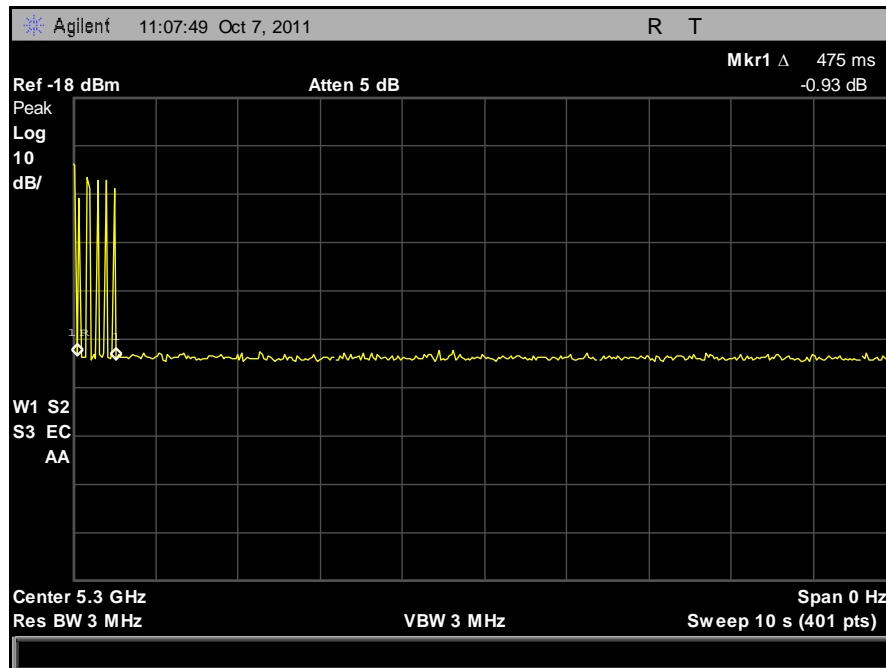

Plot 486. Channel Move Time

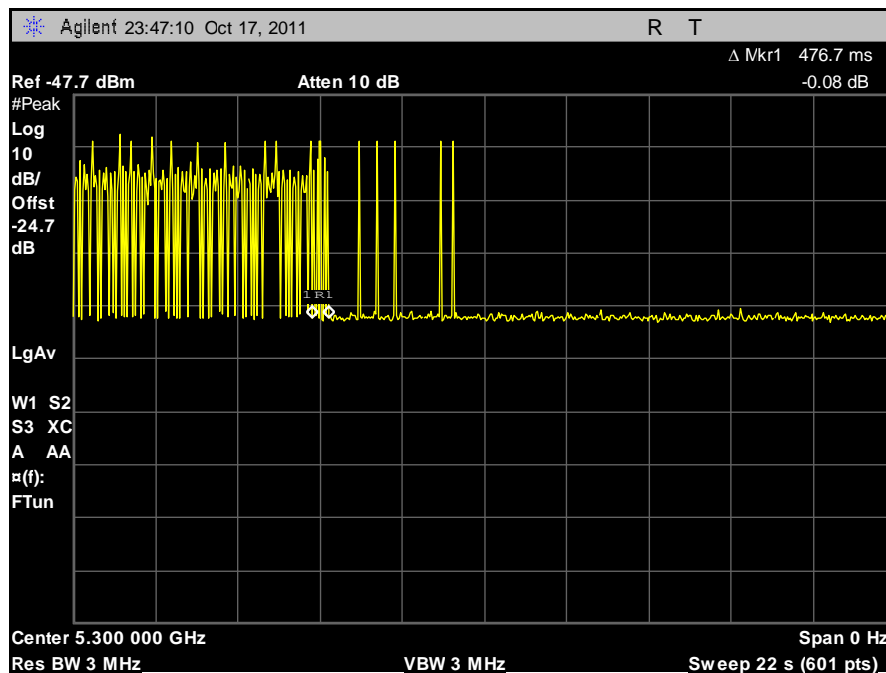

Plot 487. Channel Move Time, Bin 5

## In-Service Monitoring for Channel Closing Transmission Time – Plots

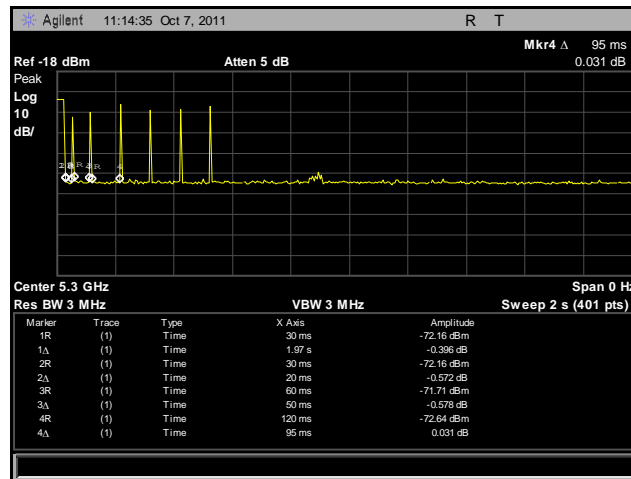

Plot 488. Channel Closing Transmission Time, 1

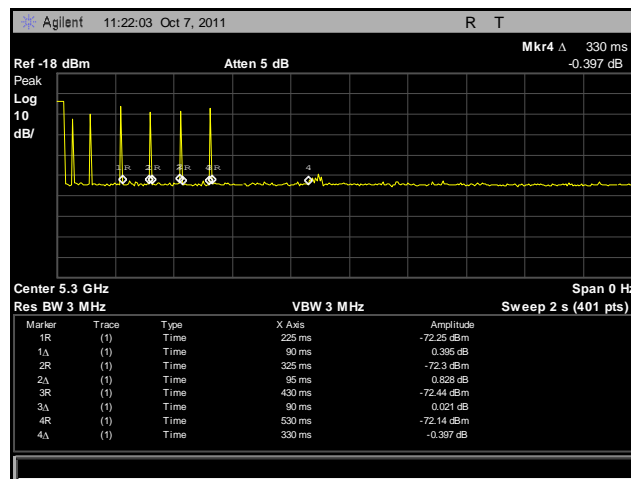

Plot 489. Channel Closing Transmission Time, 2

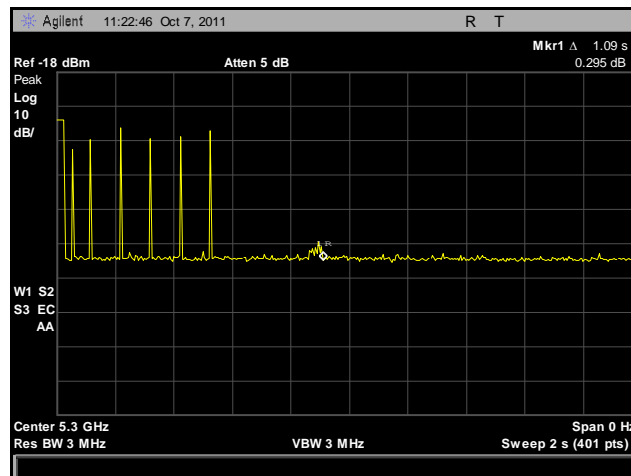

Plot 490. Channel Closing Transmission Time, 3

### In-Service Monitoring for Non-Occupancy Period – Plot

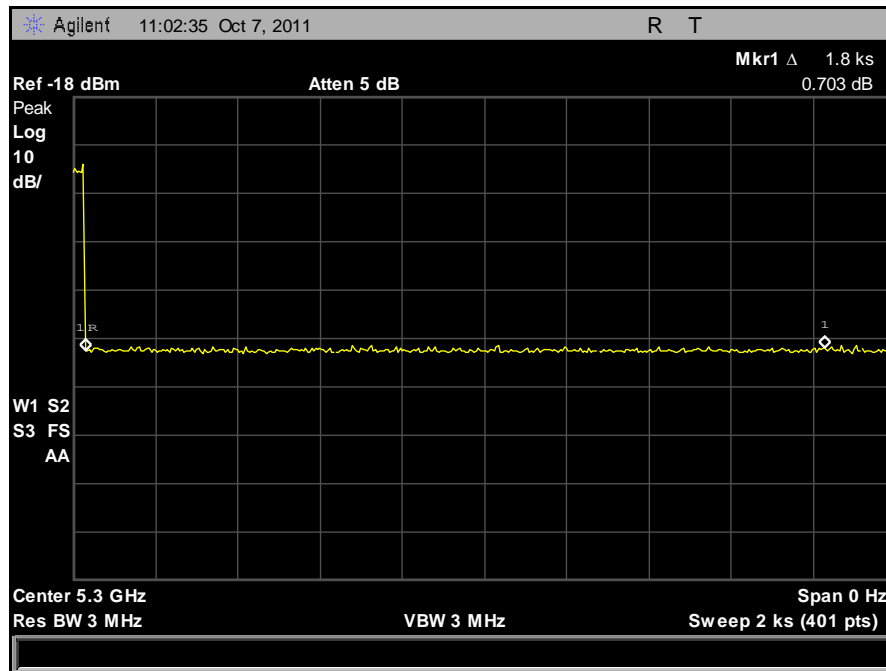

Plot 491. Non-Occupancy Period

## H. Statistical Performance Check

**Test Requirements:** § 15.407 During In-Service Monitoring, the EUT requires a minimum percentage of successful radar detections from all required radar waveforms at a level equal to the DFS Detection Threshold + 1dB.

**Test Procedure:** Stream the MPEG test file from the Master Device to the Client Device on the selected Channel for the entire period of the test. The Radar Waveform generator sends the individual waveform for each of the radar types 1-6 at -63dbm. Statistical data is gathered to determine the ability of the device to detect the radar test waveforms. The device can utilize a test mode to demonstrate when detection occurs to prevent the need to reset the device between trial runs. The percentage of successful detection is calculated by:

$$\frac{\text{TotalWaveformDetections}}{\text{TotalWaveformTrials}} \times 100$$

The Minimum number of trails, minimum percentage of successful detection and the average minimum percentage of successful detection are found in the Radar Test Waveforms section.

**Test Results:** Statistical performance for radar type 1 is tabulated in Table 30.

The equipment complies with § 15.407 Statistical Performance Check.

**Test Engineer:** Jeff Pratt

**Test Date:** 10/17/11

Radar Type	Trial #	Pulses per Burst	Pulse Width (μsec)	PRI (μsec)	Detection
					1 = Yes, 0 = No
1	1	18	1	1428	1
	2	18	1	1428	1
	3	18	1	1428	1
	4	18	1	1428	1
	5	18	1	1428	1
	6	18	1	1428	1
	7	18	1	1428	1
	8	18	1	1428	1
	9	18	1	1428	1
	10	18	1	1428	1
	11	18	1	1428	1
	12	18	1	1428	1
	13	18	1	1428	1
	14	18	1	1428	1
	15	18	1	1428	1
	16	18	1	1428	1
	17	18	1	1428	1
	18	18	1	1428	1
	19	18	1	1428	1
	20	18	1	1428	1
	21	18	1	1428	1
	22	18	1	1428	1
	23	18	1	1428	1
	24	18	1	1428	1
	25	18	1	1428	1
	26	18	1	1428	1
	27	18	1	1428	1
	28	18	1	1428	1
	29	18	1	1428	1
	30	18	1	1428	1
<b>Detection Percentage</b>					<b>100% (&gt; 60%)</b>

**Table 30. Statistical Performance Check – Radar Type 1**

Radar Type	Trial #	Pulse Width 1 to 5 $\mu$ sec	PRI 150 to 230 $\mu$ sec	Pulses per Burst 23 to 29	Detection
					1 = Yes, 0 = No
2	1	2.1	169	29	1
	2	4.4	197	27	1
	3	3.2	167	23	1
	4	3.3	154	26	1
	5	3.5	225	23	1
	6	1.8	218	26	1
	7	4.9	203	28	1
	8	3.6	214	27	1
	9	1.9	160	26	1
	10	3.7	192	29	1
	11	3.5	153	25	1
	12	4.2	225	29	1
	13	2.4	157	25	1
	14	3.9	223	25	1
	15	4.3	157	28	1
	16	3.2	165	27	1
	17	4.4	169	28	1
	18	3	194	29	1
	19	3.2	189	25	1
	20	1.1	155	28	1
	21	4	177	28	1
	22	2.1	213	24	1
	23	1	228	29	1
	24	2.5	192	28	1
	25	4	187	24	1
	26	3.1	177	29	1
	27	2.3	199	23	1
	28	2.4	218	24	1
	29	4.4	167	26	1
	30	1	226	29	1
<b>Detection Percentage</b>					<b>100% (&gt; 60%)</b>

**Table 31. Statistical Performance Check – Radar Type 2**

Radar Type	Trial #	Pulse Width 6 to 10 $\mu$ sec	PRI 200 to 500 $\mu$ sec	Pulses per Burst 16 to 18	Detection
					1 = Yes, 0 = No
3	1	9	328	18	0
	2	6.4	420	17	1
	3	6.3	283	18	1
	4	6.7	408	18	1
	5	5.8	253	18	1
	6	5.5	458	17	1
	7	5.4	415	17	1
	8	8	372	16	0
	9	5.8	277	18	1
	10	5.7	463	17	1
	11	8.8	468	18	0
	12	5.6	297	16	1
	13	9.3	364	16	1
	14	9.5	438	16	1
	15	9.2	420	16	1
	16	5.2	463	16	1
	17	7.3	267	18	1
	18	8.4	446	17	0
	19	9.3	302	17	1
	20	6.4	398	16	1
	21	5.8	402	17	1
	22	8.6	261	17	1
	23	9.3	409	17	1
	24	7.9	281	17	1
	25	6	321	17	1
	26	9	435	18	1
	27	9.3	258	17	1
	28	5.9	378	16	1
	29	9.2	482	16	1
	30	7.4	271	17	1
<b>Detection Percentage</b>					<b>86.7% (&gt; 60%)</b>

**Table 32. Statistical Performance Check – Radar Type 3, 5580 MHz, 802.11a**



Radar Type	Trial #	Pulse Width 11 to 20 µsec	PRI 200 to 500 µsec	Pulses per Burst 12 to 16	Detection
					1 = Yes, 0 = No
4	1	18.6	250	16	1
	2	19.4	375	16	1
	3	12.9	436	13	0
	4	11	495	16	1
	5	11.6	257	15	1
	6	17	336	15	1
	7	11.1	472	14	1
	8	12.5	275	16	1
	9	15	461	15	1
	10	11.2	322	13	1
	11	13	293	16	1
	12	17.1	496	14	1
	13	19.1	340	14	1
	14	19.7	329	13	1
	15	15.5	379	14	1
	16	19.2	405	14	1
	17	19.9	290	16	1
	18	10.2	325	14	1
	19	13.4	343	13	1
	20	14.3	439	14	0
	21	15.2	410	16	1
	22	13.7	260	13	1
	23	16.8	269	16	1
	24	15.2	496	15	1
	25	16	408	14	1
	26	18.4	489	14	1
	27	14.6	455	12	1
	28	14.4	450	14	1
	29	14.3	477	13	1
	30	10.9	281	16	1
<b>Detection Percentage</b>					<b>93.3% (&gt; 60%)</b>

**Table 33. Statistical Performance Check – Radar Type 4**

Radar Type	Trial #	Filename*	Detection
			1 = Yes, 0 = No
5	1	bin5set101trial 1	0
	2	bin5set101trial 2	1
	3	bin5set101trial 3	1
	4	bin5set101trial 4	0
	5	bin5set101trial 5	1
	6	bin5set101trial 6	1
	7	bin5set101trial 7	1
	8	bin5set101trial 8	1
	9	bin5set101trial 9	1
	10	bin5set101trial 10	1
	11	bin5set101trial 11	0
	12	bin5set101trial 12	1
	13	bin5set101trial 13	1
	14	bin5set101trial 14	1
	15	bin5set101trial 15	1
	16	bin5set101trial 16	1
	17	bin5set101trial 17	1
	18	bin5set101trial 18	0
	19	bin5set101trial 19	0
	20	bin5set101trial 20	1
	21	bin5set101trial 21	1
	22	bin5set101trial 22	1
	23	bin5set101trial 23	1
	24	bin5set101trial 24	1
	25	bin5set101trial 25	1
	26	bin5set101trial 26	1
	27	bin5set101trial 27	1
	28	bin5set101trial 28	1
	29	bin5set101trial 29	1
	30	bin5set101trial 30	1
<b>Detection Percentage</b>			<b>83.3% (&gt; 80%)</b>

**Table 34. Statistical Performance Check – Radar Type 5**

Note: See Appendix

Radar Type	Trial #	Frequency (MHz)	Pulses/Hop	Pulse Width (µsec)	PRI (µsec)	Detection
						1 = Yes, 0 = No
6	1	5300	9	1	333	1
	2	5300	9	1	333	1
	3	5300	9	1	333	1
	4	5300	9	1	333	1
	5	5300	9	1	333	1
	6	5300	9	1	333	1
	7	5300	9	1	333	1
	8	5300	9	1	333	1
	9	5300	9	1	333	1
	10	5300	9	1	333	1
	11	5300	9	1	333	1
	12	5300	9	1	333	1
	13	5300	9	1	333	1
	14	5300	9	1	333	1
	15	5300	9	1	333	1
	16	5300	9	1	333	1
	17	5300	9	1	333	1
	18	5300	9	1	333	1
	19	5300	9	1	333	1
	20	5300	9	1	333	1
	21	5300	9	1	333	1
	22	5300	9	1	333	1
	23	5300	9	1	333	1
	24	5300	9	1	333	1
	25	5300	9	1	333	1
	26	5300	9	1	333	1
	27	5300	9	1	333	1
	28	5300	9	1	333	1
	29	5300	9	1	333	1
	30	5300	9	1	333	1
<b>Detection Percentage</b>						<b>100% (&gt; 60%)</b>

**Table 35. Statistical Performance Check – Radar Type 6**

## I. DFS Setup



**Photograph 5. DFS Test Setup**

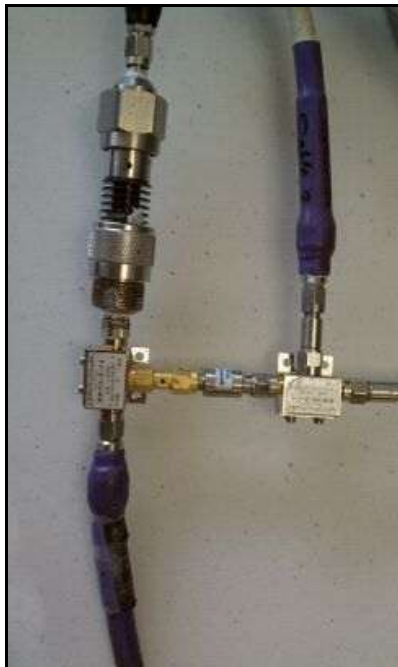

**Photograph 6. DFS Cable Setup**

## VII. Test Equipment

## Test Equipment

Calibrated test equipment utilized during testing was maintained in a current state of calibration per the requirements of ANSI/NCSL Z540-1-1994 and ANSI/ISO/IEC 17025:2000.

MET Asset #	Equipment	Manufacturer	Model	Last Cal Date	Cal Due Date
1T4771	SPECTRUM ANALYZER	AGILENT	E4446A	6/25/2011	6/25/2012
1T4442	PRE-AMPLIFIER, MICROWAVE	MITEQ	AFS42-01001800-30-10P	SEE NOTE	
1T4612	SPECTRUM ANALYZER	AGILENT TECHNOLOGIES	E4407B	10/27/2010	10/27/2011
1T4483	ANTENNA; HORN	ETS-LINDGREN	3117	7/19/2011	7/19/2012
1T4752	PRE-AMPLIFIER	MITEQ	JS44-18004000-35-8P	SEE NOTE	
1T4745	ANTENNA, HORN	ETS-LINDGREN	3116	10/4/2011	10/4/2012
1T4394	ISOLATION TRANSFORMER	TOPAZ	91005-31	SEE NOTE	
1T4751	ANTENNA – BILOG	SUNOL SCIENCES	JB6	11/3/2010	11/3/2011
1T4728	PROGRAMMABLE AC POWER SOURCE	QUADTECH	31010	SEE NOTE	
1T4409	EMI RECEIVER	ROHDE & SCHWARZ	ESIB7	6/14/2011	6/14/2012
1T4568	RADIATING NOISE SOURCE	MET LABORATORIES	N/A	SEE NOTE	
1T4565	LISN (24 AMP)	SOLAR ELECTRONICS	9252-50-R-24-BNC	10/28/2010	10/28/2011
1T4563	LISN (24 AMP)	SOLAR ELECTRONICS	9252-50-R-24-BNC	10/6/2010	10/6/2011
1T2109	RECEIVER, EMI, RECEIVER SECTION	HEWLETT PACKARD	85462A	1/7/2011	1/7/2012
1T2108	RECEIVER, EMI, FILTER SECTION	HEWLETT PACKARD	85460A	1/7/2011	1/7/2012
1T4502	COMB GENERATOR	COM-POWER	CGC-255	10/6/2010	10/6/2011
1T4634	THERMO/HYGRO/BAROMETER	CONTROL COMPANY	02-401	3/11/2010	3/11/2012
1T4758	THERMO-HYGROMETER	CONTROL COMPANY	4040	5/21/2010	5/21/2012
1T4505	TEMPERATURE CHAMBER	TEST EQUITY	115	11/29/2010	11/29/2011

**Table 36. Test Equipment List**

Note: Functionally tested equipment is verified using calibrated instrumentation at the time of testing.

MET Asset	Equipment	Manufacturer	Last Cal Date	Cal Due Date
1S2602	DFS SIGNAL GENERATOR	NATIONAL INSTRUMENTS	SEE NOTE	
1T4414	MICROWAVE PRE-AMPLIFIER	A.H. SYSTEMS INC.	SEE NOTE	
1T4354	SIGNAL GENERATOR	HEWLETT PACKARD	3/22/2011	3/22/2012

**Table 37. DFS Test Equipment List**

Note: Functionally tested equipment is verified using calibrated instrumentation at the time of testing.

## **VIII. Certification & User's Manual Information**



## Certification & User's Manual Information

### K. Certification Information

The following is extracted from Title 47 of the Code of Federal Regulations, Part 2, Subpart I — Marketing of Radio frequency devices:

#### § 2.801 Radio-frequency device defined.

As used in this part, a radio-frequency device is any device which in its operation is capable of Emitting radio-frequency energy by radiation, conduction, or other means. Radio- frequency devices include, but are not limited to:

- (a) The various types of radio communication transmitting devices described throughout this chapter.
- (b) *The incidental, unintentional and intentional radiators defined in Part 15 of this chapter.*
- (c) The industrial, scientific, and medical equipment described in Part 18 of this chapter.
- (d) Any part or component thereof which in use emits radio-frequency energy by radiation, conduction, or other means.

#### § 2.803 Marketing of radio frequency devices prior to equipment authorization.

- (a) Except as provided elsewhere in this chapter, no person shall sell or lease, or offer for sale or lease (including advertising for sale or lease), or import, ship or distribute for the purpose of selling or leasing or offering for sale or lease, any radio frequency device unless:
  - (1) In the case of a device subject to certification, such device has been authorized by the Commission in accordance with the rules in this chapter and is properly identified and labeled as required by §2.925 and other relevant sections in this chapter; or
  - (2) In the case of a device that is not required to have a grant of equipment authorization issued by the Commission, but which must comply with the specified technical standards prior to use, such device also complies with all applicable administrative (including verification of the equipment or authorization under a Declaration of Conformity, where required), technical, labeling and identification requirements specified in this chapter.
- (d) Notwithstanding the provisions of paragraph (a) of this section, the offer for sale solely to business, commercial, industrial, scientific or medical users (but not an offer for sale to other parties or to end users located in a residential environment) of a radio frequency device that is in the conceptual, developmental, design or pre-production stage is permitted prior to equipment authorization or, for devices not subject to the equipment authorization requirements, prior to a determination of compliance with the applicable technical requirements *provided* that the prospective buyer is advised in writing at the time of the offer for sale that the equipment is subject to the FCC rules and that the equipment will comply with the appropriate rules before delivery to the buyer or to centers of distribution.

- (e)(1) Notwithstanding the provisions of paragraph (a) of this section, prior to equipment authorization or determination of compliance with the applicable technical requirements any radio frequency device may be operated, but not marketed, for the following purposes and under the following conditions:
- (i) *Compliance testing*;
  - (ii) Demonstrations at a trade show provided the notice contained in paragraph (c) of this section is displayed in a conspicuous location on, or immediately adjacent to, the device;
  - (iii) Demonstrations at an exhibition conducted at a business, commercial, industrial, scientific or medical location, but excluding locations in a residential environment, provided the notice contained in paragraphs (c) or (d) of this section, as appropriate, is displayed in a conspicuous location on, or immediately adjacent to, the device;
  - (iv) Evaluation of product performance and determination of customer acceptability, provided such operation takes place at the manufacturer's facilities during developmental, design or pre-production states; or
  - (v) Evaluation of product performance and determination of customer acceptability where customer acceptability of a radio frequency device cannot be determined at the manufacturer's facilities because of size or unique capability of the device, provided the device is operated at a business, commercial, industrial, scientific or medical user's site, but not at a residential site, during the development, design or pre-production stages.
- (e)(2) For the purpose of paragraphs (e)(1)(iv) and (e)(1)(v) of this section, the term *manufacturer's facilities* includes the facilities of the party responsible for compliance with the regulations and the manufacturer's premises, as well as the facilities of other entities working under the authorization of the responsible party in connection with the development and manufacture, but not the marketing, of the equipment.
- (f) For radio frequency devices subject to verification and sold solely to business, commercial, industrial, scientific and medical users (excluding products sold to other parties or for operation in a residential environment), parties responsible for verification of the devices shall have the option of ensuring compliance with the applicable technical specifications of this chapter at each end user's location after installation, provided that the purchase or lease agreement includes a proviso that such a determination of compliance be made and is the responsibility of the party responsible for verification of the equipment.

## Certification & User's Manual Information

The following is extracted from Title 47 of the Code of Federal Regulations, Part 2, Subpart J — Equipment Authorization Procedures:

### § 2.901 Basis and Purpose

- (a) In order to carry out its responsibilities under the Communications Act and the various treaties and international regulations, and in order to promote efficient use of the radio spectrum, the Commission has developed technical standards for radio frequency equipment and parts or components thereof. The technical standards applicable to individual types of equipment are found in that part of the rules governing the service wherein the equipment is to be operated.<sup>1</sup> *In addition to the technical standards provided, the rules governing the service may require that such equipment be verified by the manufacturer or importer, be authorized under a Declaration of Conformity, or receive an equipment authorization from the Commission by one of the following procedures: certification or registration.*
- (b) The following sections describe the verification procedure, the procedure for a Declaration of Conformity, and the procedures to be followed in obtaining certification from the Commission and the conditions attendant to such a grant.

### § 2.907 Certification.

- (a) Certification is an equipment authorization issued by the Commission, based on representation and test data submitted by the applicant.
- (b) Certification attaches to all units subsequently marketed by the grantee which are identical (see Section 2.908) to the sample tested except for permissive changes or other variations authorized by the Commission pursuant to Section 2.1043.

---

<sup>1</sup> In this case, the equipment is subject to the rules of Part 15. More specifically, the equipment falls under Subpart B (of Part 15), which deals with unintentional radiators.

## Certification & User's Manual Information

### § 2.948 Description of measurement facilities.

- (a) Each party making measurements of equipment that is subject to an equipment authorization under Part 15 or Part 18 of this chapter, regardless of whether the measurements are filed with the Commission or kept on file by the party responsible for compliance of equipment marketed within the U.S. or its possessions, shall compile a description of the measurement facilities employed.
- (1) If the measured equipment is subject to the verification procedure, the description of the measurement facilities shall be retained by the party responsible for verification of the equipment.
- (i) *If the equipment is verified through measurements performed by an independent laboratory, it is acceptable for the party responsible for verification of the equipment to rely upon the description of the measurement facilities retained by or placed on file with the Commission by that laboratory. In this situation, the party responsible for the verification of the equipment is not required to retain a duplicate copy of the description of the measurement facilities.*
- (ii) If the equipment is verified based on measurements performed at the installation site of the equipment, no specific site calibration data is required. It is acceptable to retain the description of the measurement facilities at the site at which the measurements were performed.
- (2) If the equipment is to be authorized by the Commission under the certification procedure, the description of the measurement facilities shall be filed with the Commission's Laboratory in Columbia, Maryland. The data describing the measurement facilities need only be filed once but must be updated as changes are made to the measurement facilities or as otherwise described in this section. At least every three years, the organization responsible for filing the data with the Commission shall certify that the data on file is current.

## Certification & User's Manual Information

### Label and User's Manual Information

The following is extracted from Title 47 of the Code of Federal Regulations, Part 15, Subpart A — General:

#### § 15.19 Labeling requirements.

(a) *In addition to the requirements in Part 2 of this chapter, a device subject to certification or verification shall be labeled as follows:*

- (1) Receivers associated with the operation of a licensed radio service, e.g., FM broadcast under Part 73 of this chapter, land mobile operation under Part 90, etc., shall bear the following statement in a conspicuous location on the device:

This device complies with Part 15 of the FCC Rules. Operation is subject to the condition that this device does not cause harmful interference.

- (2) A stand-alone cable input selector switch, shall bear the following statement in a conspicuous location on the device:

This device is verified to comply with Part 15 of the FCC Rules for use with cable television service.

- (3) All other devices shall bear the following statement in a conspicuous location on the device:

*This device complies with Part 15 of the FCC Rules. Operation is subject to the following two conditions: (1) This device may not cause harmful interference, and (2) this device must accept any interference received, including interference that may cause undesired operation.*

- (4) Where a device is constructed in two or more sections connected by wires and marketed together, the statement specified under paragraph (a) of this section is required to be affixed only to the main control unit.

- (5) When the device is so small or for such use that it is not practicable to place the statement specified under paragraph (a) of this section on it, the information required by this paragraph shall be placed in a prominent location in the instruction manual or pamphlet supplied to the user or, alternatively, shall be placed on the container in which the device is marketed. However, the FCC identifier or the unique identifier, as appropriate, must be displayed on the device.

#### § 15.21 Information to user.

The users manual or instruction manual for an intentional or unintentional radiator shall caution the user that changes or modifications not expressly approved by the party responsible for compliance could void the user's authority to operate the equipment.

## Verification & User's Manual Information

The following is extracted from Title 47 of the Code of Federal Regulations, Part 15, Subpart B — Unintentional Radiators:

### § 15.105 Information to the user.

- (a) For a Class A digital device or peripheral, the instructions furnished the user shall include the following or similar statement, placed in a prominent location in the text of the manual:

Note: This equipment has been tested and found to comply with the limits for a Class A digital device, pursuant to Part 15 of the FCC Rules. These limits are designed to provide reasonable protection against harmful interference when the equipment is operated in a commercial environment. This equipment generates, uses, and can radiate radio frequency energy and, if not installed and used in accordance with the instruction manual, may cause harmful interference to radio communications. Operation of this equipment in a residential area is likely to cause harmful interference in which case the user will be required to correct the interference at own expense.

- (b) For a Class B digital device or peripheral, the instructions furnished the user shall include the following or similar statement, placed in a prominent location in the text of the manual:

Note: This equipment has been tested and found to comply with the limits for a Class B digital device, pursuant to Part 15 of the FCC Rules. These limits are designed to provide reasonable protection against harmful interference when the equipment is operated in a residential environment. This equipment generates, uses, and can radiate radio frequency energy and, if not installed and used in accordance with the instruction manual, may cause harmful interference to radio communications. However, there is no guarantee that interference will not occur in a particular installation. If this equipment does cause harmful interference to radio or television reception, which can be determined by turning the equipment off and on, the user is encouraged to try to correct the interference by one or more of the following measures:

- Reorient or relocate the receiving antenna.
- Increase the separation between the equipment and receiver.
- Connect the equipment into an outlet on a circuit different from that to which the receiver is connected.
- Consult the dealer or an experienced radio/TV technician for help.

## ICES-003 Procedural & Labeling Requirements

From the Industry Canada Electromagnetic Compatibility Advisory Bulletin entitled, "Implementation and Interpretation of the Interference-Causing Equipment Standard for Digital Apparatus, ICES-003" (EMCAB-3, Issue 2, July 1995):

"At present, CISPR 22: 2002 and ICES technical requirements are essentially equivalent. Therefore, if you have CISPR 22: 2002 approval by meeting CISPR Publication 22, the only additional requirements are: to attach a note to the report of the test results for compliance, indicating that these results are deemed satisfactory evidence of compliance with ICES-003 of the Canadian Interference-Causing Equipment Regulations; to maintain these records on file for the requisite five year period; and to provide the device with a notice of compliance in accordance with ICES-003."

### Procedural Requirements:

According to Industry Canada's Interference Causing Equipment Standard for Digital Apparatus ICES-003 Issue 4, February 2004:

- Section 6.1: A record of the measurements and results, showing the date that the measurements were completed, shall be retained by the manufacturer or importer for a period of at least five years from the date shown in the record and made available for examination on the request of the Minister.
- Section 6.2: A written notice indicating compliance must accompany each unit of digital apparatus to the end user. The notice shall be in the form of a label that is affixed to the apparatus. Where because of insufficient space or other constraints it is not feasible to affix a label to the apparatus, the notice may be in the form of a statement in the user's manual.

### Labeling Requirements:

The suggested text for the notice, in English and in French, is provided below, from the Annex of ICES-003:

This Class [<sup>2</sup>] digital apparatus complies with Canadian ICES-003.

Cet appareil numérique de la classe [<sup>1</sup>] est conforme à la norme NMB-003 du Canada.

---

<sup>2</sup> Insert either A or B but not both as appropriate for the equipment requirements.

# IX Appendix



Random DFS waveform parameters (NewBin5) 01-Oct-2011 08:53:11

Waveform Num = 1  
 Num of Bursts = 18  
 Burst Interval (us) = 666667.0

Burst #	Off Time (us)	# Pulses	Chirp (MHz)	PW (us)	Pulse 1 Pri(us)	Pulse 2 Pri(us)	Pulse 3 Pri(us)	Start Loc (us)	Start Burst Interval(us)	End Burst Interval(us)
1	598742	1	12.0	51	1266	0	0	598742	0	666666
2	725761	3	15.0	63	1393	1759	1617	1325769	666667	1333333
3	266922	3	5.0	51	1321	1794	1269	1597460	1333334	2000000
4	577038	1	9.0	93	1132	0	0	2178882	2000001	2666667
5	519984	3	7.0	54	1336	1258	1404	2699998	2666668	3333334
6	705478	1	20.0	77	1840	0	0	3409474	3333335	4000001
7	736866	1	10.0	63	1469	0	0	4148180	4000002	4666668
8	1065566	2	16.0	79	1294	1303	0	5215215	4666669	5333335
9	265178	3	20.0	60	1076	1318	1962	5482990	5333336	6000002
10	942598	2	16.0	50	1305	1250	0	6429944	6000003	6666669
11	258229	3	11.0	50	1777	1808	1580	6690728	6666670	7333336
12	1052341	1	18.0	88	1970	0	0	7748234	7333337	8000003
13	465257	1	18.0	68	1145	0	0	8215461	8000004	8666670
14	479238	2	17.0	75	1354	1443	0	8695844	8666671	9333337
15	1191420	3	7.0	60	1913	1400	1790	9890061	9333338	10000004
16	342917	3	14.0	83	1437	1759	1843	10238081	10000005	10666671
17	751169	3	6.0	81	1348	1142	1740	10994289	10666672	11333338
18	382319	1	18.0	66	1301	0	0	11380838	11333339	12000005

Total number of pulses in waveform = 37

□  
 Waveform Num = 2  
 Num of Bursts = 19

New3RandParmBin5.txt

Burst Interval (us) = 631579.0

Burst #	Off Time (us)	# Pulses	Chirp (MHz)	PW (us)	Pulse 1 Pri(us)	Pulse 2 Pri(us)	Pulse 3 Pri(us)	Start Loc (us)	Start Burst Interval(us)	End Burst Interval(us)
1	271686	2	18.0	68	1792	1132	0	271686	0	631578
2	938855	2	17.0	88	1605	1780	0	1213465	631579	1263157
3	260796	3	11.0	77	1932	1235	1692	1477646	1263158	1894736
4	671791	1	8.0	75	1324	0	0	2154296	1894737	2526315
5	696471	2	8.0	52	1804	1412	0	2852091	2526316	3157894
6	909064	2	18.0	92	1071	1661	0	3764371	3157895	3789473
7	124846	3	9.0	60	1241	1247	1117	3891949	3789474	4421052
8	653956	3	14.0	91	1914	1515	1421	4549510	4421053	5052631
9	618129	2	13.0	80	1119	1203	0	5172489	5052632	5684210
10	936481	3	6.0	88	1789	1154	1972	6111292	5684211	6315789
11	632001	3	15.0	100	1110	1036	1595	6748208	6315790	6947368
12	481521	3	7.0	64	1054	1393	1857	7233470	6947369	7578947
13	928317	1	11.0	60	1830	0	0	8166091	7578948	8210526
14	396724	3	8.0	70	1479	1479	1358	8564645	8210527	8842105
15	591021	1	9.0	93	1665	0	0	9159982	8842106	9473684
16	874676	2	7.0	66	1448	1334	0	10036323	9473685	10105263
17	459132	3	15.0	82	1149	1930	1414	10498237	10105264	10736842
18	479510	2	15.0	79	1244	1561	0	10982240	10736843	11368421
19	757872	1	17.0	73	1700	0	0	11742917	11368422	12000000

Total number of pulses in waveform = 42

Waveform Num = 3  
 Num of Bursts = 16  
 Burst Interval (us) = 750000.0

New3RandParmBin5.txt

Burst #	Off Time (us)	# Pulses	Chirp (MHz)	PW (us)	Pulse 1 Pri(us)	Pulse 2 Pri(us)	Pulse 3 Pri(us)	Start Loc (us)	Start Burst Interval(us)	End Burst Interval(us)
1	51833	1	5.0	93	1660	0	0	51833	0	749999
2	1393298	3	7.0	95	1575	1781	1513	1446791	750000	1499999
3	507424	3	19.0	69	1716	1300	1322	1959084	1500000	2249999
4	474211	1	11.0	60	1292	0	0	2437633	2250000	2999999
5	843636	1	17.0	63	1029	0	0	3282561	3000000	3749999
6	847104	2	5.0	52	1276	1001	0	4130694	3750000	4499999
7	393868	3	15.0	97	1745	1450	1912	4526839	4500000	5249999
8	1013778	3	14.0	53	1044	1804	1827	5545724	5250000	5999999
9	1151842	1	7.0	54	1636	0	0	6702241	6000000	6749999
10	739055	1	10.0	99	1030	0	0	7442932	6750000	7499999
11	404701	1	12.0	90	1479	0	0	7848663	7500000	8249999
12	939713	2	8.0	59	1804	1675	0	8789855	8250000	8999999
13	519222	3	5.0	72	1071	1949	1726	9312556	9000000	9749999
14	479244	1	6.0	78	1595	0	0	9796546	9750000	10499999
15	1433924	2	12.0	68	1540	1533	0	11232065	10500000	11249999
16	594518	3	19.0	81	1210	1817	1723	11829656	11250000	11999999

Total number of pulses in waveform = 31

Waveform Num = 4  
 Num of Bursts = 18  
 Burst Interval (us) = 666667.0

Burst #	Off Time (us)	# Pulses	Chirp (MHz)	PW (us)	Pulse 1 Pri(us)	Pulse 2 Pri(us)	Pulse 3 Pri(us)	Start Loc (us)	Start Burst Interval(us)	End Burst Interval(us)
1	518400	3	15.0	84	1107	1462	1823	518400	0	666666
2	485873	3	17.0	79	1056	1554	1895	1008665	666667	1333333
3	525685	2	17.0	87	1702	1165	0	1538855	1333334	2000000

New3RandParmBin5.txt

4	984561	1	6.0	97	1567	0	0	2526283	2000001	2666667
5	570640	3	18.0	87	1332	1234	1029	3098490	2666668	3333334
6	755319	2	12.0	97	1558	1269	0	3857404	3333335	4000001
7	159863	2	20.0	68	1561	1398	0	4020094	4000002	4666668
8	711917	2	12.0	78	1811	1222	0	4734970	4666669	5333335
9	859154	3	13.0	73	1911	1785	1547	5597157	5333336	6000002
10	442641	1	17.0	64	1616	0	0	6045041	6000003	6666669
11	969110	3	18.0	69	1495	1532	1323	7015767	6666670	7333336
12	788801	3	19.0	84	1428	1623	1550	7808918	7333337	8000003
13	404504	2	15.0	92	1123	1014	0	8218023	8000004	8666670
14	939769	2	12.0	70	1976	1834	0	9159929	8666671	9333337
15	522648	1	7.0	79	1804	0	0	9686387	9333338	10000004
16	629264	3	11.0	79	1334	1090	1827	10317455	10000005	10666671
17	589912	3	9.0	56	1353	1748	1301	10911618	10666672	11333338
18	1047146	2	15.0	61	1946	1044	0	11963166	11333339	12000005

Total number of pulses in waveform = 41

Waveform Num = 5  
 Num of Bursts = 18  
 Burst Interval (us) = 666667.0

Burst #	Off Time (us)	# Pulses	Chirp (MHz)	PW (us)	Pulse 1 Pri(us)	Pulse 2 Pri(us)	Pulse 3 Pri(us)	Start Loc (us)	Start Burst Interval(us)	End Burst Interval(us)
1	571034	2	6.0	78	1799	1685	0	571034	0	666666
2	667971	1	16.0	53	1640	0	0	1242489	666667	1333333
3	96498	3	7.0	69	1411	1458	1359	1340627	1333334	2000000
4	734818	3	12.0	80	1827	1554	1315	2079673	2000001	2666667
5	759739	1	12.0	80	1471	0	0	2844108	2666668	3333334

New3RandParmBin5.txt

6	817251	2	14.0	95	1924	1666	0	3662830	3333335	4000001
7	395395	2	15.0	71	1657	1589	0	4061815	4000002	4666668
8	1095869	3	7.0	83	1978	1814	1570	5160930	4666669	5333335
9	662120	1	5.0	85	1315	0	0	5828412	5333336	6000002
10	244698	1	18.0	66	1817	0	0	6074425	6000003	6666669
11	1089593	2	5.0	51	1607	1082	0	7165835	6666670	7333336
12	547032	1	9.0	55	1260	0	0	7715556	7333337	8000003
13	705845	3	10.0	61	1312	1872	1290	8422661	8000004	8666670
14	458317	1	18.0	94	1526	0	0	8885452	8666671	9333337
15	988167	3	17.0	65	1300	1699	1373	9875145	9333338	10000004
16	495929	1	13.0	95	1379	0	0	10375446	10000005	10666671
17	479399	3	16.0	78	1385	1770	1422	10856224	10666672	11333338
18	521409	2	11.0	59	1425	1047	0	11382210	11333339	12000005

Total number of pulses in waveform = 35

□  
 Waveform Num = 6  
 Num of Bursts = 16  
 Burst Interval (us) = 750000.0

Burst #	Off Time (us)	# Pulses	Chirp (MHz)	PW (us)	Pulse 1 Pri(us)	Pulse 2 Pri(us)	Pulse 3 Pri(us)	Start Loc (us)	Start Burst Interval(us)	End Burst Interval(us)
1	214868	2	19.0	94	1841	1680	0	214868	0	749999
2	874077	3	14.0	78	1175	1207	1394	1092466	750000	1499999
3	606762	3	7.0	99	1286	1561	1638	1703004	1500000	2249999
4	1279766	2	15.0	100	1074	1359	0	2987255	2250000	2999999
5	361899	2	13.0	94	1746	1579	0	3351587	3000000	3749999
6	1073652	3	20.0	62	1215	1088	1463	4428564	3750000	4499999
7	489839	1	8.0	85	1028	0	0	4922169	4500000	5249999

New3RandParmBin5.txt

8	437537	1	7.0	51	1641	0	0	5360734	5250000	5999999
9	655029	3	13.0	96	1712	1408	1327	6017404	6000000	6749999
10	826049	2	7.0	83	1794	1343	0	6847900	6750000	7499999
11	1312143	2	20.0	56	1606	1244	0	8163180	7500000	8249999
12	484874	3	8.0	80	1668	1230	1250	8650904	8250000	8999999
13	1011127	3	17.0	92	1433	1304	1068	9666179	9000000	9749999
14	354967	3	8.0	85	1636	1504	1331	10024951	9750000	10499999
15	1079023	1	12.0	61	1311	0	0	11108445	10500000	11249999
16	179325	2	17.0	80	1520	1427	0	11289081	11250000	11999999

Total number of pulses in waveform = 36

Waveform Num = 7  
 Num of Bursts = 10  
 Burst Interval (us) = 1200000.0

Burst #	Off Time (us)	# Pulses	Chirp (MHz)	PW (us)	Pulse 1 Pri(us)	Pulse 2 Pri(us)	Pulse 3 Pri(us)	Start Loc (us)	Start Burst Interval(us)	End Burst Interval(us)
1	1052287	3	17.0	84	1274	1192	1404	1052287	0	1199999
2	1068465	1	8.0	61	1089	0	0	2124622	1200000	2399999
3	562205	3	13.0	68	1004	1668	1473	2687916	2400000	3599999
4	1531279	1	11.0	68	1488	0	0	4223340	3600000	4799999
5	1574862	2	16.0	52	1399	1792	0	5799690	4800000	5999999
6	386002	3	8.0	97	1551	1410	1840	6188883	6000000	7199999
7	1919924	2	11.0	65	1326	1264	0	8113608	7200000	8399999
8	1171730	2	18.0	88	1502	1175	0	9287928	8400000	9599999
9	757853	1	16.0	60	1634	0	0	10048458	9600000	10799999
10	1150902	2	16.0	52	1962	1733	0	11200994	10800000	11999999

Total number of pulses in waveform = 20

New3RandParmBin5.txt

Waveform Num = 8  
 Num of Bursts = 14  
 Burst Interval (us) = 857143.0

Burst #	Off Time (us)	# Pulses	Chirp (MHz)	PW (us)	Pulse 1 Pri (us)	Pulse 2 Pri (us)	Pulse 3 Pri (us)	Start Loc (us)	Start Burst Interval (us)	End Burst Interval (us)
1	464313	2	20.0	97	1288	1904	0	464313	0	857142
2	1177217	1	13.0	53	1038	0	0	1644722	857143	1714285
3	320273	2	8.0	82	1179	1203	0	1966033	1714286	2571428
4	868274	3	10.0	65	1677	1743	1869	2836689	2571429	3428571
5	1265937	3	12.0	63	1268	1339	1987	4107915	3428572	4285714
6	834754	3	19.0	69	1517	1470	1839	4947263	4285715	5142857
7	880573	1	7.0	77	1994	0	0	5832662	5142858	6000000
8	167922	2	18.0	50	1289	1674	0	6002578	6000001	6857143
9	1100569	1	14.0	93	1243	0	0	7106110	6857144	7714286
10	1060010	2	16.0	90	1039	1503	0	8167363	7714287	8571429
11	816079	2	11.0	63	1036	1450	0	8985984	8571430	9428572
12	565716	2	12.0	59	1255	1424	0	9554186	9428573	10285715
13	1257952	2	13.0	81	1027	1347	0	10814817	10285716	11142858
14	589667	2	6.0	93	1663	1553	0	11406858	11142859	12000001

Total number of pulses in waveform = 28

Waveform Num = 9  
 Num of Bursts = 18  
 Burst Interval (us) = 666667.0

Burst #	Off Time (us)	# Pulses	Chirp (MHz)	PW (us)	Pulse 1 Pri (us)	Pulse 2 Pri (us)	Pulse 3 Pri (us)	Start Loc (us)	Start Burst Interval (us)	End Burst Interval (us)
1	194966	1	17.0	65	1053	0	0	194966	0	666666
2	640036	3	17.0	72	1330	1155	1081	836055	666667	1333333
3	746785	3	14.0	94	1148	1988	1788	1586406	1333334	2000000

New3RandParmBin5.txt

4	568481	2	20.0	53	1434	1555	0	2159811	2000001	2666667
5	640607	2	8.0	93	1073	1326	0	2803407	2666668	3333334
6	991388	2	5.0	96	1088	1044	0	3797194	3333335	4000001
7	820792	1	13.0	67	1937	0	0	4620118	4000002	4666668
8	398469	1	8.0	70	1395	0	0	5020524	4666669	5333335
9	499935	2	13.0	79	1376	1193	0	5521854	5333336	6000002
10	962490	2	6.0	52	1010	1051	0	6486913	6000003	6666669
11	215865	2	11.0	97	1497	1150	0	6704839	6666670	7333336
12	874137	2	18.0	69	1306	1607	0	7581623	7333337	8000003
13	654072	1	6.0	56	1654	0	0	8238608	8000004	8666670
14	493067	1	7.0	78	1137	0	0	8733329	8666671	9333337
15	605946	3	10.0	50	1021	1443	1793	9340412	9333338	10000004
16	1164858	1	20.0	69	1150	0	0	10509527	10000005	10666671
17	814033	1	16.0	97	1047	0	0	11324710	10666672	11333338
18	312601	3	13.0	70	1979	1017	1710	11638358	11333339	12000005

Total number of pulses in waveform = 33

□

Waveform Num = 10

Num of Bursts = 19

Burst Interval (us) = 631579.0

Burst #	Off Time (us)	# Pulses	Chirp (MHz)	PW (us)	Pulse 1 Pri(us)	Pulse 2 Pri(us)	Pulse 3 Pri(us)	Start Loc (us)	Start Burst Interval(us)	End Burst Interval(us)
1	447309	3	10.0	55	1541	1903	1672	447309	0	631578
2	494817	2	5.0	75	1674	1180	0	947242	631579	1263157
3	919155	3	19.0	92	1062	1848	1786	1869251	1263158	1894736
4	476359	1	6.0	83	1132	0	0	2350306	1894737	2526315
5	384214	2	10.0	79	1603	1776	0	2735652	2526316	3157894



New3RandParmBin5.txt

6	542874	1	7.0	59	1414	0	0	3281905	3157895	3789473
7	1043809	1	17.0	60	1290	0	0	4327128	3789474	4421052
8	646801	2	17.0	53	1348	1143	0	4975219	4421053	5052631
9	501810	1	5.0	62	1952	0	0	5479520	5052632	5684210
10	653875	1	11.0	95	1366	0	0	6135347	5684211	6315789
11	695240	2	9.0	85	1860	1519	0	6831953	6315790	6947368
12	185257	3	13.0	67	1451	1560	1949	7020589	6947369	7578947
13	1066394	2	16.0	86	1348	1527	0	8091943	7578948	8210526
14	244022	1	11.0	63	1166	0	0	8338840	8210527	8842105
15	884105	2	13.0	54	1577	1509	0	9224111	8842106	9473684
16	800312	3	13.0	77	1934	1452	1719	10027509	9473685	10105263
17	298543	2	9.0	100	1826	1155	0	10331157	10105264	10736842
18	570167	1	15.0	82	1947	0	0	10904305	10736843	11368421
19	477835	2	7.0	58	1395	1634	0	11384087	11368422	12000000

Total number of pulses in waveform = 35

□

Waveform Num = 11

Num of Bursts = 19

Burst Interval (us) = 631579.0

Burst #	Off Time (us)	# Pulses	Chirp (MHz)	PW (us)	Pulse 1 Pri (us)	Pulse 2 Pri (us)	Pulse 3 Pri (us)	Start Loc (us)	Start Burst Interval (us)	End Burst Interval (us)
1	389007	2	8.0	97	1351	1685	0	389007	0	631578
2	625933	3	12.0	68	1604	1501	1819	1017976	631579	1263157
3	730007	1	14.0	59	1700	0	0	1752907	1263158	1894736
4	630368	3	20.0	50	1311	1391	1497	2384975	1894737	2526315
5	365855	2	8.0	82	1663	1677	0	2755029	2526316	3157894
6	769933	1	10.0	81	1017	0	0	3528302	3157895	3789473

New3RandParmBin5.txt

7	547505	2	11.0	71	1377	1815	0	4076824	3789474	4421052
8	384452	1	7.0	69	1039	0	0	4464468	4421053	5052631
9	1052997	2	16.0	50	1694	1757	0	5518504	5052632	5684210
10	745893	1	8.0	71	1304	0	0	6267848	5684211	6315789
11	362634	1	15.0	58	1570	0	0	6631786	6315790	6947368
12	929595	1	11.0	98	1753	0	0	7562951	6947369	7578947
13	70151	1	16.0	82	1377	0	0	7634855	7578948	8210526
14	818305	2	13.0	68	1437	1703	0	8454537	8210527	8842105
15	715169	3	16.0	78	1815	1539	1301	9172846	8842106	9473684
16	367233	1	8.0	69	1044	0	0	9544734	9473685	10105263
17	1103480	1	6.0	100	1841	0	0	10649258	10105264	10736842
18	414048	3	17.0	83	1060	1337	1037	11065147	10736843	11368421
19	774814	1	8.0	72	1731	0	0	11843395	11368422	12000000

Total number of pulses in waveform = 32

□  
 Waveform Num = 12  
 Num of Bursts = 10  
 Burst Interval (us) = 1200000.0

Burst #	Off Time (us)	# Pulses	Chirp (MHz)	PW (us)	Pulse 1 Pri(us)	Pulse 2 Pri(us)	Pulse 3 Pri(us)	Start Loc (us)	Start Burst Interval(us)	End Burst Interval(us)
1	1114617	2	6.0	95	1693	1682	0	1114617	0	1199999
2	453348	2	6.0	61	1434	1818	0	1571340	1200000	2399999
3	1448852	2	10.0	55	1698	1784	0	3023444	2400000	3599999
4	681478	2	5.0	74	1324	1682	0	3708404	3600000	4799999
5	2193187	3	9.0	89	1322	1576	1909	5904597	4800000	5999999
6	1274206	1	17.0	77	1897	0	0	7183610	6000000	7199999
7	542483	1	17.0	64	1656	0	0	7727990	7200000	8399999

New3RandParmBin5.txt

8	1129498	2	18.0	89	1224	1279	0	8859144	8400000	9599999
9	1750342	2	13.0	52	1258	1213	0	10611989	9600000	10799999
10	851102	3	16.0	98	1334	1775	1174	11465562	10800000	11999999

Total number of pulses in waveform = 20

□  
 Waveform Num = 13  
 Num of Bursts = 9  
 Burst Interval (us) = 1333333.0

Burst #	Off Time (us)	# Pulses	Chirp (MHz)	PW (us)	Pulse 1 Pri(us)	Pulse 2 Pri(us)	Pulse 3 Pri(us)	Start Loc (us)	Start Burst Interval(us)	End Burst Interval(us)
1	349351	3	13.0	56	1300	1295	1669	349351	0	1333332
2	1291178	3	14.0	93	1416	1559	1095	1644793	1333333	2666665
3	1928928	2	12.0	98	1832	1292	0	3577791	2666666	3999998
4	1432764	1	17.0	80	1059	0	0	5013679	3999999	5333331
5	980180	3	11.0	78	1282	1858	1207	5994918	5333332	6666664
6	1208273	2	8.0	66	1165	1254	0	7207538	6666665	7999997
7	1558414	1	14.0	58	1192	0	0	8768371	7999998	9333330
8	1884807	1	19.0	76	1715	0	0	10654370	9333331	10666663
9	257888	3	9.0	68	1744	1609	1804	10913973	10666664	11999996

Total number of pulses in waveform = 19

□  
 Waveform Num = 14  
 Num of Bursts = 10  
 Burst Interval (us) = 1200000.0

Burst #	Off Time (us)	# Pulses	Chirp (MHz)	PW (us)	Pulse 1 Pri(us)	Pulse 2 Pri(us)	Pulse 3 Pri(us)	Start Loc (us)	Start Burst Interval(us)	End Burst Interval(us)
1	472551	1	15.0	60	1400	0	0	472551	0	1199999
2	1077933	2	7.0	74	1232	1338	0	1551884	1200000	2399999
3	1219545	3	5.0	92	1920	1861	1680	2773999	2400000	3599999
4	1193508	2	14.0	86	1052	1577	0	3972968	3600000	4799999

New3RandParmBin5.txt

5	1040545	1	19.0	95	1260	0	0	5016142	4800000	5999999
6	2159965	1	15.0	58	1558	0	0	7177367	6000000	7199999
7	1083105	1	7.0	96	1065	0	0	8262030	7200000	8399999
8	1293342	2	9.0	63	1370	1477	0	9556437	8400000	9599999
9	639870	1	13.0	71	1566	0	0	10199154	9600000	10799999
10	1594917	1	12.0	95	1989	0	0	11795637	10800000	11999999

Total number of pulses in waveform = 15

Waveform Num = 15  
 Num of Bursts = 11  
 Burst Interval (us) = 1090909.0

Burst #	Off Time (us)	# Pulses	Chirp (MHz)	PW (us)	Pulse 1 Pri(us)	Pulse 2 Pri(us)	Pulse 3 Pri(us)	Start Loc (us)	Start Burst Interval(us)	End Burst Interval(us)
1	792228	3	19.0	64	1489	1992	1751	792228	0	1090908
2	528604	3	16.0	51	1932	1574	1280	1326064	1090909	2181817
3	1207468	3	19.0	61	1212	1664	1196	2538318	2181818	3272726
4	1631635	2	9.0	51	1701	1454	0	4174025	3272727	4363635
5	638728	1	18.0	100	1265	0	0	4815908	4363636	5454544
6	1379944	1	13.0	93	1484	0	0	6197117	5454545	6545453
7	598590	3	18.0	91	1758	1912	1929	6797191	6545454	7636362
8	1886237	1	9.0	72	1823	0	0	8689027	7636363	8727271
9	564805	2	20.0	74	1233	1073	0	9255655	8727272	9818180
10	1238752	2	9.0	85	1600	1325	0	10496713	9818181	10909089
11	1147860	3	11.0	98	1444	1285	1841	11647498	10909090	11999998

Total number of pulses in waveform = 24

Waveform Num = 16  
 Num of Bursts = 14  
 Burst Interval (us) = 857143.0

New3RandParmBin5.txt

Burst #	Off Time (us)	# Pulses	Chirp (MHz)	PW (us)	Pulse 1 Pri(us)	Pulse 2 Pri(us)	Pulse 3 Pri(us)	Start Loc (us)	Start Burst Interval(us)	End Burst Interval(us)
1	449590	2	20.0	60	1939	1941	0	449590	0	857142
2	978197	3	18.0	96	1488	1794	1743	1431667	857143	1714285
3	525557	1	18.0	96	1517	0	0	1962249	1714286	2571428
4	1005232	1	5.0	57	1804	0	0	2968998	2571429	3428571
5	641512	1	10.0	62	1012	0	0	3612314	3428572	4285714
6	1249089	2	6.0	97	1957	1260	0	4862415	4285715	5142857
7	524678	2	13.0	85	1675	1320	0	5390310	5142858	6000000
8	1243150	2	11.0	79	1668	1142	0	6636455	6000001	6857143
9	393836	1	12.0	62	1481	0	0	7033101	6857144	7714286
10	724071	1	11.0	64	1558	0	0	7758653	7714287	8571429
11	1227402	1	6.0	84	1826	0	0	8987613	8571430	9428572
12	717459	2	17.0	62	1849	1948	0	9706898	9428573	10285715
13	1036303	2	17.0	62	1870	1639	0	10746998	10285716	11142858
14	509383	3	8.0	51	1302	1552	1221	11259890	11142859	12000001

Total number of pulses in waveform = 24

Waveform Num = 17  
 Num of Bursts = 13  
 Burst Interval (us) = 923077.0

Burst #	Off Time (us)	# Pulses	Chirp (MHz)	PW (us)	Pulse 1 Pri(us)	Pulse 2 Pri(us)	Pulse 3 Pri(us)	Start Loc (us)	Start Burst Interval(us)	End Burst Interval(us)
1	230124	2	19.0	92	1909	1002	0	230124	0	923076
2	1086788	2	9.0	52	1741	1264	0	1319823	923077	1846153
3	653401	1	10.0	92	1373	0	0	1976229	1846154	2769230
4	1353456	3	15.0	87	1633	1988	1029	3331058	2769231	3692307
5	594359	1	6.0	91	1753	0	0	3930067	3692308	4615384

New3RandParmBin5.txt

6	1313866	2	7.0	77	1510	1406	0	5245686	4615385	5538461
7	427470	2	5.0	76	1416	1817	0	5676072	5538462	6461538
8	1450827	3	16.0	76	1535	1276	1586	7130132	6461539	7384615
9	324634	1	14.0	95	1718	0	0	7459163	7384616	8307692
10	1145638	1	14.0	58	1051	0	0	8606519	8307693	9230769
11	951216	3	7.0	91	1031	1384	1517	9558786	9230770	10153846
12	771915	3	6.0	52	1123	1577	1307	10334633	10153847	11076923
13	1245042	1	12.0	87	1733	0	0	11583682	11076924	12000000

Total number of pulses in waveform = 25

Waveform Num = 18  
 Num of Bursts = 9  
 Burst Interval (us) = 1333333.0

Burst #	Off Time (us)	# Pulses	Chirp (MHz)	PW (us)	Pulse 1 Pri (us)	Pulse 2 Pri (us)	Pulse 3 Pri (us)	Start Loc (us)	Start Burst Interval (us)	End Burst Interval (us)
1	199264	2	14.0	96	1619	1174	0	199264	0	1333332
2	2424008	1	10.0	74	1972	0	0	2626065	1333333	2666665
3	103657	3	13.0	69	1945	1806	1241	2731694	2666666	3999998
4	1681265	2	13.0	56	1846	1534	0	4417951	3999999	5333331
5	1189786	1	15.0	98	1267	0	0	5611117	5333332	6666664
6	1792657	1	13.0	81	1005	0	0	7405041	6666665	7999997
7	1782933	1	19.0	56	1519	0	0	9188979	7999998	9333330
8	275537	3	13.0	67	1934	1250	1680	9466035	9333331	10666663
9	2314488	2	16.0	96	1109	1821	0	11785387	10666664	11999996

Total number of pulses in waveform = 16

Waveform Num = 19  
 Num of Bursts = 10  
 Burst Interval (us) = 1200000.0

New3RandParmBin5.txt

Burst #	Off Time (us)	# Pulses	Chirp (MHZ)	PW (us)	Pulse 1 Pri(us)	Pulse 2 Pri(us)	Pulse 3 Pri(us)	Start Loc (us)	Start Burst Interval(us)	End Burst Interval(us)
1	1047638	3	10.0	64	1867	1807	1617	1047638	0	1199999
2	487759	1	19.0	90	1495	0	0	1540688	1200000	2399999
3	1547094	3	13.0	97	1398	1894	1162	3089277	2400000	3599999
4	1099511	1	10.0	86	1516	0	0	4193242	3600000	4799999
5	774358	1	8.0	63	1941	0	0	4969116	4800000	5999999
6	1340528	2	7.0	96	1981	1542	0	6311585	6000000	7199999
7	1418251	2	10.0	91	1805	1151	0	7733359	7200000	8399999
8	894235	1	20.0	96	1679	0	0	8630550	8400000	9599999
9	1678594	1	6.0	97	1433	0	0	10310823	9600000	10799999
10	1243115	1	8.0	85	1834	0	0	11555371	10800000	11999999

Total number of pulses in waveform = 16

Waveform Num = 20  
 Num of Bursts = 20  
 Burst Interval (us) = 600000.0

Burst #	Off Time (us)	# Pulses	Chirp (MHZ)	PW (us)	Pulse 1 Pri(us)	Pulse 2 Pri(us)	Pulse 3 Pri(us)	Start Loc (us)	Start Burst Interval(us)	End Burst Interval(us)
1	565617	3	17.0	73	1895	1509	1012	565617	0	599999
2	127664	1	6.0	98	1170	0	0	697697	600000	1199999
3	737198	1	5.0	92	1355	0	0	1436065	1200000	1799999
4	418088	2	6.0	96	1800	1607	0	1855508	1800000	2399999
5	758119	1	11.0	64	1477	0	0	2617034	2400000	2999999
6	881986	3	16.0	67	1092	1758	1916	3500497	3000000	3599999
7	252990	1	12.0	60	1038	0	0	3758253	3600000	4199999
8	878019	3	20.0	50	1923	1738	1765	4637310	4200000	4799999
9	355581	3	13.0	54	1528	1015	1081	4998317	4800000	5399999

New3RandParmBin5.txt

10	863401	3	6.0	52	1325	1897	1100	5865342	5400000	5999999
11	410378	1	15.0	89	1954	0	0	6280042	6000000	6599999
12	378439	1	16.0	64	1439	0	0	6660435	6600000	7199999
13	940452	3	5.0	69	1154	1970	1699	7602326	7200000	7799999
14	769484	1	9.0	84	1856	0	0	8376633	7800000	8399999
15	518019	2	16.0	75	1048	1614	0	8896508	8400000	8999999
16	233390	3	14.0	81	1257	1866	1467	9132560	9000000	9599999
17	586542	1	16.0	100	1889	0	0	9723692	9600000	10199999
18	623938	3	14.0	99	1993	1381	1594	10349519	10200000	10799999
19	1027453	3	19.0	51	1067	1714	1983	11381940	10800000	11399999
20	377701	1	7.0	100	1404	0	0	11764405	11400000	11999999

Total number of pulses in waveform = 40

Waveform Num = 21  
 Num of Bursts = 8  
 Burst Interval (us) = 1500000.0

Burst #	Off Time (us)	# Pulses	Chirp (MHz)	PW (us)	Pulse 1 Pri (us)	Pulse 2 Pri (us)	Pulse 3 Pri (us)	Start Loc (us)	Start Burst Interval (us)	End Burst Interval (us)
1	186792	1	19.0	94	1019	0	0	186792	0	1499999
2	2218436	1	13.0	87	1571	0	0	2406247	1500000	2999999
3	666240	3	17.0	57	1514	1030	1276	3074058	3000000	4499999
4	2742795	1	9.0	99	1712	0	0	5820673	4500000	5999999
5	548886	3	19.0	80	1593	1961	1428	6371271	6000000	7499999
6	2402949	1	10.0	91	1520	0	0	8779202	7500000	8999999
7	740278	1	6.0	62	1043	0	0	9521000	9000000	10499999
8	2337052	1	9.0	69	1512	0	0	11859095	10500000	11999999

Total number of pulses in waveform = 12



New3RandParmBin5.txt

Waveform Num = 22  
 Num of Bursts = 16  
 Burst Interval (us) = 750000.0

Burst #	Off Time (us)	# Pulses	Chirp (MHz)	PW (us)	Pulse 1 Pri(us)	Pulse 2 Pri(us)	Pulse 3 Pri(us)	Start Loc (us)	Start Burst Interval(us)	End Burst Interval(us)
1	235408	1	10.0	56	1945	0	0	235408	0	749999
2	1042651	1	12.0	83	1443	0	0	1280004	750000	1499999
3	630913	2	7.0	92	1560	1665	0	1912360	1500000	2249999
4	451973	1	8.0	54	1613	0	0	2367558	2250000	2999999
5	1318725	2	6.0	92	1033	1634	0	3687896	3000000	3749999
6	191797	3	13.0	94	1650	1126	1891	3882360	3750000	4499999
7	834107	3	7.0	72	1135	1935	1537	4721134	4500000	5249999
8	614594	1	20.0	93	1728	0	0	5340335	5250000	5999999
9	1142023	3	5.0	51	1040	1221	1666	6484086	6000000	6749999
10	902326	2	13.0	53	1734	1986	0	7390339	6750000	7499999
11	418819	1	14.0	77	1624	0	0	7812878	7500000	8249999
12	698500	1	14.0	55	1716	0	0	8513002	8250000	8999999
13	1131665	2	16.0	66	1988	1640	0	9646383	9000000	9749999
14	121755	1	12.0	67	1498	0	0	9771766	9750000	10499999
15	1275806	3	6.0	98	1509	1169	1839	11049070	10500000	11249999
16	770125	1	13.0	81	1093	0	0	11823712	11250000	11999999

Total number of pulses in waveform = 28

□  
 Waveform Num = 23  
 Num of Bursts = 12  
 Burst Interval (us) = 1000000.0

Burst #	Off Time (us)	# Pulses	Chirp (MHz)	PW (us)	Pulse 1 Pri(us)	Pulse 2 Pri(us)	Pulse 3 Pri(us)	Start Loc (us)	Start Burst Interval(us)	End Burst Interval(us)
1	379723	2	20.0	71	1218	1122	0	379723	0	999999

New3RandParmBin5.txt

2	1241395	2	11.0	98	1857	1081	0	1623458	1000000	1999999
3	1251292	3	18.0	73	1072	1476	1649	2877688	2000000	2999999
4	491017	3	13.0	74	1129	1417	1318	3372902	3000000	3999999
5	957281	1	7.0	71	1251	0	0	4334047	4000000	4999999
6	1404240	1	11.0	76	1901	0	0	5739538	5000000	5999999
7	743364	3	12.0	72	1578	1432	1045	6484803	6000000	6999999
8	1288409	1	15.0	61	1461	0	0	7777267	7000000	7999999
9	273191	1	6.0	53	1105	0	0	8051919	8000000	8999999
10	1203185	3	8.0	89	1062	1525	1964	9256209	9000000	9999999
11	1365993	1	7.0	72	1937	0	0	10626753	10000000	10999999
12	1286340	3	16.0	61	1810	1400	1616	11915030	11000000	11999999

Total number of pulses in waveform = 24

Waveform Num = 24  
 Num of Bursts = 10  
 Burst Interval (us) = 1200000.0

Burst #	Off Time (us)	# Pulses	Chirp (MHz)	PW (us)	Pulse 1 Pri (us)	Pulse 2 Pri (us)	Pulse 3 Pri (us)	Start Loc (us)	Start Burst Interval (us)	End Burst Interval (us)
1	229635	3	18.0	67	1831	1465	1491	229635	0	1199999
2	1365641	1	10.0	58	1740	0	0	1600063	1200000	2399999
3	1111534	3	8.0	50	1310	1952	1548	2713337	2400000	3599999
4	1021998	2	20.0	52	1660	1909	0	3740145	3600000	4799999
5	1967306	1	15.0	85	1239	0	0	5711020	4800000	5999999
6	1262379	3	7.0	62	1989	1801	1630	6974638	6000000	7199999
7	649102	2	10.0	97	1521	1519	0	7629160	7200000	8399999
8	1400328	2	8.0	85	1184	1007	0	9032528	8400000	9599999
9	681800	3	9.0	92	1530	1902	1622	9716519	9600000	10799999

New3RandParmBin5.txt

10 1989945 3 20.0 82 1917 1538 1742 11711518 10800000 11999999  
 Total number of pulses in waveform = 23  
 □  
 Waveform Num = 25  
 Num of Bursts = 20  
 Burst Interval (us) = 600000.0

Burst #	Off Time (us)	# Pulses	Chirp (MHz)	PW (us)	Pulse 1 Pri(us)	Pulse 2 Pri(us)	Pulse 3 Pri(us)	Start Loc (us)	Start Burst Interval(us)	End Burst Interval(us)
1	53706	1	10.0	58	1208	0	0	53706	0	599999
2	929374	2	14.0	94	1331	1543	0	984288	600000	1199999
3	692371	3	18.0	55	1642	1294	1348	1679533	1200000	1799999
4	556446	2	16.0	76	1799	1723	0	2240263	1800000	2399999
5	382814	3	10.0	52	1248	1661	1439	2626599	2400000	2999999
6	673373	3	12.0	59	1229	1914	1081	3304320	3000000	3599999
7	882893	1	19.0	88	1993	0	0	4191437	3600000	4199999
8	524323	3	13.0	84	1495	1646	1378	4717753	4200000	4799999
9	431814	1	14.0	63	1713	0	0	5154086	4800000	5399999
10	372214	2	12.0	66	1266	1629	0	5528013	5400000	5999999
11	844701	3	18.0	91	1886	1290	1051	6375609	6000000	6599999
12	432627	2	11.0	88	1054	1311	0	6812463	6600000	7199999
13	445784	3	10.0	76	1144	1135	1487	7260612	7200000	7799999
14	613831	3	10.0	84	1081	1677	1696	7878209	7800000	8399999
15	952288	1	16.0	96	1518	0	0	8834951	8400000	8999999
16	526064	2	10.0	50	1766	1986	0	9362533	9000000	9599999
17	636416	2	18.0	100	1128	1579	0	10002701	9600000	10199999
18	575769	3	14.0	88	1717	1516	1128	10581177	10200000	10799999
19	324074	3	6.0	50	1670	1977	1923	10909612	10800000	11399999

New3RandParmBin5.txt

494309  
 20 1 19.0 67 1232 0 0 11409491 11400000 11999999  
 Total number of pulses in waveform = 44

□  
 Waveform Num = 26  
 Num of Bursts = 15  
 Burst Interval (us) = 800000.0

Burst #	Off Time (us)	# Pulses	Chirp (MHZ)	PW (us)	Pulse 1 Pri(us)	Pulse 2 Pri(us)	Pulse 3 Pri(us)	Start Loc (us)	Start Burst Interval(us)	End Burst Interval(us)
1	628717	1	9.0	53	1929	0	0	628717	0	799999
2	524807	1	18.0	72	1417	0	0	1155453	800000	1599999
3	527586	1	8.0	51	1727	0	0	1684456	1600000	2399999
4	780206	2	17.0	73	1634	1354	0	2466389	2400000	3199999
5	1406898	1	7.0	94	1612	0	0	3876275	3200000	3999999
6	781003	1	20.0	66	1432	0	0	4658890	4000000	4799999
7	560932	2	13.0	70	1911	1833	0	5221254	4800000	5599999
8	562203	1	16.0	85	1895	0	0	5787201	5600000	6399999
9	925440	2	14.0	70	1633	1481	0	6714536	6400000	7199999
10	878299	3	7.0	55	1810	1179	1057	7595949	7200000	7999999
11	412170	2	8.0	53	1842	1722	0	8012165	8000000	8799999
12	1552722	2	15.0	55	1967	1036	0	9568451	8800000	9599999
13	47101	3	13.0	54	1692	1057	1136	9618555	9600000	10399999
14	1211934	1	14.0	100	1785	0	0	10834374	10400000	11199999
15	876629	1	20.0	91	1398	0	0	11712788	11200000	11999999

Total number of pulses in waveform = 24  
 □  
 Waveform Num = 27  
 Num of Bursts = 10  
 Burst Interval (us) = 1200000.0

Burst #	Off Time (us)	# Pulses	Chirp (MHZ)	PW (us)	Pulse 1 Pri(us)	Pulse 2 Pri(us)	Pulse 3 Pri(us)	Start Loc (us)	Start Burst Interval(us)	End Burst Interval(us)
---------	---------------	----------	-------------	---------	-----------------	-----------------	-----------------	----------------	--------------------------	------------------------

New3RandParmBin5.txt

1	845530	2	16.0	90	1252	1267	0	845530	0	1199999
2	456017	2	18.0	59	1770	1030	0	1304066	1200000	2399999
3	2218467	3	17.0	68	1464	1177	1413	3525333	2400000	3599999
4	847097	3	8.0	59	1158	1237	1450	4376484	3600000	4799999
5	1239886	1	13.0	81	1807	0	0	5620215	4800000	5999999
6	1225003	2	9.0	86	1360	1013	0	6847025	6000000	7199999
7	781943	3	6.0	57	1121	1309	1310	7631341	7200000	8399999
8	1796429	1	19.0	96	1743	0	0	9431510	8400000	9599999
9	1090657	2	18.0	89	1327	1150	0	10523910	9600000	10799999
10	303728	2	12.0	75	1034	1472	0	10830115	10800000	11999999

Total number of pulses in waveform = 21

□  
 Waveform Num = 28  
 Num of Bursts = 8  
 Burst Interval (us) = 1500000.0

Burst #	Off Time (us)	# Pulses	Chirp (MHz)	PW (us)	Pulse 1 Pri(us)	Pulse 2 Pri(us)	Pulse 3 Pri(us)	Start Loc (us)	Start Burst Interval(us)	End Burst Interval(us)
1	38087	3	6.0	76	1114	1368	1729	38087	0	1499999
2	1601341	2	15.0	67	1464	1526	0	1643639	1500000	2999999
3	2182785	3	10.0	57	1435	1099	1505	3829414	3000000	4499999
4	1671926	1	14.0	97	1339	0	0	5505379	4500000	5999999
5	1306121	3	12.0	66	1478	1248	1640	6812839	6000000	7499999
6	822283	2	19.0	53	1981	1340	0	7639488	7500000	8999999
7	2295651	3	7.0	79	1955	1906	1209	9938460	9000000	10499999
8	1334281	1	8.0	88	1500	0	0	11277811	10500000	11999999

Total number of pulses in waveform = 18

□  
 Waveform Num = 29  
 Num of Bursts = 14

New3RandParmBin5.txt

Burst Interval (us) = 857143.0

Burst #	Off Time (us)	# Pulses	Chirp (MHz)	PW (us)	Pulse 1 Pri(us)	Pulse 2 Pri(us)	Pulse 3 Pri(us)	Start Loc (us)	Start Burst Interval(us)	End Burst Interval(us)
1	236032	2	8.0	70	1192	1612	0	236032	0	857142
2	1063001	2	9.0	78	1867	1483	0	1301837	857143	1714285
3	574252	1	8.0	83	1061	0	0	1879439	1714286	2571428
4	939282	2	19.0	68	1409	1295	0	2819782	2571429	3428571
5	1063268	1	16.0	99	1076	0	0	3885754	3428572	4285714
6	425044	2	6.0	91	1432	1028	0	4311874	4285715	5142857
7	1158870	2	12.0	59	1233	1497	0	5473204	5142858	6000000
8	1343246	3	18.0	95	1232	1513	1247	6819180	6000001	6857143
9	882166	3	15.0	96	1174	1595	1156	7705338	6857144	7714286
10	831738	3	8.0	72	1765	1247	1588	8541001	7714287	8571429
11	239364	1	15.0	92	1050	0	0	8784965	8571430	9428572
12	700285	1	9.0	100	1081	0	0	9486300	9428573	10285715
13	972880	2	19.0	98	1921	1812	0	10460261	10285716	11142858
14	729660	3	18.0	54	1384	1081	1792	11193654	11142859	12000001

Total number of pulses in waveform = 28

Waveform Num = 30

Num of Bursts = 19

Burst Interval (us) = 631579.0

Burst #	Off Time (us)	# Pulses	Chirp (MHz)	PW (us)	Pulse 1 Pri(us)	Pulse 2 Pri(us)	Pulse 3 Pri(us)	Start Loc (us)	Start Burst Interval(us)	End Burst Interval(us)
1	3901	2	13.0	57	1067	1117	0	3901	0	631578
2	897232	1	8.0	87	1612	0	0	903317	631579	1263157
3	432858	3	9.0	88	1757	1663	1197	1337787	1263158	1894736
4	814357	3	8.0	97	1753	1000	1555	2156761	1894737	2526315

New3RandParmBin5.txt

5	853749	2	14.0	58	1444	1729	0	3014818	2526316	3157894
6	222716	1	18.0	70	1896	0	0	3240707	3157895	3789473
7	843134	2	8.0	90	1721	1514	0	4085737	3789474	4421052
8	649531	1	18.0	93	1909	0	0	4738503	4421053	5052631
9	702120	1	8.0	60	1897	0	0	5442532	5052632	5684210
10	779287	2	16.0	52	1386	1655	0	6223716	5684211	6315789
11	236604	3	12.0	83	1317	1778	1600	6463361	6315790	6947368
12	794742	1	7.0	76	1470	0	0	7262798	6947369	7578947
13	849356	3	11.0	55	1659	1512	1932	8113624	7578948	8210526
14	696618	1	13.0	69	1639	0	0	8815345	8210527	8842105
15	250466	1	15.0	57	1626	0	0	9067450	8842106	9473684
16	621302	3	17.0	75	1752	1222	1694	9690378	9473685	10105263
17	997997	2	8.0	91	1061	1703	0	10693043	10105264	10736842
18	651027	1	18.0	53	1171	0	0	11346834	10736843	11368421
19	647219	3	9.0	75	1022	1930	1138	11995224	11368422	12000000

Total number of pulses in waveform = 36

□