



MEASUREMENT/TECHNICAL REPORT

FCC Part 15 Subpart C

Issued: July 1, 2009

Name and Address of the Applicant:	SHIMANO INC. 3-77 Oimatu-cho, Sakai-ku, Sakai City, Osaka 590-8577, Japan
Test Item:	Gear Sensor
Identification:	SM-SC79-R
Serial No.:	---
FCC ID:	WY704
Sample Receipt Date:	January 23, 2009
Test Specification:	FCC Part 15 Subpart C, 15.249
Date of Testing:	April 3, 6, 7 and 8, 2009
Test Result:	PASS

Report Prepared by:	Cosmos Corporation 2-3571 Ohnogi, Watarai-cho, Watarai-gun, Mie, Japan 516-2102 Phone: +81-596-63-0707 Fax: +81-596-63-0777
---------------------	---

Tested by:	<u>O. Itogawa</u>	<u>July 1, 2009</u>
	O. Itogawa, Engineer	Date
Reviewed by:	<u>Y. Kawahara</u>	<u>July 1, 2009</u>
	Y. Kawahara, Deputy General Manager	Date

Notes:

1. This report should not be reproduced except in full, without the written approval of Cosmos Corporation.
2. All measurement data contained in this report may have uncertainty. A judgment for the limitation should be taken into the count.
3. The report in this report apply only to the sample tested.

List of Contents	Page
1. Description of Equipment Under Test.....	3
1.1 Product Description.....	3
1.2 Antenna Description	3
1.3 Accompanied Peripherals Description	3
2. General Information	4
2.1 Test Methodology.....	4
2.2 Test Facility	4
2.3 Traceability	4
3. Summary of Test Results	4
4. Test Configuration.....	5
4.1 15. 249 (a) The field strength of emissions.....	5
4.2 Test Mode.....	5
5. Measurement Result	6
5.1 15. 249(a) The Field Strength of Emissions	6
5.1.1 Setting Remarks	6
5.1.2 Minimum Standard	7
5.1.3 Result.....	7
5.1.4 Measured Data.....	8
5.2 15. 247(d) Band Edge Measurement	26
5.2.1 Setting Remarks	26
5.2.2 Minimum Standard	26
5.2.3 Result.....	26
5.2.4 Measured Data.....	27
5.3 15. 215 (c) 20 dB Bandwidth	28
6. Photos	29
6.1 Setup Photo.....	29
7. List of Test Measurement Instruments	30
7.1 Radiated Emission Measurement.....	30

1. Description of Equipment Under Test

1.1 Product Description

Manufacturer : SHIMANO INC.
 Model (referred to as the EUT) : SM-SC79-R
 Nominal Voltage : DC 3V
 Type of Modulation : MSK
 Mode of Operation : duplex 1/2 duplex simplex other
 The type of the equipment : Stand-alone Combined Equipment
 Plug -In Card Other (Module Unit)
 The type of the antenna : Integral external Other
 The type of power source : AC mains Dedicated AC adapter (V)
 DC Voltage Battery
 The type of battery (if applicable) : N/A
 Type of Operation : Continuous Burst Intermittent
 Stand by Mode : Available N/A
 Intended functions : Gear sensor(Rear side)
 The bandwidth of the IF filters : N/A
 Method of Communication Link : Software to make gear data
 The operating frequency band : 2402.249481 to 2480.730327MH z
 The thermal limitation : Not specified

1.2 Antenna Description

No.	Type Name	Gain	Antenna Type	Remarks
1	2.4GHz chip antenna	Less than +1dBi	Helical antenna	The product by "TAIYO YUDEN"

1.3 Accompanied Peripherals Description

No.	Equipment Name	Manufacturer	Type Name	Serial Number	Remarks
1	PC	TOSHIBA	PSJ70N-1W401J	98100247H	DC15 V, ---, 5 A
2	AC Adapter	TOSHIBA	PA3283U-5ACA	---	AC100 V, 50/60 Hz, 1.5 A
3	Jig	---	---	---	DC3 V, ---, ---

2. General Information

2.1 Test Methodology

All measurement subject to the present report was carried out according to the procedures in ANSI C63.4: 2003.

2.2 Test Facility

All measurement was performed in the following facility;

Cosmos Corporation EMC Lab. Ohnogi

(2-3571 Ohaza-iwatachi, Ohnogi, Watarai-cho, Watarai-gun, Mie-ken 516-2102, Japan) The test firm has been filed since March 7, 2008 under CFR 47 Part.2.948.

2.3 Traceability

The calibration of measurement equipment used in the test subject to the present report is designed and operated to ensure that the measurement is traceable to national standards of measurement or equivalent abroad.

3. Summary of Test Results

Section	Test Item	Limit	Result
15. 215 (c)	20 dB Bandwidth	---	Pass
15. 247 (d)	Band Edge Measurement	See 5.2.2	Pass
15. 249 (a)	The Field Strength of Emissions	See 5.1.2	Pass

4. Test Configuration

	Instrument	Model		Cable	Length	Shield
A	EUT	SM-SC79-R	a	AC Power Cable	0.8 m	×
B	PC	PSJ70N-1W401J	b	DC Power Cable	1.5 m	×
C	AC Adapter	PA3283U-5ACA	c	RS232C Cable	3.0 m	○
D	Jig	---	d	DC Power Cable	3.2 m	×
			e	Signal Cable	4.0 m	×

4.1 15. 249 (a) The field strength of emissions

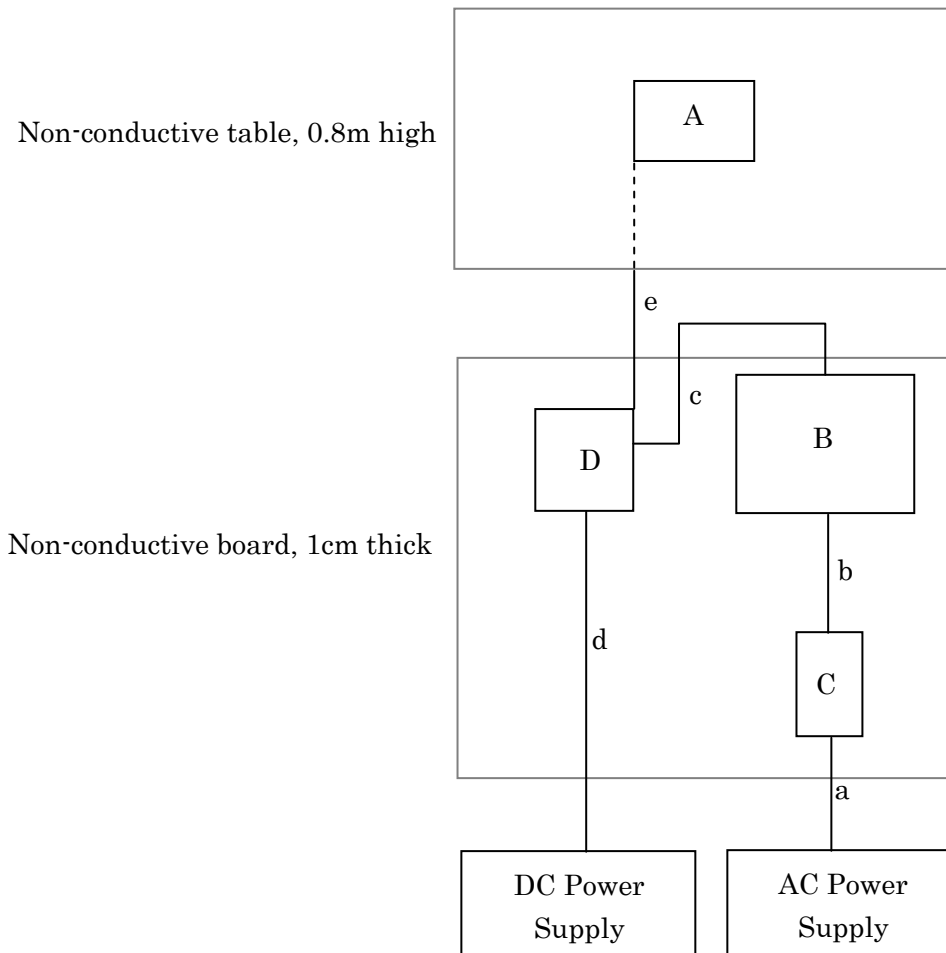
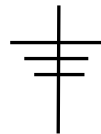

4.2 Test Mode

In test configurations above, EUT makes continuous RF transmitting with maximum power.

5. Measurement Result

5.1 15. 249(a) The Field Strength of Emissions

5.1.1 Setting Remarks

- The data lists in “5.1.4 Measured Data “ list the significant emission frequencies, measured levels, correction factor (includes cable and antenna corrections), the corrected reading, plus the limit.
- In the frequency range between 30MHz to 25 GHz (as 10th harmonics), the Electric Field Strength is measured in accordance with ANSI C63.4: 2003 and CISPR22: 1997.
- The test setup is made in accordance with ANSI C63.4: 2003.
- The antenna is measured at 1-4m height.
- The EUT is placed on the non-conductive table in the center of turntable. The height of this table is 0.8m.
- The distance between equipment and antenna is 3 m.
- The measurement is carried out with both horizontal and vertical antenna polarization.
- The highest radiation from the equipment is recorded.
- By varying the configuration of the test sample and the cable routing, it is attempted to maximize the emission.
- The test receiver with Quasi Peak and Average detector is in compliance with CISPR 16-1.
- The spectrum analyzer is set-up as following;

(Frequency range : 30 - 1000 MHz)

- ✓ Resolution bandwidth : 100 kHz
- ✓ Video bandwidth : 300 kHz
- ✓ Detector function : Peak
- ✓ Trace Mode : Max Hold

(Frequency range : Above 1000 MHz)

- ✓ Resolution bandwidth : 1 MHz
- ✓ Video bandwidth : 1 MHz
- ✓ Detector function : Peak
- ✓ Trace Mode : Max Hold

- EMI Test Receiver analyzer is set-up as following;
 - ✓ IF bandwidth : 120 kHz (Quasi-Peak Detector)
 - ✓ IF bandwidth : 1 MHz (Average Detector)
- See test configuration figure 4.1.

5.1.2 Minimum Standard

(a) Except as provided in paragraph (b) of this section, the field strength of emissions from intentional radiators operated within these frequency bands shall comply with the following:

Fundamental frequency	Field strength of fundamental (microvolts/meter)	Field strength of harmonics (microvolts/meter)
902-928 MHz	50	500
2400-2483.5 MHz	50	500
5725-5875 MHz	50	500
24.0-24.25 GHz	250	2500

5.1.3 Result

EUT complies with the requirement.

Uncertainty of measurement result: ± 3.28 dB

Temperature, Humidity : Refer to each data table

Note: All measurements was performed with supply voltage varied $\pm 15\%$, but all results were same. Therefore the data with rated voltage shall be recorded in this report.

5.1.4 Measured Data

30MHz to 1GHz, CH 08

Model Name : SM-SC79-R
 Serial No. : None
 Operator : O. Itogawa
 Power Supply : DC3V

Job No : CJ08-069537E
 Temp./Humi. : 24°C/39%
 Condition : Gear Sensor R CH08
 Remark :

Memo : RBW:30M~1GHz (120kHz)

LIMIT : FCC Part15 C 15.249 (3m) 30MHz-26.5GHz

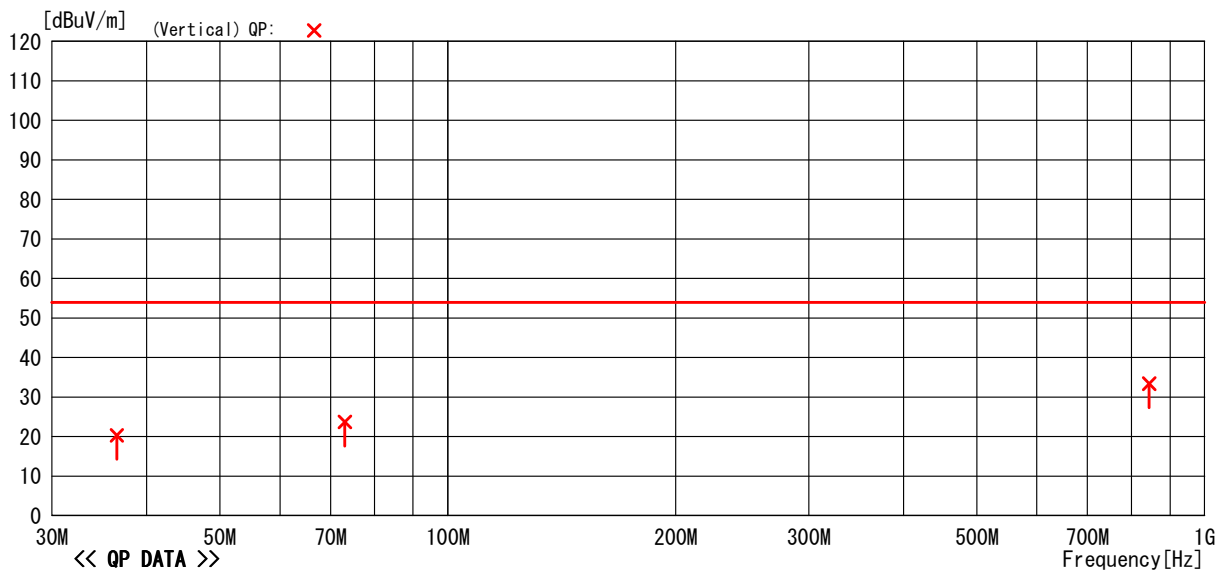
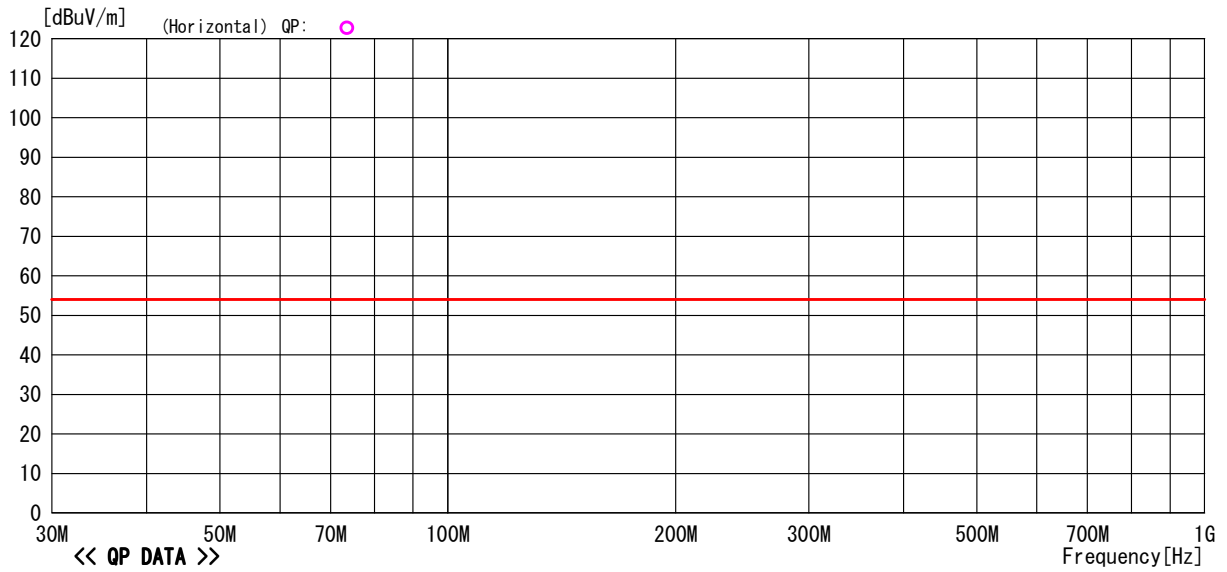

5.1.4 Measured Data (Continued)

30MHz to 1GHz, CH 08

Model Name : SM-SC79-R
 Serial No. : None
 Operator : O. Itogawa
 Power Supply : DC3V

Job No : CJ08-069537E
 Temp./Humi. : 24°C/39%
 Condition : Gear Sensor R CH08
 Remark :

Memo : RBW:30M~1GHz (120kHz)

LIMIT : FCC Part15 C 15.249 (3m) 30MHz-26.5GHz

<< QP DATA >>

No	Freq.	Reading	C. Fac	Result	Limit	Margin	Pola.	Height	Angle	Ant	Comment
	[MHz]	[dBuV]	[dB/m]	[dBuV/m]	[dBuV/m]	[dB]	[H/V]	[cm]	[deg]	Type	
1	36.539	32.1	-11.8	20.3	54.0	33.7	Vert.	100	232	BC	
2	73.077	38.3	-14.6	23.7	54.0	30.3	Vert.	100	354	BC	
3	844.559	31.7	1.7	33.4	54.0	20.6	Vert.	100	343	LP	

5.1.4 Measured Data (Continued)

30MHz to 1GHz, CH 166

Model Name : SM-SC79-R
Serial No. : None
Operator : O. Itogawa
Power Supply : DC3V

Job No : CJ08-069537E
Temp./Humi. : 24°C/39%
Condition : Gear Sensor R CH166
Remark :

Memo : RBW:30M~1GHz (120kHz)

LIMIT : FCC Part15 C 15.249 (3m) 30MHz-26.5GHz

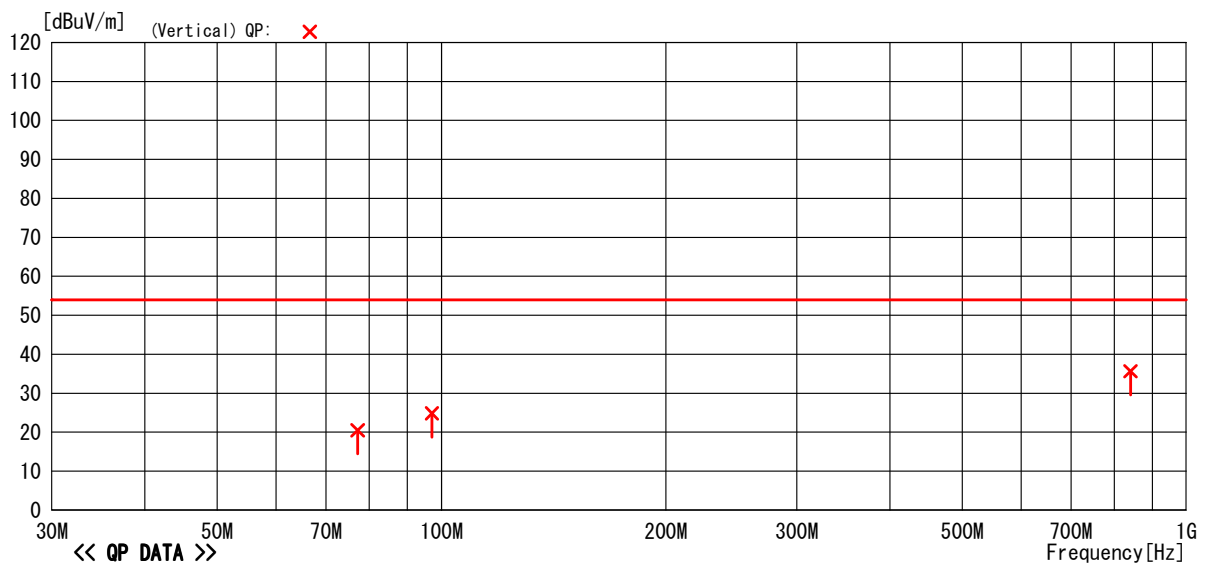
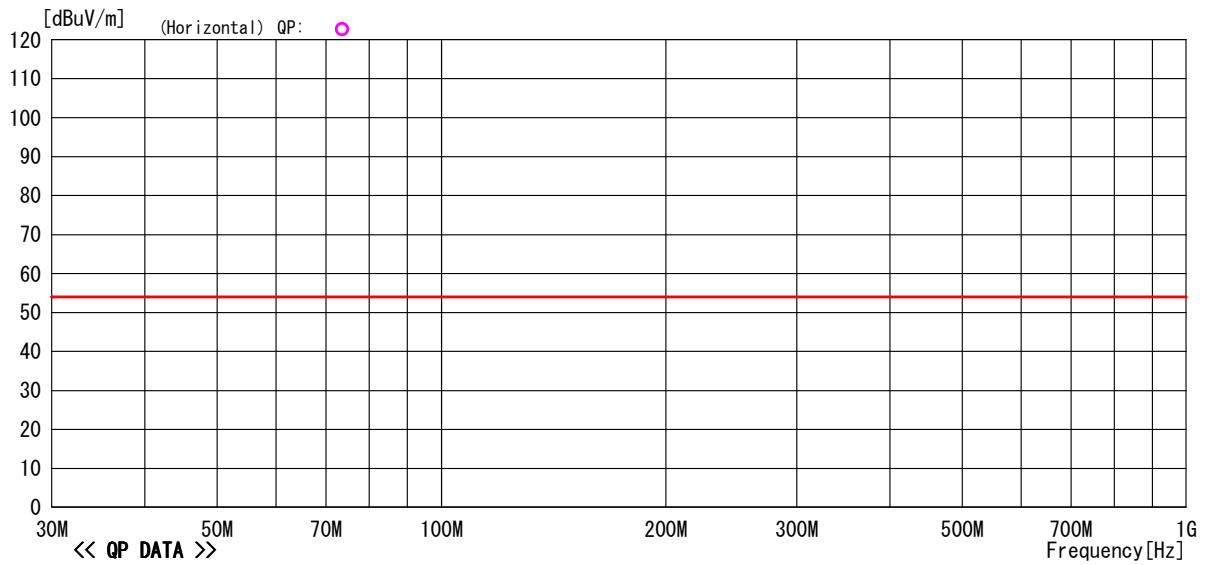

-TEPT0-DV/RE Ver 1.80.0020

5.1.4 Measured Data (Continued)

30MHz to 1GHz, CH 166

Model Name : SM-SC79-R
 Serial No. : None
 Operator : O. Itogawa
 Power Supply : DC3V

Job No : CJ08-069537E
 Temp./Humi. : 24°C/39%
 Condition : Gear Sensor R CH166
 Remark :

Memo : RBW:30M~1GHz (120kHz)

LIMIT : FCC Part15 C 15.249 (3m) 30MHz-26.5GHz

<< QP DATA >>

No	Freq.	Reading	C. Fac	Result	Limit	Margin	Pola.	Height	Angle	Ant	Comment
	[MHz]	[dBuV]	[dB/m]	[dBuV/m]	[dBuV/m]	[dB]	[H/V]	[cm]	[deg]	Type	
1	77.186	34.8	-14.3	20.5	54.0	33.5	Vert.	100	190	BC	
2	97.116	38.6	-13.8	24.8	54.0	29.2	Vert.	100	192	BC	
3	841.382	33.9	1.7	35.6	54.0	18.4	Vert.	100	358	LP	

5.1.4 Measured Data (Continued)

30MHz to 1GHz, CH 321

Model Name : SM-SC79-R
 Serial No. : None
 Operator : O. Itogawa
 Power Supply : DC3V

Job No : CJ08-069537E
 Temp./Humi. : 24°C/39%
 Condition : Gear Sensor R CH321
 Remark :

Memo : RBW: 30M~1GHz (120kHz)

LIMIT : FCC Part15 C 15. 249 (3m) 30MHz-26. 5GHz

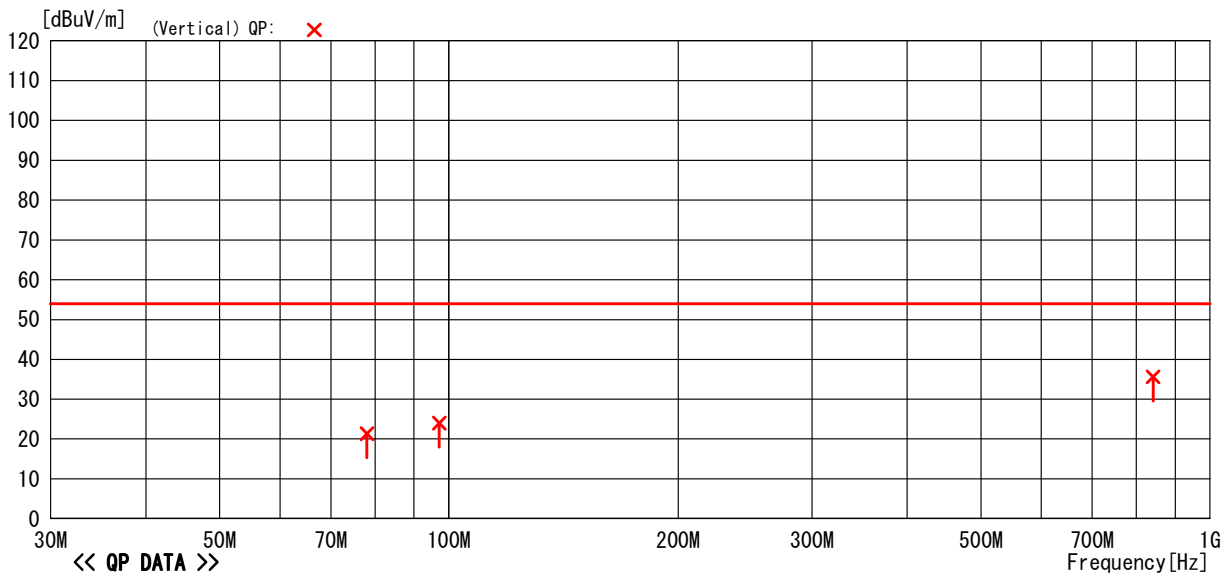
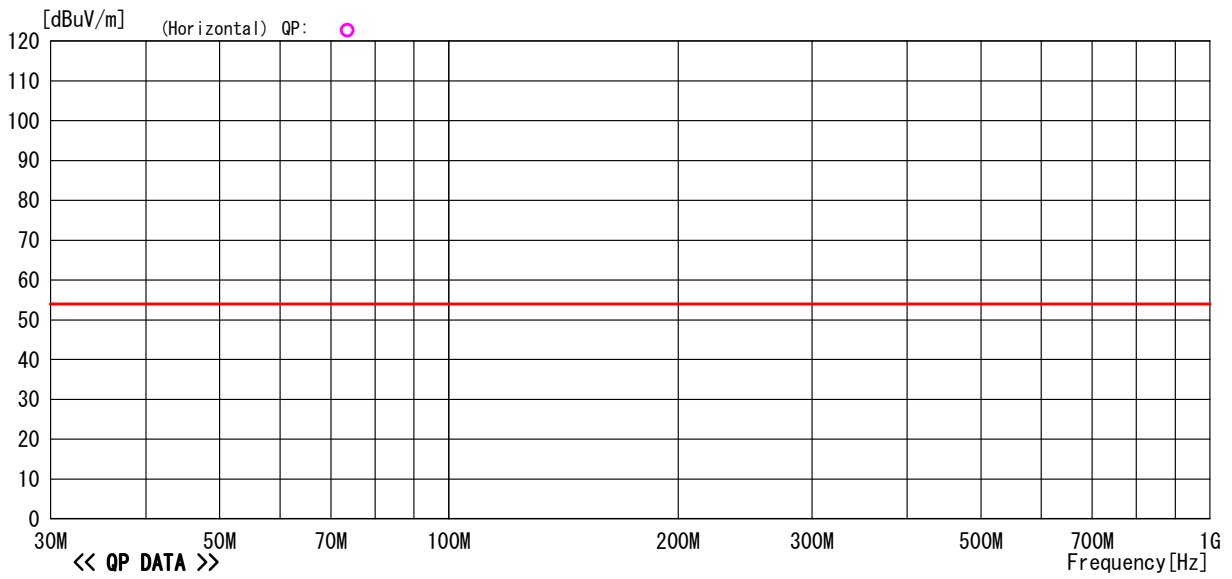

5.1.4 Measured Data (Continued)

30MHz to 1GHz, CH 321

Model Name : SM-SC79-R
 Serial No. : None
 Operator : O. Itogawa
 Power Supply : DC3V

Job No : CJ08-069537E
 Temp./Humi. : 24°C/39%
 Condition : Gear Sensor R CH321
 Remark :

Memo : RBW:30M~1GHz(120kHz)

LIMIT : FCC Part15 C 15.249(3m)30MHz-26.5GHz

<< QP DATA >>

No	Freq.	Reading	C. Fac	Result	Limit	Margin	Pola.	Height	Angle	Ant	Comment
	[MHz]	[dBuV]	[dB/m]	[dBuV/m]	[dBuV/m]	[dB]	[H/V]	[cm]	[deg]	Type	
1	78.048	35.5	-14.2	21.3	54.0	32.7	Vert.	100	199	BC	
2	97.168	37.8	-13.8	24.0	54.0	30.0	Vert.	100	186	BC	
3	841.314	33.9	1.7	35.6	54.0	18.4	Vert.	100	359	LP	

5.1.4 Measured Data (Continued)

1GHz to 18GHz, CH 08

Model Name	: SM-SC79-R	Job No.	: CJ08-069537E
Serial No.	: None	Temp/Humi	: 21°C/40%
Operator	: O. Itogawa	Condition	: Gear Sensor R CH08
Power Supply	: DC3V	Remark	:

Memo : RBW:1GHz~(1MHz)

LIMIT : FCC Part15 C 15.249(3m)30MHz-26.5GHz

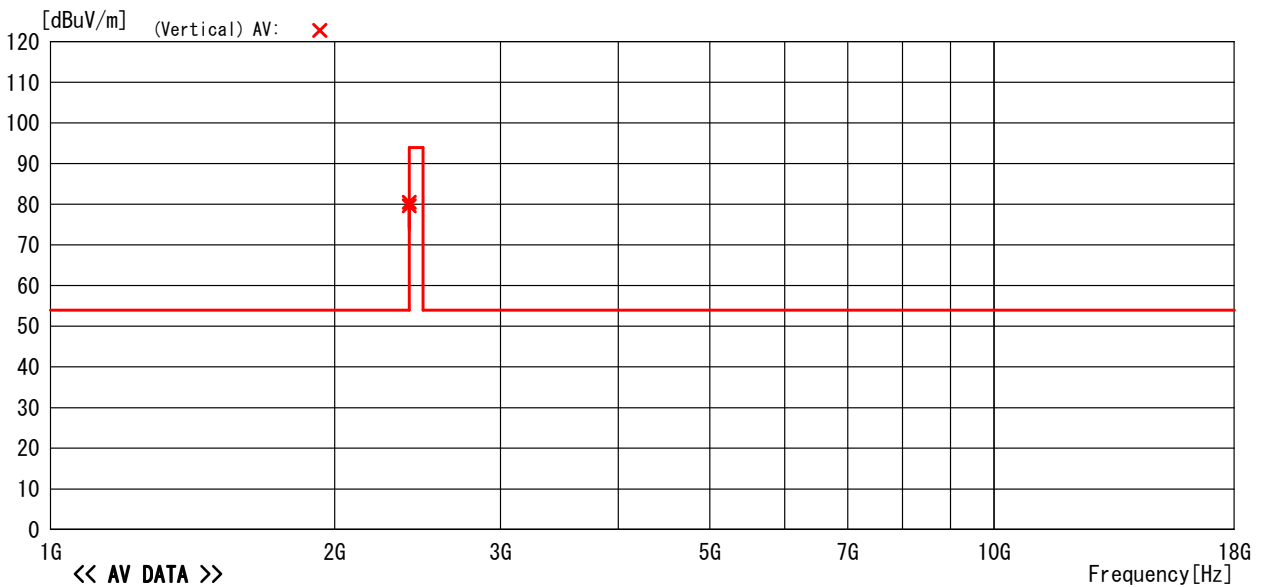
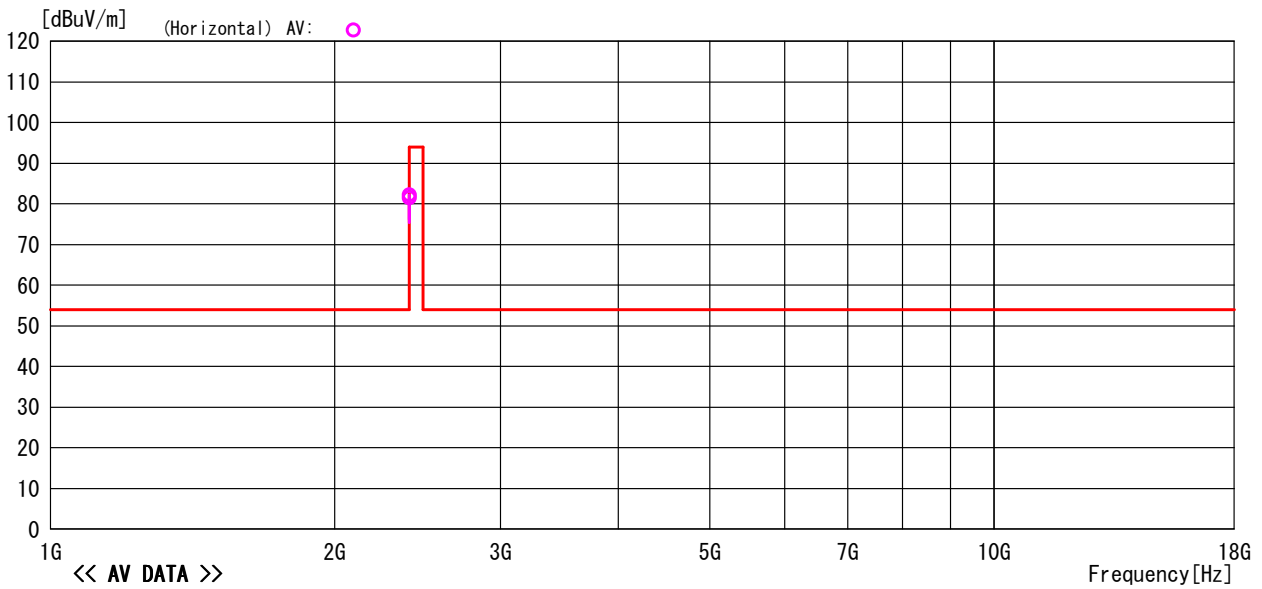

5.1.4 Measured Data (Continued)

1GHz to 18GHz, CH 08

Model Name	: SM-SC79-R	Job No.	: CJ08-069537E
Serial No.	: None	Temp/Humi	: 21°C/40%
Operator	: O. Itogawa	Condition	: Gear Sensor CH08
Power Supply	: DC3V	Remark	:
Memo	: RBW:1GHz~(1MHz)		

LIMIT : FCC Part15 C 15.249 (3m) 30MHz-26.5GHz

No	Freq.	Reading	Ant. Fac	Loss	Gain	Result	Limit	Margin	Pola.	Height	Angle	Ant	Comment
	[MHz]	[dBuV]	[dB/m]	[dB]	[dB]	[dBuV/m]	[dBuV/m]	[dB]	[H/V]	[cm]	[deg]	Type	
1	2402.084	83.1	28.1	-29.8	0.0	81.4	94.0	12.6	Hori.	107	274	HRN	AV Fundamental Frequency
2	2402.114	81.3	28.1	-29.8	0.0	79.6	94.0	14.4	Vert.	100	88	HRN	AV Fundamental Frequency

<<PEAK DATA>>

No	Freq.	Reading	Ant. Fac	Loss	Gain	Result	Limit	Margin	Pola.	Height	Angle	Ant	Comment
	[MHz]	[dBuV]	[dB/m]	[dB]	[dB]	[dBuV/m]	[dBuV/m]	[dB]	[H/V]	[cm]	[deg]	Type	
1	2402.084	83.9	28.1	-29.8	0.0	82.2	114.0	31.8	Hori.	107	274	HRN	PK Fundamental Frequency
2	2402.114	82.2	28.1	-29.8	0.0	80.5	114.0	33.5	Vert.	100	88	HRN	PK Fundamental Frequency

5.1.4 Measured Data (Continued)

1GHz to 18GHz, CH166

Model Name	: SM-SC79-R	Job No.	: CJ08-069537E
Serial No.	: None	Temp/Humi	: 21°C/40%
Operator	: O. Itogawa	Condition	: Gear Sensor R CH166
Power Supply	: DC3V	Remark	:

Memo : RBW:1GHz~(1MHz)

LIMIT : FCC Part15 C 15.249 (3m) 30MHz-26.5GHz

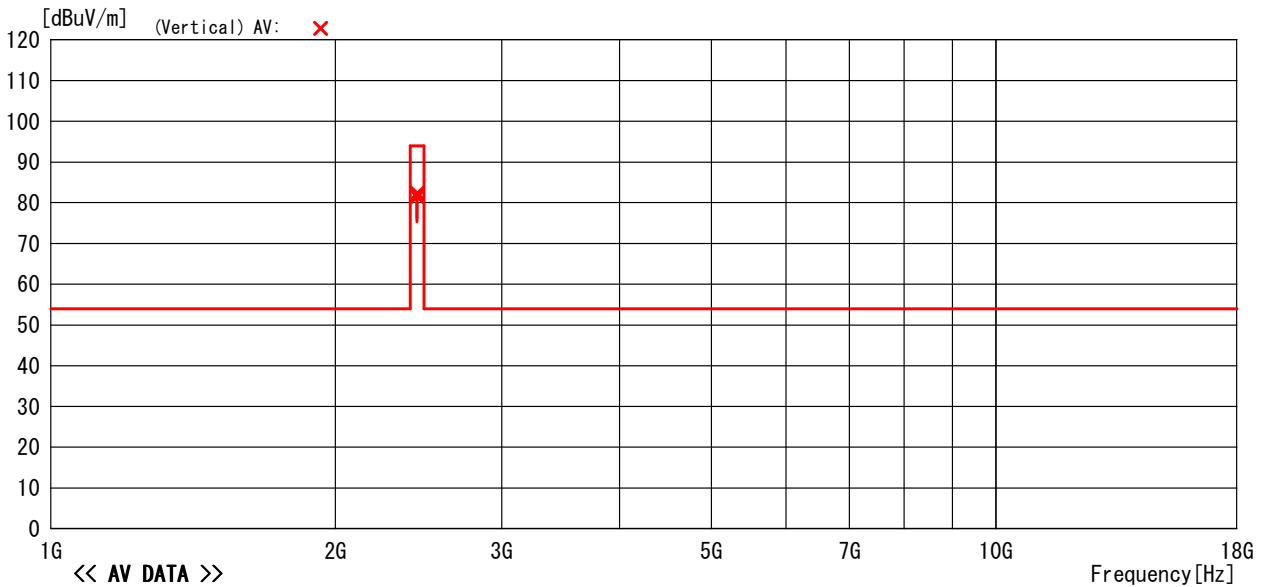
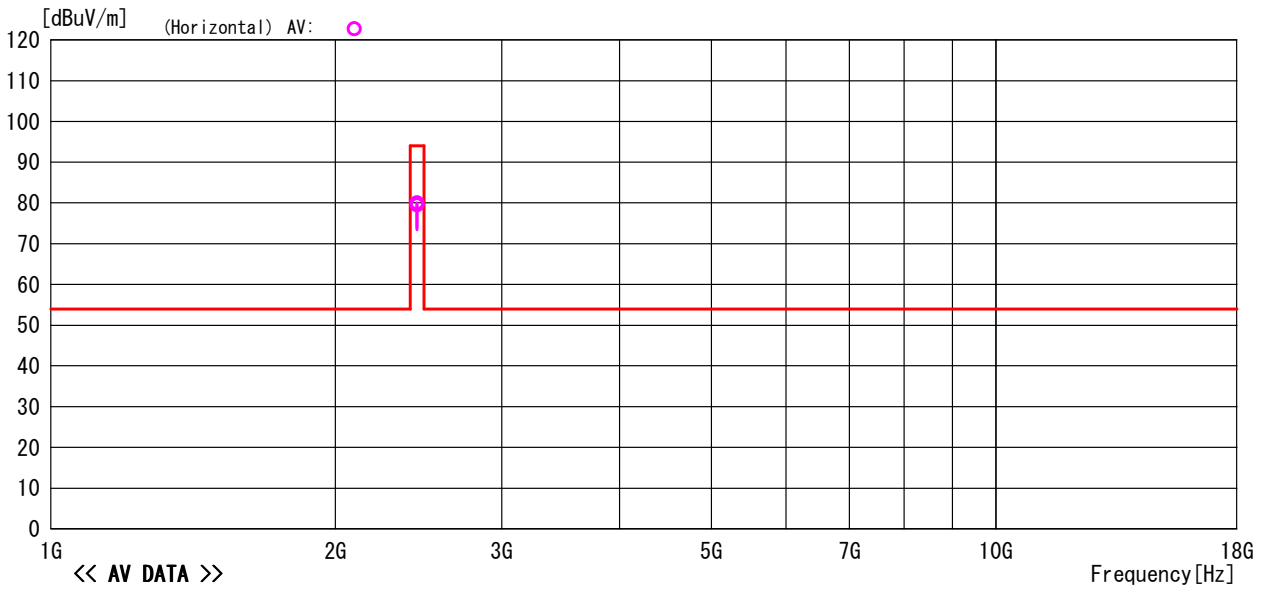

5.1.4 Measured Data (Continued)

1GHz to 18GHz, CH166

Model Name	: SM-SC79-R	Job No.	: CJ08-069537E
Serial No.	: None	Temp/Humi	: 21°C/40%
Operator	: O. Itogawa	Condition	: Gear Sensor R CH166
Power Supply	: DC3V	Remark	:
Memo	: RBW:1GHz~(1MHz)		

LIMIT : FCC Part15 C 15. 249 (3m) 30MHz-26. 5GHz

<<AV DATA>>

No	Freq.	Reading	Ant. Fac	Loss	Gain	Result	Limit	Margin	Pola.	Height	Angle	Ant	Comment
	[MHz]	[dBuV]	[dB/m]	[dB]	[dB]	[dBuV/m]	[dBuV/m]	[dB]	[H/V]	[cm]	[deg]	Type	
1	2441.447	81.1	28.2	-29.8	0.0	79.5	94.0	14.5	Hori.	100	287	HRN	AV Fundamental Frequency
2	2441.567	83.0	28.2	-29.8	0.0	81.4	94.0	12.6	Vert.	100	195	HRN	AV Fundamental Frequency

<<PEAK DATA>>

No	Freq.	Reading	Ant. Fac	Loss	Gain	Result	Limit	Margin	Pola.	Height	Angle	Ant	Comment
	[MHz]	[dBuV]	[dB/m]	[dB]	[dB]	[dBuV/m]	[dBuV/m]	[dB]	[H/V]	[cm]	[deg]	Type	
1	2441.447	81.6	28.2	-29.8	0.0	80.0	114.0	34.0	Hori.	100	287	HRN	PK Fundamental Frequency
2	2441.567	83.9	28.2	-29.8	0.0	82.3	114.0	31.7	Vert.	100	195	HRN	PK Fundamental Frequency

5.1.4 Measured Data (Continued)

1GHz to 18GHz, CH 321

Model Name	: SM-SC79-R	Job No.	: CJ08-069537E
Serial No.	: None	Temp/Humi	: 21°C/40%
Operator	: O. Itogawa	Condition	: Gear Sensor R CH321
Power Supply	: DC3V	Remark	:

Memo : RBW:1GHz~(1MHz)

LIMIT : FCC Part15 C 15.249(3m)30MHz~26.5GHz

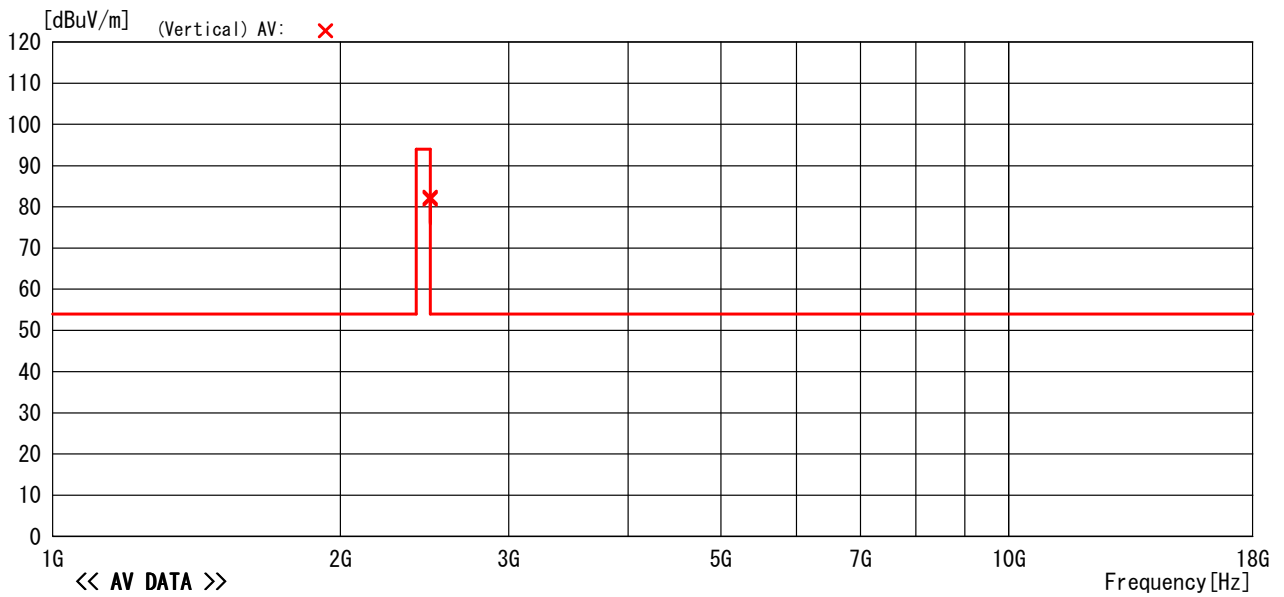
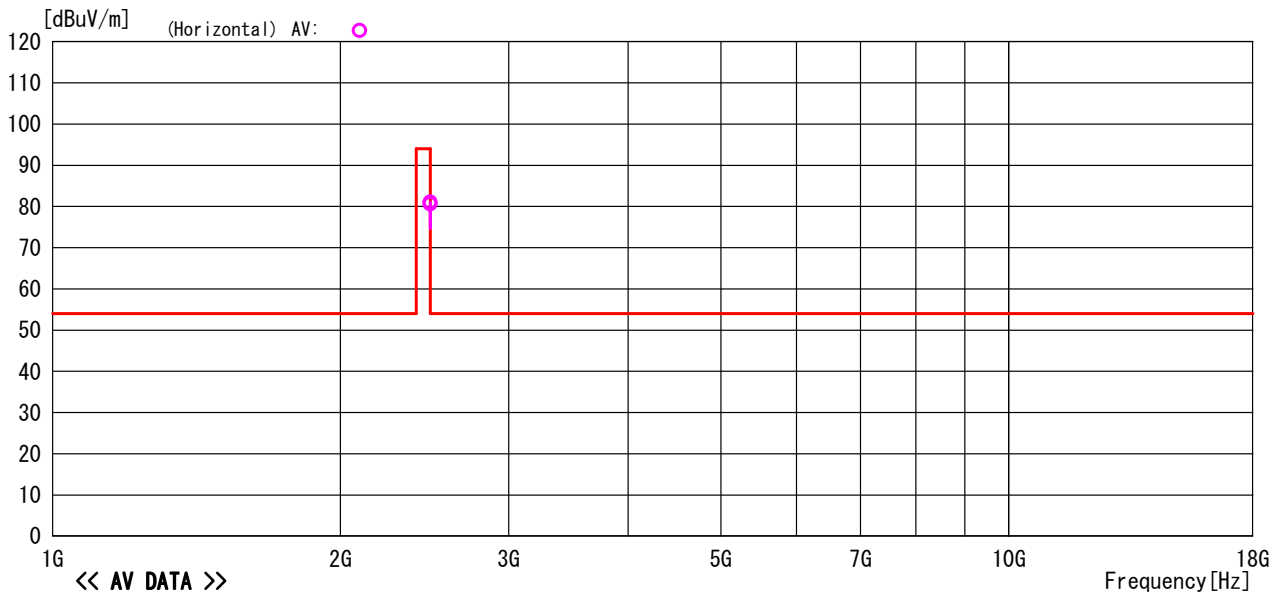

5.1.4 Measured Data (Continued)

1GHz to 18GHz, CH321

Model Name : SM-SC79-R
Serial No. : None
Operator : O. Itogawa
Power Supply : DC3V

Job No. : CJ08-069537E
Temp/Humi : 21°C/40%
Condition : Gear Sensor R CH321
Remark :

Memo : RBW:1GHz~(1MHz)

LIMIT : FCC Part15 C 15.249(3m)30MHz-26.5GHz

<<AV DATA>>

No	Freq.	Reading	Ant. Fac	Loss	Gain	Result	Limit	Margin	Pola.	Height	Angle	Ant	Comment
	[MHz]	[dBuV]	[dB/m]	[dB]	[dB]	[dBuV/m]	[dBuV/m]	[dB]	[H/V]	[cm]	[deg]	Type	
1	2480.193	82.3	28.2	-29.8	0.0	80.7	94.0	13.3	Hori.	100	196	HRN	AV Fundamental Frequency
2	2480.163	83.5	28.2	-29.8	0.0	81.9	94.0	12.1	Vert.	100	195	HRN	AV Fundamental Frequency

<<PEAK DATA>>

No	Freq.	Reading	Ant. Fac	Loss	Gain	Result	Limit	Margin	Pola.	Height	Angle	Ant	Comment
	[MHz]	[dBuV]	[dB/m]	[dB]	[dB]	[dBuV/m]	[dBuV/m]	[dB]	[H/V]	[cm]	[deg]	Type	
1	2480.193	82.6	28.2	-29.8	0.0	81.0	114.0	33.0	Hori.	100	196	HRN	PK Fundamental Frequency
2	2480.163	83.9	28.2	-29.8	0.0	82.3	114.0	31.7	Vert.	100	195	HRN	PK Fundamental Frequency

5.1.4 Measured Data (Continued)

18GHz to 26.5GHz, CH 08

Model Name : SM-SC79-R
 Serial No. : None
 Operator : O. Itogawa
 Power Supply : DC3V

Job No : CJ08-069537E
 Temp/Humi : 24°C/39%
 Condition : Gear Sensor R CH08
 Remark :

Memo : RBW:1MHz(1G~)

LIMIT : FCC Part15 C 15.249 (3m)30MHz-26.5GHz

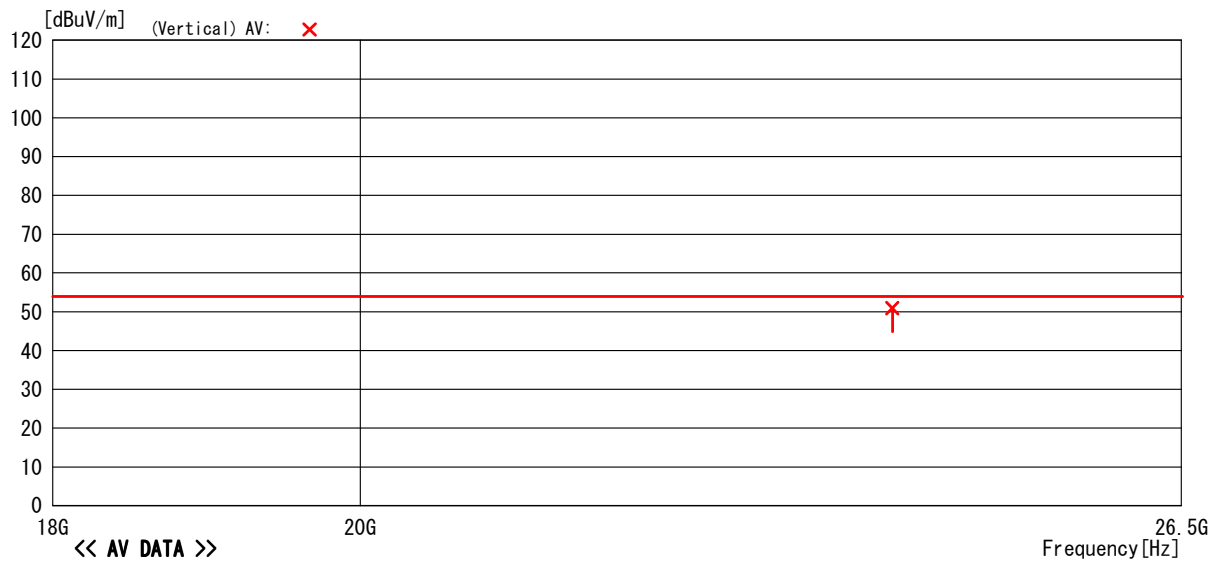
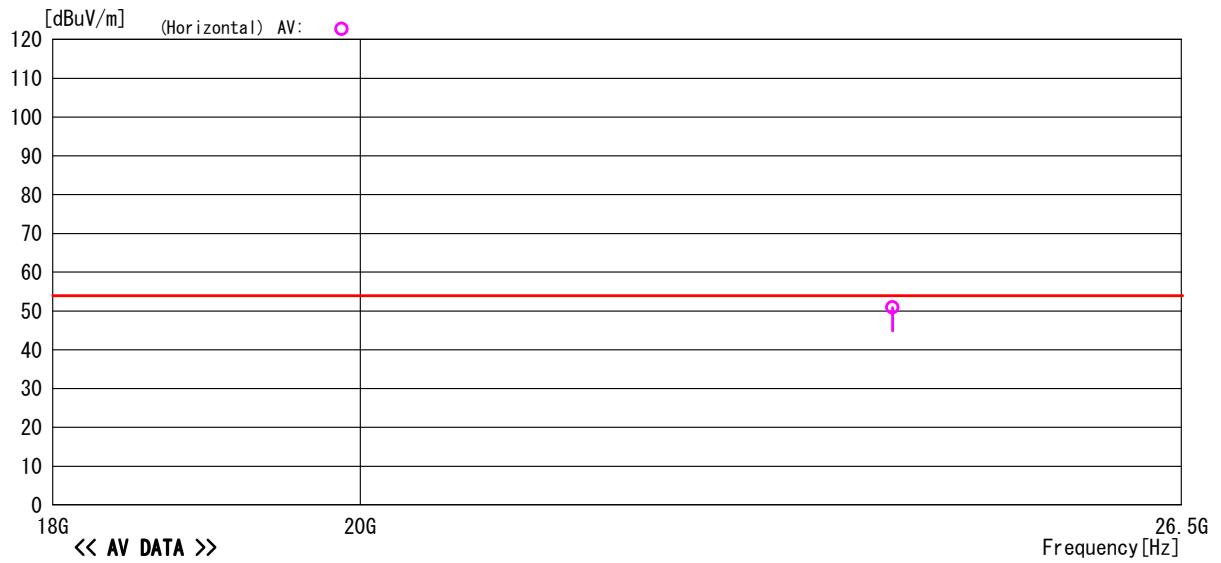

-TEPT0-DV/Ver 1.80.0020

Note: Except for measured point, AV was within a limit.

5.1.4 Measured Data (Continued)

18GHz to 26.5GHz, CH 08

Model Name : SM-SC79-R
Serial No. : None
Operator : O. Itogawa
Power Supply : DC3V

Job No : CJ08-069537E
Temp/Humi : 24°C/39%
Condition : Gear Sensor R CH08
Remark :

Memo : RBW:1MHz(1G~)

LIMIT : FCC Part15 C 15.249(3m)30MHz-26.5GHz

<<AV DATA>>

No	Freq.	Reading	C.Fac	Result	Limit	Margin	Pola.	Height	Angle	Ant	Comment
	[MHz]	[dBuV]	[dB/m]	[dBuV/m]	[dBuV/m]	[dB]	[H/V]	[cm]	[deg]	Type	
1	24000.000	30.2	20.7	50.9	54.0	3.1	Hori.	100	0	HRN	AV Freq:24000.000MHz
2	24000.000	30.2	20.7	50.9	54.0	3.1	Vert.	100	0	HRN	AV Freq:24000.000MHz

<<PEAK DATA>>

No	Freq.	Reading	C.Fac	Result	Limit	Margin	Pola.	Height	Angle	Ant	Comment
	[MHz]	[dBuV]	[dB/m]	[dBuV/m]	[dBuV/m]	[dB]	[H/V]	[cm]	[deg]	Type	
1	24000.000	30.3	20.7	51.0	74.0	23.0	Hori.	100	0	HRN	PK Freq:24000.000MHz
2	24000.000	30.3	20.7	51.0	74.0	23.0	Vert.	100	0	HRN	PK Freq:24000.000MHz

Measured Data (Continued)

18GHz to 26.5GHz, CH166

Model Name : SM-SC79-R
 Serial No. : None
 Operator : O. Itogawa
 Power Supply : DC3V

Job No : CJ08-069537E
 Temp/Humi : 24°C/39%
 Condition : Gear Sensor R CH166
 Remark :

Memo : RBW:1MHz(1G~)

LIMIT : FCC Part15 C 15.249(3m)30MHz-26.5GHz

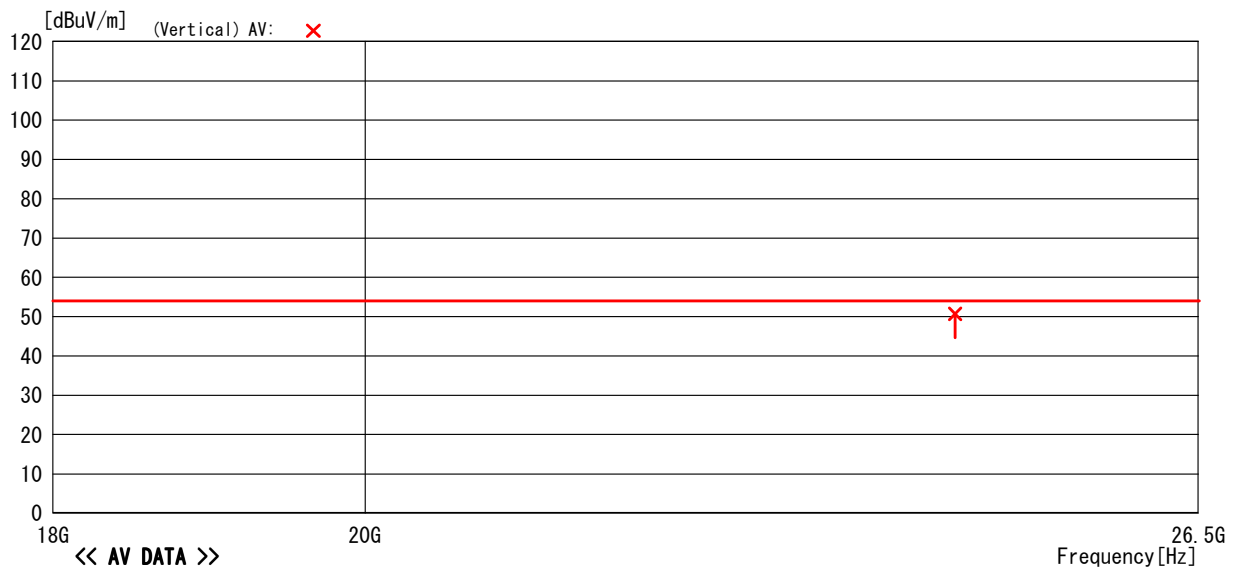
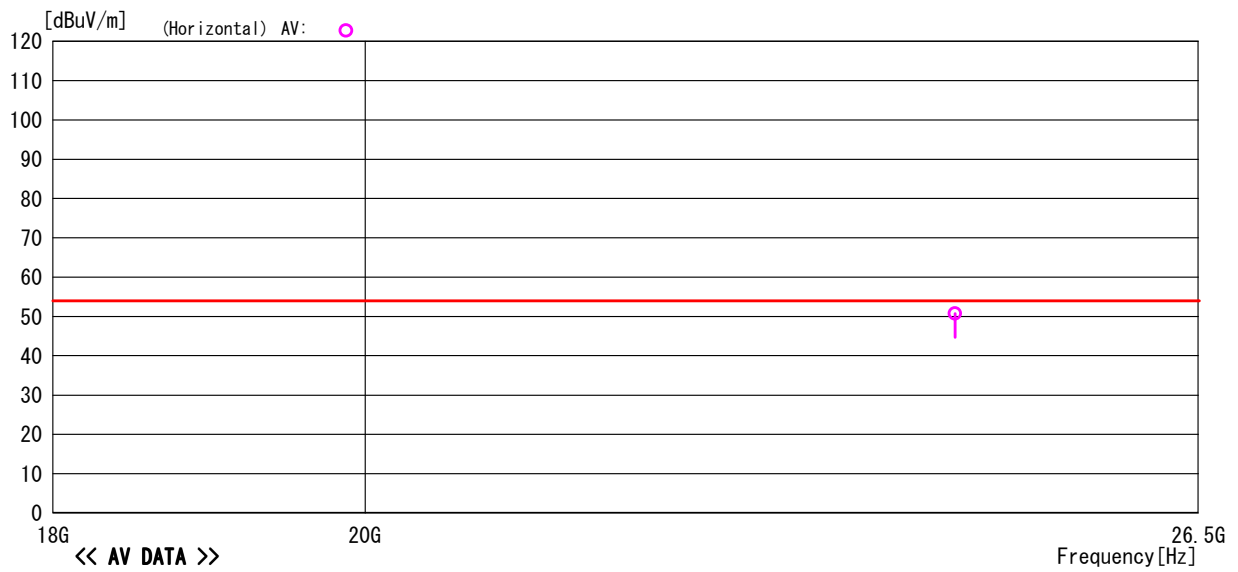

-TEPT0-DV/Ver 1.80.0020

Note: Except for measured point, AV was within a limit.

5.1.4 Measured Data (Continued)

18GHz to 26.5GHz, CH166

Model Name : SM-SC79-R
 Serial No. : None
 Operator : O. Itogawa
 Power Supply : DC3V

Job No : CJ08-069537E
 Temp/Humi : 24°C/39%
 Condition : Gear Sensor R CH166
 Remark :

Memo : RBW:1MHz(1G~)

LIMIT : FCC Part15 C 15.249(3m)30MHz-26.5GHz

<<AV DATA>>

No	Freq.	Reading	C.Fac	Result	Limit	Margin	Pola.	Height	Angle	Ant	Comment
	[MHz]	[dBuV]	[dB/m]	[dBuV/m]	[dBuV/m]	[dB]	[H/V]	[cm]	[deg]	Type	
1	24410.000	30.1	20.6	50.7	54.0	3.3	Hori.	100	0	HRN	AV Freq:24410.000MHz
2	24410.000	30.1	20.6	50.7	54.0	3.3	Vert.	100	0	HRN	AV Freq:24410.000MHz

<<PEAK DATA>>

No	Freq.	Reading	C.Fac	Result	Limit	Margin	Pola.	Height	Angle	Ant	Comment
	[MHz]	[dBuV]	[dB/m]	[dBuV/m]	[dBuV/m]	[dB]	[H/V]	[cm]	[deg]	Type	
1	24410.000	30.2	20.6	50.8	74.0	23.2	Hori.	100	0	HRN	PK Freq:24410.000MHz
2	24410.000	30.2	20.6	50.8	74.0	23.2	Vert.	100	0	HRN	PK Freq:24410.000MHz

Measured Data (Continued)

18GHz to 26.5GHz, CH 321

Model Name : SM-SC79-R
 Serial No. : None
 Operator : O. Itogawa
 Power Supply : DC3V

Job No : GJ08-069537E
 Temp/Humi : 24°C/39%
 Condition : Gear Sensor R CH321
 Remark :

Memo : RBW:1MHz (1G~)

LIMIT : FCC Part15 C 15.249 (3m) 30MHz-26.5GHz

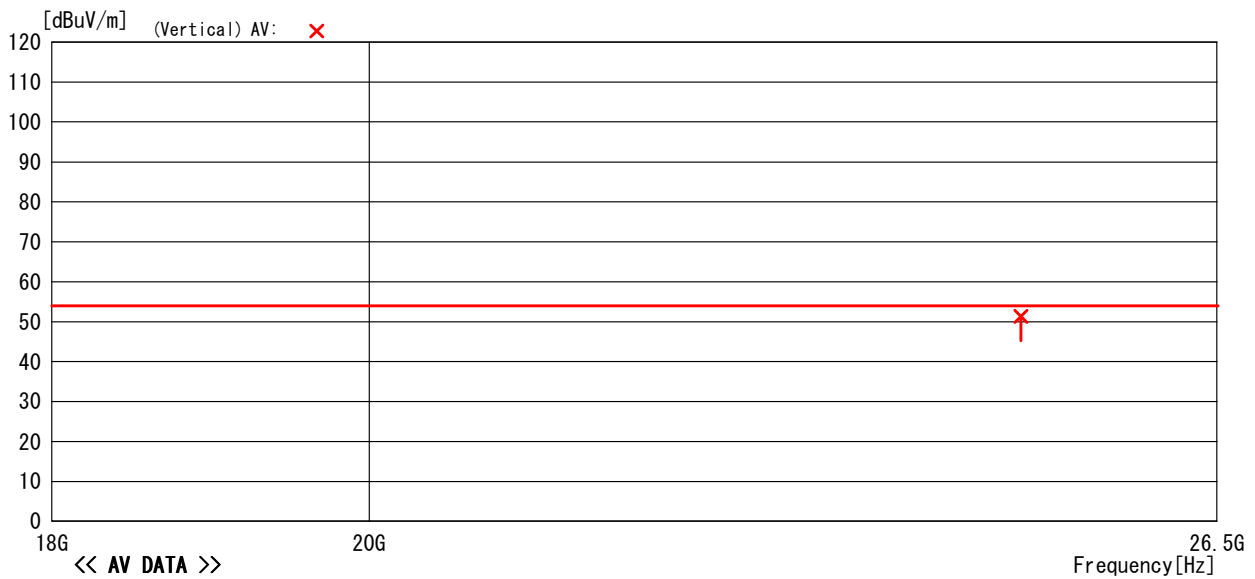
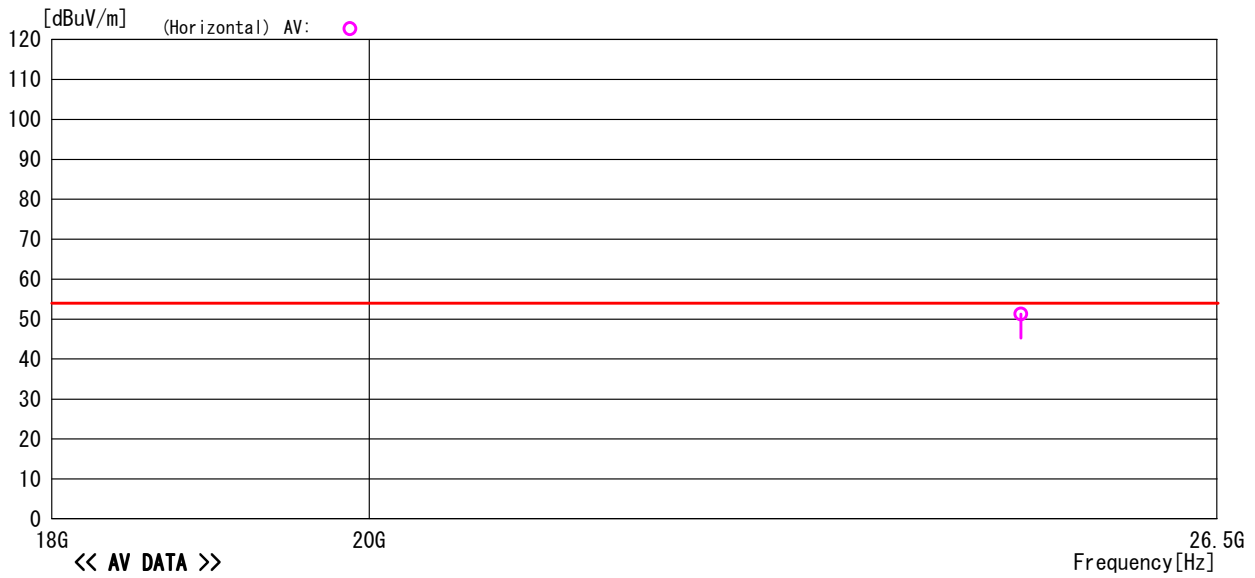

-TEPT0-DV/Ver 1.80.0020

Note: Except for measured point, AV was within a limit.

5.1.4 Measured Data (Continued)

18GHz to 26.5GHz, CH321

Model Name : SM-SC79-R
 Serial No. : None
 Operator : O. Itogawa
 Power Supply : DC3V

Job No : CJ08-069537E
 Temp/Humi : 24°C/39%
 Condition : Gear Sensor R CH321
 Remark :

Memo : RBW:1MHz (1G~)

LIMIT : FCC Part15 C 15.249 (3m) 30MHz-26.5GHz

<<AV DATA>>

No	Freq.	Reading	C.Fac	Result	Limit	Margin	Pola.	Height	Angle	Ant	Comment
	[MHz]	[dBuV]	[dB/m]	[dBuV/m]	[dBuV/m]	[dB]	[H/V]	[cm]	[deg]	Type	
1	24830.000	30.5	20.8	51.3	54.0	2.7	Hori.	100	0	HRN	AV Freq:24830.000MHz
2	24830.000	30.5	20.8	51.3	54.0	2.7	Vert.	100	0	HRN	AV Freq:24830.000MHz

<<PEAK DATA>>

No	Freq.	Reading	C.Fac	Result	Limit	Margin	Pola.	Height	Angle	Ant	Comment
	[MHz]	[dBuV]	[dB/m]	[dBuV/m]	[dBuV/m]	[dB]	[H/V]	[cm]	[deg]	Type	
1	24830.000	30.6	20.8	51.4	74.0	22.6	Hori.	100	0	HRN	PK Freq:24830.000MHz
2	24830.000	30.6	20.8	51.4	74.0	22.6	Vert.	100	0	HRN	PK Freq:24830.000MHz

5.2 15. 247(d) Band Edge Measurement

5.2.1 Setting Remarks

- EUT directly connects to the spectrum analyzer via calibrated coaxial cable and 10 dB attenuator.
- The loss of the coaxial cable is maximum 1 dB.
- The emission at the band edge is measured by using the marker function of spectrum analyzer.
- The peak of the in-band emission is measured by using the marker to peak function of spectrum analyzer.
- This measurement is repeated in both side of the spectrum.
- The spectrum analyzer is set-up as following;
 - ✓ Frequency Span : 30MHz
 - ✓ Resolution bandwidth : 300kHz (1% of frequency span)
 - ✓ Video bandwidth : > RBW
 - ✓ Sweep : Auto
 - ✓ Detector function : Peak
 - ✓ Trace Mode : Max Hold
- Where bandedge spectrum is too rough to find precise edge point, larger RBW i.e. 1MHz, 3MHz shall be applied as severer condition.
- See test configuration figure 4.1.

5.2.2 Minimum Standard

In any 100kHz bandwidth outside the frequency band in which the transmitter is operating, emissions shall be at least 20 dB below the fundamental emission or shall not exceed the following field strength limits. Emissions falling in the restricted bands of 15.205 shall not exceed the following field strength limits:

Frequency of Emission (MHz)	Limit of the band edge spurious emission (dB μ V)	
	Peak	Average
Below 2,400.0		
Above 2,483.5	74	54

5.2.3 Result

EUT complies with the requirement.

Uncertainty of measurement result: ± 2.6 dB

Temperature, Humidity : 24°C, 40%

5.2.4 Measured Data

The band edge emissions are calculated as following;

(Horizontal)

CH	P _{max}	P _{av}	P _{dev}	c.f.	E _{be}	E _{av}	Limit(E _{be})	Limit(E _{av})	Margin(E _{be})	Margin(E _{av})
8 CH (2402.50 MHz)	78.71	78.02	34.10	-1.7	42.9	42.2	74.0	54.0	31.1	11.8
321 CH (2480.75 MHz)	79.19	78.61	37.66	-1.7	39.8	39.3	74.0	54.0	34.2	14.8

(Vertical)

CH	P _{max}	P _{av}	P _{dev}	c.f.	E _{be}	E _{av}	Limit(E _{be})	Limit(E _{av})	Margin(E _{be})	Margin(E _{av})
8 CH (2402.50 MHz)	82.06	81.36	39.20	-1.7	41.2	40.5	74.0	54.0	32.8	13.5
321 CH (2480.75 MHz)	77.51	76.47	38.00	-1.7	37.8	36.8	74.0	54.0	36.2	17.2

NOTE Vertical and Horizontal were measured and Vertical was confirmed as the worst.

- P_{max} : Maximum peak power of the fundamental.
- P_{av} : Average of the fundamental.
- P_{dev} : The amplitude delta between the peak power and the band edge emission.
- E_{be} : Band edge emission.
- E_{av} : Average of the band edge emission.

5.3 15. 215 (c) 20 dB Bandwidth

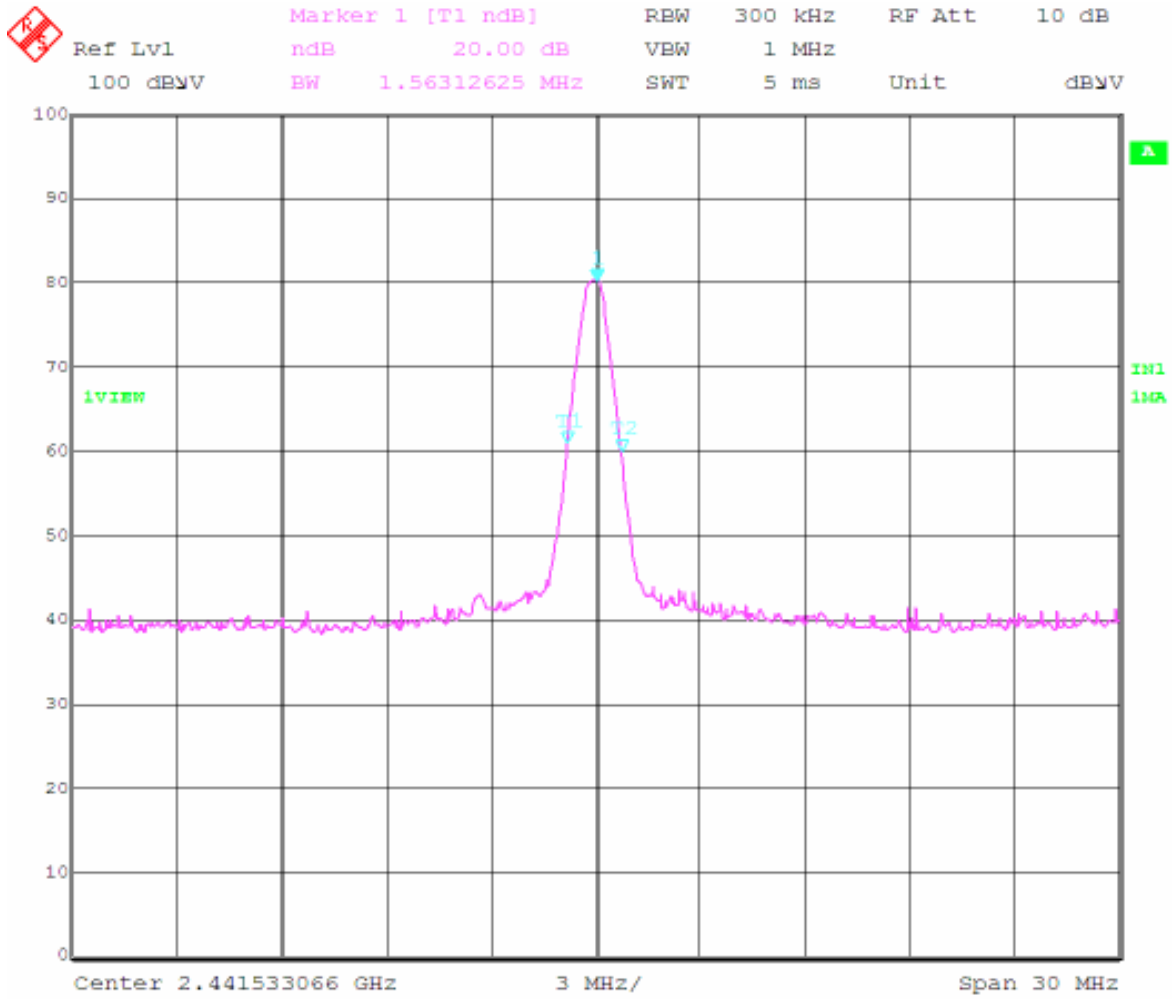

6. Photos

6.1 Setup Photo

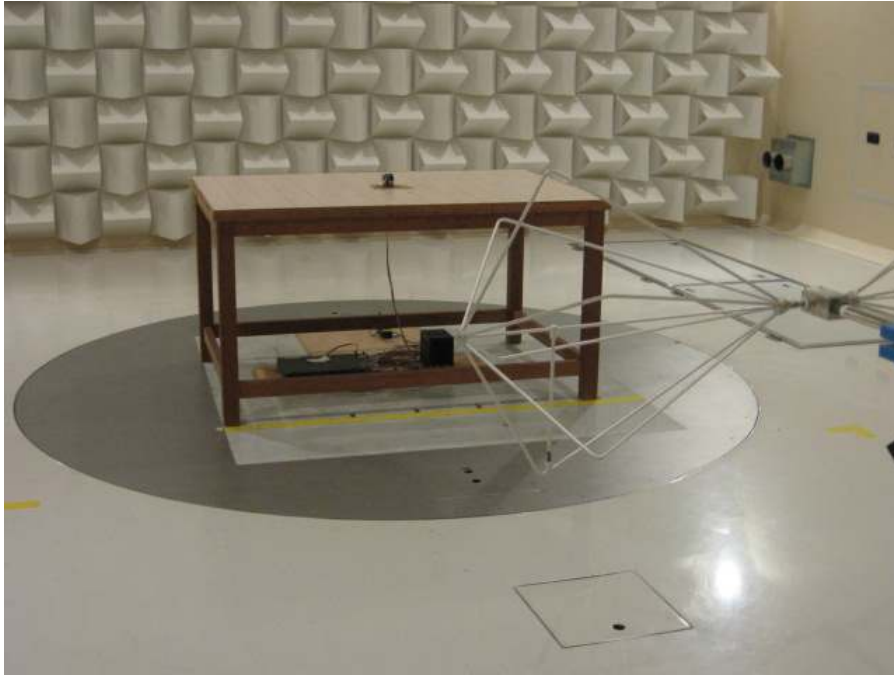

7. List of Test Measurement Instruments

7.1 Radiated Emission Measurement

Instruments	Manufacturer	Model / Type	Serial No.	Calibration Date Next Calibration
Programmable AC/DC Power Source	NF Corporation	ES18000W	425779	Confirmed Before Test
EMI Test Receiver	ROHDE & SCHWARZ	ESIB40	100211	February, 2009 February, 2010
Biconical Antenna (30 to 300 MHz)	SCHWARZBECK	VHBB9124 (Balun) BBA9106 (Elements)	9124-311	September, 2008 September, 2009
Log.-Periodic Antenna (300 MHz to 1 GHz)	SCHWARZBECK	UHALP9108A	645	September, 2008 September, 2009
Horn Antenna	SCHWARZBECK	BBHA9120D	443	September, 2008 September, 2009
Horn Antenna	ETS LINDGREN	3160-08	00033782	September, 2008 September, 2009
Horn Antenna	ETS LINDGREN	3160-09	00034723	September, 2008 September, 2009