



SAR TEST REPORT

Test Report No. : 11343917H-B-R1

Applicant : SHIMANO INC.
Type of Equipment : Wireless LAN module
Model No. : S-W092
FCC ID : WY7-21
Test regulation : FCC47CFR 2.1093
(Class II permissive change)
Test Result : Complied
Reported SAR(1g) Value : **The highest reported SAR(1g)**
Body : 0.21W/kg

1. This test report shall not be reproduced in full or partial, without the written approval of UL Japan, Inc.
2. The results in this report apply only to the sample tested.
3. This sample tested is in compliance with the limits of the above regulation.
4. The test results in this report are traceable to the national or international standards.
5. This test report must not be used by the customer to claim product certification, approval, or endorsement by NVLAP, NIST, or any agency of the Federal Government.
6. This test report covers SAR technical requirements. It does not cover administrative issues such as Manual or non-SAR test related Requirements. (if applicable)
7. This report is a revised version of 11343917H-B. 11343917H-B is replaced with this report.

Date of test: June 24, 2016

Representative test engineer:

S. Matsuyama
Satofumi Matsuyama
Engineer
Consumer Technology Division

Approved by :

Takayuki Shimada
Takayuki Shimada
Engineer
Consumer Technology Division



This laboratory is accredited by the NVLAP LAB CODE 200572-0, U.S.A. The tests reported herein have been performed in accordance with its terms of accreditation.
*As for the range of Accreditation in NVLAP, you may refer to the WEB address,
http://japan.ul.com/resources/emc_accruited/

UL Japan, Inc.

Ise EMC Lab.

4383-326 Asama-cho, Ise-shi, Mie-ken 516-0021 JAPAN

Telephone: +81 596 24 8999

Facsimile: +81 596 24 8124

13-EM-F0429

CONTENTS	PAGE
SECTION 1: Customer information.....	4
SECTION 2: Equipment under test (E.U.T.)	4
2.1 Identification of E.U.T.....	4
2.2 Product description.....	5
SECTION 3: Test standard information	6
3.1 Test Specification	6
3.2 Procedure.....	6
3.3 Exposure limit	7
3.4 Test Location.....	7
SECTION 4: Test result.....	8
4.1 Stand-alone SAR result.....	8
SECTION 5: Description of the operating mode.....	9
5.1 Output power operating modes.....	9
5.2 Output power measurement results.....	10
5.3 SAR testing operating modes	12
5.4 Confirmation after SAR testing.....	12
SECTION 6 SAR test exclusion considerations	13
6.1 Standalone SAR test exclusion considerations	13
SECTION 7: Description of the Body setup.....	15
7.1 Test position for Body setup.....	15
SECTION 8: Test surrounding	16
8.1 Measurement uncertainty	16
SECTION 9: Measurement results	17
9.1 Body SAR.....	17
SECTION 10 Test instruments.....	19
APPENDIX 1: SAR Measurement data	20
1. Evaluation procedure	20
2. Measurement data.....	21
APPENDIX 2: System Check	28
1. System check result Body 2450MHz.....	28
2. System Check Dipole (D2450V2,S/N:713) SAR Calibration Certificate - Dipole 2450MHz	31
3. System check uncertainty	41
APPENDIX 3: System specifications	42
1. Configuration and peripherals.....	42
2. Specifications.....	43
3. Dosimetric E-Field Probe Calibration (EX3DV4, S/N: 3825).....	47
APPENDIX 4: Photographs of test setup	58
1. Photographs of EUT	58
2. Antenna position.....	59
3. Photographs of setup.....	61

SECTION 1: Customer information

Company Name : SHIMANO INC.
Address : 3-77 Oimatsu-cho, Sakai-ku, Sakai City, Osaka 590-8577, Japan
Telephone Number : +81-72-223-7019
Facsimile Number : +81-72-223-3770
Contact Person : Hitoshi Hamada

SECTION 2: Equipment under test (E.U.T.)

2.1 Identification of E.U.T.

<Information of the EUT>

Type of Equipment : Wireless LAN module
Model No. : S-W092
Serial No. : SARW01
Rating : DC 3.3 V
Receipt Date of Sample : June 18, 2016
Country of Mass-production : Philippines
Condition of EUT : Production prototype
(Not for Sale: This sample is equivalent to mass-produced items.)
Modification of EUT : No Modification by the test lab

<Information of the Host device>

Type of Equipment : Digital Camera
Model No. : CM-1100
Serial No. : 1 060
Rating : Li-ion Battery (M/N:CMB-001)
DC 3.7V 950mAh 3.6Wh
* The test was performed with the EUT operated by battery.
Size of Host device : W: 44.2mm, D: 70.0mm, H: 30.3mm

*This Digital Camera is included ANT+ module.(FCC ID:WY7-SWAN1)

*ANT+ module is complied to FCC15.249, therefore simultaneous transmission between WLAN and ANT+ is excluded.

2.2 Product description

General Specification

<EUT>

Clock frequency(ies) in the system : 26MHz

<Host device>

Clock frequency(ies) in the system : 48MHz and 32.768kHz for main system
26MHz for Wireless LAN module
16MHz and 32.768kHz for ANT+ module

Radio Specification

[WLAN (IEEE802.11b/g/n-20)]

Radio Type : Transceiver
Frequency of Operation : 2412 - 2462 MHz
Modulation : DSSS and OFDM
Antenna type : 2.4 GHz Pattern Antenna
Antenna Gain : 0.41 dBi

SECTION 3 : Test standard information

3.1 Test Specification

Title : **FCC47CFR 2.1093**
Radiofrequency radiation exposure evaluation: portable devices.
: **IEEE Std 1528-2013:**
IEEE Recommended Practice for Determining the Peak Spatial-Average Specific Absorption Rate (SAR) in the Human Head from Wireless Communications Devices: Measurement Techniques.

: **Published RF exposure KDB procedures**

- KDB447498D01(v06)** Mobile and Portable Device RF Exposure Procedures and Equipment Authorization Policies
- KDB447498D02(v02r01)** SAR Measurement Procedures for USB Dongle Transmitters
- KDB648474D04(v01r03)** SAR Evaluation Considerations for Wireless Handsets
- KDB941225D01(v03r01)** SAR Measurement Procedures for 3G Devices
- KDB941225D05(v02r05)** SAR for LTE Devices
- KDB941225D06(v02r01)** SAR test procedures for devices incorporating SAR Evaluation Procedures for Portable Devices with Wireless Router Capabilities (Hot Spot SAR)
- KDB941225D07(v01r02)** SAR Evaluation Procedures for UMPC Mini-Tablet Devices
- KDB616217D04(v01r02)** SAR Evaluation Considerations for Laptop, Notebook, Netbook and Tablet Computers
- KDB865664D01(v01r04)** SAR Measurement Requirements for 100MHz to 6 GHz
- KDB248227D01(v02r02)** SAR Measurement Procedures for 802.11a//b/g Transmitters

Reference

[1]SPEAG uncertainty document (AN 15-7/AN19-17) for DASY 5 System from SPEAG (Schmid & Partner Engineering AG).

3.2 Procedure

Transmitter	WLAN
Test Procedure	Published RF exposure KDB procedures
Category	FCC47CFR 2.1093
Note: UL Japan, Inc. 's SAR Work Procedures 13-EM-W0429 and 13-EM-W0430	

3.3 Exposure limit

(A) Limits for Occupational/Controlled Exposure (W/kg)

Spatial Average (averaged over the whole body)	Spatial Peak (averaged over any 1g of tissue)	Spatial Peak (hands/wrists/feet/ankles averaged over 10g)
0.4	8.0	20.0

(B) Limits for General population/Uncontrolled Exposure (W/kg)

Spatial Average (averaged over the whole body)	Spatial Peak (averaged over any 1g of tissue)	Spatial Peak (hands/wrists/feet/ankles averaged over 10g)
0.08	1.6	4.0

Occupational/Controlled Environments: are defined as locations where there is exposure that may be incurred by people who are aware of the potential for exposure, (i.e. as a result of employment or occupation).

General Population/Uncontrolled Environments: are defined as locations where there is the exposure of individuals who have no knowledge or control of their exposure.

**NOTE:GENERAL POPULATION/UNCONTROLLED EXPOSURE
SPATIAL PEAK(averaged over any 1g of tissue) LIMIT
1.6 W/kg**

3.4 Test Location

*Shielded room for SAR testings
UL Japan, Inc. Ise EMC Lab. *NVLAP Lab. code: 200572-0
4383-326 Asama-cho, Ise-shi, Mie-ken 516-0021 JAPAN
Telephone : +81 596 24 8999 Facsimile : +81 596 24 8124

SECTION 4 : Test result**4.1 Stand-alone SAR result****Reported SAR**

Measured SAR is scaled to the maximum tune-up tolerance limit by the following formulas.

Reported SAR= Measured SAR [W/kg] · Scaled factor *1

Maximum tune-up tolerance limit is by the specification from a customer.

Body SAR

Mode	Frequency	Measured power [dBm]*2	Measured power [mW]	Maximum tune-up tolerance limit [dBm]	Maximum tune-up tolerance limit [mW]	Measured SAR [W/kg]	Scaled factor	Reported SAR [W/kg]
WLAN11b	2412MHz	10.72	11.80	11.04	12.71	0.192	1.076	0.207

Note

*1 Scaled factor = Maximum tune-up tolerance limit [mW] / Measured power [mW]

*2 The sample used by the SAR test is not more than 2 dB lower than the maximum tune-up tolerance limit. That is, measured power is included the tune-up tolerance range.

WLAN Maximum tune-up tolerance limit

Mode	Maximum tune-up tolerance limit [dBm]	Maximum tune-up tolerance limit [mW]
WLAN 11b	11.04	12.71
WLAN 11g	10.22	10.52
WLAN 11n20	8.17	6.56

SECTION 5 : Description of the operating mode**5.1 Output power operating modes**

Mode	Frequency Band	Test Frequency	Remarks
WLAN	2412-2462MHz	2412MHz (1 ch) 2437MHz (6 ch) 2462MHz (11 ch)	DSSS(11b) OFDM(11g, 11n-20)

*The power value of the EUT was set for testing as follows (setting value might be different from product specification value);

Power settings: WLAN: 11b: 11, 11g: 10, 11n20: 9

Software: WLAN: WLAN-RF-Test-FW-20160615

*This setting of software is the worst case.

Any conditions under the normal use do not exceed the condition of setting.

In addition, end users cannot change the settings of the output power of the product.

5.2 Output power measurement results**Output power measurement for WLAN****IEEE802.11b 1Mbps**

Ch	Frequency [MHz]	P/M Reading	Cable Loss [dB]	Atten. [dB]	Result	
		AVG			[dBm] AVG	[mW] AVG
1	2412	0.00	0.63	10.09	10.72	11.80
6	2437	-0.02	0.63	10.09	10.70	11.75
11	2462	-0.01	0.63	10.09	10.71	11.78

IEEE802.11b 5.5Mbps

Ch	Frequency [MHz]	P/M Reading	Cable Loss [dB]	Atten. [dB]	Result	
		AVG			[dBm] AVG	[mW] AVG
1	2412	0.29	0.63	10.09	11.01	12.62
6	2437	0.17	0.63	10.09	10.89	12.27
11	2462	0.22	0.63	10.09	10.94	12.42

:SAR test channel

Sample Calculation:

Result = Reading + Cable Loss + Attenuator

IEEE802.11g 6Mbps

Ch	Frequency [MHz]	P/M Reading	Cable Loss [dB]	Atten. [dB]	Result	
		AVG			[dBm] AVG	[mW] AVG
1	2412	-0.84	0.63	10.09	9.88	9.73
6	2437	-0.79	0.63	10.09	9.93	9.84
11	2462	-0.84	0.63	10.09	9.88	9.73

Sample Calculation:

Result = Reading + Cable Loss + Attenuator

IEEE802.11n-20 MCS0

Ch	Frequency [MHz]	P/M Reading	Cable Loss [dB]	Atten. [dB]	Result	
		AVG			[dBm] AVG	[mW] AVG
1	2412	-2.73	0.63	10.09	7.99	6.30
6	2437	-2.84	0.63	10.09	7.88	6.14
11	2462	-2.89	0.63	10.09	7.83	6.07

Sample Calculation:

$$\text{Result} = \text{Reading} + \text{Cable Loss} + \text{Attenuator}$$

Correlation of output power with original report(Test report No.: 10133943H-A)

IEEE802.11b 2Mbps (Output power(time average) of original test report)

Ch	Frequency [MHz]	P/M Reading	Cable Loss [dB]	Atten. [dB]	Result [dBm]
		AVG			AVG
1	2412	0.14	0.88	10.00	11.02

IEEE802.11b 2Mbps (This time)

Ch	Frequency [MHz]	P/M Reading	Cable Loss [dB]	Atten. [dB]	Result [dBm]	Deviation
		AVG			AVG	[dB]
1	2412	0.26	0.63	10.09	10.98	-0.04

Sample Calculation:

$$\text{Result} = \text{Reading} + \text{Cable Loss} + \text{Attenuator}$$

5.3 SAR testing operating modes

The operating mode for SAR testing was decided by the output power

Mode	Frequency Band	Test Frequency	Note
WLAN	2412-2462MHz	2412MHz (1 ch) *1	DSSS(11b) *2
<p>*The power value of the EUT was set for testing as follows (setting value might be different from product specification value); Power settings: 11b: 11 Software: WLAN: WLAN-RF-Test-FW-20160615 *This setting of software is the worst case. Any conditions under the normal use do not exceed the condition of setting. In addition, end users cannot change the settings of the output power of the product.</p>			

*1 Highest measured output power channel was tested initially according to KDB248227D01.

The other channel was not required since SAR value of highest measured output power channel was less than 0.8W/kg.

*2 SAR is not required for the following 2.4 GHz OFDM conditions according to KDB248227D01.

When the highest reported SAR for DSSS is adjusted by the ratio of OFDM to DSSS specified maximum output power and the adjusted SAR is ≤ 1.2 W/kg.

5.4 Confirmation after SAR testing

It was checked that the power drift [W] is within +/-5%. The verification of power drift during the SAR test is that DASY5 system calculates the power drift by measuring the e-filed at the same location at beginning and the end of the scan measurement for each test position.

DASY5 system calculation Power drift value[dB] = $20\log(Ea)/(Eb)$

Before SAR testing : $Eb[V/m]$

After SAR testing : $Ea[V/m]$

Limit of power drift[W] = +/-5%

$X[dB]=10\log[P]=10\log(1.05/1)=10\log(1.05)-10\log(1)=0.212dB$

from E-filed relations with power.

$p=E^2/\eta=E^2/$

Therefore, The correlation of power and the E-filed

$XdB=10\log(P)=10\log(E)^2=20\log(E)$

Therefore,

The calculated power drift of DASY5 System must be the less than +/-0.212dB.

SECTION 6 SAR test exclusion considerations

6.1 Standalone SAR test exclusion considerations

The following is based on KDB447498D01.

1) The 1-g and 10-g SAR test exclusion thresholds for 100 MHz to 6 GHz at test separation distances ≤ 50 mm are determined by:

$$[(\text{max. power of channel, including tune-up tolerance, mW})/(\text{min. test separation distance, mm})] \cdot [\sqrt{f(\text{GHz})}] \leq 3.0$$

for 1-g SAR and ≤ 7.5 for 10-g extremity SAR, where

$f(\text{GHz})$ is the RF channel transmit frequency in GHz

Power and distance are rounded to the nearest mW and mm before calculation

The result is rounded to one decimal place for comparison

The test exclusions are applicable only when the minimum test separation distance is ≤ 50 mm and for transmission frequencies between 100 MHz and 6 GHz. When the minimum test separation distance is < 5 mm, a distance of 5 mm is applied to determine SAR test exclusion.

WLAN 2.4GHz

Band	Standalone SAR tested	Position	Mode	Upper frequency of band *1	Maximum tune-up tolerance limit *4	Min distance *2	Calculation of exclusion *3
WLAN	<input checked="" type="checkbox"/>	Top	11b	2462 [MHz] (11ch)	11.04 [dBm] 12.71 [mW] 13 [mW]*5	5.00 [mm]	4.1
WLAN	<input checked="" type="checkbox"/>	Bottom	11b	2462 [MHz] (11ch)	11.04 [dBm] 12.71 [mW] 13 [mW]*5	5.00 [mm]	4.1
WLAN	<input checked="" type="checkbox"/>	Rear	11b	2462 [MHz] (11ch)	11.04 [dBm] 12.71 [mW] 13 [mW]*5	5.00 [mm]	4.1
WLAN	<input checked="" type="checkbox"/>	Left	11b	2462 [MHz] (11ch)	11.04 [dBm] 12.71 [mW] 13 [mW]*5	5.00 [mm]	4.1
WLAN	<input checked="" type="checkbox"/>	Right	11b	2462 [MHz] (11ch)	11.04 [dBm] 12.71 [mW] 13 [mW]*5	5.00 [mm]	4.1
WLAN	<input checked="" type="checkbox"/>	Top tilt	11b	2462 [MHz] (11ch)	11.04 [dBm] 12.71 [mW] 13 [mW]*5	5.00 [mm]	4.1

2) At 100 MHz to 6 GHz and for *test separation distances* > 50 mm, the SAR test exclusion threshold is determined according to the following.

a) [Threshold at 50 mm in step 1) + (test separation distance - 50 mm)·(f(MHz)/150)] mW, at 100MHz to 1500 MHz

b) [Threshold at 50 mm in step 1) + (test separation distance - 50 mm)·10] mW at > 1500 MHz and ≤ 6 GHz

WLAN 2.4GHz

Band	Standalone SAR tested	Position	Mode	Upper frequency of band *1	Maximum tune-up tolerance limit *4	Min distance	Calculation of threshold*6
WLAN	<input type="checkbox"/>	Front	11b	2462 [MHz] (11ch)	11.04 [dBm] 12.71 [mW] 13 [mW]*5	55.4 [mm]	150 [mW]

*1 The upper frequency of the frequency band was used in order to calculate standalone SAR test exclusion considerations.

*2 When the minimum test separation distance is < 5 mm, a distance of 5 mm is applied to determine SAR test exclusion.

Refer to Appendix 4.

*3 [(max. power of channel, including tune-up tolerance, mW)/(min. test separation distance, mm)] · [√f(GHz)] ≤ 3.0

If it is Calculation of exclusion ≤ 3.0 standalone SAR test is excluded.

*4 Maximum tune-up tolerance limit is by the specification from a customer.

*5 Maximum tune-up tolerance limit(mW) is rounded to one decimal place.

*6 [(3·50)/(√f_(GHz))] + (test separation distance - 50 mm)·(f(MHz)/150)] mW at > 100 MHz and ≤ 1500 MHz

[(3·50)/(√f_(GHz))] + (test separation distance - 50 mm)·10] mW at > 1500 MHz and ≤ 6 GHz

If it is maximum tune-up tolerance limit < Threshold, standalone SAR test is excluded.

SECTION 7: Description of the Body setup**7.1 Test position for Body setup****i) Procedure for SAR testing**

-The tested procedure was performed according to the KDB447498 D01 (Mobile and Portable Device RF Exposure Procedures and Equipment Authorization Policies)

ii) Test mode

WLAN 2.4 GHz	Data transmission mode (11b)
--------------	------------------------------

iii) Test position

No.	Position	Test distance	WLAN
			Tested
1	Top	0mm	<input checked="" type="checkbox"/>
2	Bottom	0mm	<input checked="" type="checkbox"/>
3	Front	0mm	<input type="checkbox"/>
4	Rear	0mm	<input checked="" type="checkbox"/>
5	Left	0mm	<input checked="" type="checkbox"/>
6	Right	0mm	<input checked="" type="checkbox"/>
7	Top tilt	0mm	<input checked="" type="checkbox"/>

*The test was conservatively performed with test distance 0mm.

SECTION 8 : Test surrounding

8.1 Measurement uncertainty

This measurement uncertainty budget is suggested by IEEE Std 1528(2013) and IEC62209-2:2010, and determined by Schmid & Partner Engineering AG (DASY5 Uncertainty Budget). Per KDB 865664 D01 SAR Measurement 100 MHz to 6 GHz v01r04 Section 2.8.1., when the highest measured SAR(1g) within a frequency band is < 1.5W/kg, the extensive SAR measurement uncertainty analysis described in IEEE Std.1528 (2013) is not required in SAR reports submitted for equipment approval.

<0.3 – 3GHz range Body>

Error Description	Uncertain value ±	Probability distribution	divisor	(ci) 1g	Standard (1g)
Measurement System					
Probe calibration	± 6.00	Normal	1	1	± 6.00
Axial isotropy of the probe	± 4.7	Rectangular	√3	0.7	± 1.9
Spherical isotropy of the probe	± 9.6	Rectangular	√3	0.7	± 3.9
Boundary effects	± 1.0	Rectangular	√3	1	± 0.6
Probe linearity	± 4.7	Rectangular	√3	1	± 2.7
Detection limit	± 1.0	Rectangular	√3	1	± 0.6
Modulation response	± 2.4	Rectangular	√3	1	± 1.4
Readout electronics	± 0.3	Normal	1	1	± 0.3
Response time	± 0.8	Rectangular	√3	1	± 0.5
Integration time	± 2.6	Rectangular	√3	1	± 1.5
RF ambient Noise	± 3.0	Rectangular	√3	1	± 1.7
RF ambient Reflections	± 3.0	Rectangular	√3	1	± 1.7
Probe Positioner	± 0.4	Rectangular	√3	1	± 0.2
Probe positioning	± 2.9	Rectangular	√3	1	± 1.7
Max.SAR Eval.	± 2.0	Rectangular	√3	1	± 1.2
Test Sample Related					
Device positioning	± 2.9	Normal	1	1	± 2.9
Device holder uncertainty	± 3.6	Normal	1	1	± 3.6
Power drift	± 5.0	Rectangular	√3	1	± 2.9
Power Scaling	+ 0.0	Rectangular	√3	1	± 0.0
Phantom and Setup					
Phantom uncertainty	± 6.1	Rectangular	√3	1	± 3.5
Algorithm for correcting SAR for deviations in permittivity and conductivity	± 1.9	Normal	1	1	± 1.9
Liquid conductivity (meas.)	+ 2.3	Rectangular	1	0.78	+ 1.8
Liquid permittivity (meas.)	- 3.2	Rectangular	1	0.23	- 0.7
Liquid conductivity - temp.unc (below 2deg.C.)	± 5.2	Rectangular	√3	0.78	± 2.3
Liquid permittivity - temp.unc (below 2deg.C.)	± 0.8	Rectangular	√3	0.23	± 0.1
Combined Standard Uncertainty					± 11.426
Expanded Uncertainty (k=2)					± 22.9

*. Table of uncertainties are listed for ISO/IEC 17025.

UL Japan, Inc.

Ise EMC Lab.

4383-326 Asama-cho, Ise-shi, Mie-ken 516-0021 JAPAN

Telephone: +81 596 24 8999

Facsimile: +81 596 24 8124

SECTION 9 : Measurement results

9.1 Body SAR

(1)Method of measurement

- Step.1 The searching for the worst mode.
The test was performed at the low channel.
Step.2 The searching for the worst position. *1*2*3
The test was performed at the worst mode of Step.1.

Note:

*1 Highest measured output power channel was tested initially according to KDB248227D01.

The other channel was not required since SAR value of highest measured output power channel was less than 0.8W/kg.

*2 SAR is not required for the following 2.4 GHz OFDM conditions according to KDB248227D01.

When the highest reported SAR for DSSS is adjusted by the ratio of OFDM to DSSS specified maximum output power and the adjusted SAR is ≤ 1.2 W/kg. Refer to (4) OFDM mode exclusion considerations.

*3 Repeated measurement is not required when the original highest measured SAR is < 0.80 W/kg in accordance to KDB865664 D1.

(2)Simulated Tissue Liquid Parameter confirmation

The dielectric parameters were checked prior to assessment using the DAKS dielectric probe kit.

The dielectric parameters measurement is reported in each correspondent section.

DIELECTRIC PARAMETERS MEASUREMENT RESULTS											
Date	Ambient Temp. [deg.c]	Relative Humidity [%]	Liquid type	Liquid Temp. [deg.c]	Measured Frequency [MHz]	Parameters	Target Value	Measured	Deviation [%]	Limit [%]	Remark
-	-	-	-	-	2000	ϵ_r	53.3	-	-	-	*1
						σ [mho/m]	1.52	-	-	-	
24-Jun	24.0	45	MSL 2450	23.5	2412	ϵ_r	52.8	51.1	-3.2	+/-5	*2
						σ [mho/m]	1.90	1.94	2.3	+/-5	
-	-	-	-	-	2450	ϵ_r	52.7	-	-	-	*1
						σ [mho/m]	1.91	-	-	-	

ϵ_r : Relative Permittivity / σ : Conductivity

*1 The Target value is a parameter defined in KDB 865664D01.

*2 The dielectric parameters should be linearly interpolated between the closest pair of target frequencies to determine the applicable dielectric parameters corresponding to the device test frequency.

(3)Result of Body SAR

SAR MEASUREMENT RESULTS													
Frequency		Modulation	Measured power		Maximum tune-up tolerance limit		Phantom Section	EUT Set-up Conditions			Measured SAR(1g) [W/kg]	Scaled factor *1	Reported SAR(1g) [W/kg] *2
Channel	[MHz]		[dBm]	[mW]	[dBm]	[mW]		Antenna	Position	Separation [mm]			
Step.1 The searching for the worst mode													
1	2412	11b 1Mbps	10.72	11.80	11.04	12.71	Flat	Fixed	Top	0	0.122	1.076	0.131
1	2412	11b 5.5Mbps	11.01	12.62	11.04	12.71	Flat	Fixed	Top	0	0.125	1.007	0.126
Step.2 The searching for the worst position													
1	2412	11b 1Mbps	10.72	11.80	11.04	12.71	Flat	Fixed	Bottom	0	0.0094	1.076	0.0101
1	2412	11b 1Mbps	10.72	11.80	11.04	12.71	Flat	Fixed	Rear	0	0.037	1.076	0.040
1	2412	11b 1Mbps	10.72	11.80	11.04	12.71	Flat	Fixed	Left	0	0.032	1.076	0.034
1	2412	11b 1Mbps	10.72	11.80	11.04	12.71	Flat	Fixed	Right	0	0.164	1.076	0.177
1	2412	11b 1Mbps	10.72	11.80	11.04	12.71	Flat	Fixed	Top tilt	0	0.192	1.076	0.207

*1 Scaled factor = Maximum tune-up tolerance limit [mW] / Measured power [mW]

*2 Reported SAR= Measured SAR [W/kg] · Scaled factor

OFDM mode exclusion considerations

OFDM was excluded from the following table according to KDB248227D01.

Maximum tune-up tolerance limit		Maximum tune-up tolerance limit		OFDM scaled factor *3	Estimated SAR of OFDM Reported SAR(1g) [W/kg] *4	Exclusion limit [W/kg]	Standalone SAR tested
DSSS		OFDM(11g/n20)					
[dBm]	[mW]	[dBm]	[mW]				
11.04	12.71	10.22	10.52	0.828	0.171	< 1.2	<input type="checkbox"/>

*3 OFDM scaled factor = Maximum tune-up tolerance limit of OFDM [mW] / Maximum tune-up tolerance limit of DSSS [mW]

*4 Estimated SAR of OFDM= Reported SAR of DSSS[W/kg] · OFDM scaled factor

SECTION 10 Test instruments

Control No.	Instrument	Manufacturer	Model No	Serial No	Test Item	Calibration Date * Interval(month)
MNA-03	Vector Reflectometer	Copper Mountain Technologies	PLANAR R140	0030913	SAR	2016/04/22 * 12
MDPK-03	Dielectric assessment kit	Schmid&Partner Engineering AG	DAK-3.5	0008	SAR	2016/04/12 * 12
MOS-37	Digital thermometer	LKM electronic	DTM3000	-	SAR	2015/07/07 * 12
COTS-MSAR-04	Dielectric assessment software	Schmid&Partner Engineering AG	DAK		SAR	-
MPM-11	Dual Power Meter	Agilent	E4419B	MY45102060	SAR	2015/08/04 * 12
MPSE-15	Power sensor	Agilent	E9301A	MY41498311	SAR	2015/08/04 * 12
MPSE-16	Power sensor	Agilent	E9301A	MY41498313	SAR	2015/08/04 * 12
MRFA-24	Pre Amplifier	R&K	R&K CGA020M602-2633R	B30550	SAR	2015/06/15 * 12
MSG-10	Signal Generator	Agilent	N5181A	MY47421098	SAR	2015/11/16 * 12
MAT-78	Attenuator	Telegrartner	J01156A0011	0042294119	SAR	Pre Check
MPM-01	Power Meter	Agilent	E4417A	GB41290639	SAR	2016/04/05 * 12
MPSE-01	Power Sensor	Agilent	E9300B	US40010300	SAR	2016/04/05 * 12
MAT-15	Attenuator	Agilent	8498A	US40010300	SAR	2016/04/05 * 12
MHDC-12	Dual Directional Coupler	Hewlett Packard	772D	2839A0016	SAR	Pre Check
MDA-07	Dipole Antenna	Schmid&Partner Engineering AG	D2450V2	713	SAR	2013/09/10 * 36
MDAE-01	Data Acquisition Electronics	Schmid&Partner Engineering AG	DAE4	509	SAR	2015/07/07 * 12
MPB-07	Dosimetric E-Field Probe	Schmid&Partner Engineering AG	EX3DV4	3825	SAR	2015/12/11 * 12
MPF-02	2mm Oval Flat Phantom	Schmid&Partner Engineering AG	QDOVA001BB	1045	SAR	2016/05/07 * 12
MDH-01	Device holder	Schmid&Partner Engineering AG	Mounting device for transmitter	-	SAR	Pre Check
MOS-26	Thermo-Hygrometer	CUSTOM	CTH-201	A08Q29	SAR	2016/04/19 * 12
COTS-MSAR-03	Dasy5	Schmid&Partner Engineering AG	DASY5	-	SAR	-
MRBT-02	SAR robot	Schmid&Partner Engineering AG	TX60 Lspeag	F10/5E3LA1/A/01	SAR	2016/04/30 * 12
MMSL2450	Tissue simulation liquid (Body)	Schmid&Partner Engineering AG	MSL2450V2	SL AA 245 BA	SAR*Daily Check Target Value $\pm 5\%$	Pre Check

The expiration date of the calibration is the end of the expired month.

All equipment is calibrated with valid calibrations. Each measurement data is traceable to the national or international standards.

As for some calibrations performed after the tested dates, those test equipment have been controlled by means of an unbroken chains of calibrations.

SAR room is checked before every testing and ambient noise is <0.012W/kg

UL Japan, Inc.

Ise EMC Lab.

4383-326 Asama-cho, Ise-shi, Mie-ken 516-0021 JAPAN

Telephone: +81 596 24 8999

Facsimile: +81 596 24 8124

APPENDIX 1 : SAR Measurement data

1. Evaluation procedure

The evaluation was performed with the following procedure:

Step 1: Measurement of the E-field at a fixed location above the ear point or central position of flat phantom was used as a reference value for assessing the power drop.

Step 2: The SAR distribution at the exposed side of head or body position was measured at a distance of each device from the inner surface of the shell. The area covered the entire dimension of the antenna of EUT and the horizontal grid spacing was 15 mm x 15 mm, 12 mm x 12 mm or 10mm x 10mm. Based on these data, the area of the maximum absorption was determined by spline interpolation.

Step 3: Around this point found in the Step 2 (area scan), a volume of 30mm x 30mm x 30mm or more was assessed by measuring 7 x 7 x 7 points at least for below 3GHz and a volume of 28 mm x 28mm x 22.5mm or more was assessed by measuring 8 x 8 x 6(ratio step method (*1)) points at least for 5GHz band.

And for any secondary peaks found in the Step2 which are within 2dB of maximum peak and not with this Step3 (Zoom scan) is repeated. On the basis of this data set, the spatial peak SAR value was evaluated under the following procedure:

(1). The data at the surface were extrapolated, since the center of the dipoles is 1mm(EX3DV4) away from the tip of the probe and the distance between the surface and the lowest measuring point is 1.3 mm. The extrapolation was based on a least square algorithm [4]. A polynomial of the fourth order was calculated through the points in z-axes. This polynomial was then used to evaluate the points between the surface and the probe tip.

(2). The maximum interpolated value was searched with a straightforward algorithm. Around this maximum the SAR values averaged over the spatial volumes (1 g or 10 g) were computed by the 3D-Spline interpolation algorithm. The 3D-Spline is composed of three one-dimensional splines with the "Not a knot"-condition (in x, y and z-directions) [4], [5]. The volume was integrated with the trapezoidal-algorithm. One thousand points (10 x 10 x 10) were interpolated to calculate the average.

(3). All neighboring volumes were evaluated until no neighboring volume with a higher average value was found.

Step 4: Re-measurement of the E-field at the same location as in Step 1.

***1. Ratio step method parameters used;**

**The first measurement point: 2mm from the phantom surface, the initial grid separation: 2mm, subsequent graded grid ratio: 1.5
These parameters comply with the requirement of the KDB 865664D01.**

2. Measurement data

WLAN 11b 2412MHz 1Mbps Top 0mm

Communication System: UID 0, WLAN 11a/b/g/n (0); Communication System Band: 11b/g/n (2.4G); Frequency: 2412 MHz; Duty Cycle: 1:1

Medium parameters used (interpolated): $f = 2412$ MHz; $\sigma = 1.944$ S/m; $\epsilon_r = 51.108$; $\rho = 1000$ kg/m³

Phantom section: Flat Section

Measurement Standard: DASY5 (IEEE/IEC/ANSI C63.19-2007)

DASY5 Configuration

Probe: EX3DV4 - SN3825; ConvF(7.29, 7.29, 7.29); Calibrated: 2015/12/11;

Sensor-Surface: 1.4mm (Mechanical Surface Detection)

Electronics: DAE4 Sn509; Calibrated: 2015/07/07

Phantom: ELI v4.0 (20deg probe tilt); Type: QDOVA001BB; Serial: TP:1045

Measurement SW: DASY52, Version 52.8 (8); SEMCAD X Version 14.6.10 (7331)

Area Scan (81x61x1): Interpolated grid: dx=1.200 mm, dy=1.200 mm

Maximum value of SAR (interpolated) = 0.256 W/kg

Zoom Scan (7x7x7)/Cube 0: Measurement grid: dx=5mm, dy=5mm, dz=5mm

Reference Value = 11.34 V/m; Power Drift = 0.10 dB

Peak SAR (extrapolated) = 0.318 W/kg

SAR(1 g) = 0.122 W/kg; SAR(10 g) = 0.047 W/kg

Maximum value of SAR (measured) = 0.233 W/kg

Date: 2016/06/24

Ambient Temp. : 24.0 degree.C. Liquid Temp.; 23.5 degree.C.

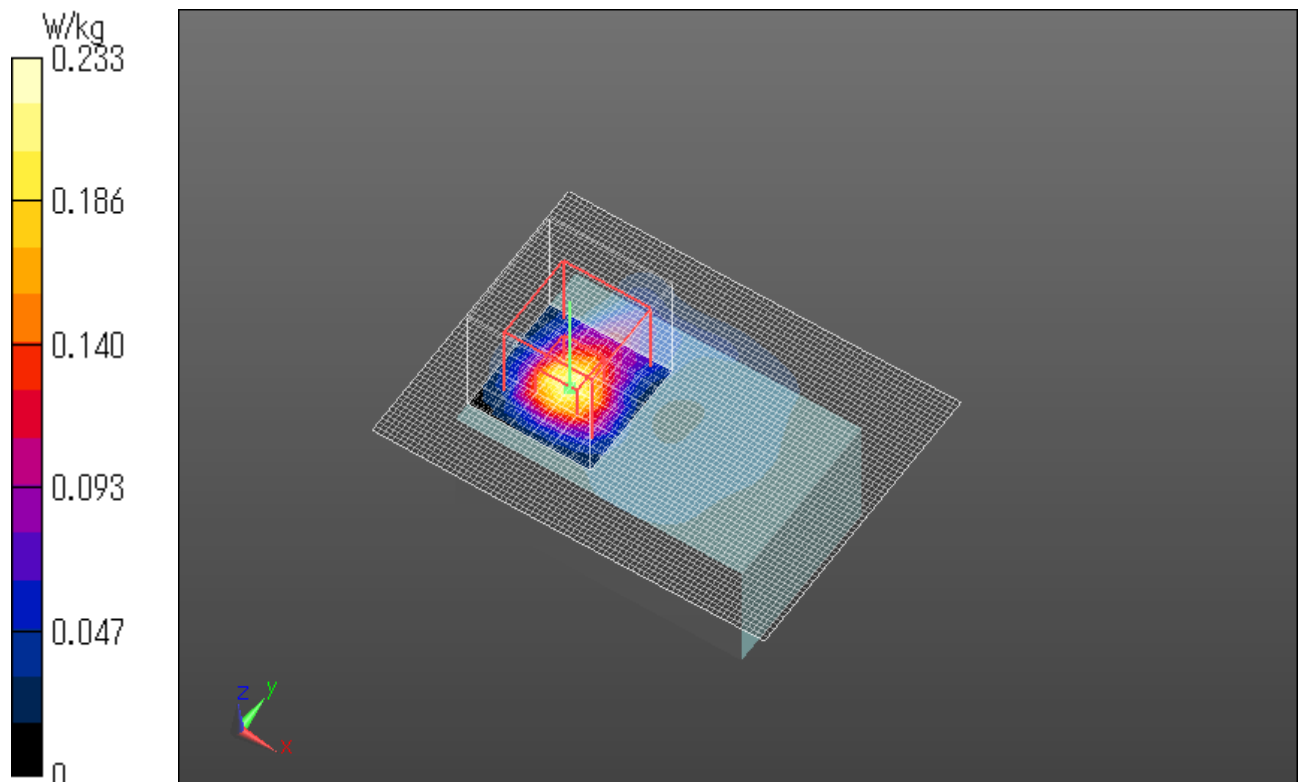

WLAN 11b 2412MHz 5.5Mbps Top 0mm

Communication System: UID 0, WLAN 11a/b/g/n (0); Communication System Band: 11b/g/n (2.4G); Frequency: 2412 MHz; Duty Cycle: 1:1

Medium parameters used (interpolated): $f = 2412$ MHz; $\sigma = 1.944$ S/m; $\epsilon_r = 51.108$; $\rho = 1000$ kg/m³

Phantom section: Flat Section

Measurement Standard: DASYS5 (IEEE/IEC/ANSI C63.19-2007)

DASY5 Configuration

Probe: EX3DV4 - SN3825; ConvF(7.29, 7.29, 7.29); Calibrated: 2015/12/11;

Sensor-Surface: 1.4mm (Mechanical Surface Detection)

Electronics: DAE4 Sn509; Calibrated: 2015/07/07

Phantom: ELI v4.0 (20deg probe tilt); Type: QDOVA001BB; Serial: TP:1045

Measurement SW: DASYS52, Version 52.8 (8); SEMCAD X Version 14.6.10 (7331)

Area Scan (81x61x1): Interpolated grid: dx=1.200 mm, dy=1.200 mm

Maximum value of SAR (interpolated) = 0.269 W/kg

Zoom Scan (7x7x7)/Cube 0: Measurement grid: dx=5mm, dy=5mm, dz=5mm

Reference Value = 11.53 V/m; Power Drift = -0.07 dB

Peak SAR (extrapolated) = 0.328 W/kg

SAR(1 g) = 0.125 W/kg; SAR(10 g) = 0.049 W/kg

Maximum value of SAR (measured) = 0.239 W/kg

Date: 2016/06/24

Ambient Temp. : 24.0 degree.C. Liquid Temp.; 23.5 degree.C.

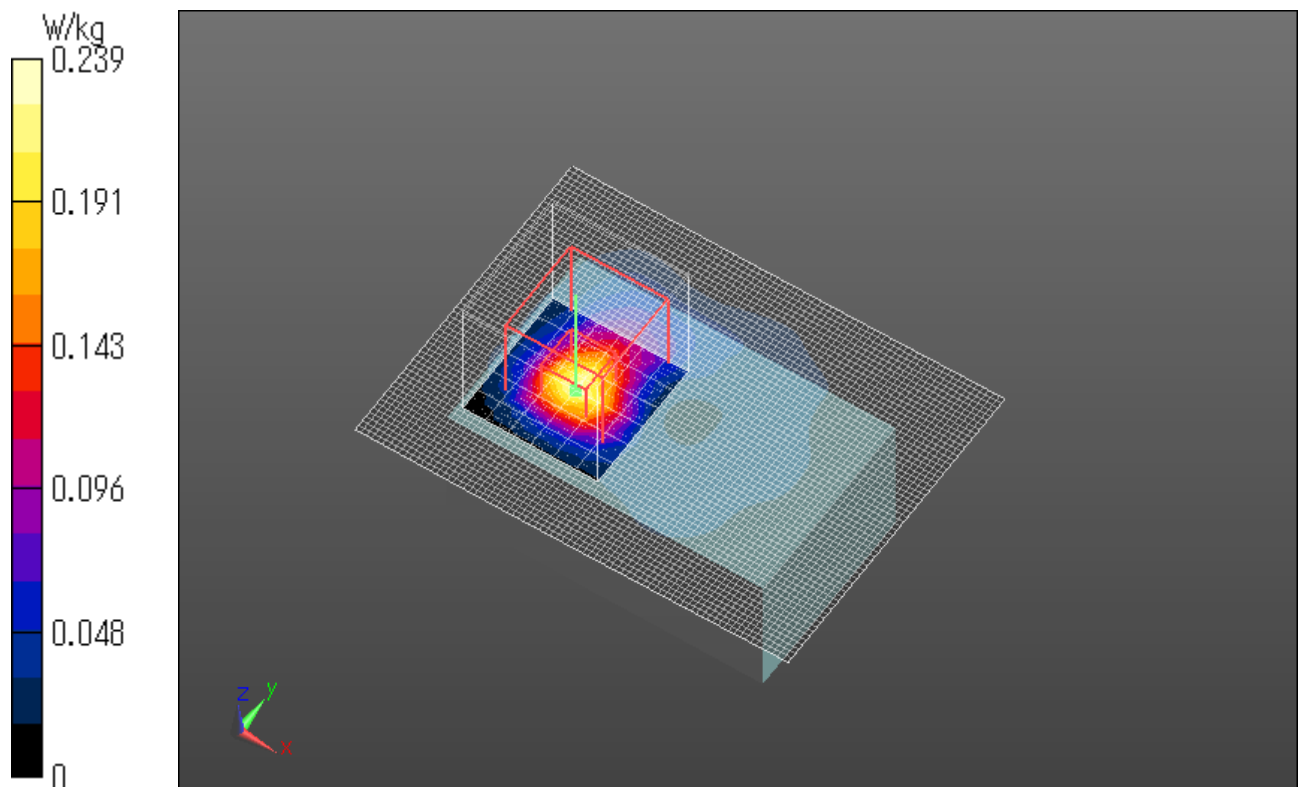

WLAN 11b 2412MHz 1Mbps Bottom 0mm

Communication System: UID 0, WLAN 11a/b/g/n (0); Communication System Band: 11b/g/n (2.4G); Frequency: 2412 MHz; Duty Cycle: 1:1

Medium parameters used (interpolated): $f = 2412$ MHz; $\sigma = 1.944$ S/m; $\epsilon_r = 51.108$; $\rho = 1000$ kg/m³

Phantom section: Flat Section

Measurement Standard: DASYS5 (IEEE/IEC/ANSI C63.19-2007)

DASY5 Configuration

Probe: EX3DV4 - SN3825; ConvF(7.29, 7.29, 7.29); Calibrated: 2015/12/11;

Sensor-Surface: 1.4mm (Mechanical Surface Detection)

Electronics: DAE4 Sn509; Calibrated: 2015/07/07

Phantom: ELI v4.0 (20deg probe tilt); Type: QDOVA001BB; Serial: TP:1045

Measurement SW: DASYS5, Version 52.8 (8); SEMCAD X Version 14.6.10 (7331)

Area Scan (81x61x1): Interpolated grid: dx=1.200 mm, dy=1.200 mm

Maximum value of SAR (interpolated) = 0.0206 W/kg

Zoom Scan (7x7x7)/Cube 0: Measurement grid: dx=5mm, dy=5mm, dz=5mm

Reference Value = 3.077 V/m; Power Drift = -0.17 dB

Peak SAR (extrapolated) = 0.0300 W/kg

SAR(1 g) = 0.0094 W/kg; SAR(10 g) = 0.00303 W/kg

Maximum value of SAR (measured) = 0.0180 W/kg

Date: 2016/06/24

Ambient Temp. : 24.0 degree.C. Liquid Temp.; 23.5 degree.C.

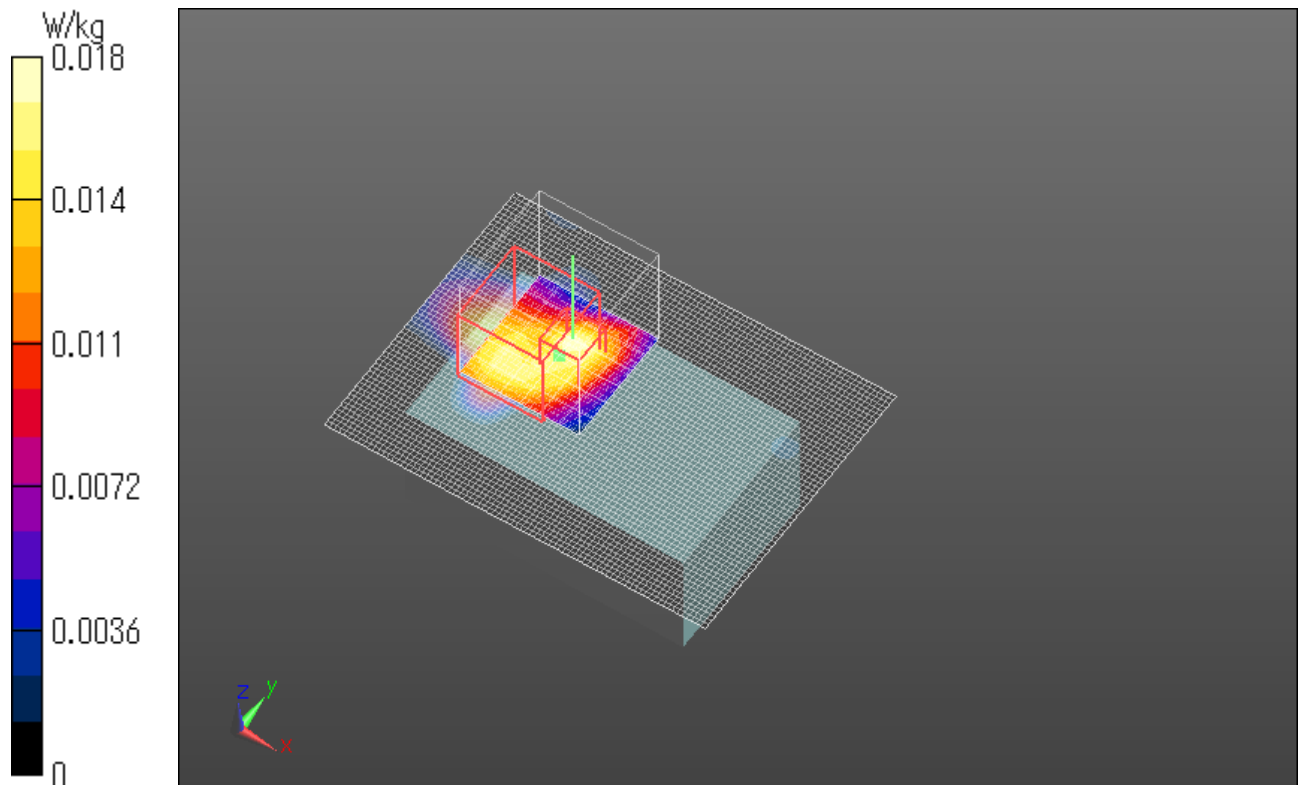

WLAN 11b 2412MHz 1Mbps Rear 0mm

Communication System: UID 0, WLAN 11a/b/g/n (0); Communication System Band: 11b/g/n (2.4G); Frequency: 2412 MHz; Duty Cycle: 1:1

Medium parameters used (interpolated): $f = 2412$ MHz; $\sigma = 1.944$ S/m; $\epsilon_r = 51.108$; $\rho = 1000$ kg/m³

Phantom section: Flat Section

Measurement Standard: DASYS5 (IEEE/IEC/ANSI C63.19-2007)

DASY5 Configuration

Probe: EX3DV4 - SN3825; ConvF(7.29, 7.29, 7.29); Calibrated: 2015/12/11;

Sensor-Surface: 1.4mm (Mechanical Surface Detection)

Electronics: DAE4 Sn509; Calibrated: 2015/07/07

Phantom: ELI v4.0 (20deg probe tilt); Type: QDOVA001BB; Serial: TP:1045

Measurement SW: DASYS5, Version 52.8 (8); SEMCAD X Version 14.6.10 (7331)

Area Scan (51x61x1): Interpolated grid: dx=1.200 mm, dy=1.200 mm

Maximum value of SAR (interpolated) = 0.0770 W/kg

Zoom Scan (7x7x7)/Cube 0: Measurement grid: dx=5mm, dy=5mm, dz=5mm

Reference Value = 5.802 V/m; Power Drift = -0.14 dB

Peak SAR (extrapolated) = 0.0810 W/kg

SAR(1 g) = 0.037 W/kg; SAR(10 g) = 0.017 W/kg

Maximum value of SAR (measured) = 0.0614 W/kg

Date: 2016/06/24

Ambient Temp. : 24.0 degree.C. Liquid Temp.; 23.5 degree.C.

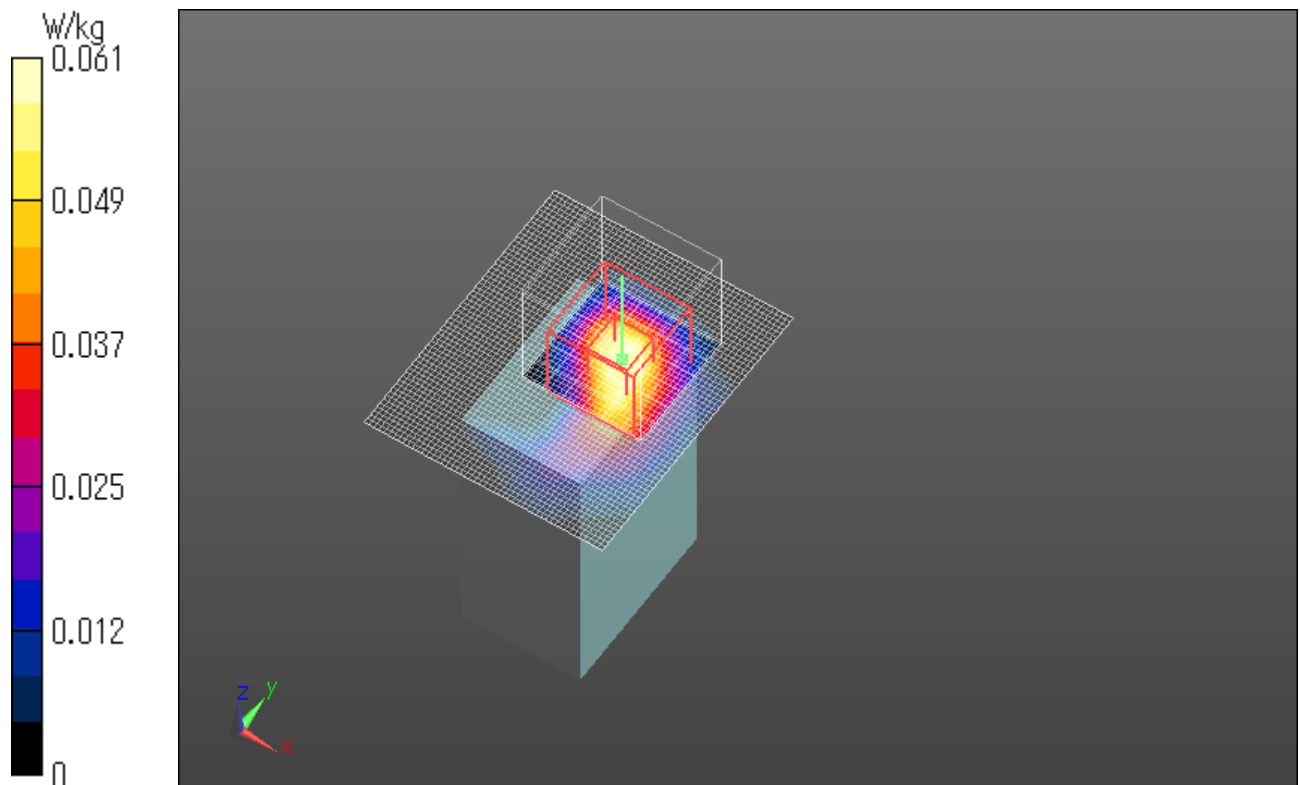

WLAN 11b 2412MHz 1Mbps Left 0mm

Communication System: UID 0, WLAN 11a/b/g/n (0); Communication System Band: 11b/g/n (2.4G); Frequency: 2412 MHz; Duty Cycle: 1:1

Medium parameters used (interpolated): $f = 2412$ MHz; $\sigma = 1.944$ S/m; $\epsilon_r = 51.108$; $\rho = 1000$ kg/m³

Phantom section: Flat Section

Measurement Standard: DASY5 (IEEE/IEC/ANSI C63.19-2007)

DASY5 Configuration

Probe: EX3DV4 - SN3825; ConvF(7.29, 7.29, 7.29); Calibrated: 2015/12/11;

Sensor-Surface: 1.4mm (Mechanical Surface Detection)

Electronics: DAE4 Sn509; Calibrated: 2015/07/07

Phantom: ELI v4.0 (20deg probe tilt); Type: QDOVA001BB; Serial: TP:1045

Measurement SW: DASY52, Version 52.8 (8); SEMCAD X Version 14.6.10 (7331)

Area Scan (81x61x1): Interpolated grid: dx=1.200 mm, dy=1.200 mm

Maximum value of SAR (interpolated) = 0.0765 W/kg

Zoom Scan (7x7x7)/Cube 0: Measurement grid: dx=5mm, dy=5mm, dz=5mm

Reference Value = 5.569 V/m; Power Drift = -0.08 dB

Peak SAR (extrapolated) = 0.107 W/kg

SAR(1 g) = 0.032 W/kg; SAR(10 g) = 0.012 W/kg

Maximum value of SAR (measured) = 0.0673 W/kg

Date: 2016/06/24

Ambient Temp. : 24.0 degree.C. Liquid Temp.; 23.5 degree.C.

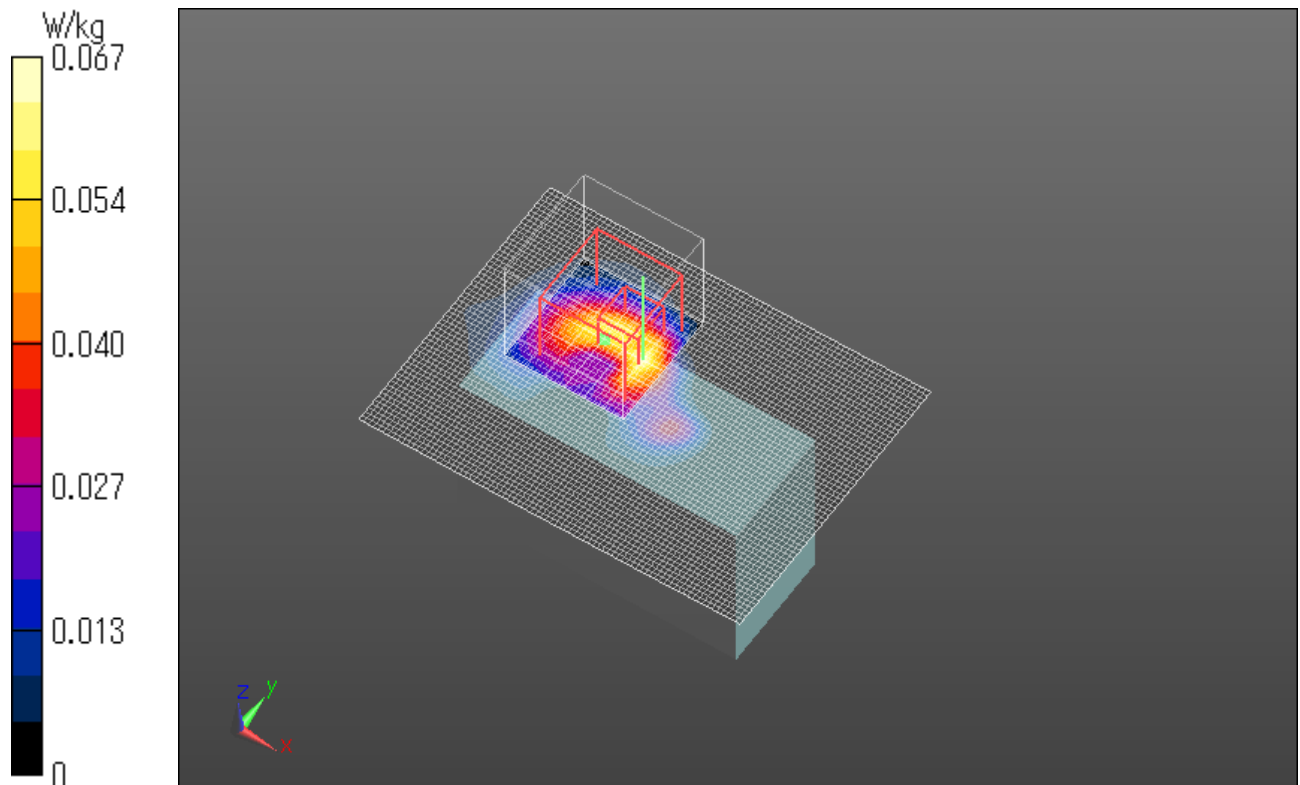

WLAN 11b 2412MHz 1Mbps Right 0mm

Communication System: UID 0, WLAN 11a/b/g/n (0); Communication System Band: 11b/g/n (2.4G); Frequency: 2412 MHz; Duty Cycle: 1:1

Medium parameters used (interpolated): $f = 2412$ MHz; $\sigma = 1.944$ S/m; $\epsilon_r = 51.108$; $\rho = 1000$ kg/m³

Phantom section: Flat Section

Measurement Standard: DASYS (IEEE/IEC/ANSI C63.19-2007)

DASY5 Configuration

Probe: EX3DV4 - SN3825; ConvF(7.29, 7.29, 7.29); Calibrated: 2015/12/11;

Sensor-Surface: 1.4mm (Mechanical Surface Detection)

Electronics: DAE4 Sn509; Calibrated: 2015/07/07

Phantom: ELI v4.0 (20deg probe tilt); Type: QDOVA001BB; Serial: TP:1045

Measurement SW: DASYS2, Version 52.8 (8); SEMCAD X Version 14.6.10 (7331)

Area Scan (81x61x1): Interpolated grid: dx=1.200 mm, dy=1.200 mm

Maximum value of SAR (interpolated) = 0.337 W/kg

Zoom Scan (7x7x7)/Cube 0: Measurement grid: dx=5mm, dy=5mm, dz=5mm

Reference Value = 13.34 V/m; Power Drift = -0.02 dB

Peak SAR (extrapolated) = 0.447 W/kg

SAR(1 g) = 0.164 W/kg; SAR(10 g) = 0.059 W/kg

Maximum value of SAR (measured) = 0.329 W/kg

Date: 2016/06/24

Ambient Temp. : 24.0 degree.C. Liquid Temp.; 23.5 degree.C.

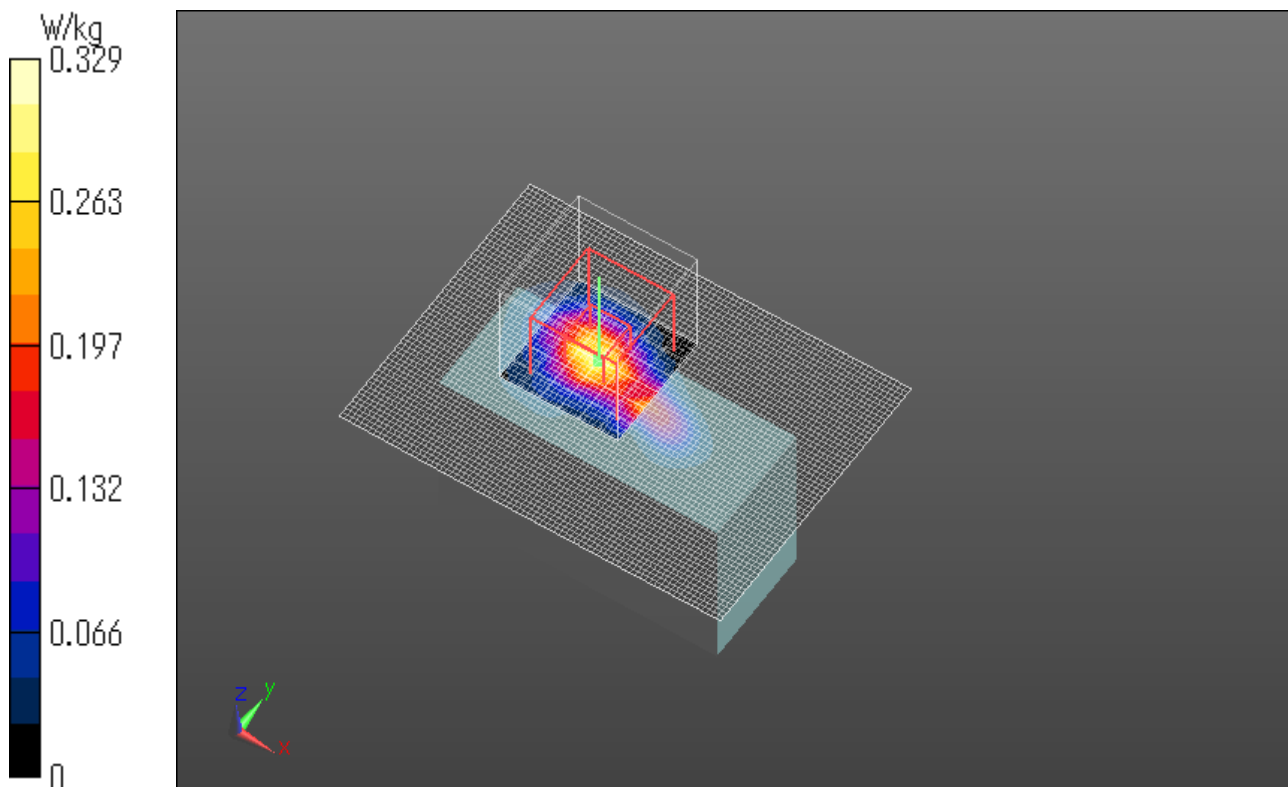

WLAN 11b 2412MHz 1Mbps Top tilt1 0mm

Communication System: UID 0, WLAN 11a/b/g/n (0); Communication System Band: 11b/g/n (2.4G); Frequency: 2412 MHz; Duty Cycle: 1:1

Medium parameters used (interpolated): $f = 2412$ MHz; $\sigma = 1.944$ S/m; $\epsilon_r = 51.108$; $\rho = 1000$ kg/m³

Phantom section: Flat Section

Measurement Standard: DASYS (IEEE/IEC/ANSI C63.19-2007)

DASY5 Configuration

Probe: EX3DV4 - SN3825; ConvF(7.29, 7.29, 7.29); Calibrated: 2015/12/11;

Sensor-Surface: 1.4mm (Mechanical Surface Detection)

Electronics: DAE4 Sn509; Calibrated: 2015/07/07

Phantom: ELI v4.0 (20deg probe tilt); Type: QDOVA001BB; Serial: TP:1045

Measurement SW: DASYS2, Version 52.8 (8); SEMCAD X Version 14.6.10 (7331)

Area Scan (81x61x1): Interpolated grid: $dx=1.200$ mm, $dy=1.200$ mm

Maximum value of SAR (interpolated) = 0.475 W/kg

Zoom Scan (7x7x7)/Cube 0: Measurement grid: $dx=5$ mm, $dy=5$ mm, $dz=5$ mm

Reference Value = 14.35 V/m; Power Drift = -0.11 dB

Peak SAR (extrapolated) = 0.506 W/kg

SAR(1 g) = 0.192 W/kg; SAR(10 g) = 0.071 W/kg

Maximum value of SAR (measured) = 0.367 W/kg

Date: 2016/06/24

Ambient Temp. : 24.0 degree.C. Liquid Temp.; 23.5 degree.C.

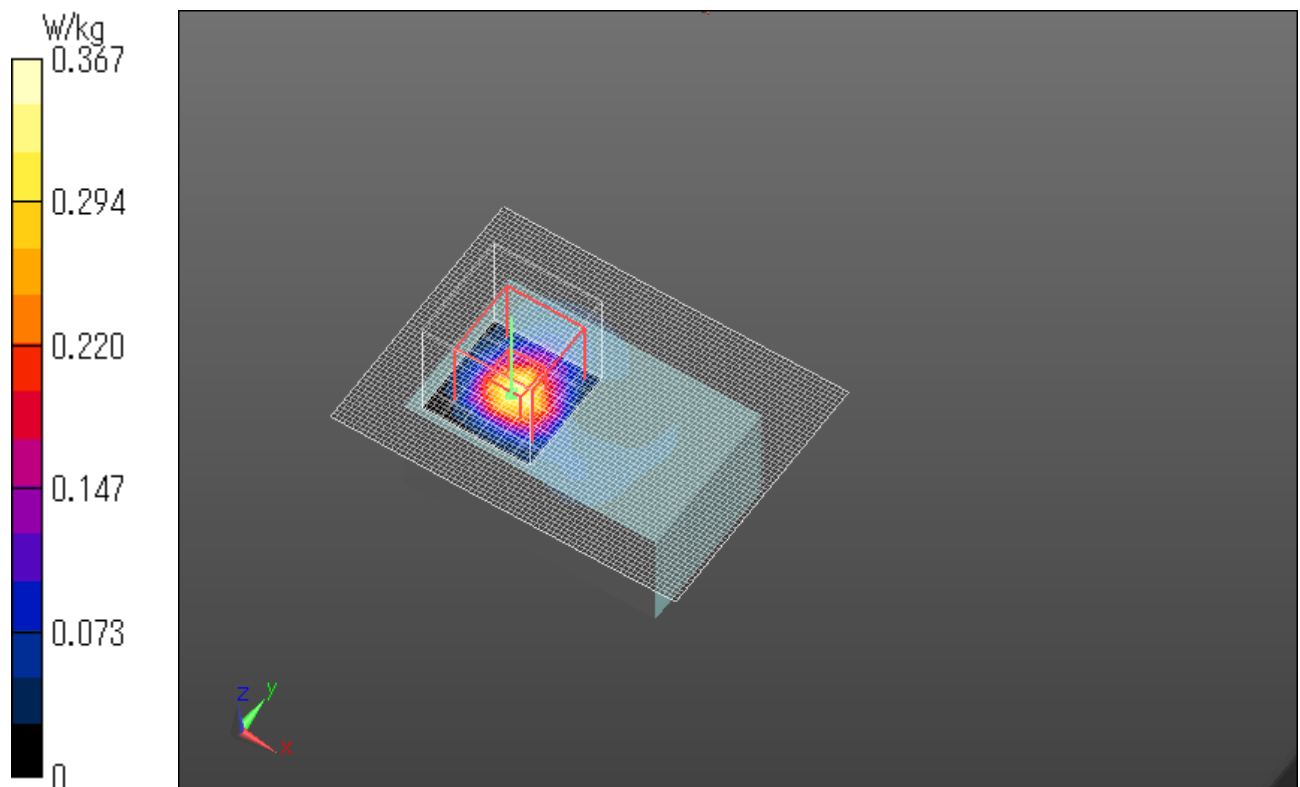

APPENDIX2 : System Check

1. System check result Body 2450MHz

(1) Simulated Tissue Liquid Parameter confirmation

DIELECTRIC PARAMETERS MEASUREMENT RESULTS											
Date	Ambient Temp. [deg.c]	Relative Humidity [%]	Liquid type	Liquid Temp. [deg.c]	Measured Frequency [MHz]	Parameters	Target Value	Measured	Deviation [%]	Limit [%]	Remark
24-Jun	24.0	45	MSL 2450	23.5	2450	ϵ_r	52.7	51.0	-3.3	+/-5	*1
						σ [mho/m]	1.95	2.00	2.4	+/-5	

ϵ_r : Relative Permittivity / σ : Conductivity

*1 The Target value is a parameter defined in KDB 865664D01.

DIELECTRIC PARAMETERS MEASUREMENT RESULTS											
Date	Ambient Temp. [deg.c]	Relative Humidity [%]	Liquid type	Liquid Temp. [deg.c]	Measured Frequency [MHz]	Parameters	Target Value	Measured	Deviation [%]	Limit [%]	Remark
24-Jun	24.0	45	MSL 2450	23.5	2450	ϵ_r	52.2	51.0	-2.4	+/-6	*2 *3
						σ [mho/m]	2.00	2.00	-0.2	+/-6	

ϵ_r : Relative Permittivity / σ : Conductivity

*2 The target value is the calibrated dipole Body TSL parameters. (D2450V2 SN:713, Measured Body TSL parameters)

*3 The limit is for deviation provided by manufacture.

(2) System check result (for calibration by manufacture)

SYSTEM CHECK									
Date	Frequency [MHz]	SAR 1g [W/kg]				Target Value(1W)	Deviation [%]	Limit [%]	Remark
		Forward Power		Conversion 1W					
		Measured		Calculation					
24-Jun	2450.00	13.60		54.40		50.40	7.9	+/-10	*4

*4 The target value is the parameter defined in SAR measured x4(12.6 x 4 = 50.4) in manufacturer calibrated dipole (D2450V2 SN:713)

Please refer to " SAR result with Body TSL of Appendix 2 2. System Check Dipole (D2450V2 SN:713)".

BODY 2450MHz System Check DATA / Dipole 2450MHz / Forward Conducted Power : 250mW

Communication System: UID 0, CW (0); Communication System Band: D2450 (2450.0 MHz); Frequency: 2450 MHz;
Duty Cycle: 1:1

Medium parameters used: $f = 2450$ MHz; $\sigma = 1.996$ S/m; $\epsilon_r = 50.958$; $\rho = 1000$ kg/m³

Phantom section: Flat Section

Measurement Standard: DASY5 (IEEE/IEC/ANSI C63.19-2007)

DASY5 Configuration

Probe: EX3DV4 - SN3825; ConvF(7.29, 7.29, 7.29); Calibrated: 2015/12/11;

Sensor-Surface: 1.4mm (Mechanical Surface Detection)

Electronics: DAE4 Sn509; Calibrated: 2015/07/07

Phantom: ELI v4.0 (20deg probe tilt); Type: QDOVA001BB; Serial: TP:1045

Measurement SW: DASY52, Version 52.8 (8); SEMCAD X Version 14.6.10 (7331)

Area Scan (61x61x1): Interpolated grid: dx=1.500 mm, dy=1.500 mm

Maximum value of SAR (interpolated) = 22.9 W/kg

Zoom Scan (7x7x7)/Cube 0: Measurement grid: dx=5mm, dy=5mm, dz=5mm

Reference Value = 105.4 V/m; Power Drift = 0.02 dB

Peak SAR (extrapolated) = 28.9 W/kg

SAR(1 g) = 13.6 W/kg; SAR(10 g) = 6.19 W/kg

Maximum value of SAR (measured) = 23.0 W/kg

Date: 2016/06/24

Ambient Temp. : 24.0 degree.C. Liquid Temp.; 23.5 degree.C.

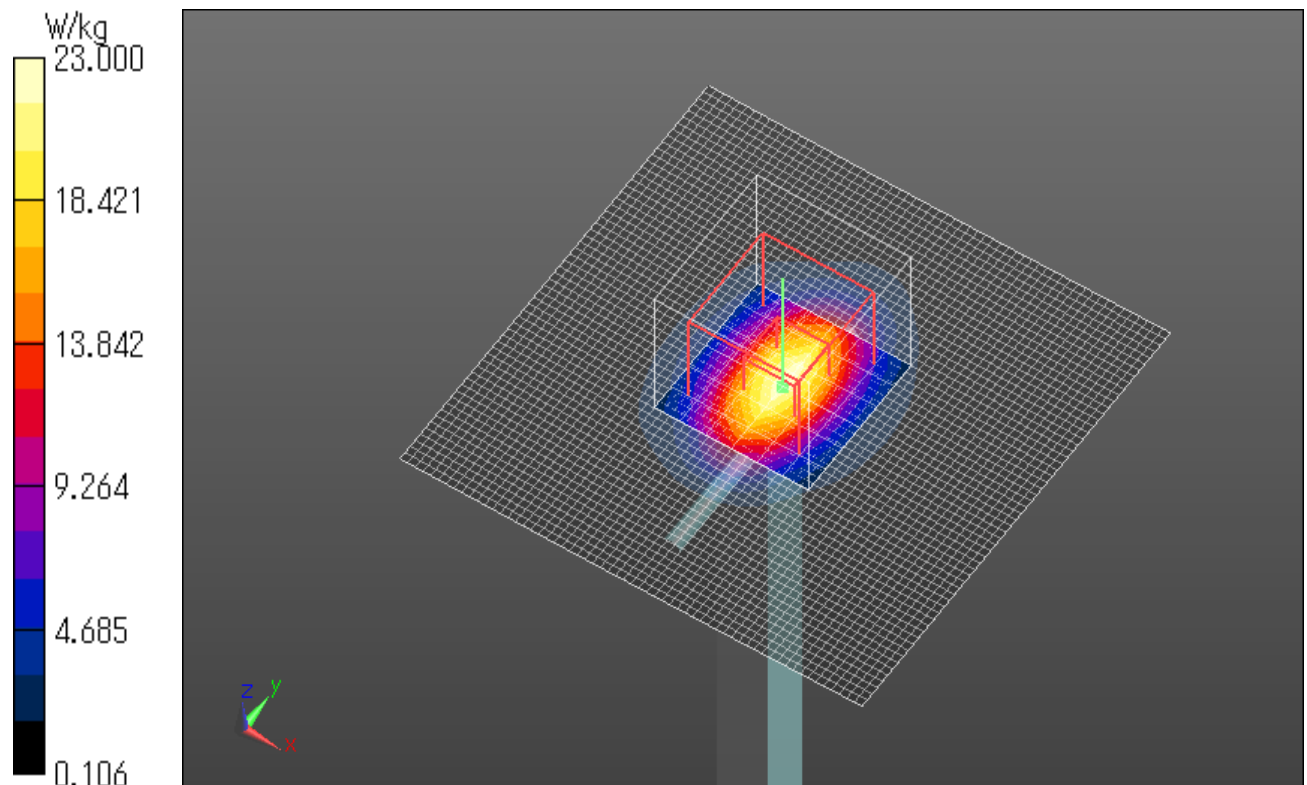

BODY 2450MHz System Check DATA / Dipole 2450MHz / Forward Conducted Power : 250mW

Communication System: UID 0, CW (0); Communication System Band: D2450 (2450.0 MHz); Frequency: 2450 MHz; Duty Cycle: 1:1

Medium parameters used: $f = 2450$ MHz; $\sigma = 1.996$ S/m; $\epsilon_r = 50.958$; $\rho = 1000$ kg/m³

Phantom section: Flat Section

Measurement Standard: DASYS (IEEE/IEC/ANSI C63.19-2007)

DASY5 Configuration

Probe: EX3DV4 - SN3825; ConvF(7.29, 7.29, 7.29); Calibrated: 2015/12/11;

Sensor-Surface: 0mm (Fix Surface)

Electronics: DAE4 Sn509; Calibrated: 2015/07/07

Phantom: ELI v4.0 (20deg probe tilt); Type: QDOVA001BB; Serial: TP:1045

Measurement SW: DASYS2, Version 52.8 (8); SEMCAD X Version 14.6.10 (7331)

Z Scan (1x1x31): Measurement grid: dx=20mm, dy=20mm, dz=5mm

Maximum value of SAR (measured) = 0.147 W/kg

Date: 2016/06/24

Ambient Temp. : 24.0 degree.C. Liquid Temp.; 23.5 degree.C.

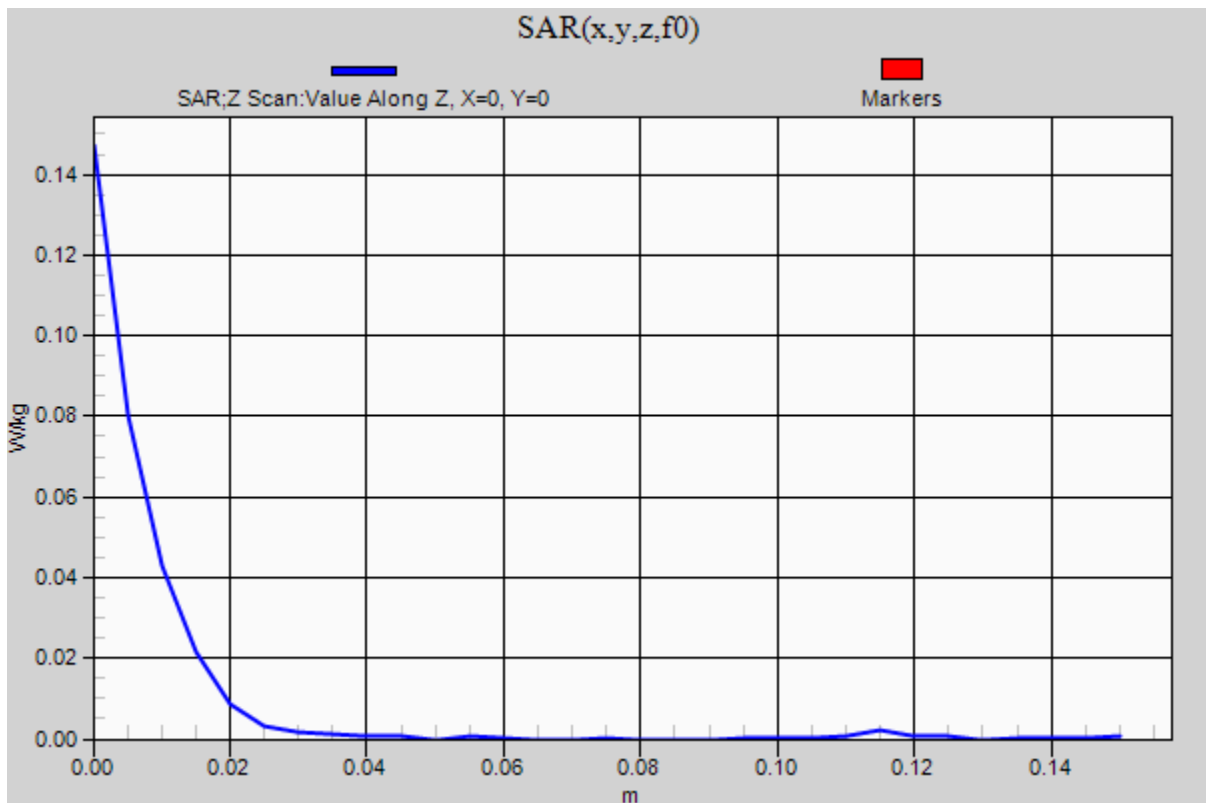

2. System Check Dipole (D2450V2,S/N:713) SAR Calibration Certificate - Dipole 2450MHz

Calibration Laboratory of
Schmid & Partner
Engineering AG
Zeughausstrasse 43, 8004 Zurich, Switzerland



S Schweizerischer Kalibrierdienst
C Service suisse d'étalonnage
S Servizio svizzero di taratura
S Swiss Calibration Service

Accredited by the Swiss Accreditation Service (SAS)
The Swiss Accreditation Service is one of the signatories to the EA
Multilateral Agreement for the recognition of calibration certificates

Accreditation No.: SCS 108

Client **UL Japan (PTT)**

Certificate No: **D2450V2-713_Sep13**

CALIBRATION CERTIFICATE

Object **D2450V2 - SN: 713**

Calibration procedure(s) **QA CAL-05.v9
Calibration procedure for dipole validation kits above 700 MHz**

Calibration date: **September 10, 2013**

This calibration certificate documents the traceability to national standards, which realize the physical units of measurements (SI).
The measurements and the uncertainties with confidence probability are given on the following pages and are part of the certificate.

All calibrations have been conducted in the closed laboratory facility: environment temperature (22 ± 3)°C and humidity < 70%.

Calibration Equipment used (M&TE critical for calibration)

Primary Standards	ID #	Cal Date (Certificate No.)	Scheduled Calibration
Power meter EPM-442A	GB37480704	01-Nov-12 (No. 217-01640)	Oct-13
Power sensor HP 8481A	US37292783	01-Nov-12 (No. 217-01640)	Oct-13
Reference 20 dB Attenuator	SN: 5058 (20k)	04-Apr-13 (No. 217-01736)	Apr-14
Type-N mismatch combination	SN: 5047.3 / 06327	04-Apr-13 (No. 217-01739)	Apr-14
Reference Probe ES3DV3	SN: 3205	28-Dec-12 (No. ES3-3205_Dec12)	Dec-13
DAE4	SN: 601	25-Apr-13 (No. DAE4-601_Apr13)	Apr-14
Secondary Standards	ID #	Check Date (in house)	Scheduled Check
Power sensor HP 8481A	MY41092317	18-Oct-02 (in house check Oct-11)	In house check: Oct-13
RF generator R&S SMT-06	100005	04-Aug-99 (in house check Oct-11)	In house check: Oct-13
Network Analyzer HP 8753E	US37390585 S4206	18-Oct-01 (in house check Oct-12)	In house check: Oct-13

Calibrated by:	Name Israa El-Naouq	Function Laboratory Technician	Signature
Approved by:	Katja Pokovic	Technical Manager	

Issued: September 10, 2013

This calibration certificate shall not be reproduced except in full without written approval of the laboratory.

**Calibration Laboratory of
Schmid & Partner
Engineering AG**
Zeughausstrasse 43, 8004 Zurich, Switzerland



S Schweizerischer Kalibrierdienst
C Service suisse d'étalonnage
S Servizio svizzero di taratura
S Swiss Calibration Service

Accredited by the Swiss Accreditation Service (SAS)
The Swiss Accreditation Service is one of the signatories to the EA
Multilateral Agreement for the recognition of calibration certificates

Accreditation No.: **SCS 108**

Glossary:

TSL	tissue simulating liquid
ConvF	sensitivity in TSL / NORM x,y,z
N/A	not applicable or not measured

Calibration is Performed According to the Following Standards:

- IEEE Std 1528-2003, "IEEE Recommended Practice for Determining the Peak Spatial-Averaged Specific Absorption Rate (SAR) in the Human Head from Wireless Communications Devices: Measurement Techniques", December 2003
- IEC 62209-1, "Procedure to measure the Specific Absorption Rate (SAR) for hand-held devices used in close proximity to the ear (frequency range of 300 MHz to 3 GHz)", February 2005
- KDB 865664, "SAR Measurement Requirements for 100 MHz to 6 GHz"

Additional Documentation:

- DASY4/5 System Handbook

Methods Applied and Interpretation of Parameters:

- Measurement Conditions:* Further details are available from the Validation Report at the end of the certificate. All figures stated in the certificate are valid at the frequency indicated.
- Antenna Parameters with TSL:* The dipole is mounted with the spacer to position its feed point exactly below the center marking of the flat phantom section, with the arms oriented parallel to the body axis.
- Feed Point Impedance and Return Loss:* These parameters are measured with the dipole positioned under the liquid filled phantom. The impedance stated is transformed from the measurement at the SMA connector to the feed point. The Return Loss ensures low reflected power. No uncertainty required.
- Electrical Delay:* One-way delay between the SMA connector and the antenna feed point. No uncertainty required.
- SAR measured:* SAR measured at the stated antenna input power.
- SAR normalized:* SAR as measured, normalized to an input power of 1 W at the antenna connector.
- SAR for nominal TSL parameters:* The measured TSL parameters are used to calculate the nominal SAR result.

The reported uncertainty of measurement is stated as the standard uncertainty of measurement multiplied by the coverage factor $k=2$, which for a normal distribution corresponds to a coverage probability of approximately 95%.

Measurement Conditions

DASY system configuration, as far as not given on page 1.

DASY Version	DASY5	V52.8.7
Extrapolation	Advanced Extrapolation	
Phantom	Modular Flat Phantom	
Distance Dipole Center - TSL	10 mm	with Spacer
Zoom Scan Resolution	dx, dy, dz = 5 mm	
Frequency	2450 MHz \pm 1 MHz	

Head TSL parameters

The following parameters and calculations were applied.

	Temperature	Permittivity	Conductivity
Nominal Head TSL parameters	22.0 °C	39.2	1.80 mho/m
Measured Head TSL parameters	(22.0 \pm 0.2) °C	39.4 \pm 6 %	1.83 mho/m \pm 6 %
Head TSL temperature change during test	< 0.5 °C	---	----

SAR result with Head TSL

SAR averaged over 1 cm ³ (1 g) of Head TSL	Condition	
SAR measured	250 mW input power	13.0 W/kg
SAR for nominal Head TSL parameters	normalized to 1W	51.6 W/kg \pm 17.0 % (k=2)

SAR averaged over 10 cm ³ (10 g) of Head TSL	condition	
SAR measured	250 mW input power	6.05 W/kg
SAR for nominal Head TSL parameters	normalized to 1W	24.1 W/kg \pm 16.5 % (k=2)

Body TSL parameters

The following parameters and calculations were applied.

	Temperature	Permittivity	Conductivity
Nominal Body TSL parameters	22.0 °C	52.7	1.95 mho/m
Measured Body TSL parameters	(22.0 \pm 0.2) °C	52.2 \pm 6 %	2.00 mho/m \pm 6 %
Body TSL temperature change during test	< 0.5 °C	---	----

SAR result with Body TSL

SAR averaged over 1 cm ³ (1 g) of Body TSL	Condition	
SAR measured	250 mW input power	12.6 W/kg
SAR for nominal Body TSL parameters	normalized to 1W	49.7 W/kg \pm 17.0 % (k=2)

SAR averaged over 10 cm ³ (10 g) of Body TSL	condition	
SAR measured	250 mW input power	5.89 W/kg
SAR for nominal Body TSL parameters	normalized to 1W	23.4 W/kg \pm 16.5 % (k=2)

Appendix**Antenna Parameters with Head TSL**

Impedance, transformed to feed point	51.8 Ω + 0.7 j Ω
Return Loss	- 34.4 dB

Antenna Parameters with Body TSL

Impedance, transformed to feed point	48.7 Ω + 2.8 j Ω
Return Loss	- 30.0 dB

General Antenna Parameters and Design

Electrical Delay (one direction)	1.162 ns
----------------------------------	----------

After long term use with 100W radiated power, only a slight warming of the dipole near the feedpoint can be measured.

The dipole is made of standard semirigid coaxial cable. The center conductor of the feeding line is directly connected to the second arm of the dipole. The antenna is therefore short-circuited for DC-signals. On some of the dipoles, small end caps are added to the dipole arms in order to improve matching when loaded according to the position as explained in the "Measurement Conditions" paragraph. The SAR data are not affected by this change. The overall dipole length is still according to the Standard.

No excessive force must be applied to the dipole arms, because they might bend or the soldered connections near the feedpoint may be damaged.

Additional EUT Data

Manufactured by	SPEAG
Manufactured on	July 05, 2002

DASY5 Validation Report for Head TSL

Date: 10.09.2013

Test Laboratory: SPEAG, Zurich, Switzerland

DUT: Dipole 2450 MHz; Type: D2450V2; Serial: D2450V2 - SN: 713

Communication System: UID 0 - CW; Frequency: 2450 MHz

Medium parameters used: $f = 2450$ MHz; $\sigma = 1.83$ S/m; $\epsilon_r = 39.4$; $\rho = 1000$ kg/m³

Phantom section: Flat Section

Measurement Standard: DASY5 (IEEE/IEC/ANSI C63.19-2007)

DASY52 Configuration:

- Probe: ES3DV3 - SN3205; ConvF(4.52, 4.52, 4.52); Calibrated: 28.12.2012;
- Sensor-Surface: 3mm (Mechanical Surface Detection)
- Electronics: DAE4 Sn601; Calibrated: 25.04.2013
- Phantom: Flat Phantom 5.0 (front); Type: QD000P50AA; Serial: 1001
- DASY52 52.8.7(1137); SEMCAD X 14.6.10(7164)

Dipole Calibration for Head Tissue/Pin=250 mW, d=10mm/Zoom Scan (7x7x7)/Cube 0:

Measurement grid: dx=5mm, dy=5mm, dz=5mm

Reference Value = 94.095 V/m; Power Drift = 0.04 dB

Peak SAR (extrapolated) = 26.7 W/kg

SAR(1 g) = 13 W/kg; SAR(10 g) = 6.05 W/kg

Maximum value of SAR (measured) = 17.0 W/kg

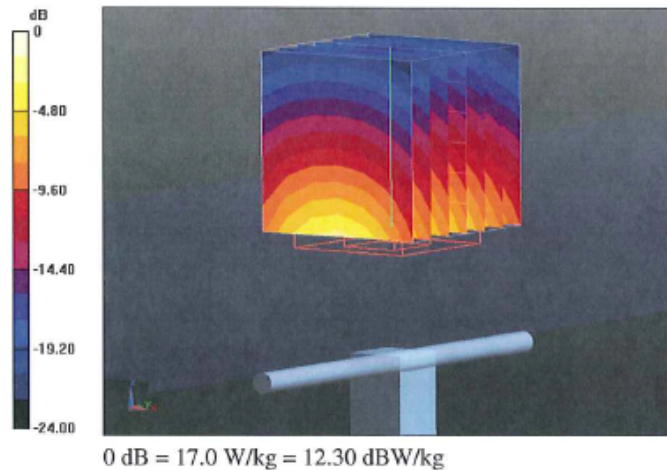

Impedance Measurement Plot for Head TSL

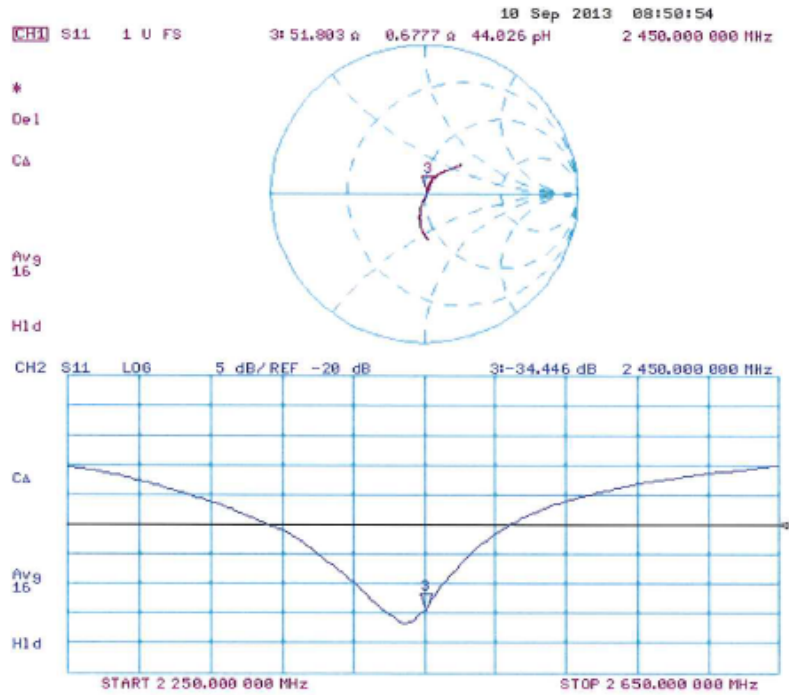

DASY5 Validation Report for Body TSL

Date: 10.09.2013

Test Laboratory: SPEAG, Zurich, Switzerland

DUT: Dipole 2450 MHz; Type: D2450V2; Serial: D2450V2 - SN: 713

Communication System: UID 0 - CW; Frequency: 2450 MHz

Medium parameters used: $f = 2450$ MHz; $\sigma = 2$ S/m; $\epsilon_r = 52.2$; $\rho = 1000$ kg/m³

Phantom section: Flat Section

Measurement Standard: DASY5 (IEEE/IEC/ANSI C63.19-2007)

DASY52 Configuration:

- Probe: ES3DV3 - SN3205; ConvF(4.42, 4.42, 4.42); Calibrated: 28.12.2012;
- Sensor-Surface: 3mm (Mechanical Surface Detection)
- Electronics: DAE4 Sn601; Calibrated: 25.04.2013
- Phantom: Flat Phantom 5.0 (back); Type: QD000P50AA; Serial: 1002
- DASY52 52.8.7(1137); SEMCAD X 14.6.10(7164)

Dipole Calibration for Body Tissue/Pin=250 mW, d=10mm/Zoom Scan (7x7x7)/Cube 0:

Measurement grid: dx=5mm, dy=5mm, dz=5mm

Reference Value = 94.095 V/m; Power Drift = 0.03 dB

Peak SAR (extrapolated) = 26.1 W/kg

SAR(1 g) = 12.6 W/kg; SAR(10 g) = 5.89 W/kg

Maximum value of SAR (measured) = 16.7 W/kg

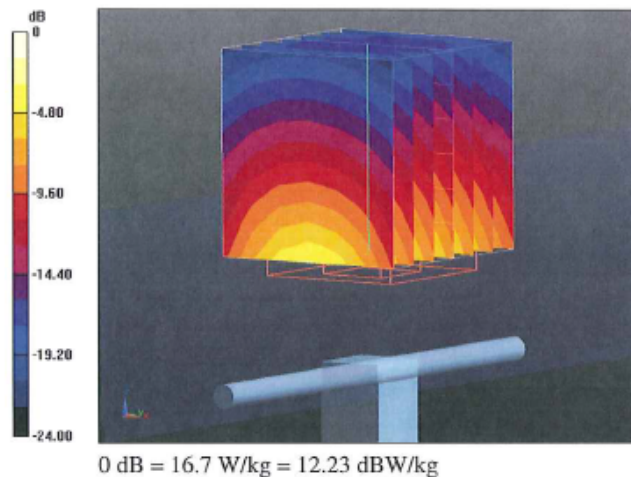

Impedance Measurement Plot for Body TSL

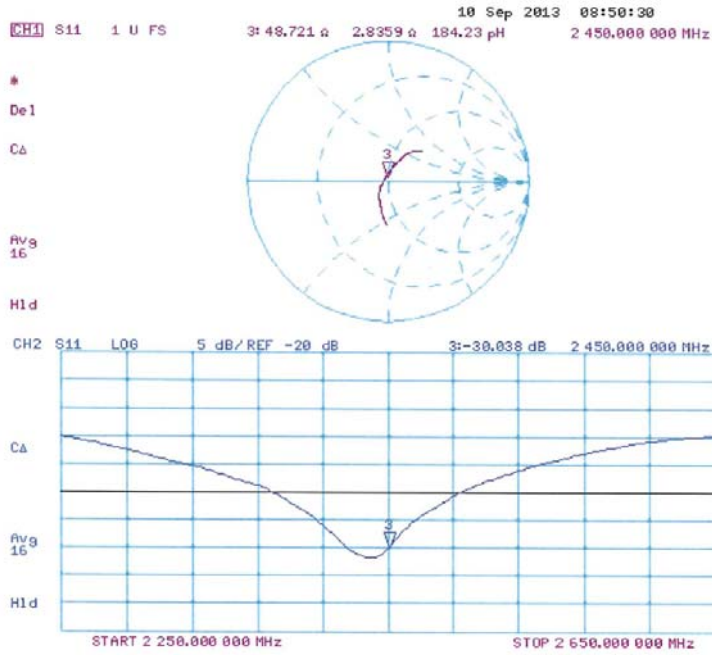

D2450V2 Calibration for Impedance and Return-loss

Equipment	Dipole Antenna	Model	D2450V2
Manufacture	Schmid&Partner Engineering AG	Serial	713
Tested by	Tomohisa Nakagawa		

1. Test environment

Date	July 21, 2015		
Ambient Temperature	24.0 deg.C	Relative humidity	50%RH

2. Equipment used

Control No.	Instrument	Manufacturer	Model No	Serial No	Test Item	Calibration Date * Interval(month)
EST-54	Network Analyzer	Hewlett Packard	8753ES	US39171615	SAR	2015/05/05 * 12
EST-08	Calibration Kit	Agilent	85032B	3217A12903	SAR	2015/05/04 * 12
MPF-04	2mm Oval Flat Phantom	Schmid&Partner Engineering AG	QDOVA001BB	1207	SAR	2015/05/11 * 12
MPSAM-04	SAM Phantom	Schmid&Partner Engineering AG	QD000P40CD	1762	SAR	2015/05/11 * 12
MOS-38	Digital thermometer	HANNA	Checktemp 4	-	SAR	2015/04/28 * 12
MOS-31	Thermo-Hygrometer	Custom	CTH-201	3101	SAR	2015/07/07 * 12
HSL2450						Daily check
MSL2450						Daily check
SAR room1						Daily check

3. Test Result

Impedance, Transformed to feed point	Head	Deviation	Tolerance	Result
Calibration (SPEAG) 2013/09/10	51.8 Ω +0.7j Ω	-	-	-
Calibration(ULJ)2015/7/21	50.94 Ω +0.86j Ω	-0.9 Ω +0.2j Ω	+/-5 Ω +/-5j Ω	Complied

Return loss	Head	Deviation	Tolerance	Result
Calibration (SPEAG) 2013/09/10	-34.4dB	-	-	-
Calibration(ULJ)2015/7/21	-37.97dB	-3.5dB	-34.4 *+/-20%	Complied

Impedance, Transformed to feed point	Body	Deviation	Tolerance	Result
Calibration (SPEAG) 2013/09/10	48.7 Ω +2.8j Ω	-	-	-
Calibration(ULJ)2015/7/21	50.53 Ω +2.48j Ω	+1.8 Ω +/-0.3j Ω	+/-5 Ω +/-5j Ω	Complied

Return loss	Body	Deviation	Tolerance	Result
Calibration (SPEAG) 2013/09/10	-30.0dB	-	-	-
Calibration(ULJ)2015/7/21	-31.95dB	-1.95dB	-30.0 *+/-20%	Complied

*Tolerance : According to the KDB450824D02

UL Japan, Inc.

Ise EMC Lab.

4383-326 Asama-cho, Ise-shi, Mie-ken 516-0021 JAPAN

Telephone: +81 596 24 8999

Facsimile: +81 596 24 8124

Measurement Plots

<Head Liquid>

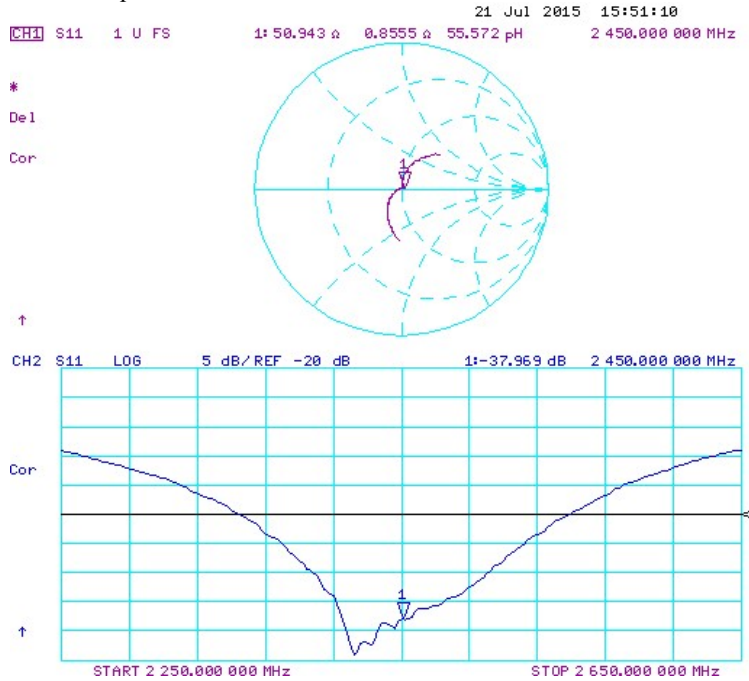

<Body Liquid>

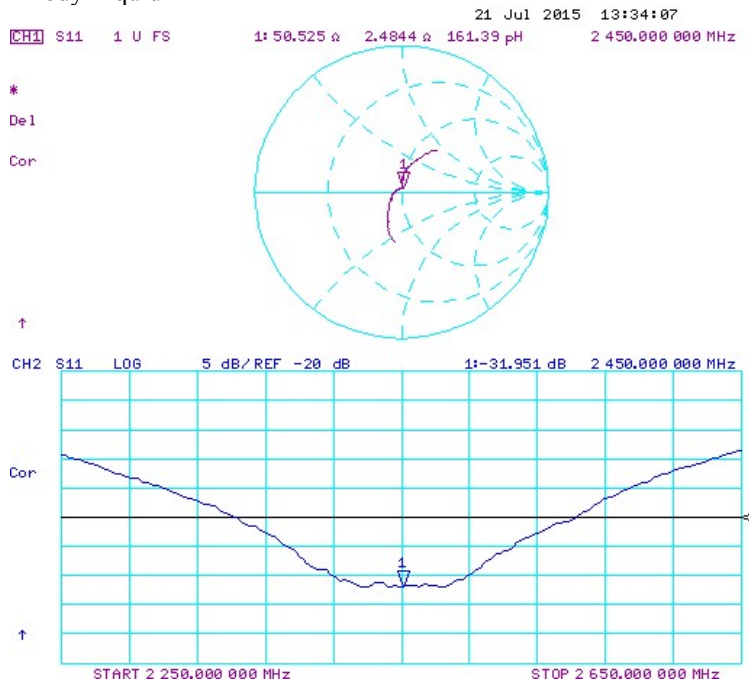

3. System check uncertainty

The uncertainty budget has been determined for the DASY5 measurement system according to the SPEAG documents and is given in the following Table.

Repeatability Budget for System Check

<0.3 – 3GHz range Body>

Error Description	Uncertainty value \pm %	Probability distribution	divisor	(ci) 1g	Standard (1g)	vi or veff
Measurement System						
Probe calibration	± 1.8	Normal	1	1	± 1.8	∞
Axial isotropy of the probe	± 0.0	Rectangular	$\sqrt{3}$	1	± 0.0	∞
Spherical isotropy of the probe	± 0.0	Rectangular	$\sqrt{3}$	0	± 0.0	∞
Boundary effects	± 0.0	Rectangular	$\sqrt{3}$	1	± 0.0	∞
Probe linearity	± 0.0	Rectangular	$\sqrt{3}$	1	± 0.0	∞
Detection limit	± 0.0	Rectangular	$\sqrt{3}$	1	± 0.0	∞
Modulation response	± 0.0	Rectangular	$\sqrt{3}$	1	± 0.0	∞
Readout electronics	± 0.0	Normal	1	1	± 0.0	∞
Response time	± 0.0	Rectangular	$\sqrt{3}$	1	± 0.0	∞
Integration time	± 0.0	Rectangular	$\sqrt{3}$	1	± 0.0	∞
RF ambient Noise	± 0.0	Rectangular	$\sqrt{3}$	1	± 0.0	∞
RF ambient Reflections	± 0.0	Rectangular	$\sqrt{3}$	1	± 0.0	∞
Probe Positioner	± 0.4	Rectangular	$\sqrt{3}$	1	± 0.2	∞
Probe positioning	± 2.9	Rectangular	$\sqrt{3}$	1	± 1.7	∞
Max.SAR Eval.	± 0.0	Rectangular	$\sqrt{3}$	1	± 0.0	∞
Test Sample Related						
Deviation of	± 0.0	Normal	$\sqrt{3}$	1	± 0.0	∞
Dipole Axis to Liquid Distance	± 2.0	Normal	$\sqrt{3}$	1	± 1.2	∞
Input power and SAR drift meas.	± 3.4	Rectangular	$\sqrt{3}$	1	± 2.0	∞
Phantom and Setup						
Phantom uncertainty	± 4.0	Rectangular	$\sqrt{3}$	1	± 2.3	∞
Algorithm for correcting SAR for deviations in permittivity and conductivity	± 1.9	Normal	1	1	± 1.9	∞
Liquid conductivity (meas.)	± 5.0	Rectangular	1	0.78	+ 3.9	∞
Liquid permittivity (meas.)	± 5.0	Rectangular	1	0.26	- 1.3	∞
Liquid conductivity - temp.unc (below 2deg.C.)	± 1.7	Rectangular	$\sqrt{3}$	0.78	± 0.8	∞
Liquid permittivity - temp.unc (below 2deg.C.)	± 0.3	Rectangular	$\sqrt{3}$	0.23	± 0.0	∞
Combined Standard Uncertainty					± 6.144	
Expanded Uncertainty (k=2)					± 12.3	

UL Japan, Inc.

Ise EMC Lab.

4383-326 Asama-cho, Ise-shi, Mie-ken 516-0021 JAPAN

Telephone: +81 596 24 8999

Facsimile: +81 596 24 8124

APPENDIX 3 : System specifications

1. Configuration and peripherals

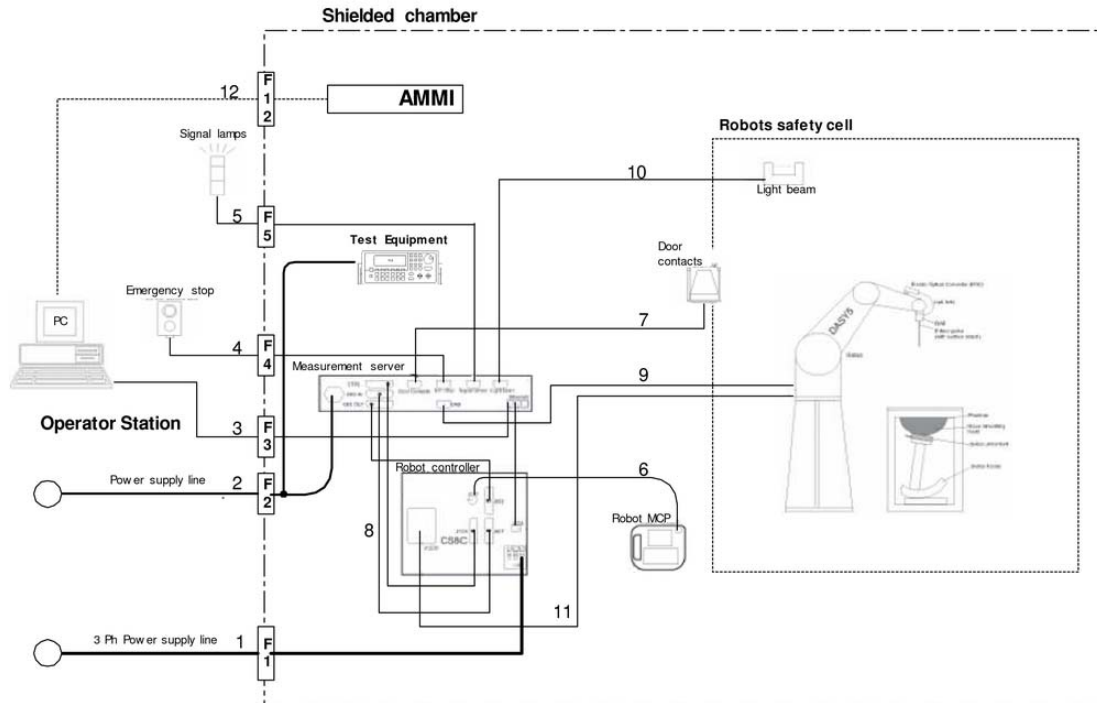

The DASYS5 system for performing compliance tests consist of the following items:

- a) A standard high precision 6-axis robot (Stäubli RX family) with controller and software.
An arm extension for accommodating the data acquisition electronics (DAE).
- b) An isotropic field probe optimized and calibrated for the targeted measurement.
- c) A data acquisition electronic (DAE), which performs the signal amplification, signal multiplexing, AD-conversion, offset measurements, mechanical surface detection, collision detection, etc. The unit is battery powered with standard or rechargeable batteries. The signal is optically transmitted to the EOC.
- d) The Electro-optical converter (EOC) performs the conversion between optical and electrical of the signals for the digital communication to the DAE and for the analog signal from the optical surface detection.
The EOC is connected to the measurement server.
- e) The function of the measurement server is to perform the time critical tasks such as signal filtering, control of the robot operation and fast movement interrupts.
- f) The Light Beam used is for probe alignment. This improves the (absolute) accuracy of the probe positioning.
- g) A computer running WinXP and the DASYS5 software.
- h) Remote control with teaches pendant and additional circuitry for robot safety such as warning lamps, etc.
- i) The phantom, the device holder and other accessories according to the targeted measurement.

UL Japan, Inc.

Ise EMC Lab.

4383-326 Asama-cho, Ise-shi, Mie-ken 516-0021 JAPAN

Telephone: +81 596 24 8999

Facsimile: +81 596 24 8124

2. Specifications

a) Robot TX60L

Number of Axes	:	6
Nominal Load	:	2 kg
Maximum Load	:	5kg
Reach	:	920mm
Repeatability	:	+/-0.03mm
Control Unit	:	CS8c
Programming Language	:	VAL3
Weight	:	52.2kg
Manufacture	:	Stäubli Robotics

b) E-Field Probe

Model	:	EX3DV4
Serial No.	:	3825
Construction	:	Symmetrical design with triangular core Built-in shielding against static charges PEEK enclosure material (resistant to organic solvents, e.g., glycol ether)
Frequency	:	10 MHz to > 6 GHz Linearity: ± 0.2 dB (30 MHz to 6 GHz)
Directivity	:	+/-0.3 dB in HSL (rotation around probe axis) +/-0.5 dB in tissue material (rotation normal probe axis)
Dynamic Range	:	10uW/g to > 100 mW/g; Linearity +/-0.2 dB(noise: typically < 1uW/g)
Dimensions	:	Overall length: 337 mm (Tip: 20 mm) Tip diameter: 2.5mm (Body: 12 mm) Typical distance from probe tip to dipole centers: 1 mm
Application	:	Highprecision dosimetric measurement in any exposure scenario (e.g., very strong gradient fields). Only probe which enables compliance testing for frequencies up to 6GHz with precision of better 30%.
Manufacture	:	Schmid & Partner Engineering AG



EX3DV4 E-field Probe

c)Data Acquisition Electronic (DAE4)

Features	:	Signal amplifier, multiplexer, A/D converter and control logic Serial optical link for communication with DASY5 embedded system (fully remote controlled) Two step probe touch detector for mechanical surface detection and emergency robot stop
Measurement Range	:	-100 to +300 mV (16 bit resolution and two range settings: 4mV, 400mV)
Input Offset voltage	:	< 5 μ V (with auto zero)
Input Resistance	:	200 M Ω
Input Bias Current	:	< 50 fA
Battery Power	:	> 10 h of operation (with two 9.6 V NiMH accus)
Dimension	:	60 x 60 x 68 mm
Manufacture	:	Schmid & Partner Engineering AG

d)Electro-Optic Converter (EOC)

Version	:	EOC 61
Description	:	for TX60 robot arm, including proximity sensor
Manufacture	:	Schmid & Partner Engineering AG

e)DASY5 Measurement server

Features	:	Intel ULV Celeron 400MHz 128MB chip disk and 128MB RAM 16 Bit A/D converter for surface detection system Vacuum Fluorescent Display Robot Interface Serial link to DAE (with watchdog supervision) Door contact port (Possibility to connect a light curtain) Emergency stop port (to connect the remote control) Signal lamps port Light beam port Three Ethernet connection ports Two USB 2.0 Ports Two serial links Expansion port for future applications
Dimensions (L x W x H)	:	440 x 241 x 89 mm
Manufacture	:	Schmid & Partner Engineering AG

f) Light Beam Switches

Version	:	LB5
Dimensions (L x H)	:	110 x 80 mm
Thickness	:	12 mm
Beam-length	:	80 mm
Manufacture	:	Schmid & Partner Engineering AG

g)Software

Item	:	Dosimetric Assessment System DASY5
Type No.	:	SD 000 401A, SD 000 402A
Software version No.	:	DASY52, Version 52.6 (1)
Manufacture / Origin	:	Schmid & Partner Engineering AG

h)Robot Control Unit

Weight	:	70 Kg
AC Input Voltage	:	selectable
Manufacturer	:	Stäubli Robotics

i)Phantom and Device Holder**Phantom**

Type	:	SAM Twin Phantom V4.0
Description	:	The shell corresponds to the specifications of the Specific Anthropomorphic Mannequin (SAM) phantom defined in IEEE 1528 and IEC 62209-1. It enables the dosimetric evaluation of left and right hand phone usage as well as body mounted usage at the flat phantom region. A cover prevents evaporation of the liquid. Reference markings on the phantom allow the complete setup of all predefined phantom positions and measurement grids by teaching three points with the robot.
Material	:	Vinylester, glass fiber reinforced (VE-GF)
Shell Material	:	Fiberglass
Thickness	:	2.0 +/-0.2 mm
Dimensions	:	Length: 1000 mm Width: 500 mm Height: adjustable feet
Volume	:	Approx. 25 liters
Manufacture	:	Schmid & Partner Engineering AG

Type	:	2mm Flat phantom ERI4.0
Description	:	Phantom for compliance testing of handheld and body-mounted wireless devices in the frequency range of 30 MHz to 6 GHz. ELI4 is fully compatible with the latest draft of the standard IEC 62209 Part II and all known tissue simulating liquids. ELI4 has been optimized regarding its performance and can be integrated into our standard phantom tables. A cover prevents evaporation of the liquid. Reference markings on the phantom allow installation of the complete setup, including all predefined phantom positions and measurement grids, by teaching three points. The phantom is supported by software version DASY4.5 and higher and is compatible with all SPEAG dosimetric probes and dipoles.
Material	:	Vinylester, glass fiber reinforced (VE-GF)
Shell Thickness	:	2.0 ± 0.2 mm (sagging: <1%)
Filling Volume	:	approx. 30 liters
Dimensions	:	Major ellipse axis: 600 mm Minor axis: 400 mm
Manufacture	:	Schmid & Partner Engineering AG

Device Holder

In combination with the Twin SAM Phantom V4.0/V4.0c or ELI4, the Mounting Device enables the rotation of the mounted transmitter device in spherical coordinates. Rotation point is the ear opening point. Transmitter devices can be easily and accurately positioned according to IEC, IEEE, FCC or other specifications. The device holder can be locked for positioning at different phantom sections (left head, right head, flat).

Material	:	POM
-----------------	---	-----

Laptio Extensions kit

Simple but effective and easy-to-use extension for Mounting Device that facilitates the testing of larger devices according to IEC 62209-2 (e.g., laptops, cameras, etc.). It is lightweight and fits easily on the upper part of the Mounting Device in place of the phone positioner. The extension is fully compatible with the Twin-SAM, ELI4 Phantoms.

Material	:	POM, Acrylic glass, Foam
-----------------	---	--------------------------

Urethane

For this measurement, the urethane foam was used as device holder.

j) Simulated Tissues (Liquid)

The following tissue formulations are provided for reference only as some of the parameters have not been thoroughly verified. The composition of ingredients may be modified accordingly to achieve the desired target tissue parameters required for routine SAR evaluation.

Mixture (%)	Frequency (MHz)									
	450		900		1800		1950		2450	
Tissue Type	Head	Body	Head	Body	Head	Body	Head	Body	Head	Body
Water	38.91	46.21	40.29	50.75	55.24	70.17	55.41	69.79	55.0	68.64
Sugar	56.93	51.17	57.90	48.21	-	-	-	-	-	-
Cellulose	0.25	0.18	0.24	0.00	-	-	-	-	-	-
Salt (NaCl)	3.79	2.34	1.38	0.94	0.31	0.39	0.08	0.2	-	-
Preventol	0.12	0.08	0.18	0.10	-	-	-	-	-	-
DGMBE	-	-	-	-	44.45	29.44	44.51	30.0	45.0	31.37
Dielectric Constant	43.42	58.0	42.54	56.1	42.0	56.8	39.9	54.0	39.8	52.5
Conductivity (S/m)	0.85	0.83	0.91	0.95	1.0	1.07	1.42	1.45	1.88	1.78

Note: DGMBE (Diethylenglycol-monobutyl ether)

The simulated tissue (liquid) of 1800MHz was used for the test frequency of 1700MHz to 1800MHz.

Mixture (%)	Frequency (MHz)	
	650&750	1450
Tissue Type	Head and Body	Head and Body
Water	35-58%	52-75%
Sugar	40-60%	-
Cellulose	<0.3%	-
Salt (NaCl)	0-6%	<1%
Preventol	0.1-0.7%	-
DGMBE	-	25-48%

Mixture (%)	Frequency (MHz)	
	5800	
Tissue Type	Head	Body
Water	64.0	78.0
Mineral Oil	18.0	11.0
Emulsifiers	15.0	9.0
Additives and salt	3.0	2.0

3. Dosimetric E-Field Probe Calibration (EX3DV4, S/N: 3825)

**Calibration Laboratory of
Schmid & Partner
Engineering AG**
Zeughausstrasse 43, 8004 Zurich, Switzerland



S Schweizerischer Kalibrierdienst
C Service suisse d'étalonnage
S Servizio svizzero di taratura
S Swiss Calibration Service

Accredited by the Swiss Accreditation Service (SAS)
The Swiss Accreditation Service is one of the signatories to the EA
Multilateral Agreement for the recognition of calibration certificates

Accreditation No.: **SCS 0108**

Client **UL Japan (Vitec)**

Certificate No: **EX3-3825_Dec15**

CALIBRATION CERTIFICATE

Object **EX3DV4 - SN:3825**

Calibration procedure(s) **QA CAL-01.v9, QA CAL-14.v4, QA CAL-23.v5, QA CAL-25.v6
Calibration procedure for dosimetric E-field probes**

Calibration date: **December 11, 2015**

This calibration certificate documents the traceability to national standards, which realize the physical units of measurements (SI).
The measurements and the uncertainties with confidence probability are given on the following pages and are part of the certificate.

All calibrations have been conducted in the closed laboratory facility: environment temperature (22 ± 3)°C and humidity < 70%.

Calibration Equipment used (M&TE critical for calibration)

Primary Standards	ID	Cal Date (Certificate No.)	Scheduled Calibration
Power meter E4419B	GB41293874	01-Apr-15 (No. 217-02128)	Mar-16
Power sensor E4412A	MY41498087	01-Apr-15 (No. 217-02128)	Mar-16
Reference 3 dB Attenuator	SN: S5054 (3c)	01-Apr-15 (No. 217-02129)	Mar-16
Reference 20 dB Attenuator	SN: S5277 (20x)	01-Apr-15 (No. 217-02132)	Mar-16
Reference 30 dB Attenuator	SN: S5129 (30b)	01-Apr-15 (No. 217-02133)	Mar-16
Reference Probe ES3DV2	SN: 3013	30-Dec-14 (No. ES3-3013_Dec14)	Dec-15
DAE4	SN: 660	14-Jan-15 (No. DAE4-660_Jan15)	Jan-16
Secondary Standards	ID	Check Date (in house)	Scheduled Check
RF generator HP 8648C	US3642U01700	4-Aug-99 (in house check Apr-13)	In house check: Apr-16
Network Analyzer HP 8753E	US37390585	18-Oct-01 (in house check Oct-15)	In house check: Oct-16

	Name	Function	Signature
Calibrated by:	Leif Klysner	Laboratory Technician	
Approved by:	Katja Pokovic	Technical Manager	

Issued: December 15, 2015

This calibration certificate shall not be reproduced except in full without written approval of the laboratory.

**Calibration Laboratory of
Schmid & Partner
Engineering AG**
Zeughausstrasse 43, 8004 Zurich, Switzerland



S Schweizerischer Kalibrierdienst
C Service suisse d'étalonnage
S Servizio svizzero di taratura
Swiss Calibration Service

Accredited by the Swiss Accreditation Service (SAS)

Accreditation No.: **SCS 0108**

The Swiss Accreditation Service is one of the signatories to the EA
Multilateral Agreement for the recognition of calibration certificates

Glossary:

TSL	tissue simulating liquid
NORM _{x,y,z}	sensitivity in free space
ConvF	sensitivity in TSL / NORM _{x,y,z}
DCP	diode compression point
CF	crest factor (1/duty_cycle) of the RF signal
A, B, C, D	modulation dependent linearization parameters
Polarization ϕ	ϕ rotation around probe axis
Polarization ϑ	ϑ rotation around an axis that is in the plane normal to probe axis (at measurement center), i.e., $\vartheta = 0$ is normal to probe axis
Connector Angle	information used in DASY system to align probe sensor X to the robot coordinate system

Calibration is Performed According to the Following Standards:

- IEEE Std 1528-2013, "IEEE Recommended Practice for Determining the Peak Spatial-Averaged Specific Absorption Rate (SAR) in the Human Head from Wireless Communications Devices: Measurement Techniques", June 2013
- IEC 62209-1, "Procedure to measure the Specific Absorption Rate (SAR) for hand-held devices used in close proximity to the ear (frequency range of 300 MHz to 3 GHz)", February 2005
- IEC 62209-2, "Procedure to determine the Specific Absorption Rate (SAR) for wireless communication devices used in close proximity to the human body (frequency range of 30 MHz to 6 GHz)", March 2010
- KDB 865664, "SAR Measurement Requirements for 100 MHz to 6 GHz"

Methods Applied and Interpretation of Parameters:

- NORM_{x,y,z}**: Assessed for E-field polarization $\vartheta = 0$ ($f \leq 900$ MHz in TEM-cell; $f > 1800$ MHz: R22 waveguide). NORM_{x,y,z} are only intermediate values, i.e., the uncertainties of NORM_{x,y,z} does not affect the E^2 -field uncertainty inside TSL (see below *ConvF*).
- NORM(f)_{x,y,z} = NORM_{x,y,z} * frequency_response** (see Frequency Response Chart). This linearization is implemented in DASY4 software versions later than 4.2. The uncertainty of the frequency response is included in the stated uncertainty of *ConvF*.
- DCP_{x,y,z}**: DCP are numerical linearization parameters assessed based on the data of power sweep with CW signal (no uncertainty required). DCP does not depend on frequency nor media.
- PAR**: PAR is the Peak to Average Ratio that is not calibrated but determined based on the signal characteristics
- A_{x,y,z}; B_{x,y,z}; C_{x,y,z}; D_{x,y,z}; VR_{x,y,z}**: A, B, C, D are numerical linearization parameters assessed based on the data of power sweep for specific modulation signal. The parameters do not depend on frequency nor media. VR is the maximum calibration range expressed in RMS voltage across the diode.
- ConvF and Boundary Effect Parameters**: Assessed in flat phantom using E-field (or Temperature Transfer Standard for $f \leq 800$ MHz) and inside waveguide using analytical field distributions based on power measurements for $f > 800$ MHz. The same setups are used for assessment of the parameters applied for boundary compensation (alpha, depth) of which typical uncertainty values are given. These parameters are used in DASY4 software to improve probe accuracy close to the boundary. The sensitivity in TSL corresponds to **NORM_{x,y,z} * ConvF** whereby the uncertainty corresponds to that given for *ConvF*. A frequency dependent *ConvF* is used in DASY version 4.4 and higher which allows extending the validity from ± 50 MHz to ± 100 MHz.
- Spherical isotropy (3D deviation from isotropy)**: in a field of low gradients realized using a flat phantom exposed by a patch antenna.
- Sensor Offset**: The sensor offset corresponds to the offset of virtual measurement center from the probe tip (on probe axis). No tolerance required.
- Connector Angle**: The angle is assessed using the information gained by determining the **NORM_x** (no uncertainty required).

EX3DV4 – SN:3825

December 11, 2015

Probe EX3DV4

SN:3825

Manufactured: September 6, 2011
Calibrated: December 11, 2015

Calibrated for DASY/EASY Systems
(Note: non-compatible with DASY2 system!)

EX3DV4- SN:3825

December 11, 2015

DASY/EASY - Parameters of Probe: EX3DV4 - SN:3825**Basic Calibration Parameters**

	Sensor X	Sensor Y	Sensor Z	Unc (k=2)
Norm ($\mu\text{V}/(\text{V}/\text{m})^2$) ^A	0.43	0.39	0.43	$\pm 10.1 \%$
DCP (mV) ^B	101.4	102.7	100.2	

Modulation Calibration Parameters

UID	Communication System Name		A dB	B dB $\sqrt{\mu\text{V}}$	C	D dB	VR mV	Unc ^E (k=2)
0	CW	X	0.0	0.0	1.0	0.00	143.6	$\pm 2.7 \%$
		Y	0.0	0.0	1.0		139.1	
		Z	0.0	0.0	1.0		153.8	

The reported uncertainty of measurement is stated as the standard uncertainty of measurement multiplied by the coverage factor k=2, which for a normal distribution corresponds to a coverage probability of approximately 95%.

^A The uncertainties of Norm X,Y,Z do not affect the E²-field uncertainty inside TSL (see Pages 5 and 6).

^B Numerical linearization parameter: uncertainty not required.

^E Uncertainty is determined using the max. deviation from linear response applying rectangular distribution and is expressed for the square of the field value.

EX3DV4- SN:3825

December 11, 2015

DASY/EASY - Parameters of Probe: EX3DV4 - SN:3825

Calibration Parameter Determined in Head Tissue Simulating Media

f (MHz) ^C	Relative Permittivity ^F	Conductivity (S/m) ^F	ConvF X	ConvF Y	ConvF Z	Alpha ^G	Depth (mm) ^G	Unc (k=2)
750	41.9	0.89	9.79	9.79	9.79	0.23	1.25	± 12.0 %
835	41.5	0.90	9.49	9.49	9.49	0.21	1.30	± 12.0 %
900	41.5	0.97	9.23	9.23	9.23	0.24	1.24	± 12.0 %
1450	40.5	1.20	8.30	8.30	8.30	0.12	2.03	± 12.0 %
1750	40.1	1.37	8.18	8.18	8.18	0.24	0.95	± 12.0 %
1900	40.0	1.40	7.94	7.94	7.94	0.31	0.85	± 12.0 %
1950	40.0	1.40	7.69	7.69	7.69	0.31	0.85	± 12.0 %
2450	39.2	1.80	7.31	7.31	7.31	0.34	0.83	± 12.0 %
3500	37.9	2.91	6.91	6.91	6.91	0.28	1.25	± 13.1 %
5200	36.0	4.66	5.13	5.13	5.13	0.35	1.80	± 13.1 %
5250	35.9	4.71	5.06	5.06	5.06	0.35	1.80	± 13.1 %
5300	35.9	4.76	4.83	4.83	4.83	0.40	1.80	± 13.1 %
5500	35.6	4.96	4.60	4.60	4.60	0.45	1.80	± 13.1 %
5600	35.5	5.07	4.27	4.27	4.27	0.50	1.80	± 13.1 %
5750	35.4	5.22	4.44	4.44	4.44	0.50	1.80	± 13.1 %
5800	35.3	5.27	4.34	4.34	4.34	0.50	1.80	± 13.1 %

^C Frequency validity above 300 MHz of ± 100 MHz only applies for DASY v4.4 and higher (see Page 2), else it is restricted to ± 50 MHz. The uncertainty is the RSS of the ConvF uncertainty at calibration frequency and the uncertainty for the indicated frequency band. Frequency validity below 300 MHz is ± 10, 25, 40, 50 and 70 MHz for ConvF assessments at 30, 64, 128, 150 and 220 MHz respectively. Above 5 GHz frequency validity can be extended to ± 110 MHz.

^F At frequencies below 3 GHz, the validity of tissue parameters (ϵ and σ) can be relaxed to ± 10% if liquid compensation formula is applied to measured SAR values. At frequencies above 3 GHz, the validity of tissue parameters (ϵ and σ) is restricted to ± 5%. The uncertainty is the RSS of the ConvF uncertainty for indicated target tissue parameters.

^G Alpha/Depth are determined during calibration. SPEAG warrants that the remaining deviation due to the boundary effect after compensation is always less than ± 1% for frequencies below 3 GHz and below ± 2% for frequencies between 3-6 GHz at any distance larger than half the probe tip diameter from the boundary.

DASY/EASY - Parameters of Probe: EX3DV4 - SN:3825

Calibration Parameter Determined in Body Tissue Simulating Media

f (MHz) ^C	Relative Permittivity ^F	Conductivity (S/m) ^F	ConvF X	ConvF Y	ConvF Z	Alpha ^G	Depth ^G (mm)	Unc (k=2)
750	55.5	0.96	9.89	9.89	9.89	0.35	0.92	± 12.0 %
835	55.2	0.97	9.67	9.67	9.67	0.23	1.22	± 12.0 %
900	55.0	1.05	9.56	9.56	9.56	0.30	0.98	± 12.0 %
1450	54.0	1.30	8.18	8.18	8.18	0.24	1.09	± 12.0 %
1750	53.4	1.49	7.94	7.94	7.94	0.32	0.88	± 12.0 %
1900	53.3	1.52	7.66	7.66	7.66	0.23	1.10	± 12.0 %
1950	53.3	1.52	7.93	7.93	7.93	0.29	0.96	± 12.0 %
2450	52.7	1.95	7.29	7.29	7.29	0.32	0.85	± 12.0 %
3500	51.3	3.31	6.39	6.39	6.39	0.36	1.06	± 13.1 %
5250	48.9	5.36	4.25	4.25	4.25	0.50	1.90	± 13.1 %
5600	48.5	5.77	3.61	3.61	3.61	0.60	1.90	± 13.1 %
5750	48.3	5.94	3.85	3.85	3.85	0.60	1.90	± 13.1 %

^C Frequency validity above 300 MHz of ± 100 MHz only applies for DASY v4.4 and higher (see Page 2), else it is restricted to ± 50 MHz. The uncertainty is the RSS of the ConvF uncertainty at calibration frequency and the uncertainty for the indicated frequency band. Frequency validity below 300 MHz is ± 10, 25, 40, 50 and 70 MHz for ConvF assessments at 30, 64, 128, 150 and 220 MHz respectively. Above 5 GHz frequency validity can be extended to ± 110 MHz.

^F At frequencies below 3 GHz, the validity of tissue parameters (ϵ and σ) can be relaxed to ± 10% if liquid compensation formula is applied to measured SAR values. At frequencies above 3 GHz, the validity of tissue parameters (ϵ and σ) is restricted to ± 5%. The uncertainty is the RSS of the ConvF uncertainty for indicated target tissue parameters.

^G Alpha/Depth are determined during calibration. SPEAG warrants that the remaining deviation due to the boundary effect after compensation is always less than ± 1% for frequencies below 3 GHz and below ± 2% for frequencies between 3-6 GHz at any distance larger than half the probe tip diameter from the boundary.

Frequency Response of E-Field (TEM-Cell:ifi110 EXX, Waveguide: R22)

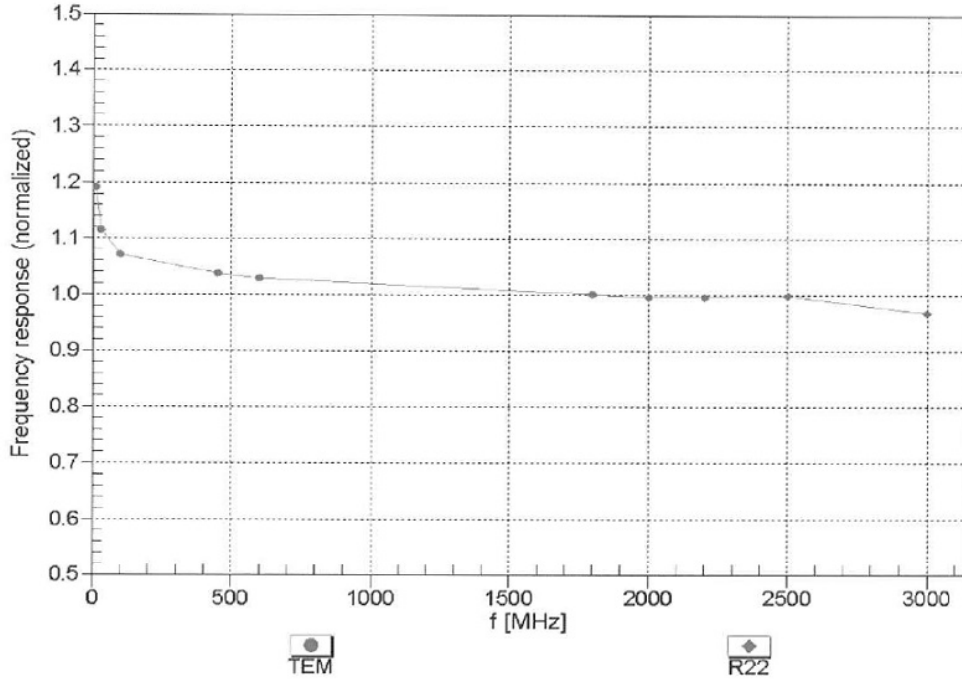

Uncertainty of Frequency Response of E-field: $\pm 6.3\%$ (k=2)

Receiving Pattern (ϕ), $\theta = 0^\circ$

f=600 MHz,TEM

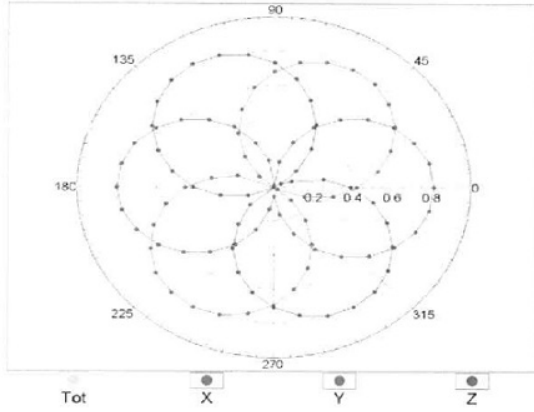

f=1800 MHz,R22

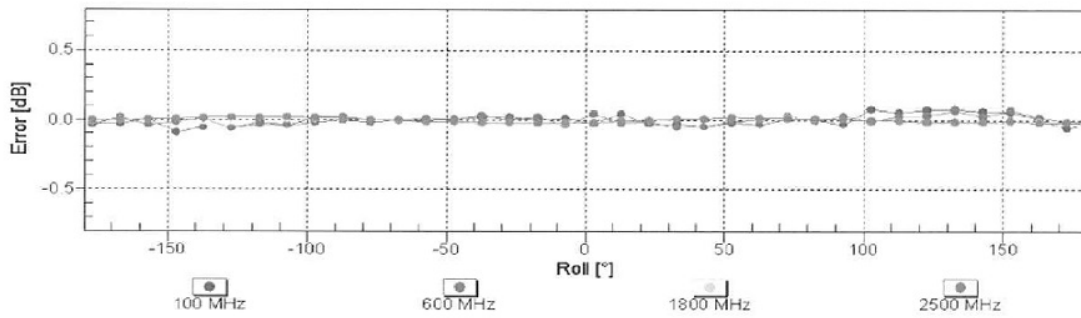
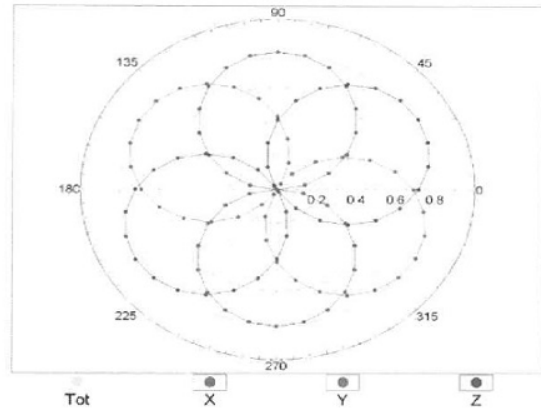

Uncertainty of Axial Isotropy Assessment: $\pm 0.5\%$ (k=2)

Dynamic Range f(SAR_{head}) (TEM cell , f_{eval}= 1900 MHz)

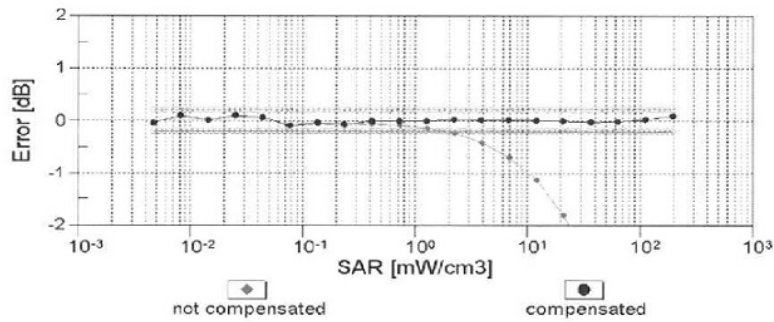
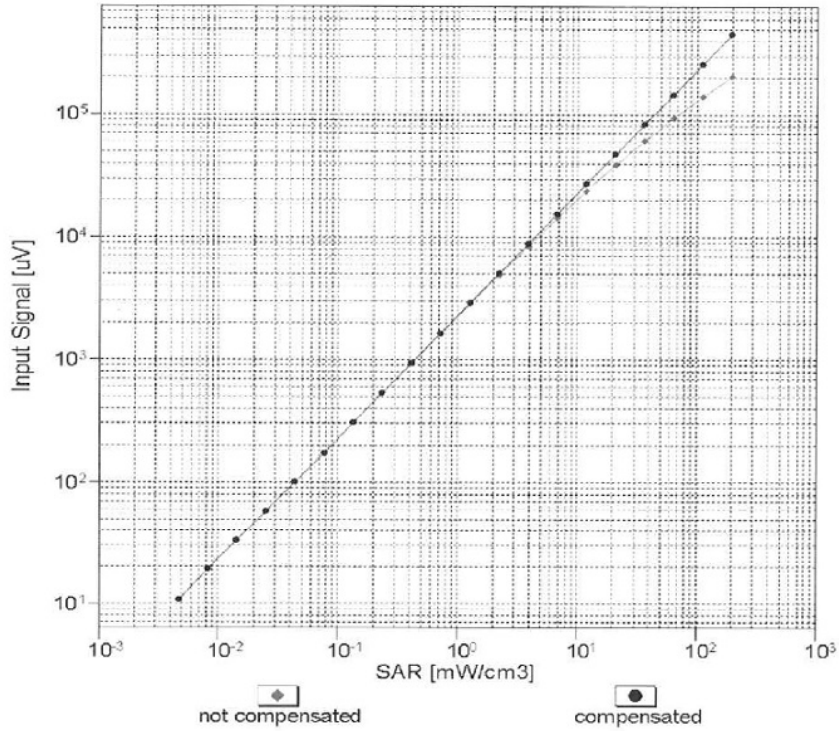

Uncertainty of Linearity Assessment: ± 0.6% (k=2)

EX3DV4- SN:3825

December 11, 2015

Conversion Factor Assessment

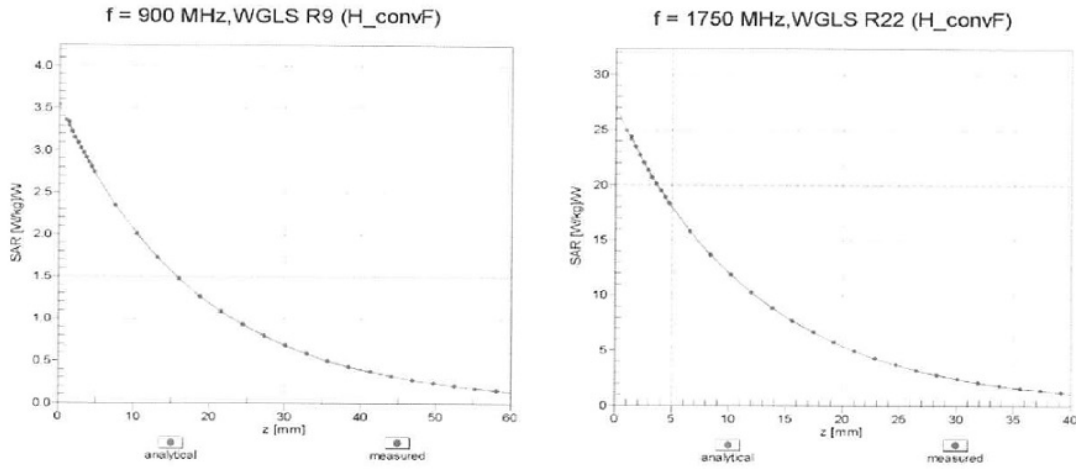

Deviation from Isotropy in Liquid

Error (ϕ, θ), f = 900 MHz

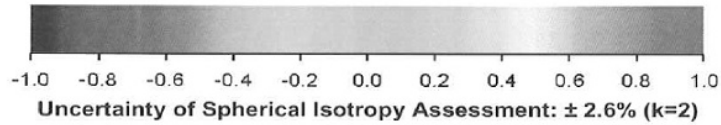
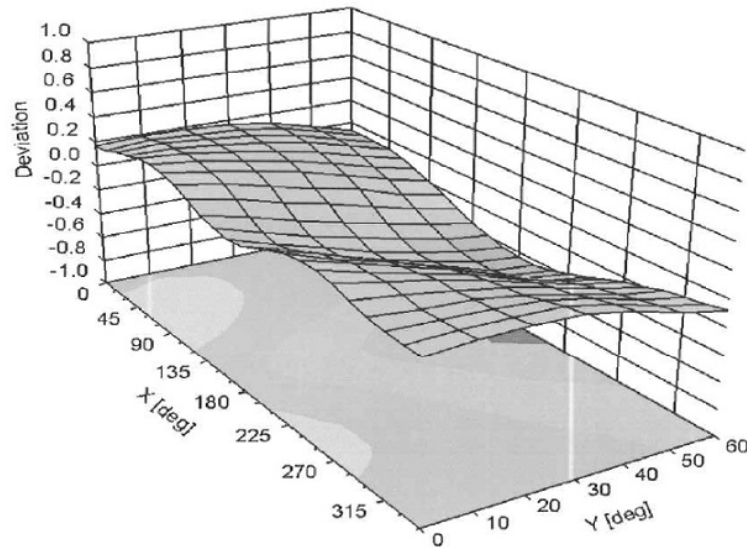

EX3DV4- SN:3825

December 11, 2015

DASY/EASY - Parameters of Probe: EX3DV4 - SN:3825

Other Probe Parameters

Sensor Arrangement	Triangular
Connector Angle (°)	-27.3
Mechanical Surface Detection Mode	enabled
Optical Surface Detection Mode	disabled
Probe Overall Length	337 mm
Probe Body Diameter	10 mm
Tip Length	9 mm
Tip Diameter	2.5 mm
Probe Tip to Sensor X Calibration Point	1 mm
Probe Tip to Sensor Y Calibration Point	1 mm
Probe Tip to Sensor Z Calibration Point	1 mm
Recommended Measurement Distance from Surface	1.4 mm