

---

# FCC Test Report

---

**Report No: WD-RF-R-230178-A0**

**Product Name** : RFID Reader  
**Model No** : DF700A  
**Multi-listing Model No.** : DF700A-00, DF710A-00, DF710A-U2, ACC-D5280  
**FCC ID** : WXADF700A  
**Applicant** : GIGA-TMS INC  
**Received Date** : Jun. 06, 2023  
**Tested Date** : Jun. 09, 2023 ~ Jun. 20, 2023  
**Applicable Standard** : 47 CFR FCC Part 15, Subpart C (Section 15.225)  
ANSI C63.10 : 2013



**Wendell Industrial Co., Ltd**  
**Wendell EMC & RF Laboratory**

**Caution:**

This report sets forth our findings solely with respect to the test samples identified herein. The results set forth in this report are not indicative or representative of the quality or characteristics of the lot from which a test sample was taken or any similar or identical product unless specifically and expressly noted.

The test results shown in the test report are traceable to the national/international standard through the calibration report of the equipment.

Please note that the measurement uncertainty are provided for informational purpose only and are not used in determining the Pass/Fail results.

This report must not be used to claim product endorsement by TAF or any agency of the government.

The test report shall not be reproduced without the written approval of Wendell Industrial Co., Ltd..

# Test Report

Issued Date: June 21, 2023

Project No.: 23Q050802

<b>Product Name</b>	RFID Reader
<b>Trade Name</b>	PROMAG, GIGATEK, ProxData
<b>Model No</b>	DF700A
<b>Multi-listing Model No.</b>	DF700A-00, DF710A-00, DF710A-U2, ACC-D5280
<b>FCC ID</b>	WXADF700A
<b>Applicant</b>	GIGA-TMS INC
<b>Manufacturer</b>	GIGA-TMS INC
<b>EUT Rated Voltage</b>	DC 9 ~ 24V
<b>EUT Test Voltage</b>	DC 12V
<b>EUT Supports Radios Application</b>	RFID 13.56 MHz
<b>Applicable Standard</b>	47 CFR FCC Part 15, Subpart C (Section 15.225) ANSI C63.10 : 2013
<b>Test Result</b>	Complied

Documented :



( Specialist / Emma Lu )

Technical Engineer :



( Section Manager / Jack Chang )

Approved :

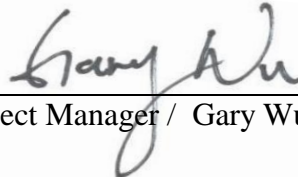

( Project Manager / Gary Wu )

## Table of Contents

<b>Document Revision History</b> .....	<b>4</b>
<b>Summary of Test Result</b> .....	<b>5</b>
<b>1 Generation Information</b> .....	<b>6</b>
<b>1.1 Applicant</b> .....	<b>6</b>
<b>1.2 Manufacturer</b> .....	<b>6</b>
<b>1.3 Description of Equipment under Test</b> .....	<b>6</b>
<b>1.4 Configuration of Tested System</b> .....	<b>9</b>
<b>1.5 EUT Exercise Software</b> .....	<b>9</b>
<b>1.6 Tested System Details</b> .....	<b>9</b>
<b>1.7 Test Facility</b> .....	<b>10</b>
<b>1.8 Measurement Uncertainty</b> .....	<b>11</b>
<b>1.9 List of Test Equipment</b> .....	<b>12</b>
<b>2 Test Result</b> .....	<b>16</b>
<b>2.1 Antenna Requirement</b> .....	<b>16</b>
2.1.1 Applicable Standard .....	16
2.1.2 Antenna Connected Construction .....	16
<b>2.2 20dB Spectrum Bandwidth Measurement</b> .....	<b>17</b>
2.2.1 Limit .....	17
2.2.2 Test Setup .....	17
2.2.3 Test Procedure .....	17
2.2.4 Test Result .....	18
<b>2.3 Frequency Stability Measurement</b> .....	<b>19</b>
2.3.1 Limit .....	19
2.3.2 Test Setup .....	19
2.3.3 Test Procedure .....	19
2.3.4 Test Result .....	20
<b>2.4 Field Strength of Fundamental Emissions Measurement</b> .....	<b>22</b>
2.4.1 Limit .....	22
2.4.2 Test Setup .....	23
2.4.3 Test Procedure .....	23
2.4.4 Test Result .....	24
<b>2.5 Radiated Emissions Measurement</b> .....	<b>26</b>
2.5.1 Limit .....	26
2.5.2 Test Setup .....	26
2.5.3 Test Procedure .....	27
2.5.4 Test Result .....	28
<b>2.6 AC Conducted Emissions Measurement</b> .....	<b>32</b>
2.6.1 Limit .....	32
2.6.2 Test Setup .....	32
2.6.3 Test Procedure .....	33
2.6.4 Test Result .....	34
<b>Attachment 1: EUT Test Photographs</b>	
<b>Attachment 2: EUT Detailed Photographs</b>	

## Document Revision History

Report No.	Issue date	Description
WD-RF-R-230178-A0	June 21, 2023	Initial report

## Summary of Test Result

Ref. Std. Clause	Test Items	Result
15.203	Antenna Requirement	Pass
15.215(c)	20dB Spectrum Bandwidth	Pass
15.225(e)	Frequency Stability	Pass
15.225 (a)(b)(c)	Field Strength of Fundamental Emissions	Pass
15.225(d)	Radiated Spurious Emissions	Pass
15.207	AC Conducted Emission	N/A

# 1 Generation Information

## 1.1 Applicant

GIGA-TMS INC  
8F. NO31, Lane 169, Kang-Ning St., His-Chih, New Taipei City 22180, Taiwan

## 1.2 Manufacturer

GIGA-TMS INC  
8F. NO31, Lane 169, Kang-Ning St., His-Chih, New Taipei City 22180, Taiwan

## 1.3 Description of Equipment under Test

<b>Product Name</b>	RFID Reader
<b>Model No</b>	DF700A
<b>Multi-listing Model No.</b>	DF700A-00, DF710A-00, DF710A-U2, ACC-D5280
<b>Model Difference</b>	Refer to the table "Series Difference List"
<b>FCC ID</b>	WXADF700A
<b>Frequency Range</b>	13.56 MHz
<b>Type of Modulation</b>	ASK
<b>Antenna Information</b>	Refer to the table "Antenna List"
<b>EUT Supports Radios Application</b>	RFID 13.56 MHz
<b>EUT Rated Voltage</b>	DC 9 ~ 24V
<b>EUT Test Voltage</b>	DC 12V

### Series Difference List

Model Differences	Model No.	Multi-listing Model No.			
	DF700A	DF700A-00	DF710A-00	DF710A-U2	ACC-D5280
RS 232	The model name of this project is collectively called as DF700A.	V	--	--	--
RS 485		--	V	V	V
8 pins		V	V	--	--
10 pins		--	--	V	V

### Antenna List

No.	Manufacturer	Model No.	Antenna Type	Peak Gain
1	N/A	PCB-T2889A	PCB Antenna	N/A

**Channel List**

Channel	Frequency (MHz)
01	13.56

**Test Frequencies in each operating band**

Frequency range over which the device operates in each operating band (Note 1)	Number of test frequencies required	Location of test frequencies inside the operating frequency range (Note 1,2)
$\leq 1$ MHz	1	near centre
$> 1$ MHz and $\leq 10$ MHz	2	1 near high end, 1 near low end
$> 10$ MHz	3	1 near high end, 1 near centre, and 1 near low end

**Note 1:** The frequency range over which the device operates in a given operating band is the difference between the highest and lowest frequencies on which the device can be tuned within that given operating band. The frequency range can be smaller than or equal to the operating band, but cannot be greater than the operating band.

**Note 2:** In the third column of table 1, “near” means as close as possible to or at the centre / low end / high end of the frequency range over which the device operates.

**Firmware / Software Version**

1	Product Name	RFID Reader
2	Model No.	DF700A
3	Test SW Version	N/A
4	RF power setting in TEST SW	<input checked="" type="checkbox"/> RF power setting was not able to alter during testing. <input type="checkbox"/> RF power setting was able to alter during testing. (See the following table)

**Parameters of test software setting**

Type of Modulation	Channel	Frequency (MHz)	Set Value
ASK	01	13.56	Default

The EUT has been pre-tested under the following test modes, and test mode A was the worst case for final test.

The EUT has the following different models, and the difference is shown in the series difference. After laboratory evaluation, the worst mode must be found by pre-test results of radiation 30M-1GHz.

**Pretest Mode**

Mode A : DF710A-U2, ACC-D5280
Mode B : DF700A-00
Mode C : DF710A-00

**Test Mode**

Mode 1 : DF710A-U2, ACC-D5280 -Transmit
---

Note:

1. This device is a RFID Reader with a built-in RFID transceiver.
2. These tests were performed on a sample of equipment to demonstrate compliance with 47 CFR FCC Part 15, Subpart C (Section 15.225).
3. The radiation measurements are performed in X, Y, Z axis positioning. Only the X axis worst case is shown in the report.



## 1.4 Configuration of Tested System

Radiation

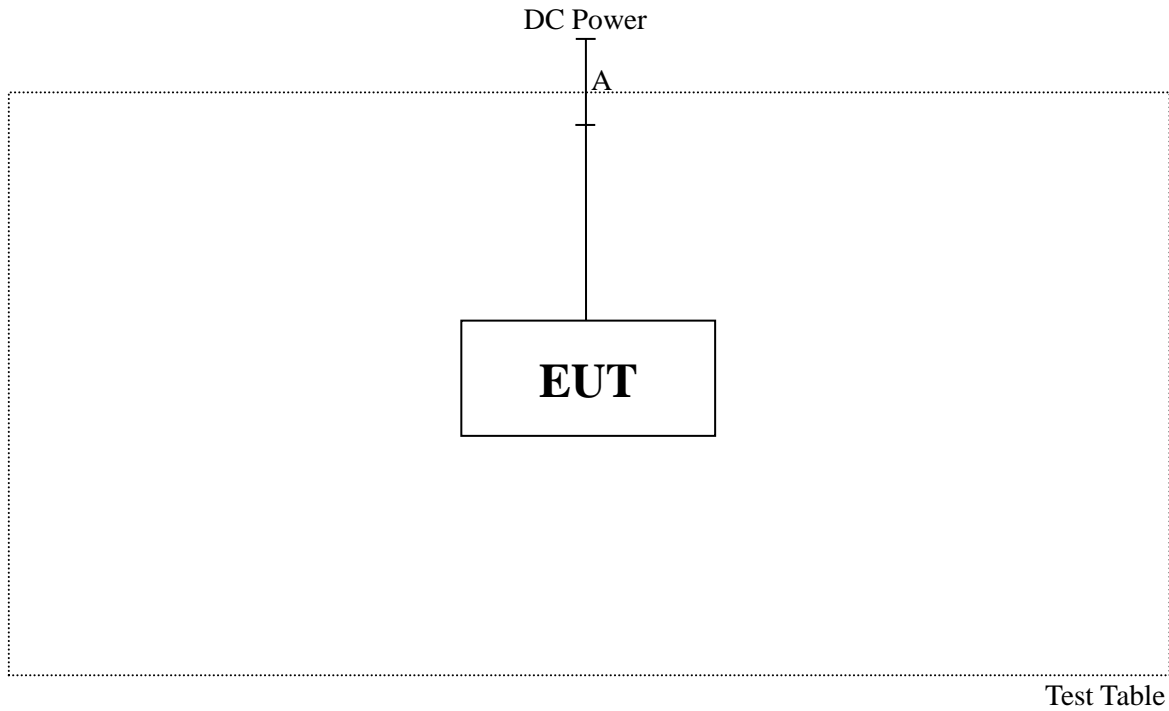

## 1.5 EUT Exercise Software

1. Setup the EUT as shown in Section 1.4
2. Turn on the power of all equipment.
3. Using tag to trigger RFID continuous transmission.
4. Verify that the EUT works properly.

## 1.6 Tested System Details

The types for all equipment, plus descriptions of all cables used in the tested system (including inserted cards) are:

No.	Signal Cable Type	Signal cable Description
A	DC Power Cable	Non-shielded, Non-Core, 1m

## 1.7 Test Facility

Items	Required (IEC 60068-1)
Temperature (°C)	15-35
Humidity (% RH)	25-75
Barometric pressure (mbar)	860-1060

**Description:** Accredited by TAF  
Accredited Number: 2965

**Issued by:** Wendell Industrial Co., Ltd

**Lab Address:** 6F/6F-1, No.188, Baoqiao Rd., Xindian Dist.,  
New Taipei City 23145, Taiwan R.O.C

**Test Lab:** Wendell EMC & RF Laboratory

**Test Location:** No. 119, Wugong 3rd Rd., Wugu Dist.,  
New Taipei City 248, Taiwan (R.O.C.)

**Designation Number:** TW0025

**Test Firm Registration Number:** 665221

## 1.8 Measurement Uncertainty

ISO/IEC 17025 requires that an estimate of the measurement uncertainties associated with the emissions test results be included in the report. The measurement uncertainties given below are based on a 95% confidence (level based on a coverage factor K=2)

Measurement Project	Condition	Expended Uncertainty
AC Conducted Emission	0.150 ~ 30 MHz	± 2.64 dB
Radiated Emission	0.009 ~ 30 MHz	± 3.7 dB
	30 ~ 1000 MHz	± 3.9 dB
	1000 ~ 18000 MHz	± 4.5 dB
	18000 ~ 40000 MHz	± 4.3 dB
RF Power, Conducted	Conducted Measuring	± 0.75 dB
Occupied Bandwidth	Conducted Measuring	± 2.4 %
Power Density	Conducted Measuring	± 1.2 dB
Duty Cycle and Dwell Time	Conducted Measuring	± 0.9 %
Conducted Unwanted Emission Strength	Conducted Measuring	± 1.4 dB
DC Power Supply	--	± 2.0 %
Temperature	--	± 0.55 °C
Humidity	--	± 3.1 %

**Note:** Please note that the measurement uncertainty are provided for informational purpose only and are not used in determining the Pass/Fail results.

## 1.9 List of Test Equipment

### For Conducted measurements / W08-Conducted Measurement

Equipment	Manufacturer	Model No.	Serial No.	Cal. Date	Due Date
✓ Spectrum analyzer	Keysight	N9010A	SG50420005	2022/08/01	2023/07/31
Wideband Peak Power Meter	Anritsu	ML2495A	1733007	2022/09/06	2023/09/05
Pulse Power Sensor + Precision Adaptor	Anritsu	MA2411B	1726022	2022/09/06	2023/09/05
✓ Temperature Chamber	TAICHY	MHK-225LK	1061121	2023/04/24	2024/04/23
Wireless Connectivity Tester	R&S	CMW270	101307	2023/05/29	2024/05/28
Attenuator	MVE	MVE2211-10	CT-9-056	2022/08/10	2023/08/09
Attenuator	MVE	MVE2211-20	CT-9-057	2022/08/10	2023/08/09
Attenuator	MVE	MVE2211-30	CT-9-058	2022/08/10	2023/08/09
Power Divider	MVE	MVE8546	170826003	2022/08/10	2023/08/09
Power Splitter	MVE	MVE8547	170302047	2022/08/11	2023/08/10
DC Power Supply	GW INSTEK	GPC-3060D	GER817636	2022/08/09	2023/08/08

Remark:

1. All equipments are calibrated every one year.
2. The test instruments marked with “✓” are used to measure the final test results.

**For AC Conduction measurements / W08-CE**

Equipment	Manufacturer	Model No.	Serial No.	Cal. Date	Due Date
EMI Test Receiver	R&S	ESR3	102309	2022/6/15	2023/6/14
2-Line V-Network LISN	R&S	ENV216	101185	2022/6/20	2023/6/19
LISN	SCHWARZBECK	NSLK 8127RC	05028	2022/6/20	2023/6/19
Transient Limiter	EM Electronics Corporation	EM-7600	857	2022/6/20	2023/6/19
50ohm Cable	EMCI	EMCCFD300-BM-BM- 5000	170612	2022/6/17	2023/6/16
50 ohm terminal impedance	HUBER+SUHNER	50 ohm terminal impedance	CT-1-109-1	2022/6/17	2023/6/16

## Remark:

1. All equipments are calibrated every one year.
2. The test instruments marked with “√” are used to measure the final test results.
3. Test Software version: FARAD EZ-EMC Ver.EMC-CON 3A1

**For Radiated measurements / W08-996-2**

Equipment	Manufacturer	Model No.	Serial No.	Cal. Date	Due Date
✓ EMI Receiver	Keysight	N9038A	MY51210173	2022/08/17	2023/08/16
✓ Spectrum Analyzer	Keysight	N9010A	MY52220228	2022/08/16	2023/08/15
✓ Active Loop Antenna	Schwarzbeck	FMZB 1513-60B	00033	2023/05/08	2024/05/07
✓ TRILOG super broad Antenna	Schwarzbeck	VULB 9168	VULB 9168-700 & 20E03	2022/08/12	2023/08/11
Horn Antenna	Schwarzbeck	BBHA 9120D	01767	2022/08/24	2023/08/23
Horn Antenna	Schwarzbeck	BBHA 9170	703	2022/08/29	2023/08/28
✓ Pre-Amplifier	EMEC	EMC330	060774	2022/08/17	2023/08/16
Pre-Amplifier	EMEC	EM01G18G	060648	2022/08/18	2023/08/17
Pre-Amplifier	JPT	JPA0118-55-303K	1910001800055003	2022/08/18	2023/08/17
Pre-Amplifier	EMCI	EMC184045SE	980515	2022/08/18	2023/08/17
✓ Cable	EMEC	EM-CB400	105060103	2022/08/18	2023/08/17
✓ Cable	EMEC	EM-CB400	105060102	2022/08/18	2023/08/17
✓ Cable	EMEC	EM-CB400	105060101	2022/08/18	2023/08/17
RF Cable	HUBER+SUHNER	SF102	MY2752/2	2022/08/17	2023/08/16
RF Cable	MVE	280280.LL266.1200	B60028C	2022/08/17	2023/08/16
RF Cable	EMCI	EMC102-KM-KM-600	190646	2022/08/17	2023/08/16
RF Cable	MVE	140140.LL404.700	B90014C	2022/07/28	2023/07/27
RF Cable	MVE	140140.LL404.300	B90006C	2022/08/17	2023/08/16
RF Filter	EMEC	BRF-2400-2500	002	2022/08/17	2023/08/16
RF Filter	EMEC	BRF-5150-5350	104	2022/08/17	2023/08/16
RF Filter	EMEC	BRF-5470-5725	092	2022/08/17	2023/08/16
RF Filter	EMEC	BRF-5725-5875	091	2022/08/17	2023/08/16
RF Filter	EMEC	HPF-2800	002	2022/08/17	2023/08/16
RF Filter	EMEC	HPF-5850	059	2022/08/17	2023/08/16
SMA Notch Filter	MVE	MFN-902.928.S1	190604001	2022/08/17	2023/08/16

Remark:

1. All equipments are calibrated every one year.
2. The test instruments marked with “✓” are used to measure the final test results.
3. Test Software version: FARAD EZ-EMC Ver.WD-03A1-1

## **2 Test Result**

### **2.1 Antenna Requirement**

#### **2.1.1 Applicable Standard**

An intentional radiator shall be designed to ensure that no antenna other than that furnished by the responsible party shall be used with the device. The use of a permanently attached antenna or of an antenna that uses a unique coupling to the intentional radiator shall be considered sufficient to comply with the provisions of this section. The manufacturer may design the unit so that a broken antenna can be replaced by the user, but the use of a standard antenna jack or electrical connector is prohibited.

#### **2.1.2 Antenna Connected Construction**

Non-standard antenna connector is used.



## 2.2 20dB Spectrum Bandwidth Measurement

### 2.2.1 Limit

Intentional radiators must be designed to ensure that the 20dB emission bandwidth in the specific band 13.553~13.567MHz.

### 2.2.2 Test Setup



### 2.2.3 Test Procedure

Refer to ANSI C63.10 : 2013 clause 6.9

### 2.2.4 Test Result

Operating Frequency Band : 13.553~13.567 MHz

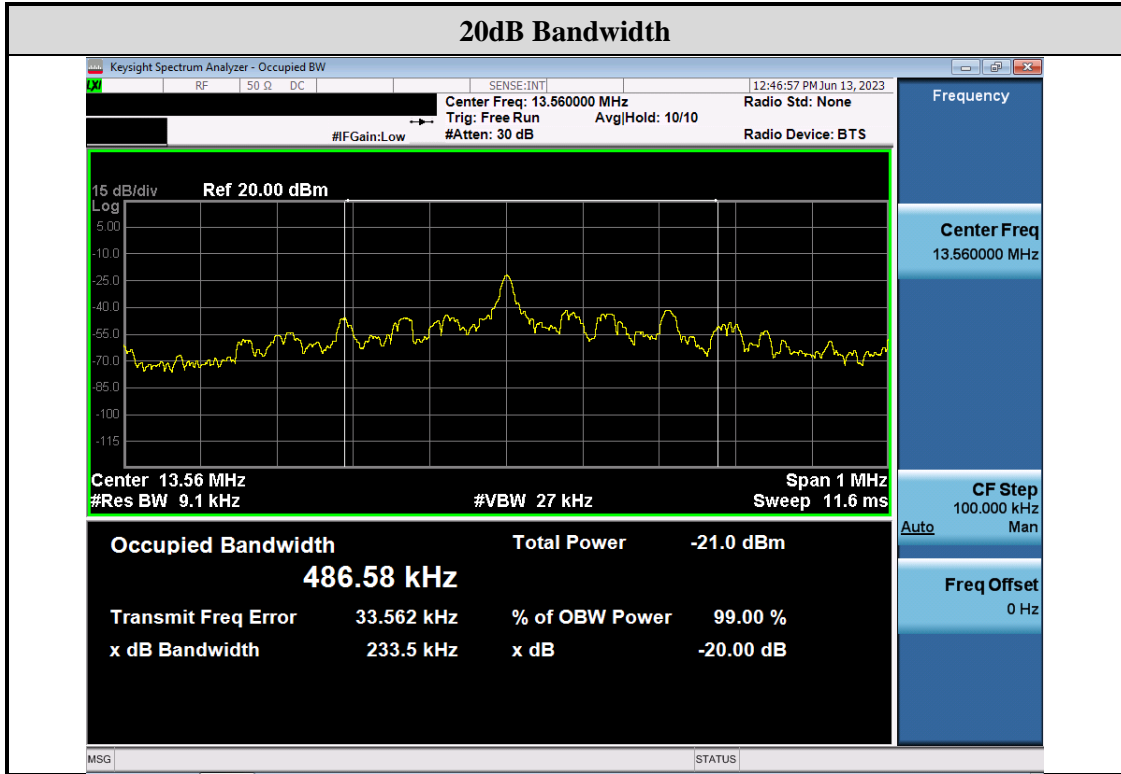

## 2.3 Frequency Stability Measurement

### 2.3.1 Limit

The frequency tolerance of the carrier signal shall be maintained within  $\pm 0.01\%$  (100ppm) of the operating frequency over a temperature variation of  $-20^{\circ}\text{C}$  to  $+50^{\circ}\text{C}$  at normal supply voltage, and for a variation in the primary supply voltage from 85% to 115% of the rated supply voltage at a temperature of  $20^{\circ}\text{C}$ .

### 2.3.2 Test Setup

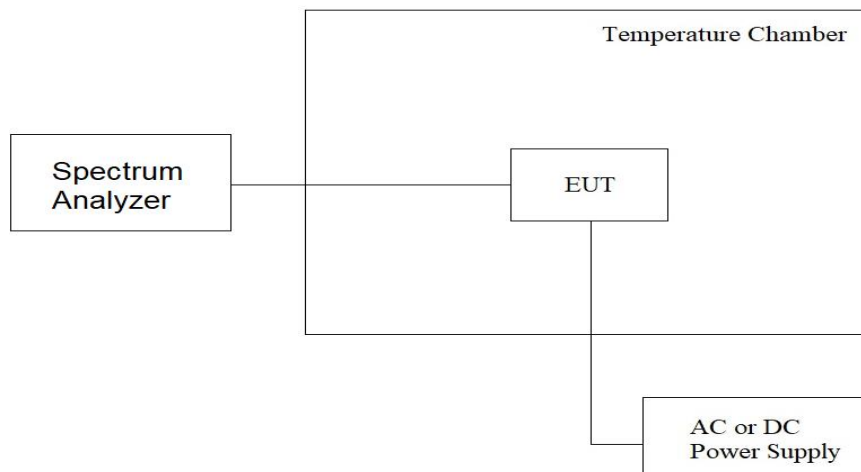

### 2.3.3 Test Procedure

1. Set the spectrum analyzer span to view the entire emissions bandwidth.
2. The  $f_c$  is declaring of channel frequency. Then the frequency error formula is  $(f_c - f) / f_c \times 10^6$  ppm and the limit is less than  $\pm 100$ ppm.
3. Extreme temperature rule is  $-20^{\circ}\text{C} \sim 50^{\circ}\text{C}$ .

### 2.3.4 Test Result

Temperature (°C)	Voltage	Observe Time	Frequency	Delta Frequency (Hz)	Delta Frequency (%)	Limit (%)	Result
20	Normal	start	13.560100	100	0.0007	±0.01%	Pass
		2 min	13.559400	-600	-0.0044	±0.01%	Pass
		5 min	13.559200	-800	-0.0059	±0.01%	Pass
		10 min	13.560100	100	0.0007	±0.01%	Pass
20	High(+15%)	start	13.559100	-900	-0.0066	±0.01%	Pass
		2 min	13.559900	-100	-0.0007	±0.01%	Pass
		5 min	13.560100	100	0.0007	±0.01%	Pass
		10 min	13.560200	200	0.0015	±0.01%	Pass
20	Low(-15%)	start	13.560500	500	0.0037	±0.01%	Pass
		2 min	13.560900	900	0.0066	±0.01%	Pass
		5 min	13.561000	1000	0.0074	±0.01%	Pass
		10 min	13.560700	700	0.0052	±0.01%	Pass
50	Normal	start	13.561000	1000	0.0074	±0.01%	Pass
		2 min	13.559600	-400	-0.0029	±0.01%	Pass
		5 min	13.559200	-800	-0.0059	±0.01%	Pass
		10 min	13.559200	-800	-0.0059	±0.01%	Pass
40	Normal	start	13.559800	-200	-0.0015	±0.01%	Pass
		2 min	13.559700	-300	-0.0022	±0.01%	Pass
		5 min	13.560800	800	0.0059	±0.01%	Pass
		10 min	13.560700	700	0.0052	±0.01%	Pass
30	Normal	Start	13.561000	1000	0.0074	±0.01%	Pass
		2 min	13.560000	0	0.0000	±0.01%	Pass
		5 min	13.559700	-300	-0.0022	±0.01%	Pass
		10 min	13.560600	600	0.0044	±0.01%	Pass
10	Normal	Start	13.560100	100	0.0007	±0.01%	Pass
		2 min	13.559200	-800	-0.0059	±0.01%	Pass
		5 min	13.559700	-300	-0.0022	±0.01%	Pass
		10 min	13.559400	-600	-0.0044	±0.01%	Pass
0	Normal	start	13.559200	-800	-0.0059	±0.01%	Pass
		2 min	13.560800	800	0.0059	±0.01%	Pass
		5 min	13.560900	900	0.0066	±0.01%	Pass
		10 min	13.559800	-200	-0.0015	±0.01%	Pass

-10	Normal	start	13.559800	-200	-0.0015	±0.01%	Pass
		2 min	13.559900	-100	-0.0007	±0.01%	Pass
		5 min	13.559700	-300	-0.0022	±0.01%	Pass
		10 min	13.560800	800	0.0059	±0.01%	Pass
-20	Normal	star	13.559700	-300	-0.0022	±0.01%	Pass
		2 min	13.560100	100	0.0007	±0.01%	Pass
		5 min	13.560700	700	0.0052	±0.01%	Pass
		10 min	13.560600	600	0.0044	±0.01%	Pass

## 2.4 Field Strength of Fundamental Emissions Measurement

### 2.4.1 Limit

Rules and specifications	FCC Part 15 Subpart C Paragraph 15.225 Limits		
Freq. of Emission (MHz)	Field Strength ( $\mu\text{V/m}$ ) at 30m	Field Strength ( $\text{dB}\mu\text{V/m}$ ) at 30m	Field Strength ( $\text{dB}\mu\text{V/m}$ ) at 3m
13.553~13.567	15848	84.0	124.0
13.410 – 13.553 and 13.567 – 13.710	334	50.5	90.5
13.110 – 13.410 and 13.710 – 14.010	106	40.5	80.5
Outside of the 13.110 – 14.010	See 15.209 Limits		

Remark:

1. Emission level ( $\text{dB}\mu\text{V/m}$ ) = 20 log Emission level ( $\mu\text{V/m}$ )
2. Distance refers to the distance in meters between the measuring instrument antenna and the closed point of any part of the device or system.
3. The emission limit in this paragraph is based on measurement instrumentation employing an quasi-peak detector.

FCC Part 15 Subpart C Paragraph 15.209 Limits		
Frequency (MHz)	Field Strength ( $\mu\text{V/m}$ )	Measurement Distance (m)
0.009 – 0.490	2400/F(kHz)	300
0.490 – 1.705	24000/F(kHz)	30
1.705 – 30.0	30	30
30 – 88	100	3
88 – 216	150	3
216 - 960	200	3
Above 960	500	3

Remark:

1. Emission level ( $\text{dB}\mu\text{V/m}$ ) = 20 log Emission level ( $\mu\text{V/m}$ )
2. In the Above Table, the tighter limit applies at the band edges.
3. The emission limit in this paragraph is based on a measurement frequency below 1GHz instrumentation employing a quasi-peak detector.

## 2.4.2 Test Setup

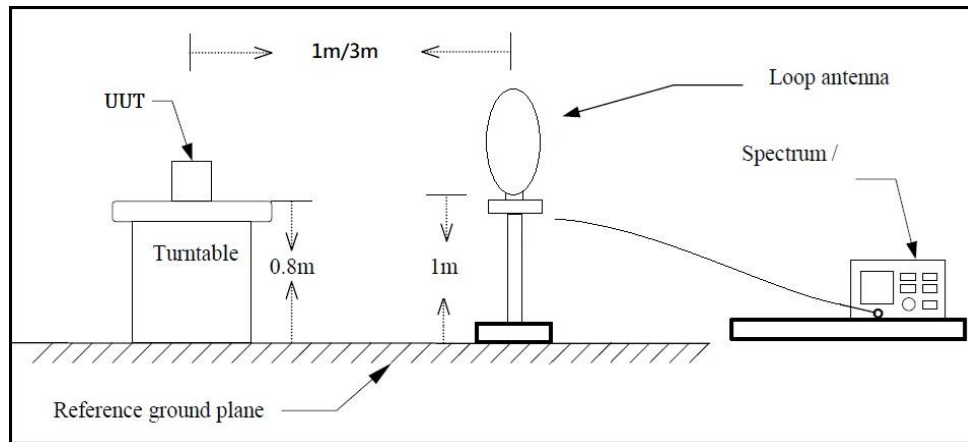

## 2.4.3 Test Procedure

1. For Fundamental emissions, use the receiver to measure QP reading.
2. When the radiated emissions limits are expressed in terms of the average value of the emissions, and pulsed operation is employed, the measurement field strength shall be determined by averaging over one complete pulse train, including blanking intervals, as long as the pulse train does not exceed 0.1 seconds. As an alternative (provided the transmitter operates for longer than 0.1 seconds) or in cases where the pulse train exceeds 0.1 seconds, the measured field strength shall be determined from the average absolute voltage during a 0.1 second interval during which the field strength is at its maximum value.
4. Compliance with the spectrum mask is tested with RBW = 9kHz.

### 2.4.4 Test Result

<b>Test Mode :</b>	Mode 1 : DF710A-U2, ACC-D5280 -Transmit	<b>Test Date :</b>	2023/06/16
<b>Test Frequency :</b>	13.56 MHz	<b>Temperature :</b>	23.1 °C
<b>Polarization :</b>	Horizontal ; X axis	<b>Relative Humidity :</b>	35.6 %

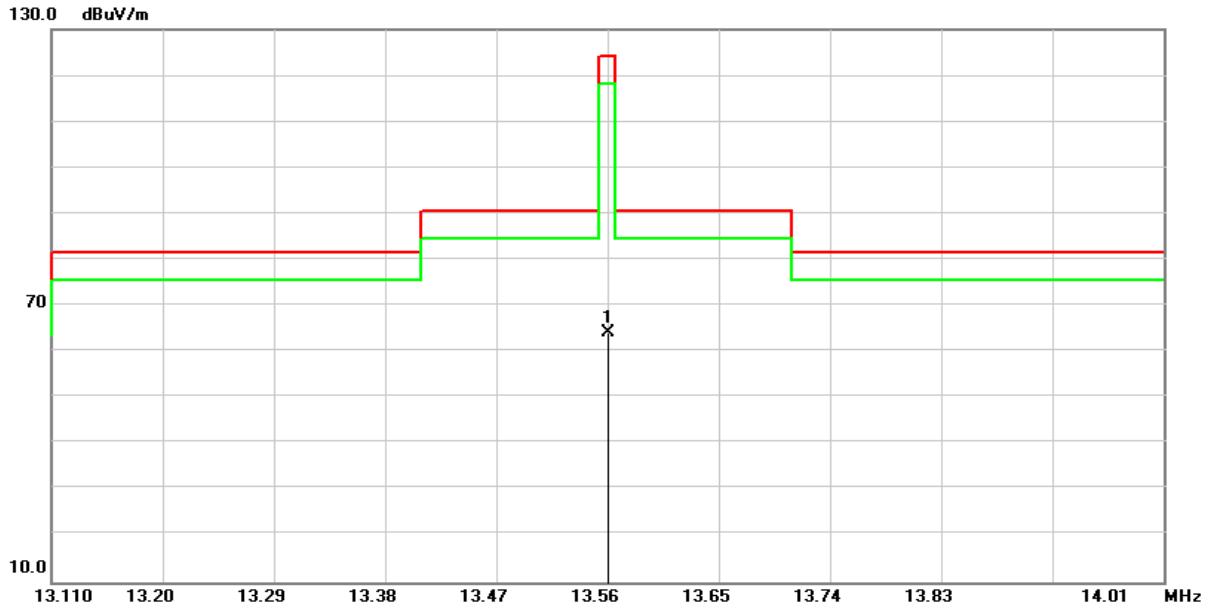

No.	Frequency (MHz)	Reading (dBuV/m)	Correct Factor (dB/m)	Result (dBuV/m)	Limit (dBuV/m)	Margin (dB)	Remark
1	13.5600	42.87	21.26	64.13	124.00	-59.87	peak

**Remark :**

- (1) Correction Factor = Antenna factor + Cable loss – Amplifier gain
- (2) Result Value = Reading Level + Correct Factor
- (3) Margin Level = Measurement Value – Limit Value



<b>Test Mode :</b>	Mode 1 : DF710A-U2, ACC-D5280 -Transmit	<b>Test Date :</b>	2023/06/16
<b>Test Frequency :</b>	13.56 MHz	<b>Temperature :</b>	23.1 °C
<b>Polarization :</b>	Vertical ; X axis	<b>Relative Humidity :</b>	35.6 %

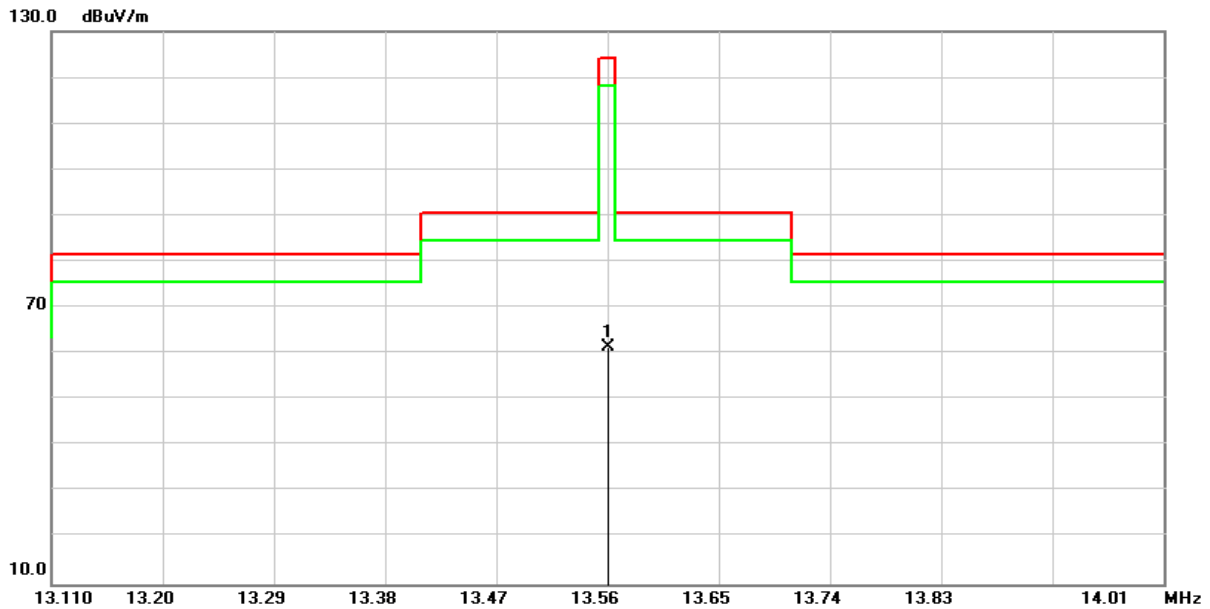

No.	Frequency (MHz)	Reading (dBuV/m)	Correct Factor (dB/m)	Result (dBuV/m)	Limit (dBuV/m)	Margin (dB)	Remark
1	13.5600	40.06	21.26	61.32	124.00	-62.68	peak

**Remark :**

- (1) Correction Factor = Antenna factor + Cable loss – Amplifier gain
- (2) Result Value = Reading Level + Correct Factor
- (3) Margin Level = Measurement Value – Limit Value

## 2.5 Radiated Emissions Measurement

### 2.5.1 Limit

The field strength of any emissions appearing outside of the 13.110-14.010 MHz band shall not exceed the general radiated emission limits in Section 15.209. In addition, radiated emissions which fall in the restricted bands, as defined in Section 15.205, must also comply with the radiated emission limits specified in Section 15.209

### 2.5.2 Test Setup

#### Below 30MHz

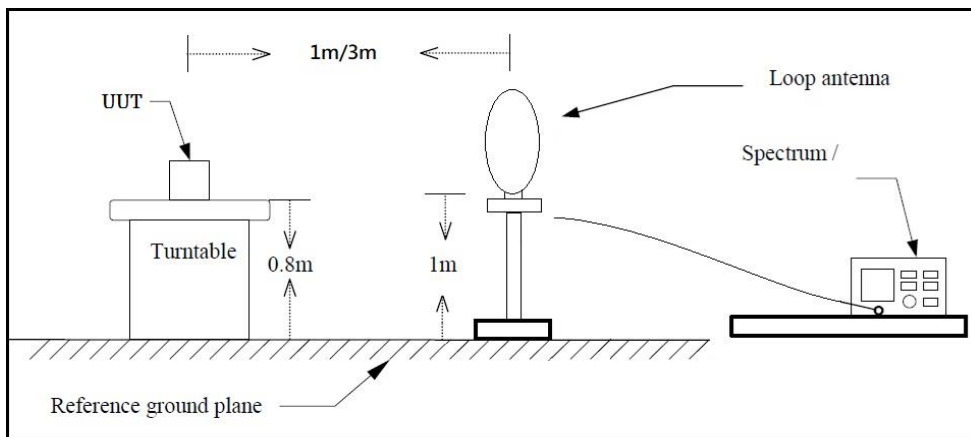

#### Above 30MHz

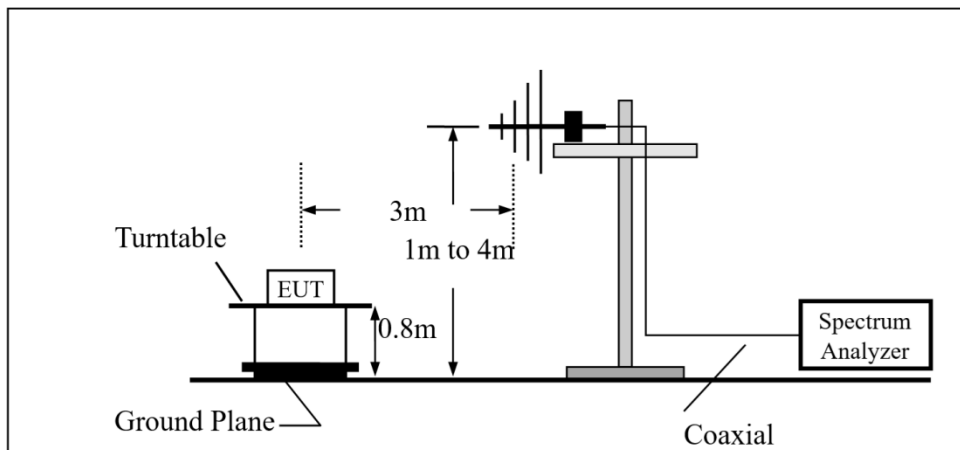

### 2.5.3 Test Procedure

The EUT was setup according to ANSI C63.10, 2013 for compliance to FCC 47CFR 15.225 requirements.

#### **For Radiated emission below 30MHz**

- (1) The EUT was placed on the top of a rotating table 0.8 meters above the ground in a 3 meter chamber room. The table was rotated 360 degrees to determine the position of the highest radiation.
- (2) The EUT was set 3 meters away from the interference-receiving antenna, which was mounted on the top of a variable-height antenna tower.
- (3) Parallel, perpendicular, and ground-parallel orientations of the antenna are set to make the measurement.
- (4) For each suspected emission, the EUT was arranged to its worst case and the rotatable table was turned from 0 degrees to 360 degrees to find the maximum reading.
- (5) The test-receiver system was set to Quasi-Peak Detect Function and Specified Bandwidth with Maximum Hold Mode.

#### **For Radiated emission Above 30MHz**

- (1) The EUT was placed on the top of a rotating table 0.8 meters above the ground at 3 meter chamber room for the test. The table was rotated 360 degrees to determine the position of the highest radiation.
- (2) The EUT was set 3 meters away from the interference-receiving antenna, the height of the antenna is varied from 1 meter to 4 meters above the ground to determine the maximum value of the field strength.
- (3) Parallel, perpendicular, and ground-parallel orientations of the antenna are set to make the measurement.
- (4) For each suspected emission, the EUT was arranged to its worst case and the rotatable table was turned from 0 degrees to 360 degrees to find the maximum reading.
- (5) The test-receiver system was set to quasi-peak detect function and specified bandwidth with maximum hold mode when the test frequency is below 1 GHz.

## 2.5.4 Test Result

### Below 30 MHz Data

<b>Test Mode :</b>	Mode 1 : DF710A-U2, ACC-D5280 -Transmit	<b>Test Date :</b>	2023/06/16
<b>Test Frequency :</b>	13.56 MHz	<b>Temperature :</b>	23.1 °C
<b>Polarization :</b>	Horizontal ; X axis	<b>Relative Humidity :</b>	35.6 %

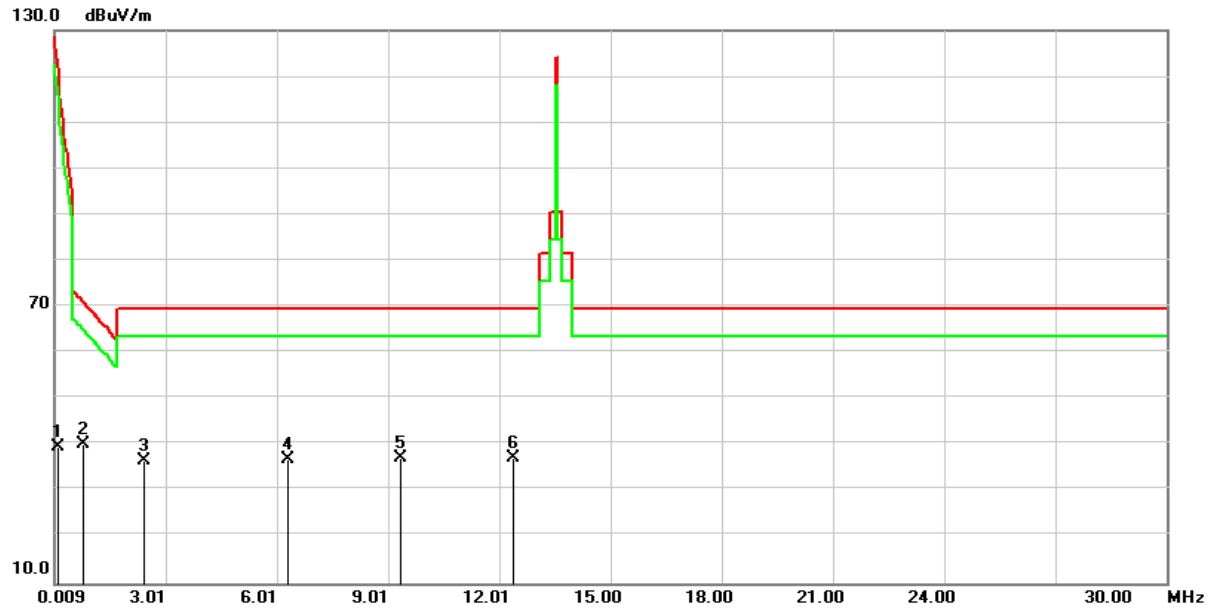

No.	Frequency (MHz)	Reading (dBuV/m)	Correct Factor (dB/m)	Result (dBuV/m)	Limit (dBuV/m)	Margin (dB)	Remark
1	0.1004	20.67	18.76	39.43	107.57	-68.14	QP
2	0.8067	20.63	19.39	40.02	69.47	-29.45	QP
3	2.4186	17.34	19.22	36.56	69.54	-32.98	QP
4	6.2991	15.93	20.86	36.79	69.54	-32.75	QP
5	9.3438	16.36	20.90	37.26	69.54	-32.28	QP
6	12.3885	15.77	21.42	37.19	69.54	-32.35	QP

#### Remark :

- (1) Correction Factor = Antenna factor + Cable loss – Amplifier gain
- (2) Result Value = Reading Level + Correct Factor
- (3) Margin Level = Measurement Value – Limit Value
- (4) The other emission levels were very low against the limit

<b>Test Mode :</b>	Mode 1 : DF710A-U2, ACC-D5280 -Transmit	<b>Test Date :</b>	2023/06/16
<b>Test Frequency :</b>	13.56 MHz	<b>Temperature :</b>	23.1 °C
<b>Polarization :</b>	Vertical ; X axis	<b>Relative Humidity :</b>	35.6 %

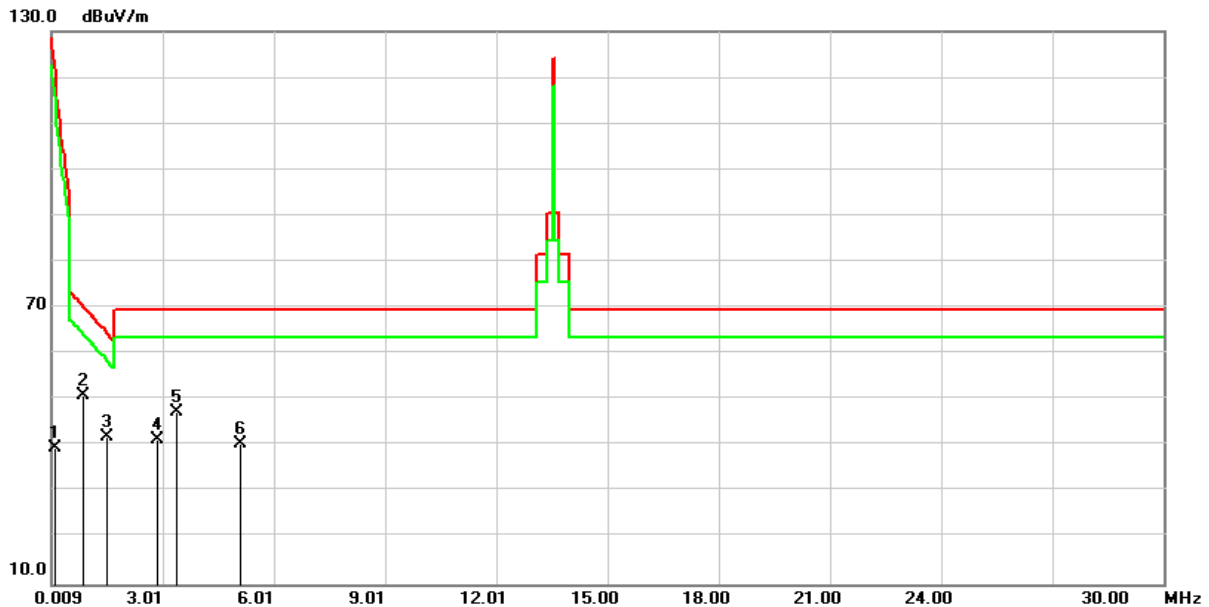

No.	Frequency (MHz)	Reading (dBuV/m)	Correct Factor (dB/m)	Result (dBuV/m)	Limit (dBuV/m)	Margin (dB)	Remark
1	0.0994	20.69	18.74	39.43	107.66	-68.23	QP
2	0.8366	31.69	19.36	51.05	69.15	-18.10	QP
3	1.4932	22.82	19.27	42.09	64.12	-22.03	QP
4	2.8365	22.18	19.19	41.37	69.54	-28.17	QP
5	3.3738	27.90	19.30	47.20	69.54	-22.34	QP
6	5.1051	20.63	19.79	40.42	69.54	-29.12	QP

**Remark :**

- (1) Correction Factor = Antenna factor + Cable loss – Amplifier gain
- (2) Result Value = Reading Level + Correct Factor
- (3) Margin Level = Measurement Value – Limit Value
- (4) The other emission levels were very low against the limit

### Above 30MHz Data

<b>Test Mode :</b>	Mode 1 : DF710A-U2, ACC-D5280 -Transmit	<b>Test Date :</b>	2023/06/16
<b>Test Frequency :</b>	13.56 MHz	<b>Temperature :</b>	23.1 °C
<b>Polarization :</b>	Horizontal	<b>Relative Humidity :</b>	35.6 %

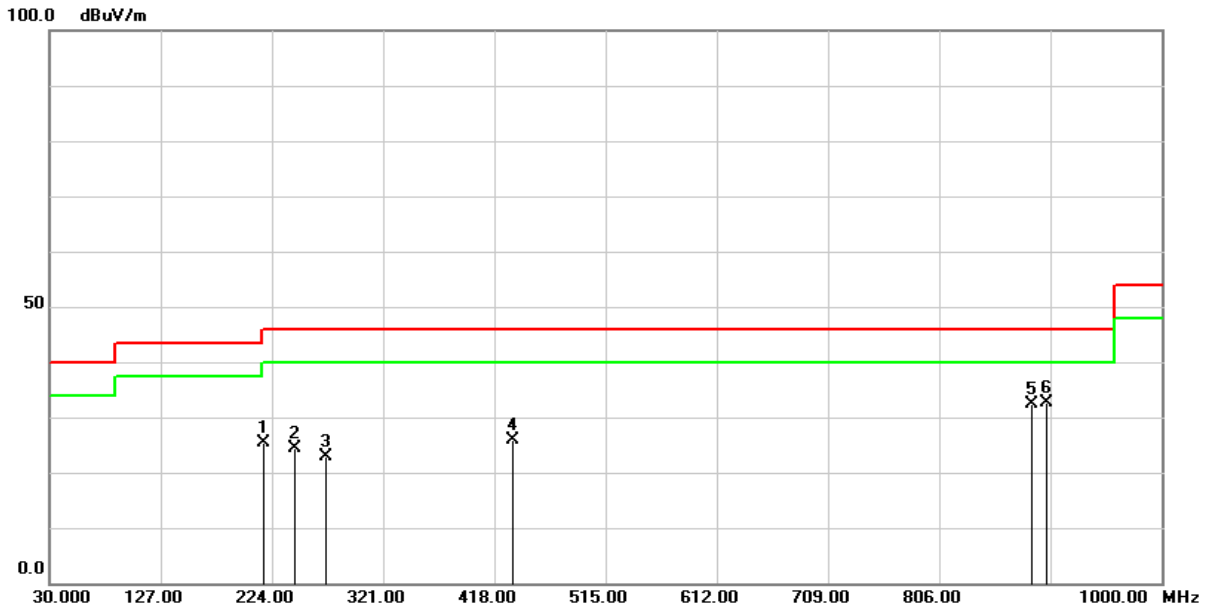

No.	Frequency (MHz)	Reading (dBuV/m)	Correct Factor (dB/m)	Result (dBuV/m)	Limit (dBuV/m)	Margin (dB)	Remark
1	217.2100	39.73	-14.29	25.44	46.00	-20.56	QP
2	244.3700	36.42	-12.12	24.30	46.00	-21.70	QP
3	271.5300	33.76	-10.95	22.81	46.00	-23.19	QP
4	433.5200	31.80	-6.01	25.79	46.00	-20.21	QP
5	886.5100	29.63	2.76	32.39	46.00	-13.61	QP
6	900.0900	29.56	3.04	32.60	46.00	-13.40	QP

#### Remark :

- (1) Correction Factor = Antenna factor + Cable loss – Amplifier gain
- (2) Result Value = Reading Level + Correct Factor
- (3) Margin Level = Measurement Value –Limit Value
- (4) The other emission levels were very low against the limit

<b>Test Mode :</b>	Mode 1 : DF710A-U2, ACC-D5280 -Transmit	<b>Test Date :</b>	2023/06/16
<b>Test Frequency :</b>	13.56 MHz	<b>Temperature :</b>	23.1 °C
<b>Polarization :</b>	Vertical	<b>Relative Humidity :</b>	35.6 %

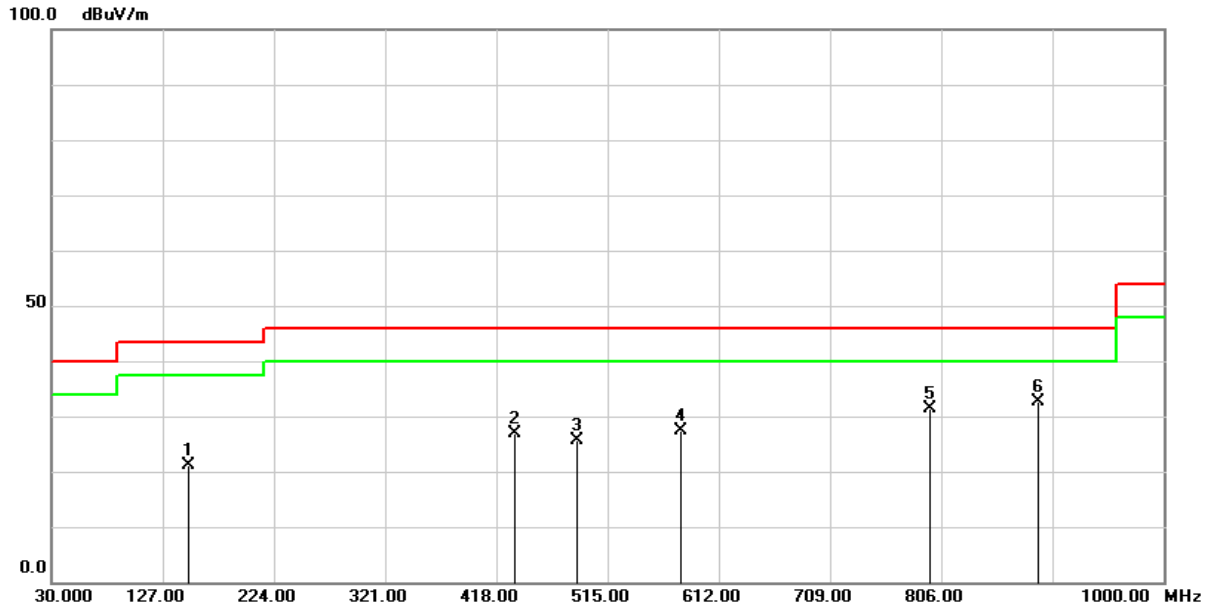

No.	Frequency (MHz)	Reading (dBuV/m)	Correct Factor (dB/m)	Result (dBuV/m)	Limit (dBuV/m)	Margin (dB)	Remark
1	149.3100	32.23	-11.08	21.15	43.50	-22.35	QP
2	433.5200	32.92	-6.01	26.91	46.00	-19.09	QP
3	487.8400	30.44	-4.93	25.51	46.00	-20.49	QP
4	579.0200	30.31	-2.92	27.39	46.00	-18.61	QP
5	796.3000	29.61	1.71	31.32	46.00	-14.68	QP
6	890.3900	29.90	2.79	32.69	46.00	-13.31	QP

**Remark :**

- (1) Correction Factor = Antenna factor + Cable loss – Amplifier gain
- (2) Result Value = Reading Level + Correct Factor
- (3) Margin Level = Measurement Value –Limit Value
- (4) The other emission levels were very low against the limit

## 2.6 AC Conducted Emissions Measurement

### 2.6.1 Limit

Frequency (MHz)	FCC Part 15 Subpart C Paragraph 15.207 (dB $\mu$ V) Limit	
	Quasi-peak	Average
0.15 to 0.5	66 to 56*	56 to 46*
0.50 to 5.0	56	46
5.0 to 30.0	60	50

\*Decreases with the logarithm of the frequency

### 2.6.2 Test Setup

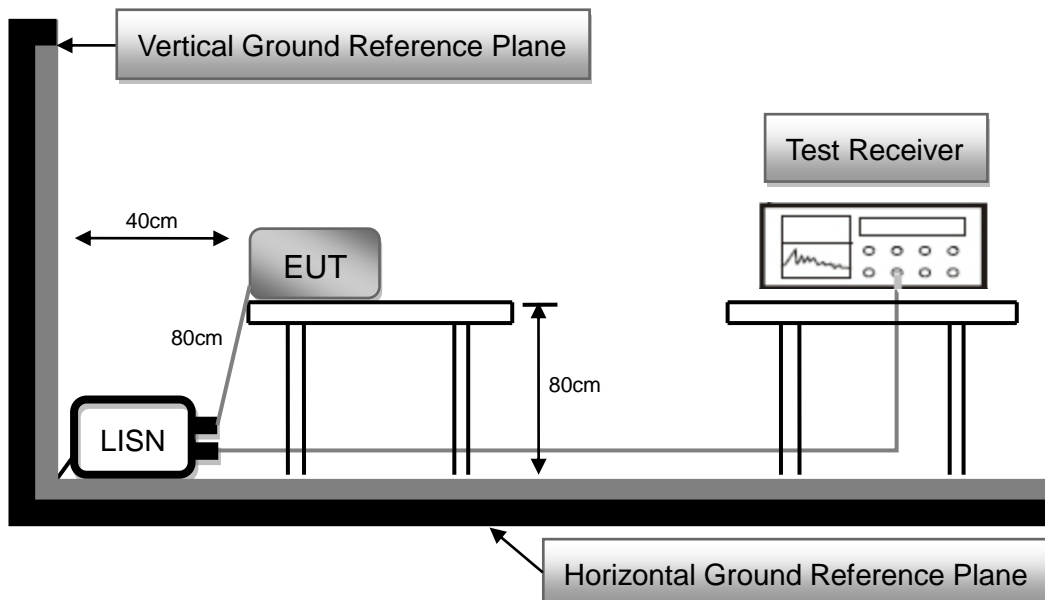



### 2.6.3 Test Procedure

1. The EUT was placed 0.8 meter height wooden table from the horizontal ground plane with EUT being connected to power source through a line impedance stabilization network (LISN). The LISN at least be 80 cm from nearest chassis of EUT.
2. The line impedance stabilization network (LISN) provides 50 ohm/50uH of coupling impedance for the measuring instrument. All other support equipments powered from additional LISN(s).
3. Interrelating cables that hang closer than 40 cm to the ground plane shall be folded back and forth in the center forming a bundle. All I/O cables were positioned to simulate typical usage.
4. All I/O cables that are not connected to a peripheral shall be bundle in the center. The end of the cable may be terminated, if required, using the correct terminating impedance. The overall length shall not exceed 1 m.
5. The EMI test receiver connected to LISN powering the EUT. The actual test configuration, please refer to EUT test photos.
6. The receiver scanned from 150kHz to 30MHz for emissions in each of test modes. Conducted emissions were invested over the frequency range from 0.15MHz to 30MHz using a receiver bandwidth of 9kHz. A scan was taken on both power lines, Line and Neutral, recording at least six highest emissions.
7. The EUT and cable configuration of the above highest emission levels were recorded. The Test Data of the worst case was recorded.

Note: For a device with a permanent or detachable antenna operating at or below 30 MHz, the FCC will accept measurements performed with a suitable dummy load in lieu of the antenna.

## 2.6.4 Test Result

Owing to the DC operation of EUT, this test item is not performed.

--- END ---