



A D T

FCC TEST REPORT

REPORT NO.: RF110701C18C
MODEL NO.: PW-DN427
FCC ID: WWMDN427V3
RECEIVED: Jul. 1, 2011
TESTED: Jul. 11 ~ 25, 2011 & Jul. 10, 2012
ISSUED: Jul. 13, 2012

APPLICANT: Proware Technologies Co Ltd.

ADDRESS: 2nd F1 East Wing, South Section, Factory Building
24, Science & Technology Park, Shennan
Rd, Nanshan District, Shenzhen

ISSUED BY: Bureau Veritas Consumer Products Services
(H.K.) Ltd., Taoyuan Branch

LAB ADDRESS: No. 47, 14th Ling, Chia Pau Vil., Lin Kou Dist.,
New Taipei City, Taiwan, R.O.C.

This report should not be used by the client to claim product certification, approval, or endorsement by TAF or any government agencies.



This report is for your exclusive use. Any copying or replication of this report to or for any other person or entity, or use of our name or trademark, is permitted only with our prior written permission. This report sets forth our findings solely with respect to the test samples identified herein. The results set forth in this report are not indicative or representative of the quality or characteristics of the lot from which a test sample was taken or any similar or identical product unless specifically and expressly noted. Our report includes all of the tests requested by you and the results thereof based upon the information that you provided to us. You have 60 days from date of issuance of this report to notify us of any material error or omission caused by our negligence, provided, however, that such notice shall be in writing and shall specifically address the issue you wish to raise. A failure to raise such issue within the prescribed time shall constitute your unqualified acceptance of the completeness of this report, the tests conducted and the correctness of the report contents. Unless specific mention, the uncertainty of measurement has been explicitly taken into account to declare the compliance or non-compliance to the specification.



A D T

TABLE OF CONTENTS

RELEASE CONTROL RECORD	4
1. CERTIFICATION	5
2. SUMMARY OF TEST RESULTS	6
2.1 MEASUREMENT UNCERTAINTY	6
3. GENERAL INFORMATION	7
3.1 GENERAL DESCRIPTION OF EUT	7
3.2 DESCRIPTION OF TEST MODES	8
3.2.1 TEST MODE APPLICABILITY AND TESTED CHANNEL DETAIL	9
3.3 DESCRIPTION OF SUPPORT UNITS	11
3.3.1 CONFIGURATION OF SYSTEM UNDER TEST	11
3.4 GENERAL DESCRIPTION OF APPLIED STANDARDS	12
4. TEST TYPES AND RESULTS	13
4.1 RADIATED EMISSION AND BANDEDGE MEASUREMENT	13
4.1.1 LIMITS OF RADIATED EMISSION AND BANDEDGE MEASUREMENT	13
4.1.2 TEST INSTRUMENTS	14
4.1.3 TEST PROCEDURES	15
4.1.4 DEVIATION FROM TEST STANDARD	15
4.1.5 TEST SETUP	16
4.1.6 EUT OPERATING CONDITIONS	16
4.1.7 TEST RESULTS	17
4.2 CONDUCTED EMISSION MEASUREMENT	30
4.2.1 LIMITS OF CONDUCTED EMISSION MEASUREMENT	30
4.2.2 TEST INSTRUMENTS	30
4.2.3 TEST PROCEDURES	31
4.2.4 DEVIATION FROM TEST STANDARD	31
4.2.5 TEST SETUP	31
4.2.6 EUT OPERATING CONDITIONS	31
4.2.7 TEST RESULTS	32
4.3 6dB BANDWIDTH MEASUREMENT	34
4.3.1 LIMITS OF 6dB BANDWIDTH MEASUREMENT	34
4.3.2 TEST SETUP	34
4.3.3 TEST INSTRUMENTS	34
4.3.4 TEST PROCEDURE	34
4.3.5 DEVIATION FROM TEST STANDARD	34
4.3.6 EUT OPERATING CONDITIONS	34
4.3.7 TEST RESULTS	35
4.4 CONDUCTED OUTPUT POWER	39
4.4.1 LIMITS OF CONDUCTED OUTPUT POWER MEASUREMENT	39
4.4.2 TEST SETUP	39



A D T

4.4.3	TEST INSTRUMENTS	39
4.4.4	TEST PROCEDURES	39
4.4.5	DEVIATION FROM TEST STANDARD	39
4.4.6	EUT OPERATING CONDITIONS	39
4.4.7	TEST RESULTS	40
4.5	POWER SPECTRAL DENSITY MEASUREMENT	41
4.5.1	LIMITS OF POWER SPECTRAL DENSITY MEASUREMENT	41
4.5.2	TEST SETUP	41
4.5.3	TEST INSTRUMENTS	41
4.5.4	TEST PROCEDURE	41
4.5.5	DEVIATION FROM TEST STANDARD	41
4.5.6	EUT OPERATING CONDITION	41
4.5.7	TEST RESULTS	42
4.6	CONDUCTED OUT OF BAND EMISSION MEASUREMENT	46
4.6.1	LIMITS OF CONDUCTED OUT OF BAND EMISSION MEASUREMENT	46
4.6.2	TEST SETUP	46
4.6.3	TEST INSTRUMENTS	46
4.6.4	TEST PROCEDURE	46
4.6.5	DEVIATION FROM TEST STANDARD	47
4.6.6	EUT OPERATING CONDITION	47
4.6.7	TEST RESULTS	47
5.	PHOTOGRAPHS OF THE TEST CONFIGURATION	52
6.	INFORMATION ON THE TESTING LABORATORIES	53
7.	APPENDIX A - MODIFICATIONS RECORDERS FOR ENGINEERING CHANGES TO THE EUT BY THE LAB	54



A D T

RELEASE CONTROL RECORD

ISSUE NO.	REASON FOR CHANGE	DATE ISSUED
RF110701C18C	Original release	Jul. 13, 2012

1. CERTIFICATION

PRODUCT: 150Mbps Wireless N USB Adapter
MODEL NO.: PW-DN427
BRAND: PROWARE
APPLICANT: Proware Technologies Co Ltd.
TESTED: Jul. 11 ~ 25, 2011 & Jul. 10, 2012
TEST SAMPLE: PROTOTYPE
STANDARDS: **FCC Part 15, Subpart C (Section 15.247)**
ANSI C63.10-2009

The above equipment has been tested by **Bureau Veritas Consumer Products Services (H.K.) Ltd., Taoyuan Branch**, and found compliance with the requirement of the above standards. The test record, data evaluation & Equipment Under Test (EUT) configurations represented herein are true and accurate accounts of the measurements of the sample's EMC characteristics under the conditions specified in this report.

PREPARED BY : Celia Chen , DATE: Jul. 13, 2012
(Celia Chen / Senior Specialist)

APPROVED BY : Ken Liu , DATE: Jul. 13, 2012
(Ken Liu / Manager)

2. SUMMARY OF TEST RESULTS

The EUT has been tested according to the following specifications:

APPLIED STANDARD: FCC PART 15, SUBPART C (SECTION 15.247)			
STANDARD SECTION	TEST TYPE	RESULT	REMARK
15.207	AC Power Conducted Emission	PASS	Meet the requirement of limit. Minimum passing margin is -15.14dB at 0.189MHz.
15.247(d) 15.209	Radiated Emissions	PASS	Meet the requirement of limit. Minimum passing margin is -0.1dB at 2390.00 & 2483.50MHz.
15.247(d)	Band Edge Measurement	PASS	Meet the requirement of limit.
15.247(a)(2)	6dB bandwidth	PASS	Meet the requirement of limit.
15.247(b)	Conducted power	PASS	Meet the requirement of limit.
15.247(e)	Power Spectral Density	PASS	Meet the requirement of limit.
15.203	Antenna Requirement	PASS	No antenna connector is used.

2.1 MEASUREMENT UNCERTAINTY

Where relevant, the following measurement uncertainty levels have been estimated for tests performed on the EUT as specified in CISPR 16-4-2:

MEASUREMENT	FREQUENCY	UNCERTAINTY
Conducted emissions	150kHz~30MHz	2.41 dB
Radiated emissions	30MHz ~ 1GHz	3.87 dB
	Above 1GHz	3.36 dB

This uncertainty represents an expanded uncertainty expressed at approximately the 95% confidence level using a coverage factor of $k = 2$.



3. GENERAL INFORMATION

3.1 GENERAL DESCRIPTION OF EUT

EUT	150Mbps Wireless N USB Adapter
MODEL NO.	PW-DN427
POWER SUPPLY	5Vdc from host equipment
MODULATION TYPE	CCK, DQPSK, DBPSK for DSSS 64QAM, 16QAM, QPSK, BPSK for OFDM
MODULATION TECHNOLOGY	DSSS, OFDM
TRANSFER RATE	802.11b:11.0/ 5.5/ 2.0/ 1.0Mbps 802.11g: 54.0/ 48.0/ 36.0/ 24.0/ 18.0/ 12.0/ 9.0/ 6.0Mbps 802.11n: up to 150.0Mbps
OPERATING FREQUENCY	2412 ~ 2462MHz
NUMBER OF CHANNEL	11 for 802.11b, 802.11g, 802.11n (20MHz) 7 for 802.11n (40MHz)
OUTPUT POWER	309.0mW
ANTENNA TYPE	Printed antenna with 0dBi gain
ANTENNA CONNECTOR	N/A
DATA CABLE	USB cable (1.0m)
I/O PORTS	USB port
ACCESSORY DEVICES	N/A

NOTE:

1. The EUT is a 150Mbps Wireless N USB Adapter.
2. The EUT incorporates a SISO function. Physically, the EUT provides one completed transmitter and one receiver.

MODULATION MODE	TX FUNCTION
802.11b	1TX
802.11g	1TX
802.11n (20MHz)	1TX
802.11n (40MHz)	1TX

3. The above EUT information is declared by manufacturer and for more detailed features description, please refer to the manufacturer's specifications or user's manual.



3.2 DESCRIPTION OF TEST MODES

11 channels are provided for 802.11b, 802.11g and 802.11n (20MHz):

CHANNEL	FREQUENCY	CHANNEL	FREQUENCY
1	2412MHz	7	2442MHz
2	2417MHz	8	2447MHz
3	2422MHz	9	2452MHz
4	2427MHz	10	2457MHz
5	2432MHz	11	2462MHz
6	2437MHz		

7 channels are provided for 802.11n (40MHz):

CHANNEL	FREQUENCY	CHANNEL	FREQUENCY
3	2422MHz	7	2442MHz
4	2427MHz	8	2447MHz
5	2432MHz	9	2452MHz
6	2437MHz		

3.2.1 TEST MODE APPLICABILITY AND TESTED CHANNEL DETAIL

EUT CONFIGURE MODE	APPLICABLE TO				DESCRIPTION
	RE ³ 1G	RE<1G	PLC	APCM	
-	√	√	√	√	-

Where **RE³1G**: Radiated Emission above 1GHz **RE<1G**: Radiated Emission below 1GHz
PLC: Power Line Conducted Emission **APCM**: Antenna Port Conducted Measurement

NOTE:
The EUT had been pre-tested on the positioned of each 3 axis. The worst case was found when positioned on **X-plane**.

RADIATED EMISSION TEST (ABOVE 1GHz):

- Pre-Scan has been conducted to determine the worst-case mode from all possible combinations between available modulations, data rates and antenna ports (if EUT with antenna diversity architecture).
- Following channel(s) was (were) selected for the final test as listed below.

EUT CONFIGURE MODE	MODE	AVAILABLE CHANNEL	TESTED CHANNEL	MODULATION TECHNOLOGY	MODULATION TYPE	DATA RATE (Mbps)
-	802.11b	1 to 11	1, 6, 11	DSSS	DBPSK	1.0
-	802.11g	1 to 11	1, 6, 11	OFDM	BPSK	6.0
-	802.11n (20MHz)	1 to 11	1, 6, 11	OFDM	BPSK	6.5
-	802.11n (40MHz)	3 to 9	3, 6, 9	OFDM	BPSK	13.5

RADIATED EMISSION TEST (BELOW 1GHz):

- Pre-Scan has been conducted to determine the worst-case mode from all possible combinations between available modulations, data rates and antenna ports (if EUT with antenna diversity architecture).
- Following channel(s) was (were) selected for the final test as listed below.

EUT CONFIGURE MODE	MODE	AVAILABLE CHANNEL	TESTED CHANNEL	MODULATION TECHNOLOGY	MODULATION TYPE	DATA RATE (Mbps)
-	802.11g	1 to 11	11	OFDM	BPSK	6.0

POWER LINE CONDUCTED EMISSION TEST:

- Pre-Scan has been conducted to determine the worst-case mode from all possible combinations between available modulations, data rates and antenna ports (if EUT with antenna diversity architecture).
- Following channel(s) was (were) selected for the final test as listed below.

EUT CONFIGURE MODE	MODE	AVAILABLE CHANNEL	TESTED CHANNEL	MODULATION TECHNOLOGY	MODULATION TYPE	DATA RATE (Mbps)
-	802.11g	1 to 11	11	OFDM	BPSK	6.0



BANDEDGE MEASUREMENT:

- Pre-Scan has been conducted to determine the worst-case mode from all possible combinations between available modulations, data rates and antenna ports (if EUT with antenna diversity architecture).
- Following channel(s) was (were) selected for the final test as listed below.

EUT CONFIGURE MODE	MODE	AVAILABLE CHANNEL	TESTED CHANNEL	MODULATION TECHNOLOGY	MODULATION TYPE	DATA RATE (Mbps)
-	802.11b	1 to 11	1, 11	DSSS	DBPSK	1.0
-	802.11g	1 to 11	1, 11	OFDM	BPSK	6.0
-	802.11n (20MHz)	1 to 11	1, 11	OFDM	BPSK	6.5
-	802.11n (40MHz)	3 to 9	3, 9	OFDM	BPSK	13.5

ANTENNA PORT CONDUCTED MEASUREMENT:

- This item includes all test value of each mode, but only includes spectrum plot of worst value of each mode.
- Pre-Scan has been conducted to determine the worst-case mode from all possible combinations between available modulations, data rates and antenna ports (if EUT with antenna diversity architecture).
- Following channel(s) was (were) selected for the final test as listed below.

EUT CONFIGURE MODE	MODE	AVAILABLE CHANNEL	TESTED CHANNEL	MODULATION TECHNOLOGY	MODULATION TYPE	DATA RATE (Mbps)
-	802.11b	1 to 11	1, 6, 11	DSSS	DBPSK	1.0
-	802.11g	1 to 11	1, 6, 11	OFDM	BPSK	6.0
-	802.11n (20MHz)	1 to 11	1, 6, 11	OFDM	BPSK	6.5
-	802.11n (40MHz)	3 to 9	3, 6, 9	OFDM	BPSK	13.5

TEST CONDITION:

APPLICABLE TO	ENVIRONMENTAL CONDITIONS	INPUT POWER (SYSTEM)	TESTED BY
RE ³ 1G	25deg. C, 57% RH	120Vac, 60Hz	Chad Lee
RE<1G	25deg. C, 57% RH	120Vac, 60Hz	Chad Lee
PLC	26deg. C, 66% RH	120Vac, 60Hz	Nick Chen
APCM	24deg. C, 78% RH	120Vac, 60Hz	Jun Wu

3.3 DESCRIPTION OF SUPPORT UNITS

The EUT has been tested as an independent unit together with other necessary accessories or support units. The following support units or accessories were used to form a representative test configuration during the tests.

NO.	PRODUCT	BRAND	MODEL NO.	SERIAL NO.	FCC ID
1	NOTEBOOK COMPUTER	DELL	PP27L	8SNZ12S	FCC DoC Approved

NO.	SIGNAL CABLE DESCRIPTION OF THE ABOVE SUPPORT UNITS
1	N/A

NOTE: All power cords of the above support units are non shielded (1.8m).

3.3.1 CONFIGURATION OF SYSTEM UNDER TEST

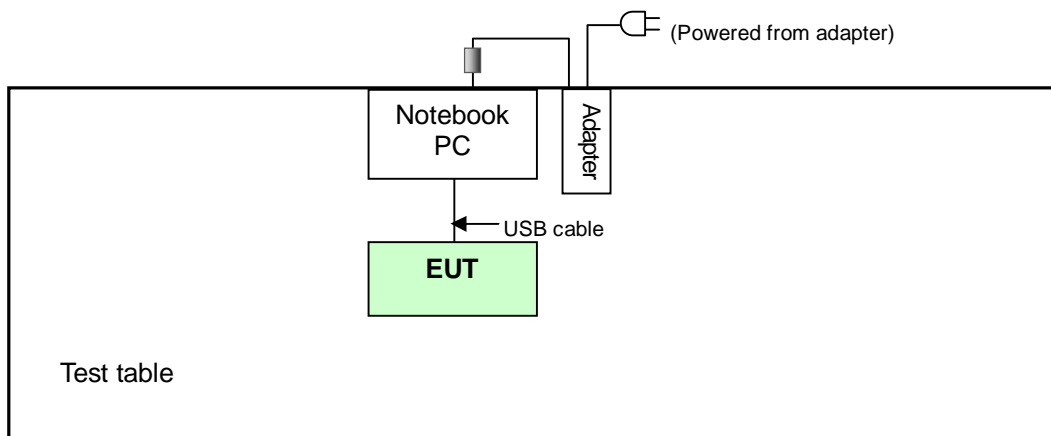



A D T

3.4 GENERAL DESCRIPTION OF APPLIED STANDARDS

The EUT is a RF Product. According to the specifications of the manufacturer, it must comply with the requirements of the following standards:

FCC Part 15, Subpart C (15.247)

558074 D01 DTS Meas Guidance v01

ANSI C63.10-2009

All test items have been performed and recorded as per the above standards.

NOTE: The EUT is also considered as a kind of computer peripheral, because the connection to computer is necessary for typical use. It has been verified to comply with the requirements of FCC Part 15, Subpart B, Class B (DoC). The test report has been issued separately.



4. TEST TYPES AND RESULTS

4.1 RADIATED EMISSION AND BANDEDGE MEASUREMENT

4.1.1 LIMITS OF RADIATED EMISSION AND BANDEDGE MEASUREMENT

Radiated emissions which fall in the restricted bands must comply with the radiated emission limits specified as below table. Other emissions shall be at least 20dB below the highest level of the desired power:

FREQUENCIES (MHz)	FIELD STRENGTH (microvolts/meter)	MEASUREMENT DISTANCE (meters)
0.009 ~ 0.490	2400/F(kHz)	300
0.490 ~ 1.705	24000/F(kHz)	30
1.705 ~ 30.0	30	30
30 ~ 88	100	3
88 ~ 216	150	3
216 ~ 960	200	3
Above 960	500	3

NOTE:

1. The lower limit shall apply at the transition frequencies.
2. Emission level (dBuV/m) = 20 log Emission level (uV/m).
3. For frequencies above 1000MHz, the field strength limits are based on average detector, however, the peak field strength of any emission shall not exceed the maximum permitted average limits, specified above by more than 20dB under any condition of modulation.



A D T

4.1.2 TEST INSTRUMENTS

DESCRIPTION & MANUFACTURER	MODEL NO.	SERIAL NO.	CALIBRATED DATE	CALIBRATED UNTIL
HP Preamplifier	8447D	2432A03504	Mar. 04, 2011	Mar. 03, 2012
HP Preamplifier	8449B	3008A01924	Mar. 04, 2011	Mar. 03, 2012
HP Preamplifier	8449B	3008A01292	Mar. 04, 2011	Mar. 03, 2012
Agilent Spectrum Analyzer	E4446A	MY46180403	Jun. 22, 2011	Jun. 21, 2012
ROHDE & SCHWARZ TEST RECEIVER	ESCS30	838251/021	Oct. 01, 2010	Sep. 30, 2011
Schwarzbeck Antenna	VULB 9168	137	Apr. 12, 2011	Apr. 11, 2012
Schwarzbeck Antenna	VHBA 9123	480	May 06, 2011	May 05, 2012
ADT. Turn Table	TT100	0306	NA	NA
ADT. Tower	AT100	0306	NA	NA
Software	ADT_Radiated_V 7.6.15.9.2	NA	NA	NA
SUHNER RF cable	SF102	CABLE-CH6	Aug. 20, 2010	Aug. 19, 2011
EMCO Horn Antenna	3115	6714	Oct. 26, 2010	Oct. 25, 2011
EMCO Horn Antenna	3115	9312-4192	Apr. 22, 2011	Apr. 21, 2012
Highpass filter Wainwright Instruments	WHK 3.1/18G-10SS	SN 8	NA	NA

- NOTE:**
1. The calibration interval of the above test instruments is 12 months. And the calibrations are traceable to NML/ROC and NIST/USA.
 2. The horn antenna and HP preamplifier (model: 8449B) are used only for the measurement of emission frequency above 1GHz if tested.
 3. The test was performed in Chamber No. 6.
 4. The Industry Canada Reference No. IC 7450E-6.
 5. The FCC Site Registration No. is 447212.
 6. Tested Date: Jul. 11 ~ 25, 2011



A D T

4.1.3 TEST PROCEDURES

- a. The EUT was placed on the top of a rotating table 0.8 meters above the ground at a 3 meters semi-anechoic chamber. The table was rotated 360 degrees to determine the position of the highest radiation.
- b. The EUT was set 3 meters away from the interference-receiving antenna, which was mounted on the top of a variable-height antenna tower.
- c. Height of receiving antenna is varied from one meter to four meters above the ground to determine the maximum value of the field strength. Both horizontal and vertical polarizations of the antenna are set to make the measurement.
- d. For each suspected emission, the EUT was arranged to its worst case and then the antenna was tuned to heights from 1 meter to 4 meters and the rotatable table was turned from 0 degrees to 360 degrees to find the maximum reading.
- e. The test-receiver system was set to Peak Detect Function and Specified Bandwidth with Maximum Hold Mode.
- f. If the emission level of the EUT in peak mode was lower than the limit specified, then testing could be stopped and the peak values of the EUT would be reported. Otherwise the emissions would be re-tested one by one using peak, quasi-peak or average method as specified and then reported in a data sheet.

NOTE:

1. The resolution bandwidth and video bandwidth of test receiver/spectrum analyzer is 120kHz for Quasi-peak detection at frequency below 1GHz.
2. The resolution bandwidth of test receiver/spectrum analyzer is 1MHz and video bandwidth is 3MHz for Peak detection at frequency above 1GHz.
3. The resolution bandwidth of test receiver/spectrum analyzer is 1MHz and the video bandwidth is 10Hz for Average detection (AV) at frequency above 1GHz.
4. All modes of operation were investigated and the worst-case emissions are reported.

4.1.4 DEVIATION FROM TEST STANDARD

No deviation.

4.1.5 TEST SETUP

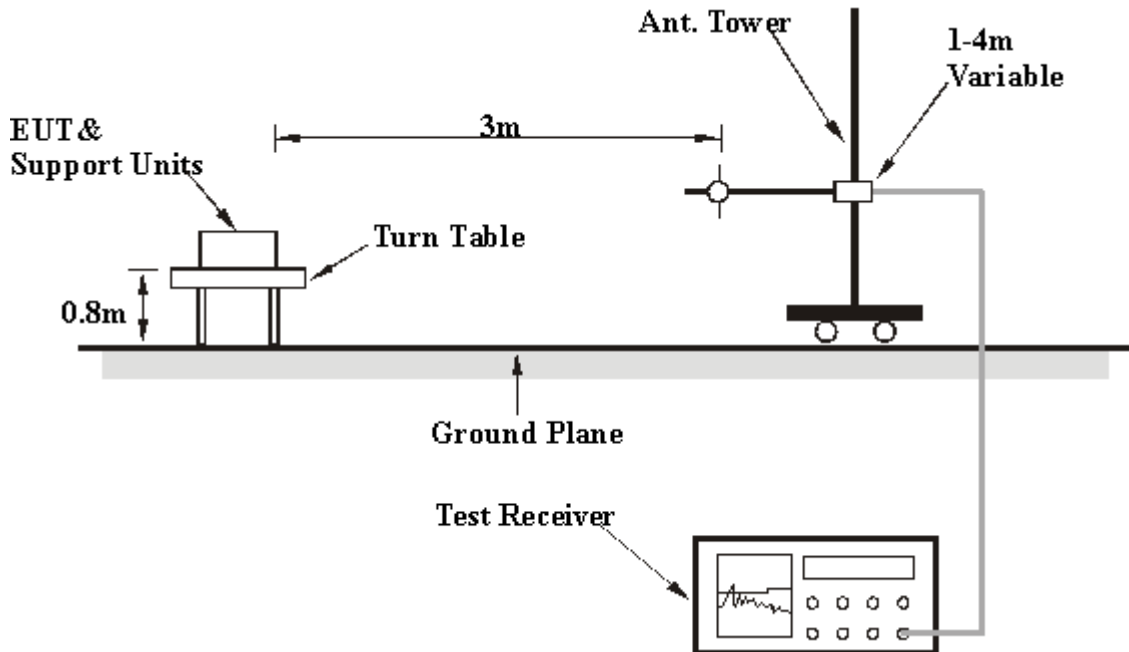

For the actual test configuration, please refer to the attached file (Test Setup Photo).

4.1.6 EUT OPERATING CONDITIONS

- a. Turn on the power of all equipment.
- b. Notebook PC ran a test program (provided by manufacture) to enable EUT under transmitting condition at specific channel continuously.
- c. Notebook PC read and wrote messages to/ from HDD.
- d. Notebook PC sent messages to panel and displayed on the screen.
- e. Repeated c ~ e.



4.1.7 TEST RESULTS

802.11b

EUT TEST CONDITION		MEASUREMENT DETAIL	
CHANNEL	Channel 1	FREQUENCY RANGE	1 ~ 25GHz
INPUT POWER (SYSTEM)	120Vac, 60Hz	DETECTOR FUNCTION	Peak (PK) Average (AV)
ENVIRONMENTAL CONDITIONS	25deg. C, 57%RH	TESTED BY	Chad Lee

ANTENNA POLARITY & TEST DISTANCE: HORIZONTAL AT 3 M								
NO.	FREQ. (MHz)	EMISSION LEVEL (dBuV/m)	LIMIT (dBuV/m)	MARGIN (dB)	ANTENNA HEIGHT (m)	TABLE ANGLE (Degree)	RAW VALUE (dBuV)	CORRECTION FACTOR (dB/m)
1	2390.00	57.1 PK	74.0	-16.9	1.16 H	160	24.91	32.15
2	2390.00	44.7 AV	54.0	-9.3	1.16 H	160	12.56	32.15
3	*2412.00	104.1 PK			1.16 H	160	71.81	32.24
4	*2412.00	100.5 AV			1.16 H	160	68.25	32.24
5	4824.00	53.2 PK	74.0	-20.8	1.00 H	242	14.51	38.66
6	4824.00	48.1 AV	54.0	-5.9	1.00 H	242	9.40	38.66

ANTENNA POLARITY & TEST DISTANCE: VERTICAL AT 3 M								
NO.	FREQ. (MHz)	EMISSION LEVEL (dBuV/m)	LIMIT (dBuV/m)	MARGIN (dB)	ANTENNA HEIGHT (m)	TABLE ANGLE (Degree)	RAW VALUE (dBuV)	CORRECTION FACTOR (dB/m)
1	2390.00	52.3 PK	74.0	-21.7	1.00 V	191	20.12	32.15
2	2390.00	42.7 AV	54.0	-11.3	1.00 V	191	10.56	32.15
3	*2412.00	99.8 PK			1.00 V	191	67.57	32.24
4	*2412.00	96.5 AV			1.00 V	191	64.25	32.24
5	4824.00	55.9 PK	74.0	-18.2	1.00 V	188	17.19	38.66
6	4824.00	52.7 AV	54.0	-1.3	1.00 V	188	14.00	38.66

- REMARKS:**
1. Emission level (dBuV/m) = Raw Value (dBuV) + Correction Factor (dB/m).
 2. Correction Factor (dB/m) = Antenna Factor (dB/m) + Cable Factor (dB).
 3. The other emission levels were very low against the limit.
 4. Margin value = Emission level – Limit value.
 5. “ * “: Fundamental frequency.



A D T

EUT TEST CONDITION		MEASUREMENT DETAIL	
CHANNEL	Channel 6	FREQUENCY RANGE	1 ~ 25GHz
INPUT POWER (SYSTEM)	120Vac, 60Hz	DETECTOR FUNCTION	Peak (PK) Average (AV)
ENVIRONMENTAL CONDITIONS	25deg. C, 57%RH	TESTED BY	Chad Lee

ANTENNA POLARITY & TEST DISTANCE: HORIZONTAL AT 3 M								
NO.	FREQ. (MHz)	EMISSION LEVEL (dBuV/m)	LIMIT (dBuV/m)	MARGIN (dB)	ANTENNA HEIGHT (m)	TABLE ANGLE (Degree)	RAW VALUE (dBuV)	CORRECTION FACTOR (dB/m)
1	*2437.00	104.1 PK			1.17 H	148	71.74	32.33
2	*2437.00	101.1 AV			1.17 H	148	68.78	32.33
3	4874.00	52.3 PK	74.0	-21.7	1.00 H	143	13.52	38.78
4	4874.00	41.6 AV	54.0	-12.4	1.00 H	143	2.84	38.78
ANTENNA POLARITY & TEST DISTANCE: VERTICAL AT 3 M								
NO.	FREQ. (MHz)	EMISSION LEVEL (dBuV/m)	LIMIT (dBuV/m)	MARGIN (dB)	ANTENNA HEIGHT (m)	TABLE ANGLE (Degree)	RAW VALUE (dBuV)	CORRECTION FACTOR (dB/m)
1	*2437.00	100.1 PK			1.00 V	189	67.79	32.33
2	*2437.00	96.7 AV			1.00 V	189	64.41	32.33
3	4874.00	52.3 PK	74.0	-21.7	1.00 V	15	13.55	38.78
4	4874.00	44.4 AV	54.0	-9.6	1.00 V	15	5.65	38.78

- REMARKS:**
1. Emission level (dBuV/m) = Raw Value (dBuV) + Correction Factor (dB/m).
 2. Correction Factor (dB/m) = Antenna Factor (dB/m) + Cable Factor (dB).
 3. The other emission levels were very low against the limit.
 4. Margin value = Emission level – Limit value.
 5. “ * “: Fundamental frequency.



A D T

EUT TEST CONDITION		MEASUREMENT DETAIL	
CHANNEL	Channel 11	FREQUENCY RANGE	1 ~ 25GHz
INPUT POWER (SYSTEM)	120Vac, 60Hz	DETECTOR FUNCTION	Peak (PK) Average (AV)
ENVIRONMENTAL CONDITIONS	25deg. C, 57%RH	TESTED BY	Chad Lee

ANTENNA POLARITY & TEST DISTANCE: HORIZONTAL AT 3 M								
NO.	FREQ. (MHz)	EMISSION LEVEL (dBuV/m)	LIMIT (dBuV/m)	MARGIN (dB)	ANTENNA HEIGHT (m)	TABLE ANGLE (Degree)	RAW VALUE (dBuV)	CORRECTION FACTOR (dB/m)
1	*2462.00	103.2 PK			1.12 H	152	70.75	32.43
2	*2462.00	100.3 AV			1.12 H	152	67.82	32.43
3	2483.50	60.6 PK	74.0	-13.4	1.12 H	152	28.13	32.51
4	2483.50	49.1 AV	54.0	-4.9	1.12 H	152	16.59	32.51
5	4924.00	53.2 PK	74.0	-20.8	1.00 H	19	14.26	38.90
6	4924.00	43.6 AV	54.0	-10.4	1.00 H	19	4.68	38.90
ANTENNA POLARITY & TEST DISTANCE: VERTICAL AT 3 M								
NO.	FREQ. (MHz)	EMISSION LEVEL (dBuV/m)	LIMIT (dBuV/m)	MARGIN (dB)	ANTENNA HEIGHT (m)	TABLE ANGLE (Degree)	RAW VALUE (dBuV)	CORRECTION FACTOR (dB/m)
1	*2462.00	99.8 PK			1.00 V	188	67.33	32.43
2	*2462.00	95.4 AV			1.00 V	188	62.95	32.43
3	2483.50	54.6 PK	74.0	-19.4	1.00 V	188	22.13	32.51
4	2483.50	43.1 AV	54.0	-10.9	1.00 V	188	10.59	32.51
5	4924.00	56.6 PK	74.0	-17.4	1.00 V	12	17.67	38.90
6	4924.00	53.1 AV	54.0	-0.9	1.00 V	12	14.19	38.90

- REMARKS:**
1. Emission level (dBuV/m) = Raw Value (dBuV) + Correction Factor (dB/m).
 2. Correction Factor (dB/m) = Antenna Factor (dB/m) + Cable Factor (dB).
 3. The other emission levels were very low against the limit.
 4. Margin value = Emission level – Limit value.
 5. “ * “: Fundamental frequency.



802.11g

EUT TEST CONDITION		MEASUREMENT DETAIL	
CHANNEL	Channel 1	FREQUENCY RANGE	1 ~ 25GHz
INPUT POWER (SYSTEM)	120Vac, 60Hz	DETECTOR FUNCTION	Peak (PK) Average (AV)
ENVIRONMENTAL CONDITIONS	25deg. C, 57%RH	TESTED BY	Chad Lee

ANTENNA POLARITY & TEST DISTANCE: HORIZONTAL AT 3 M								
NO.	FREQ. (MHz)	EMISSION LEVEL (dBuV/m)	LIMIT (dBuV/m)	MARGIN (dB)	ANTENNA HEIGHT (m)	TABLE ANGLE (Degree)	RAW VALUE (dBuV)	CORRECTION FACTOR (dB/m)
1	2390.00	72.7 PK	74.0	-1.3	1.17 H	152	40.56	32.15
2	2390.00	53.9 AV	54.0	-0.1	1.17 H	152	21.73	32.15
3	*2412.00	106.2 PK			1.17 H	152	73.98	32.24
4	*2412.00	94.2 AV			1.17 H	152	62.00	32.24
5	4824.00	54.9 PK	74.0	-19.1	1.00 H	126	16.25	38.66
6	4824.00	42.0 AV	54.0	-12.0	1.00 H	126	3.30	38.66
ANTENNA POLARITY & TEST DISTANCE: VERTICAL AT 3 M								
NO.	FREQ. (MHz)	EMISSION LEVEL (dBuV/m)	LIMIT (dBuV/m)	MARGIN (dB)	ANTENNA HEIGHT (m)	TABLE ANGLE (Degree)	RAW VALUE (dBuV)	CORRECTION FACTOR (dB/m)
1	2390.00	72.1 PK	74.0	-1.9	1.28 V	186	39.95	32.15
2	2390.00	53.3 AV	54.0	-0.7	1.28 V	186	21.16	32.15
3	*2412.00	104.4 PK			1.28 V	186	72.13	32.24
4	*2412.00	92.5 AV			1.28 V	186	60.25	32.24
5	4824.00	54.9 PK	74.0	-19.1	1.00 V	33	16.28	38.66
6	4824.00	42.0 AV	54.0	-12.0	1.00 V	33	3.30	38.66

- REMARKS:**
1. Emission level (dBuV/m) = Raw Value (dBuV) + Correction Factor (dB/m).
 2. Correction Factor (dB/m) = Antenna Factor (dB/m) + Cable Factor (dB).
 3. The other emission levels were very low against the limit.
 4. Margin value = Emission level – Limit value.
 5. “ * “: Fundamental frequency.



A D T

EUT TEST CONDITION		MEASUREMENT DETAIL	
CHANNEL	Channel 6	FREQUENCY RANGE	1 ~ 25GHz
INPUT POWER (SYSTEM)	120Vac, 60Hz	DETECTOR FUNCTION	Peak (PK) Average (AV)
ENVIRONMENTAL CONDITIONS	25deg. C, 57%RH	TESTED BY	Chad Lee

ANTENNA POLARITY & TEST DISTANCE: HORIZONTAL AT 3 M								
NO.	FREQ. (MHz)	EMISSION LEVEL (dBuV/m)	LIMIT (dBuV/m)	MARGIN (dB)	ANTENNA HEIGHT (m)	TABLE ANGLE (Degree)	RAW VALUE (dBuV)	CORRECTION FACTOR (dB/m)
1	*2437.00	109.4 PK			1.11 H	118	77.03	32.33
2	*2437.00	98.3 AV			1.11 H	118	65.95	32.33
3	4874.00	52.0 PK	74.0	-22.0	1.00 H	90	13.23	38.78
4	4874.00	39.7 AV	54.0	-14.3	1.00 H	90	0.91	38.78
ANTENNA POLARITY & TEST DISTANCE: VERTICAL AT 3 M								
NO.	FREQ. (MHz)	EMISSION LEVEL (dBuV/m)	LIMIT (dBuV/m)	MARGIN (dB)	ANTENNA HEIGHT (m)	TABLE ANGLE (Degree)	RAW VALUE (dBuV)	CORRECTION FACTOR (dB/m)
1	*2437.00	107.7 PK			1.00 V	189	75.35	32.33
2	*2437.00	96.9 AV			1.00 V	189	64.52	32.33
3	4874.00	54.8 PK	74.0	-19.2	1.00 V	17	16.03	38.78
4	4874.00	40.1 AV	54.0	-13.9	1.00 V	17	1.33	38.78

- REMARKS:**
1. Emission level (dBuV/m) = Raw Value (dBuV) + Correction Factor (dB/m).
 2. Correction Factor (dB/m) = Antenna Factor (dB/m) + Cable Factor (dB).
 3. The other emission levels were very low against the limit.
 4. Margin value = Emission level – Limit value.
 5. “ * “: Fundamental frequency.



A D T

EUT TEST CONDITION		MEASUREMENT DETAIL	
CHANNEL	Channel 11	FREQUENCY RANGE	1 ~ 25GHz
INPUT POWER (SYSTEM)	120Vac, 60Hz	DETECTOR FUNCTION	Peak (PK) Average (AV)
ENVIRONMENTAL CONDITIONS	25deg. C, 57%RH	TESTED BY	Chad Lee

ANTENNA POLARITY & TEST DISTANCE: HORIZONTAL AT 3 M								
NO.	FREQ. (MHz)	EMISSION LEVEL (dBuV/m)	LIMIT (dBuV/m)	MARGIN (dB)	ANTENNA HEIGHT (m)	TABLE ANGLE (Degree)	RAW VALUE (dBuV)	CORRECTION FACTOR (dB/m)
1	*2462.00	107.0 PK			1.14 H	148	74.59	32.43
2	*2462.00	94.0 AV			1.14 H	148	61.57	32.43
3	2483.50	71.6 PK	74.0	-2.4	1.14 H	148	39.06	32.51
4	2483.50	53.5 AV	54.0	-0.5	1.14 H	148	21.01	32.51
5	4924.00	51.2 PK	74.0	-22.8	1.00 H	322	12.27	38.90
6	4924.00	39.3 AV	54.0	-14.7	1.00 H	322	0.40	38.90
ANTENNA POLARITY & TEST DISTANCE: VERTICAL AT 3 M								
NO.	FREQ. (MHz)	EMISSION LEVEL (dBuV/m)	LIMIT (dBuV/m)	MARGIN (dB)	ANTENNA HEIGHT (m)	TABLE ANGLE (Degree)	RAW VALUE (dBuV)	CORRECTION FACTOR (dB/m)
1	*2462.00	105.1 PK			1.00 V	184	72.69	32.43
2	*2462.00	93.2 AV			1.00 V	184	60.72	32.43
3	2483.50	70.9 PK	74.0	-3.1	1.00 V	184	38.35	32.51
4	2483.50	52.9 AV	54.0	-1.1	1.00 V	184	20.37	32.51
5	4924.00	59.9 PK	74.0	-14.1	1.00 V	163	20.99	38.90
6	4924.00	46.7 AV	54.0	-7.3	1.00 V	163	7.80	38.90

- REMARKS:**
1. Emission level (dBuV/m) = Raw Value (dBuV) + Correction Factor (dB/m).
 2. Correction Factor (dB/m) = Antenna Factor (dB/m) + Cable Factor (dB).
 3. The other emission levels were very low against the limit.
 4. Margin value = Emission level – Limit value.
 5. “ * “: Fundamental frequency.



A D T

802.11n (20MHz)

EUT TEST CONDITION		MEASUREMENT DETAIL	
CHANNEL	Channel 1	FREQUENCY RANGE	1 ~ 25GHz
INPUT POWER (SYSTEM)	120Vac, 60Hz	DETECTOR FUNCTION	Peak (PK) Average (AV)
ENVIRONMENTAL CONDITIONS	26deg. C, 65%RH	TESTED BY	Chad Lee

ANTENNA POLARITY & TEST DISTANCE: HORIZONTAL AT 3 M

NO.	FREQ. (MHz)	EMISSION LEVEL (dBuV/m)	LIMIT (dBuV/m)	MARGIN (dB)	ANTENNA HEIGHT (m)	TABLE ANGLE (Degree)	RAW VALUE (dBuV)	CORRECTION FACTOR (dB/m)
1	2390.00	73.1 PK	74.0	-0.9	1.12 H	115	40.91	32.15
2	2390.00	52.9 AV	54.0	-1.1	1.12 H	115	20.78	32.15
3	*2412.00	105.3 PK			1.12 H	115	73.02	32.24
4	*2412.00	94.2 AV			1.12 H	115	61.91	32.24
5	4824.00	47.9 PK	74.0	-26.1	1.01 H	6	9.20	38.66
6	4824.00	35.0 AV	54.0	-19.0	1.01 H	6	-3.62	38.66

ANTENNA POLARITY & TEST DISTANCE: VERTICAL AT 3 M

NO.	FREQ. (MHz)	EMISSION LEVEL (dBuV/m)	LIMIT (dBuV/m)	MARGIN (dB)	ANTENNA HEIGHT (m)	TABLE ANGLE (Degree)	RAW VALUE (dBuV)	CORRECTION FACTOR (dB/m)
1	2390.00	68.3 PK	74.0	-5.7	1.00 V	174	36.12	32.15
2	2390.00	48.1 AV	54.0	-5.9	1.00 V	174	15.96	32.15
3	*2412.00	103.1 PK			1.00 V	174	70.89	32.24
4	*2412.00	93.0 AV			1.00 V	174	60.79	32.24
5	4824.00	52.8 PK	74.0	-21.2	1.00 V	190	14.12	38.66
6	4824.00	39.4 AV	54.0	-14.6	1.00 V	190	0.74	38.66

- REMARKS:**
1. Emission level (dBuV/m) = Raw Value (dBuV) + Correction Factor (dB/m).
 2. Correction Factor (dB/m) = Antenna Factor (dB/m) + Cable Factor (dB).
 3. The other emission levels were very low against the limit.
 4. Margin value = Emission level – Limit value.
 5. “ * “: Fundamental frequency.



A D T

EUT TEST CONDITION		MEASUREMENT DETAIL	
CHANNEL	Channel 6	FREQUENCY RANGE	1 ~ 25GHz
INPUT POWER (SYSTEM)	120Vac, 60Hz	DETECTOR FUNCTION	Peak (PK) Average (AV)
ENVIRONMENTAL CONDITIONS	25deg. C, 57%RH	TESTED BY	Chad Lee

ANTENNA POLARITY & TEST DISTANCE: HORIZONTAL AT 3 M								
NO.	FREQ. (MHz)	EMISSION LEVEL (dBuV/m)	LIMIT (dBuV/m)	MARGIN (dB)	ANTENNA HEIGHT (m)	TABLE ANGLE (Degree)	RAW VALUE (dBuV)	CORRECTION FACTOR (dB/m)
1	*2437.00	110.0 PK			1.09 H	116	77.69	32.33
2	*2437.00	97.5 AV			1.09 H	116	65.12	32.33
3	4874.00	53.1 PK	74.0	-20.9	1.00 H	301	14.35	38.78
4	4874.00	38.6 AV	54.0	-15.4	1.00 H	301	-0.20	38.78
ANTENNA POLARITY & TEST DISTANCE: VERTICAL AT 3 M								
NO.	FREQ. (MHz)	EMISSION LEVEL (dBuV/m)	LIMIT (dBuV/m)	MARGIN (dB)	ANTENNA HEIGHT (m)	TABLE ANGLE (Degree)	RAW VALUE (dBuV)	CORRECTION FACTOR (dB/m)
1	*2437.00	107.9 PK			1.00 V	188	75.59	32.33
2	*2437.00	95.6 AV			1.00 V	188	63.25	32.33
3	4874.00	57.3 PK	74.0	-16.7	1.00 V	191	18.48	38.78
4	4874.00	42.4 AV	54.0	-11.6	1.00 V	191	3.64	38.78

- REMARKS:**
1. Emission level (dBuV/m) = Raw Value (dBuV) + Correction Factor (dB/m).
 2. Correction Factor (dB/m) = Antenna Factor (dB/m) + Cable Factor (dB).
 3. The other emission levels were very low against the limit.
 4. Margin value = Emission level – Limit value.
 5. “ * “: Fundamental frequency.



A D T

EUT TEST CONDITION		MEASUREMENT DETAIL	
CHANNEL	Channel 11	FREQUENCY RANGE	1 ~ 25GHz
INPUT POWER (SYSTEM)	120Vac, 60Hz	DETECTOR FUNCTION	Peak (PK) Average (AV)
ENVIRONMENTAL CONDITIONS	26deg. C, 65%RH	TESTED BY	Chad Lee

ANTENNA POLARITY & TEST DISTANCE: HORIZONTAL AT 3 M								
NO.	FREQ. (MHz)	EMISSION LEVEL (dBuV/m)	LIMIT (dBuV/m)	MARGIN (dB)	ANTENNA HEIGHT (m)	TABLE ANGLE (Degree)	RAW VALUE (dBuV)	CORRECTION FACTOR (dB/m)
1	*2462.00	105.9 PK			1.00 H	110	73.43	32.43
2	*2462.00	93.2 AV			1.00 H	110	60.78	32.43
3	2483.50	71.8 PK	74.0	-2.2	1.00 H	110	39.29	32.51
4	2483.50	53.6 AV	54.0	-0.4	1.00 H	110	21.07	32.51
5	4924.00	50.5 PK	74.0	-23.5	1.00 H	16	11.56	38.90
6	4924.00	35.8 AV	54.0	-18.2	1.00 H	16	-3.09	38.90
ANTENNA POLARITY & TEST DISTANCE: VERTICAL AT 3 M								
NO.	FREQ. (MHz)	EMISSION LEVEL (dBuV/m)	LIMIT (dBuV/m)	MARGIN (dB)	ANTENNA HEIGHT (m)	TABLE ANGLE (Degree)	RAW VALUE (dBuV)	CORRECTION FACTOR (dB/m)
1	*2462.00	100.7 PK			1.00 V	181	68.29	32.43
2	*2462.00	90.5 AV			1.00 V	181	58.03	32.43
3	2483.50	65.5 PK	74.0	-8.5	1.00 V	181	32.96	32.51
4	2483.50	46.9 AV	54.0	-7.1	1.00 V	181	14.35	32.51
5	4924.00	49.1 PK	74.0	-24.9	1.00 V	6	10.16	38.90
6	4924.00	37.3 AV	54.0	-16.7	1.00 V	6	-1.56	38.90

- REMARKS:**
1. Emission level (dBuV/m) = Raw Value (dBuV) + Correction Factor (dB/m).
 2. Correction Factor (dB/m) = Antenna Factor (dB/m) + Cable Factor (dB).
 3. The other emission levels were very low against the limit.
 4. Margin value = Emission level – Limit value.
 5. “ * “: Fundamental frequency.



A D T

802.11n (40MHz)

EUT TEST CONDITION		MEASUREMENT DETAIL	
CHANNEL	Channel 3	FREQUENCY RANGE	1 ~ 25GHz
INPUT POWER (SYSTEM)	120Vac, 60Hz	DETECTOR FUNCTION	Peak (PK) Average (AV)
ENVIRONMENTAL CONDITIONS	25deg. C, 57%RH	TESTED BY	Chad Lee

ANTENNA POLARITY & TEST DISTANCE: HORIZONTAL AT 3 M

NO.	FREQ. (MHz)	EMISSION LEVEL (dBuV/m)	LIMIT (dBuV/m)	MARGIN (dB)	ANTENNA HEIGHT (m)	TABLE ANGLE (Degree)	RAW VALUE (dBuV)	CORRECTION FACTOR (dB/m)
1	2390.00	72.5 PK	74.0	-1.5	1.03 H	109	40.31	32.15
2	2390.00	53.7 AV	54.0	-0.3	1.03 H	109	21.54	32.15
3	*2422.00	100.4 PK			1.03 H	109	68.16	32.27
4	*2422.00	88.6 AV			1.03 H	109	56.28	32.27
5	4844.00	51.1 PK	74.0	-22.9	1.00 H	6	12.42	38.71
6	4844.00	36.8 AV	54.0	-17.2	1.00 H	6	-1.93	38.71

ANTENNA POLARITY & TEST DISTANCE: VERTICAL AT 3 M

NO.	FREQ. (MHz)	EMISSION LEVEL (dBuV/m)	LIMIT (dBuV/m)	MARGIN (dB)	ANTENNA HEIGHT (m)	TABLE ANGLE (Degree)	RAW VALUE (dBuV)	CORRECTION FACTOR (dB/m)
1	2390.00	68.7 PK	74.0	-5.3	1.00 V	175	36.58	32.15
2	2390.00	50.2 AV	54.0	-3.8	1.00 V	175	18.06	32.15
3	*2422.00	96.6 PK			1.00 V	175	64.32	32.27
4	*2422.00	84.5 AV			1.00 V	175	52.18	32.27
5	4844.00	49.6 PK	74.0	-24.4	1.00 V	16	10.90	38.71
6	4844.00	36.7 AV	54.0	-17.3	1.00 V	16	-2.02	38.71

- REMARKS:**
1. Emission level (dBuV/m) = Raw Value (dBuV) + Correction Factor (dB/m).
 2. Correction Factor (dB/m) = Antenna Factor (dB/m) + Cable Factor (dB).
 3. The other emission levels were very low against the limit.
 4. Margin value = Emission level – Limit value.
 5. “ * “: Fundamental frequency.



A D T

EUT TEST CONDITION		MEASUREMENT DETAIL	
CHANNEL	Channel 6	FREQUENCY RANGE	1 ~ 25GHz
INPUT POWER (SYSTEM)	120Vac, 60Hz	DETECTOR FUNCTION	Peak (PK) Average (AV)
ENVIRONMENTAL CONDITIONS	25deg. C, 57%RH	TESTED BY	Chad Lee

ANTENNA POLARITY & TEST DISTANCE: HORIZONTAL AT 3 M								
NO.	FREQ. (MHz)	EMISSION LEVEL (dBuV/m)	LIMIT (dBuV/m)	MARGIN (dB)	ANTENNA HEIGHT (m)	TABLE ANGLE (Degree)	RAW VALUE (dBuV)	CORRECTION FACTOR (dB/m)
1	*2437.00	104.8 PK			1.00 H	113	72.49	32.33
2	*2437.00	92.4 AV			1.00 H	113	60.03	32.33
3	4874.00	51.6 PK	74.0	-22.4	1.00 H	234	12.83	38.78
4	4874.00	40.8 AV	54.0	-13.2	1.00 H	234	2.02	38.78
ANTENNA POLARITY & TEST DISTANCE: VERTICAL AT 3 M								
NO.	FREQ. (MHz)	EMISSION LEVEL (dBuV/m)	LIMIT (dBuV/m)	MARGIN (dB)	ANTENNA HEIGHT (m)	TABLE ANGLE (Degree)	RAW VALUE (dBuV)	CORRECTION FACTOR (dB/m)
1	*2437.00	100.6 PK			1.00 V	177	68.28	32.33
2	*2437.00	88.4 AV			1.00 V	177	56.04	32.33
3	4874.00	49.9 PK	74.0	-24.2	1.00 V	43	11.07	38.78
4	4874.00	37.8 AV	54.0	-16.2	1.00 V	43	-0.94	38.78

- REMARKS:**
1. Emission level (dBuV/m) = Raw Value (dBuV) + Correction Factor (dB/m).
 2. Correction Factor (dB/m) = Antenna Factor (dB/m) + Cable Factor (dB).
 3. The other emission levels were very low against the limit.
 4. Margin value = Emission level – Limit value.
 5. “ * “: Fundamental frequency.



A D T

EUT TEST CONDITION		MEASUREMENT DETAIL	
CHANNEL	Channel 9	FREQUENCY RANGE	1 ~ 25GHz
INPUT POWER (SYSTEM)	120Vac, 60Hz	DETECTOR FUNCTION	Peak (PK) Average (AV)
ENVIRONMENTAL CONDITIONS	25deg. C, 57%RH	TESTED BY	Chad Lee

ANTENNA POLARITY & TEST DISTANCE: HORIZONTAL AT 3 M								
NO.	FREQ. (MHz)	EMISSION LEVEL (dBuV/m)	LIMIT (dBuV/m)	MARGIN (dB)	ANTENNA HEIGHT (m)	TABLE ANGLE (Degree)	RAW VALUE (dBuV)	CORRECTION FACTOR (dB/m)
1	*2452.00	101.2 PK			1.00 H	108	68.76	32.39
2	*2452.00	89.5 AV			1.00 H	108	57.08	32.39
3	2483.50	71.2 PK	74.0	-2.8	1.00 H	108	38.70	32.51
4	2483.50	53.9 AV	54.0	-0.1	1.00 H	108	21.36	32.51
5	4904.00	52.1 PK	74.0	-21.9	1.00 H	6	13.21	38.86
6	4904.00	40.4 AV	54.0	-13.6	1.00 H	6	1.52	38.86
ANTENNA POLARITY & TEST DISTANCE: VERTICAL AT 3 M								
NO.	FREQ. (MHz)	EMISSION LEVEL (dBuV/m)	LIMIT (dBuV/m)	MARGIN (dB)	ANTENNA HEIGHT (m)	TABLE ANGLE (Degree)	RAW VALUE (dBuV)	CORRECTION FACTOR (dB/m)
1	*2452.00	97.1 PK			1.00 V	108	64.74	32.39
2	*2452.00	85.1 AV			1.00 V	108	52.68	32.39
3	2483.50	67.5 PK	74.0	-6.6	1.00 V	108	34.94	32.51
4	2483.50	50.4 AV	54.0	-3.6	1.00 V	108	17.92	32.51
5	4904.00	48.2 PK	74.0	-25.8	1.00 V	6	9.36	38.86
6	4904.00	36.5 AV	54.0	-17.6	1.00 V	6	-2.41	38.86

- REMARKS:**
1. Emission level (dBuV/m) = Raw Value (dBuV) + Correction Factor (dB/m).
 2. Correction Factor (dB/m) = Antenna Factor (dB/m) + Cable Factor (dB).
 3. The other emission levels were very low against the limit.
 4. Margin value = Emission level – Limit value.
 5. “ * “: Fundamental frequency.



A D T

BELOW 1GHz WORST-CASE DATA : 802.11g

EUT TEST CONDITION		MEASUREMENT DETAIL	
CHANNEL	Channel 11	FREQUENCY RANGE	Below 1000MHz
INPUT POWER (SYSTEM)	120Vac, 60Hz	DETECTOR FUNCTION	Quasi-Peak
ENVIRONMENTAL CONDITIONS	25deg. C, 57%RH	TESTED BY	Chad Lee

ANTENNA POLARITY & TEST DISTANCE: HORIZONTAL AT 3 M

NO.	FREQ. (MHz)	EMISSION LEVEL (dBuV/m)	LIMIT (dBuV/m)	MARGIN (dB)	ANTENNA HEIGHT (m)	TABLE ANGLE (Degree)	RAW VALUE (dBuV)	CORRECTION FACTOR (dB/m)
1	74.60	36.8 QP	40.0	-3.2	1.55 H	175	25.22	11.54
2	135.19	40.5 QP	43.5	-3.0	1.69 H	127	27.21	13.33
3	234.08	42.7 QP	46.0	-3.3	1.84 H	199	29.89	12.85
4	323.76	37.5 QP	46.0	-8.5	1.74 H	229	21.17	16.36
5	398.42	35.5 QP	46.0	-10.6	1.63 H	289	16.85	18.60
6	959.77	41.7 QP	46.0	-4.3	1.22 H	316	13.14	28.55

ANTENNA POLARITY & TEST DISTANCE: VERTICAL AT 3 M

NO.	FREQ. (MHz)	EMISSION LEVEL (dBuV/m)	LIMIT (dBuV/m)	MARGIN (dB)	ANTENNA HEIGHT (m)	TABLE ANGLE (Degree)	RAW VALUE (dBuV)	CORRECTION FACTOR (dB/m)
1	44.06	30.5 QP	40.0	-9.5	1.77 V	94	16.41	14.08
2	74.60	35.6 QP	40.0	-4.4	1.69 V	223	24.05	11.54
3	135.68	37.3 QP	43.5	-6.2	1.84 V	166	23.97	13.36
4	399.39	40.0 QP	46.0	-6.1	1.08 V	286	21.33	18.62
5	795.92	34.7 QP	46.0	-11.3	1.15 V	13	8.17	26.51
6	959.28	37.3 QP	46.0	-8.7	1.36 V	178	8.72	28.54

- REMARKS:**
1. Emission level (dBuV/m) = Raw Value (dBuV) + Correction Factor (dB/m).
 2. Correction Factor (dB/m) = Antenna Factor (dB/m) + Cable Factor (dB).
 3. The other emission levels were very low against the limit.
 4. Margin value = Emission level – Limit value.



4.2 CONDUCTED EMISSION MEASUREMENT

4.2.1 LIMITS OF CONDUCTED EMISSION MEASUREMENT

FREQUENCY OF EMISSION (MHz)	CONDUCTED LIMIT (dBµV)	
	Quasi-peak	Average
0.15 ~ 0.5	66 to 56	56 to 46
0.5 ~ 5	56	46
5 ~ 30	60	50

- NOTE:** 1. The lower limit shall apply at the transition frequencies.
2. The limit decreases in line with the logarithm of the frequency in the range of 0.15 to 0.50MHz.
3. All emanations from a class A/B digital device or system, including any network of conductors and apparatus connected thereto, shall not exceed the level of field strengths specified above.

4.2.2 TEST INSTRUMENTS

DESCRIPTION & MANUFACTURER	MODEL NO.	SERIAL NO.	CALIBRATED DATE	CALIBRATED UNTIL
ROHDE & SCHWARZ Test Receiver	ESCS 30	100276	Dec. 31, 2010	Dec. 30, 2011
ROHDE & SCHWARZ Artificial Mains Network (for EUT)	ESH3-Z5	100219	Nov. 24, 2010	Nov. 23, 2011
LISN With Adapter (for EUT)	AD10	C10Ada-001	Nov. 24, 2010	Nov. 23, 2011
ROHDE & SCHWARZ Artificial Mains Network (for peripherals)	ESH3-Z5	100218	Nov. 24, 2010	Nov. 23, 2011
Software	ADT_Cond_V7.3.7	NA	NA	NA
Software	ADT_ISN_V7.3.7	NA	NA	NA
RF cable (JYEBAO)	5D-FB	Cable-C10.01	Feb. 22, 2011	Feb. 21, 2012
SUHNER Terminator (For ROHDE & SCHWARZ LISN)	65BNC-5001	E1-010773	Feb. 26, 2011	Feb. 25, 2012

- NOTE:** 1. The calibration interval of the above test instruments is 12 months and the calibrations are traceable to NML/ROC and NIST/USA.
2. The test was performed in Shielded Room No. 10.
3. The VCCI Site Registration No. C-1852.
4. Tested Date: Jul. 11 ~ 25, 2011

4.2.3 TEST PROCEDURES

- a. The EUT was placed 0.4 meters from the conducting wall of the shielded room with EUT being connected to the power mains through a line impedance stabilization network (LISN). Other support units were connected to the power mains through another LISN. The two LISNs provide 50 ohm/ 50uH of coupling impedance for the measuring instrument.
- b. Both lines of the power mains connected to the EUT were checked for maximum conducted interference.
- c. The frequency range from 150kHz to 30MHz was searched. Emission levels under (Limit - 20dB) was not recorded.

NOTE: All modes of operation were investigated and the worst-case emissions are reported.

4.2.4 DEVIATION FROM TEST STANDARD

No deviation.

4.2.5 TEST SETUP

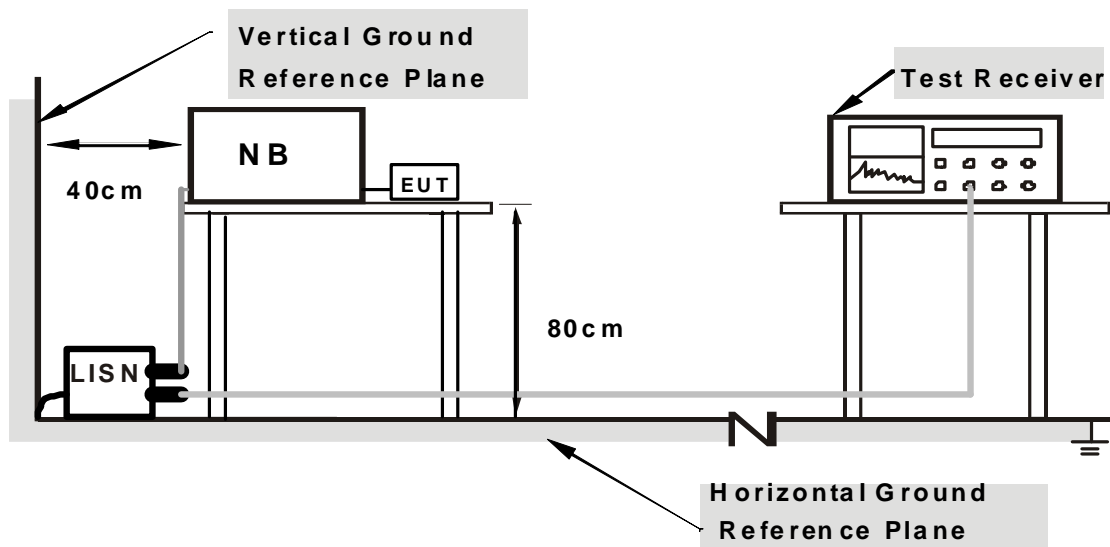

- Note:**
1. Support units were connected to second LISN.
 2. Both of LISNs (AMN) are 80 cm from EUT and at least 80 from other units and other metal planes

For the actual test configuration, please refer to the attached file (Test Setup Photo).

4.2.6 EUT OPERATING CONDITIONS

Same as 4.1.6.

4.2.7 TEST RESULTS

CONDUCTED WORST-CASE DATA : 802.11g

CHANNEL	Channel 11	6dB BANDWIDTH	9kHz
PHASE	Line 1		

No	Freq. [MHz]	Corr. Factor (dB)	Reading Value		Emission Level		Limit		Margin	
			[dB (uV)]		[dB (uV)]		[dB (uV)]		(dB)	
			Q.P.	AV.	Q.P.	AV.	Q.P.	AV.	Q.P.	AV.
1	0.198	0.17	46.90	-	47.07	-	63.69	53.69	-16.62	-
2	0.311	0.21	34.96	-	35.17	-	59.93	49.93	-24.76	-
3	0.623	0.25	28.69	-	28.94	-	56.00	46.00	-27.06	-
4	0.982	0.27	31.35	-	31.62	-	56.00	46.00	-24.38	-
5	1.418	0.30	34.12	-	34.42	-	56.00	46.00	-21.58	-
6	3.219	0.43	25.95	-	26.38	-	56.00	46.00	-29.62	-

- REMARKS:**
1. Q.P. and AV. are abbreviations of quasi-peak and average individually.
 2. "-": The Quasi-peak reading value also meets average limit and measurement with the average detector is unnecessary.
 3. The emission levels of other frequencies were very low against the limit.
 4. Margin value = Emission level - Limit value
 5. Correction factor = Insertion loss + Cable loss
 6. Emission Level = Correction Factor + Reading Value.

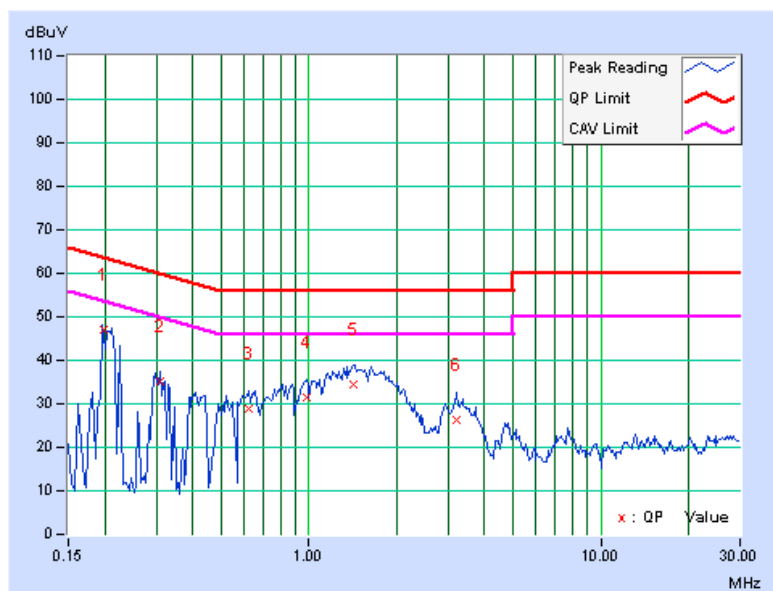

CHANNEL	Channel 11	6dB BANDWIDTH	9kHz
PHASE	Line 2		

No	Freq. [MHz]	Corr. Factor (dB)	Reading Value		Emission Level		Limit		Margin	
			[dB (uV)]		[dB (uV)]		[dB (uV)]		(dB)	
			Q.P.	AV.	Q.P.	AV.	Q.P.	AV.	Q.P.	AV.
1	0.170	0.18	47.88	-	48.06	-	64.96	54.96	-16.91	-
2	0.189	0.18	48.76	-	48.94	-	64.08	54.08	-15.14	-
3	0.271	0.20	37.47	-	37.67	-	61.08	51.08	-23.41	-
4	0.970	0.28	30.83	-	31.11	-	56.00	46.00	-24.89	-
5	1.668	0.31	34.58	-	34.89	-	56.00	46.00	-21.11	-
6	3.499	0.43	26.34	-	26.77	-	56.00	46.00	-29.23	-

- REMARKS:**
1. Q.P. and AV. are abbreviations of quasi-peak and average individually.
 2. "-": The Quasi-peak reading value also meets average limit and measurement with the average detector is unnecessary.
 3. The emission levels of other frequencies were very low against the limit.
 4. Margin value = Emission level - Limit value
 5. Correction factor = Insertion loss + Cable loss
 6. Emission Level = Correction Factor + Reading Value.

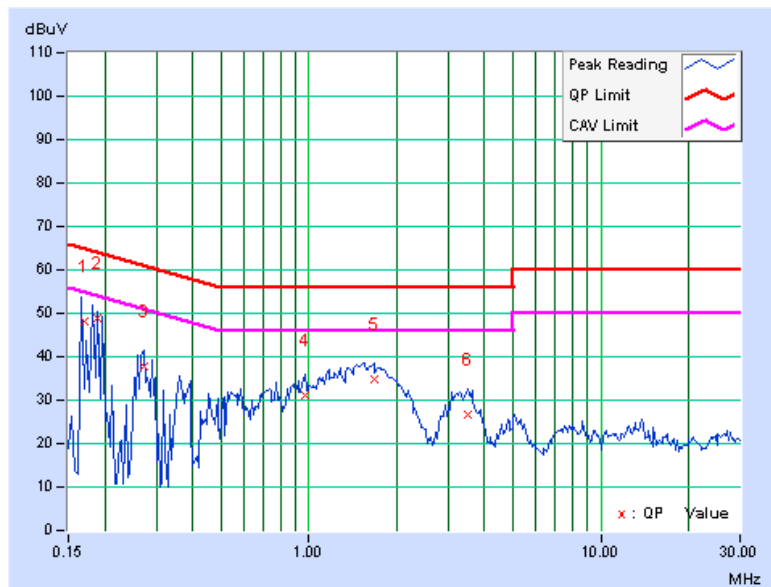



A D T

4.3 6dB BANDWIDTH MEASUREMENT

4.3.1 LIMITS OF 6dB BANDWIDTH MEASUREMENT

The minimum of 6dB Bandwidth Measurement is 0.5 MHz.

4.3.2 TEST SETUP

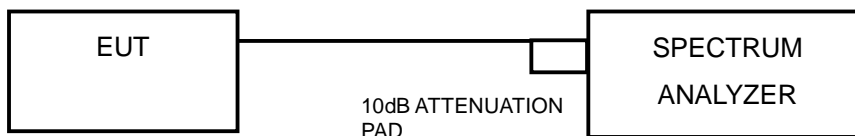

4.3.3 TEST INSTRUMENTS

DESCRIPTION & MANUFACTURER	MODEL NO.	SERIAL NO.	DATE OF CALIBRATION	DUE DATE OF CALIBRATION
R&S SPECTRUM ANALYZER	FSP 40	100036	May 9, 2012	May 8, 2013

NOTE: 1. The calibration interval of the above test instruments is 12 months and the calibrations are traceable to NML/ROC and NIST/USA.
2. Tested Date: Jul. 10, 2012.

4.3.4 TEST PROCEDURE

- Set resolution bandwidth (RBW) = approximately 1% of the emission bandwidth
- Set the video bandwidth (VBW) $\geq 3 \times$ RBW, Detector = Peak.
- Trace mode = max hold.
- Sweep = auto couple.
- Measure the maximum width of the emission that is constrained by the frequencies associated with the two amplitude points (upper and lower) that are attenuated by 6 dB relative to the maximum level measured in the fundamental emission

4.3.5 DEVIATION FROM TEST STANDARD

No deviation.

4.3.6 EUT OPERATING CONDITIONS

The software provided by client to enable the EUT under transmission condition continuously at lowest, middle and highest channel frequencies individually.



A D T

4.3.7 TEST RESULTS

802.11b

CHANNEL	FREQUENCY (MHz)	6dB BANDWIDTH (MHz)	MINIMUM LIMIT (MHz)	PASS / FAIL
1	2412	11.6	0.5	PASS
6	2437	10.4	0.5	PASS
11	2462	10.4	0.5	PASS

FOR CH 1

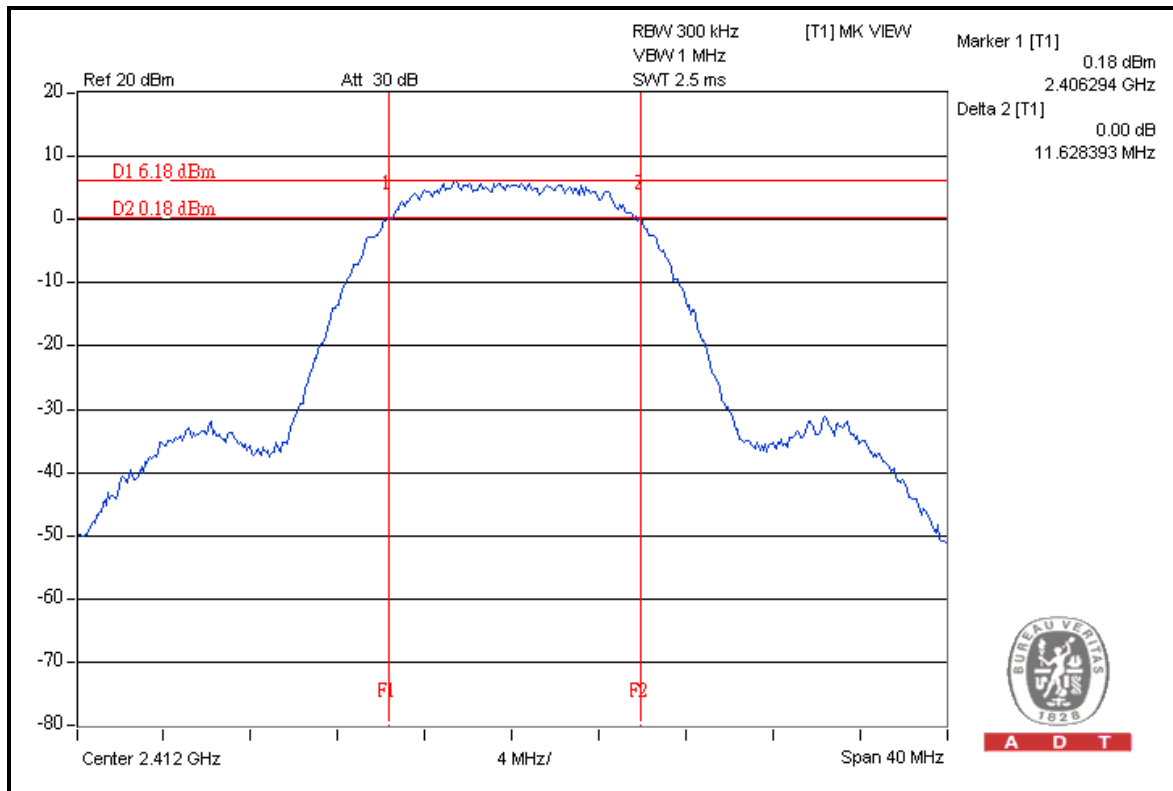



A D T

802.11g

CHANNEL	FREQUENCY (MHz)	6dB BANDWIDTH (MHz)	MINIMUM LIMIT (MHz)	PASS / FAIL
1	2412	16.3	0.5	PASS
6	2437	16.2	0.5	PASS
11	2462	16.2	0.5	PASS

FOR CH 1

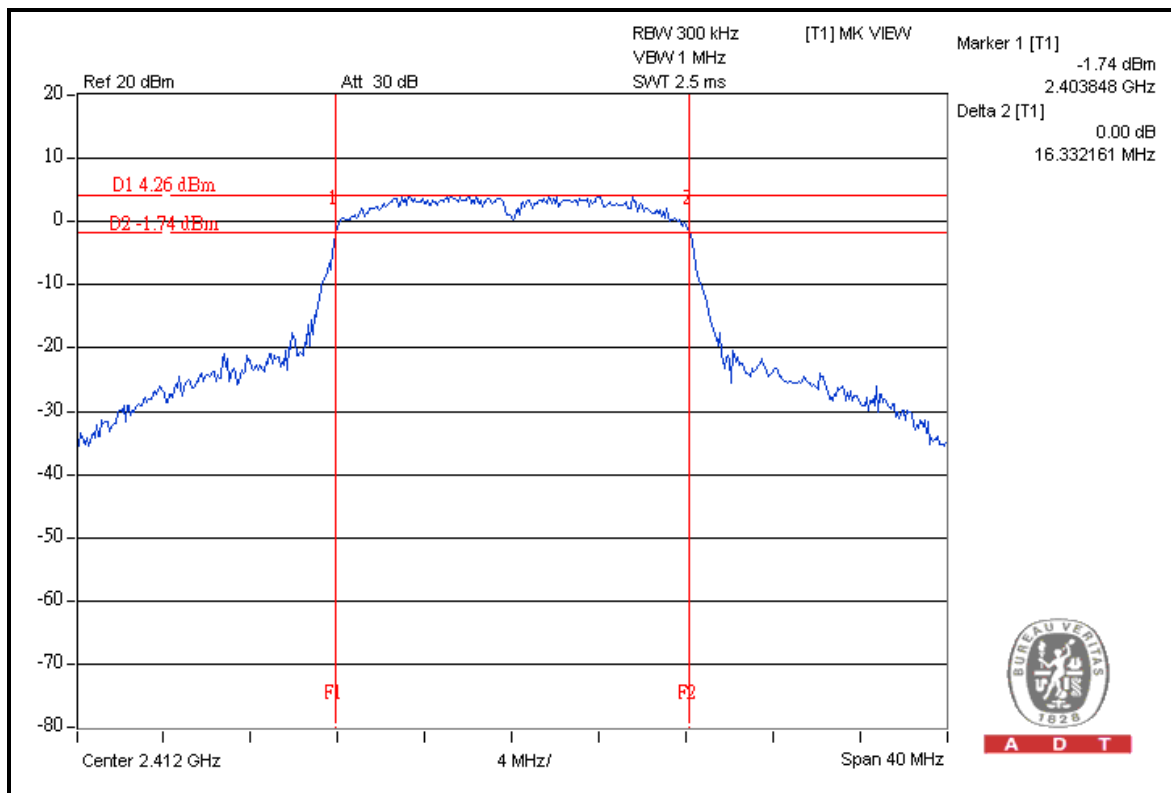



A D T

802.11n (20MHz)

CHANNEL	FREQUENCY (MHz)	6dB BANDWIDTH (MHz)	MINIMUM LIMIT (MHz)	PASS / FAIL
1	2412	16.7	0.5	PASS
6	2437	16.8	0.5	PASS
11	2462	16.9	0.5	PASS

FOR CH 11

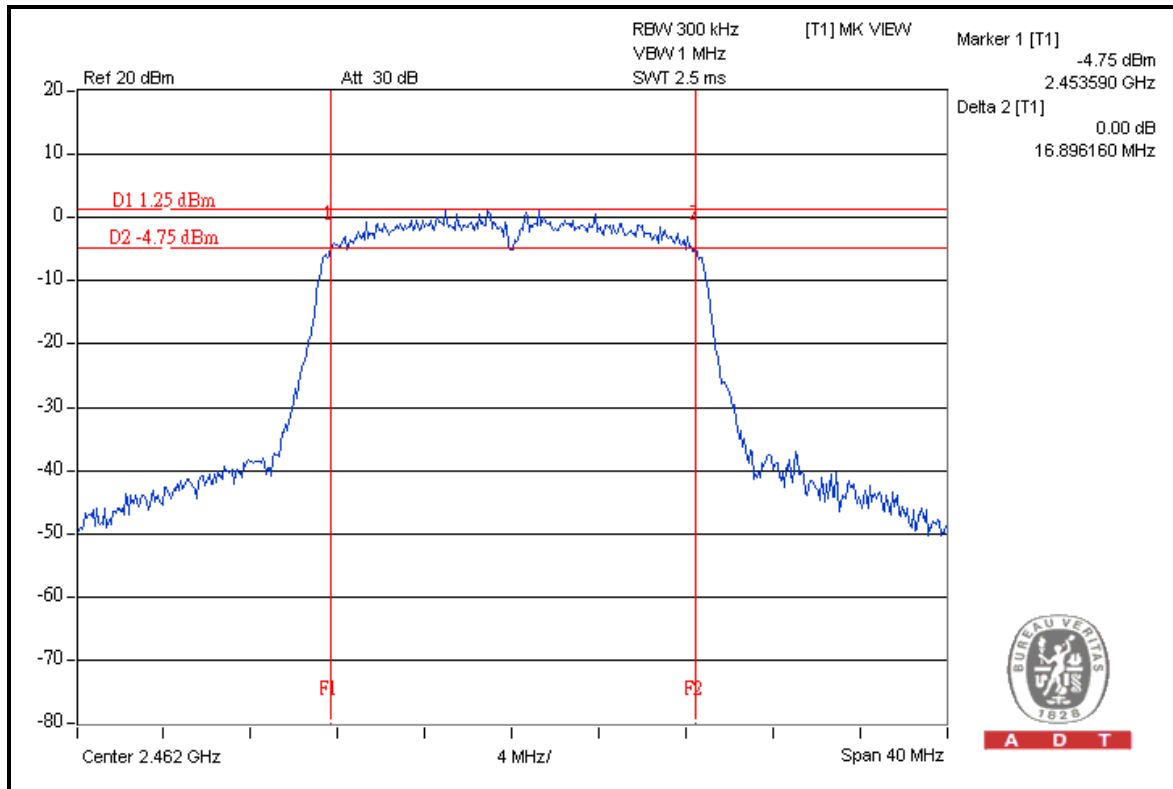



A D T

802.11n (40MHz)

CHANNEL	FREQUENCY (MHz)	6dB BANDWIDTH (MHz)	MINIMUM LIMIT (MHz)	PASS / FAIL
3	2422	33.0	0.5	PASS
6	2437	34.2	0.5	PASS
9	2452	33.8	0.5	PASS

FOR CH 6

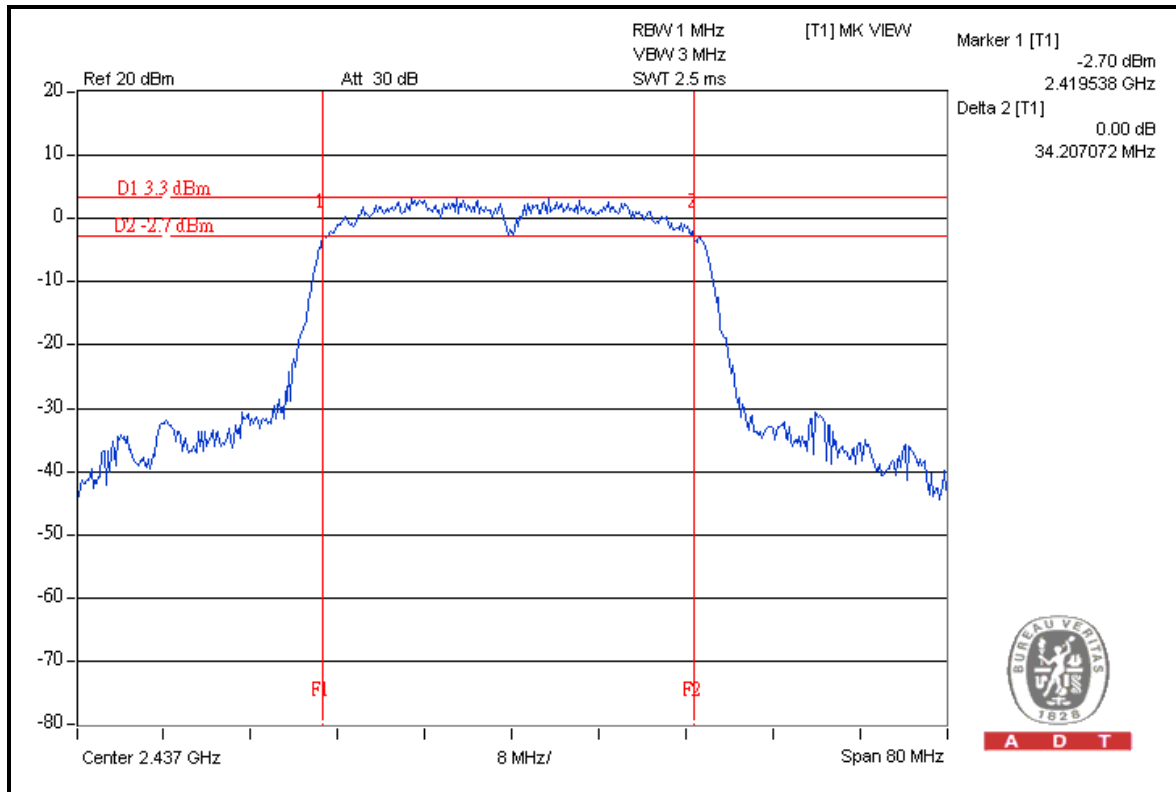



4.4 CONDUCTED OUTPUT POWER

4.4.1 LIMITS OF CONDUCTED OUTPUT POWER MEASUREMENT

For systems using digital modulation in the 2400–2483.5 MHz bands: 1 Watt (30dBm)

4.4.2 TEST SETUP

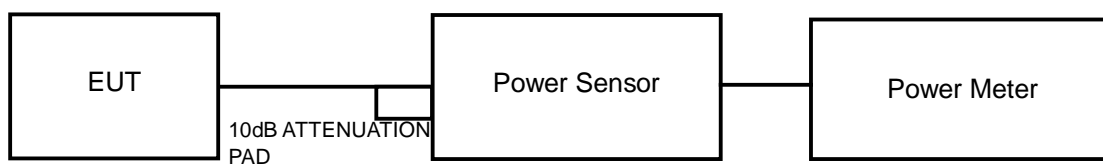

4.4.3 TEST INSTRUMENTS

DESCRIPTION & MANUFACTURER	MODEL NO.	SERIAL NO.	DATE OF CALIBRATION	DUE DATE OF CALIBRATION
Anritsu Power Sensor	MA2411B	0738404	Apr. 28, 2012	Apr. 27, 2013
Anritsu Power Meter	ML2495A	0842014	Apr. 28, 2012	Apr. 27, 2013

- Note:**
1. The calibration interval of the above test instruments is 12 months and the calibrations are traceable to NML/ROC and NIST/USA.
 2. Measurement Bandwidth of ML2495A is 65MHz greater than 6dB bandwidth of emission.
 3. Tested Date: Jul. 10, 2012.

4.4.4 TEST PROCEDURES

A peak power sensor was used on the output port of the EUT. A power meter was used to read the response of the peak power sensor. Record the peak power level.

4.4.5 DEVIATION FROM TEST STANDARD

No deviation.

4.4.6 EUT OPERATING CONDITIONS

Same as Item 4.3.6.



4.4.7 TEST RESULTS

802.11b

CHANNEL	FREQUENCY (MHz)	PEAK POWER (mW)	PEAK POWER (dBm)	LIMIT (dBm)	PASS/FAIL
1	2412	64.6	18.1	30	PASS
6	2437	81.3	19.1	30	PASS
11	2462	61.7	17.9	30	PASS

802.11g

CHANNEL	FREQUENCY (MHz)	PEAK POWER (mW)	PEAK POWER (dBm)	LIMIT (dBm)	PASS/FAIL
1	2412	204.2	23.1	30	PASS
6	2437	177.8	22.5	30	PASS
11	2462	190.5	22.8	30	PASS

802.11n (20MHz)

CHANNEL	FREQUENCY (MHz)	PEAK POWER (mW)	PEAK POWER (dBm)	LIMIT (dBm)	PASS/FAIL
1	2412	151.4	21.8	30	PASS
6	2437	309.0	24.9	30	PASS
11	2462	182.0	22.6	30	PASS

802.11n (40MHz)

CHANNEL	FREQUENCY (MHz)	PEAK POWER (mW)	PEAK POWER (dBm)	LIMIT (dBm)	PASS/FAIL
3	2422	75.9	18.8	30	PASS
6	2437	144.5	21.6	30	PASS
9	2452	63.1	18.0	30	PASS



4.5 POWER SPECTRAL DENSITY MEASUREMENT

4.5.1 LIMITS OF POWER SPECTRAL DENSITY MEASUREMENT

The Maximum of Power Spectral Density Measurement is 8dBm.

4.5.2 TEST SETUP

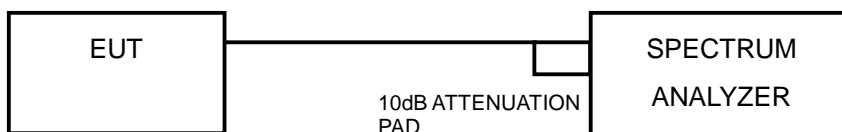

4.5.3 TEST INSTRUMENTS

DESCRIPTION & MANUFACTURER	MODEL NO.	SERIAL NO.	DATE OF CALIBRATION	DUE DATE OF CALIBRATION
R&S SPECTRUM ANALYZER	FSP 40	100036	May 9, 2012	May 8, 2013

- NOTE:** 1. The calibration interval of the above test instruments is 12 months and the calibrations are traceable to NML/ROC and NIST/USA.
2. Tested Date: Jul. 10, 2012.

4.5.4 TEST PROCEDURE

- Set the RBW = 100 kHz, VBW = 300 kHz, Detector = peak.
- Sweep time = auto couple, Trace mode = max hold, allow trace to fully stabilize.
- Use the peak marker function to determine the maximum power level in any 100 kHz band segment within the fundamental EBW.
- Scale the observed power level to an equivalent value in 3 kHz by adjusting (reducing) the measured power by a bandwidth correction factor (BWCF) where $BWCF = 10\log(3 \text{ kHz}/100\text{kHz})$

4.5.5 DEVIATION FROM TEST STANDARD

No deviation.

4.5.6 EUT OPERATING CONDITION

Same as Item 4.3.6



A D T

4.5.7 TEST RESULTS

802.11b

Channel	FREQ. (MHz)	PSD (dBm/100kHz)	PSD (dBm/3kHz)	Limit (dBm/3kHz)	PASS /FAIL
1	2412	2.56	-12.64	8	PASS
6	2437	1.18	-14.02	8	PASS
11	2462	-1.03	-16.23	8	PASS

FOR CH 1

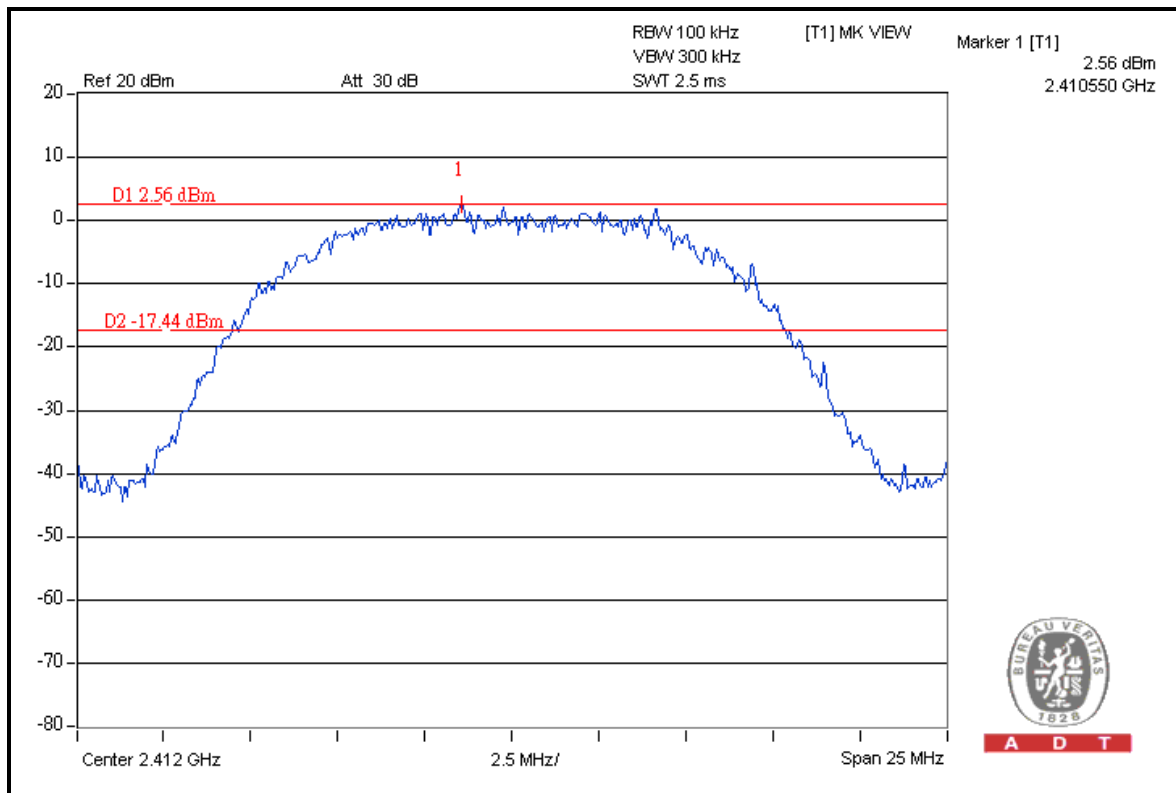



A D T

802.11g

Channel	FREQ. (MHz)	PSD (dBm/100kHz)	PSD (dBm/3kHz)	Limit (dBm/3kHz)	PASS /FAIL
1	2412	1.78	-13.42	8	PASS
6	2437	1.05	-14.15	8	PASS
11	2462	0.97	-14.23	8	PASS

FOR CH 1

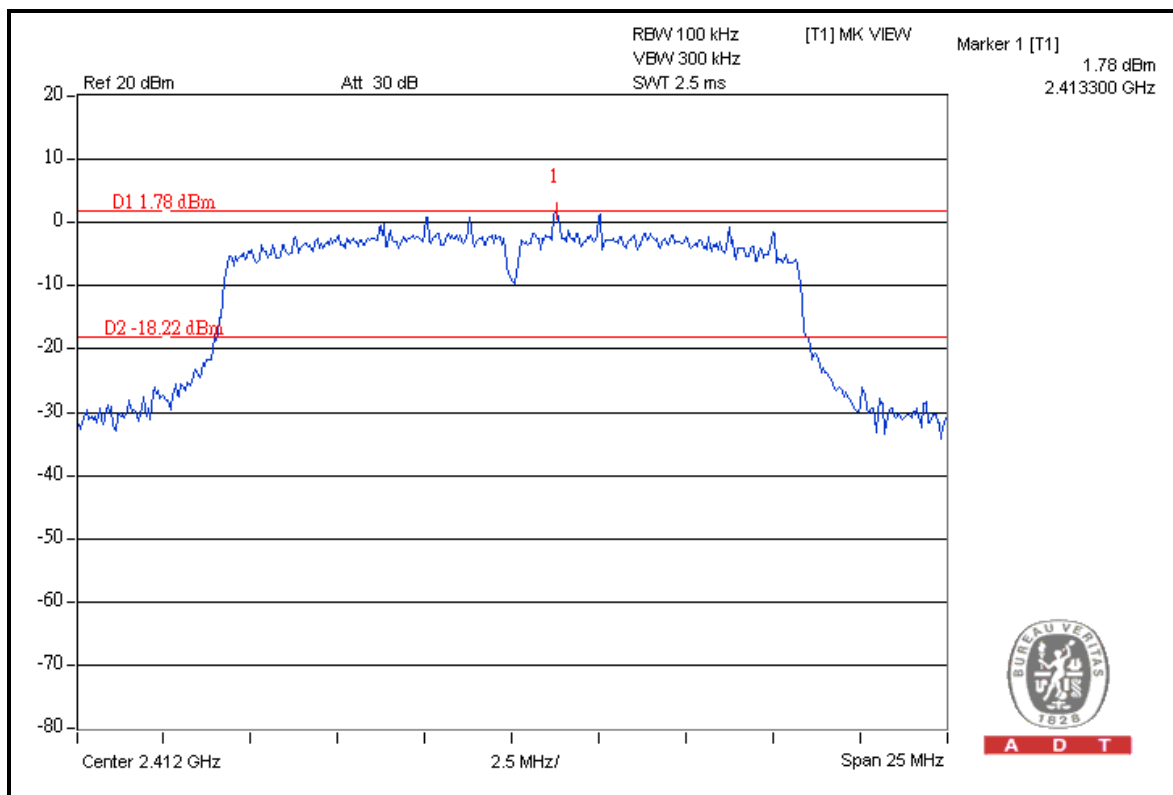



A D T

802.11n (20MHz)

Channel	FREQ. (MHz)	PSD (dBm/100kHz)	PSD (dBm/3kHz)	Limit (dBm/3kHz)	PASS /FAIL
1	2412	-2.95	-18.15	8	PASS
6	2437	-0.56	-15.76	8	PASS
11	2462	-2.75	-17.95	8	PASS

FOR CH 6

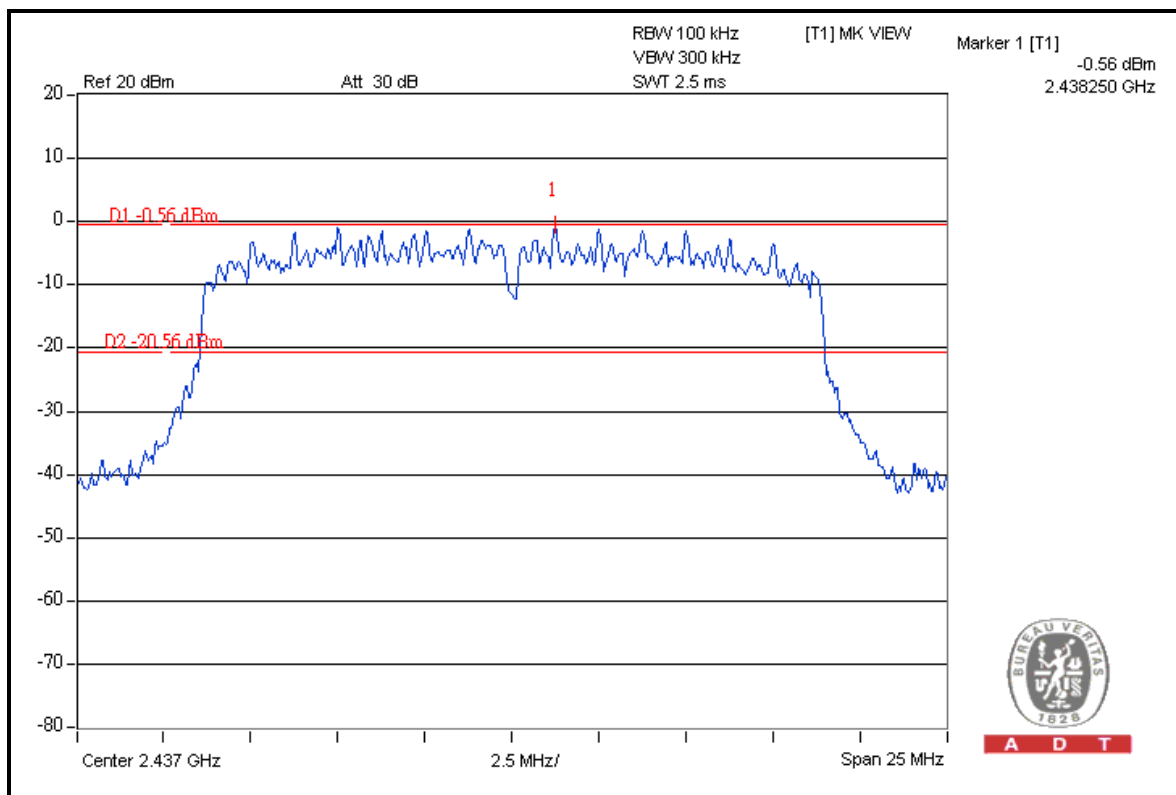

A D T



A D T

802.11n (40MHz)

Channel	FREQ. (MHz)	PSD (dBm/100kHz)	PSD (dBm/3kHz)	Limit (dBm/3kHz)	PASS /FAIL
3	2422	-9.08	-24.28	8	PASS
6	2437	-5.16	-20.36	8	PASS
9	2452	-10.37	-25.57	8	PASS

FOR CH 6

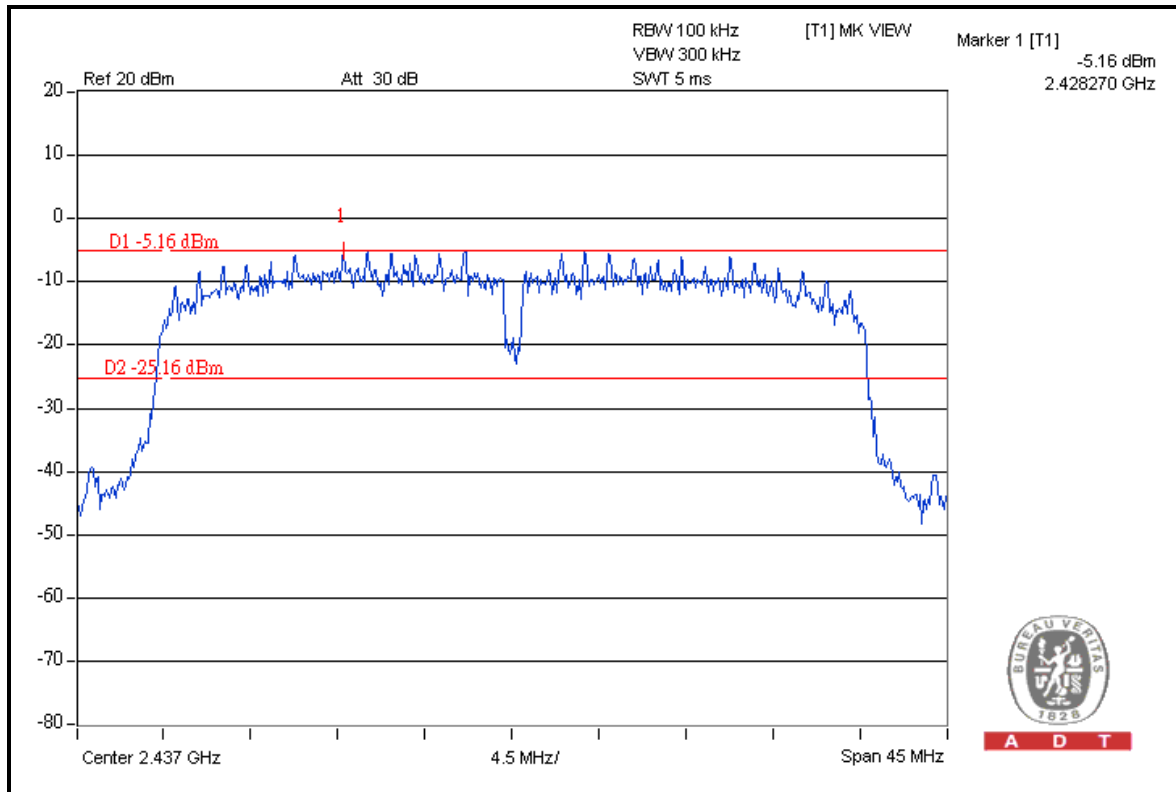

4.6 CONDUCTED OUT OF BAND EMISSION MEASUREMENT

4.6.1 LIMITS OF CONDUCTED OUT OF BAND EMISSION MEASUREMENT

Below -20dB of the highest emission level of operating band (in 100kHz Resolution Bandwidth).

4.6.2 TEST SETUP

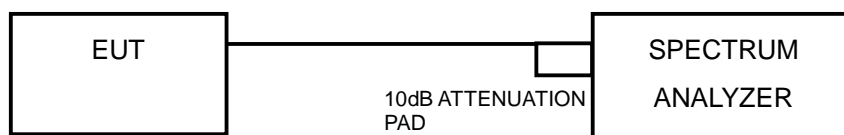

4.6.3 TEST INSTRUMENTS

DESCRIPTION & MANUFACTURER	MODEL NO.	SERIAL NO.	DATE OF CALIBRATION	DUE DATE OF CALIBRATION
R&S SPECTRUM ANALYZER	FSP 40	100036	May 9, 2012	May 8, 2013

NOTE: 1. The calibration interval of the above test instruments is 12 months and the calibrations are traceable to NML/ROC and NIST/USA.
2. Tested Date: Jul. 10, 2012.

4.6.4 TEST PROCEDURE

MEASUREMENT PROCEDURE REF

1. Set the RBW = 100 kHz.
2. Set the VBW \geq 300 kHz.
3. Detector = peak.
4. Sweep time = auto couple.
5. Trace mode = max hold.
6. Allow trace to fully stabilize.
7. Use the peak marker function to determine the maximum power level in any 100 kHz band segment within the fundamental EBW.



A D T

MEASUREMENT PROCEDURE OOB

1. Set RBW = 100 kHz.
2. Set VBW \geq 300 kHz.
3. Set span to encompass the spectrum to be examined.
4. Detector = peak.
5. Trace Mode = max hold.
6. Sweep = auto couple.

4.6.5 DEVIATION FROM TEST STANDARD

No deviation.

4.6.6 EUT OPERATING CONDITION

Same as Item 4.3.6

4.6.7 TEST RESULTS

The spectrum plots are attached on the following pages. D1 line indicates the highest level, and D2 line indicates the 20dB offset below D1. It shows compliance with the requirement.



A D T

802.11b

CH 1

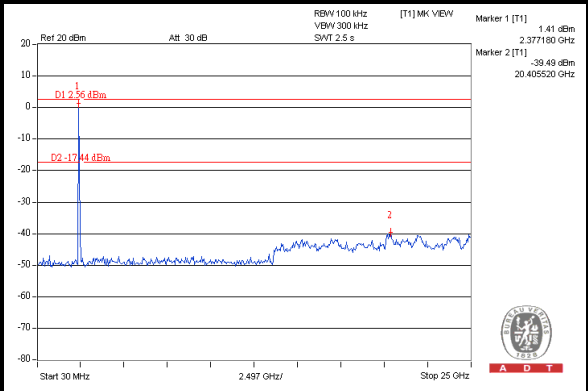
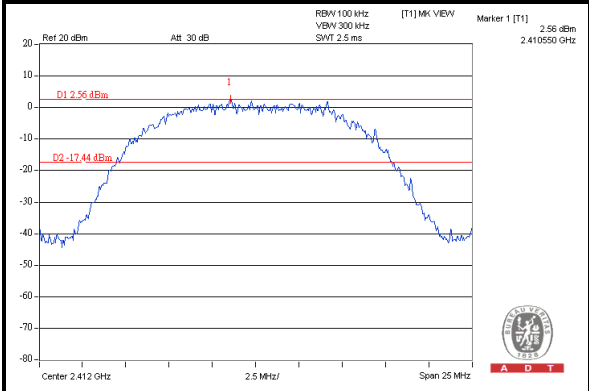

CH 6

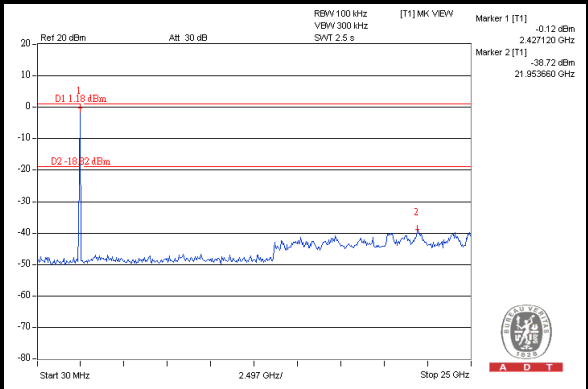
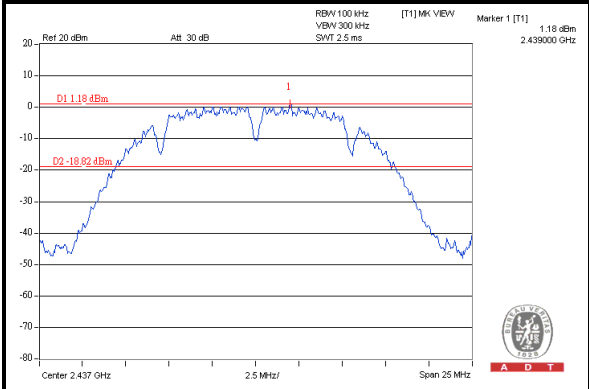

CH 11

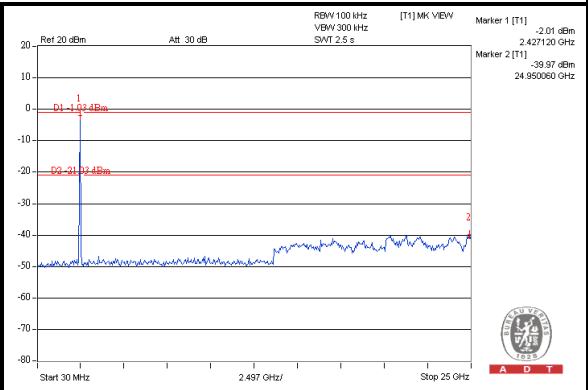
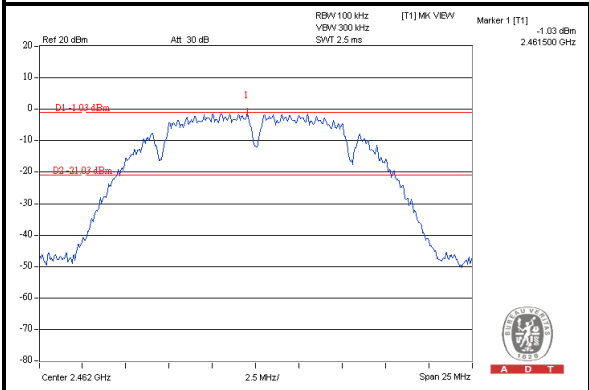



A D T

802.11g

CH 1

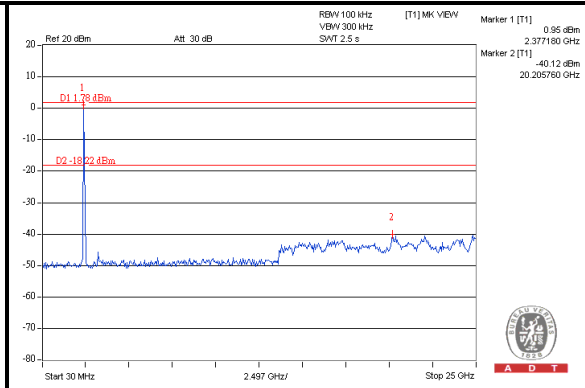
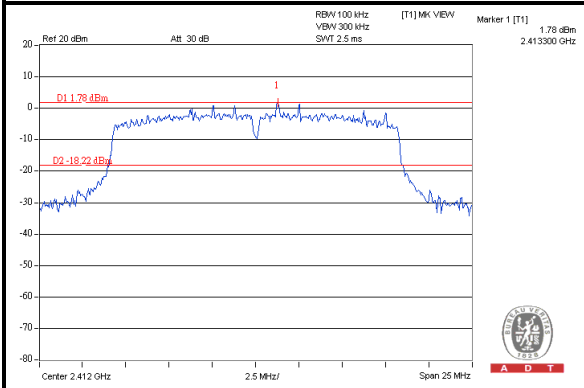

CH 6

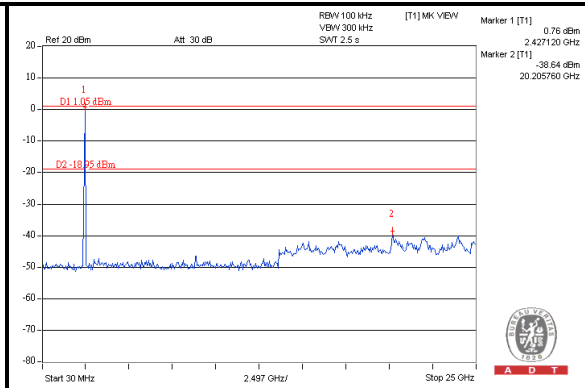
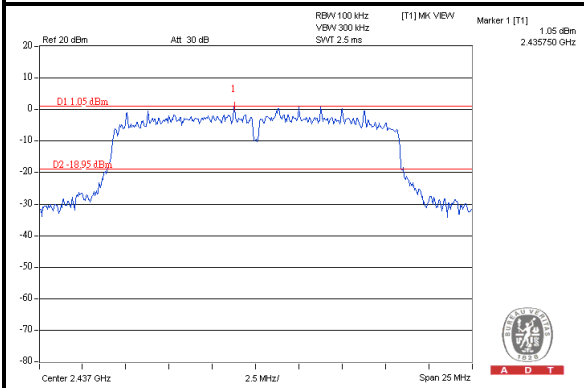

CH 11

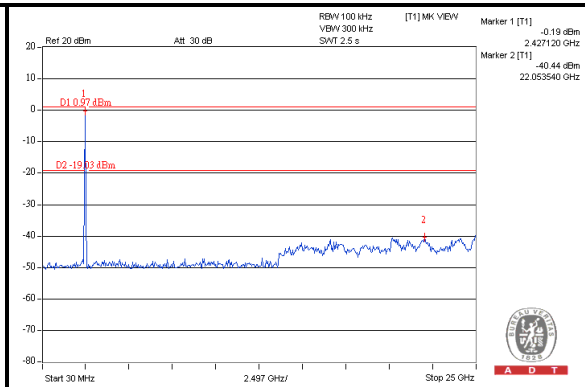
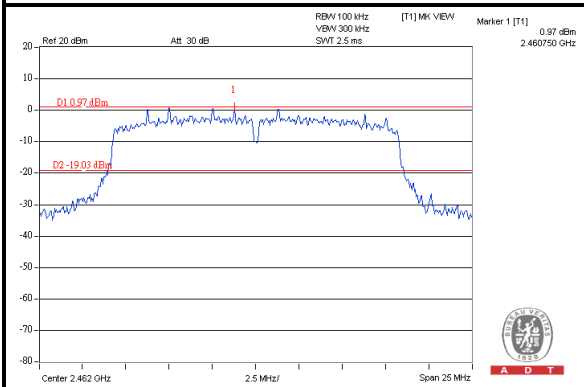



A D T

802.11n (20MHz)

CH 1

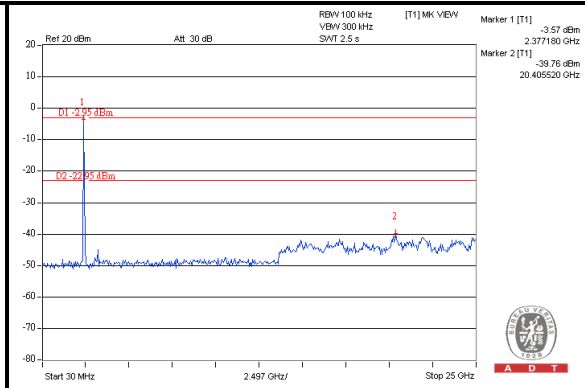
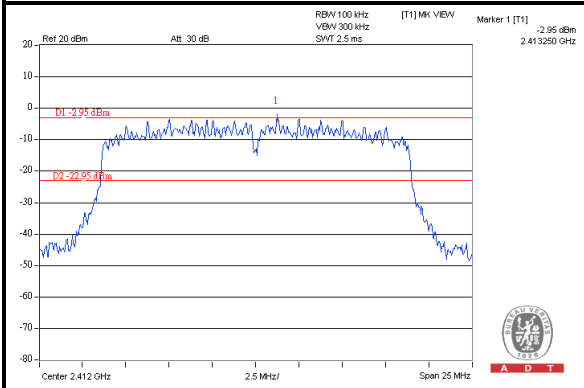

CH 6

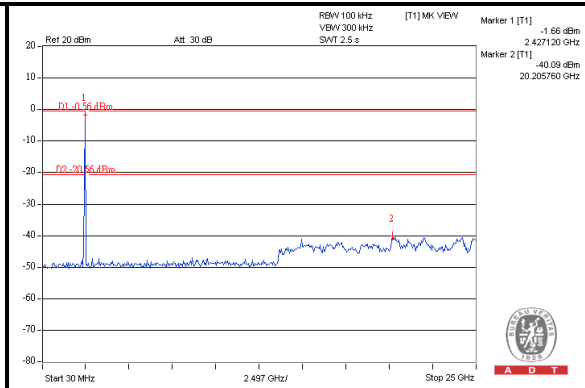
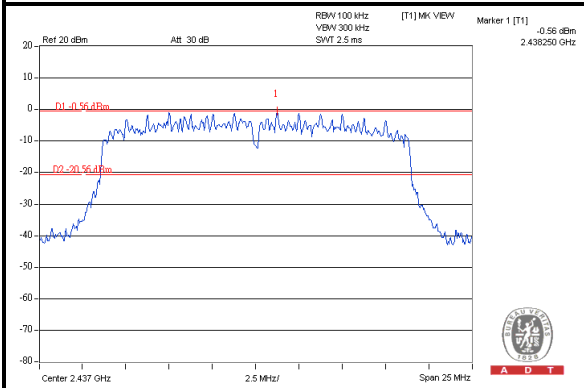

CH 11

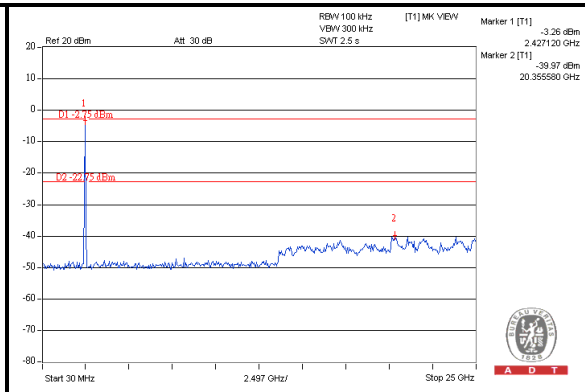
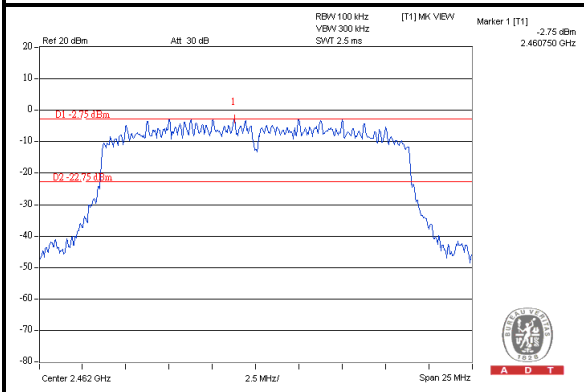



A D T

802.11n (40MHz)

CH 3

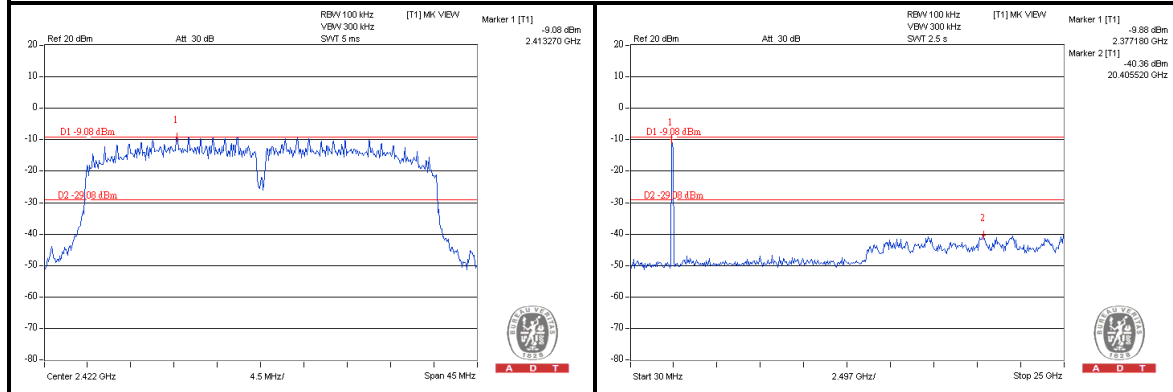

CH 6

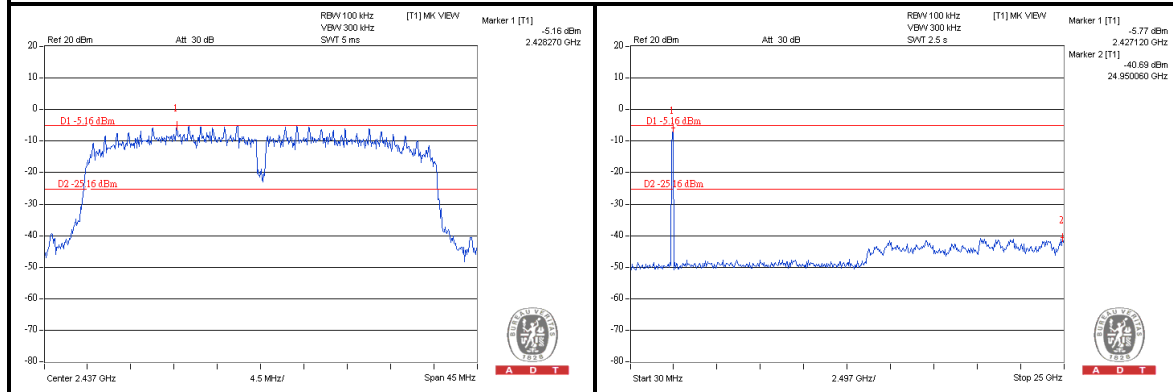

CH 9

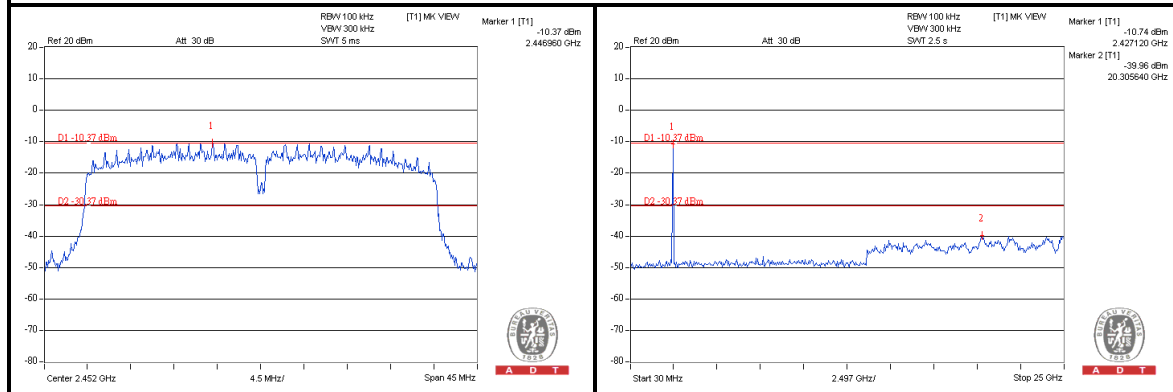



A D T

5. PHOTOGRAPHS OF THE TEST CONFIGURATION

Please refer to the attached file (Test Setup Photo).

6. INFORMATION ON THE TESTING LABORATORIES

We, Bureau Veritas Consumer Products Services (H.K.) Ltd., Taoyuan Branch, were founded in 1988 to provide our best service in EMC, Radio, Telecom and Safety consultation. Our laboratories are accredited and approved according to ISO/IEC 17025.

If you have any comments, please feel free to contact us at the following:

Linko EMC/RF Lab:

Tel: 886-2-26052180

Fax: 886-2-26051924

Hsin Chu EMC/RF Lab:

Tel: 886-3-5935343

Fax: 886-3-5935342

Hwa Ya EMC/RF/Safety Telecom Lab:

Tel: 886-3-3183232

Fax: 886-3-3270892

Email: service.adt@tw.bureauveritas.com

Web Site: www.adt.com.tw

The address and road map of all our labs can be found in our web site also.



A D T

7. APPENDIX A - MODIFICATIONS RECORDERS FOR ENGINEERING CHANGES TO THE EUT BY THE LAB

No modifications were made to the EUT by the lab during the test.

---END---