

Radio Test Report

Report No.:STS2308110W02

Issued for

Lifeworks Technology Group LLC.

530 7th Ave 21st Fl, New York, NY 10018, United States

Product Name: Wireless Headset

Brand Name: MONSTER

Model Name: 2MNHP2091

Series Model(s): 2MNHP2091B0L2, 2MNHP2091G0L2

FCC ID: WWE-2MNHP2091

Test Standards: FCC Part15.247

Any reproduction of this document must be done in full. No single part of this document may be reproduced without permission from STS, all test data presented in this report is only applicable to presented test sample.



TEST REPORT

Applicant's Name Lifeworks Technology Group LLC.

Address..... 530 7th Ave 21st Fl, New York, NY 10018, United States

Manufacturer's Name Lifeworks Technology Group LLC.

Address..... 530 7th Ave 21st Fl, New York, NY 10018, United States

Product Description

Product Name Wireless Headset

Brand Name..... MONSTER

Model Name..... 2MNHP2091

Series Model(s) 2MNHP2091B0L2, 2MNHP2091G0L2

Test Standards..... FCC Part15.247

Test Procedure..... ANSI C63.10-2013

This device described above has been tested by STS, the test results show that the equipment under test (EUT) is in compliance with the FCC requirements. And it is applicable only to the tested sample identified in the report.

This report shall not be reproduced except in full, without the written approval of STS, this document may be altered or revised by STS, personal only, and shall be noted in the revision of the document.

Date of Test..... :

Date of receipt of test item : 17 Aug. 2023

Date (s) of performance of tests : 17 Aug. 2023 ~ 25 Aug. 2023

Date of Issue : 25 Aug. 2023

Test Result : Pass

Testing Engineer :

Aaron Bu

(Aaron Bu)

Technical Manager :

Sean She

(Sean she)

Authorized Signatory :

Chris Chen

(Chris Chen)





Table of Contents	Page
1. SUMMARY OF TEST RESULTS	6
1.1 TEST FACTORY	7
1.2 MEASUREMENT UNCERTAINTY	7
2. GENERAL INFORMATION	8
2.1 GENERAL DESCRIPTION OF THE EUT	8
2.2 DESCRIPTION OF THE TEST MODES	10
2.3 FREQUENCY HOPPING SYSTEM REQUIREMENTS	10
2.4 TABLE OF PARAMETERS OF TEST SOFTWARE SETTING	12
2.5 BLOCK DIAGRAM SHOWING THE CONFIGURATION OF SYSTEM TESTED	13
2.6 DESCRIPTION OF NECESSARY ACCESSORIES AND SUPPORT UNITS	14
2.7 EQUIPMENTS LIST	15
3. EMC EMISSION TEST	16
3.1 CONDUCTED EMISSION MEASUREMENT	16
3.2 RADIATED EMISSION MEASUREMENT	20
4. CONDUCTED SPURIOUS & BAND EDGE EMISSION	32
4.1 LIMIT	32
4.2 TEST PROCEDURE	32
4.3 TEST SETUP	33
4.4 EUT OPERATION CONDITIONS	33
4.5 TEST RESULTS	33
5. NUMBER OF HOPPING CHANNEL	34
5.1 LIMIT	34
5.2 TEST PROCEDURE	34
5.3 TEST SETUP	34
5.4 EUT OPERATION CONDITIONS	34
5.5 TEST RESULTS	34
6. AVERAGE TIME OF OCCUPANCY	35
6.1 LIMIT	35
6.2 TEST PROCEDURE	35
6.3 TEST SETUP	35
6.4 EUT OPERATION CONDITIONS	35
6.5 TEST RESULTS	35
7. HOPPING CHANNEL SEPARATION MEASUREMENT	36



Table of Contents	Page
7.1 LIMIT	36
7.2 TEST PROCEDURE	36
7.3 TEST SETUP	36
7.4 EUT OPERATION CONDITIONS	36
7.5 TEST RESULTS	36
8. BANDWIDTH TEST	37
8.1 LIMIT	37
8.2 TEST PROCEDURE	37
8.3 TEST SETUP	37
8.4 EUT OPERATION CONDITIONS	37
8.5 TEST RESULTS	37
9. OUTPUT POWER TEST	38
9.1 LIMIT	38
9.2 TEST PROCEDURE	38
9.3 TEST SETUP	38
9.4 EUT OPERATION CONDITIONS	38
9.5 TEST RESULTS	38
10. ANTENNA REQUIREMENT	39
10.1 STANDARD REQUIREMENT	39
10.2 EUT ANTENNA	39
APPENDIX 1-TEST DATA	40
1. MAXIMUM AVERAGE CONDUCTED OUTPUT POWER	40
2. MAXIMUM PEAK CONDUCTED OUTPUT POWER	46
3. -20DB BANDWIDTH	52
5. CARRIER FREQUENCIES SEPARATION	58
6. NUMBER OF HOPPING CHANNEL	64
7. BAND EDGE	67
8. BAND EDGE(HOPPING)	74
9. CONDUCTED RF SPURIOUS EMISSION	81
10. DWELL TIME	91
APPENDIX 2-PHOTOS OF TEST SETUP	95



Revision History

Rev.	Issue Date	Report No.	Effect Page	Contents
00	25 Aug. 2023	STS2308110W02	ALL	Initial Issue



1. SUMMARY OF TEST RESULTS

Test procedures according to the technical standards:
KDB 558074 D01 15.247 Meas Guidance v05r02.

FCC Part 15.247, Subpart C			
Standard Section	Test Item	Judgment	Remark
15.207	Conducted Emission	PASS	--
15.247(a)(1)	Hopping Channel Separation	PASS	--
15.247(a)(1)&(b)(1)	Output Power	PASS	--
15.209	Radiated Spurious Emission	PASS	--
15.247(d)	Conducted Spurious & Band Edge Emission	PASS	--
15.247(a)(1)(iii)	Number of Hopping Frequency	PASS	--
15.247(a)(1)(iii)	Dwell Time	PASS	--
15.247(a)(1)	Bandwidth	PASS	--
15.205	Restricted bands of operation	PASS	--
Part 15.247(d)/part 15.209(a)	Band Edge Emission	PASS	--
15.203	Antenna Requirement	PASS	--

NOTE:

- (1) 'N/A' denotes test is not applicable in this Test Report.
- (2) All tests are according to ANSI C63.10-2013.



1.1 TEST FACTORY

SHENZHEN STS TEST SERVICES CO., LTD

Add. : 101, Building B, Zhuoke Science Park, No.190 Chongqing Road, ZhanChengShequ, Fuhai Sub-District, Bao'an District, Shenzhen, Guang Dong, China

FCC test Firm Registration Number: 625569

IC test Firm Registration Number: 12108A

A2LA Certificate No.: 4338.01

1.2 MEASUREMENT UNCERTAINTY

The reported uncertainty of measurement $y \pm U$, where expanded uncertainty U is based on a standard uncertainty multiplied by a coverage factor of $k=2$, providing a level of confidence of approximately **95** %.

No.	Item	Uncertainty
1	RF output power, conducted	$\pm 1.197\text{dB}$
2	Unwanted Emissions, conducted	$\pm 2.896\text{dB}$
3	All emissions, radiated 9K-30MHz	$\pm 3.84\text{dB}$
4	All emissions, radiated 30M-1GHz	$\pm 3.94\text{dB}$
5	All emissions, radiated 1G-6GHz	$\pm 4.59\text{dB}$
6	All emissions, radiated >6G	$\pm 5.22\text{dB}$
7	Conducted Emission (9KHz-150KHz)	$\pm 2.14\text{dB}$
8	Conducted Emission (150KHz-30MHz)	$\pm 2.54\text{dB}$
9	Occupied Channel Bandwidth	$\pm 3.5\%$
10	Dwell time	$\pm 3.2\%$

2. GENERAL INFORMATION

2.1 GENERAL DESCRIPTION OF THE EUT

Product Name	Wireless Headset	
Brand Name	MONSTER	
Model Name	2MNHP2091	
Series Model(s)	2MNHP2091B0L2, 2MNHP2091G0L2	
Model Difference	Only the color and the name are different	
Product Description	The EUT is a Wireless Headset	
	Operation Frequency:	2402~2480 MHz
	Modulation Type:	GFSK(1Mbps), $\pi/4$ -DQPSK(2Mbps), 8DPSK(3Mbps)
	Radio Technology:	BT
	Bluetooth Configuration:	BR+EDR
	Number Of Channel:	79
	Antenna Type:	Ceramic
Antenna Gain (dBi)	2.71dBi	
Channel List	Please refer to the Note 3.	
Rating	Input: DC5V 1A	
Battery	Rated Voltage: 3.7V Charge Limit Voltage: 4.2V Capacity: 1000mAh	
Hardware version number	V1.0	
Software version number	V12	
Connecting I/O Port(s)	Please refer to the Note 1.	

Note:

1. For a more detailed features description, please refer to the manufacturer's specifications or the User Manual.
2. The antenna information refer the manufacturer provide report, applicable only to the tested sample identified in the report. Due to the incorrect antenna information, a series of problems such as the accuracy of the test results will be borne by the customer.



3.

Channel List					
Channel	Frequency (MHz)	Channel	Frequency (MHz)	Channel	Frequency (MHz)
00	2402	27	2429	54	2456
01	2403	28	2430	55	2457
02	2404	29	2431	56	2458
03	2405	30	2432	57	2459
04	2406	31	2433	58	2460
05	2407	32	2434	59	2461
06	2408	33	2435	60	2462
07	2409	34	2436	61	2463
08	2410	35	2437	62	2464
09	2411	36	2438	63	2465
10	2412	37	2439	64	2466
11	2413	38	2440	65	2467
12	2414	39	2441	66	2468
13	2415	40	2442	67	2469
14	2416	41	2443	68	2470
15	2417	42	2444	69	2471
16	2418	43	2445	70	2472
17	2419	44	2446	71	2473
18	2420	45	2447	72	2474
19	2421	46	2448	73	2475
20	2422	47	2449	74	2476
21	2423	48	2450	75	2477
22	2424	49	2451	76	2478
23	2425	50	2452	77	2479
24	2426	51	2453	78	2480
25	2427	52	2454		
26	2428	53	2455		

2.2 DESCRIPTION OF THE TEST MODES

To investigate the maximum EMI emission characteristics generates from EUT, the test system was pre-scanning tested base on the consideration of following EUT operation mode or test configuration mode which possible have effect on EMI emission level. Each of these EUT operation mode(s) or test configuration mode(s) mentioned above was evaluated respectively.

Worst Mode	Description	Data Rate/Modulation
Mode 1	TX CH00	1Mbps/GFSK
Mode 2	TX CH39	1Mbps/GFSK
Mode 3	TX CH78	1Mbps/GFSK
Mode 4	TX CH00	2 Mbps/ π /4-DQPSK
Mode 5	TX CH39	2 Mbps/ π /4-DQPSK
Mode 6	TX CH78	2 Mbps/ π /4-DQPSK
Mode7	TX CH00	3 Mbps/8DPSK
Mode 8	TX CH39	3 Mbps/8DPSK
Mode 9	TX CH78	3 Mbps/8DPSK
Mode 10	Hopping	GFSK
Mode 11	Hopping	π /4-DQPSK
Mode 12	Hopping	8DPSK

Note:

(1) The measurements are performed at all Bit Rate of Transmitter, the worst data was reported.

(2) We tested for all available U.S. voltage and frequencies (For 120V, 50/60Hz and 240V, 50/60Hz) for which the device is capable of operation, and the worst case of 120V/ 60Hz is shown in the report.

(3) The battery is fully-charged during the radiated and RF conducted test.

For AC Conducted Emission

Test Case	
AC Conducted Emission	Mode 13 : Keeping BT TX

2.3 FREQUENCY HOPPING SYSTEM REQUIREMENTS

(1)Standard and Limit

According to FCC Part 15.247(a)(1), The system shall hop to channel frequencies that are selected at the system hopping rate from a pseudo randomly ordered list of hopping frequencies. Each frequency must be used equally on the average by each transmitter. The system receivers shall have input bandwidths that match the hopping channel bandwidths of their corresponding transmitters and shall shift frequencies in synchronization with the transmitted signals.

Frequency hopping spread spectrum systems are not required to employ all available hopping channels during each transmission. However, the system, consisting of both the transmitter and the receiver, must be designed to comply with all of the regulations in this section should the transmitter be presented with a continuous data (or information) stream. In addition, a system employing short transmission bursts must comply with the definition of a frequency hopping system and must distribute its transmissions over the minimum number of hopping channels specified in this section.

The incorporation of intelligence within a frequency hopping spread spectrum system that permits the system to recognize other users within the spectrum band so that it individually and independently chooses and adapts its hop sets to avoid hopping on occupied channels is permitted. The coordination of frequency hopping systems in any other manner for the express purpose of avoiding the simultaneous occupancy of individual hopping frequencies by multiple transmitters is not permitted.

(2)The Pseudorandom sequence may be generated in a nine-stage shift register whose 5th and 9th stage outputs are added in a modulo-two addition stage. And the result is fed back to the input of the first stage. The sequence begins with the first one of 9 consecutive ones: i.e. the shift register is initialized with nine ones.

Numver of shift register stages:9

Length of pseudo-random sequence: $2^9-1=511$ bits

Longest sequence of zeros: 8(non-inverted signal)

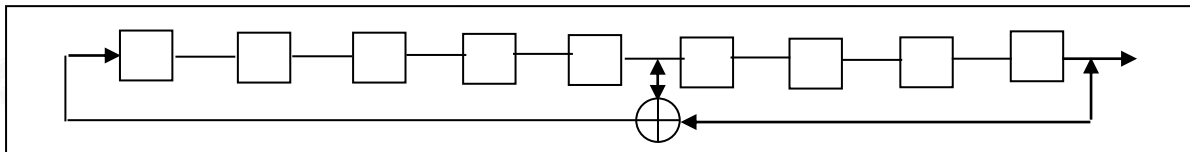

Liner Feedback Shift Register for Generator of the PRBS sequence

An example of Pseudorandom Frequency Hopping Sequence as follow:

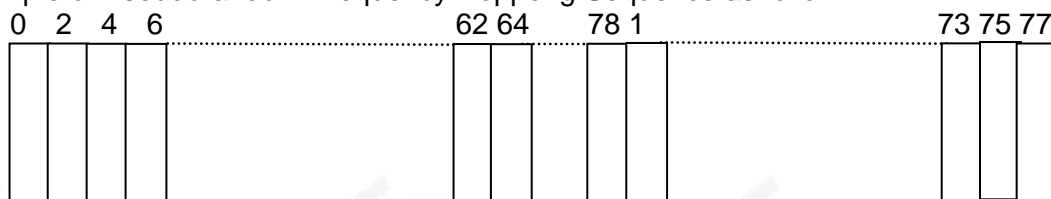

Each frequency used equally on th average by each transmitter.

The system receivers have input bandwidths that match the hopping channel bandwidths of their corresponding transmitters and shift frequencies ini synchronization with the transmitted signals.

(3)Frequency Hopping System

This transmitter device is frequency hopping device, and complies with FCC part 15.247 rule.

This device uses Bluetooth radio which operates in 2400-2483.5 MHz band. Bluetooth uses a radio technology called frequency-hopping spread spectrum, which chops up the data being sent and transmits chunks of it on up to 79 bands (1 MHz each; centred from 2402 to 2480 MHz) in the range 2,400-2,483.5MHz. The transmitter switches hop frequencies 1,600 times per second to assure a high degree of data security. All Bluetooth devices participating in a given piconet are synchronized to the frequency-hopping channel for the piconet. The frequency hopping sequence is determined by the master's device address and the phase of the hopping sequence (the frequency to hop at a specific time) is determined by the master's internal clock. Therefore, all slaves in a piconet must know the master's device address and must synchronize their clocks with the master's clock.

Adaptive Frequency Hopping (AFH) was introduced in the Bluetooth specification to provide an effective way for a Bluetooth radio to counteract normal interference. AFH identifies "bad" channels, where either other wireless devices are interfering with the Bluetooth signal or the Bluetooth signal is interfering with another device. The AFH-enabled Bluetooth device will then communicate with other devices within its piconet to share details of any identified bad channels. The devices will then switch to alternative available "good" channels, away from the areas of interference, thus having no impact on the bandwidth used.

This device was tested with a bluetooth system receiver to check that the device maintained hopping synchronization, and the device complied with these requirements FCC Part 15.247 rule.



2.4 TABLE OF PARAMETERS OF TEST SOFTWARE SETTING

During testing channel & power controlling software provided by the customer was used to control the operating channel as well as the output power level. The RF output power selection is for the setting of RF output power expected by the customer and is going to be fixed on the firmware of the final end product power parameters of FHSS.

(Control software) Parameters(1/2/3Mbps)	Test program: Bluetooth		
	Packet type: DH1:4:27 2DH1:20:54 3DH1:24:83	Packet type: DH3:11:183 2DH3:26:367 3DH3:27:552	Packet type: DH5:15:339 2DH5:30:679 3DH5:31:1021

RF Function	Type	Mode Or Modulation type	ANT Gain(dBi)	Power Class	Software For Testing
BT	BR+EDR	GFSK	2.71	4	BT_Tool
		$\pi/4$ -DQPSK	2.71	4	
		8DPSK	2.71	4	

2.5 BLOCK DIAGRAM SHOWING THE CONFIGURATION OF SYSTEM TESTED

Radiated Spurious Emission Test

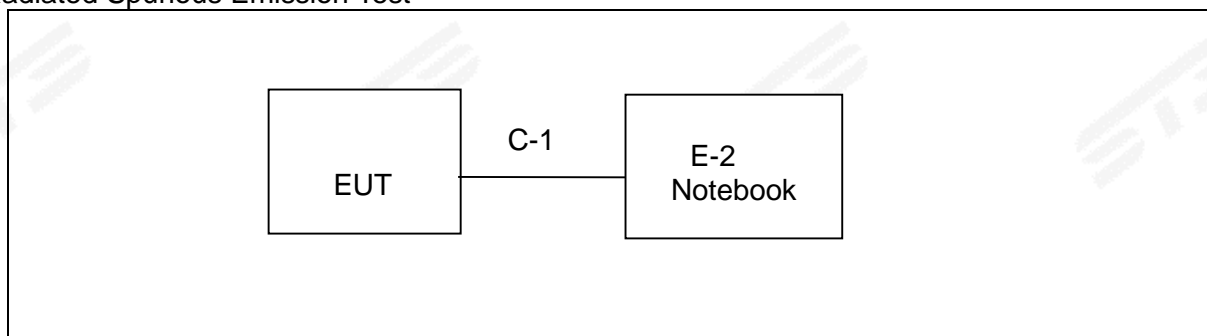

Conducted Emission Test

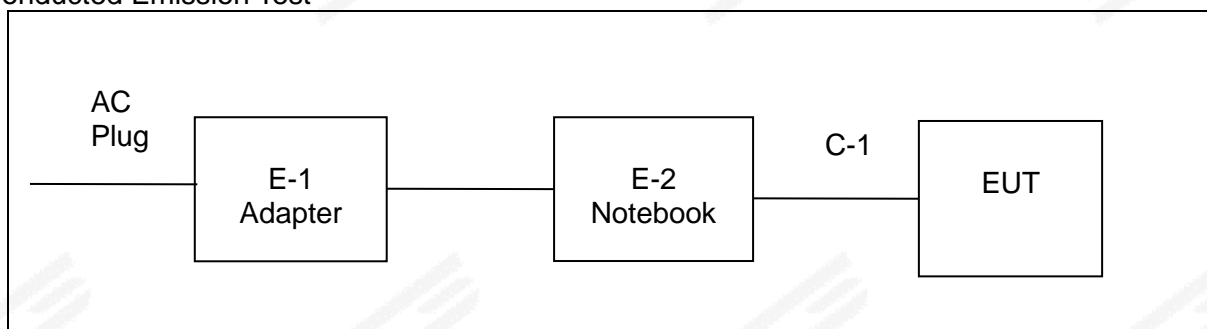



2.6 DESCRIPTION OF NECESSARY ACCESSORIES AND SUPPORT UNITS

The EUT has been tested as an independent unit together with other necessary accessories or support units. The following support units or accessories were used to form a representative test configuration during the tests.

Necessary accessories

Item	Equipment	Mfr/Brand	Model/Type No.	Length	Note
N/A	N/A	N/A	N/A	N/A	N/A

Support units

Item	Equipment	Mfr/Brand	Model/Type No.	Length	Note
E-1	Notebook Adapter	LENOVO	ADLX45DLC3A	N/A	N/A
E-2	Notebook	LENOVO	ThinkPad E470	N/A	N/A
C-1	USB Cable	N/A	N/A	150cm	NO

Note:

- (1) For detachable type I/O cable should be specified the length in cm in 'Length' column.
- (2) "YES" is means "with core"; "NO" is means "without core".



2.7 EQUIPMENTS LIST

RF Radiation Test Equipment					
Kind of Equipment	Manufacturer	Type No.	Serial No.	Last Calibration	Calibrated Until
Temperature & Humidity	SW-108	SuWei	N/A	2023.03.03	2024.03.02
Pre-Amplifier (0.1M-3GHz)	EM	EM330	060665	2023.02.28	2024.02.27
Pre-Amplifier (1G-18GHz)	SKET	LNPA-01018G-45	SK2018080901	2022.09.29	2023.09.28
18GHz-40GHz Filter	XINGBO	XBLBQ-GTA44	22062003-1	2023.03.06	2024.03.05
Pre-mpifier (18G-40G)	SKET	LNPA_1840-50	SK2018101801	2023.03.06	2024.03.05
Positioning Controller	MF	MF-7802	MF-780208587	N/A	N/A
Signal Analyzer	R&S	FSV 40-N	101823	2022.09.29	2023.09.28
Switch Control Box	N/A	N/A	N/A	N/A	N/A
Filter Box	BALUN Technology	SU319E	BL-SZ1530051	N/A	N/A
Active loop Antenna	ZHINAN	ZN30900C	16035	2023.02.28	2024.02.27
Bilog Antenna	TESEQ	CBL6111D	34678	2022.09.30	2024.09.29
Horn Antenna	SCHWARZBECK	BBHA 9120D	02014	2021.10.11	2023.10.10
Horn Antenna	A-INFOMW	LB-180400-KF	J211020657	2021.09.28	2023.09.27
Antenna Mast	MF	MFA-440H	N/A	N/A	N/A
Turn Table	MF	SC100_1	60531	N/A	N/A
AC Power Source	APC	KDF-11010G	F214050035	N/A	N/A
DC Power Supply	Zhaoxin	RXN 605D	20R605D11010081	N/A	N/A
Test SW	EZ-EMC	Ver.STSLAB-03A1 RE			
Conduction Test equipment					
Kind of Equipment	Manufacturer	Type No.	Serial No.	Last calibration	Calibrated until
Test Receiver	R&S	ESCI	101427	2022.09.29	2023.09.28
LISN	R&S	ENV216	101242	2022.09.28	2023.09.27
LISN	EMCO	3810/2NM	23625	2022.09.28	2023.09.27
Temperature & Humidity	HH660	Mieo	N/A	2022.09.30	2023.09.29
Test SW	EZ-EMC	Ver.STSLAB-03A1 CE			
RF Connected Test					
Kind of Equipment	Manufacturer	Type No.	Serial No.	Last calibration	Calibrated until
Signal Analyzer	Agilent	N9020A	MY51510623	2023.03.01	2024.02.28
Switch control box	MW	MW100-RFCB	N/A	N/A	N/A
Temperature & Humidity	HH660	Mieo	N/A	2022.09.30	2023.09.29
Test SW	MW	MTS 8310_2.0.0.0			

3. EMC EMISSION TEST

3.1 CONDUCTED EMISSION MEASUREMENT

3.1.1 POWER LINE CONDUCTED EMISSION LIMITS

The radio frequency voltage that is conducted back onto the AC power line on any frequency or frequencies, within the band 150 kHz to 30 MHz, shall not exceed the limits in the following table.

FREQUENCY (MHz)	Conducted Emissionlimit (dBuV)	
	Quasi-peak	Average
0.15 -0.5	66 - 56 *	56 - 46 *
0.50 -5.0	56.00	46.00
5.0 -30.0	60.00	50.00

Note:

- (1) The tighter limit applies at the band edges.
- (2) The limit of “ * ” marked band means the limitation decreases linearly with the logarithm of the frequency in the range.

The following table is the setting of the receiver

Receiver Parameters	Setting
Attenuation	10 dB
Start Frequency	0.15 MHz
Stop Frequency	30 MHz
IF Bandwidth	9 kHz

3.1.2 TEST PROCEDURE

- a. The EUT is 0.8 m from the horizontal ground plane and 0.4 m from the vertical ground plane with EUT being connected to the power mains through a line impedance stabilization network (LISN). All other support equipments are powered from additional LISN(s). The LISN provides 50 Ohm/ 50uH of coupling impedance for the measuring instrument.
- b. Interconnecting cables that hang closer than 40 cm to the ground plane shall be folded back and forth in the center forming a bundle 30 to 40 cm long.
- c. I/O cables that are not connected to a peripheral shall be bundled in the center. The end of the cable may be terminated, if required, using the correct terminating impedance. The overall length shall not exceed 1 m.
- d. LISN is at least 80 cm from the nearest part of EUT chassis.
- e. For the actual test configuration, please refer to the related Item –EUT Test Photos.

3.1.3 TEST SETUP

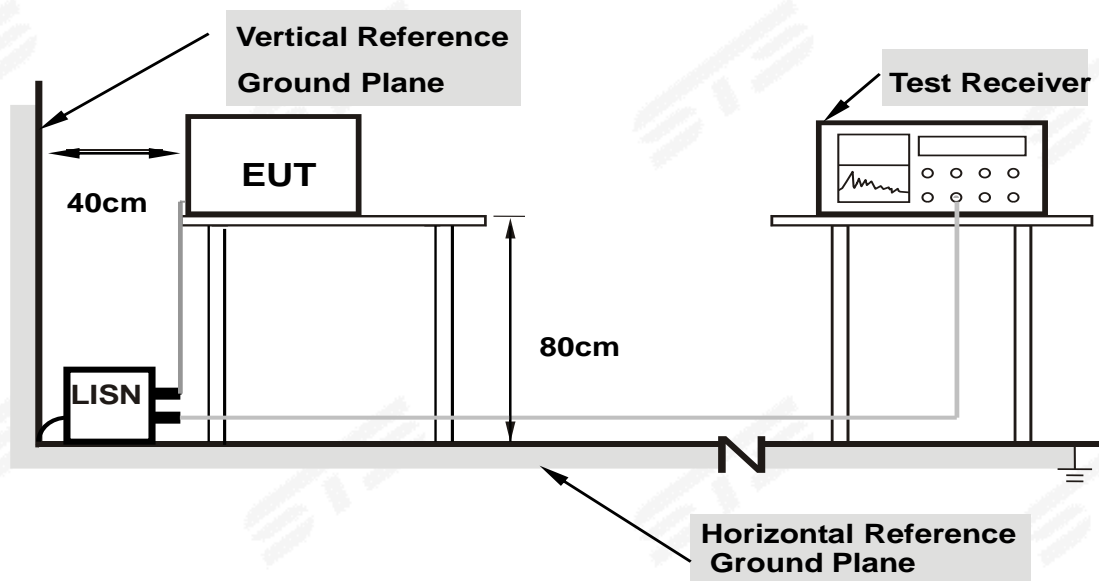

Note: 1. Support units were connected to second LISN.

2. Both of LISNs (AMN) are 80 cm from EUT and at least 80 cm from other units and other metal planes support units.

3.1.4 EUT OPERATING CONDITIONS

The EUT was configured for testing in a typical fashion (as a customer would normally use it). The EUT has been programmed to continuously transmit during test. This operating condition was tested and used to collect the included data.



3.1.5 TEST RESULT

Temperature:	26.1(C)	Relative Humidity:	55%RH
Test Voltage:	AC 120V/60Hz	Phase:	L
Test Mode:	Mode 13		

No.	Frequency (MHz)	Reading (dBuV)	Correct Factor(dB)	Result (dBuV)	Limit (dBuV)	Margin (dB)	Remark
1	0.2260	9.52	20.43	29.95	62.60	-32.65	QP
2	0.2260	-0.71	20.43	19.72	52.60	-32.88	AVG
3	0.4660	20.35	20.54	40.89	56.58	-15.69	QP
4	0.4660	-1.49	20.54	19.05	46.58	-27.53	AVG
5	0.8340	12.53	20.33	32.86	56.00	-23.14	QP
6	0.8340	-2.61	20.33	17.72	46.00	-28.28	AVG
7	1.1460	10.94	20.30	31.24	56.00	-24.76	QP
8	1.1460	-3.25	20.30	17.05	46.00	-28.95	AVG
9	1.9100	9.95	20.30	30.25	56.00	-25.75	QP
10	1.9100	-3.38	20.30	16.92	46.00	-29.08	AVG
11	7.3940	11.73	20.66	32.39	60.00	-27.61	QP
12	7.3940	-2.92	20.66	17.74	50.00	-32.26	AVG

Remark:

1. All readings are Quasi-Peak and Average values
2. Margin = Result (Result = Reading + Factor) – Limit
3. Factor=LISN factor+Cable loss+Limiter (10dB)

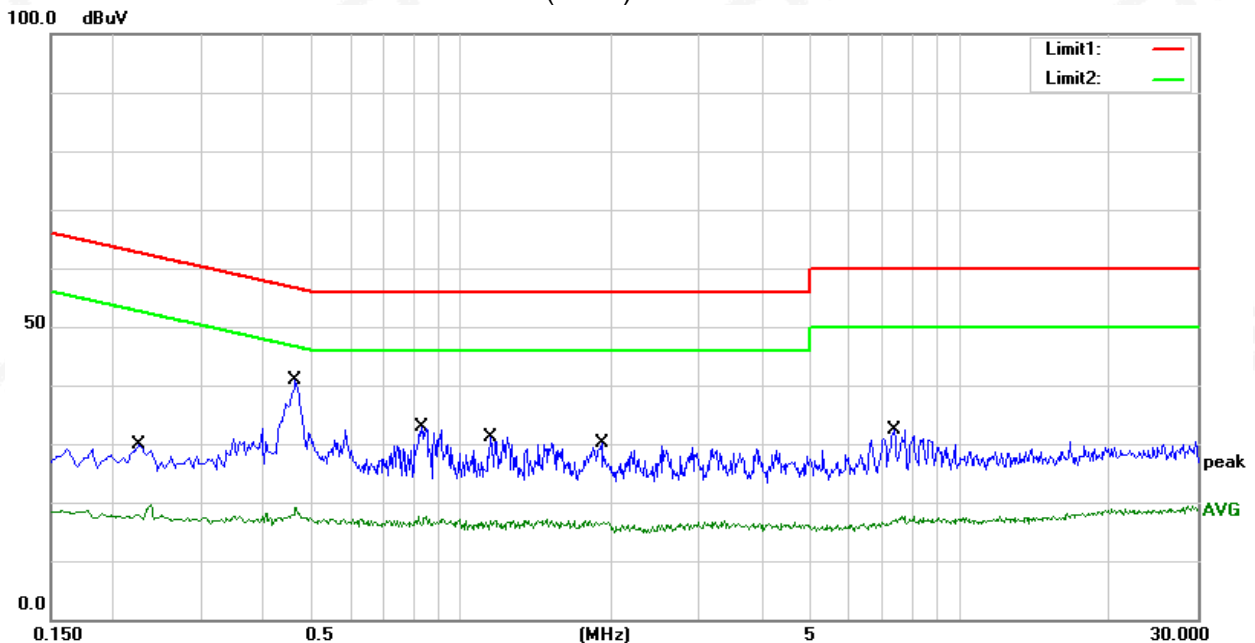



Temperature:	26.1(C)	Relative Humidity:	55%RH
Test Voltage:	AC 120V/60Hz	Phase:	N
Test Mode:	Mode 13		

No.	Frequency (MHz)	Reading (dBuV)	Correct Factor(dB)	Result (dBuV)	Limit (dBuV)	Margin (dB)	Remark
1	0.2500	8.26	20.53	28.79	61.76	-32.97	QP
2	0.2500	-1.45	20.53	19.08	51.76	-32.68	AVG
3	0.4700	16.80	20.54	37.34	56.51	-19.17	QP
4	0.4700	-2.19	20.54	18.35	46.51	-28.16	AVG
5	0.8220	9.10	20.33	29.43	56.00	-26.57	QP
6	0.8220	-3.13	20.33	17.20	46.00	-28.80	AVG
7	2.2420	9.08	20.31	29.39	56.00	-26.61	QP
8	2.2420	-3.29	20.31	17.02	46.00	-28.98	AVG
9	4.2540	8.90	20.41	29.31	56.00	-26.69	QP
10	4.2540	-3.20	20.41	17.21	46.00	-28.79	AVG
11	9.7700	7.33	21.16	28.49	60.00	-31.51	QP
12	9.7700	-3.86	21.16	17.30	50.00	-32.70	AVG

Remark:

1. All readings are Quasi-Peak and Average values
2. Margin = Result (Result =Reading + Factor)–Limit
3. Factor=LISN factor+Cable loss+Limiter (10dB)

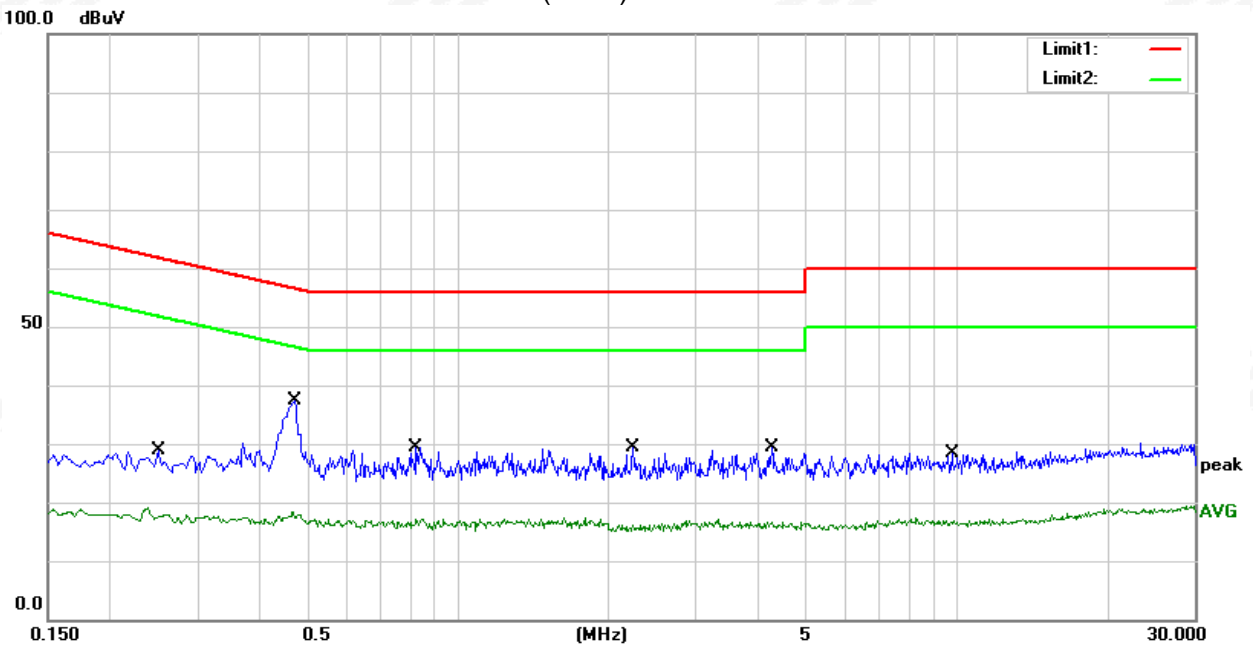

3.2 RADIATED EMISSION MEASUREMENT

3.2.1 RADIATED EMISSION LIMITS

In any 100 kHz bandwidth outside the operating frequency band. In case the emission fall within the Restricted band specified on Part15.205 (a)&209(a) limit in the table and according to ANSI C63.10-2013 below has to be followed.

LIMITS OF RADIATED EMISSION MEASUREMENT (0.009MHz - 1000MHz)

Frequencies (MHz)	Field Strength (microvolts/meter)	Measurement Distance (meters)
0.009~0.490	2400/F(KHz)	300
0.490~1.705	24000/F(KHz)	30
1.705~30.0	30	30
30~88	100	3
88~216	150	3
216~960	200	3
Above 960	500	3

LIMITS OF RADIATED EMISSION MEASUREMENT (1GHz-25 GHz)

FREQUENCY (MHz)	(dBuV/m) (at 3M)	
	PEAK	AVERAGE
Above 1000	74	54

Notes:

- (1) The limit for radiated test was performed according to FCC PART 15C.
- (2) The tighter limit applies at the band edges.
- (3) Emission level (dBuV/m)=20log Emission level (uV/m).

LIMITS OF RESTRICTED FREQUENCY BANDS

FREQUENCY (MHz)	FREQUENCY (MHz)	FREQUENCY (MHz)	FREQUENCY (GHz)
0.090-0.110	16.42-16.423	399.9-410	4.5-5.15
0.495-0.505	16.69475-16.69525	608-614	5.35-5.46
2.1735-2.1905	16.80425-16.80475	960-1240	7.25-7.75
4.125-4.128	25.5-25.67	1300-1427	8.025-8.5
4.17725-4.17775	37.5-38.25	1435-1626.5	9.0-9.2
4.20725-4.20775	73-74.6	1645.5-1646.5	9.3-9.5
6.215-6.218	74.8-75.2	1660-1710	10.6-12.7
6.26775-6.26825	108-121.94	1718.8-1722.2	13.25-13.4
6.31175-6.31225	123-138	2200-2300	14.47-14.5
8.291-8.294	149.9-150.05	2310-2390	15.35-16.2
8.362-8.366	156.52475-156.52525	2483.5-2500	17.7-21.4
8.37625-8.38675	156.7-156.9	2690-2900	22.01-23.12
8.41425-8.41475	162.0125-167.17	3260-3267	23.6-24.0
12.29-12.293	167.72-173.2	3332-3339	31.2-31.8
12.51975-12.52025	240-285	3345.8-3358	36.43-36.5
12.57675-12.57725	322-335.4	3600-4400	Above 38.6
13.36-13.41			



For Radiated Emission

Spectrum Parameter	Setting
Attenuation	Auto
Detector	Peak/QP/AV
Start Frequency	9 KHz/150KHz(Peak/QP/AV)
Stop Frequency	150KHz/30MHz(Peak/QP/AV)
RB / VB (emission in restricted band)	200Hz (From 9kHz to 0.15MHz)/ 9KHz (From 0.15MHz to 30MHz); 200Hz (From 9kHz to 0.15MHz)/ 9KHz (From 0.15MHz to 30MHz)

Spectrum Parameter	Setting
Attenuation	Auto
Detector	Peak/QP
Start Frequency	30 MHz(Peak/QP)
Stop Frequency	1000 MHz (Peak/QP)
RB / VB (emission in restricted band)	120 KHz / 300 KHz

Spectrum Parameter	Setting
Attenuation	Auto
Detector	Peak/AV
Start Frequency	1000 MHz(Peak/AV)
Stop Frequency	10th carrier hamonic(Peak/AV)
RB / VB (emission in restricted band)	1 MHz / 3 MHz(Peak) 1 MHz/1/T MHz(AVG)

For Restricted band

Spectrum Parameter	Setting
Detector	Peak/AV
Start/Stop Frequency	Lower Band Edge: 2310 to 2410 MHz Upper Band Edge: 2476 to 2500 MHz
RB / VB	1 MHz / 3 MHz(Peak) 1 MHz/1/T MHz(AVG)

Receiver Parameter	Setting
Attenuation	Auto
Start ~ Stop Frequency	9kHz~90kHz / RB 200Hz for PK & AV
Start ~ Stop Frequency	90kHz~110kHz / RB 200Hz for QP
Start ~ Stop Frequency	110kHz~490kHz / RB 200Hz for PK & AV
Start ~ Stop Frequency	490kHz~30MHz / RB 9kHz for QP
Start ~ Stop Frequency	30MHz~1000MHz / RB 120kHz for QP

3.2.2 TEST PROCEDURE

- a. The measuring distance at 3 m shall be used for measurements at frequency 0.009MHz up to 1GHz, and above 1GHz.
- b. The EUT was placed on the top of a rotating table 0.8 m (above 1GHz is 1.5 m) above the ground at a 3 m anechoic chamber test site. The table was rotated 360 degree to determine the position of the highest radiation.
- c. The height of the equipment shall be 0.8 m (above 1GHz is 1.5 m); the height of the test antenna shall vary between 1 m to 4 m. Horizontal and vertical polarization of the antenna are set to make the measurement.
- d. The initial step in collecting conducted emission data is a spectrum analyzer peak detector mode pre-scanning the measurement frequency range. Significant peaks are then marked and QuasiPeak detector mode will be re-measured.
- e. If the Peak Mode measured value is compliance with and lower than Quasi Peak Mode Limit, the EUT shall be deemed to meet QP Limits and no additional QP Mode measurement was performed.
- f. For the actual test configuration, please refer to the related Item –EUT Test Photos.

Note:

Both horizontal and vertical antenna polarities were tested and performed pretest to three orthogonal axis. The worst case emissions were reported.

3.2.3 DEVIATION FROM TEST STANDARD

No deviation.

3.2.4 TESTSETUP

(A) Radiated Emission Test-Up Frequency Below 30MHz

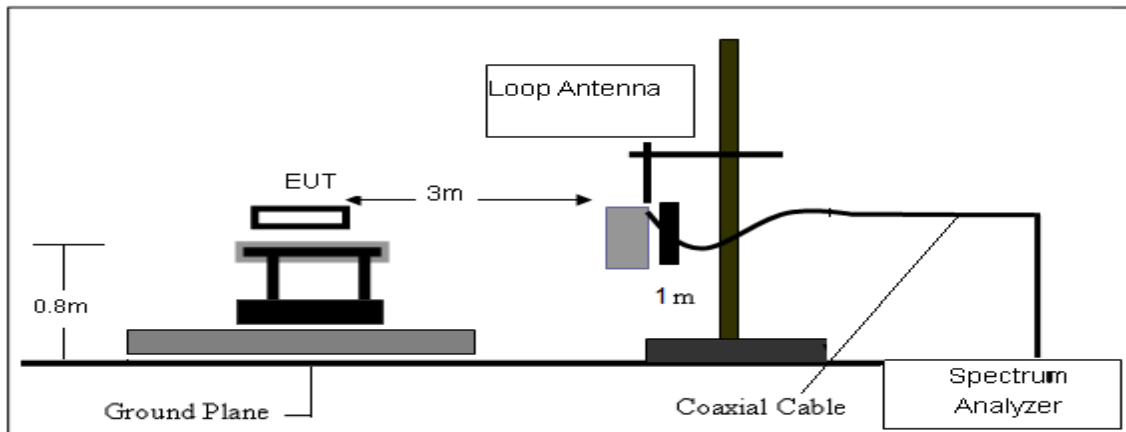

(B) Radiated Emission Test-Up Frequency 30MHz~1GHz

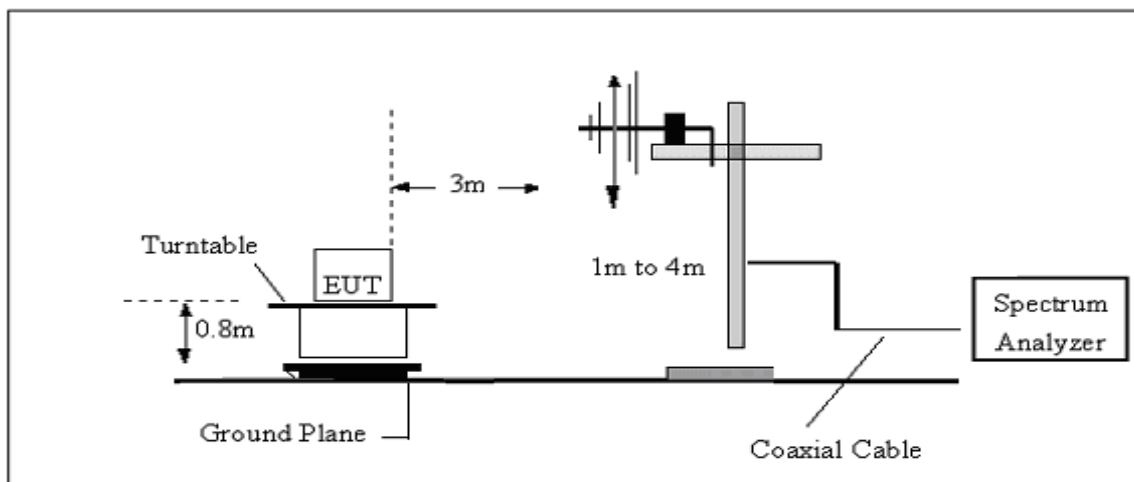

(C) Radiated Emission Test-Up Frequency Above 1GHz

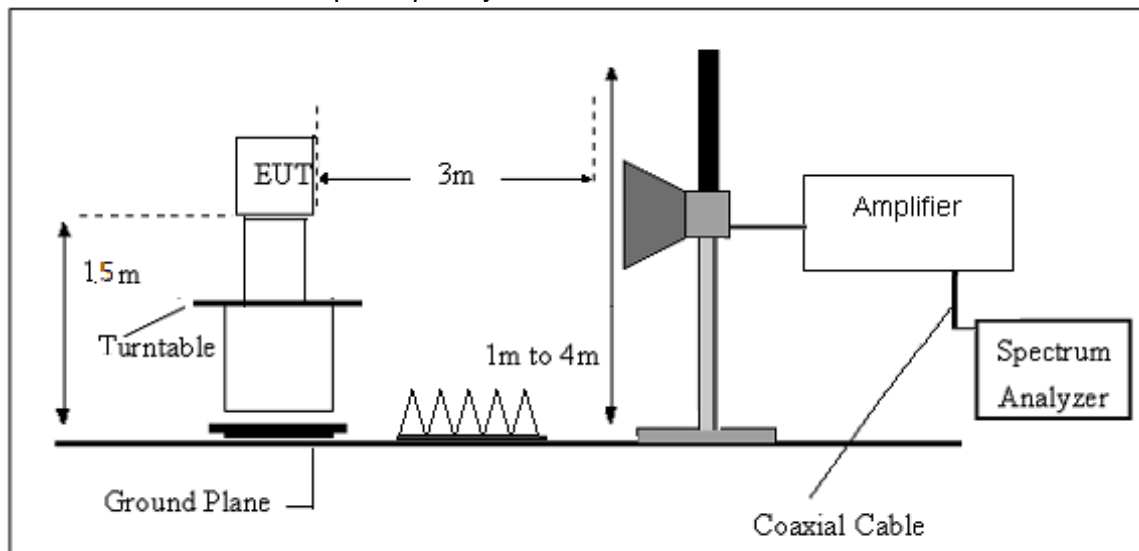

3.2.5 EUT OPERATING CONDITIONS

Please refer to section 3.1.4 of this report.



3.2.6 FIELD STRENGTH CALCULATION

The field strength is calculated by adding the Antenna Factor and Cable Factor and subtracting the Amplifier Gain and Duty Cycle Correction Factor (if any) from the measured reading. The basic equation with a sample calculation is as follows:

$$FS = RA + AF + CL - AG$$

Where

FS = Field Strength

CL = Cable Attenuation Factor (Cable Loss)

RA = Reading Amplitude

AG = Amplifier Gain

AF = Antenna Factor

For example

Frequency (MHz)	FS (dB μ V/m)	RA (dB μ V/m)	AF (dB)	CL (dB)	AG (dB)	Factor (dB)
300	40	58.1	12.2	1.6	31.9	-18.1

$$\text{Factor} = \text{AF} + \text{CL} - \text{AG}$$



3.2.7 TEST RESULTS

(9KHz-30MHz)

Temperature:	23.1(C)	Relative Humidity:	60%RH
Test Voltage:	DC 3.7V	Test Mode:	TX Mode

Freq. (MHz)	Reading (dBuV/m)	Limit (dBuV/m)	Margin (dB)	State P/F	Test Result
--	--	--	--	--	PASS
--	--	--	--	--	PASS

Note:

The amplitude of spurious emissions which are attenuated by more than 20dB below the permissible value has no need to be reported.

Distance extrapolation factor = $40 \log(\text{specific distance}/\text{test distance})$ (dB);

Limit line = specific limits (dBuV) + distance extrapolation factor.



(30MHz-1000MHz)

Temperature:	23.1(C)	Relative Humidity:	60%RH
Test Voltage:	DC 3.7V	Phase:	Horizontal
Test Mode:	Mode 1/2/3/4/5/6/7/8/9(Mode 8 worst mode)		

No.	Frequency (MHz)	Reading (dBUV)	Correct Factor(dB/m)	Result (dBUV/m)	Limit (dBUV/m)	Margin (dB)	Remark
1	83.3500	51.14	-22.52	28.62	40.00	-11.38	peak
2	155.1300	52.86	-18.63	34.23	43.50	-9.27	peak
3	199.7500	58.34	-21.11	37.23	43.50	-6.27	peak
4	399.5700	45.93	-11.16	34.77	46.00	-11.23	peak
5	531.4900	41.60	-7.37	34.23	46.00	-11.77	peak
6	898.1500	38.36	-0.49	37.87	46.00	-8.13	peak

Remark:

- 1. Margin = Result (Result =Reading + Factor)-Limit
- 2. Factor= Antenna factor+Cable attenuation factor(cable loss)-Amplifier gain

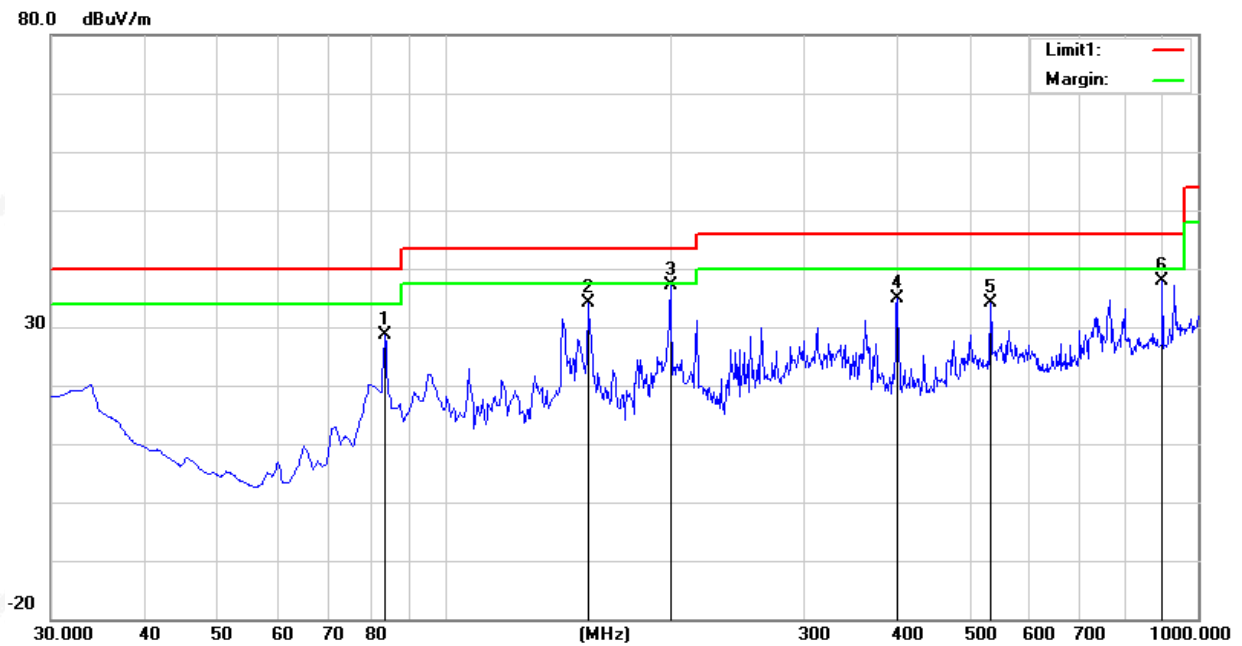



Temperature:	23.1(C)	Relative Humidity:	60%RH
Test Voltage:	DC 3.7V	Phase:	Vertical
Test Mode:	Mode 1/2/3/4/5/6/7/8/9(Mode 8 worst mode)		

No.	Frequency (MHz)	Reading (dBuV)	Correct Factor(dB/m)	Result (dBuV/m)	Limit (dBuV/m)	Margin (dB)	Remark
1	33.8800	47.89	-14.80	33.09	40.00	-6.91	peak
2	199.7500	57.87	-21.11	36.76	43.50	-6.74	peak
3	242.5253	44.92	-17.50	27.42	46.00	-18.58	peak
4	399.5700	39.63	-11.16	28.47	46.00	-17.53	peak
5	731.3100	37.33	-2.42	34.91	46.00	-11.09	peak
6	898.1500	33.15	-0.49	32.66	46.00	-13.34	peak

Remark:

- 1. Margin = Result (Result =Reading + Factor)-Limit
- 2. Factor= Antenna factor+Cable attenuation factor(cable loss)-Amplifier gain

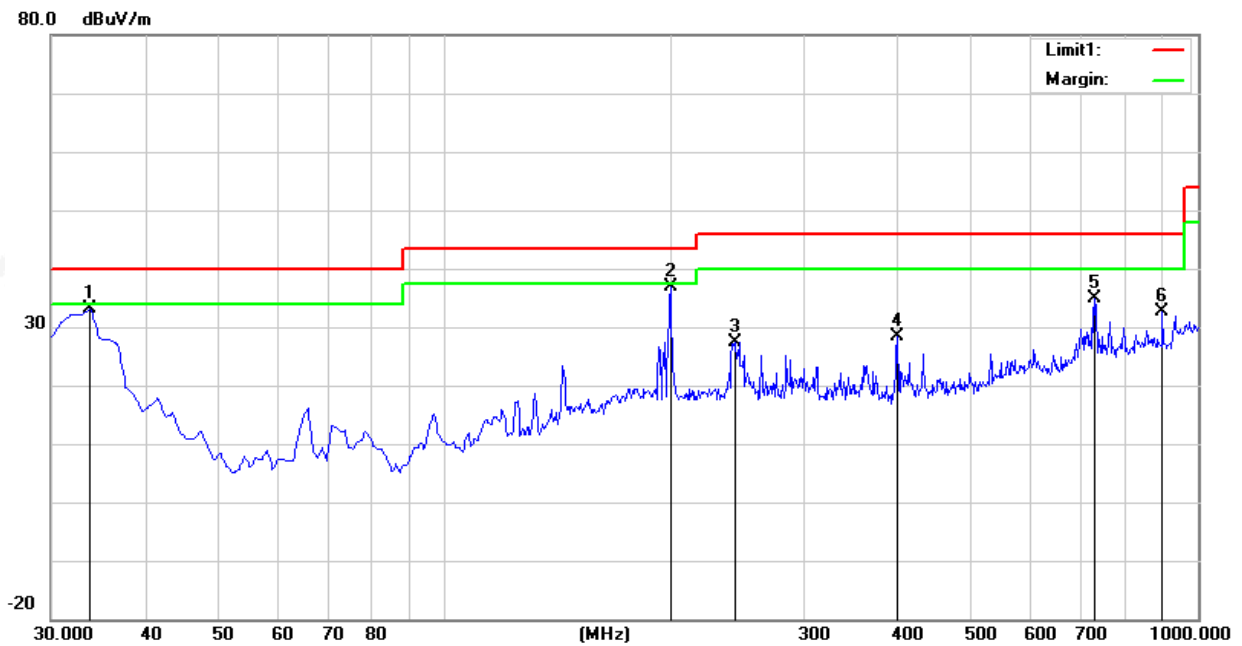



(1GHz~25GHz) Spurious emission Requirements

Frequency	Meter Reading	Amplifier	Loss	Antenna Factor	Corrected Factor	Emission Level	Limits	Margin	Detector	Comment
(MHz)	(dBμV)	(dB)	(dB)	(dB/m)	(dB)	(dBμV/m)	(dBμV/m)	(dB)	Type	
Low Channel (8DPSK/2402 MHz)										
3264.83	60.90	44.70	6.70	28.20	-9.80	51.10	74.00	-22.90	PK	Vertical
3264.83	50.06	44.70	6.70	28.20	-9.80	40.26	54.00	-13.74	AV	Vertical
3264.77	61.70	44.70	6.70	28.20	-9.80	51.90	74.00	-22.10	PK	Horizontal
3264.77	51.06	44.70	6.70	28.20	-9.80	41.26	54.00	-12.74	AV	Horizontal
4804.53	58.26	44.20	9.04	31.60	-3.56	54.70	74.00	-19.30	PK	Vertical
4804.53	49.81	44.20	9.04	31.60	-3.56	46.25	54.00	-7.75	AV	Vertical
4804.38	59.23	44.20	9.04	31.60	-3.56	55.67	74.00	-18.33	PK	Horizontal
4804.38	49.72	44.20	9.04	31.60	-3.56	46.16	54.00	-7.84	AV	Horizontal
5359.78	48.54	44.20	9.86	32.00	-2.34	46.19	74.00	-27.81	PK	Vertical
5359.78	40.30	44.20	9.86	32.00	-2.34	37.96	54.00	-16.04	AV	Vertical
5359.68	48.18	44.20	9.86	32.00	-2.34	45.84	74.00	-28.16	PK	Horizontal
5359.68	39.29	44.20	9.86	32.00	-2.34	36.94	54.00	-17.06	AV	Horizontal
7205.98	54.53	43.50	11.40	35.50	3.40	57.93	74.00	-16.07	PK	Vertical
7205.98	44.61	43.50	11.40	35.50	3.40	48.01	54.00	-5.99	AV	Vertical
7205.70	53.63	43.50	11.40	35.50	3.40	57.03	74.00	-16.97	PK	Horizontal
7205.70	44.91	43.50	11.40	35.50	3.40	48.31	54.00	-5.69	AV	Horizontal
Middle Channel (8DPSK/2441 MHz)										
3264.62	60.98	44.70	6.70	28.20	-9.80	51.18	74.00	-22.82	PK	Vertical
3264.62	50.11	44.70	6.70	28.20	-9.80	40.31	54.00	-13.69	AV	Vertical
3264.58	60.90	44.70	6.70	28.20	-9.80	51.10	74.00	-22.90	PK	Horizontal
3264.58	50.34	44.70	6.70	28.20	-9.80	40.54	54.00	-13.46	AV	Horizontal
4882.42	59.18	44.20	9.04	31.60	-3.56	55.62	74.00	-18.38	PK	Vertical
4882.42	49.16	44.20	9.04	31.60	-3.56	45.60	54.00	-8.40	AV	Vertical
4882.38	58.15	44.20	9.04	31.60	-3.56	54.59	74.00	-19.41	PK	Horizontal
4882.38	50.20	44.20	9.04	31.60	-3.56	46.64	54.00	-7.36	AV	Horizontal
5359.85	48.44	44.20	9.86	32.00	-2.34	46.10	74.00	-27.90	PK	Vertical
5359.85	39.97	44.20	9.86	32.00	-2.34	37.63	54.00	-16.37	AV	Vertical
5359.66	47.24	44.20	9.86	32.00	-2.34	44.89	74.00	-29.11	PK	Horizontal
5359.66	39.40	44.20	9.86	32.00	-2.34	37.05	54.00	-16.95	AV	Horizontal
7323.90	54.00	43.50	11.40	35.50	3.40	57.40	74.00	-16.60	PK	Vertical
7323.90	44.07	43.50	11.40	35.50	3.40	47.47	54.00	-6.53	AV	Vertical
7323.69	54.72	43.50	11.40	35.50	3.40	58.12	74.00	-15.88	PK	Horizontal
7323.69	43.63	43.50	11.40	35.50	3.40	47.03	54.00	-6.97	AV	Horizontal



High Channel (8DPSK/2480 MHz)										
3264.70	60.86	44.70	6.70	28.20	-9.80	51.06	74.00	-22.94	PK	Vertical
3264.70	49.93	44.70	6.70	28.20	-9.80	40.13	54.00	-13.87	AV	Vertical
3264.62	62.13	44.70	6.70	28.20	-9.80	52.33	74.00	-21.67	PK	Horizontal
3264.62	51.30	44.70	6.70	28.20	-9.80	41.50	54.00	-12.50	AV	Horizontal
4960.50	58.19	44.20	9.04	31.60	-3.56	54.63	74.00	-19.37	PK	Vertical
4960.50	49.63	44.20	9.04	31.60	-3.56	46.07	54.00	-7.93	AV	Vertical
4960.51	59.52	44.20	9.04	31.60	-3.56	55.96	74.00	-18.04	PK	Horizontal
4960.51	49.61	44.20	9.04	31.60	-3.56	46.05	54.00	-7.95	AV	Horizontal
5359.72	49.19	44.20	9.86	32.00	-2.34	46.85	74.00	-27.15	PK	Vertical
5359.72	40.04	44.20	9.86	32.00	-2.34	37.69	54.00	-16.31	AV	Vertical
5359.85	47.41	44.20	9.86	32.00	-2.34	45.06	74.00	-28.94	PK	Horizontal
5359.85	39.33	44.20	9.86	32.00	-2.34	36.99	54.00	-17.01	AV	Horizontal
7439.89	54.67	43.50	11.40	35.50	3.40	58.07	74.00	-15.93	PK	Vertical
7439.89	44.85	43.50	11.40	35.50	3.40	48.25	54.00	-5.75	AV	Vertical
7439.86	54.21	43.50	11.40	35.50	3.40	57.61	74.00	-16.39	PK	Horizontal
7439.86	43.85	43.50	11.40	35.50	3.40	47.25	54.00	-6.75	AV	Horizontal

Note:

- 1) Scan with GFSK, $\pi/4$ -DQPSK, 8DPSK, the worst case is GFSK Mode.
- 2) Factor = Antenna Factor + Cable Loss – Pre-amplifier.
Emission Level = Reading + Factor
- 3) The frequency emission of peak points that did not show above the forms are at least 20dB below the limit, the frequency emission is mainly from the environment noise.



Restricted band Requirements

GFSK-Low
Horizontal

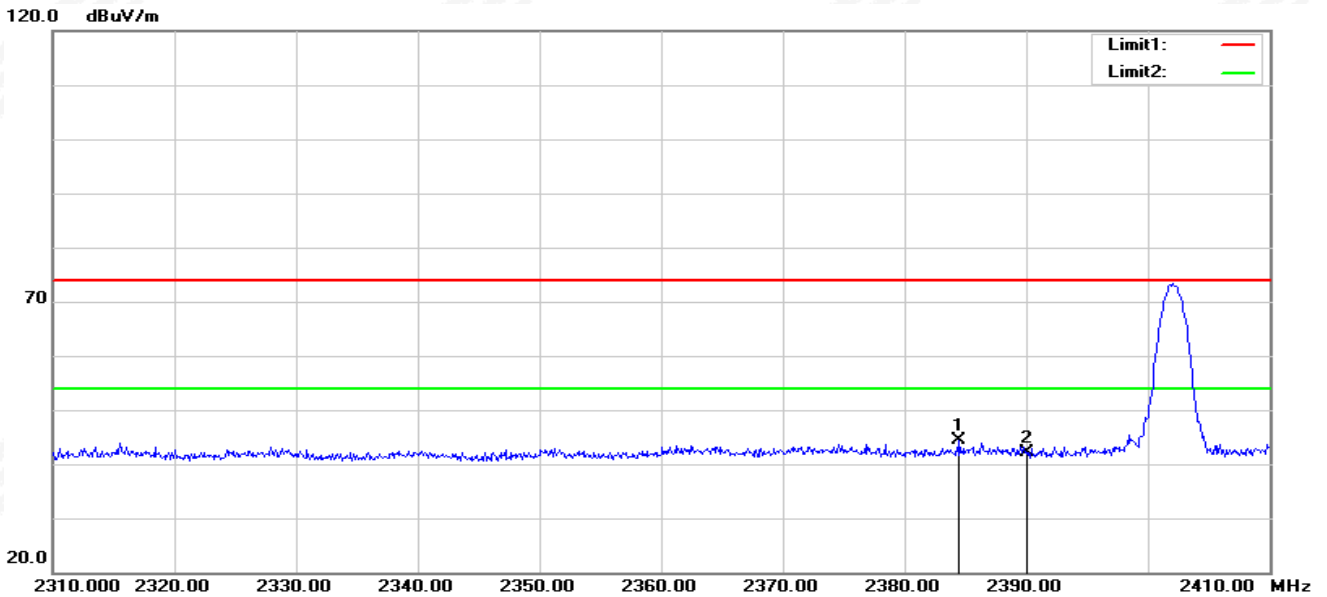

No.	Frequency (MHz)	Reading (dBuV)	Correct Factor(dB/m)	Result (dBuV/m)	Limit (dBuV/m)	Margin (dB)	Remark
1	2384.500	40.01	4.26	44.27	74.00	-29.73	peak
2	2390.000	37.77	4.34	42.11	74.00	-31.89	peak

Vertical

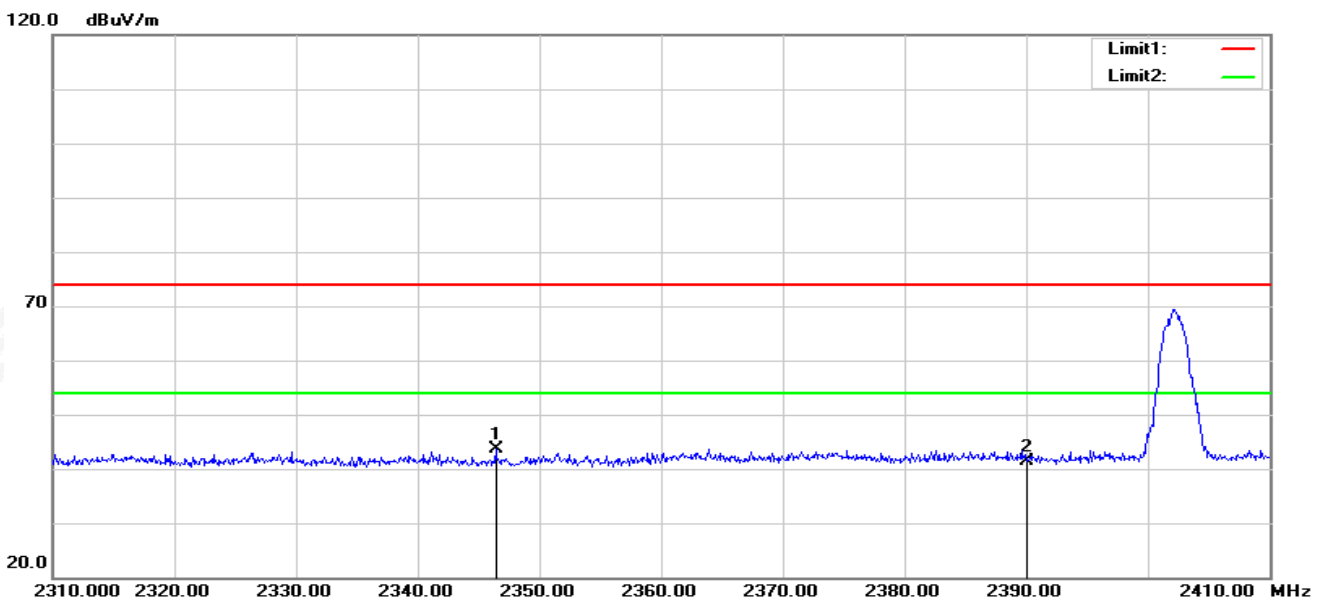

No.	Frequency (MHz)	Reading (dBuV)	Correct Factor(dB/m)	Result (dBuV/m)	Limit (dBuV/m)	Margin (dB)	Remark
1	2346.400	39.89	3.72	43.61	74.00	-30.39	peak
2	2390.000	36.96	4.34	41.30	74.00	-32.70	peak

GFSK-High
Horizontal

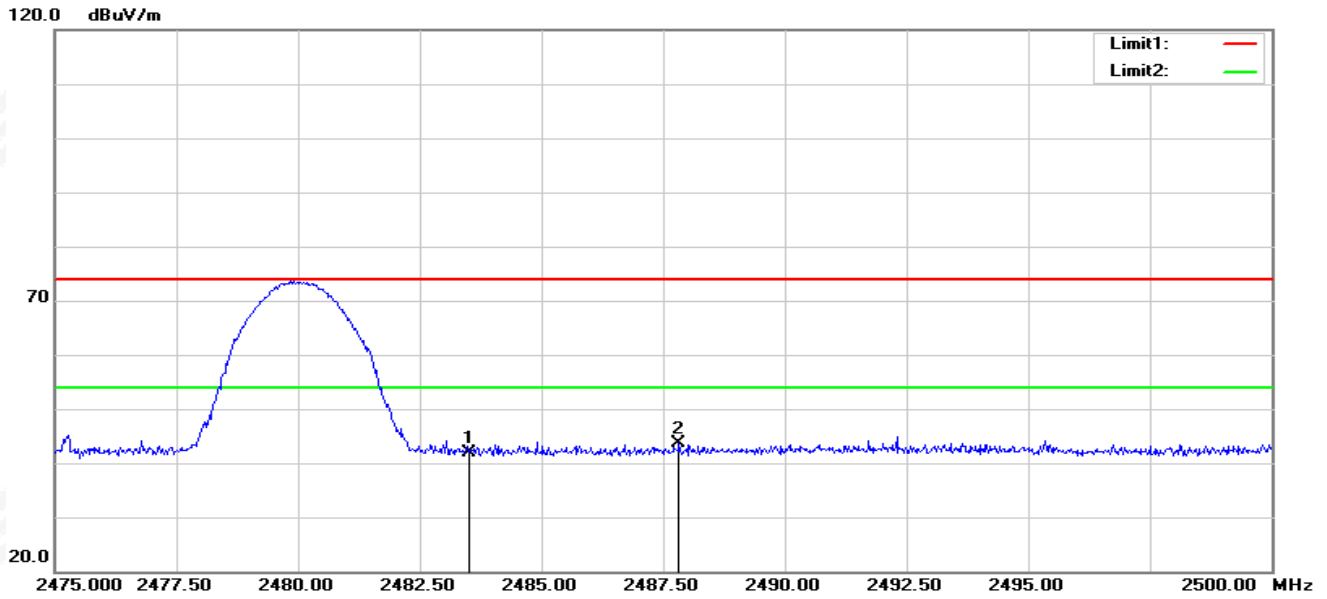

No.	Frequency (MHz)	Reading (dBuV)	Correct Factor(dB/m)	Result (dBuV/m)	Limit (dBuV/m)	Margin (dB)	Remark
1	2483.500	37.37	4.60	41.97	74.00	-32.03	peak
2	2487.825	39.08	4.62	43.70	74.00	-30.30	peak

Vertical

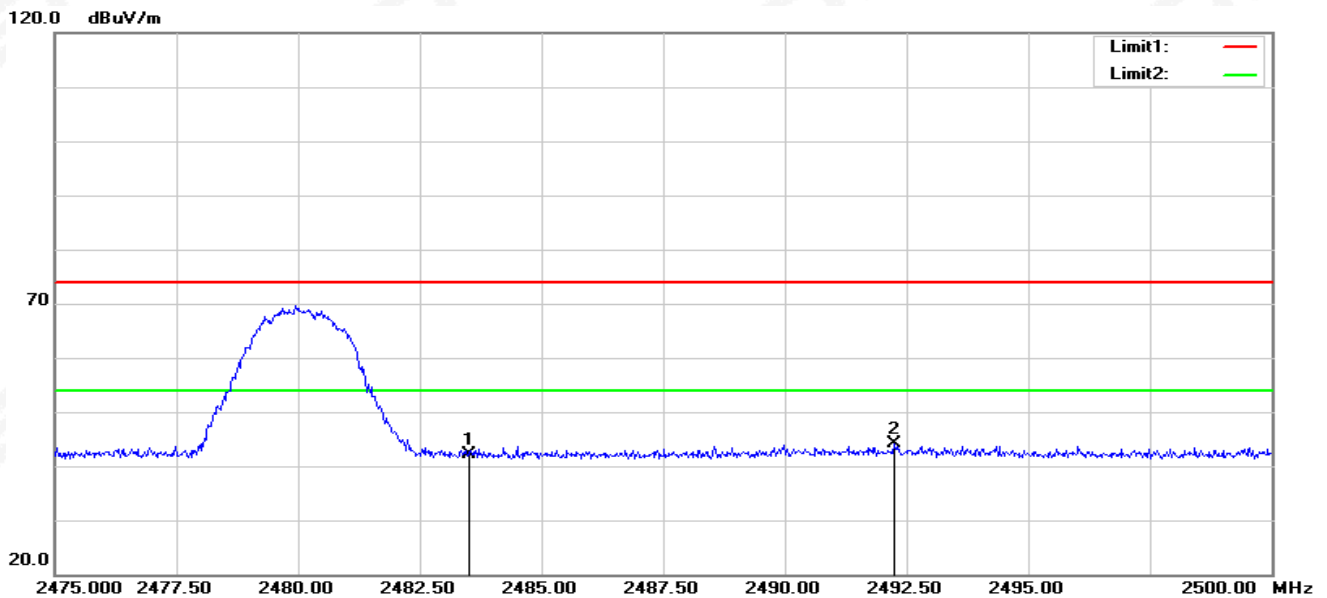

No.	Frequency (MHz)	Reading (dBuV)	Correct Factor(dB/m)	Result (dBuV/m)	Limit (dBuV/m)	Margin (dB)	Remark
1	2483.500	37.48	4.60	42.08	74.00	-31.92	peak
2	2492.250	39.49	4.63	44.12	74.00	-29.88	peak

Note: GFSK, $\pi/4$ -DQPSK, 8DPSK of the nohopping and hopping mode all have been test, the worst case is GFSK of the nohopping mode, this report only show the worst case.

4. CONDUCTED SPURIOUS & BAND EDGE EMISSION

4.1 LIMIT

According to FCC section 15.247(d), in any 100kHz bandwidth outside the frequency band in which the spread spectrum or digitally modulated intentional radiator is operating, the radio frequency power that is produced by the intentional radiator shall be at least 20dB below that in the 100kHz bandwidth within the band that contains the highest level of the desired power, based on either an RF conducted or a radiated measurement.

4.2 TEST PROCEDURE

Spectrum Parameter	Setting
Detector	Peak
Start/Stop Frequency	30 MHz to 10th carrier harmonic
RB / VB (emission in restricted band)	100 KHz/300 KHz
Trace-Mode:	Max hold

For Band edge

Spectrum Parameter	Setting
Detector	Peak
Start/Stop Frequency	Lower Band Edge: 2300 – 2407 MHz Upper Band Edge: 2475 – 2500 MHz
RB / VB (emission in restricted band)	100 KHz/300 KHz
Trace-Mode:	Max hold

For Hopping Band edge

Spectrum Parameter	Setting
Detector	Peak
Start/Stop Frequency	Lower Band Edge: 2300– 2403 MHz Upper Band Edge: 2479 – 2500 MHz
RB / VB (emission in restricted band)	100 KHz/300 KHz
Trace-Mode:	Max hold

4.3 TEST SETUP



The EUT is connected to the Spectrum Analyzer; the RF load attached to the EUT antenna terminal is 50Ohm; the path loss as the factor is calibrated to correct the reading. Tune the measurement with the spectrum analyzer's resolution bandwidth (RBW) = 100 kHz. In order to make an accurate measurement, the span is set to be greater than RBW.

4.4 EUT OPERATION CONDITIONS

Please refer to section 3.1.4 of this report.

4.5 TEST RESULTS

Note: The test data please refer to APPENDIX 1.

5. NUMBER OF HOPPING CHANNEL

5.1 LIMIT

FCC Part 15.247, Subpart C				
Section	Test Item	Limit	FrequencyRange (MHz)	Result
15.247 (a)(1)(iii)	Number of Hopping Channel	≥15	2400-2483.5	PASS

Spectrum Parameters	Setting
Attenuation	Auto
Span Frequency	> Operating FrequencyRange
RB	100KHz
VB	300KHz
Detector	Peak
Trace	Max Hold
Sweep Time	Auto

5.2 TEST PROCEDURE

- a. The EUT was directly connected to the spectrum analyzer and antenna output port as show in the block diagram below.
- b. Spectrum Setting: RBW= 100KHz, VBW=300KHz, Sweep time = Auto.

5.3 TEST SETUP



5.4 EUT OPERATION CONDITIONS

Please refer to section 3.1.4 of this report.

5.5 TEST RESULTS

Note: The test data please refer to APPENDIX 1.

6. AVERAGE TIME OF OCCUPANCY

6.1 LIMIT

FCC Part 15.247, Subpart C				
Section	Test Item	Limit	Frequency Range (MHz)	Result
15.247 (a)(1)(iii)	Average Time of Occupancy	0.4sec	2400-2483.5	PASS

6.2 TEST PROCEDURE

- a. The transmitter output (antenna port) was connected to the spectrum analyzer.
- b. Set RBW = 1MHz/VBW = 3MHz.
- c. Use a video trigger with the trigger level set to enable triggering only on full pulses.
- d. Sweep Time is more than once pulse time.
- e. Set the center frequency on any frequency would be measure and set the frequency span to zero span.
- f. Measure the maximum time duration of one single pulse.
- g. Set the EUT for DH5, DH3 and DH1 packet transmitting.
- h. Measure the maximum time duration of one single pulse.
- i. DH5 Packet permit maximum $1600 / 79 / 6 = 3.37$ hops per second in each channel (5 time slots RX, 1 time slot TX). So the number of pulses in the observation period of 31.6 seconds is $3.37 \times 31.6 = 106.6$.
- j. DH3 Packet permit maximum $1600 / 79 / 4 = 5.06$ hops per second in each channel (3 time slots RX, 1 time slot TX). So the number of pulses in the observation period of 31.6 seconds is $5.06 \times 31.6 = 160$.
- k. DH1 Packet permit maximum $1600 / 79 / 2 = 10.12$ hops per second in each channel (1 time slot RX, 1 time slot TX). So the number of pulses in the observation period of 31.6 seconds is $10.12 \times 31.6 = 320$.

6.3 TEST SETUP

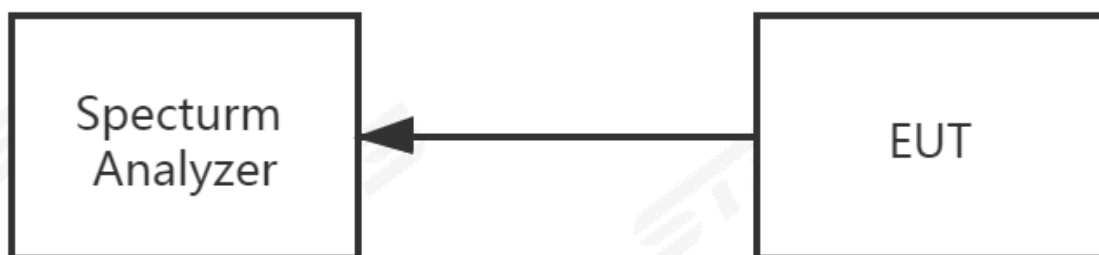

6.4 EUT OPERATION CONDITIONS

Please refer to section 3.1.4 of this report.

6.5 TEST RESULTS

Note: The test data please refer to APPENDIX 1.

7. HOPPING CHANNEL SEPARATION MEASUREMENT

7.1 LIMIT

Frequency hopping systems shall have hopping channel carrier frequencies separated by a minimum of 25 kHz or the 20 dB bandwidth of the hopping channel, whichever is greater. Alternatively, frequency hopping systems operating in the 2400-2483.5 MHz band may have hopping channel carrier frequencies that are separated by 25 kHz or two-thirds of the 20 dB bandwidth of the hopping channel, whichever is greater, provided the systems operate with an output power no greater than 125 mW.

Spectrum Parameter	Setting
Attenuation	Auto
Span Frequency	> 20 dB Bandwidth or Channel Separation
RB	30 kHz (20dB Bandwidth) / 30 kHz (Channel Separation)
VB	100 kHz (20dB Bandwidth) / 100 kHz (Channel Separation)
Detector	Peak
Trace	Max Hold
Sweep Time	Auto

7.2 TEST PROCEDURE

- a. The transmitter output (antenna port) was connected to the spectrum analyser in peak hold mode.
- b. The resolution bandwidth of 30 kHz and the video bandwidth of 100 kHz were utilised for 20 dB bandwidth measurement.
- c. The resolution bandwidth of 30 kHz and the video bandwidth of 100 kHz were utilised for channel separation measurement.

7.3 TEST SETUP



7.4 EUT OPERATION CONDITIONS

The EUT was programmed to be in continuously transmitting mode.

7.5 TEST RESULTS

Note: The test data please refer to APPENDIX 1.

8. BANDWIDTH TEST

8.1 LIMIT

FCC Part15 15.247,Subpart C				
Section	Test Item	Limit	FrequencyRange (MHz)	Result
15.247 (a)(1)	Bandwidth	N/A	2400-2483.5	PASS

Spectrum Parameter	Setting
Attenuation	Auto
Span Frequency	> Measurement Bandwidth or Channel Separation
RB	30 kHz (20dB Bandwidth) / 30 kHz (Channel Separation)
VB	100 kHz (20dB Bandwidth) / 100 kHz (Channel Separation)
Detector	Peak
Trace	Max Hold
Sweep Time	Auto

8.2 TEST PROCEDURE

- a. The EUT was directly connected to the spectrum analyzer and antenna output port as show in the block diagram below.
- b. Spectrum Setting: RBW= 30KHz, VBW=100KHz, Sweep time = Auto.

8.3 TEST SETUP



8.4 EUT OPERATION CONDITIONS

Please refer to section 3.1.4 of this report.

8.5 TEST RESULTS

Note: The test data please refer to APPENDIX 1.

9. OUTPUT POWER TEST

9.1 LIMIT

FCC Part 15.247, Subpart C				
Section	Test Item	Limit	Frequency Range (MHz)	Result
15.247 (a)(1)&(b)(1)	Output Power	1 W or 0.125W	2400-2483.5	PASS
		if channel separation > 2/3 bandwidth provided the systems operate with an output power no greater than 125 mW (20.97 dBm)		

9.2 TEST PROCEDURE

This is an RF-conducted test to evaluate maximum peak output power. Use a direct connection between the antenna port of the unlicensed wireless device and the spectrum analyzer, through suitable attenuation. The hopping shall be disabled for this test:

a) Use the following spectrum analyzer settings:

- 1) Span: Approximately five times the 20 dB bandwidth, centered on a hopping channel.
- 2) RBW > 20 dB bandwidth of the emission being measured.
- 3) VBW ≥ RBW.
- 4) Sweep: Auto.
- 5) Detector function: Peak.
- 6) Trace: Max hold.

b) Allow trace to stabilize.

c) Use the marker-to-peak function to set the marker to the peak of the emission.

d) The indicated level is the peak output power, after any corrections for external attenuators and cables.

e) A plot of the test results and setup description shall be included in the test report.

NOTE—A peak responding power meter may be used, where the power meter and sensor system video bandwidth is greater than the occupied bandwidth of the unlicensed wireless device, rather than a spectrum analyzer.

PKPM1 Peak power meter method:

The maximum peak conducted output power may be measured using a broadband peak RF power meter. The power meter shall have a video bandwidth that is greater than or equal to the DSS bandwidth and shall use a fast-responding diode detector.

9.3 TEST SETUP



9.4 EUT OPERATION CONDITIONS

Please refer to section 3.1.4 of this report.

9.5 TEST RESULTS

Note: The test data please refer to APPENDIX 1.



10. ANTENNA REQUIREMENT

10.1 STANDARD REQUIREMENT

15.203 requirement: For intentional device, according to 15.203: an intentional radiator shall be designed to ensure that no antenna other than that furnished by the responsible party shall be used with the device.

10.2 EUT ANTENNA

The EUT antenna is Ceramic Antenna. It comply with the standard requirement.



APPENDIX 1-TEST DATA

1. Maximum Average Conducted Output Power

Condition	Mode	Frequency (MHz)	Conducted Power (dBm)	Limit (dBm)	Verdict
NVNT	1-DH5	2402	-1.55	≤ 20.97	Pass
NVNT	1-DH5	2441	-0.15	≤ 20.97	Pass
NVNT	1-DH5	2480	-0.3	≤ 20.97	Pass
NVNT	2-DH5	2402	-1.72	≤ 20.97	Pass
NVNT	2-DH5	2441	-0.37	≤ 20.97	Pass
NVNT	2-DH5	2480	-0.37	≤ 20.97	Pass
NVNT	3-DH5	2402	-1.64	≤ 20.97	Pass
NVNT	3-DH5	2441	-0.26	≤ 20.97	Pass
NVNT	3-DH5	2480	-0.38	≤ 20.97	Pass



Test Graphs Average Power NVNT 1-DH5 2402MHz



Average Power NVNT 1-DH5 2441MHz





Average Power NVNT 1-DH5 2480MHz

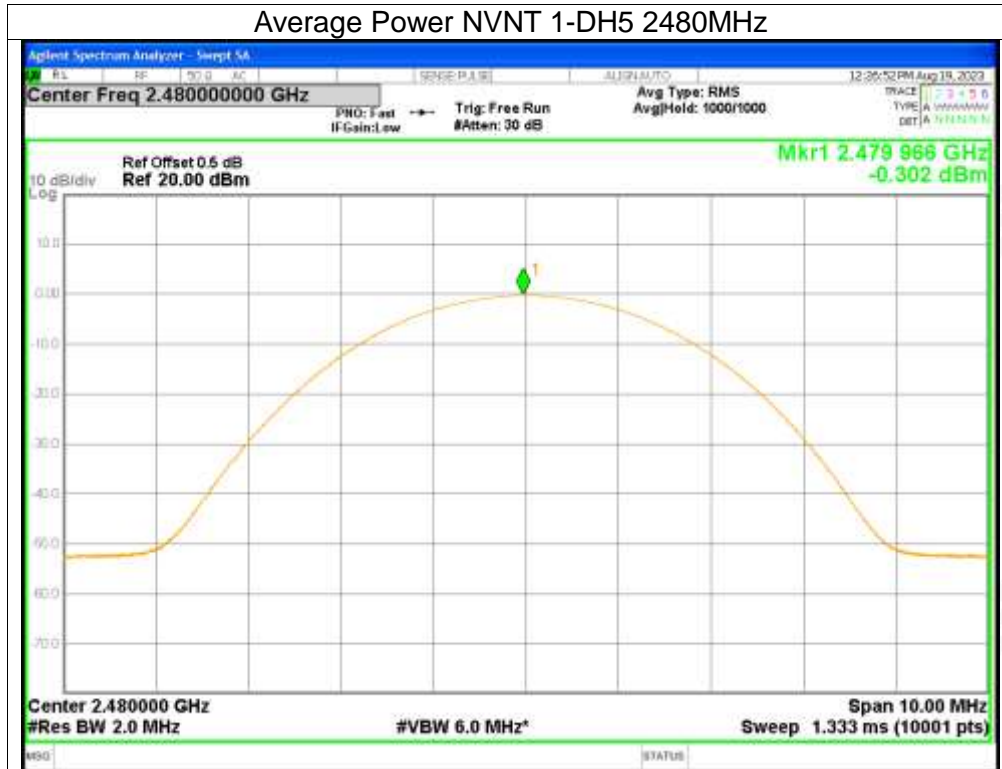

Average Power NVNT 2-DH5 2402MHz





Average Power NVNT 2-DH5 2441MHz

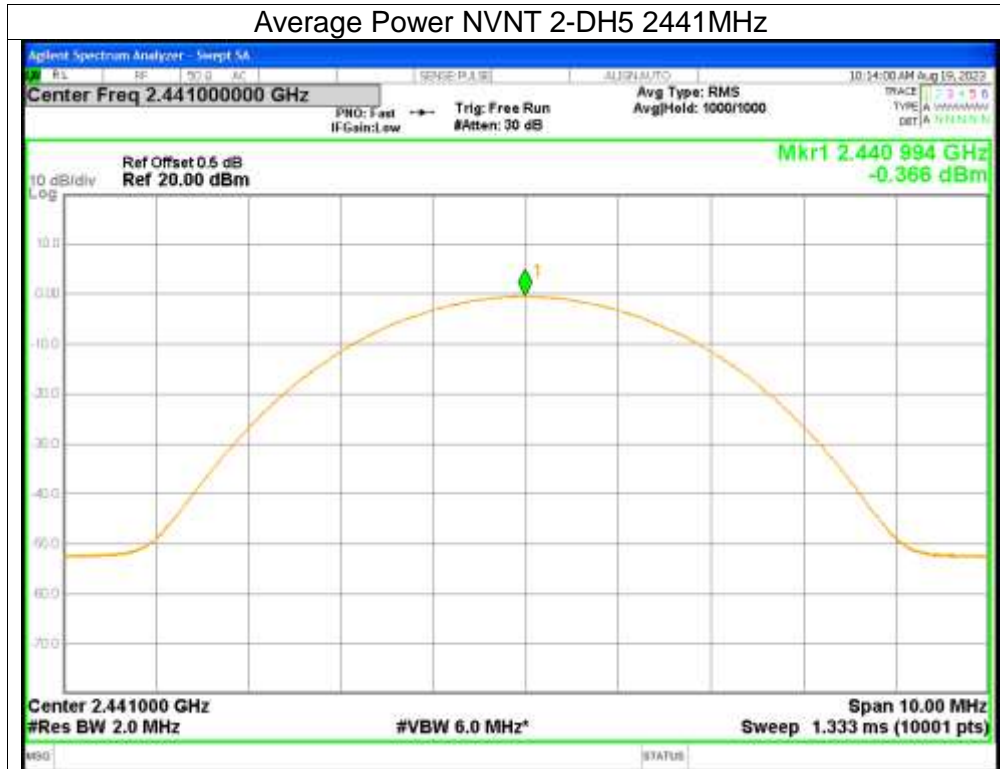

Average Power NVNT 2-DH5 2480MHz





Average Power NVNT 3-DH5 2402MHz

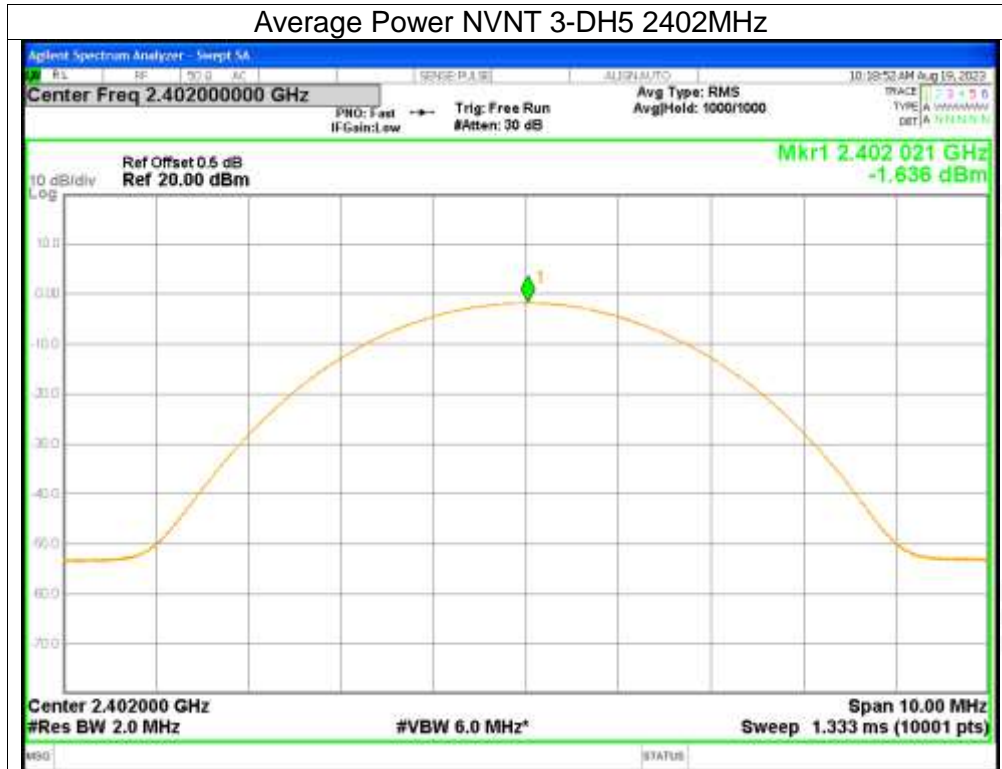

Average Power NVNT 3-DH5 2441MHz



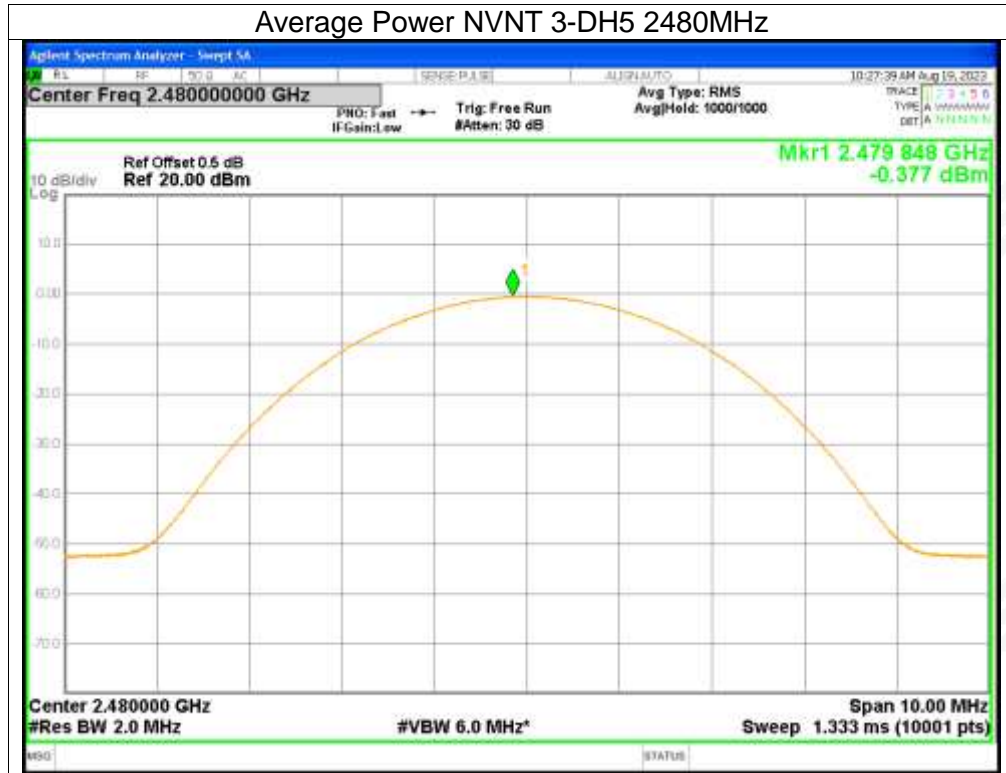



2. Maximum Peak Conducted Output Power

Condition	Mode	Frequency (MHz)	Conducted Power (dBm)	Limit (dBm)	Verdict
NVNT	1-DH5	2402	-0.05	<=20.97	Pass
NVNT	1-DH5	2441	1.36	<=20.97	Pass
NVNT	1-DH5	2480	1.15	<=20.97	Pass
NVNT	2-DH5	2402	2.21	<=20.97	Pass
NVNT	2-DH5	2441	3.56	<=20.97	Pass
NVNT	2-DH5	2480	3.4	<=20.97	Pass
NVNT	3-DH5	2402	2.92	<=20.97	Pass
NVNT	3-DH5	2441	4.2	<=20.97	Pass
NVNT	3-DH5	2480	3.96	<=20.97	Pass



Test Graphs Peak Power NVNT 1-DH5 2402MHz



Peak Power NVNT 1-DH5 2441MHz





Peak Power NVNT 1-DH5 2480MHz

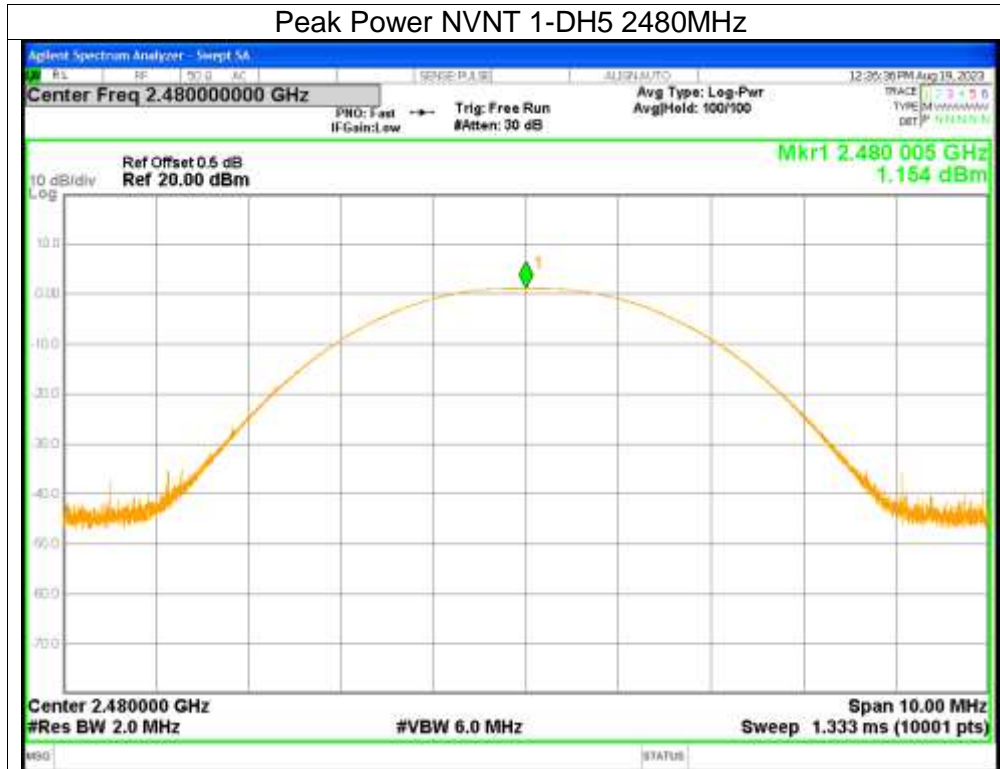

Peak Power NVNT 2-DH5 2402MHz

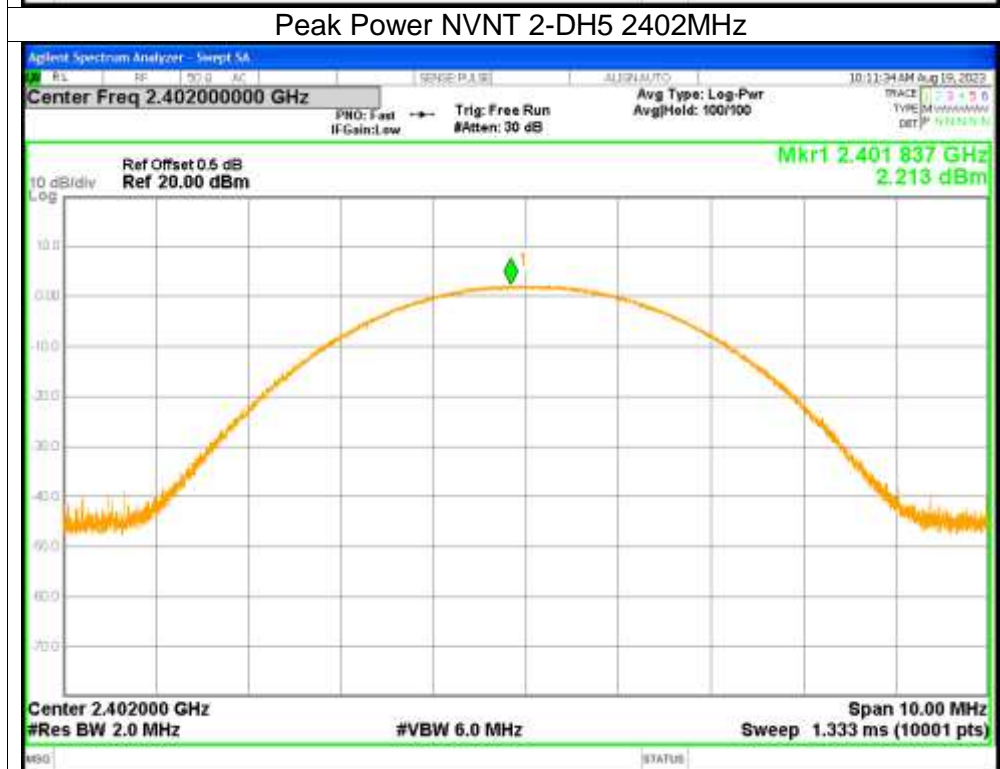



Peak Power NVNT 2-DH5 2441MHz

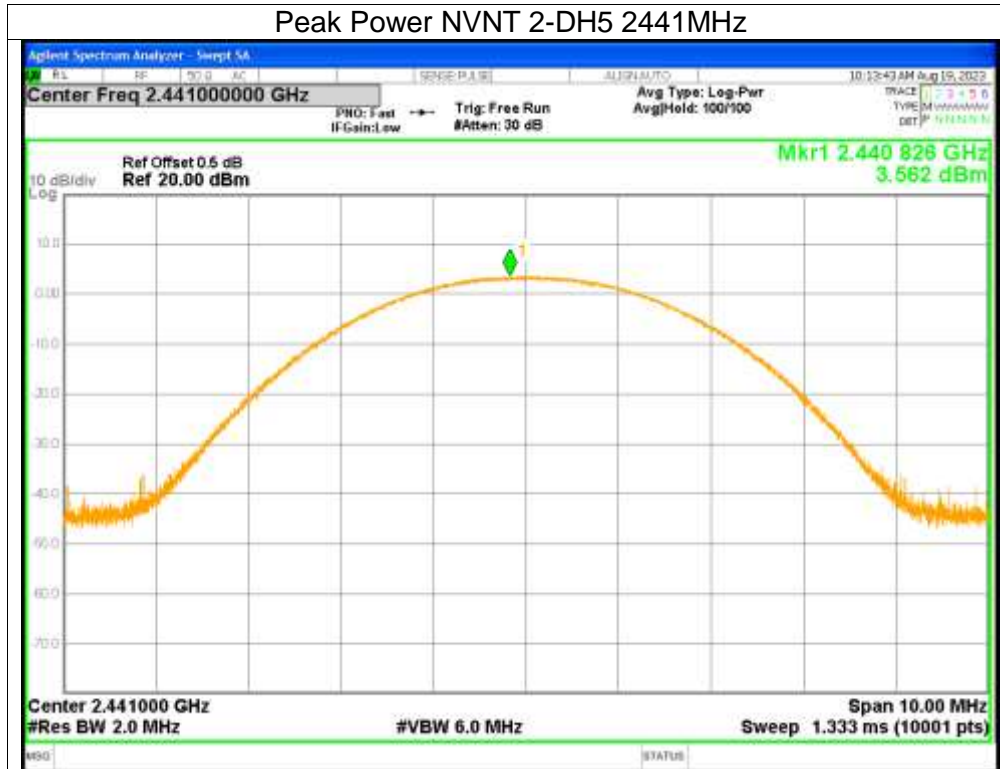

Peak Power NVNT 2-DH5 2480MHz





Peak Power NVNT 3-DH5 2402MHz

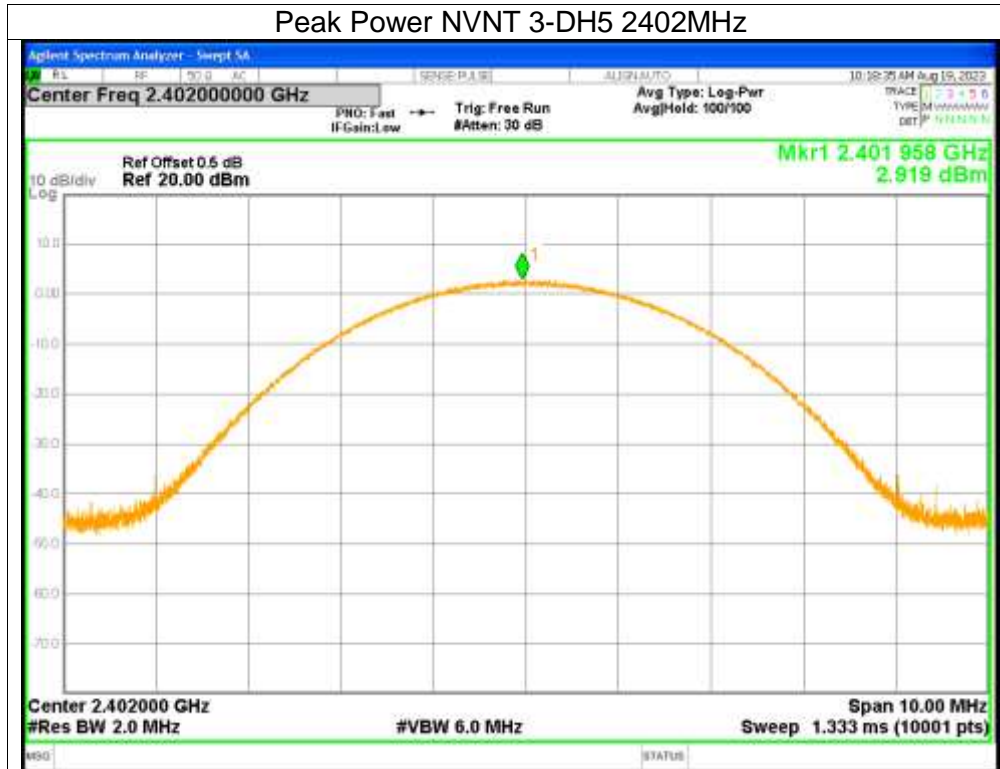

Peak Power NVNT 3-DH5 2441MHz

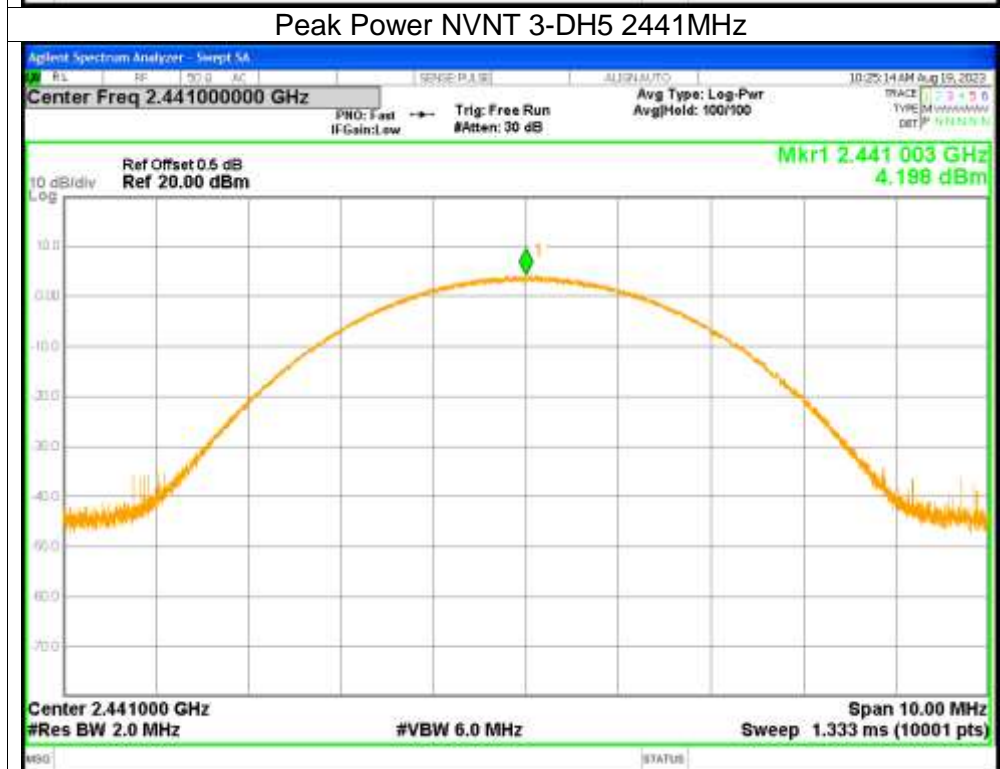



Peak Power NVNT 3-DH5 2480MHz

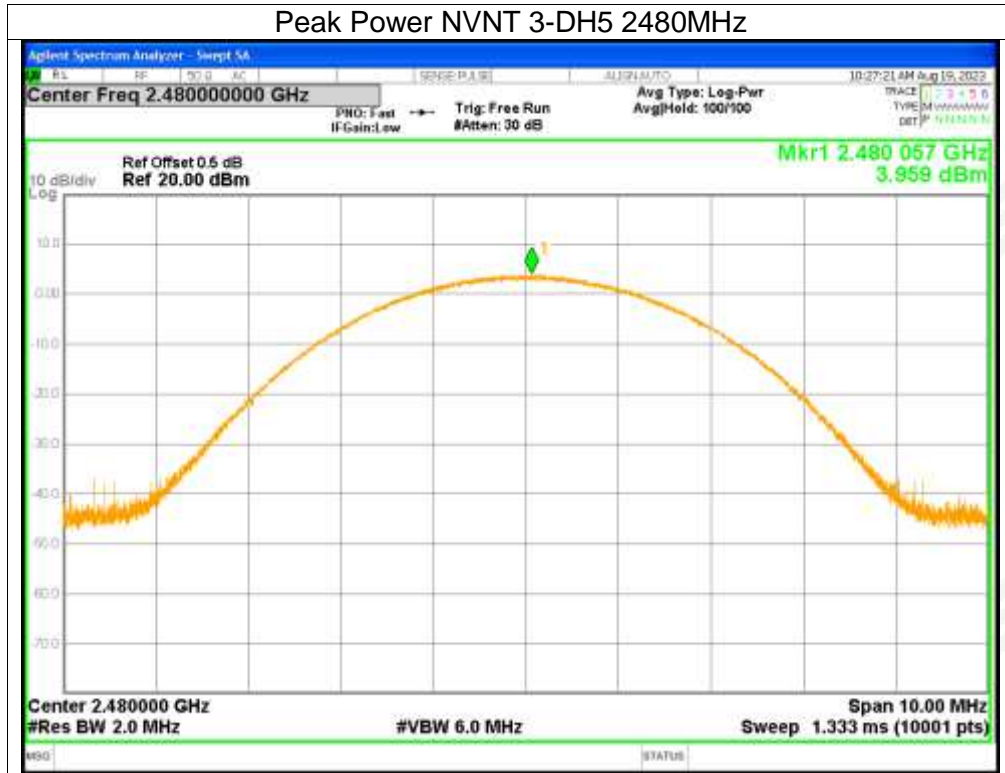



3. -20dB Bandwidth

Condition	Mode	Frequency (MHz)	-20 dB Bandwidth (MHz)	Verdict
NVNT	1-DH5	2402	0.9433	Pass
NVNT	1-DH5	2441	0.931	Pass
NVNT	1-DH5	2480	0.9401	Pass
NVNT	2-DH5	2402	1.2821	Pass
NVNT	2-DH5	2441	1.3164	Pass
NVNT	2-DH5	2480	1.2815	Pass
NVNT	3-DH5	2402	1.29	Pass
NVNT	3-DH5	2441	1.2963	Pass
NVNT	3-DH5	2480	1.3162	Pass

Test Graphs

-20dB Bandwidth NVNT 1-DH5 2402MHz



-20dB Bandwidth NVNT 1-DH5 2441MHz



-20dB Bandwidth NVNT 1-DH5 2480MHz

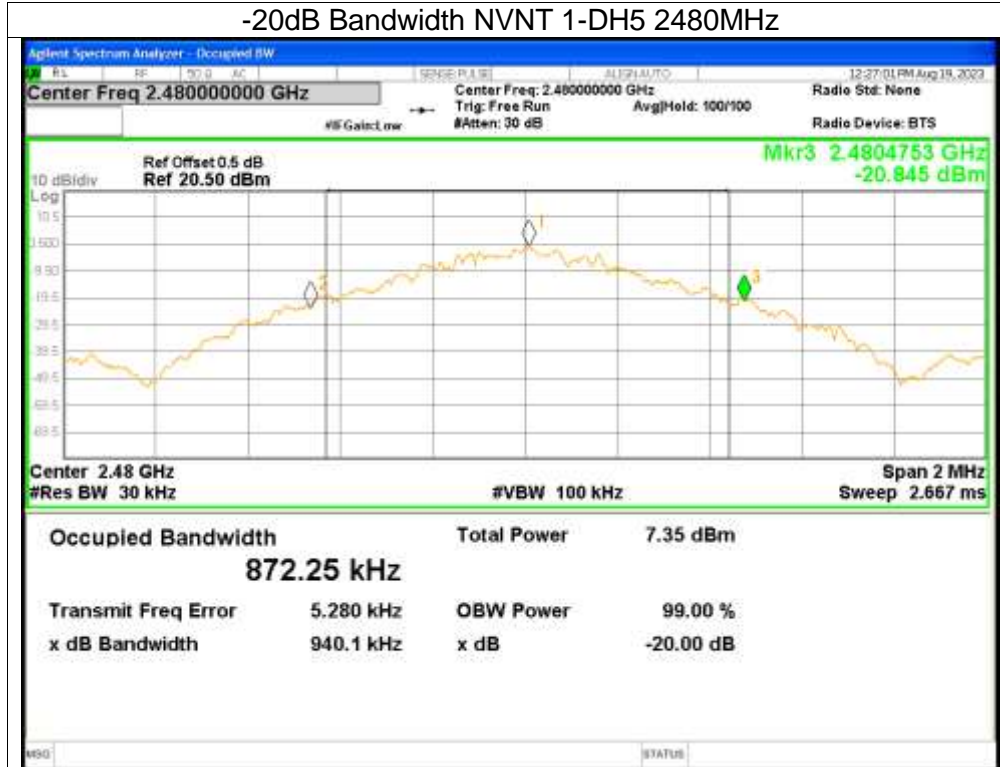

-20dB Bandwidth NVNT 2-DH5 2402MHz

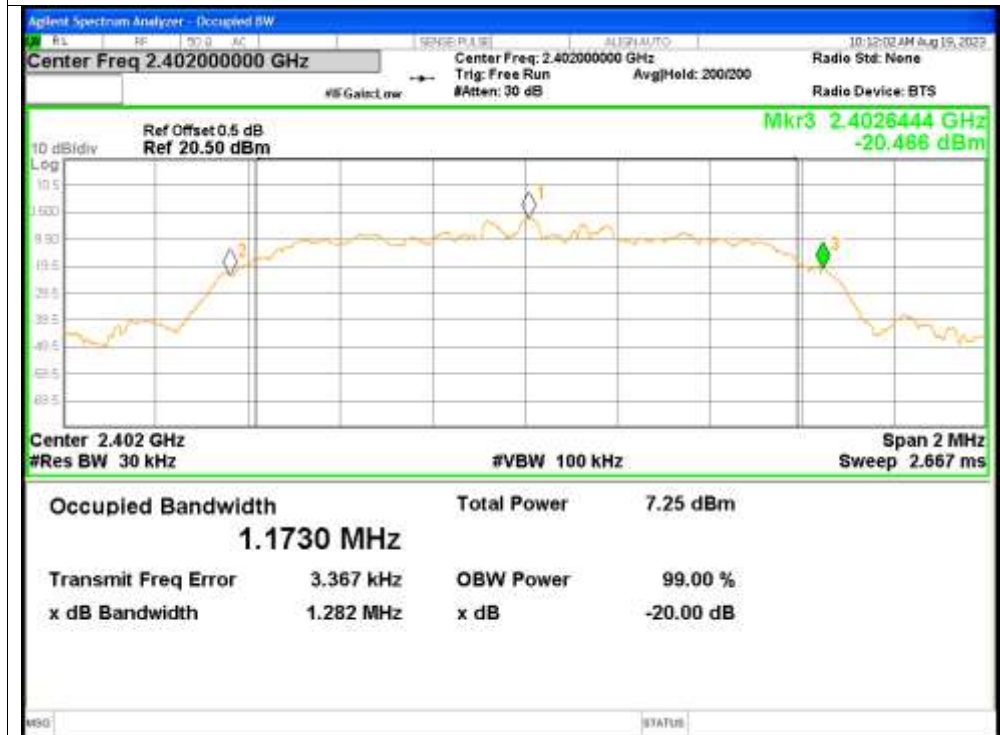

-20dB Bandwidth NVNT 2-DH5 2441MHz

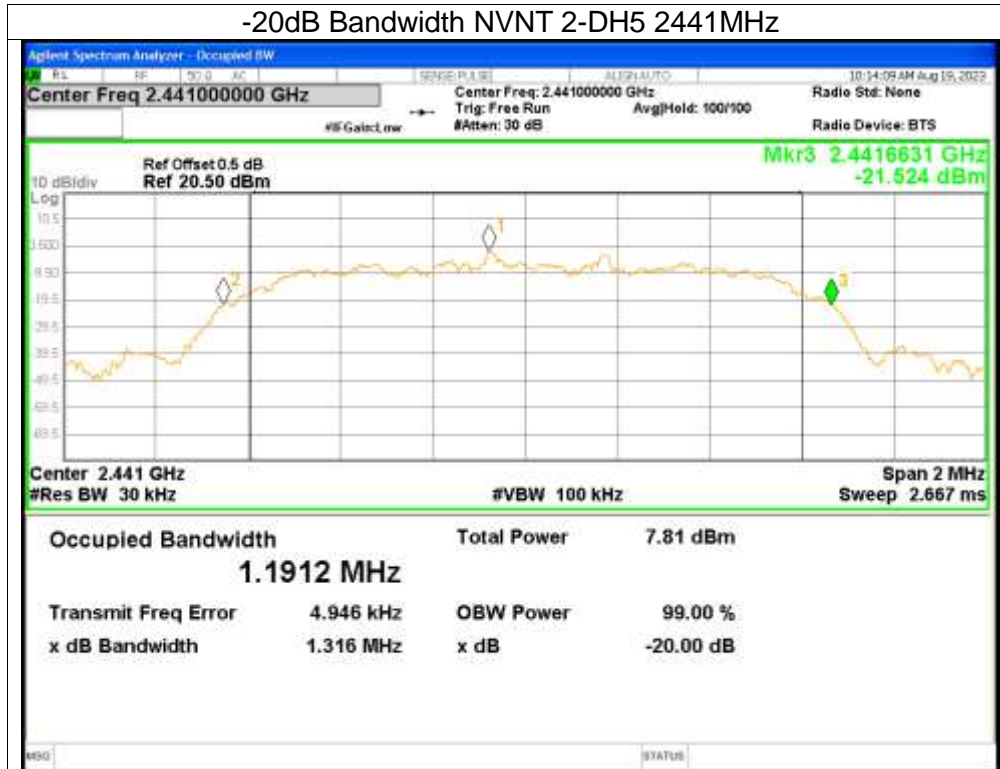

-20dB Bandwidth NVNT 2-DH5 2480MHz



-20dB Bandwidth NVNT 3-DH5 2402MHz

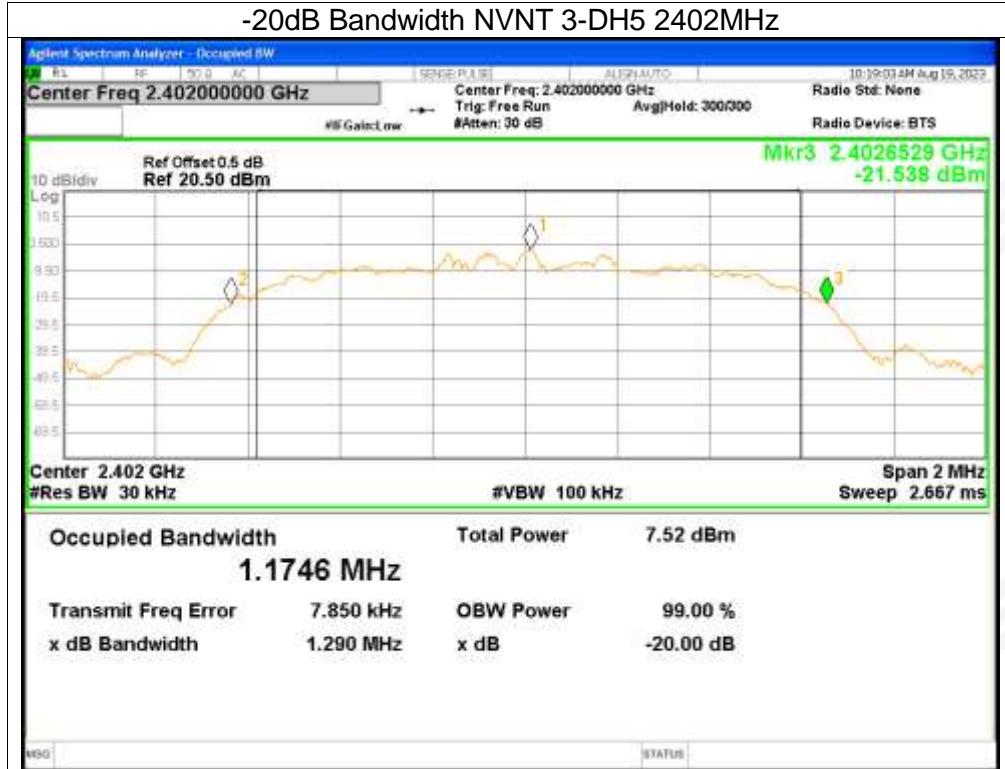

-20dB Bandwidth NVNT 3-DH5 2441MHz





-20dB Bandwidth NVNT 3-DH5 2480MHz

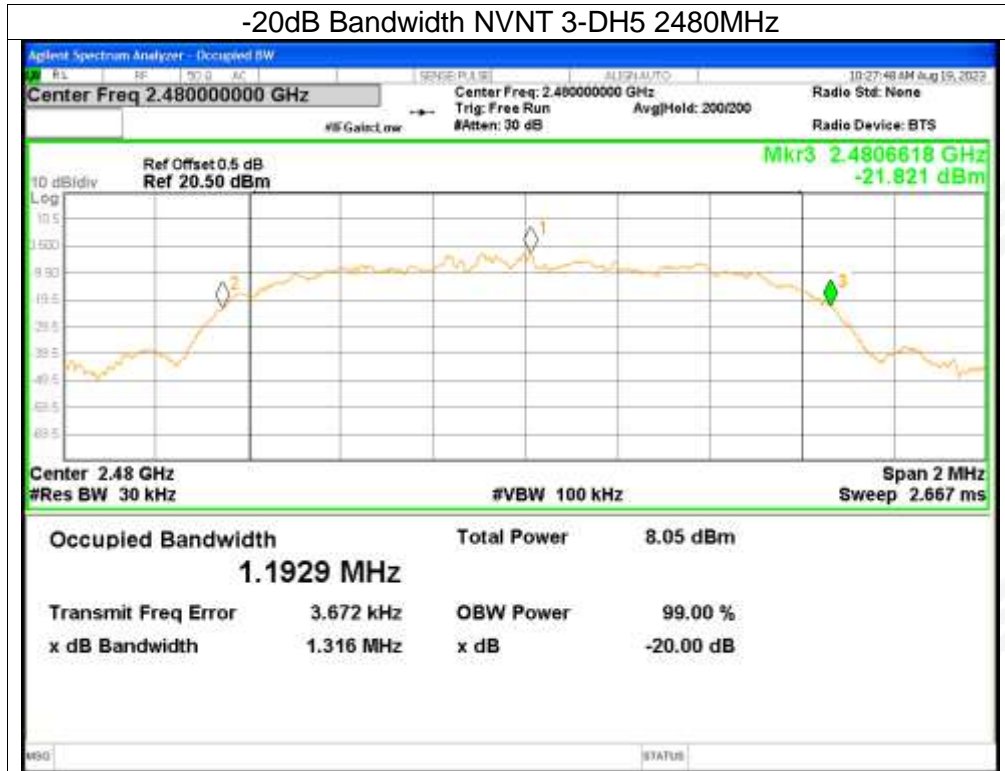



5. Carrier Frequencies Separation

Condition	Mode	Hopping Freq1 (MHz)	Hopping Freq2 (MHz)	HFS (MHz)	Limit (MHz)	Verdict
NVNT	1-DH5	2401.842	2402.994	1.152	≥ 0.629	Pass
NVNT	1-DH5	2439.994	2441	1.006	≥ 0.621	Pass
NVNT	1-DH5	2478.924	2480.01	1.086	≥ 0.627	Pass
NVNT	2-DH5	2401.998	2403.008	1.01	≥ 0.855	Pass
NVNT	2-DH5	2441.006	2442.018	1.012	≥ 0.878	Pass
NVNT	2-DH5	2479.008	2479.998	0.99	≥ 0.854	Pass
NVNT	3-DH5	2401.84	2403.008	1.168	≥ 0.86	Pass
NVNT	3-DH5	2440.934	2441.912	0.978	≥ 0.864	Pass
NVNT	3-DH5	2479.02	2479.998	0.978	≥ 0.877	Pass

CFS NVNT 1-DH5 2480MHz



CFS NVNT 2-DH5 2402MHz

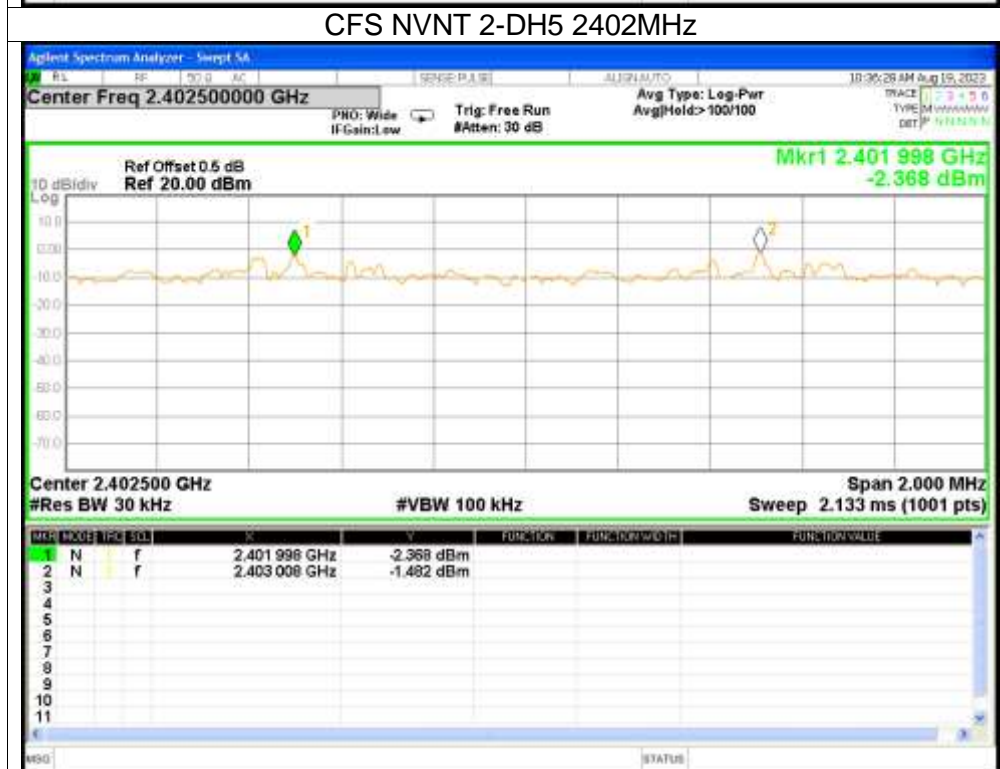

CFS NVNT 2-DH5 2441MHz

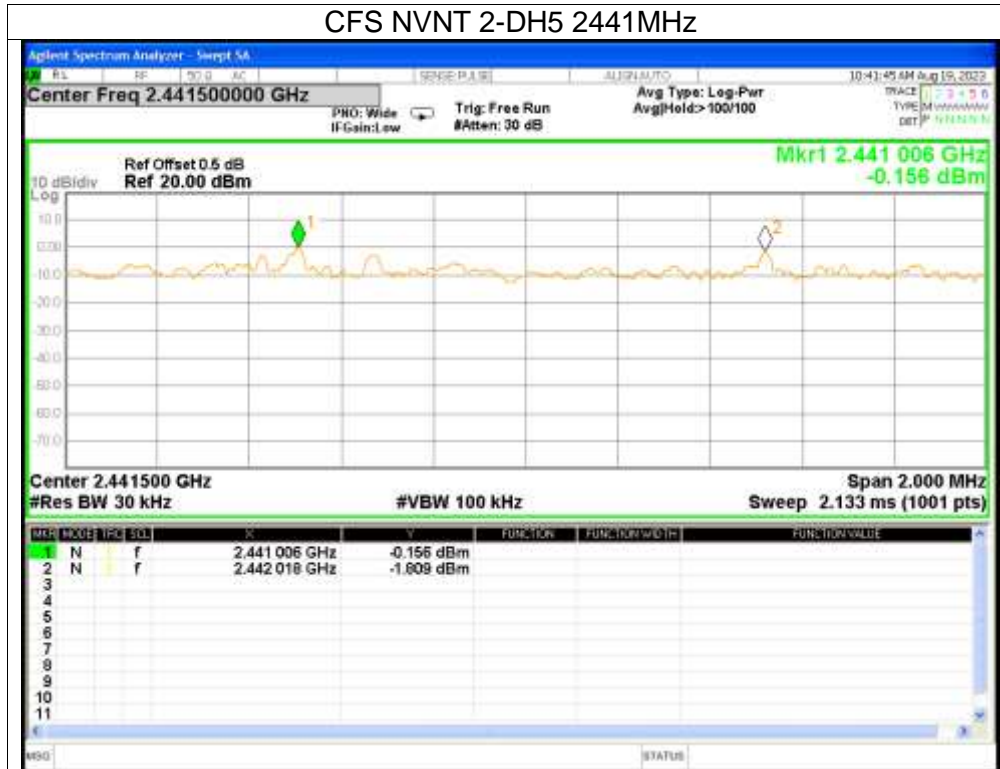

CFS NVNT 2-DH5 2480MHz

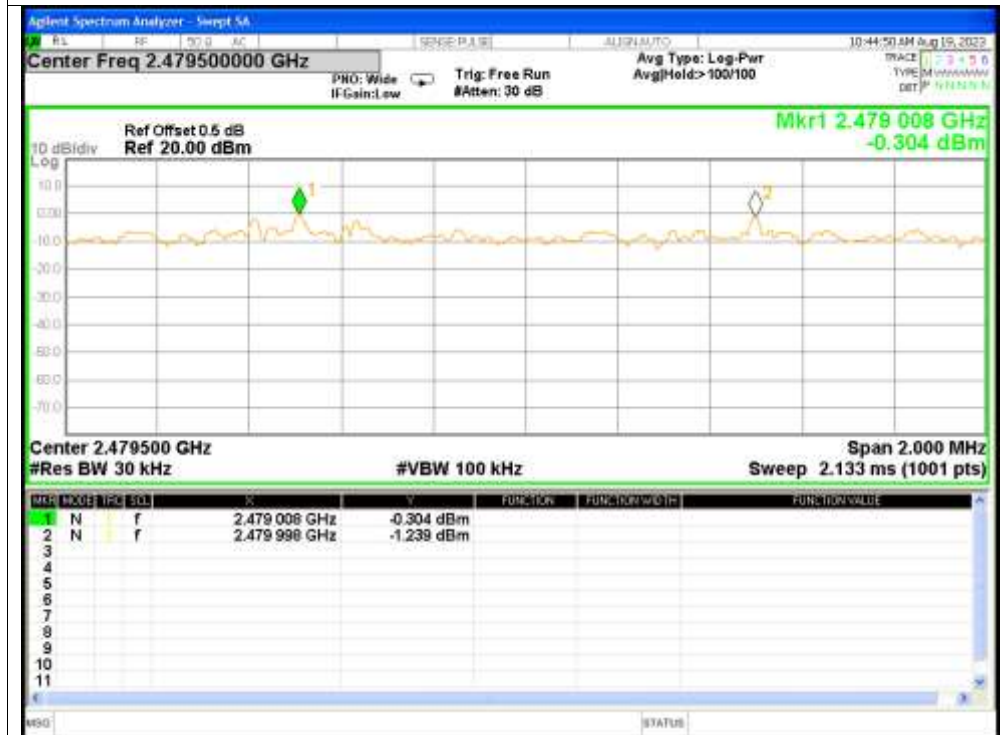

CFS NVNT 3-DH5 2402MHz

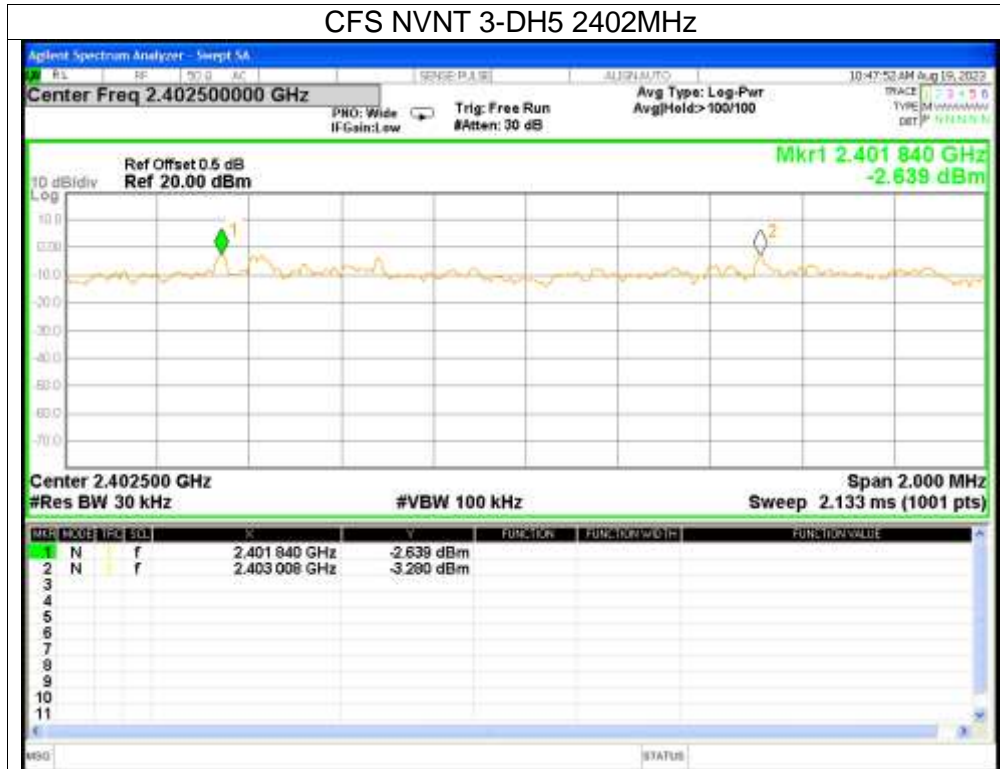

CFS NVNT 3-DH5 2441MHz





6. Number of Hopping Channel

Condition	Mode	Hopping Number	Limit	Verdict
NVNT	1-DH5	79	≥ 15	Pass
NVNT	2-DH5	79	≥ 15	Pass
NVNT	3-DH5	79	≥ 15	Pass

Test Graphs Hopping No. NVNT 1-DH5 Hopping

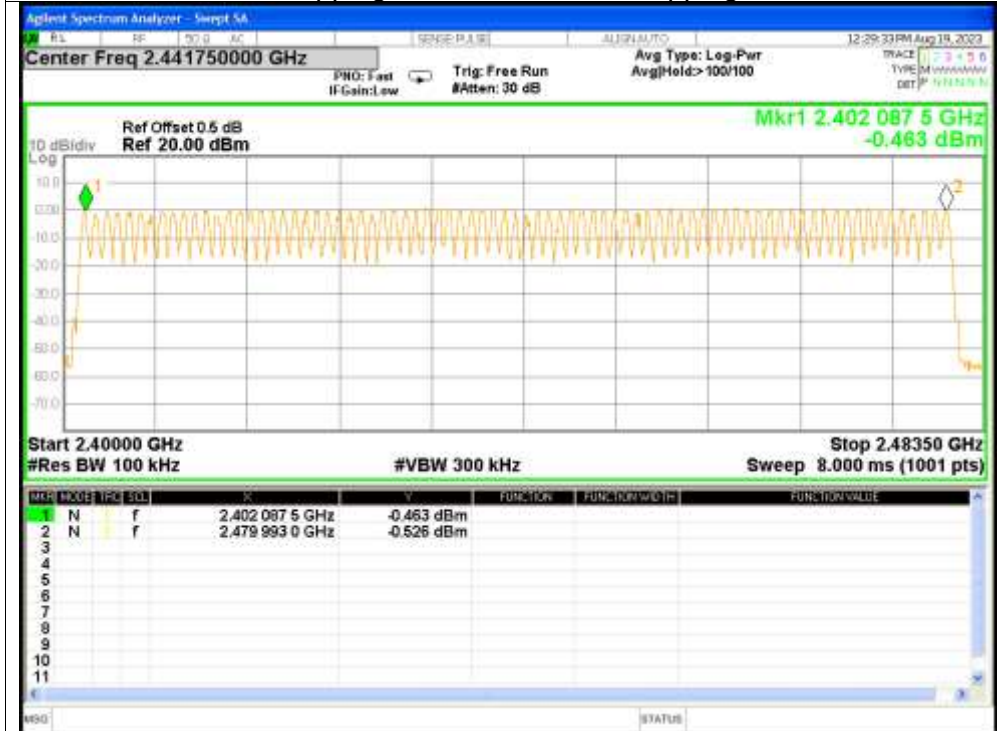

Hopping No. NVNT 2-DH5 Hopping





7. Band Edge

Condition	Mode	Frequency (MHz)	Hopping Mode	Max Value (dBc)	Limit (dBc)	Verdict
NVNT	1-DH5	2402	No-Hopping	-50.75	<=-20	Pass
NVNT	1-DH5	2480	No-Hopping	-51.37	<=-20	Pass
NVNT	2-DH5	2402	No-Hopping	-52.3	<=-20	Pass
NVNT	2-DH5	2480	No-Hopping	-51.97	<=-20	Pass
NVNT	3-DH5	2402	No-Hopping	-51.71	<=-20	Pass
NVNT	3-DH5	2480	No-Hopping	-53.76	<=-20	Pass

Test Graphs

Band Edge NVNT 1-DH5 2402MHz No-Hopping Ref



Band Edge NVNT 1-DH5 2402MHz No-Hopping Emission





8. Band Edge(Hopping)

Condition	Mode	Frequency (MHz)	Hopping Mode	Max Value (dBc)	Limit (dBc)	Verdict
NVNT	1-DH5	2402	Hopping	-55.29	≤ -20	Pass
NVNT	1-DH5	2480	Hopping	-55.38	≤ -20	Pass
NVNT	2-DH5	2402	Hopping	-55.16	≤ -20	Pass
NVNT	2-DH5	2480	Hopping	-54.69	≤ -20	Pass
NVNT	3-DH5	2402	Hopping	-64.36	≤ -20	Pass
NVNT	3-DH5	2480	Hopping	-53.71	≤ -20	Pass

Test Graphs

Band Edge(Hopping) NVNT 1-DH5 2402MHz Hopping Ref



Band Edge(Hopping) NVNT 1-DH5 2402MHz Hopping Emission



Band Edge(Hopping) NVNT 1-DH5 2480MHz Hopping Ref

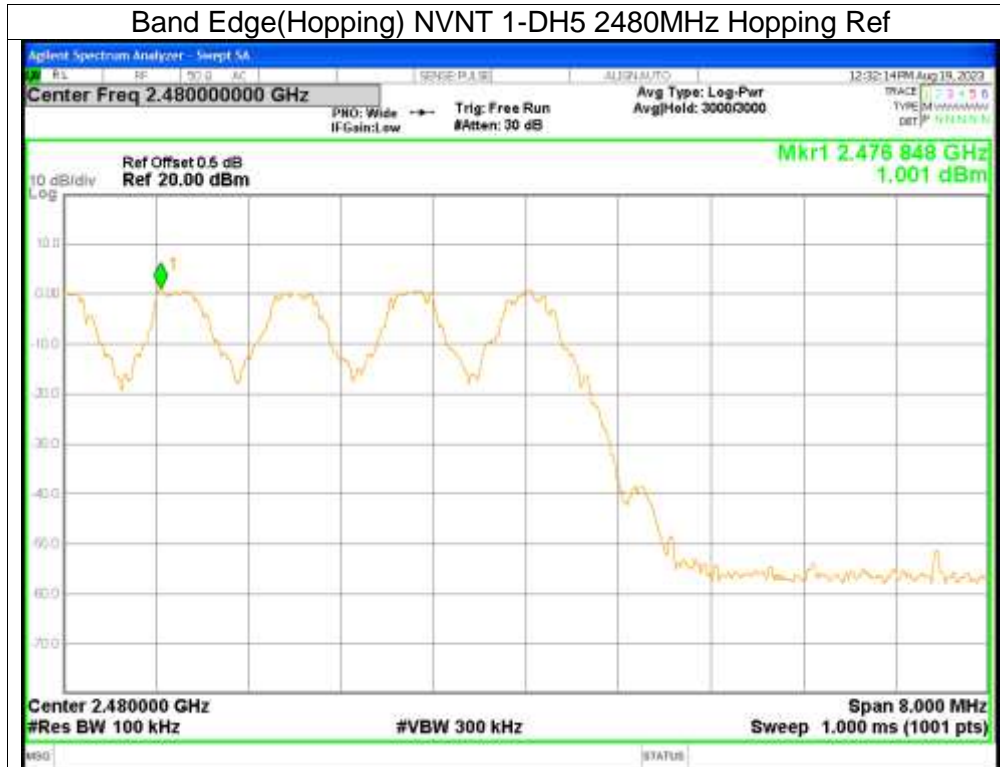

Band Edge(Hopping) NVNT 1-DH5 2480MHz Hopping Emission





9. Conducted RF Spurious Emission

Condition	Mode	Frequency (MHz)	Max Value (dBc)	Limit (dBc)	Verdict
NVNT	1-DH5	2402	-43.38	<=-20	Pass
NVNT	1-DH5	2441	-43.07	<=-20	Pass
NVNT	1-DH5	2480	-42.15	<=-20	Pass
NVNT	2-DH5	2402	-42.97	<=-20	Pass
NVNT	2-DH5	2441	-42.13	<=-20	Pass
NVNT	2-DH5	2480	-44.37	<=-20	Pass
NVNT	3-DH5	2402	-42.09	<=-20	Pass
NVNT	3-DH5	2441	-42.97	<=-20	Pass
NVNT	3-DH5	2480	-43.51	<=-20	Pass

Test Graphs
Tx. Spurious NVNT 1-DH5 2402MHz Ref



Tx. Spurious NVNT 1-DH5 2402MHz Emission

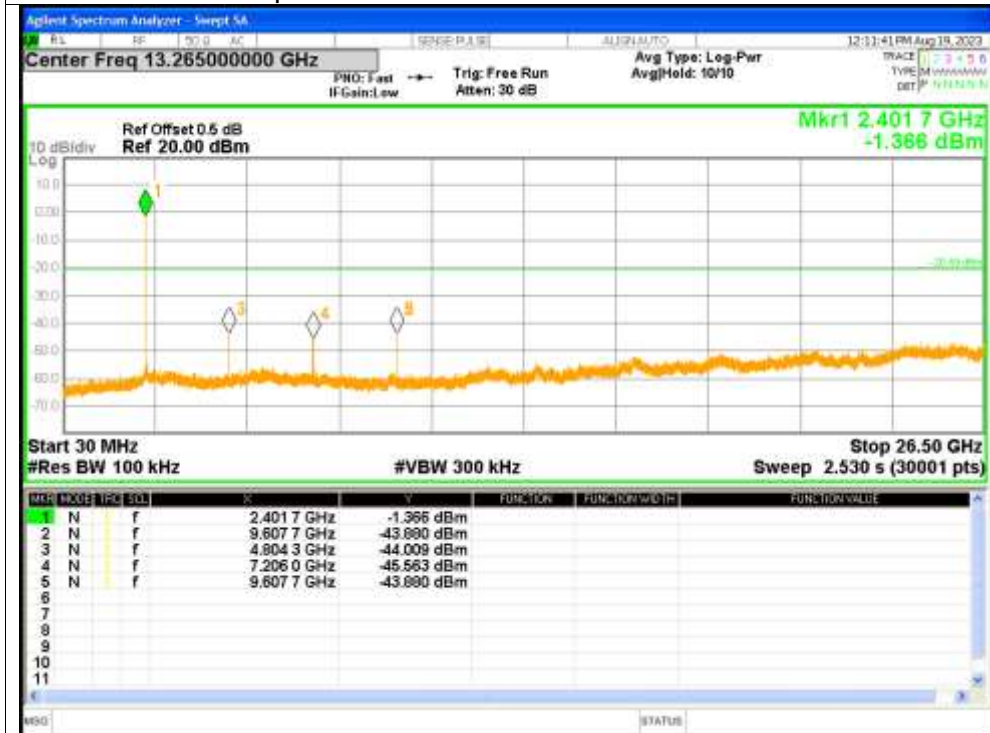



10. Dwell Time

Condition	Mode	Frequency (MHz)	Pulse Time (ms)	Total Dwell Time (ms)	Burst Count	Period Time (ms)	Limit (ms)	Verdict
NVNT	1-DH5	2441	2.909	296.718	102	31600	<=400	Pass
NVNT	2-DH5	2441	2.913	305.865	105	31600	<=400	Pass
NVNT	3-DH5	2441	2.913	288.387	99	31600	<=400	Pass

Test Graphs Dwell NVNT 1-DH5 2441MHz One Burst



Dwell NVNT 1-DH5 2441MHz Accumulated

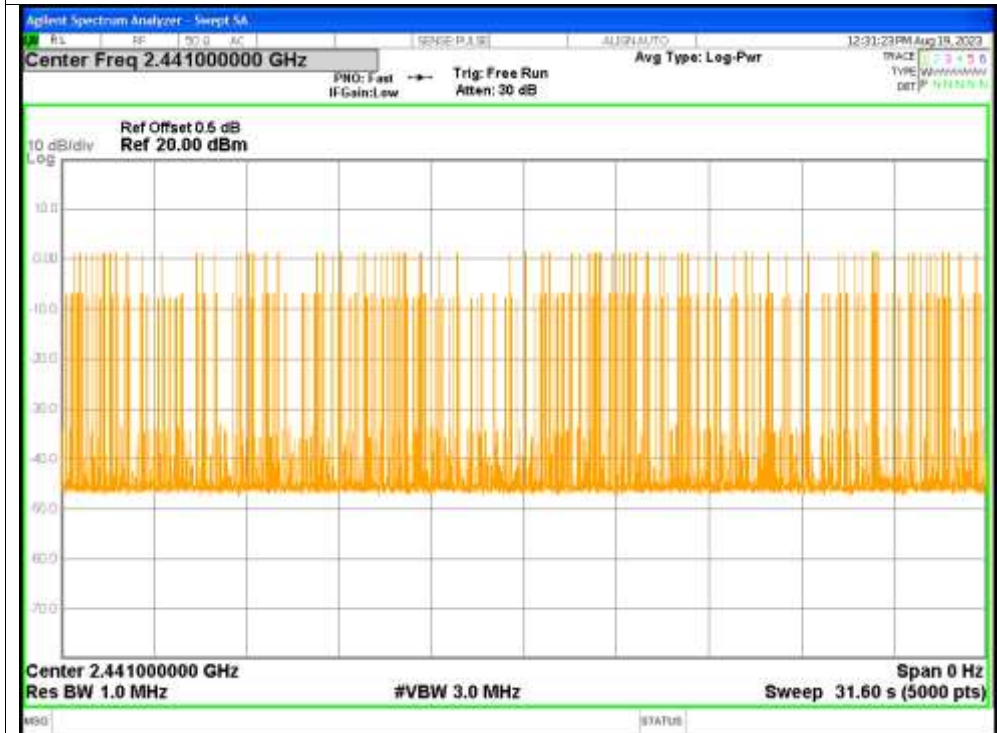

Dwell NVNT 2-DH5 2441MHz One Burst

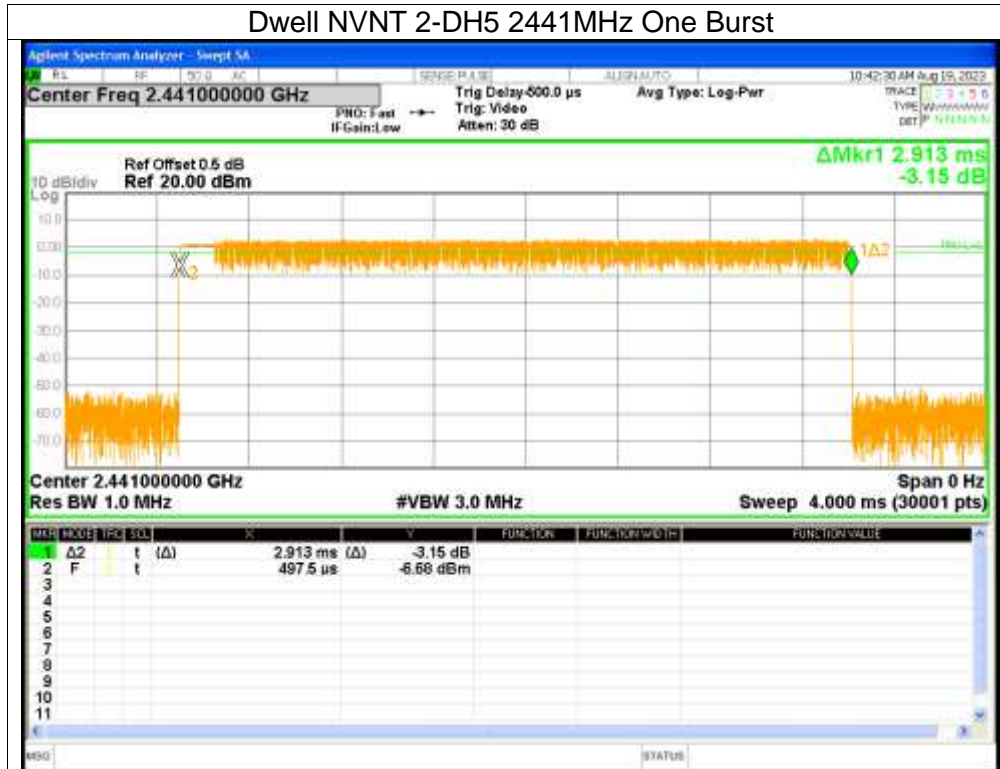

Dwell NVNT 2-DH5 2441MHz Accumulated

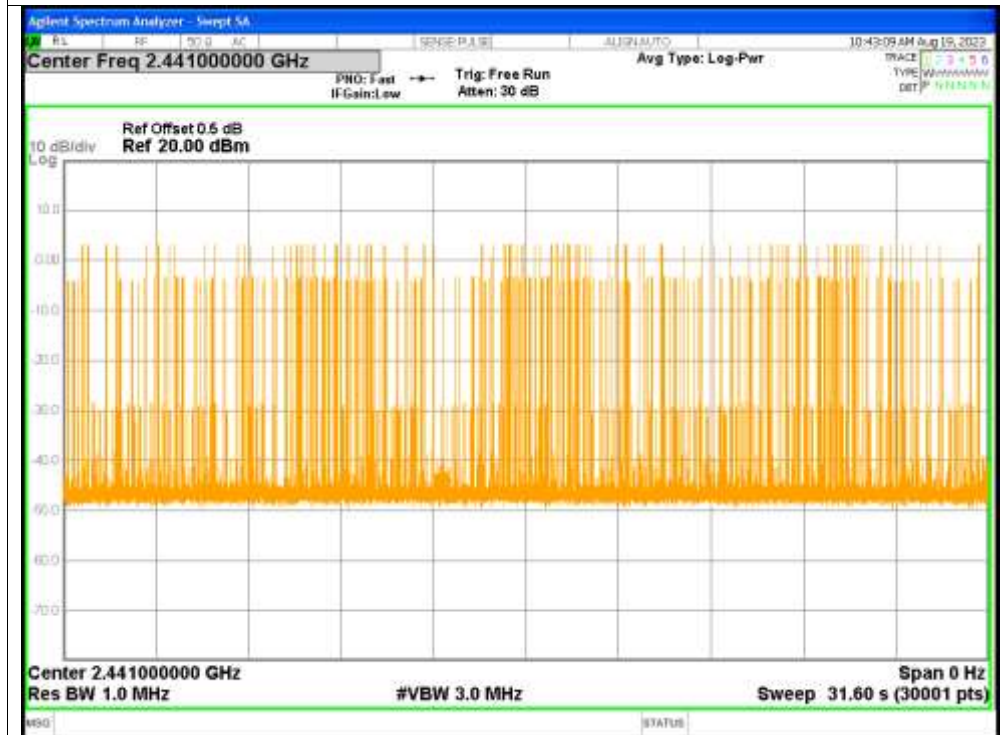



Dwell NVNT 3-DH5 2441MHz One Burst

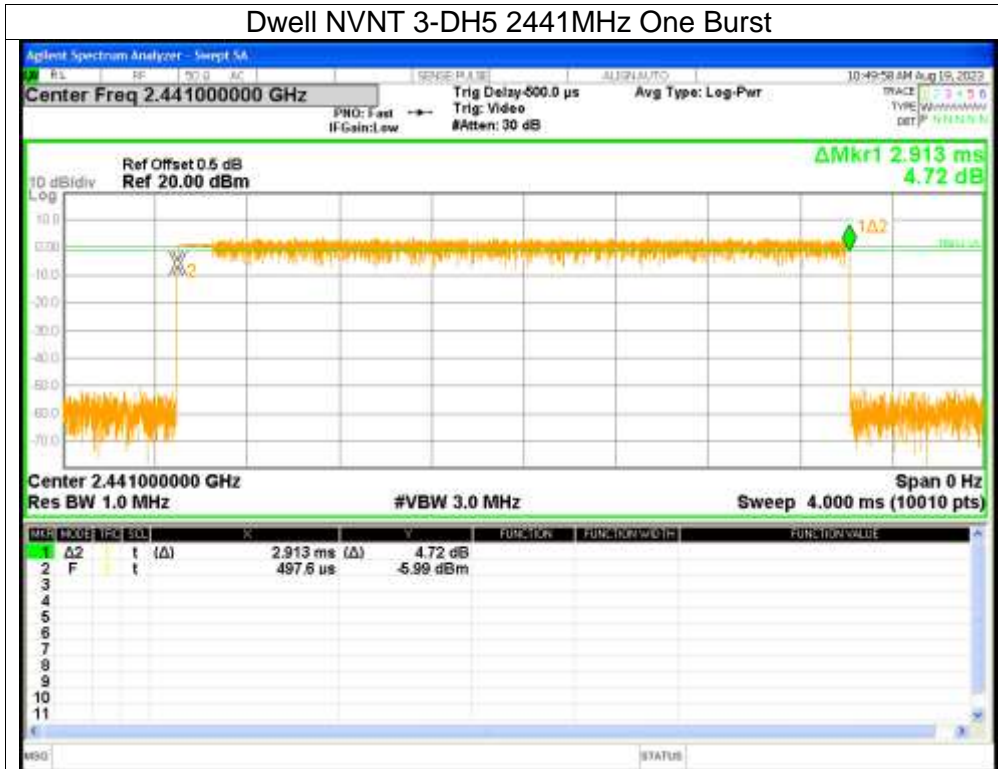

Dwell NVNT 3-DH5 2441MHz Accumulated

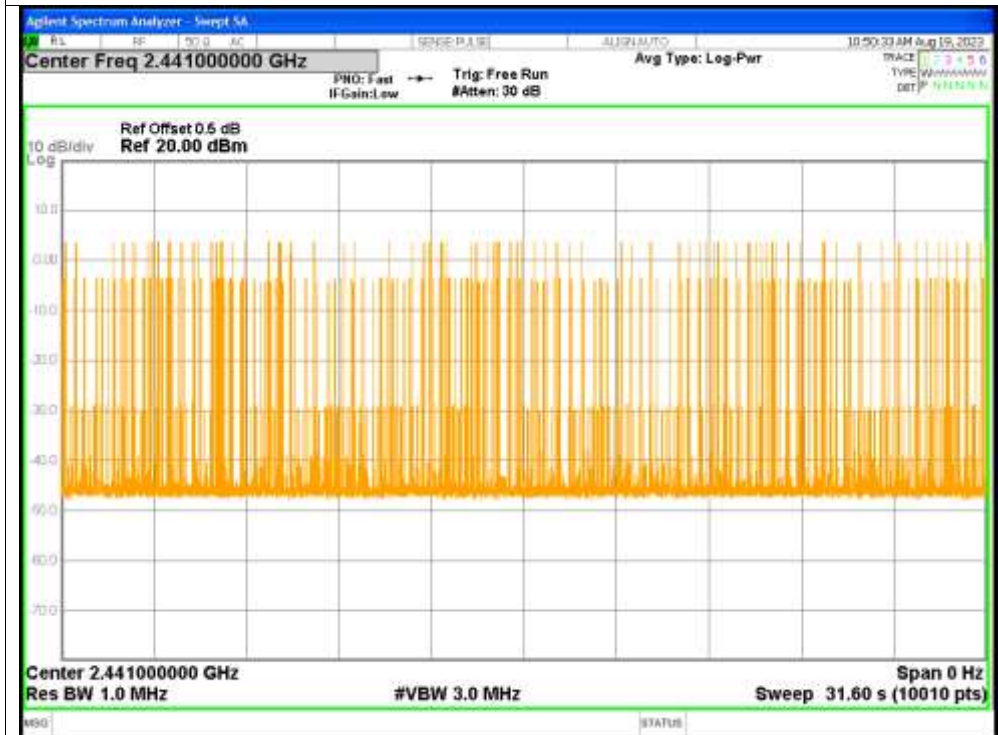



APPENDIX 2-PHOTOS OF TEST SETUP

Note: See test photos in setup photo document for the actual connections between Product and support equipment.

*****END OF THE REPORT*****