

FCC TEST REPORT

Client Name : LIFEWORKS TECHNOLOGY GROUP LLC.
Address : 530 7th Ave 21st Fl, New York, United States, 10018
Product Name : Magscope
Date : Jan. 12, 2022



Shenzhen Anbotek Compliance Laboratory Limited

Contents

| | |
|--|----|
| 1. General Information..... | 4 |
| 1.1. Client Information..... | 4 |
| 1.2. Description of Device (EUT)..... | 4 |
| 1.3. Auxiliary Equipment Used During Test..... | 5 |
| 1.4. Description of Test Modes..... | 5 |
| 1.5. Description Of Test Setup..... | 6 |
| 1.6. Test Equipment List..... | 7 |
| 1.7. Measurement Uncertainty..... | 8 |
| 1.8. Description of Test Facility..... | 8 |
| 2. Summary of Test Results..... | 9 |
| 3. Conducted Emission Test..... | 10 |
| 3.1. Test Standard and Limit..... | 10 |
| 3.2. Test Setup..... | 10 |
| 3.3. Test Procedure..... | 10 |
| 3.4. Test Data..... | 10 |
| 4. Radiation Spurious Emission..... | 13 |
| 4.1. Test Standard and Limit..... | 13 |
| 4.2. Test Setup..... | 13 |
| 4.3. Test Procedure..... | 14 |
| 4.4. Test Data..... | 14 |
| 5. Antenna Requirement..... | 19 |
| 5.1. Test Standard and Requirement..... | 19 |
| 5.2. Antenna Connected Construction..... | 19 |
| APPENDIX I -- TEST SETUP PHOTOGRAPH..... | 20 |
| APPENDIX II -- EXTERNAL PHOTOGRAPH..... | 22 |
| APPENDIX III -- INTERNAL PHOTOGRAPH..... | 26 |

TEST REPORT

Applicant : LIFEWORKS TECHNOLOGY GROUP LLC.
Manufacturer : LIFEWORKS TECHNOLOGY GROUP LLC.
Product Name : Magscope
Model No. : 2IHBD1132, 2IHBD1132W9L2, 2IHQI1001, 2IHQI1001W0L2
Trade Mark : N.A.
Rating(s) : Input: DC 5V/2A, DC 9V/2A
Output: 10W/7.5W/5W
Test Standard(s) : FCC Part15 Subpart C, Paragraph 15.209
Test Method(s) : ANSI C63.10: 2020

The device described above is tested by Shenzhen Anbotek Compliance Laboratory Limited to determine the maximum emission levels emanating from the device and the severe levels of the device can endure and its performance criterion. The measurement results are contained in this test report and Shenzhen Anbotek Compliance Laboratory Limited is assumed full of responsibility for the accuracy and completeness of these measurements. Also, this report shows that the EUT (Equipment Under Test) is technically compliant with the FCC Part 15 Subpart C requirements.

This report applies to above tested sample only and shall not be reproduced in part without written approval of Shenzhen Anbotek Compliance Laboratory Limited.

Date of Receipt

Dec. 20, 2021

Date of Test

Dec. 20~ 29, 2021

Prepared By



(Ella Liang)

Approved & Authorized Signer



(Kingkong Jin)

1. General Information

1.1. Client Information

| | | |
|--------------|---|---|
| Applicant | : | LIFEWORKS TECHNOLOGY GROUP LLC. |
| Address | : | 530 7th Ave 21st Fl, New York, United States, 10018 |
| Manufacturer | : | LIFEWORKS TECHNOLOGY GROUP LLC. |
| Address | : | 530 7th Ave 21st Fl, New York, United States, 10018 |
| Factory | : | LIFEWORKS TECHNOLOGY GROUP LLC. |
| Address | : | 530 7th Ave 21st Fl, New York, United States, 10018 |

1.2. Description of Device (EUT)

| | | |
|---|----------------------|--|
| Product Name | : | Magscope |
| Model No. | : | 2IHBD1132, 2IHBD1132W9L2, 2IHQI1001, 2IHQI1001W0L2 (Note: All samples are the same except the model number, so we prepare "2IHBD1132" for test only.) |
| Trade Mark | : | N.A. |
| Test Power Supply | : | AC 120V, 60Hz for adapter |
| Test Sample No. | : | 1-2-1(Normal Sample), 1-2-2(Engineering Sample) |
| Product Description | Operation Frequency: | 110.1-205KHz |
| | Modulation Type: | ASK |
| | Antenna Type: | Inductive loop coil Antenna |
| | Antenna Gain(Peak): | 0 dBi (Provided by customer) |
| | Adapter: | N.A. |
| Remark: 1) For a more detailed features description, please refer to the manufacturer's specifications or the User's Manual. | | |

1.3. Auxiliary Equipment Used During Test

| | | |
|------------------------|---|--|
| Adapter | : | M/N: A2014 Input: AC 100-240V, 0.75A, 50-60Hz Output: 5V---3A,9V---2A,12V---3A, 20V---1.5A |
| Wireless charging load | : | Manufacturer: Shenzhen Ouju Technology Co., Ltd. M/N: CD2577 Power: 5W/7.5W/10W/15W Last Cal.: Oct. 26, 2021 Cal. Interval: 1 Year |

1.4. Description of Test Modes

To investigate the maximum EMI emission characteristics generates from EUT, the test system was pre-scanning tested base on the consideration of following EUT operation mode or test configuration mode which possible have effect on EMI emission level. Each of these EUT operation mode(s) or test configuration mode(s) mentioned above was evaluated respectively.

| Pretest Mode | Description |
|--------------|------------------------|
| Mode 1 | Wireless charging mode |

| For Conducted Emission | |
|------------------------|------------------------|
| Final Test Mode | Description |
| Mode 1 | Wireless charging mode |

| For Radiated Emission | |
|-----------------------|------------------------|
| Final Test Mode | Description |
| Mode 1 | Wireless charging mode |

Note: (1)Test channel is 0.125MHz.

(2) All the situation(full load, half load and empty load) has been tested,only the worst situation (full load 10W) was recorded in the report.

1.5. Description Of Test Setup

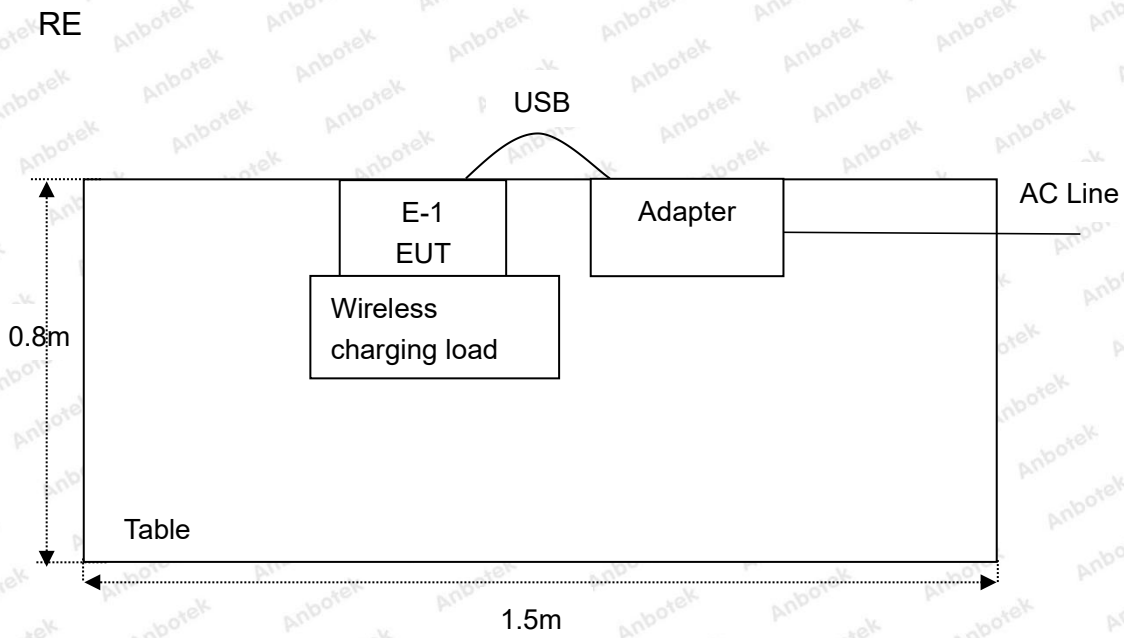
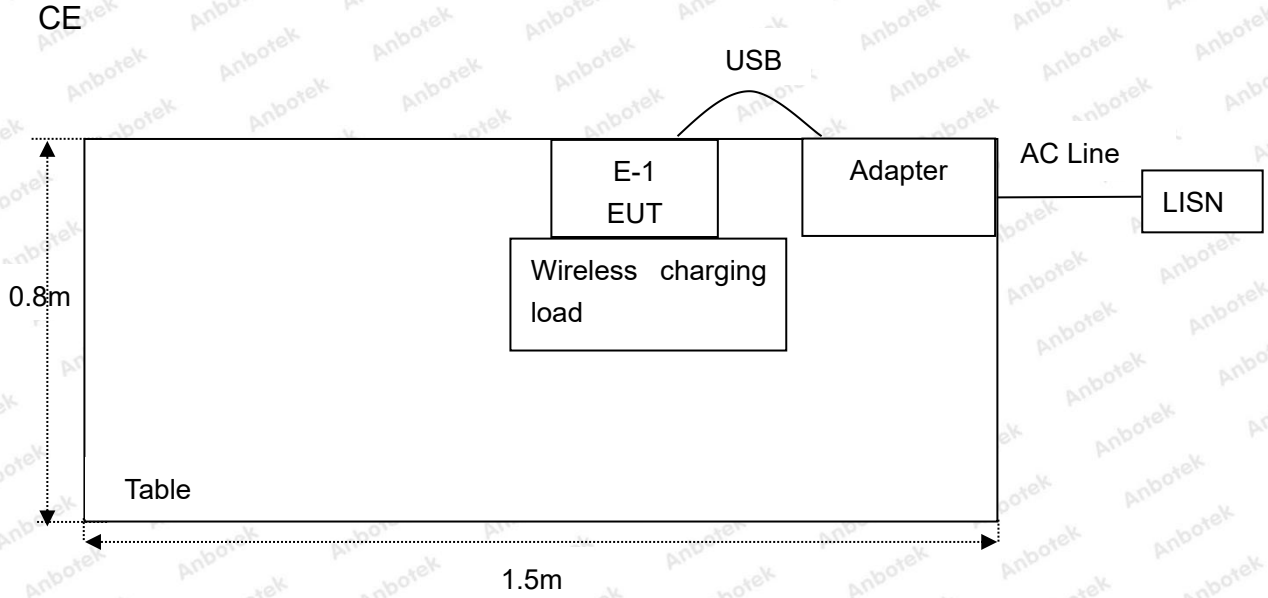

1.6. Test Equipment List

| Item | Equipment | Manufacturer | Model No. | Serial No. | Last Cal. | Cal. Interval |
|------|---|-------------------------|---------------|---------------|---------------|---------------|
| 1. | Three Phase V-type Artificial Power Network | CYBERTEK | EM5040DT | E215040DT001 | Jul 05, 2021 | 1 Year |
| 2. | EMI Test Receiver | Rohde & Schwarz | ESCI | 100627 | Oct. 22, 2021 | 1 Year |
| 3. | EMI Test Receiver | Rohde & Schwarz | ESR26 | 101481 | Oct. 22, 2021 | 1 Year |
| 4. | RF Switching Unit | Compliance Direction | RSU-M2 | 38303 | Oct. 22, 2021 | 1 Year |
| 5. | MAX Spectrum Analysis | Agilent | N9020A | MY51170037 | Oct. 22, 2021 | 1 Year |
| 6. | Preamplifier | SKET Electronic | BK1G18G30 D | KD17503 | Oct. 22, 2021 | 1 Year |
| 7. | Double Ridged Horn Antenna | Instruments corporation | GTH-0118 | 351600 | Oct. 22, 2021 | 2 Year |
| 8. | Bilog Broadband Antenna | Schwarzbeck | VULB9163 | VULB 9163-289 | Oct. 22, 2021 | 2 Year |
| 9. | Loop Antenna | Schwarzbeck | FMZB1519B | 00053 | Oct. 22, 2021 | 2 Year |
| 10. | Horn Antenna | A-INFO | LB-180400-K F | J211060628 | Oct. 22, 2021 | 2 Year |
| 11. | Pre-amplifier | SONOMA | 310N | 186860 | Oct. 22, 2021 | 1 Year |
| 12. | EMI Test Software EZ-EMC | SHURPLE | N/A | N/A | N/A | N/A |
| 13. | RF Test Control System | YIHENG | YH3000 | 2017430 | Oct. 22, 2021 | 1 Year |
| 14. | Power Sensor | DAER | RPR3006W | 15I00041SN045 | Oct. 22, 2021 | 1 Year |
| 15. | Power Sensor | DAER | RPR3006W | 15I00041SN046 | Oct. 22, 2021 | 1 Year |
| 16. | MXA Spectrum Analysis | KEYSIGHT | N9020A | MY53280032 | Oct. 22, 2021 | 1 Year |
| 17. | MXG RF Vector Signal Generator | Agilent | N5182A | MY48180656 | Oct. 22, 2021 | 1 Year |
| 18. | Signal Generator | Agilent | E4421B | MY41000743 | Oct. 22, 2021 | 1 Year |
| 19. | DC Power Supply | IVYTECH | IV3605 | 1804D360510 | Oct. 22, 2021 | 1 Year |
| 20. | Constant Temperature Humidity Chamber | ZHONGJIAN | ZJ-KHWS80 B | N/A | Oct. 22, 2021 | 1 Year |

1.7. Measurement Uncertainty

| | | |
|------------------------|---|--------------------------|
| Radiation Uncertainty | : | Ur = 3.9 dB (Horizontal) |
| | | Ur = 3.8 dB (Vertical) |
| Conduction Uncertainty | : | Uc = 3.4 dB |

1.8. Description of Test Facility

The test facility is recognized, certified, or accredited by the following organizations:

FCC-Registration No.: 184111

Shenzhen Anbotek Compliance Laboratory Limited, EMC Laboratory has been registered and fully described in a report filed with the (FCC) Federal Communications Commission. The acceptance letter from the FCC is maintained in our files. Registration No. 184111.

ISED-Registration No.: 8058A

Shenzhen Anbotek Compliance Laboratory Limited, EMC Laboratory has been registered and fully described in a report filed with the (ISED) Innovation, Science and Economic Development Canada. The acceptance letter from the ISED is maintained in our files. Registration 8058A.

Test Location

Shenzhen Anbotek Compliance Laboratory Limited.

1/F, Building D, Sogood Science and Technology Park, Sanwei community, Hangcheng Street, Bao'an District, Shenzhen, Guangdong, China.518102

2. Summary of Test Results

| Standard Section | Test Item | Result |
|-------------------------------------|-------------------------|--------|
| FCC Part 15, Paragraph 15.207 | Conducted Emission Test | PASS |
| FCC Part 15, Paragraph 15.209(a)(f) | Spurious Emission | PASS |
| Part 15.203 | Antenna Requirement | PASS |

3. Conducted Emission Test

3.1. Test Standard and Limit

| | | | |
|--|---------------------------|--------------------------------|---------------|
| Test Standard | FCC Part15 Section 15.207 | | |
| Test Limit | Frequency | Maximum RF Line Voltage (dBuV) | |
| | | Quasi-peak Level | Average Level |
| | 150kHz~500kHz | 66 ~ 56 * | 56 ~ 46 * |
| | 500kHz~5MHz | 56 | 46 |
| | 5MHz~30MHz | 60 | 50 |
| Remark: (1) *Decreasing linearly with logarithm of the frequency. (2) The lower limit shall apply at the transition frequency. | | | |

3.2. Test Setup

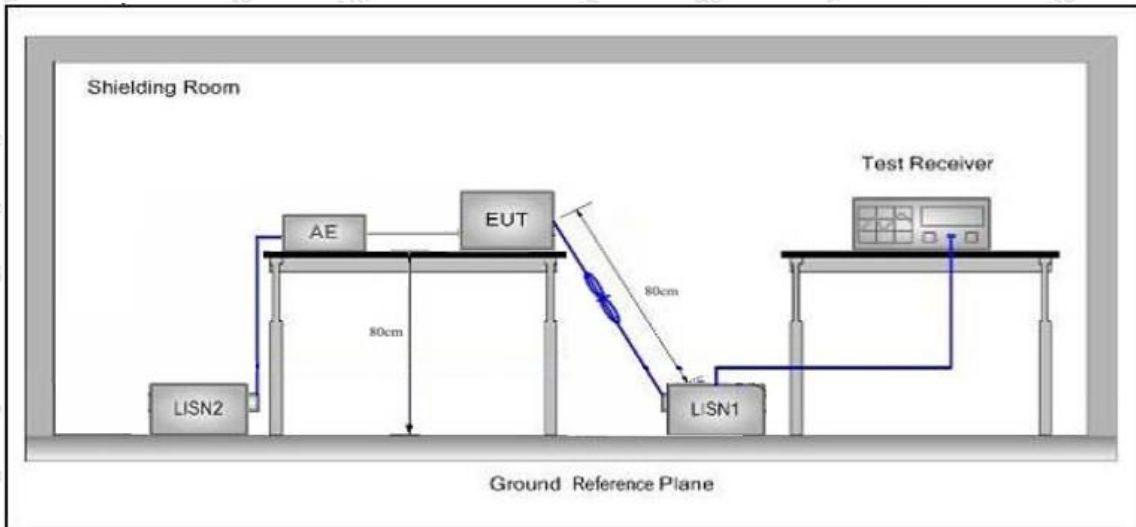

3.3. Test Procedure

The EUT system is connected to the power mains through a line impedance stabilization network (L.I.S.N.). This provides a 50ohm coupling impedance for the EUT system. Please refer the block diagram of the test setup and photographs. Both sides of AC line are checked to find out the maximum conducted emission. In order to find the maximum emission levels, the relative positions of equipment and all of the interface cables shall be changed according to FCC ANSI C63.10-2020 on Conducted Emission Measurement.

The bandwidth of test receiver (ESCI) set at 9kHz.

The frequency range from 150kHz to 30MHz is checked.

3.4. Test Data

Please to see the following pages

Conducted Emission Test Data

Test Site: 1# Shielded Room
 Operating Condition: Mode 1
 Test Specification: AC 120V, 60Hz for adapter
 Comment: Live Line
 Tem.: 22.4°C Hum.: 47%

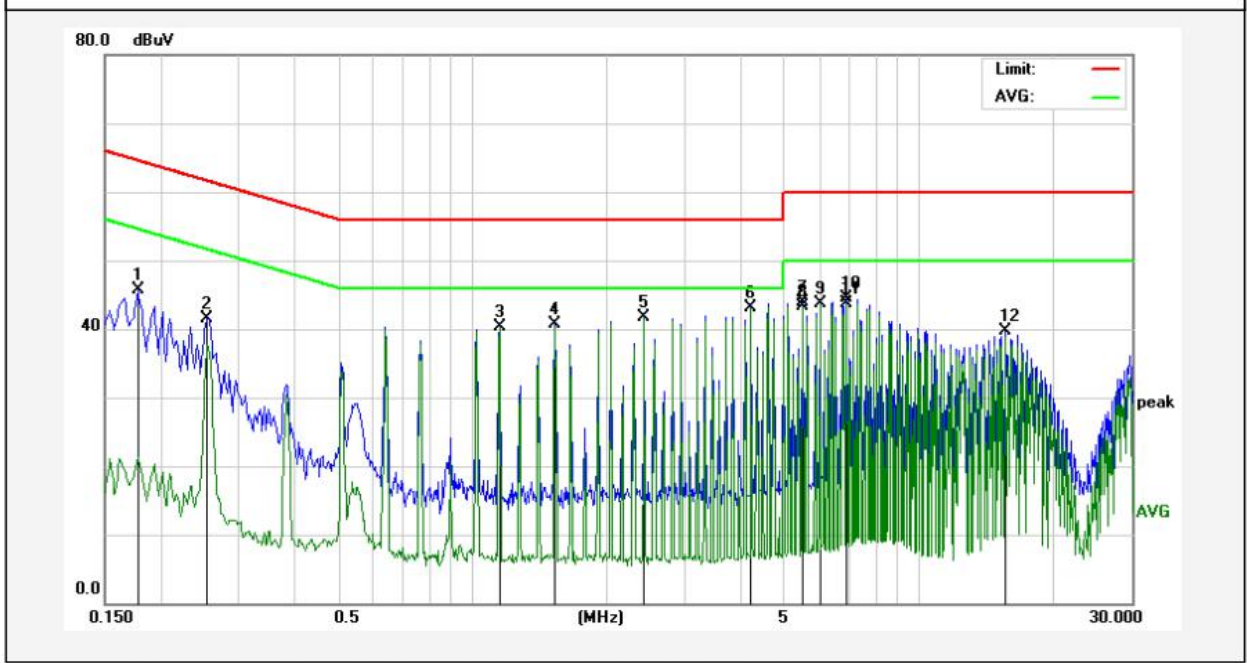

| No. | Freq. (MHz) | Reading (dBuV) | Factor (dB) | Result (dBuV) | Limit (dBuV) | Over Limit (dB) | Detector | Remark |
|-----|-------------|----------------|-------------|---------------|--------------|-----------------|----------|--------|
| 1 | 0.1780 | 45.55 | 0.12 | 45.67 | 64.57 | -18.90 | peak | |
| 2 | 0.2540 | 41.44 | 0.13 | 41.57 | 61.62 | -20.05 | peak | |
| 3 | 1.1500 | 40.14 | 0.15 | 40.29 | 46.00 | -5.71 | AVG | |
| 4 | 1.5339 | 40.54 | 0.13 | 40.67 | 56.00 | -15.33 | peak | |
| 5 | 2.4260 | 41.59 | 0.12 | 41.71 | 46.00 | -4.29 | AVG | |
| 6 | 4.2139 | 42.95 | 0.11 | 43.06 | 46.00 | -2.94 | AVG | |
| 7 | 5.4899 | 43.79 | 0.11 | 43.90 | 60.00 | -16.10 | peak | |
| 8 | 5.4899 | 43.10 | 0.11 | 43.21 | 50.00 | -6.79 | AVG | |
| 9 | 6.0019 | 43.56 | 0.11 | 43.67 | 50.00 | -6.33 | AVG | |
| 10 | 6.8939 | 44.31 | 0.11 | 44.42 | 60.00 | -15.58 | peak | |
| 11 | 6.8939 | 43.54 | 0.11 | 43.65 | 50.00 | -6.35 | AVG | |
| 12 | 15.7059 | 39.58 | 0.17 | 39.75 | 60.00 | -20.25 | peak | |

Conducted Emission Test Data

Test Site: 1# Shielded Room
 Operating Condition: Mode 1
 Test Specification: AC 120V, 60Hz for adapter
 Comment: Neutral Line
 Tem.: 22.4°C Hum.: 47%

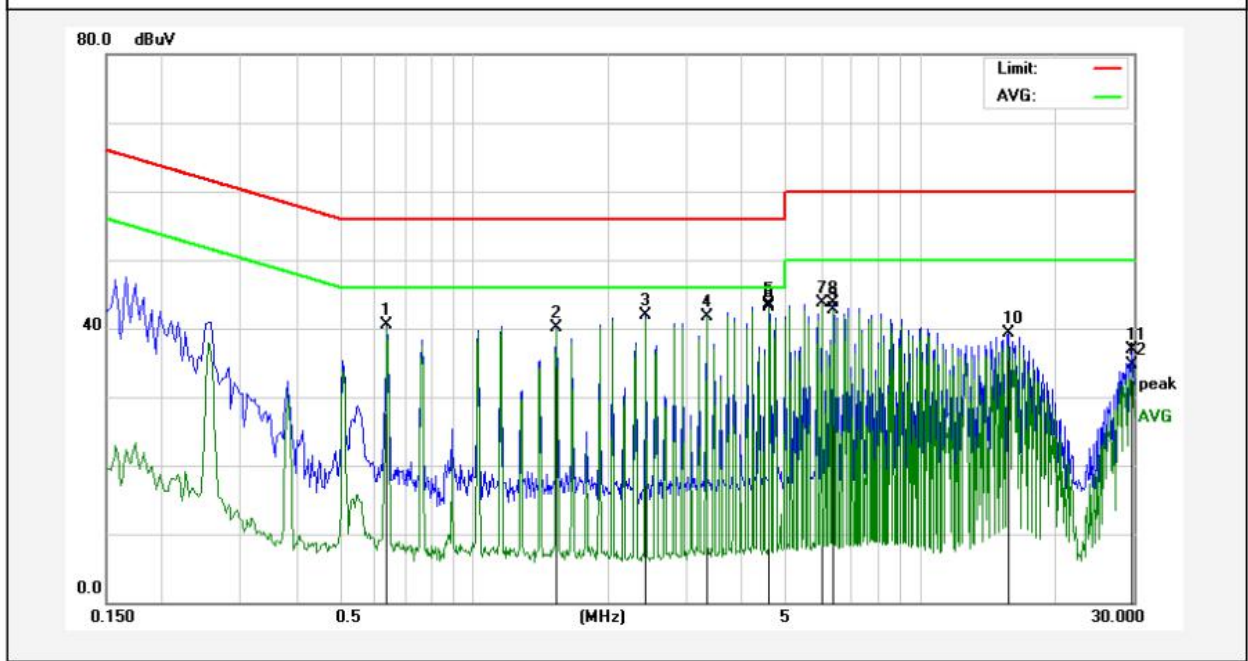

| No. | Freq. (MHz) | Reading (dBuV) | Factor (dB) | Result (dBuV) | Limit (dBuV) | Over Limit (dB) | Detector | Remark |
|-----|-------------|----------------|-------------|---------------|--------------|-----------------|----------|--------|
| 1 | 0.6380 | 40.37 | 0.15 | 40.52 | 56.00 | -15.48 | peak | |
| 2 | 1.5300 | 40.06 | 0.13 | 40.19 | 46.00 | -5.81 | AVG | |
| 3 | 2.4260 | 41.83 | 0.12 | 41.95 | 56.00 | -14.05 | peak | |
| 4 | 3.3180 | 41.68 | 0.12 | 41.80 | 46.00 | -4.20 | AVG | |
| 5 | 4.5939 | 43.48 | 0.11 | 43.59 | 56.00 | -12.41 | peak | |
| 6 | 4.5939 | 42.92 | 0.11 | 43.03 | 46.00 | -2.97 | AVG | |
| 7 | 5.9980 | 43.66 | 0.11 | 43.77 | 50.00 | -6.23 | AVG | |
| 8 | 6.3820 | 43.51 | 0.11 | 43.62 | 60.00 | -16.38 | peak | |
| 9 | 6.3820 | 42.52 | 0.11 | 42.63 | 50.00 | -7.37 | AVG | |
| 10 | 15.7180 | 39.08 | 0.17 | 39.25 | 60.00 | -20.75 | peak | |
| 11 | 29.7460 | 36.64 | 0.36 | 37.00 | 60.00 | -23.00 | peak | |
| 12 | 29.7460 | 34.38 | 0.36 | 34.74 | 50.00 | -15.26 | AVG | |

4. Radiation Spurious Emission

4.1. Test Standard and Limit

| Test Standard | FCC Part15 C Section 15.209 and 15.205 | | | | |
|---------------|--|----------------------------------|----------------|------------|--------------------------|
| Test Limit | Frequency (MHz) | Field strength (microvolt/meter) | Limit (dBuV/m) | Remark | Measurement distance (m) |
| | 0.009MHz~0.490MHz | 2400/F(kHz) | - | - | 300 |
| | 0.490MHz-1.705MHz | 24000/F(kHz) | - | - | 30 |
| | 1.705MHz-30MHz | 30 | - | - | 30 |
| | 30MHz~88MHz | 100 | 40.0 | Quasi-peak | 3 |
| | 88MHz~216MHz | 150 | 43.5 | Quasi-peak | 3 |
| | 216MHz~960MHz | 200 | 46.0 | Quasi-peak | 3 |
| | 960MHz~1000MHz | 500 | 54.0 | Quasi-peak | 3 |
| | Above 1000MHz | 500 | 54.0 | Average | 3 |
| - | | 74.0 | Peak | 3 | |

Remark:

(1)The lower limit shall apply at the transition frequency.

(2) 15.35(b), Unless otherwise specified, the limit on peak radio frequency emissions is 20dB above the maximum permitted average emission limit applicable to the equipment under test. This peak limit applies to the total peak emission level radiated by the device.

4.2. Test Setup

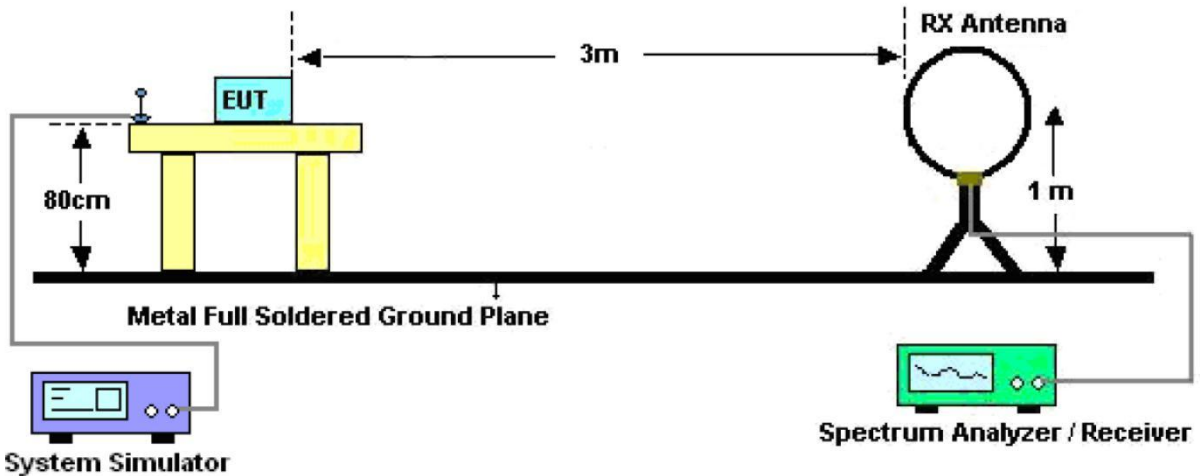

Figure 1. Below 30MHz

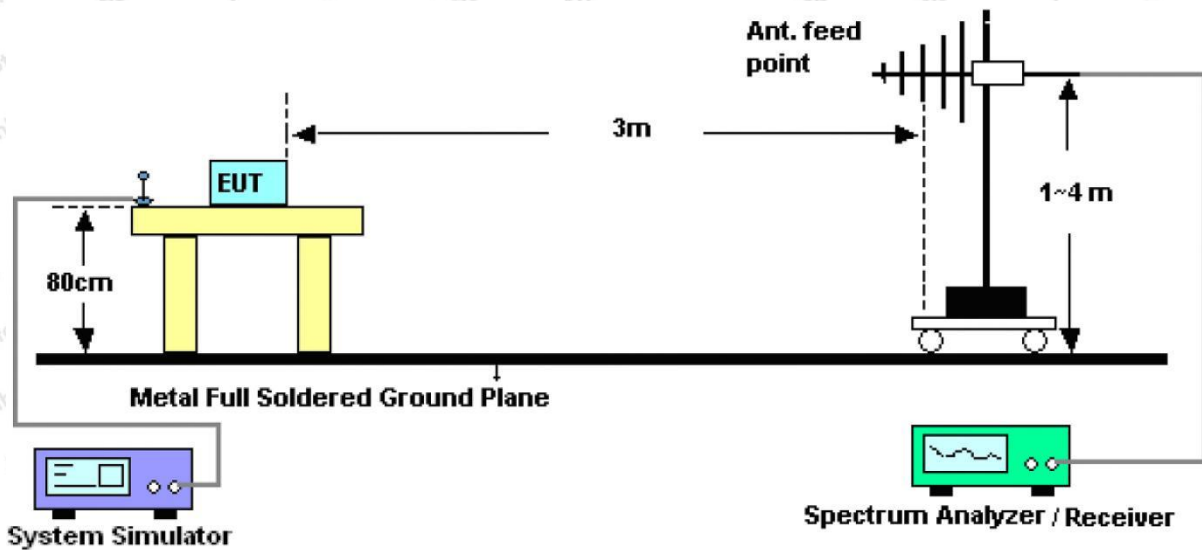

Figure 2. 30MHz to 1GHz

4.3. Test Procedure

For below 1GHz: The EUT is placed on a turntable, which is 0.8m above the ground plane. The turn table can rotate 360 degrees to determine the position of the maximum emission level. The EUT is set 3 meters away from the receiving antenna which is mounted on a antenna tower. The antenna can be moved up and down from 1 to 4 meters to find out the maximum emission level. Rotated the EUT through three orthogonal axes to determine the maximum emissions, both horizontal and vertical polarization of the antenna are set on test. The EUT is tested in 9*6*6 Chamber. The device is evaluated in xyz orientation.

For 9kHz to 150kHz, Set the spectrum analyzer as:

RBW = 200Hz, VBW = 1kHz, Detector= Quasi-Peak, Trace mode= Max hold, Sweep- auto couple.

For 150kHz to 30MHz, Set the spectrum analyzer as:

RBW = 9kHz, VBW = 30kHz, Detector= Quasi-Peak, Trace mode= Max hold, Sweep- auto couple.

For 30MHz to 1000MHz, Set the spectrum analyzer as:

RBW = 100kHz, VBW = 300kHz, Detector= Quasi-Peak, Trace mode= Max hold, Sweep- auto couple.

4.4. Test Data

PASS

Note: The data is in TX mode, and this is the worst mode.

Test Results(9KHz – 30MHz)

Standard: FCC PART15 C_3m **Power Source:** AC 120V, 60Hz for adapter
Test item: Radiation Test **Temp.(C)/Hum.(%RH):** 22.4°C/49%RH
Test Mode: Mode 1 **Distance:** 3m

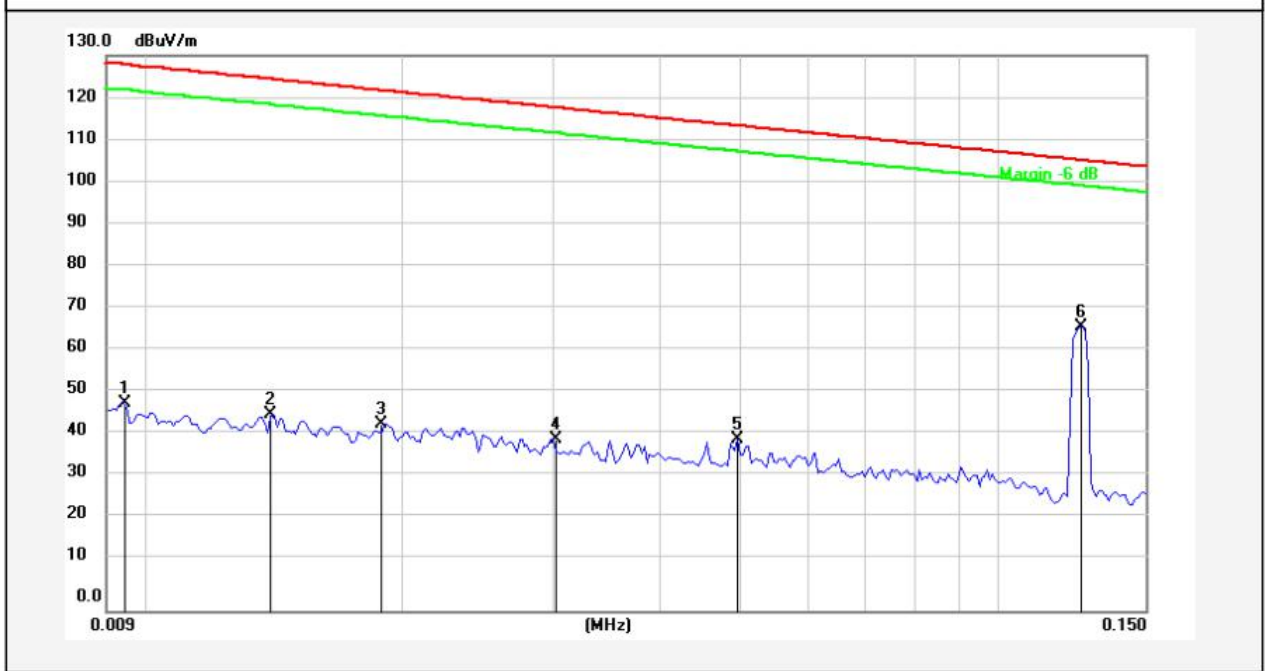

| No. | Freq. (MHz) | Reading (dBuV) | Factor () | Result (dBuV/m) | Limit (dBuV/m) | Over Limit (dB) | Detector | Height (cm) | degree (deg) | Remark |
|-----|-------------|----------------|------------|-----------------|----------------|-----------------|----------|-------------|--------------|--------|
| 1 | 0.0094 | 28.40 | 20.11 | 48.51 | 127.93 | -79.42 | AV | | | |
| 2 | 0.0140 | 25.81 | 20.18 | 45.99 | 124.49 | -78.50 | AV | | | |
| 3 | 0.0189 | 23.56 | 20.31 | 43.87 | 121.90 | -78.03 | AV | | | |
| 4 | 0.0302 | 19.67 | 20.54 | 40.21 | 117.86 | -77.65 | AV | | | |
| 5 | 0.0497 | 19.61 | 20.42 | 40.03 | 113.55 | -73.52 | AV | | | |
| 6 | 0.1250 | 46.03 | 20.33 | 66.36 | 105.59 | -39.23 | AV | | | |

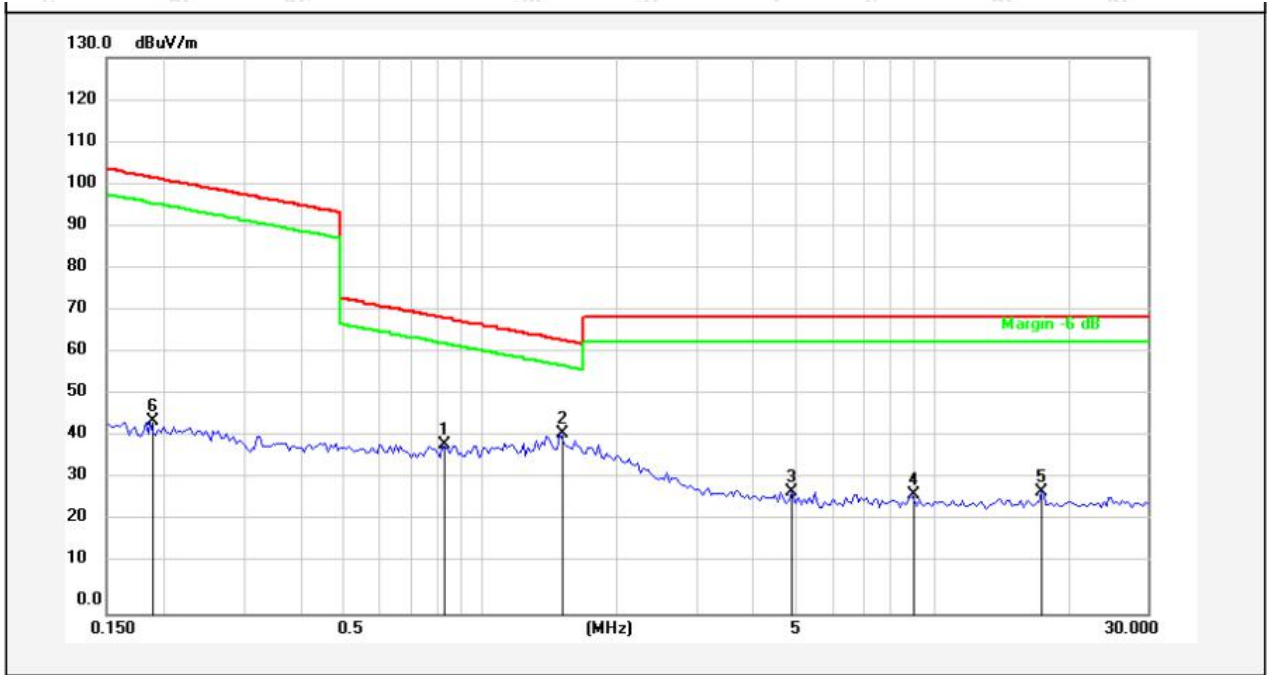

| No. | Freq. (MHz) | Reading (dBuV) | Factor () | Result (dBuV/m) | Limit (dBuV/m) | Over Limit (dB) | Detector | Height (cm) | degree (deg) | Remark |
|-----|-------------|----------------|------------|-----------------|----------------|-----------------|----------|-------------|--------------|--------|
| 1 | 0.8283 | 19.30 | 20.26 | 39.56 | 69.25 | -29.69 | QP | | | |
| 2 | 1.5033 | 21.73 | 20.27 | 42.00 | 64.09 | -22.09 | QP | | | |
| 3 | 4.8867 | 8.12 | 20.42 | 28.54 | 69.50 | -40.96 | QP | | | |
| 4 | 8.9875 | 7.19 | 20.50 | 27.69 | 69.50 | -41.81 | QP | | | |
| 5 | 17.4287 | 7.92 | 20.56 | 28.48 | 69.50 | -41.02 | QP | | | |
| 6 | 0.1879 | 24.76 | 20.32 | 45.08 | 102.07 | -56.99 | QP | | | |

Remark: According to FCC PART 15.209 (d), the emission limits for the frequency bands 9–90 kHz, 110–490 kHz and above 1000 MHz, Radiated emission limits in these three bands are based on measurements employing an average detector.

Test Results(30MHz –1000 MHz)

| | | | |
|-------------------|------------------------|----------------------------|----------------------------------|
| Standard: | FCC PART15 C_3m | Polarization: | Horizontal |
| Test item: | Radiation Test | Power Source: | AC 120V, 60Hz for adapter |
| Test Mode: | Mode 1 | Temp.(C)/Hum.(%RH): | 23.4°C/50%RH |
| Distance: | 3m | | |

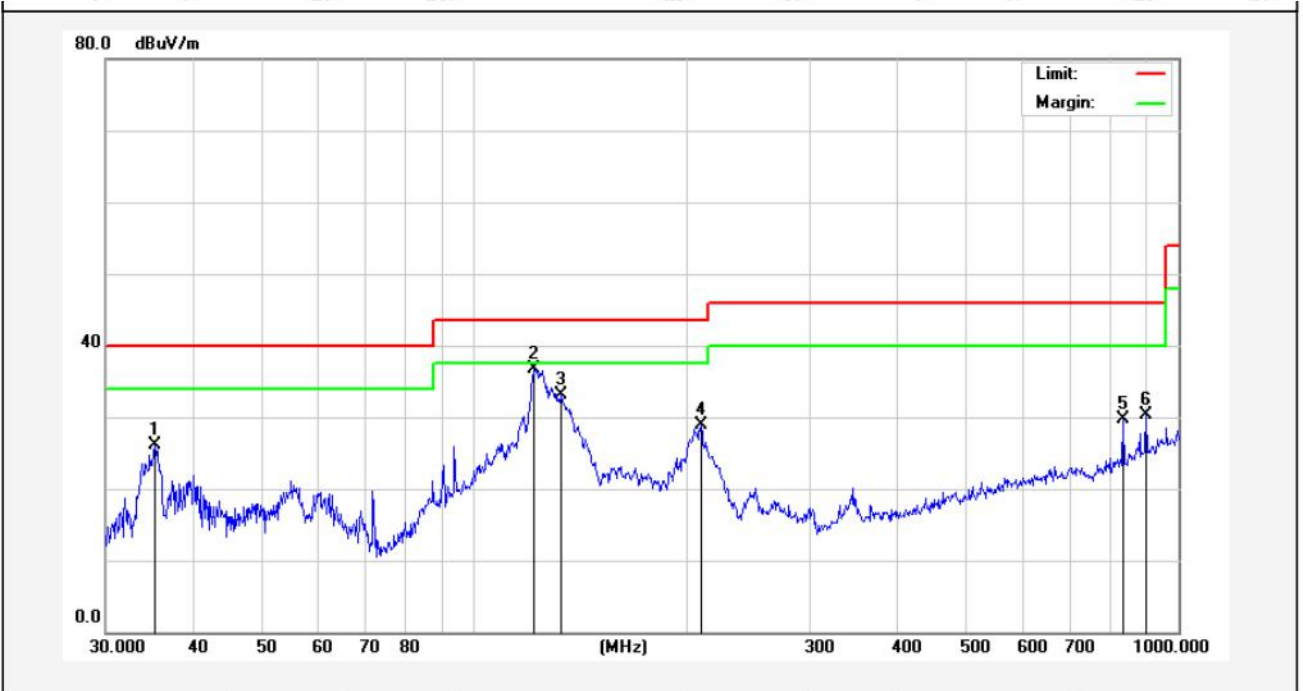

| No. | Freq. (MHz) | Reading (dBuV) | Factor (dB/m) | Result (dBuV/m) | Limit (dBuV/m) | Over Limit (dB) | Detector | Height (cm) | degree (deg) | Remark |
|-----|-------------|----------------|---------------|-----------------|----------------|-----------------|----------|-------------|--------------|--------|
| 1 | 35.2512 | 44.40 | -18.31 | 26.09 | 40.00 | -13.91 | peak | | | |
| 2 | 121.5486 | 60.44 | -23.72 | 36.72 | 43.50 | -6.78 | peak | | | |
| 3 | 132.6850 | 55.71 | -22.66 | 33.05 | 43.50 | -10.45 | peak | | | |
| 4 | 210.0482 | 50.98 | -22.16 | 28.82 | 43.50 | -14.68 | peak | | | |
| 5 | 833.3171 | 37.49 | -7.74 | 29.75 | 46.00 | -16.25 | peak | | | |
| 6 | 900.1474 | 36.54 | -6.22 | 30.32 | 46.00 | -15.68 | peak | | | |

Standard: FCC PART15 C _3m **Polarization:** Vertical
Test item: Radiation Test **Power Source:** AC 120V, 60Hz for adapter
Test Mode: Mode 1 **Temp.(C)/Hum.(%RH):** 23.4°C/50%RH
Distance: 3m

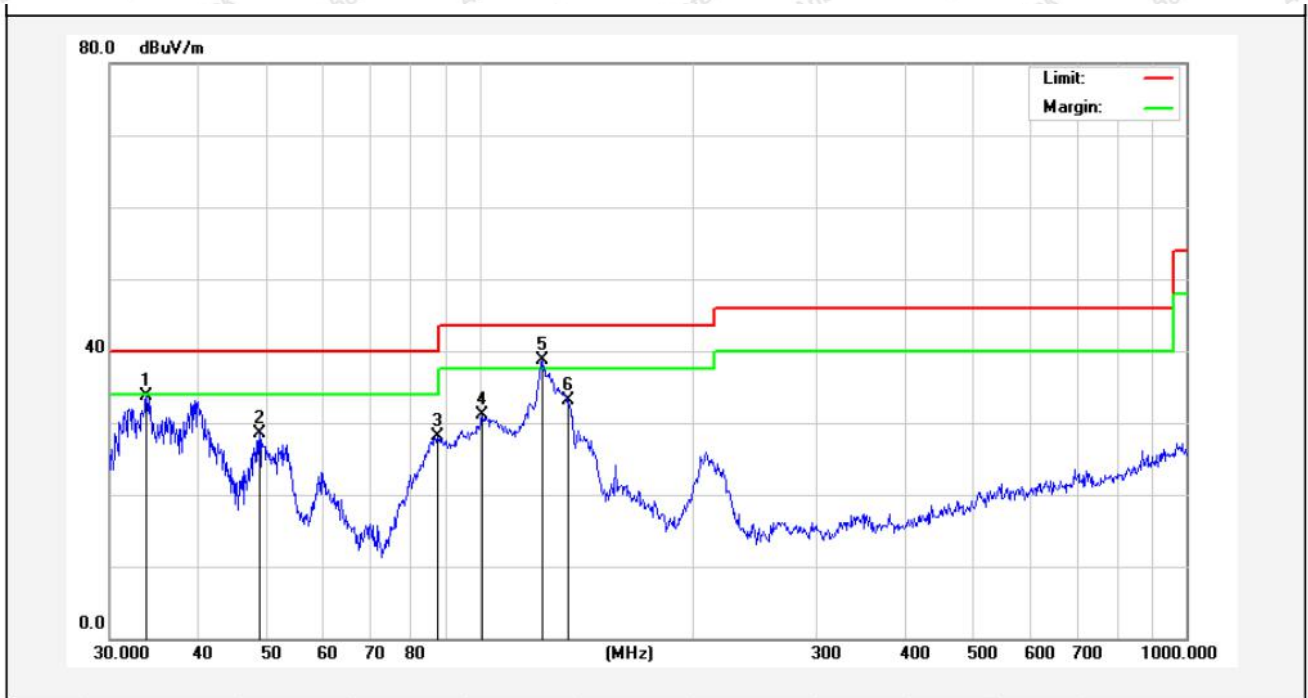

| No. | Freq. (MHz) | Reading (dBuV) | Factor (dB/m) | Result (dBuV/m) | Limit (dBuV/m) | Over Limit (dB) | Detector | Height (cm) | degree (deg) | Remark |
|-----|-------------|----------------|---------------|-----------------|----------------|-----------------|----------|-------------|--------------|--------|
| 1 | 33.7986 | 50.97 | -17.34 | 33.63 | 40.00 | -6.37 | peak | | | |
| 2 | 48.8429 | 44.05 | -15.60 | 28.45 | 40.00 | -11.55 | peak | | | |
| 3 | 87.1117 | 46.18 | -18.13 | 28.05 | 40.00 | -11.95 | peak | | | |
| 4 | 100.9339 | 47.89 | -16.72 | 31.17 | 43.50 | -12.33 | peak | | | |
| 5 | 122.8340 | 59.10 | -20.36 | 38.74 | 43.50 | -4.76 | peak | | | |
| 6 | 133.6188 | 54.76 | -21.73 | 33.03 | 43.50 | -10.47 | peak | | | |

5. Antenna Requirement

5.1. Test Standard and Requirement

| | |
|---------------|--|
| Test Standard | FCC Part15 Section 15.203 |
| Requirement | An intentional radiator shall be designed to ensure that no antenna other than that furnished by the responsible party shall be used with the device. The use of a permanently attached antenna or of an antenna that uses a unique coupling to the intentional radiator, the manufacturer may design the unit so that a broken antenna can be replaced by the user, but the use of a standard antenna jack or electrical connector is prohibited. |

5.2. Antenna Connected Construction

The antenna is a Inductive loop coil Antenna which permanently attached, and the best case gain of the antenna is 0 dBi. It complies with the standard requirement.

APPENDIX I -- TEST SETUP PHOTOGRAPH

Photo of Conducted Emission Measurement



Photo of Radiation Emission Test





APPENDIX II -- EXTERNAL PHOTOGRAPH





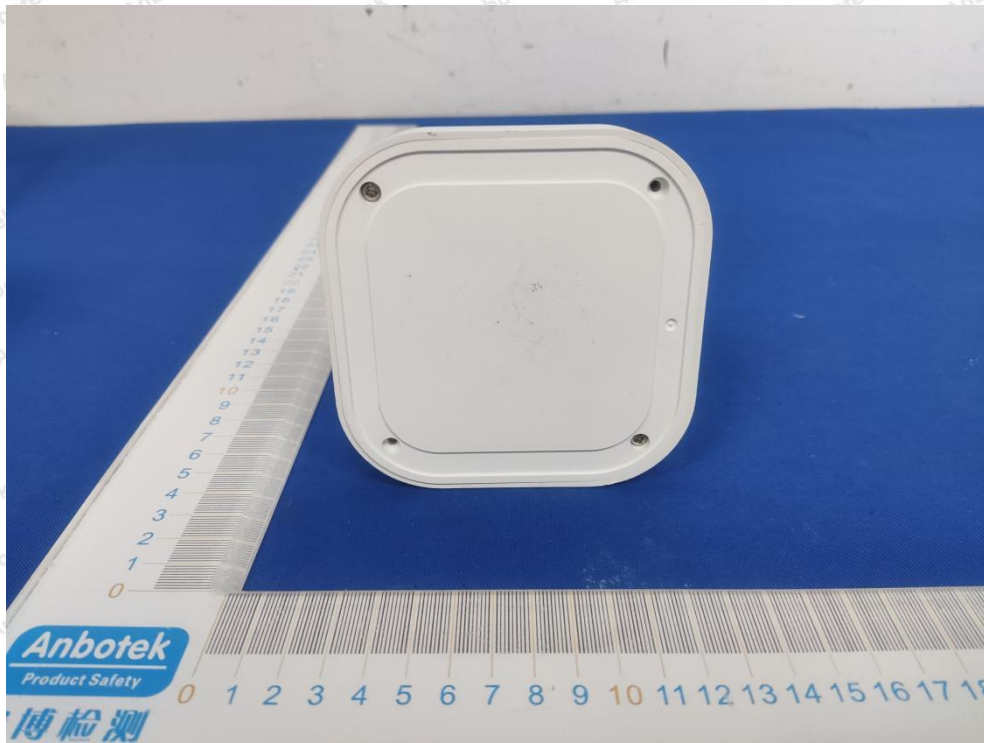

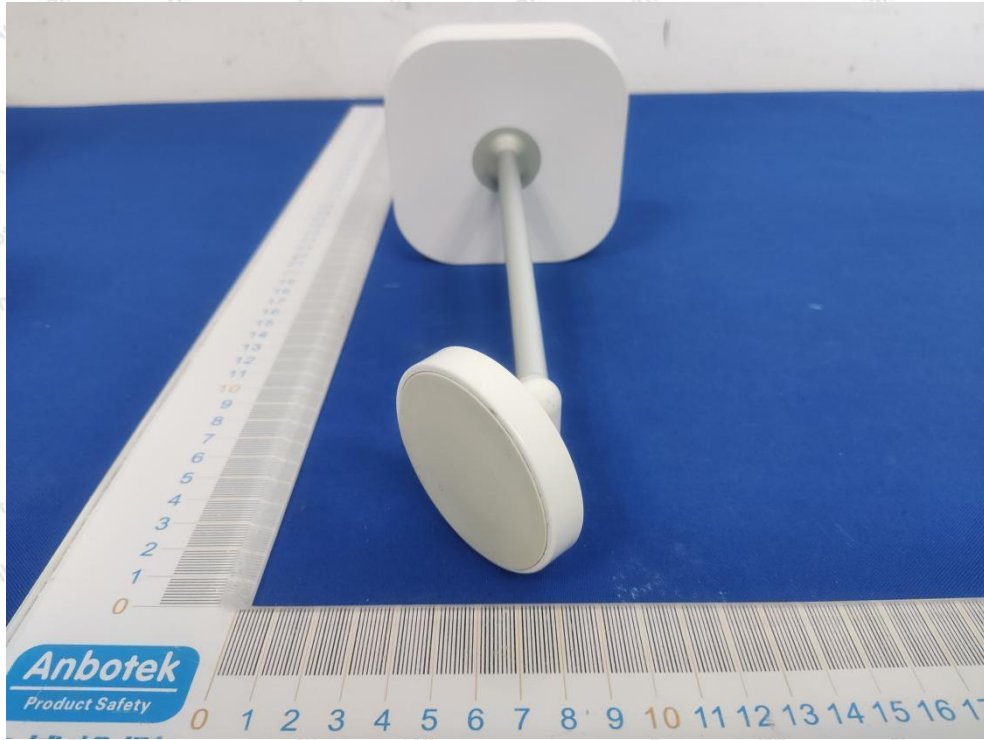

APPENDIX III -- INTERNAL PHOTOGRAPH

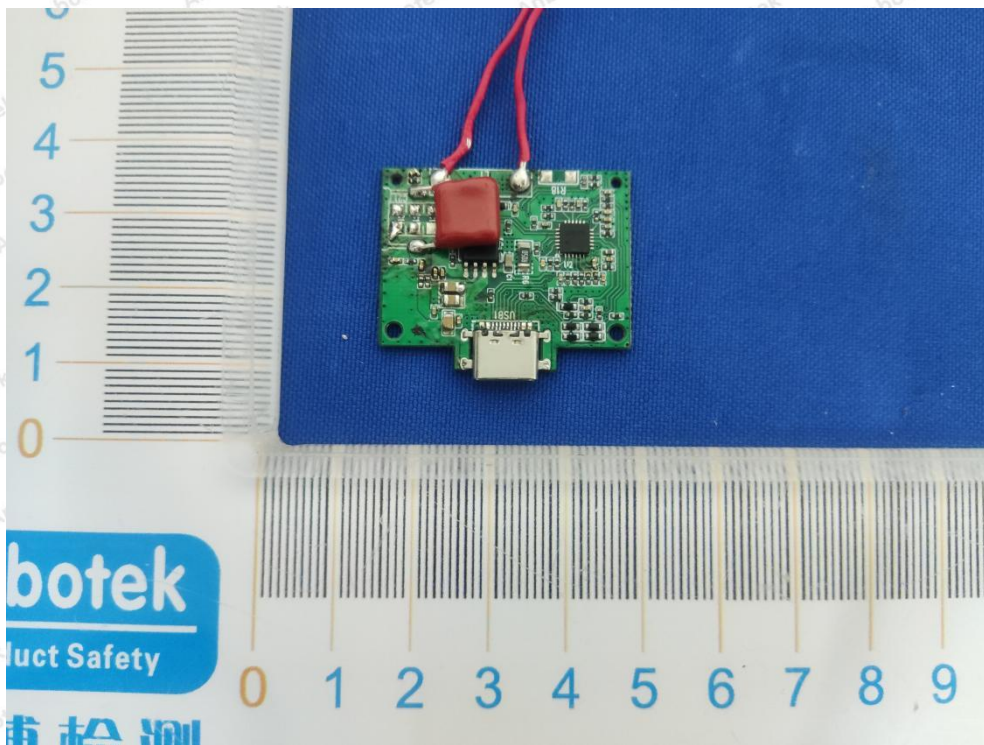
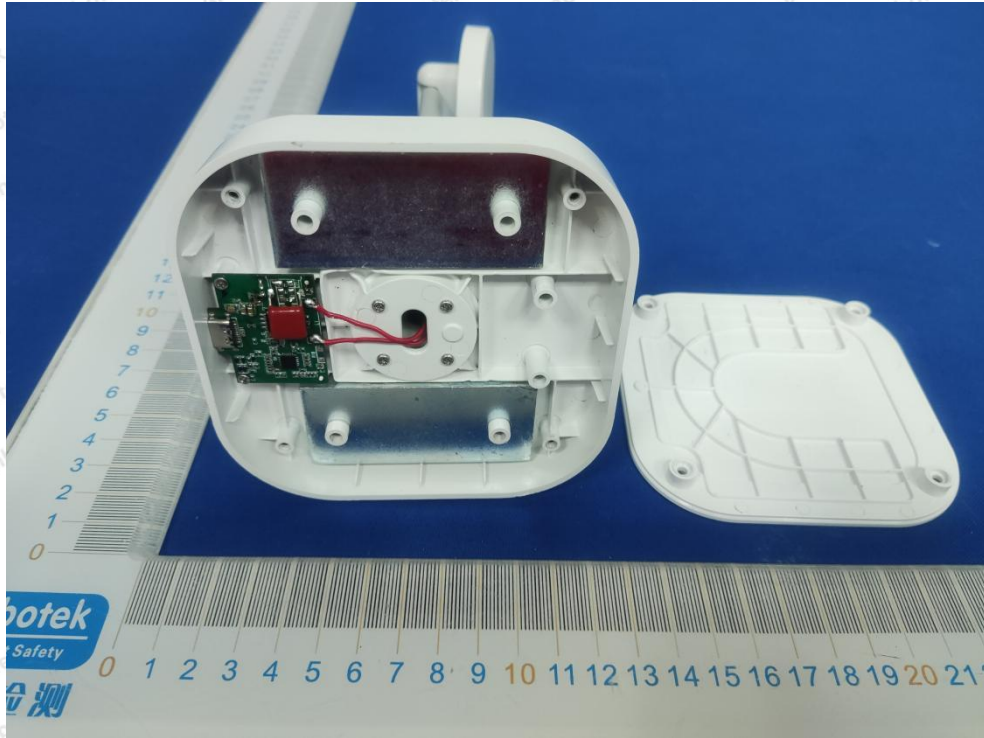

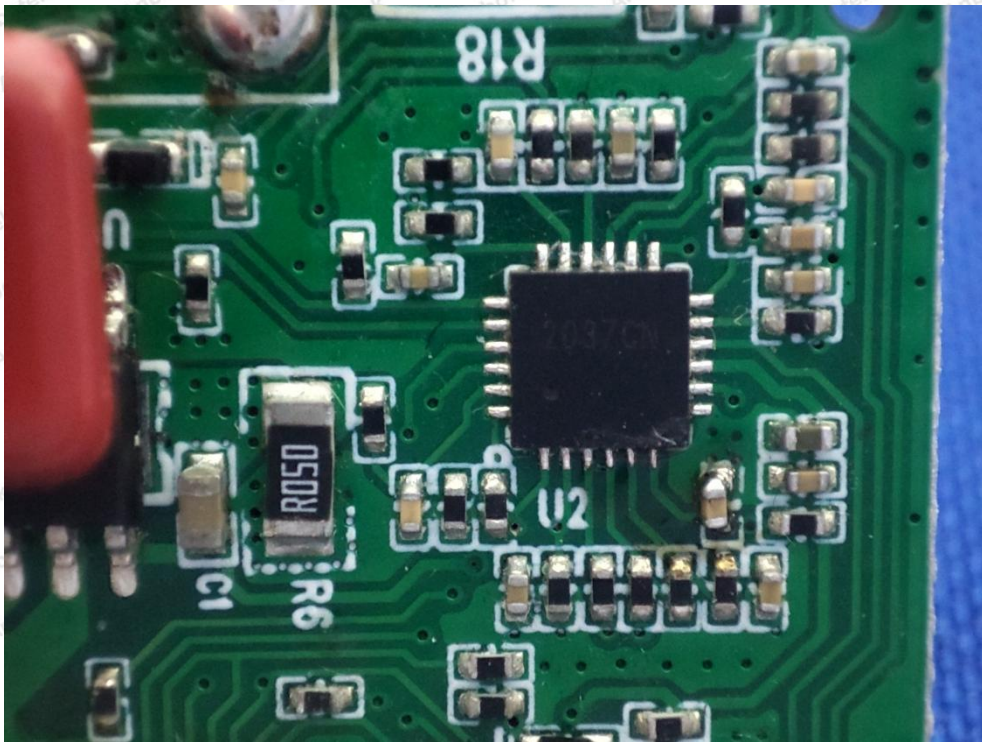
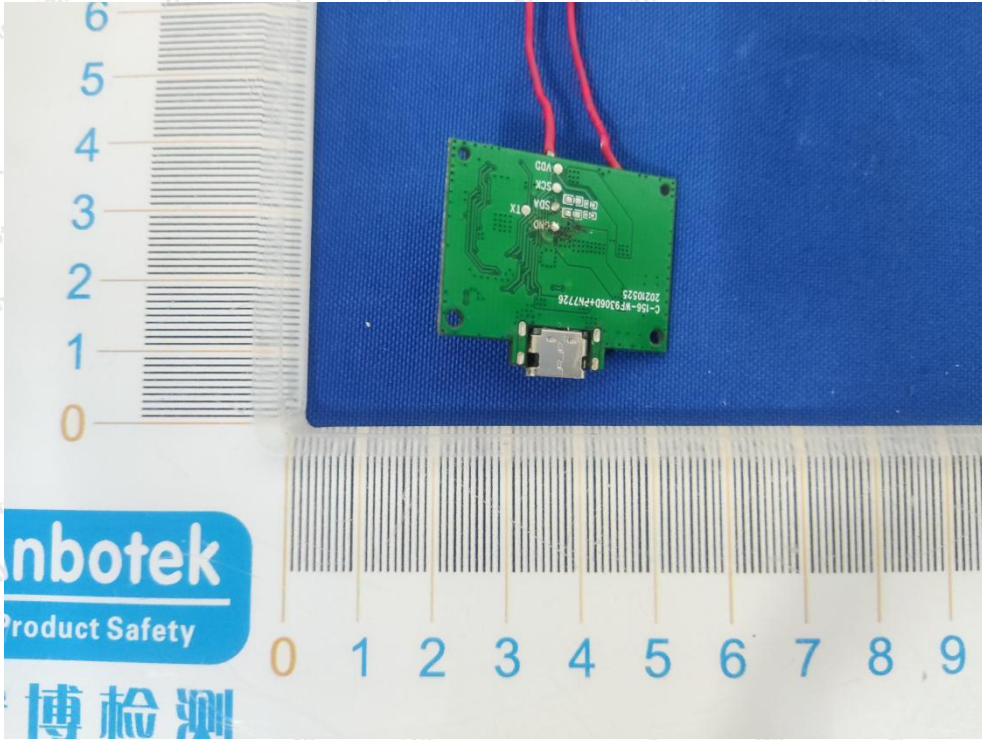

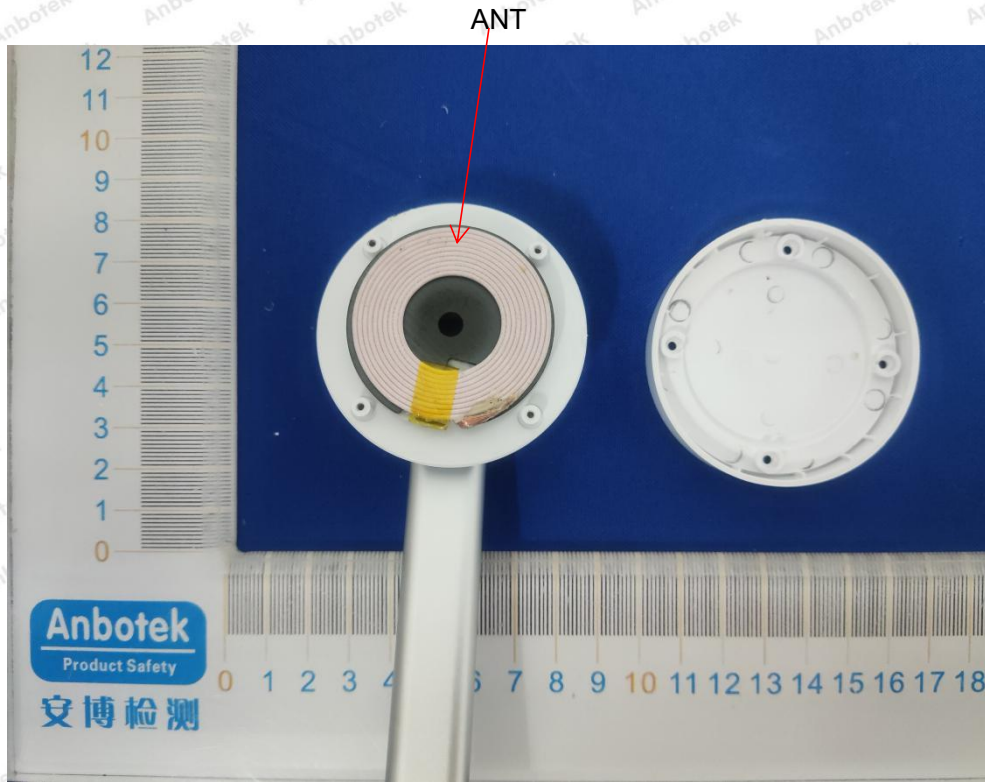

----- End of Report -----