



Radio



**Duplex Cross Band Repeater
(V-U or U-V)**

Same-Band/Cross-Band Simultaneous Reception
Scrambler/Compander



Made by: Quanzhou Wouxun Electronics Co., Ltd.
Add: #38 Yuantai 1st Road, Jiangnan High Technology Industry Park,
Licheng District, Quanzhou 362000, Fujian, China
[Http://www.wouxun.com](http://www.wouxun.com)



ISO9001:2015

Certificate No.:00118Q39964R4M/5100



ISO14001:2015

Certificate No.:00118E33425R3M/5100

USER'S MANUAL

Thanks for buying the transceiver.

This transceiver offers latest design, enhanced features, solid performances and easy accessibility. We believe you will be pleased with the high quality and reliable features for all your communication needs.

READ THIS IMPORTANT INFORMATION ON THE SAFE AND EFFICIENT OPERATION BEFORE USING PORTABLE TRANSCEIVER.

Contents

Installing Before Use	01
Getting Started	02-07
Description of Features	02-03
Specifications	04
Description of Transceiver	05-07
Description of Functions	08-11
Multi Operation Modes	08
Basic Operation	08-11
Shortcut Operation Sheet	12-17
How to Operate	18-53
Step Frequency (STEP) ----- MENU 1	18
Squelch Level (SQL-LE) ----- MENU 2	18-19
Power Saver Mode (SAVE) ----- MENU 3	19
Transmitting Power Selection (TXP) ----- MENU 4	19
Begin/End Transmitting Prompt (ROGER) ----- MENU 5	20
Time-out Timer (TOT) ----- MENU 6	20
VOX (VOX) ----- MENU 7	20-21
Bandwidth Selection (W/N) ----- MENU 8	21

Voice Guide (VOICE) ----- MENU 9	21
Transmitting Overtime Alarm (TOA) ----- MENU 10	22
Beep Prompt Function (BEEP) ----- MENU 11	22
Display Language (Language) ----- MENU 12	23
Busy Channel Lockout (BCL) ----- MENU 13	23
Scan Mode (SC-REV) ----- MENU 14	23-24
Receiving CTCSS (R-CTC) ----- MENU 15	24
Transmitting CTCSS (T-CTC) ----- MENU 16	25
Receiving DCS (R-DCS) ----- MENU 17	25
Transmitting DCS (T-DCS) ----- MENU 18	25-27
CALL/VFTX on Side Key 1 (PF1) ----- MENU 19	27
SCAN/LAMP/SOS-CHTELE-ALARM/RADIO/DISABLE on Side Key 3 (PF3) ----- MENU 20	28-30
Working Mode Switch (CH-MDF) ----- MENU 21	30-31
Auto Backlight (ABR) ----- MENU 22	31
Offset Frequency (OFF-SET) ----- MENU 23	31
Frequency Shift Direction (SFT-D) ----- MENU 24	32
Stopwatch Timer (SECOND) ----- MENU 25	32-33
Channel Name Edit (CHNAME) ----- MENU 26	33

Contents

<i>Channel Memory (MEM-CH) ----- MENU 27</i>	34-35
<i>Channel Delete (DEL-CH) ----- MENU 28</i>	35
<i>Scan CTCSS/DCS (SCN-CTC) ----- MENU 29</i>	36
<i>Power-ON Message(PONMSG) ----- MENU 30</i>	36-37
<i>Mute Mode (SP-MUTE) ----- MENU 31</i>	37-38
<i>Caller ID Code Switch (ANI-SW) ----- MENU 32</i>	38
<i>Caller ID Code Edit (ANI-EDIT) ----- MENU 33</i>	38-39
<i>DTMF Sidetone (DTMF-ST) ----- MENU 34</i>	39-40
<i>Keypad Autolock (AUTOLOCK) ----- MENU 35</i>	40
<i>Priority Channel Switch (PRI CH-SW) ----- MENU 36</i>	40-41
<i>Repeater Setting (RPT-SET) ----- MENU 37</i>	41-44
<i>Repeater Speaker (RPT-SPK) ----- MENU 38</i>	45
<i>Repeater PTT (RPT-PTT) ----- MENU 39</i>	45
<i>Scan Add (SCAN-ADD) ----- MENU 40</i>	45
<i>Single-Tone Pulse Frequency (ALERT) ----- MENU 41</i>	46
<i>PTT ID Delay (PTT-DLY) ----- MENU 42</i>	46
<i>PTT Caller ID Modes (PTT-ID) ----- MENU 43</i>	46-47
<i>Ring Time (RING) ----- MENU44</i>	47

<i>Scan Channel Group A (SCG-A) ----- MENU 45</i>	47
<i>Scan Channel Group B (SCG-B) ----- MENU 46</i>	48
<i>Repeater Receipt Tone (RPT-TONE) ----- MENU47</i>	48
<i>Saving Scanned CTCSS/DCS(SC-QT) ----- MENU 48</i>	48-49
<i>Mute Setting on Sub-frequency (SMUTESET) ----- MENU 49</i>	49
<i>Selective Call Code Group Setting (CALLCODE) ----- MENU 50</i>	50
<i>Reset Setting(RESET) ----- MENU 51</i>	50
<i>Setting Backlight(BK-LIGHT)----MENU52</i>	51
<i>Radio Storage(RADIO-WR)----MENU53</i>	51
<i>Scrambler(SCRAM)----MENU54</i>	52
<i>Compander(COMPANDER)---MENU55</i>	52
<i>Backlight(COLOR)--MENU 56</i>	53
Detailed Instruction for Some Important Functions	54-58
<i>All Calls,Group Calls and Selective Calls</i>	54-56
<i>Repeater Usage</i>	56-58
Troubleshooting	59-60
Announcement	61

Installing before use

■ Install / remove batterypack

The batterypack is not fully charged before leaving factory. Please charge it before use.

NOTE

- » Do not shortcircuit the terminals or put the batterypack into fire.
- » Do not try to remove the case from the batterypack.

1. Please aim the batterypack at the back of the transceiver, and then push up and press down the batterypack to lock the release latch. (PIC1)
2. If you want to remove the batterypack, push down the release latch, and the batterypack will be released from the transceiver. (PIC2)

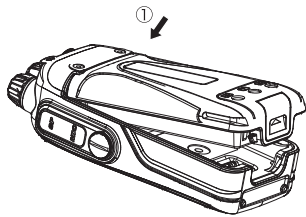

PIC1

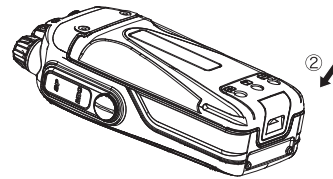

PIC2

Getting Started

Description of Features

1. Duplex Repeater (VHF to UHF or UHF to VHF)
2. Duplex Work Mode (TX on one area while RX on the other area simultaneously)
3. Dual Receiving (RX on the same/different bands of A&B areas simultaneously)
4. Large Colorful Screen
5. Dual Display
Dual Band Display on Large Screen, Two Independent Operation System
6. Frequency Offset and Direction Programmable in Repeater Mode
UHF/VHF or VHF/UHF Cross-Band Repeater
7. 999 Memory Channels
8. Strong and Stable Output Power
9. QT/DQT Encoding/Decoding, QT/DQT Scan
10. VOX
11. Multi Definition for Sidekeys
12. Incoming Message Display
Caller ID display
13. DTMF Encoding&Decoding
14. All Calls, Group Calls And Selective Calls
15. SOS Function
16. Priority Scan Function

Getting Started

17. Remote Alarm
18. Wide/Narrow Bandwidth Selection (25KHz/12.5KHz)
19. Voice Guide: Chinese/English
20. Chinese/English Screen Display
21. Bright Flashlight Illumination
22. Single-Tone Pulse Frequency: 2100Hz/1750Hz/1000Hz/1450Hz (signalling for activating repeater)
23. Reverse Frequency
24. Stopwatch
25. Scrambler
26. Setting for Backlight
27. Componder

Specifications

Intergration		Receiving	Wide bandwidth	Narrow bandwidth
Frequency Range	RX: 136-174MHz; 400-480MHz TX: 144-148MHz; 420-450MHz	Adjacent Channel Selectivity	< 70dB	< 60dB
Step	5KHz / 6.25KHz / 10KHz / 12.5KHz / 25KHz / 50KHz / 100KHz	Inter Modulation	< 65dB	< 60dB
Channel Number	999	Spurious Response	< 70dB	< 70dB
Work Mode	F2D / F3E	Audio Response	+1~3dB (0.3~3KHz)	+1~3dB(0.3 ~2.55KHz)
Operating Temperature	-20℃ or 40℃	Signal to Noise Ratio	≥ 45dB	≥ 40dB
Antenna Resistance	50Ω	Audio Distortion	≤ 5%	
Voltage	7.4VDC	Audio Power	Transceiver ≤ 500mW	
Weight	490g	Sensitivity	UHF/VHF: 0.25μV(12dB SINAD)	
Size	124.5x 61.49 x 33.88 (mm)			

Transmitter	Wide bandwidth	Narrow bandwidth	Transmitter	Wide bandwidth	Narrow bandwidth
Type of Modulation	16K F3E	11K F3E	Audio Response	+1~3dB (0.3~3KHz)	+1~3dB (0.3~2.55KHz)
Adjacent Channel Power	> 70dB	> 60dB		Frequency Stability	± 2.5ppm
Spurious	> 60dB	> 60dB	Audio Distortion	< 5%	
Max Frequency Deviation	± 5KHz	± 2.5KHz			

Getting Started

Description of Transceiver

LCD Display

There are various indicators display on the screen when powering on. Please refer the below table to learn what the indicators stand for accordingly.

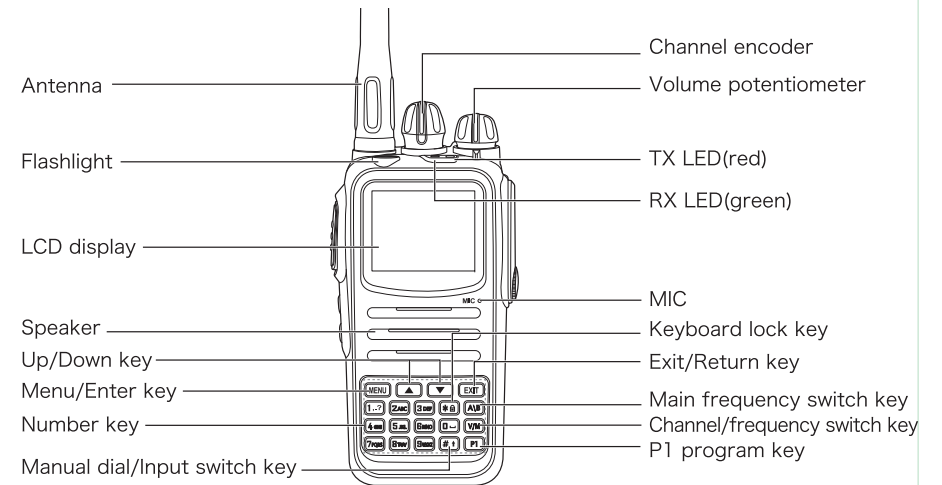
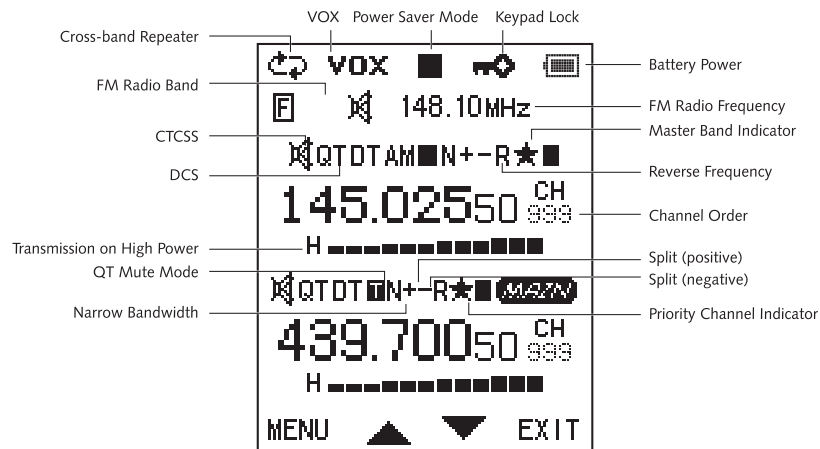

Note: In editing text message and name:

1. A/B key and V/M key can move the cursor up and down.
2. * key can clear the edited characters.
3. Up/down key can switch up/down row.

Getting Started

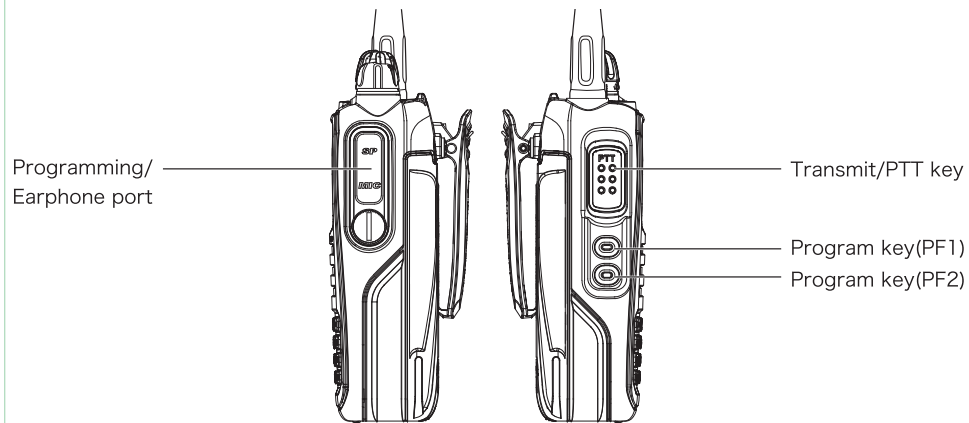

Note: Following function with program key:

All alert ON/OFF, Emergency mode ON/OFF, High/Low power select, Monitor, Temporary deletion of noise channels, One-touch 1-6, Repeat/Talkaround, Scan ON/OFF, Encrypt ON/OFF, VOX ON/OFF, Switch area, Battery voltage indicator, Lone worker ON/OFF, Flashlight ON/OFF, Exit call.

Description of Functions

Multi Work Modes

- Normal transceiver's communication mode
- Directional cross-band repeater mode or two way cross-band repeater mode

Note: Work modes can be switched via **RPT** key.

- There are A and B areas on the LCD screen to display two bands' status. The master band is with a sign "MAIN" on the top right. This is an important sign, since all the below operation instruction are for the master band. The band without this sign is called "Sub-band".
- Specifications on A&B bands can be programmed separately. Please set the band that you want to program any specifications into as the master band firstly.
- Some functions are not allowed to be used under directional cross-band repeater or two way cross-band repeater mode.

Basic operation

■ Quick Search

Short press **▲** or **▼** key to search the desired function/parameter during your setting, while long press to quick search.

■ DTMF encoding

This transceiver has DTMF encoding. By pressing the right number key on transmitting you can choose

Description of Functions

the right DTMF tone which you want to TX. Number key and corresponding DTMF encoding are as follows:

MENU	▲	▼	EXIT		A	B	C	D
1 STEP	2 SQL	3 SAVE	*SCAN	A/B	1	2	3	*
4 EXP	5 CHGSEL	6 TOP	0	V/M	4	5	6	0
7 VOX	8 WIN	9 LIDS	# LOCK	P1	7	8	9	#

Setting Reverse Frequency Function

When the reverse frequency function is activated, the transmitting and receiving frequencies can be exchanged. And the CTCSS/DCS encoding and decoding can also be exchanged.

How to operate reverse frequency function:

In standby mode, long press ***SCAN** to turn on the reverse frequency function; long press ***SCAN** again to turn off.

Working Mode Switch

Two work modes: VFO(Frequency) mode and MR(Channel) mode. Three different display manners for MR mode.

A. Channel NO. B. Frequency+Channel NO. C. Channel Name

It is available to switch between the frequency mode and the channel mode manually or via the programming software. If you want, you can set the password for the mode switch.

VFO/MR(Frequency/Channel switch) switch is indicated as following:

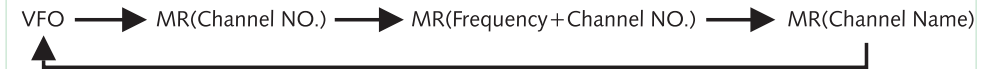

When you set password for switching work mode, press **V/M**, LCD screen display , please input the correct password and press **MENU**. If inputting the wrong password, the work mode switch can not be workable. Password only can be programmed via supplied programming software.

When the password is made up of full "ZERO", the work mode switch does not require password.

Wire Clone Function

Using wireclone	<ol style="list-style-type: none"> 1.Installing the battery for source transceiver and target transceiver. 2.Powering on target transceiver. 3.Press PF3 of source transceiver, and power on at the same time. 4.Red LED of the source radio flashes, the cloning activates 	<p>LED is flashing red during cloning. LED goes out in case of successful cloning. LED glows continuous red in case of cloning failure.</p>
	Target Transceiver	<p>Green indicator is flashing during cloning. Indicator is off when completing cloning.</p>

Description of Functions

How to use the intelligent charger

When the battery power is low, the transceiver will activate voice guide, and prompt "Di" in every 5 seconds.

1. Insert the AC plug into outlet (AC:90-240V), the charger indicator flashes once. That means the charging is in standby.
2. Insert the battery into the charger, the RED indicator continuously flashes. That means the charging is on the progress.
While the GREEN indicator continuously flashes. That means the charging is complete.

NOTE

- » When inserting the exhausted battery into the charger, it will pre-charge the battery in trickling mode, the RED light of charger flashes and lasts 10-20 minutes, then start normal charger with RED light keeping on, it will turn to GREEN when it is fully charged.
- » Trickle charge the exhausted battery is to protect the lithium-ion battery.

Function order	Function name	Enter function set	Screen display	Select parameter	Selectable parameter explanation	Confirm	Return to standby	See page
1	Step Frequency	MENU → 1 STEP	STEP MAN 1 H	MENU → Press ▲ or ▼ key Select parameter	8 frequency steps available: 5k/6.25k/10k/12.5k/50k/ 100k	MENU	EXIT	P19
2	Squelch Level	MENU → 2 SQL	SQL - LE MAN 2 H	MENU → Press ▲ or ▼ key Select parameter	Squelch level from 0 to 9	MENU	EXIT	P19-20
3	Power Saver Mode	MENU → 3 SAVE	SAVE MAN 3 H	MENU → Press ▲ or ▼ key Select parameter	ON: Activate OFF: Deactivate	MENU	EXIT	P20
4	Transmitting Power Selection	MENU → 4 TXP	TXP MAN 4 H	MENU → Press ▲ or ▼ key Select parameter		MENU	EXIT	P20-21
5	Begin/End Transmitting Prompt	MENU → 5 ROGER	ROGER MAN 5 H	MENU → Press ▲ or ▼ key Select parameter	OFF: turn off this function, without any voice prompting. BOT: press PTT, voice prompt when beginning transmitting EOT: release PTT, voice prompt when ending transmitting BOTH: press and release PTT, voice prompt	MENU	EXIT	P21
6	Time-out Timer	MENU → 6 TOT	TOT MAN 6 H	MENU → Press ▲ or ▼ key Select parameter	TOT has 40 levels in steps of 19 seconds. OFF: Turn off TOT	MENU	EXIT	P21
7	VOX	MENU → 7 VOX	VOX MAN 7 H	MENU → Press ▲ or ▼ key Select parameter	VOX has levels from 1 to 9 OFF: Turn off VOX transmission	MENU	EXIT	P22
8	Bandwidth Selection	MENU → 8 WBN	WBN MAN 8 H	MENU → Press ▲ or ▼ key Select parameter	WIDE: 25KHz NARR: 12.5KHz	MENU	EXIT	P22

Shortcut Operation Sheet

9 Voice Guide	MENU → 9 VOICE	VOICE ^{MAN 9} _H	MENU → Press ▲ or ▼ key Select parameter	CHINESE: Chinese voice prompt ENGLISH: English voice prompt OFF: Turn off voice prompt	MENU → EXIT P22-23
10 Transmitting Overtime Alarm	MENU → 1 STEP 0	TOA ^{MAN 10} _H	MENU → Press ▲ or ▼ key Select parameter	ON: Activate OFF: Deactivate	MENU → EXIT P23
11 Beep Prompt	MENU → 1 STEP 1 STEP	BEEP ^{MAN 11} _H	MENU → Press ▲ or ▼ key Select parameter	ON: Turn on beep prompt function OFF: Turn off beep prompt function	MENU → EXIT P23-24
12 Display Language	MENU → 1 STEP 2 SQL	LANGUAGE ^{MAN 12} _H	MENU → Press ▲ or ▼ key Select parameter	CHINESE ENGLISH	MENU → EXIT P24
13 Busy Chann Lockout	MENU → 1 STEP 3 SAVE	BCL ^{MAN 13} _H	MENU → Press ▲ or ▼ key Select parameter	ON: Turn on BCL OFF: Turn off BCL	MENU → EXIT P24
14 Scan Mode	MENU → 1 STEP 4 TXP	SC-REV ^{MAN 14} _H	MENU → Press ▲ or ▼ key Select parameter	3 Kinds of Scan modes TO: Time scanning mode CO: Carrier mode scan SE: Search mode scan	MENU → EXIT P24-25
15 Receiving CTCSS	MENU → 1 STEP 5 ROGER	R-CTC ^{MAN 15} _H	MENU → Press ▲ or ▼ key Select parameter	50 groups CTCSS (67.0Hz-254.1Hz) OFF: Turn off CTCSS	MENU → EXIT P25
16 Transmitting CTCSS	MENU → 1 STEP 6 TOT	T-CTC ^{MAN 16} _H	MENU → Press ▲ or ▼ key Select parameter	50 groups CTCSS (67.0Hz-254.1Hz) OFF: Turn off CTCSS	MENU → EXIT P26
17 Receiving DCS	MENU → 1 STEP 7 VOX	R-DCS ^{MAN 17} _H	MENU → Press ▲ or ▼ key Select parameter	105 groups DCS (D023N-D754I) OFF: Turn off DCS	MENU → EXIT P26
18 Transmitting DCS	MENU → 1 STEP 8 WIN	T-DCS ^{MAN 18} _H	MENU → Press ▲ or ▼ key Select parameter	105 groups DCS (D023N-D754I) OFF: Turn off DCS	MENU → EXIT P26-28
19 Side Key Setting	MENU → 1 STEP 9 VOICE	PF1-KEY ^{MAN 19} _H	MENU → Press ▲ or ▼ key Select parameter	CALL: Selective Call VFTX: Transmission on Sub-frequency	MENU → EXIT P28

13

20 Side Key Setting

MENU → 2 SQL 0	PF3-KEY ^{MAN 20} _H	MENU → Press ▲ or ▼ key Select parameter	SCAN: Activate scan LAMP: Turn on Lamp Tele Alarm: Remote Alarm SOS-CH: SOS function RADIO: Turn on FM radio Disable: Inactivate	MENU → EXIT P29-31
----------------	--	---	---	--------------------

21 Working Mode Switch

MENU → 2 SQL 1 STEP	CH-MDF ^{MAN 21} _H	MENU → Press ▲ or ▼ key Select parameter	This transceiver has two working modes available: 1. Frequency mode (FREQ) 2. Channel mode Three kinds of channel modes available: ① Channel (CH) ② Frequency + Channel number (CH FREQ) ③ Channel name (NAME)	MENU → EXIT P31-32
---------------------	---------------------------------------	---	--	--------------------

22 Auto Backlight

MENU → 2 SQL 2 SQL	ABR ^{MAN 22} _H	MENU → Press ▲ or ▼ key Select parameter	Always ON 1S-20S: Backlight Timer	MENU → EXIT P32
--------------------	------------------------------------	---	--------------------------------------	-----------------

23 Offset Frequency

MENU → 2 SQL 3 SAVE	OFFSET ^{MAN 23} _H	MENU → Press ▲ or ▼ key Select parameter	0-599.995MHz	MENU → EXIT P32
---------------------	---------------------------------------	---	--------------	-----------------

24 Frequency Shift Direction

MENU → 2 SQL 4 TXP	SFT-D ^{MAN 24} _H	MENU → Press ▲ or ▼ key Select parameter	+ Positive direction - Negative direction OFF: Turn off frequency shift direction	MENU → EXIT P33
--------------------	--------------------------------------	---	---	-----------------

25 Stopwatch Timer

MENU → 2 SQL 5 ROGER	SECOND ^{MAN 25} _H	MENU → Press ▲ or ▼ key Select parameter	ON: Activate OFF: Deactivate	MENU → EXIT P33-34
----------------------	---------------------------------------	---	---------------------------------	--------------------

26 Channel Name Edit

MENU → 2 SQL 6 TOT	CHNAME ^{MAN 26} _H	MENU → Press ▲ or ▼ key Select parameter	Channel name should be composed by 26 letters (A to Z) and 10 numbers (0 to 9), eight maximum	MENU → EXIT P34
--------------------	---------------------------------------	---	---	-----------------

27 Channel Memory

MENU → 2 SQL 7 VOX	MEM-CH ^{MAN 27} _H	MENU → Press ▲ or ▼ key Select parameter	999 channels available	MENU → EXIT P35-36
--------------------	---------------------------------------	---	------------------------	--------------------

28 Channel Delete

MENU → 2 SQL 8 WIN	DEL-CH ^{MAN 28} _H	MENU → Press ▲ or ▼ key Select parameter	999 channels available	MENU → EXIT P36
--------------------	---------------------------------------	---	------------------------	-----------------

14

Shortcut Operation Sheet

29 Scan CTCSS/DCS	MENU → 2 SQL → 9 VOICE → SC-CTC ^{MAN 29}	MENU → Press or Select parameter	CTCSS DCS	MENU → EXIT P37
30 Power-ON Message	MENU → 3 SAVE → 0 → SC-DCS ^{MAN 30}	MENU → Press or Select parameter	BITMAP: Picture BATT-V: Votlage	MENU → EXIT P37-38
31 Mute Settings	MENU → 3 SAVE → 1 STEP → SP-MUTE ^{MAN 31}	MENU → Press or Select parameter	There are three squelch settings: QT*DTMF, QT+DTMF, QT	MENU → EXIT P38-39
32 Caller ID Transmission Settings	MENU → 3 SAVE → 2 SQL → ANI-SW ^{MAN 32}	MENU → Press or Select parameter	ON: Activate OFF: Deactivate	MENU → EXIT P39
33 Editing Caller ID	MENU → 3 SAVE → 3 SAVE → ANI-EDIT ^{MAN 33}	MENU → Press or Select parameter	Individual Caller IDs can be chosen within the range 100-999999, and cannot begin with 0	MENU → EXIT P39-40
34 DTMF Sidetone Settings	MENU → 3 SAVE → 4 TXP → DTMFST ^{MAN 34}	MENU → Press or Select parameter	DT-ST: Keypad sidetone will be activated when transmitting ANI-ST: Caller ID sidetone will be activated when transmitting DT-ANI: Caller ID sidetone and keypad sidetone will be activated when transmitting OFF: Deactivate all	MENU → EXIT P40-41
35 Keypad Auto Lock	MENU → 3 SAVE → 5 → AUTOLK ^{MAN 35}	MENU → Press or Select parameter	ON: Activate OFF: Deactivate	MENU → EXIT P41
36 Priority Channel Switch	MENU → 3 SAVE → 6 TOT → PRICH-SW ^{MAN 36}	MENU → Press or Select parameter	ON: Activate OFF: Deactivate	MENU → EXIT P41-42
37 Repeater Settings	MENU → 3 SAVE → 7 VOX → RPT-SET ^{MAN 37}	MENU → Press or Select parameter	X-DIRPT: Directional cross band repeat X-TWRPT: Two-way cross band repeat	MENU → EXIT P42-45
38 Repeater Speaker Switch	MENU → 3 SAVE → 8 WIN → RPT-SPK ^{MAN 38}	MENU → Press or Select parameter	ON: Speaker is activate when repeating OFF: Speaker is deactivate when repeating	MENU → EXIT P46

39 Repeater PTT Switch	MENU → 3 SAVE → 9 VOICE → RPT-PTT ^{MAN 39}	MENU → Press or Select parameter	ON: PTT transmission activated when repeating OFF: PTT transmission blocked when repeating	MENU → EXIT P46
40 Scan Add	MENU → 4 TXP → 0 → SCAN-ADD ^{MAN 40}	MENU → Press or Select parameter	ON: When scanning channels, they will be added to the scanning table OFF: Channels will not be added to the table when scanning	MENU → EXIT P46
41 Single-Tone Pulse Frequency	MENU → 4 TXP → 1 STEP → ALERT ^{MAN 41}	MENU → Press or Select parameter	There are 4 single-tone pulse frequency options:1750; 2100; 1000; 1450	MENU → EXIT P47
42 PTT ID Delay	MENU → 4 TXP → 2 SQL → PTT-DLY ^{MAN 42}	MENU → Press or Select parameter	Options: 100ms 200ms...3000ms	MENU → EXIT P47
43 Caller ID Transmission Mode	MENU → 4 TXP → 3 SAVE → PTT-ID ^{MAN 43}	MENU → Press or Select parameter	BOT: Press PTT to transmit caller ID. EOT: Release PTT to transmit caller ID. BOTH: Press and release PTT will both transmit caller ID.	MENU → EXIT P47-48
44 Ring Time	MENU → 4 TXP → 4 TXP → RING ^{MAN 44}	MENU → Press or Select parameter	1-10 Levels:each level 1 second OFF:Deactivate	MENU → EXIT P48
45 Scan Channel Group NO. of A Area	MENU → 4 TXP → 5 → SCG-A ^{MAN 45}	MENU → Press or Select parameter	All: scan all Group 1, Group 2, Group 3, Group 4, Group 5, Group 6, Group 7, Group 8, Group 9, Group 10	MENU → EXIT P48
46 Scan channel Group NO. of B Area	MENU → 4 TXP → 6 TOT → SCG-B ^{MAN 46}	MENU → Press or Select parameter	All: scan all Group 1, Group 2, Group 3, Group 4, Group 5, Group 6, Group 7, Group 8, Group 9, Group 10	MENU → EXIT P49
47 Repeater Receipt Tone	MENU → 4 TXP → 7 VOX → RPT-TONE ^{MAN 47}	MENU → Press or Select parameter	ON: Activate OFF: Deactivate	MENU → EXIT P49
48 Saving Scan Mode	MENU → 4 TXP → 8 WIN → SC-QT ^{MAN 48}	MENU → Press or Select parameter	ALL: Save both RX and TX CTCSS/DCS DEC: Save RX CTCSS/DCS NEC: Save TX CTCSS/DCS	MENU → EXIT P49-50

Shortcut Operation Sheet

49 Setting Sub-Frequency Mute	MENU → 4 _{TXP} → 9 _{VOICE} → SHUTESET ^{MAN} _H S3	MENU → Press ▲ or ▼ key Select parameter	OFF: Deactive this function TX: Deactive volume on sub-frequency when transmitting on master frequency RX: Deactive volume on sub-frequency when receiving on master frequency TX/RX:Deactive volume on sub-frequency when transmitting and receiving on master frequency	MENU → EXIT P50
50 Selective Call Code Group Setting	MENU → 5 _{ROGER} → 0 → CALLCODE ^{MAN} _H S3	MENU → Press ▲ or ▼ key Select parameter	Selective call group:1-20	MENU → EXIT P51
51 Reset Setting	MENU → 5 _{ROGER} → 1 _{STEP} → RESET ^{MAN} _H S1	MENU → Press ▲ or ▼ key Select parameter	VFO: Reset menu functional parameters ALL: Reset all (menu & channel) functional parameters	MENU → EXIT P51
52 Setting for Backlight	MENU → 5 _{ROGER} → 2 _{SQL} → BACKLIGHT ^{MAN} _H S2	MENU → Press ▲ or ▼ key Select parameter	Backlight: 01 to 10 groups	MENU → EXIT P52
53 Radio-WR	MENU → 5 _{ROGER} → 3 _{SAVE} → RADIO-WR ^{MAN} _H S3	MENU → Press ▲ or ▼ key Select parameter	Read Radio Station: 01-20 Groups Write Radio Station: 01-20 Groups	MENU → EXIT P52
54 Scramber	MENU → 5 _{ROGER} → 4 _{TXP} → ^{MAN} _H S4	MENU → Press ▲ or ▼ key Select parameter	Scrambler: 1-8 groups OFF: Turn off	MENU → EXIT P53
55 Componder	MENU → 5 _{ROGER} → 5 _{ROGER} → COMPANDE ^{MAN} _H S3	MENU → Press ▲ or ▼ key Select parameter	ON: Turn on OFF: Turn off	MENU → EXIT P53
56 Black	MENU → 5 _{ROGER} → 6 _{TOT} → COLOR ^{MAN} _H S8	MENU → Press ▲ or ▼ key Select parameter	White1, White 2, Black 1, Black 2	MENU → EXIT P54

How to Operate

Step Frequency (STEP) ----- MENU 1

In standby, press **MENU** + **1_{STEP}**, the screen displays . Press **MENU** to enter, press ▲ / ▼ to select the desired step, then press **MENU** to confirm, finally press **EXIT** to return to standby.

The frequency steps selectable for this transceiver are as follows:
5.00KHz, 6.25KHz, 10.00KHz, 12.50KHz, 25.00KHz, 50.00KHz and 100KHz.

Squelch Level (SQL-LE) ----- MENU 2

Squelch level is about when the signal is strong enough to turn on the squelch function, and when it is weak enough to turn off. You may hear the voice from the loudspeaker when turning ON the squelch and receiving the same signal from other transceivers. Higher level makes it harder to receive the weak signals, while lower level will be interfered by noises and/or unwanted signals.

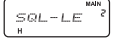
In standby, press **MENU** + **2_{SQL}**, the screen displays . Press **MENU** to enter, press ▲ / ▼ to select the desired squelch level, then press **MENU** to confirm, finally press **EXIT** to return to standby.

How to Operate

NOTE

» The squelch level for this transceiver has 0-9 levels selectable, and level 0 means turn off the squelch function. The higher level of the squelch is set, the stronger receiving signal is needed.

Power Saver Mode (SAVE) --- MENU 3

When the power saver function is ON, the receiver circuit will be cut off for a moment, and then re-activate to detect the signals for a while, in order to reduce the battery capacity consumption.

In standby, press **MENU** + **3_{SAVE}**, the screen displays 

Press **MENU** to enter, it shows 'ON', press **▲** / **▼** to select turn ON/OFF the power saver function.

Press **MENU** to confirm, and then press **EXIT** to return to standby.

Transmitting Power Selection (TXP) --- MENU 4

In frequency mode, press **MENU** + **4_{TXP}**, the screen displays 

Press **MENU** to enter, it shows 'HIGH', press **▲** / **▼** to select HIGH/LOW power, then press **MENU** to confirm, finally press **EXIT** to return to standby.

Transmission Prompt settings (ROGER) --- Menu 5

When the transceiver is standby, press the **MENU** + **5_{ROGER}** keys and the screen will display: 

Press the key to access the menu, and after pressing the **▲** / **▼** keys to choose the required prompt mode, press the **MENU** key to confirm, or the **EXIT** key to return to standby.

The transceiver features 4 kinds of prompt: BOT (beginning of transmission), EOT (end of transmission), BOTH (beginning and end of transmission), and OFF (prompts deactivated).

Time-out Timer (TOT) --- MENU 6

This transceiver can be set in 60 levels with 15 seconds each, between 15 and 900 seconds.

In standby, press **MENU** + **6_{TOT}**, the screen displays 

Press **MENU** to enter, press **▲** / **▼** to select the desired timer level, then press **MENU** to confirm, finally press **EXIT** to return to standby.

VOX (VOX) --- MENU 7

In standby, press **MENU** + **7_{VOX}**, the screen displays 

Press **MENU** to enter, press **▲** / **▼** to select VOX level (1-9), then press **MENU** to confirm, finally press **EXIT** to return to standby.

How to Operate

NOTE

- » The higher level of VOX is set, the higher volume is needed.
- » In SCAN and FM radio modes, the VOX function is not available.

Bandwidth Selection (W/N) --- MENU 8

In standby, press **MENU** + **8**_{W/N}, the screen displays 

Press **MENU** to enter, it shows 'WIDE', press **▲** / **▼** to select WIDE/NARROW bandwidth, then press **MENU** to confirm, finally press **EXIT** to return to standby.

There are two bandwidths for option: WIDE:25KHz and NARR:12.5KHz

Voice Guide (VOICE) --- MENU 9

In standby, press **MENU** + **9**_{VOICE}, the screen displays 

Press **MENU** to enter, press **▲** / **▼** to select ON or OFF, and then press **MENU** key to confirm, finally press **EXIT** to return to standby.

NOTE

- » Turn off MENU 9 and MENU 11 at the same time to turn off all the voice prompt if required.

Transmitting Overtime Alarm (TOA) --- MENU 10

In standby, press **MENU** + **1**_{STEP} **0**, the screen displays 

Press the **MENU** key to access the menu, and after pressing the **▲** / **▼** keys to select the required time, press the **MENU** key to confirm, and the **EXIT** key to return to standby.

TOA has a maximum length of 10seconds, each level corresponding to 1second. OFF: Deactivate TOA.

Special Reminder

- » When the transmission exceeds the "Time-out timer" set time, a error tone will prompt, and transmission is stopped automatically.

Beep Prompt Function (BEEP) --- MENU 11

In standby, press **MENU** + **1**_{STEP} **1**_{STEP}, the screen displays 

Press **MENU** to enter, press **▲** / **▼** to turn ON/OFF the beep prompt function, then press **MENU** to confirm, finally press **EXIT** to return to standby.

How to Operate

Display Language (LANGUAGE) --- MENU 12

In standby, press **MENU** + **1STEP** **2SQL** , the screen display 

Press **MENU** to access the function, press **▲** / **▼** to select the desired language, and then press **MENU** to confirm, press **EXIT** to return to standby mode.

Two Options:CHINESE and ENGLISH

Busy Channel Lockout (BCL) --- MENU 13

In frequency mode, press **MENU** + **1STEP** **3SAFE** , the screen displays 

Press **MENU** to enter, press **▲** / **▼** to select ON/OFF this function, then press **MENU** to confirm, finally press **EXIT** to return to standby.

Note:This function is invalid in cross band repeater or repeater/transmitter modes.

Scan Mode Settings (SC-REV) --- Menu 14

When the transceiver is standby, press the **MENU** + **1STEP** **4TXP** , keys and the screen will display 

Press the **MENU** key to access the menu, and after pressing the **▲** / **▼** keys to select the required setting, press the **MENU** key to confirm, and the **EXIT** key to return to standby

The transceiver has 3 scan modes:TO,CO,and SE:

TO: after finding a carrier wave signal, scanning will continue if no operations are carrier out within 5 seconds.

CO: scanning will stop when a carrier wave signal has been found,and scanning will continue if the carrier wave signal is lost for 3 seconds.

SE: scanning will stop when a carrier wave signal is found.

NOTE

» Hold on for 2 seconds to access the scan mode.

Receiving CTCSS settings (RX-CTC) --- Menu 15

When the transceiver in standby. press the **MENU** + **1STEP** **5ACCESS** keys and the screen will display 

Press the **MENU** key to access the menu,and after pressing the **▲** / **▼** key to select the CTCSS you desire, press the **EXIT** key to return to standby.

The CTCSS has a total of 50 groups, ranging from 67.0 to 254.1HZ. OFF:Deactivate.

How to Operate

Transmitting CTCSS settings (TX-CTC) --- Menu 16

When the transceiver is standby, press the **MENU** + **1** **STEP** **6** **TOT** keys and the screen will display 

Press the **MENU** key to access the menu, and after pressing the **▲** / **▼** key to select the CTCSS you desire, press the **MENU** key to confirm, and press the **EXIT** key to return to standby.

CTCSS has a total of 5 groups, ranging from 67.0-254.1Hz. OFF: Deactivate

Receiving DCS settings (RX-DCS) --- Menu 17

When the transceiver is standby, press the **MENU** + **1** **STEP** **7** **VOX** keys and the screen will display 

Press the **MENU** key to access the menu, and after pressing the **▲** / **▼** key to select the DCS you desire, press the **MENU** key to confirm, and press the **EXIT** key to return to standby.

DCS: 105 groups of positive code, 105 groups of negative code, ranging from D023N to D754I.

OFF: Deactivate.

Transmission DCS settings (TX-DCS) --- Menu 18

When the transceiver is standby, press the **MENU** + **1** **STEP** **8** **WIN** keys and the screen will display 

Press the **MENU** key to access the menu, and after pressing the **▲** / **▼** key to select the DCS you desire, press the **MENU** key to confirm, and press the **EXIT** key to return to standby.

DCS: 105 groups of positive code, 105 groups of negative codes, ranging from D023N to D754I.

OFF: Deactivate.

CTCSS									
1	67.0	11	94.8	21	131.8	31	171.3	41	203.5
2	69.3	12	97.4	22	136.5	32	173.8	42	206.5
3	71.9	13	100.0	23	141.3	33	177.3	43	210.7
4	74.4	14	103.5	24	146.2	34	179.9	44	218.1
5	77.0	15	107.2	25	151.4	35	183.5	45	225.7
6	79.7	16	110.9	26	156.7	36	186.2	46	229.1
7	82.5	17	114.8	27	159.8	37	189.9	47	233.6
8	85.4	18	118.8	28	162.2	38	192.8	48	241.8
9	88.5	19	123.0	29	165.5	39	196.6	49	250.3
10	91.5	20	127.3	30	167.9	40	199.5	50	254.1

How to Operate

DCS (positive code)

1	D023N	16	D074N	31	D165N	46	D261N	61	D356N	76	D462N	91	D627N
2	D025N	17	D114N	32	D172N	47	D263N	62	D364N	77	D464N	92	D631N
3	D026N	18	D115N	33	D174N	48	D265N	63	D365N	78	D465N	93	D632N
4	D031N	19	D116N	34	D205N	49	D266N	64	D371N	79	D466N	94	D645N
5	D032N	20	D122N	35	D212N	50	D271N	65	D411N	80	D503N	95	D654N
6	D036N	21	D125N	36	D223N	51	D274N	66	D412N	81	D506N	96	D662N
7	D043N	22	D131N	37	D225N	52	D306N	67	D413N	82	D516N	97	D664N
8	D047N	23	D132N	38	D226N	53	D311N	68	D423N	83	D523N	98	D703N
9	D051N	24	D134N	39	D243N	54	D315N	69	D431N	84	D526N	99	D712N
10	D053N	25	D143N	40	D244N	55	D325N	70	D432N	85	D532N	100	D723N
11	D054N	26	D145N	41	D245N	56	D331N	71	D445N	86	D546N	101	D731N
12	D065N	27	D152N	42	D246N	57	D332N	72	D446N	87	D565N	102	D732N
13	D071N	28	D155N	43	D251N	58	D343N	73	D452N	88	D606N	103	D734N
14	D072N	29	D156N	44	D252N	59	D346N	74	D454N	89	D612N	104	D743N
15	D073N	30	D162N	45	D255N	60	D351N	75	D455N	90	D624N	105	D754N

CALL/VFTX on Side Key 1 (PF1-KEY) --- MENU 19

In standby, press **MENU** + **1STEP** **8WIN** the screen displays 

Press **MENU** to access the menu, press **▲** / **▼** to select the mode you desire. And then press **MENU** to confirm, and press **EXIT** to return to standby.

Two options: CALL(Selective Calls) and VFTX (Transmission on Sub-frequency).

Selective call codes are programmed via supplied software.

SCAN/LAMP/SOS/TeleAlarm/RADIO/DISABLE on Side Key 3 (PF3-KEY) --- MENU 20

In standby, press **MENU** + **2SQL** **0** the screen displays 

Press **MENU** to access the menu, press **▲** / **▼** to select the function you desire. And then press **MENU** to confirm, press **EXIT** to return to standby.

Six options: SCAN,LAMP, SOS, TeleAlarm, RADIO and Disable.

Different operations according to different functions:

SCAN: Activate the scan function:

In standby, press PF3 to access scanning mode.(scan mode can be set via MENU 14-Scan Mode Setting), while press any key to stop scanning.

LAMP: Activate lamp function:

In standby, press PF3 to activate lamp function, while press PF3 again to deactivate.

SOS-CH function

In standby, press PF3, the speaker will prompt alarm after 2 seconds, and the radio will transmit alarm tone.

How to Operate

NOTE

» Each alarm lasts 10seconds, and after 5 minutes, the alarm will re-activate. Press any key to exit the function.



TeleAlarm: Activate remote alarm function

In standby, press PF3, the speaker will prompt alarm and transmit ANI ID code + numbers "110".

Press PTT key to exit.

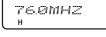

RADIO: Activate the FM radio function

A. Activate FM radio:

In standby, press PF3 to activate FM radio. The screen displays , press  to access FM radio function to automatically search FM radio. The search will automatically stop when receiving FM radio.

FM radio will be received on the searched frequency.

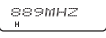
B. Inputting FM radio Frequency

In FM radio mode, press PF3, the screen display , hold on  for 2 seconds, the screen displays . It is OK to input the FM radio frequency.

C. Exit FM radio





Press PF3 again to exit FM radio function.

NOTE

» When FM radio is active, current frequency or channel is still in standby. After receiving the signals, the transceiver returns to transceiver communication mode. After the signal disappears for 5seconds, the transceiver returns to FM radio. After 5seconds when pressing PTT key to transmit, the transceiver returns to FM radio automatically.

Working Mode Switch (CH-MDF) --- MENU 21

In standby, press  +  , the screen display 

Press  to enter, press  / , to select mode then press  confirm, press  it return to standby.

This transceiver has two options for the working mode:

1. Frequency mode(FREQ)
2. Channel mode

There are three channel display selections in channel mode as follows;

- ① Channel (CH)
- ② Frequency+ Channel number (CH FREQ)
- ③ Channel name (NAME)

How to Operate

NOTE

- » The password for the work mode switch is programmed only via the programming software.
- » The password is consist of 6 characters, while "000000" means no password needed for the mode switch.

Auto Backlight (ABR) --- MENU 22

In standby , press **MENU** + **2SQL** **2SQL** , the screen display 

Press **MENU** to enter, press **▲** / **▼** to select backlight function , then press **MENU** confirm , press **EXIT** it return to standby.

Always Activate

1S-20S: Set the lasting time of backlight

Offset Frequency (OFF-SET) --- MENU 23

In standby, press **MENU** + **2SQL** **3SAVE** and the screen display 

Press **MENU** to access the menu,press **▲** / **▼** to select the parameter you desire, and then presses **MENU** to confirm, press **EXIT** to return to standby.

Offset frequency range:0-599.995MHz, The 7th and 8th frequency point depends on the programmed step frequency.

Frequency Shift Direction (SFT-D) --- MENU 24

In standby, press **MENU** + **2SQL** **4FXP** , The screen display 

Press **MENU** to enter, press **▲** / **▼** to select the desired frequency shift direction, then press **MENU** confirm, press **EXIT** it return to standby.

There are three selections for the frequency shift direction setting:

1. Plus shift (+), which means that the transmitting frequency is higher than the receiving frequency.
2. Minus shift (-), which means that the transmitting frequency is lower than the receiving frequency.
3. Turn off this function

NOTE

- » When offset frequency is out of the allowed offset frequency range, the transceiver can not transmit. In this case, please make sure the offset frequency and receiving frequency is within the allowed range.

Stopwatch Timer (SECOND) --- MENU 25

In standby, press **MENU** + **2SQL** **5ROGER** , The screen display 

Press **MENU** to enter, **▲** / **▼** to select ON/OFF , then press **MENU** confirm, press **EXIT** to standby.

Using the stopwatch timer:

How to Operate

When this function is ON, press **#LOCK** to start counting, while press any key to stop working . Press **#LOCK** again to re-start counting.

NOTE

» Press any key (except **#LOCK**) when the stopwatch stops working to exit the stopwatch function.

Editing a Channel Name (CH-NAME) --- MENU 26

Channel names can only be edited in channel mode, and only the name of the present channel can be edited this operation is ineffective in frequency mode.

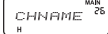
In standby, press **MENU** + **2SQL** **6TOT** keys and the screen will display 

Press **MENU** to access the menu, and the first digit will flash (which indicates that this digit is being edited).

Press **▲** to choose the required character, press **▼** to edit the next character, press **MENU** to confirm, and then press **EXIT** to return to standby.

NOTE

- » 1.Channel names can be maximum of 8 characters long.
- » 2.When all 8 characters are empty, the channel will be displayed on the screen as "NO-NAME!"

Memorize Channel (MEM-CH) --- MENU 27

In channel mode or standby, press **MENU** + **2SQL** **7VOX**, the screen displays 

Press **MENU** to access the menu, press **▲** / **▼** to select the desired channel order, and then press **MENU** to memorize with a voice prompt. Press **EXIT** to return to standby.

When the transceiver is in channel(MR) mode, the parameters(except channel name and scan adding) will be memorized into the channel.

When the transceiver is in frequency(VFO) mode, you can program all the parameters(frequency, offset, offset directions etc.) into the channel to memorize.

Example:

- 1.Inputting 450.025MHz to the transceiver in frequency(VFO)mode, press **MENU** + **1STEP** **5ROCS** to access receiving CTCSS/DCS setting, press **▲** / **▼** to select 67.0Hz, press **MENU** to confirm.
- 2.Press **MENU** + **2SQL** **3SAVE** to select the offset frequency is 10.000MHz, press **MENU** + **2SQL** **4TYP** to set the frequency direction as "+".
- 3.Press **MENU** + **2SQL** **7VOX** to access channel memory, select CH-010 and press **MENU** to memorize the

How to Operate

channel and return to standby.

In standby, press **MENU** + **2SQL** **7VOX** to access channel memory, the screen displays , input the desired channel number orderly, and then press **MENU** to confirm.

NOTE

- » When the selected channel is empty (without any parameter), the characters of the channel number is blue, while the selected channel is with the memorized parameters, the characters of the channel number is dark red.

Deleting a channel (DEL-CH) --- MENU 28

In standby, press **MENU** + **2SQL** **8WV** the screen will display 

Press **MENU** to access the menu, press **▲** / **▼** to select the channel you wish to delete or manually inputting the channel number, press **MENU** to confirm and the **EXIT** key to return to standby.

Special Reminder

- » 1st channel can not be deleted.
- » When the selected channel is empty (without any parameter), the characters of the channel number is blue, while the selected channel is with the memorized parameters, the characters of the channel number is dark red.

CTCSS scanning (SCN-CTC) --- MENU 29

This function is scanning the programmed frequencies or channels with CTCSS/DCS or not. When the CTCSS/DCS are not compatible with the one you are going to communicate with, it stops the regular communication.

In standby, press **MENU** + **2SQL** **9VOICE**, screen displays , Select CTCSS or DCS, then Press **MENU** to confirm and start the scan.

Special Reminder

- » if there is no carrier received on the scanned frequencies or channels, the function is not activated.
- » pls use the **▲** / **▼** to change the direction for scanning.
- » it stopes on the frequency or channel which is programmed with CTCSS/DCS, pls press **MENU** to save by yourself if needed. Pls press ***SCAN** to continue to scan the next frequencies or channels if not needed.

Power-ON Message(PONMSG)-----MENU 30

In Standby, press **MENU** + **3SAVE** **0**, the screen displays 

Press **MENU** to enter the function, then press **▲** / **▼** to select the parameter and then **MENU** to confirm,

How to Operate

while press **EXIT** to return back to the standby.

BITMAP: Picture

BATT-V: Voltage

Mute settings (SP-MUTE) --- MENU 31

In standby, press **MENU** + **3SAVE** **1STEP**, the screen displays 

Press **MENU** to access the menu, and after pressing **▲** / **▼** to choose the required mute mode, press **MENU** to confirm, and press **EXIT** to return to standby.

Squelch settings: set the conditions which determine when the speaker shall be turned on, these settings are used during selective calls, group calls and all calls.

The transceiver's mute mode include:

QT: When the transceiver is set to this mode, all signals on the same QT frequency will activate the speaker.

QT+DTMF: only those signals which both satisfy the requirements of QT and whose DTMF carrier wave signal also match the transceiver will activate the speaker in this mode.

QT*DTMF: When this mode is active, only those signals which either meet QT requirements or DTMF requirements will activate the speaker.

Caller ID Code Switch (ANI-SW) --- MENU 32

In frequency mode, press **MENU** + **3SAVE** **2SQL**, The screen display 

Press **MENU** to enter, press **▲** / **▼** to select turn ON/OFF, and press **MENU** to confirm, press **EXIT** it return to standby.

Editing Caller ID Code (ANI-EDIT) --- MENU 33

The transceiver's Caller ID code is composed of the arabic numerals 0-9: the first digit cannot be 0, and ID numbers can be as short as 3 digits and as long as 6.

In standby, press **MENU** + **3SAVE** **3SAVE**, the screen displays 

Press **MENU** to access the menu, and after inputting the required numbers, press **MENU** to confirm, and **EXIT** key to return to standby.

Example 1: editing a 6-digit ANI ID code(123456).

In standby, press **MENU** + **3SAVE** **3SAVE**, the screen displays 

After pressing **MENU** key, the first digit will flash, then input the required value 123456.

Press **MENU** to confirm, and press **EXIT** to return to standby.

Example 2: editing a 3-digit Caller ID code(123)

How to Operate

In standby, press **MENU** + **3**_{SAVE} **3**_{SAVE}, the screen displays 

After pressing **MENU**, if a Caller ID code has been already input, it will be displayed, and the first digit will flash. If no Caller ID code has been input, 101 will be displayed, and the first digit will flash. Input 123 at the same time, press **MENU** to confirm, press **EXIT** to return to standby.

Special Reminder

» Each transceiver can have only one ANI ID code, which is shared by Area A and B.

DTMF Sidetone (DTMF-ST) --- MENU 34

In frequency mode, press **MENU** + **3**_{SAVE} **4**_{TXP}, The screen display 

Press **MENU** to enter, press **▲** / **▼** to select the required sidetone mode, and press **MENU** to confirm, press **EXIT** it return to standby.

The transceiver has the following DTMF modes: 1. DT-ST: Keypad sidetone will be activated when transmitting; 2. ANI-ST: ANI ID code sidetone will be activated when transmitting; 3. DT+ANI: keypad and caller ID sidetone are both activated when transmitting. OFF: Deactivate sidetone function.

Keypad Autolock (AUTOLOCK) --- MENU 35

In standby, press **MENU** + **3**_{SAVE} **5**_{PROCES}, the screen displays 

Press **MENU** to access the menu, press **▲** / **▼** to select ON(Activate)/OFF(Deactivate), and then press **MENU** to confirm, press **EXIT** to return to standby.

After activating keypad autolock function, the keypad will be locked automatically without any operation in 15seconds. Hold on **#**_{LOCK} for 2seconds to unlock the keypad.

NOTE

» Manually lock: In standby, hold on **#**_{LOCK} for 2seconds to lock the keypad, hold on **#**_{LOCK} for 2 seconds again to unlock the keypad.

Priority Channel Switch (PRI CH-SW) --- MENU 36

In standby, press **MENU** + **3**_{SAVE} **6**_{TOT}, the screen display 

Press **MENU** to access, press **▲** / **▼** to select ON/OFF. And then press **MENU** to confirm, and press **EXIT** to return to standby

If you want to monitor the other frequency and check the certain preferred frequency at the same time, you can set priority scan function.

How to Operate

E.g.: Scan six channels. Set CH1, CH2, CH3, and CH4 and CH5 as the common scanned channels and CH6 as the priority scanned channels. Then the scanning order is as followings:

→ CH1 → CH6 → CH2 → CH6 → CH3 → CH6 → CH4 → CH6 → CH5 → CH6 →

When this transceiver detects signal on the priority channel during scanning, it will on its frequency. Please program the priority channel via KG-UV8E programming software.

Repeater Setting (RPT-SET) --- MENU 37

This transceiver has 2 repeater setting available:

- 1.X-DIRPT: Directional cross-band repeater mode
- 2.X-TWRPT: Two way cross-band repeater mode

Special Reminder

» In cross-band repeater mode, if the channel or frequency set the reverse frequency, offset frequency, or offset direction, its transmitting frequency would out of the transceiver's frequency, then it will not transmit.

Master frequency and sub frequency for repeater should be on different bands. (For example, master frequency is programmed on VHF band, and the sub frequency should be programmed on UHF band, and vice versa.)

X-DIRPT (Directional cross-band repeater): The master VFO's receiving frequency is the cross-band receiver's receiving frequency, and the sub VFO's transmitting frequency is the cross-band transmitter's transmitting frequency.

X-TWRPT (Two way cross-band repeater): In standby, both the master and secondary VFO's are receivers, whichever VFO receives an effective carrier-wave signal, the other VFO will be the transmitter and start transmitting. The transmitter and receiver is unfixed under two way cross-band repeater mode. The first received VFO is receiver and relatively the other one is transmitter.

After accessing cross-band repeater mode, the operation of receiving /transmission frequencies, CTCSS/DCS encoding& decoding are the same as the transceiver is in transceiver

How to Operate

communication mode.

Example:

- A. Before accessing cross-band repeater mode, A area is in channel mode. The receiving frequency and CTCSS/DCS in cross-band repeater mode are the same with the channel in standby.
After B area receives the effective signal, A area starts transmission. The transmitting frequency and CTCSS/DCS in cross-band repeater mode are the same with the channel in A area.
If setting reverse frequency function, the transmission&receiving frequencies and CTCSS/DCS will be reverted.
- B. Before accessing cross-band repeater mode, A area is in frequency mode. The receiving frequency and CTCSS/DCS in cross-band repeater mode are the same with the setting in standby.
After B area receives the effective signal, A area starts transmission. The receiving frequency and CTCSS/DCS in cross-band repeater mode are the same with the channel in A area.
If setting reverse frequency function, the transmission&receiving frequencies and CTCSS/DCS will be reverted.

To select if you will open speaker for the receiver in cross-band repeater via MENU38 (RPT-SPK), and if you would like to hold on PTT key to transmit in repeater mode via MENU39 (RPT-PTT). But if you press PTT key to transmit, the transceiver exits the repeater mode temporarily.

In standby, press **MENU** + **3**_{SAVE} **7**_{VOX} the screen displays 

Press **MENU**, press **▲** / **▼** to select the mode you desire, and then press **MENU** again.

Special Reminder

- » In cross-band repeater mode, the screen will display .
- » Switching transceiver communication and repeater modes via **RPT**. In standby, hold on **RPT** for 2 seconds to switch the modes.
- » In order to use the repeating well, there is the Repeating Receipt Tone which is set by MENU 47. The repeating receipt tone timely and effectively reports the working status and increases the efficiency of repeating.
- » The Repeating Hold Timer is used for avoiding to press or release PTT too frequently in order to read out the message. When the receiver was released PTT, the hold time is able for the equipment keeping transmitting for a while during waiting for response. If there is no efficient QT/DQT detected within the hold time, then the transmitter will release PTT. The repeating hold timer is setting the hold time for the transmitter to keep transmitting after the QT/QDT receiving signal disappears. The function is programmable by supplied software.

How to Operate

Repeater Speaker (RPT-SPK) --- MENU 38

In standby, press **MENU** + **3**_{SAVE} **8**_{WIN}, the screen display 

Press **MENU** to access, press **▲** / **▼** to select ON/OFF. And then press **MENU** to confirm, and press **EXIT** to return to standby.

Repeater PTT (RPT-PTT) --- MENU 39

In standby, press **MENU** + **3**_{SAVE} **9**_{VOICE}, the screen display 

Press **MENU** to access, press **▲** / **▼** to select ON/OFF. And then press **MENU** to confirm, and press **EXIT** to return to standby.

Scan Add (SCAN-ADD) --- MENU 40

This function means whether a channel in scanning when in the startup channel scanning, so the function can be set only in the channel mode under the current channel, is invalid in frequency mode.

In standby, press **MENU** + **4**_{TXP} **0**, the screen display 

Press **MENU** to access, press **▲** / **▼** to select ON/OFF. And then press **MENU** to confirm, and press **EXIT** to return to standby.

Note: The function is invalid in cross-band repeater or repeater/transmitter mode.

Single-Tone Pulse Frequency (ALERT) --- MENU 41

Some of the relay systems used for single-tone pulse transmission need a single-tone pulse signal to activate, if a repeater is already active, however, this signal is not needed. The following pulse signal frequencies can be selected: 1750Hz, 2100Hz, 1000Hz and 1450Hz.

In standby, press **MENU** + **4**_{TXP} **1**_{STEP}, the screen displays 

Press **MENU** to access, press **▲** / **▼** to select the parameter you desire and then press **MENU** to confirm, press **EXIT** to return to standby.

In transmission mode, press PF2 to transmit the selected single-tone pulse frequency.

Caller ID Code Transmitting Delay (PTT-DLY) --- MENU 42

In standby, press **MENU** + **4**_{TXP} **2**_{SQL}, the screen display 

Press **MENU** to access, press **▲** / **▼** to select the time you want. And then press **MENU** to confirm, and press **EXIT** to return to standby.

This delay time can be set 100~3000ms, total 30 levels with 100ms each.

Caller ID Transmission Mode (PTT-ID) --- MENU 43

In standby, press **MENU** + **4**_{TXP} **3**_{SAVE}, the screen display 

How to Operate

Press **MENU** to access, press **▲** / **▼** to select the mode you want. And then press **MENU** to confirm, and press **EXIT** to return to standby.

This can be set three methods, BOT (begin), EOT (end), BOTH (begin /end).

Ring Time --- MENU 44

In standby, press **MENU** + **4**_{TXP} **4**_{TXP}, the screen display 

Press **MENU** to access, press **▲** / **▼** to select the parameter you want. And then press **MENU** to confirm, and press **EXIT** to return to standby.

This ring time can be set 10 seconds, total 10 levels with 1 second. OFF:Deactivate the function.

Scan group A setting (SCG-A) --- MENU 45

The scan group settings are the way that a transceiver can divide the programming channels into different scan groups. It will scan all channels in Group A.

Scan group settings are: ALL channel, as well as 1-10 individual scanning groups.

In standby, press **MENU** + **4**_{TXP} **5**_{PROG B}, the screen displays 

Press **▲** / **▼** to press **MENU** to confirm, press **EXIT** to return.

Note:Scanning group A setting is active in A area.

Scan Group B Setting (SCG-B) --- MENU 46

The scan group settings are the way that a transceiver can divide the programming channels into different scan groups. It will scan all channels in Group B.

Scan group settings are: ALL channel, as well as 1-10 individual scanning groups.

In standby, press **MENU** + **4**_{TXP} **6**_{TOT}, the screen displays 

Press **▲** / **▼** to press **MENU** to confirm, press **EXIT** to return.

Note:Scanning group B setting is active in B area.

Repeater Tone Setting (RPT-TONE) --- MENU 47

In standby, press **MENU** + **4**_{TXP} **7**_{VOX}, the screen display 

Press **MENU** to access, press **▲** / **▼** to select the parameter,. And then press **MENU** to confirm, and press **EXIT** to return to standby.

ON: Activate the function

OFF: Deactivate the function

Saving Scanned CTCSS/DCS (SC-QT) --- MENU 48

When the transceiver is in CTCSS/DCS scanning, there are 3 saving types to save the detected CTCSS/

How to Operate

DCS from the others to your transceiver:

1. Save as your transceivers decoder and encoder(ALL).
2. Save as your transceiver encoder(ENCODER)
3. Save as your transceiver decoder(DECODER)

When the transceiver is in standby, press **MENU** + **4**_{TXP} **8**_{WIN} keys and the screen will display 

Press **▲** / **▼** press **MENU**, and then press **EXIT**.

Mute Setting on Sub-frequency --- MENU 49

Mute function is very practical, especially when the transceiver is in dual receiving mode.

In standby, press **MENU** + **4**_{TXP} **9**_{VOICE}, the screen displays 

Press **MENU** to access and then press **▲** / **▼** to select the parameter you desire, and then press **MENU** to confirm.

OFF: Deactivate the function

TX: Transmission on master frequency, the receiving volume of sub-frequency is off.

RX: Receiving on master frequency, the receiving volume of sub-frequency is off.

TX/RX: Both receiving and transmission on master frequency, the receiving volume of sub-frequency is off.

Selective Call Code Group Setting (CALLCODE) --- MENU 50

In standby, press **MENU** + **5**_{ROGER} **0**, the screen displays 

Press **MENU** to access the menu, press **▲** / **▼** to select the desired selective call group number. Press **MENU** to confirm, and the transceiver returns to standby.

Selective call code are with 1-20 groups for option. Selective call codes are programmed via supplied software.

Reset setting (Reset) --- MENU 51

Functional Parameter Reset(VFO): resets all functional settings to factory default values, but channel parameters are not reset.

Total Parameter Reset(ALL): resets all of the transceiver's functional settings and channel parameters to factory values.

In standby, press **MENU** + **5**_{ROGER} **1**_{STEP}, the screen displays 

Press **MENU** to access, press **▲** / **▼** to select the parameter you desire and then press **EXIT** to confirm.

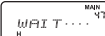
The screen will display 

After the transceiver resets(VFO/ALL), it will restart and return to standby mode.

How to Operate

Setting Backlight (BK-LIGHT) --- MENU52

In standby, press **MENU** + **5**^{ROGER} **2**^{SQ}, screen display 

Press **MENU** to enter the function, then press **▲** / **▼** to select the parameter and then **MENU** to confirm, while press **MENU** to return back to the standby.

Level selectable for baklight setting: 01 to 10

Radio Storage (RADIO-WR) --- MENU53

Read Radio Station: In FM Radio mode, enter the menu to select the function, there is 20 groups for selection.

Write Radio Station: In FM Radio mode, enter the menu to select the function, there is 20 groups for selection.

In standby, press **MENU** + **5**^{ROGER} **3**^{SAVE}, screen display 

Press **MENU** to enter the function, then press **▲** / **▼** to select the parameter and then **MENU** to confirm, while press **MENU** to return back to the standby.

Scrambler (SCRAM) --- MENU54

This is a special voice process to keep the communication confidential from other non-users.

In standby, press **MENU** + **5**^{ROGER} **4**^{TXP}, screen display 

Press **MENU** to enter the function, then press **▲** / **▼** to select the parameter and then **MENU** to confirm, while press **MENU** to return back to the standby.

There are 8 groups for selection, OFF is to turn off this function then.

Compander (COMPANDER) --- MENU55

This is for decreasing the voice squelch, and it is highly efficient for long-term communication.

In standby, press **MENU** + **5**^{ROGER} **5**^{ROGER}, screen display 

Press **MENU** to enter the function, then press **▲** / **▼** to select the parameter and then **MENU** to confirm, while press **MENU** to return back to the standby.

There is ON and OFF selectable.

How to Operate

Backlight (COLOR) --- MENU 56

It supports to select different colors for the backlight of display, default color is Black2.

In standby, press **MENU** + **5** (PROG) **6** (TOT), display , then press **MENU** to enter and select the colors by UP/DOWN, finally, press **MENU** to confirm or **EXIT** to go back to standby.

White1: backlight is white, font is black, and icon is red.

White2: backlight is light blue, font is dark blue, and icon is red.

Black1: backlight is shadow black, font is golden, and icon is green.

Black2: backlight is black, font is white, and icon is green.

Detailed Instruction for Some Important Functions

All calls, Group calls and Selective calls

There are Caller ID code transmission, Caller ID code edit and DTMF decoding functions. Without the assistance of the other communication equipments, the all calls, group calls and selective calls are available between the groups.

Before using all calls, group calls and selective calls function, you need to set as followings:

1. Caller ID CODE edit

Each transceiver in the same group should be edited a unique ANI ID code.

Caller ID CODE: ID -- XXX(3 digits) ID -- XXXX(4 digits) ID--XXXXX(5 digits) ID-- XXXXXX(6digits)

<u>ID</u>	<u>X</u>	<u>XXXXX</u>
Caller ID CODE mark	Group NO. mark From 1 to 9 group, Maximum: 9 groups	Unique Caller ID CODE From 00000~99999, Maximum:1000000 digits

This is how to set Caller ID CODE.

NOTE: Caller ID Codes should be different for the transceivers in the same group.

Detailed Instruction for Some Important Functions

Steps are as followings:

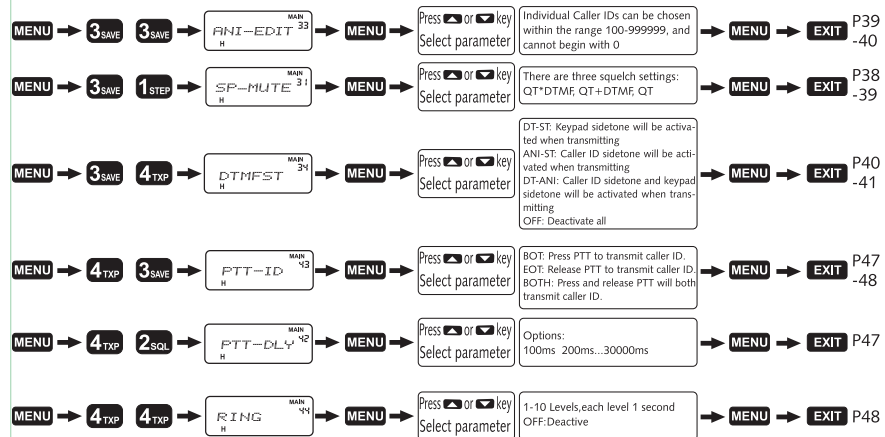

NOTE

» Any transceiver in the same group should be with the same frequency point and parameter.

a. How to use all calls function:

Hold on PTT key to transmit. After transmitting Caller ID Code, input *SCAN + #LOCK keys directly.

b. How to use group calls function:

Hold on PTT key to transmit. After transmitting Caller ID Code, input "Group NO." *SCAN + #LOCK

c. How to use selective calls function:

Hold on PTT key to transmit. After transmitting Caller ID Code, input the Caller ID Code of the selective transceiver that you want to speak to.

Note: Selective call is available via selective call key. Selective call code is programmed via supplied software. Programming the same selective call code of the selective transceiver and Caller ID code of the selected transceiver.

For example, Caller ID Code for the selected transceiver is 123456, selective call code for the selective transceiver should be 123456 too.

Repeater Usage

1.Repeater PTT Switch (RPT-PTT)

When the transceiver is in standby, press MENU + 3 SAVE 9 NOISE keys and the screen displays 

Press MENU to access the settings, and after pressing the ▲ / ▼ keys to activate (ON) the PTT trans-

Detailed Instruction for Some Important Functions

ission, Press **MENU** to confirm, and press the **EXIT** key to return to standby.

2.Repeater speaker switch (RPT-SPK)

When the transceiver is in standby, press **MENU** + **3_{SAVE}** **8_{WIN}** keys and the screen will display 

Press **MENU** to access the settings, and after pressing **▲** / **▼** to activate (ON) the speaker, press **EXIT** key to return to standby.

3.Repeater Setting (RPT-SET)

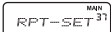
Accessing cross-band repeater mode: when the transceiver is in standby, press **MENU** + **3_{SAVE}** **7_{VOX}** and the screen will display 

Press **MENU** to access, press **▲** / **▼** to select two-way cross-band repeater mode (X-TWRPT) or directional cross-band repeater mode (X-DIRPT). Press **MENU** to confirm. And then press **EXIT** to return to standby mode, hold on **RPT** key for 2seconds, the transceiver is to access cross-band repeater.

Exit Cross-Band Repeater: In standby, hold **RPT** for 2seconds, the transceiver exit the cross-band repeater mode and access transceiver communication mode.

(1) When "RPT-PTT" is ON, pressing PTT to stop receiving or transmission in cross-band repeater mode.

The transmission frequency is the frequency of the master band, release PTT key to access Two-way

cross-band repeater mode.

(2) When "RPT-SPK" is ON, any transceiver in cross-band repeater mode can receive the effective signals, and then the repeater receipt tone will be heard.

(3) The difference between directional cross-band repeater and two-way cross-band repeater modes is the transmitter and receiver is unfixed under two way cross-band repeater mode.

Directional cross-band repeater: The master frequency area A is the receiving frequency of the receiver in cross-band repeater mode, the sub-frequency area B is the transmitting frequency.

Two-way cross-band repeater mode:In standby, both master and sub areas are receivers, whichever area receives an effective carrier wave signal, the other area will be the transmitter and start transmitting.

Troubleshooting

Before assuming your transceiver is broken, please check your transceiver according to the following table; if the problem persists, you can reset the transceiver, which sometimes.

Fault	Solution
Reception prompt remains but speaker is silent	<ul style="list-style-type: none">» Check that the volume knob has been set to maximum.» Please reset CTCSS/DCS to check whether different channels from other group members have been set.» Check whether mute settings are correct.
Keypad is unresponsive	<ul style="list-style-type: none">» Check whether keypad has been locked.» Check whether other keys have been pressed.
Other voices (not from group members) appear in the channel.	<ul style="list-style-type: none">» Please change the CTCSS / DCS code.
In standby, automatic transmission without pressing PTT key	<ul style="list-style-type: none">» Please check if VOX function is active or VOX level is too low.

Fault

Solution

Can not enter scanning mode	» Please see if the scan group channel, Scan Add function is turned on.
Cannot set up the cross-band repeater	» Please make sure A/B area is on the cross-band repeaters operating frequency.
Cannot transmit in repeat mode	» Please check to see if the receivers squelch and CTCSS / DCS settings are correct.

Announcement

Endeavors to achieve the accuracy and completeness of this manual, but it is still not perfect for any possible omissions or printing errors. All the above is subject to be updated without prior notice.

MEMO

FCC Statement:

Any Changes or modifications not expressly approved by the party responsible for compliance could void the user's authority to operate the equipment.

This device complies with part 15 of the FCC Rules. Operation is subject to the following two conditions:

- (1) This device may not cause harmful interference, and
- (2) This device must accept any interference received, including interference that may cause undesired operation.

Note: This equipment has been tested and found to comply with the limits for a Class B digital device, pursuant to part 15 of the FCC Rules. These limits are designed to provide reasonable protection against harmful interference in a residential installation. This equipment generates, uses and can radiate radio frequency energy and, if not installed and used in accordance with the instructions, may cause harmful interference to radio communications. However, there is no guarantee that interference will not occur in a particular installation. If this equipment does cause harmful interference to radio or television reception, which can be determined by turning the equipment off and on, the user is encouraged to try to correct the interference by one or more of the following measures:

- Reorient or relocate the receiving antenna.
- Increase the separation between the equipment and receiver.
- Connect the equipment into an outlet on a circuit different from that to which the receiver is connected.
- Consult the dealer or an experienced radio/TV technician for help.