



FCC Test Report

Report No.: AGC01870140601FE08

FCC ID : WVTWOUXUN10

TYPE OF AUTHORIZATION : Certification

APPLICATION PURPOSE : Original Equipment

PRODUCT DESIGNATION : TWO-WAY RADIO

BRAND NAME : WOUXUN

TEST MODEL : KG-UV8D, KG-UV7D, KG-UV9D, KG-UV83, KG-UV86,
KG-UV66, KG-UV899, KG-UV8A, KG-UV8E, KG-UV8F,
KG-UV8G, KG-UV8H, KG-UV8K

CLIENT : QUANZHOU WOUXUN ELECTRONICS CO., LTD.

DATE OF ISSUE : Jun.07, 2014

STANDARD(S) : FCC Part 15 Rules

REPORT VERSION : V 1.0

Attestation of Global Compliance (Shenzhen) Co., Ltd



CAUTION:

This report shall not be reproduced except in full without the written permission of the test laboratory and shall not be quoted out of context.

Report Revise Record

Report Version	Revise Time	Issued Date	Valid Version	Notes
V1.0	/	Jun.07, 2014	Valid	Original Report

TABLE OF CONTENTS

1. VERIFICATION OF COMPLIANCE4

2. PRODUCT INFORMATION5

3. TEST FACILITY6

4. SUPPORT EQUIPMENT LIST7

5. SYSTEM DESCRIPTION7

6. SUMMARY OF TEST RESULTS8

7. FCC LINE CONDUCTED EMISSION TEST9

 7.1. TEST EQUIPMENT OF LINE CONDUCTED EMISSION TEST9

 7.2 .LIMITS OF LINE CONDUCTED EMISSION TEST9

 7.3. BLOCK DIAGRAM OF LINE CONDUCTED EMISSION TEST9

 7.4. PROCEDURE OF LINE CONDUCTED EMISSION TEST10

 7.5 TEST RESULT OF LINE CONDUCTED EMISSION TEST11

8. FCC RADIATED EMISSION TEST13

 8.1. TEST EQUIPMENT OF RADIATED EMISSION13

 8.2. LIMITS OF RADIATED EMISSION TEST13

 8.3 BLOCK DIAGRAM OF RADIATED EMISSION TEST13

 8.4 PROCEDURE OF RADIATED EMISSION TEST14

 8.5 TEST RESULT OF RADIATED EMISSION TEST15

9. ANTENNA CONDUCTED POWER FOR RECEIVERS19

APPENDIX 122

PHOTOGRAPHS OF TEST SETUP22

APPENDIX 223



PHOTOGRAPHS OF EUT23

1. VERIFICATION OF COMPLIANCE

Applicant	QUANZHOU WOUXUN ELECTRONICS CO., LTD.
Address	NO.928 NANHUAN ROAD, JIANGNAN HIGH TECHNOLOGY INDUSTRY PARK, QUANZHOU, FUJIAN 362000, CHINA.
Manufacturer	QUANZHOU WOUXUN ELECTRONICS CO., LTD.
Address	NO.928 NANHUAN ROAD, JIANGNAN HIGH TECHNOLOGY INDUSTRY PARK, QUANZHOU, FUJIAN 362000, CHINA.
Product Designation	TWO-WAY RADIO
Brand name:	WOUXUN
Test Model	KG-UV8D
Series Model :	KG-UV7D, KG-UV9D, KG-UV83, KG-UV86, KG-UV66, KG-UV899, KG-UV8A, KG-UV8E, KG-UV8F, KG-UV8G, KG-UV8H, KG-UV8K
Difference description:	All the same except for the model name.
Hardware Version:	N/A
Software Version:	N/A
Measurement Procedure:	ANSI C63.4: 2003
Date of test:	Jun.04, 2014 to Jun.06, 2014
Deviation:	None
Condition of Test Sample	Normal

The above equipment was tested by Attestation Of Global Compliance (Shenzhen) Co., Ltd. for compliance with the requirements set forth in the FCC Rules and Regulations Part 15, the measurement procedure according to ANSI C63.4:2003. This said equipment in the configuration described in this report shows the maximum emission levels emanating from equipment are within the compliance requirements.

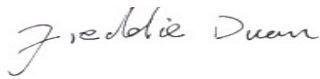
The test results of this report relate only to the tested sample identified in this report.

Tested by	
	_____ Freddie Duan Jun.07, 2014
Checked By	
	_____ Kidd Yang Jun.07, 2014
Authorized By	
	_____ Solger Zhang Jun.07, 2014

2. PRODUCT INFORMATION

The EUT is a TWO-WAY RADIO designed for voice communication. It is designed by way of utilizing the FM modulation achieves the system operating.

A major technical description of EUT is described as following:

Communication Type	Voice / Tone only
Modulation	FM
RX Frequency Range	144-148MHz/420-450MHz
Emission Type	10K5F8E
Antenna Designation	Detachable
Power Supply	DC 7.4V by battery
Adapter Parameter	Input: 100-240V, 50/60HZ Output: 8.4V, 0.45A

I/O Port Information (Applicable Not Applicable)

I/O Port of EUT			
I/O Port Type	Q'TY	Cable	Tested with
DC Input Port	1	1.5m, Unshielded	
Antenna Connect Port	1	0	1
Hand-Operated Microphone Connect Port	2	0	2

3. TEST FACILITY

Facility Attestation of Global Compliance (Shenzhen) Co., Ltd

Location 1: 2/F., Building 2, No.1-No.4, Chaxi Sanwei Technical Industrial Park, Gushu,
Xixiang, Bao'an District, Shenzhen, Guangdong, China

Location 2: B112-B113, Building 12, Baoan Building Materials Center, No.1 of Xixiang Inner
Ring Road, Baoan District, Shenzhen, Guangdong, P.R.China

Description: The test site is constructed and calibrated to meet the FCC requirements in
documents ANSI C63.4:2003.

Site Filing: The FCC Registration Number is 259865

Instrument Tolerance: All measuring equipment is in accord with ANSI C63.4 requirements that meet
industry regulatory agency and accreditation agency requirement.

4. SUPPORT EQUIPMENT LIST

Device Type	Manufacturer	Model Name	Serial No.	Data Cable	Power Cable
--	--	--	--	--	--

5. SYSTEM DESCRIPTION

EUT test procedure:

1. Connect EUT and peripheral devices.
2. Power on the EUT, the EUT begins to work.
3. Running data transmission and make sure the EUT normal working.

EMC TEST MODES

No.	TEST MODES
1	Scanning mode + Receiving mode

Note: Only the result of the worst case was recorded in the report.

6. SUMMARY OF TEST RESULTS

FCC Rules	Description Of Test	Result
§15.107	Conduction Emission	Compliant
§15.109	Radiated Emission	Compliant
§15.111	Antenna Conducted Power for receivers	Compliant
§15.121	Scanning receivers and frequency converters used with scanning receivers.	Compliant

7. FCC LINE CONDUCTED EMISSION TEST

7.1. TEST EQUIPMENT OF LINE CONDUCTED EMISSION TEST

Description	Manufacturer	Model	Identifier	Cal. Date	Cal. Due
EMI Test Receiver	Rohde & Schwarz	ESCI	100694	07/17/2013	07/16/2014
LISN	Rohde & Schwarz	ESH2-Z5	862060/020	07/17/2013	07/16/2014

7.2 .LIMITS OF LINE CONDUCTED EMISSION TEST

Frequency	Maximum RF Line Voltage	
	Q.P.(dBuV)	Average(dBuV)
150kHz~500kHz	66-56	56-46
500kHz~5MHz	56	46
5MHz~30MHz	60	50

**Note: 1. The lower limit shall apply at the transition frequency.

2. The limit decreases linearly with the logarithm of the frequency in the range 0.15 MHz to 0.50 MHz

7.3. BLOCK DIAGRAM OF LINE CONDUCTED EMISSION TEST

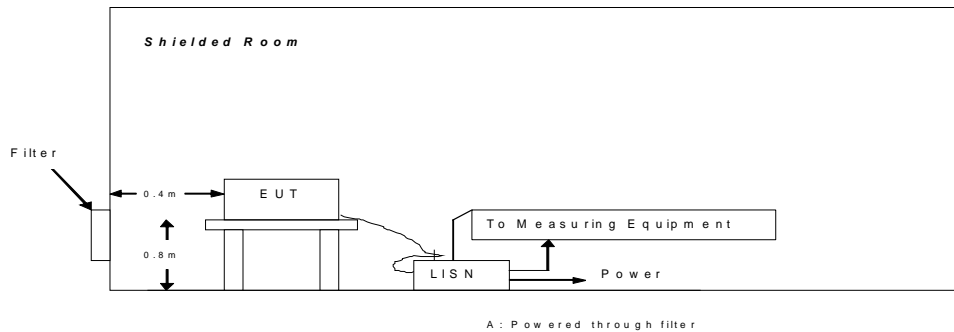

7.4. PROCEDURE OF LINE CONDUCTED EMISSION TEST

- 1) The equipment was set up as per the test configuration to simulate typical actual usage per the user's manual. When the EUT is a tabletop system, a wooden table with a height of 0.8 meters is used and is placed on the ground plane as per ANSI C63.4 (see Test Facility for the dimensions of the ground plane used). When the EUT is a floor-standing equipment, it is placed on the ground plane which has a 3-12 mm non-conductive covering to insulate the EUT from the ground plane.
- 2) Support equipment, if needed, was placed as per ANSI C63.4.
- 3) All I/O cables were positioned to simulate typical actual usage as per ANSI C63.4.
The EUT received power through a Line Impedance Stabilization Network (LISN) that was grounded to the protect earth.
- 4) The EUT test program was started. Emissions were measured on each current carrying line of the EUT using a spectrum Analyzer / Receiver connected to the LISN powering the EUT. The LISN has two monitoring points: Line 1 (Hot Side) and Line 2 (Neutral Side). Two scans were taken: one with Line 1 connected to Analyzer / Receiver and Line 2 connected to a 50 ohm load; the second scan had Line 1 connected to a 50 ohm load and Line 2 connected to the Analyzer / Receiver.
- 5) Analyzer / Receiver scanned from 150 kHz to 30MHz for emissions in each of the test modes.
- 6) During the above scans, the emissions were maximized by cable manipulation.
- 7) A scan was taken on both power lines, Line 1 and Line 2, recording at least the six highest emissions.
- 8) Emission frequency and amplitude were recorded into a computer in which correction factors were used to calculate the emission level and compare reading to the applicable limit. If EUT emission level was less -2dB to the A.V. limit in Peak mode, then the emission signal was re-checked using Q.P and Average detector.

The test data of the worst case condition (mode 1) was reported on the following Data page.

7.5 TEST RESULT OF LINE CONDUCTED EMISSION TEST

Line Conducted Emission Test Line 1-L

SCAN TABLE: "Voltage (150K-30M) FIN"

Short Description: 9k-30M Voltage

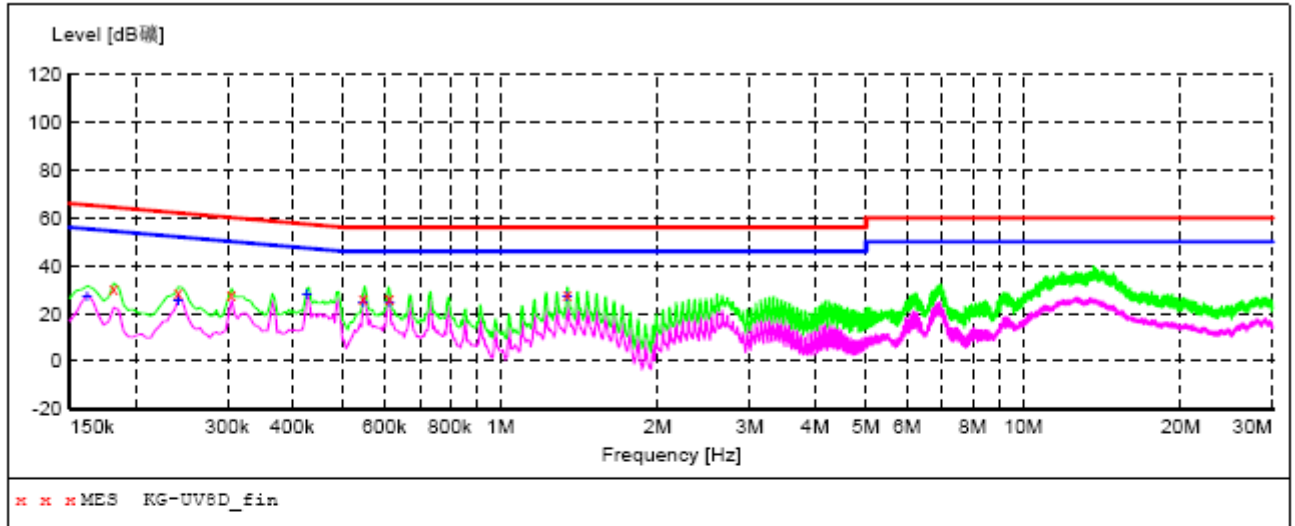

MEASUREMENT RESULT: "KG-UV8D_fin"

2014-6-5 11:56

Frequency MHz	Level dBμV	Transd dB	Limit dBμV	Margin dB	Detector	Line	PE
0.182000	30.90	0.2	64	33.5	QP	L1	GND
0.242000	29.10	0.2	62	32.9	QP	L1	GND
0.306000	27.70	0.2	60	32.4	QP	L1	GND
0.546000	26.60	0.2	56	29.4	QP	L1	GND
0.614000	26.20	0.2	56	29.8	QP	L1	GND
1.342000	27.90	0.2	56	28.1	QP	L1	GND

MEASUREMENT RESULT: "KG-UV8D_fin2"

2014-6-5 11:56

Frequency MHz	Level dBμV	Transd dB	Limit dBμV	Margin dB	Detector	Line	PE
0.162000	27.40	0.2	55	28.0	AV	L1	GND
0.242000	25.80	0.2	52	26.2	AV	L1	GND
0.426000	28.00	0.2	47	19.3	AV	L1	GND
0.546000	24.90	0.2	46	21.1	AV	L1	GND
0.614000	24.60	0.2	46	21.4	AV	L1	GND
1.342000	26.90	0.2	46	19.1	AV	L1	GND

Line Conducted Emission Test Line 2-N

SCAN TABLE: "Voltage (150K-30M) FIN"
Short Description: 9k-30M Voltage

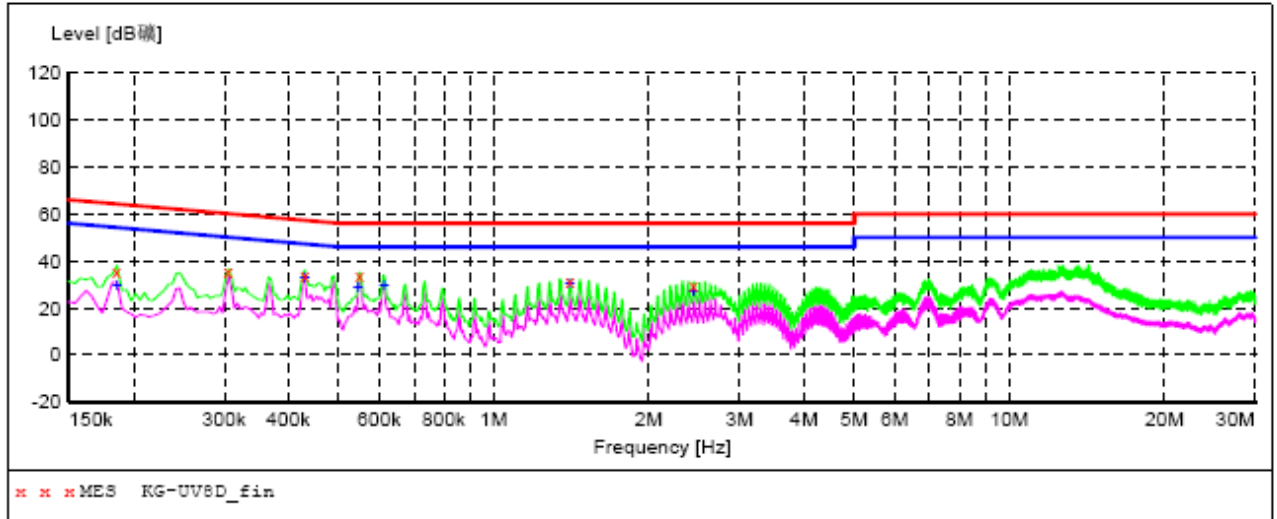

MEASUREMENT RESULT: "KG-UV8D_fin"

2014-6-5 11:37

Frequency MHz	Level dB	Transd dB	Limit dB	Margin dB	Detector	Line	PE
0.186000	35.40	0.2	64	28.8	QP	N	GND
0.306000	35.40	0.2	60	24.7	QP	N	GND
0.430000	34.30	0.2	57	23.0	QP	N	GND
0.550000	33.70	0.2	56	22.3	QP	N	GND
1.406000	31.10	0.2	56	24.9	QP	N	GND
2.442000	29.50	0.3	56	26.5	QP	N	GND

MEASUREMENT RESULT: "KG-UV8D_fin2"

2014-6-5 11:37

Frequency MHz	Level dB	Transd dB	Limit dB	Margin dB	Detector	Line	PE
0.186000	29.80	0.2	54	24.4	AV	N	GND
0.430000	32.70	0.2	47	14.6	AV	N	GND
0.546000	29.10	0.2	46	16.9	AV	N	GND
0.614000	29.90	0.2	46	16.1	AV	N	GND
1.406000	30.40	0.2	46	15.6	AV	N	GND
2.442000	27.40	0.3	46	18.6	AV	N	GND

8. FCC RADIATED EMISSION TEST

8.1. TEST EQUIPMENT OF RADIATED EMISSION

Description	Manufacturer	Model	Identifier	Cal. Date	Cal. Due
PSA SERIES SPECTRUM ANALYZER	AGILENT	E4440A	US41421290	07/17/2013	07/16/2014
ANTENNA	A.H.	SAS-521-4	26	07/17/2013	07/16/2014
HORN ANTENNA	EM	EM-AH-10180	67	04/19/2014	04/18/2015
AMPLIFIER	EM	EM30180	0607030	07/18/2013	07/17/2014
POSITIONING CONTROLLER	MF	MF-7802	MF780208147	07/17/2013	07/16/2014

8.2. LIMITS OF RADIATED EMISSION TEST

Frequency (MHz)	Distance (m)	Maximum Field Strength Limit (dBuV/m/ Q.P.)
30~88	3	40.0
88~216	3	43.5
216~960	3	46.0
Above 960	3	54.0

**Note: The lower limit shall apply at the transition frequency.

8.3 BLOCK DIAGRAM OF RADIATED EMISSION TEST

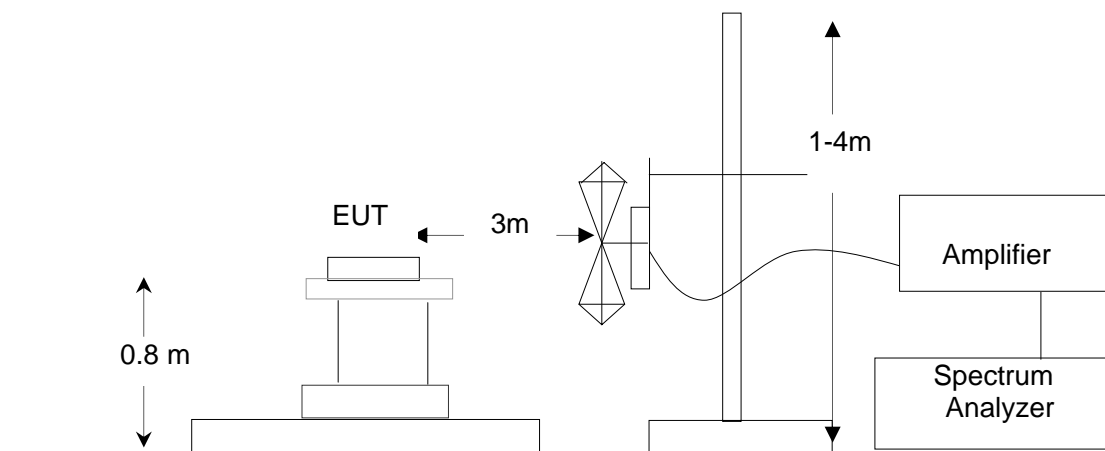

8.4 PROCEDURE OF RADIATED EMISSION TEST

- 1) The equipment was set up as per the test configuration to simulate typical actual usage per the user's manual. When the EUT is a tabletop system, a wooden turntable with a height of 0.8 meters is used which is placed on the ground plane as per ANSI C63.4 (see Test Facility for the dimensions of the ground plane used). When the EUT is floor-standing equipment, it is placed on the ground plane which has a 3-12 mm non-conductive covering to insulate the EUT from the ground plane.
- 2) Support equipment, if needed, was placed as per ANSI C63.4.
- 3) All I/O cables were positioned to simulate typical actual usage as per ANSI C63.4.
- 4) The EUT received DC 13.8V by DC source. All support equipments received AC 120V/60Hz power from socket under the turntable, if any.
- 5) The antenna was placed at 3 meter away from the EUT as stated in FCC Part 15. The antenna connected to the Analyzer via a cable and at times a pre-amplifier would be used.
- 6) The Analyzer / Receiver quickly scanned from 30MHz to 1000MHz. The EUT test program was started. Emissions were scanned and measured rotating the EUT to 360 degrees and positioning the antenna 1 to 4 meters above the ground plane, in both the vertical and the horizontal polarization, to maximize the emission reading level.
- 7) The test mode(s) were scanned during the test:
- 8) Recorded at least the six highest emissions. Emission frequency, amplitude, antenna position, polarization and turntable position were recorded into a computer in which correction factors were used to calculate the emission level and compare reading to the applicable limit and Q.P./Peak reading is presented.

The test data of the worst case condition(mode 1) was reported on the following Data page

8.5 TEST RESULT OF RADIATED EMISSION TEST

Radiated Emission Test –Horizontal -3m Below 1G

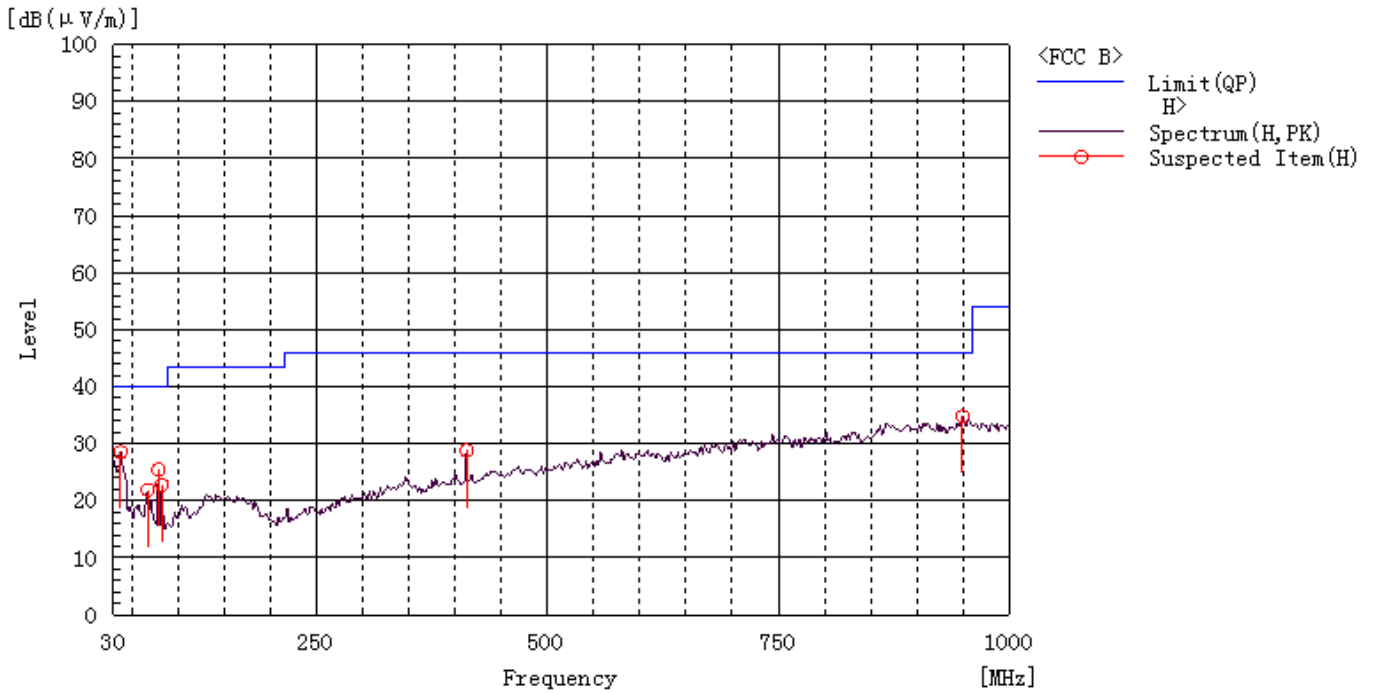

Frequency MHz	Polarization	Reading dB(uV)	Factor dB (1/m)	Level dB(uV/m)	Limit dB(uV/m) PK	Margin dB PK	Pass/Fail	Height cm	Angle deg
37.760	H	7.4	21.2	28.6	40.0	11.4	Pass	100.0	205.1
78.500	H	15.6	9.9	25.5	40.0	14.5	Pass	200.0	109.1
82.380	H	13.1	9.7	22.8	40.0	17.2	Pass	200.0	109.1
949.560	H	6.1	28.7	34.8	46.0	11.2	Pass	200.0	9.9
66.860	H	11.2	10.7	21.9	40.0	18.1	Pass	100.0	317.7
412.180	H	10.1	18.7	28.8	46.0	17.2	Pass	200.0	9.9

Radiated Emission Test –Vertical -3m Below 1G

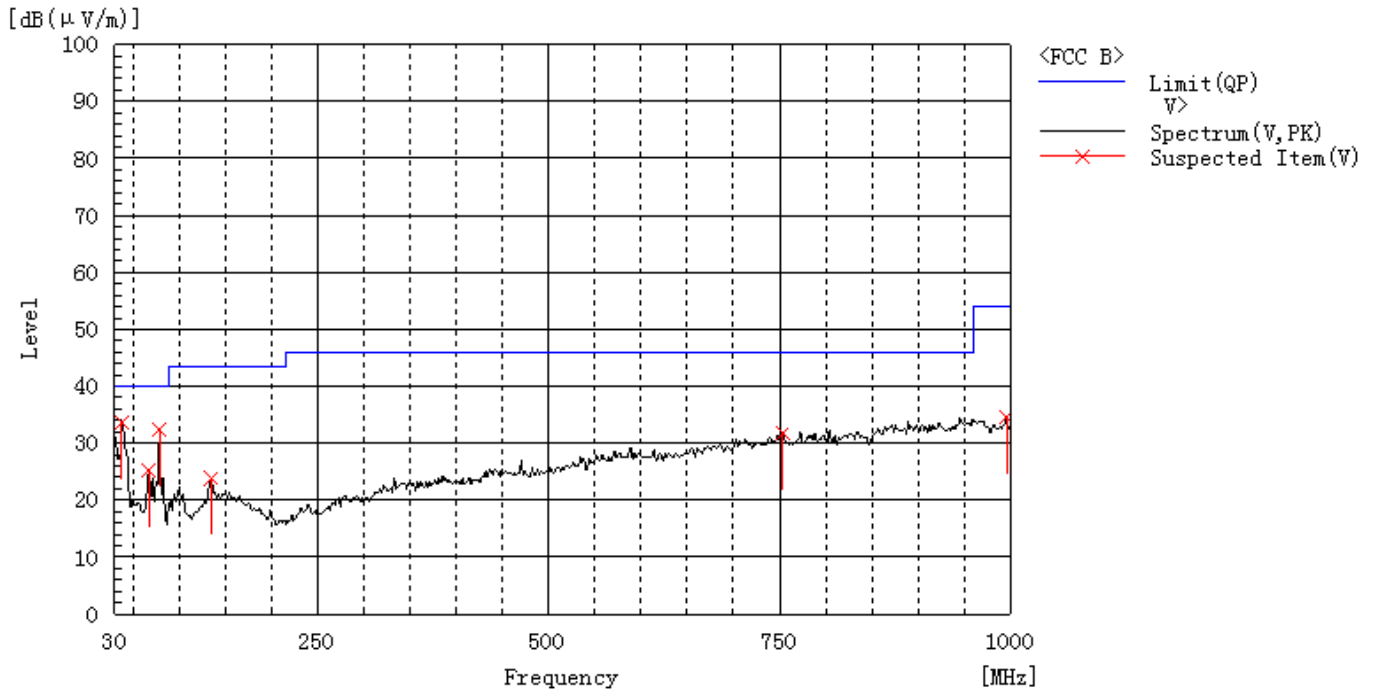

Frequency MHz	Polarization	Reading dB(uV)	Factor dB (1/m)	Level dB(uV/m)	Limit dB(uV/m) PK	Margin dB PK	Pass/Fail	Height cm	Angle deg
37.760	V	12.5	21.2	33.7	40.0	6.3	Pass	100.0	345.4
78.500	V	22.5	9.9	32.4	40.0	7.6	Pass	200.0	120.9
134.760	V	9.3	14.6	23.9	43.5	19.6	Pass	100.0	36.7
996.120	V	6.2	28.3	34.5	54.0	19.5	Pass	100.0	181.1
66.860	V	14.5	10.7	25.2	40.0	14.8	Pass	200.0	299.9
753.620	V	6.1	25.6	31.7	46.0	14.3	Pass	200.0	144.1

Radiated Emission Test –Horizontal -3m Above 1G

[dB(μ V/m)]

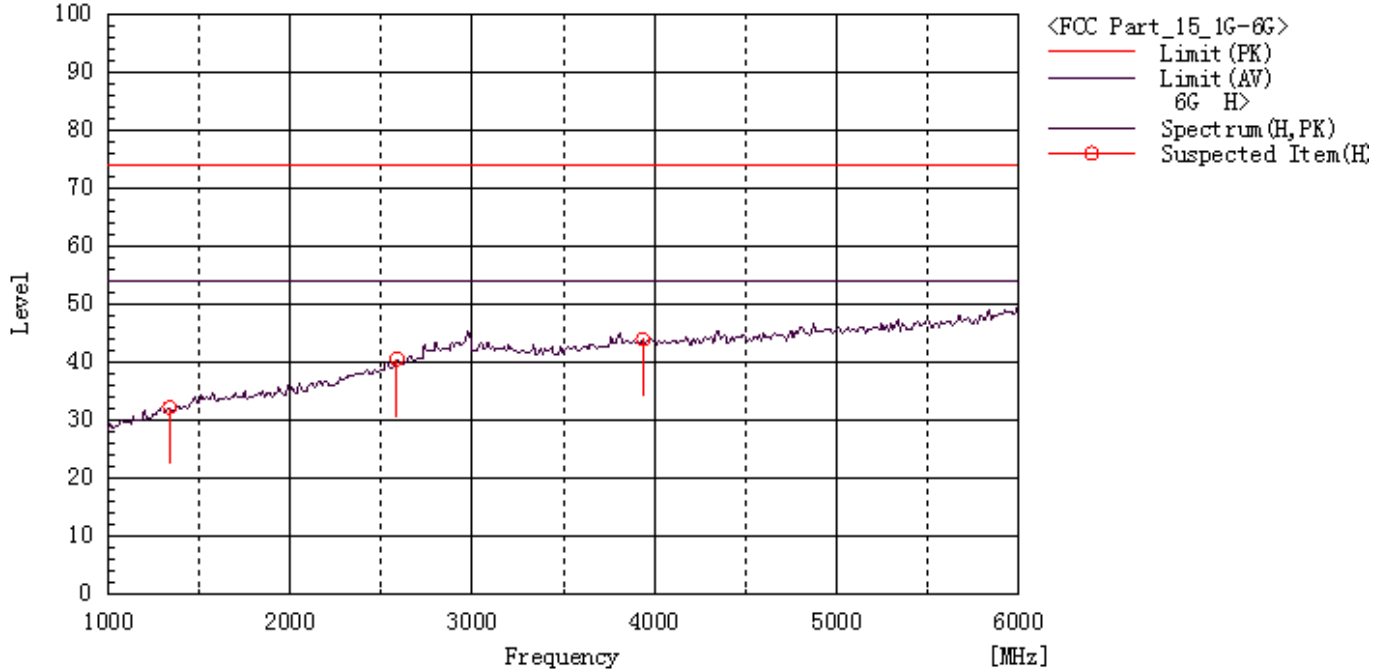

Frequency MHz	Polarization	Reading dB(uV)	Factor dB (1/m)	Level dB(uV/m)	Limit dB(uV/m) PK	Margin dB PK	Pass/Fail	Height cm	Angle deg
1337.500	H	37.3	-5.2	32.1	74.0	41.9	Pass	200.0	211.2
2587.500	H	39.8	0.7	40.5	74.0	33.5	Pass	100.0	250.6
3937.500	H	37.3	6.5	43.8	74.0	30.2	Pass	200.0	140.3

Radiated Emission Test –Vertical -3m Above 1G

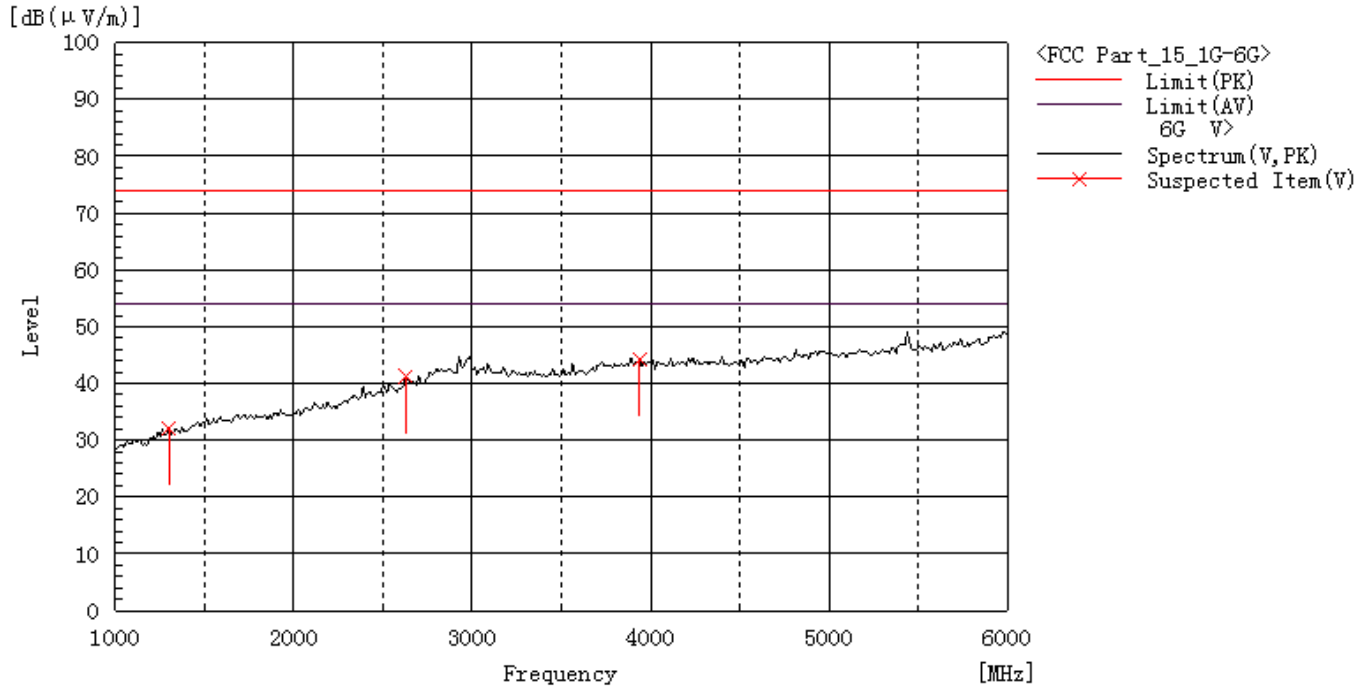

Frequency MHz	Polarization	Reading dB(uV)	Factor dB (1/m)	Level dB(uV/m)	Limit dB(uV/m) PK	Margin dB PK	Pass/Fail	Height cm	Angle deg
1300.000	V	37.5	-5.4	32.1	74.0	41.9	Pass	200.0	289.5
2625.000	V	40.1	1.1	41.2	74.0	32.8	Pass	100.0	246.1
3937.500	V	37.7	6.5	44.2	74.0	29.8	Pass	200.0	289.5

9. ANTENNA CONDUCTED POWER FOR RECEIVERS

LIMIT

The antenna conducted power of the receiver as defined in §15.111 shall not exceed the values given in the following tables

Frequency Range	9 KHz to 2GHz
Limit	2.0 nW (-57 dBm)

MEASUREMENT EQUIPMENT USED

Name of Equipment	Manufacturer	Model	Serial Number	Calibration Due
EXA Signal Analyzer	Aglient	N9010A	MY53470504	03/28/2015

Remark: Each piece of equipment is scheduled for calibration once a year.

TEST CONFIGURATION

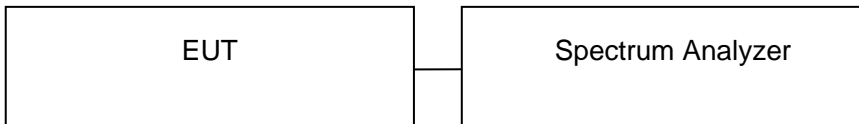

TEST PROCEDURE

1. The receiver antenna terminal connected to a spectrum analyzer.
2. The test data of the worst case condition(mode 1) was reported on the following Data page.

Conducted Measurement (30MHz to 1GHz)

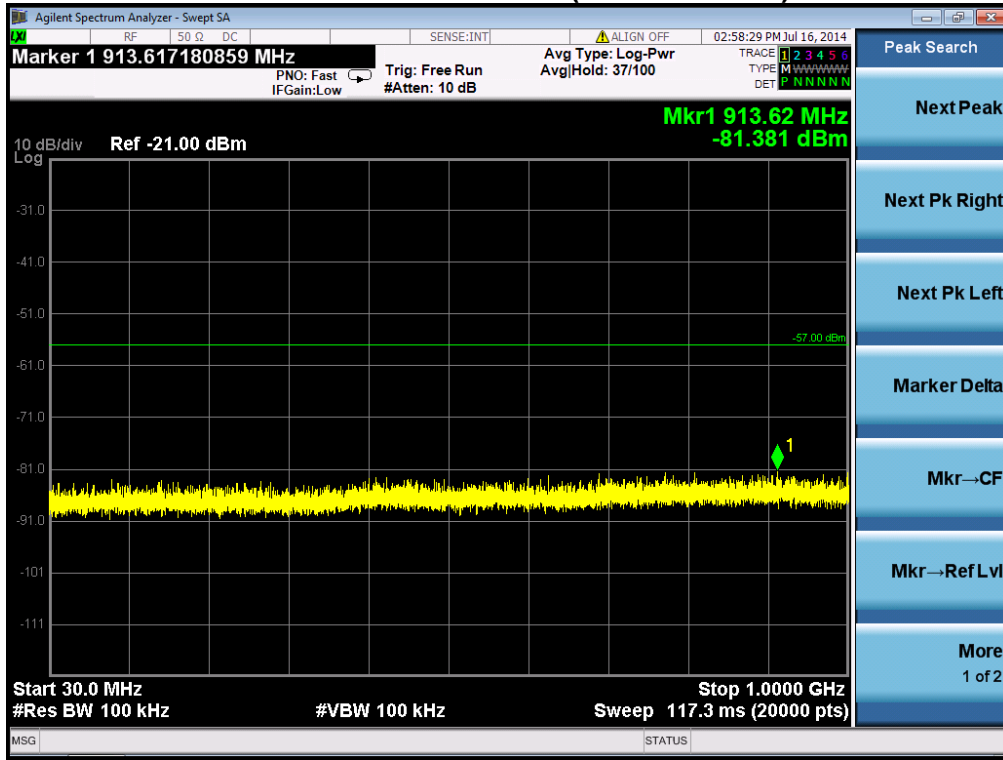

Conducted Measurement (1GHz to 2GHz)

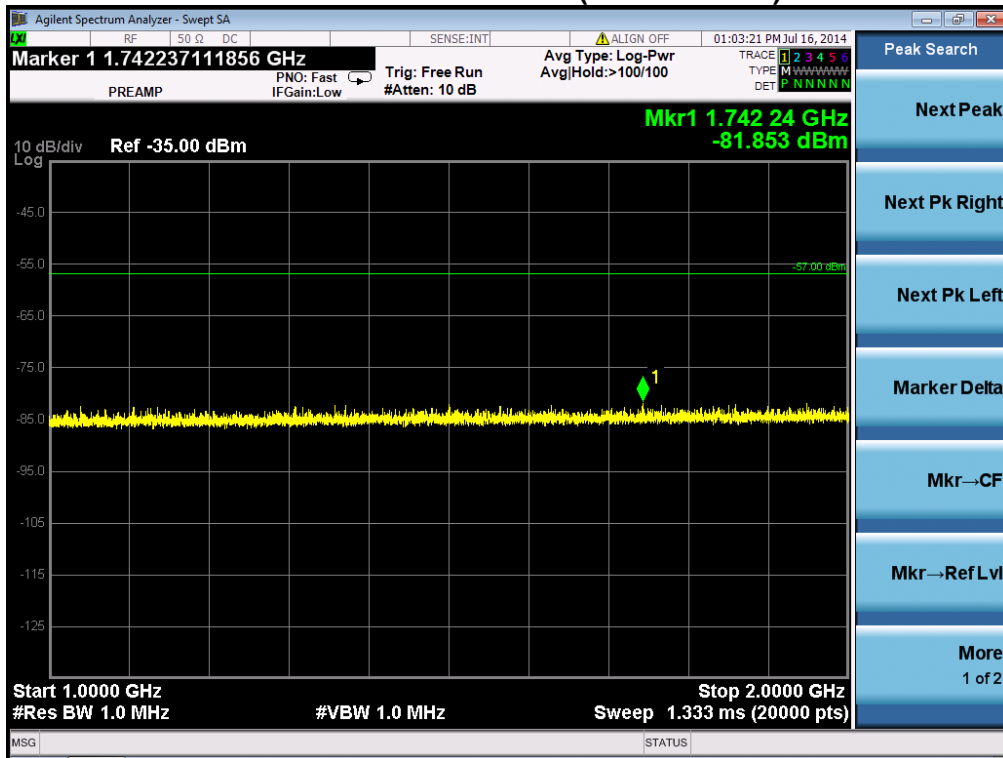

PASS

APPENDIX 1 PHOTOGRAPHS OF TEST SETUP

RADIATED TEST SETUP

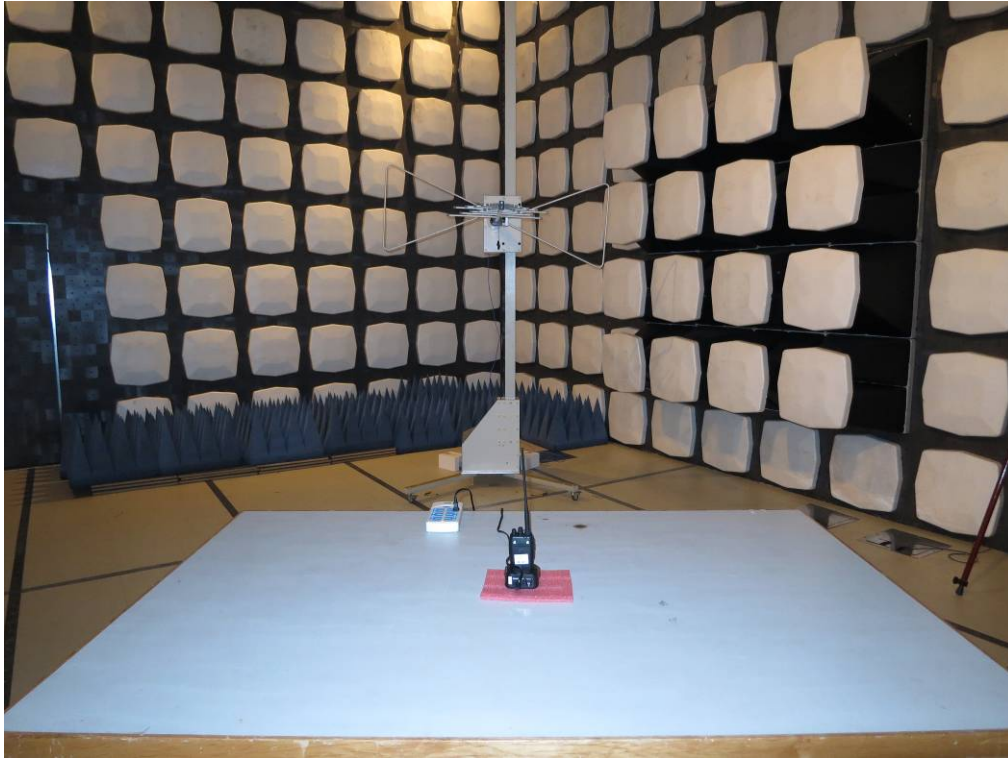

CONDUCTED EMISSION



APPENDIX 2 PHOTOGRAPHS OF EUT

WHOLE VIEW OF EUT



TOP VIEW OF EUT



BOTTOM VIEW OF EUT



FRONT VIEW OF EUT



BACK VIEW OF EUT



LEFT VIEW OF EUT



RIGHT VIEW OF EUT



OPEN VIEW-1 OF EUT



OPEN VIEW-2 OF EUT



INTERNAL VIEW-1 OF EUT

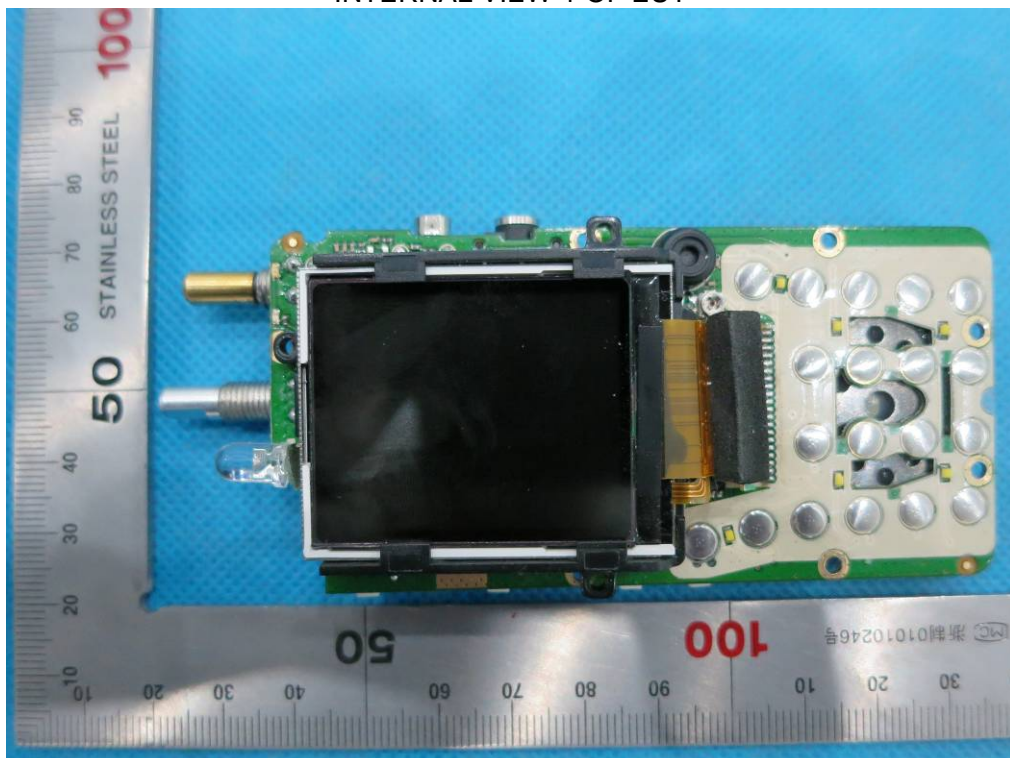

INTERNAL VIEW-2 OF EUT

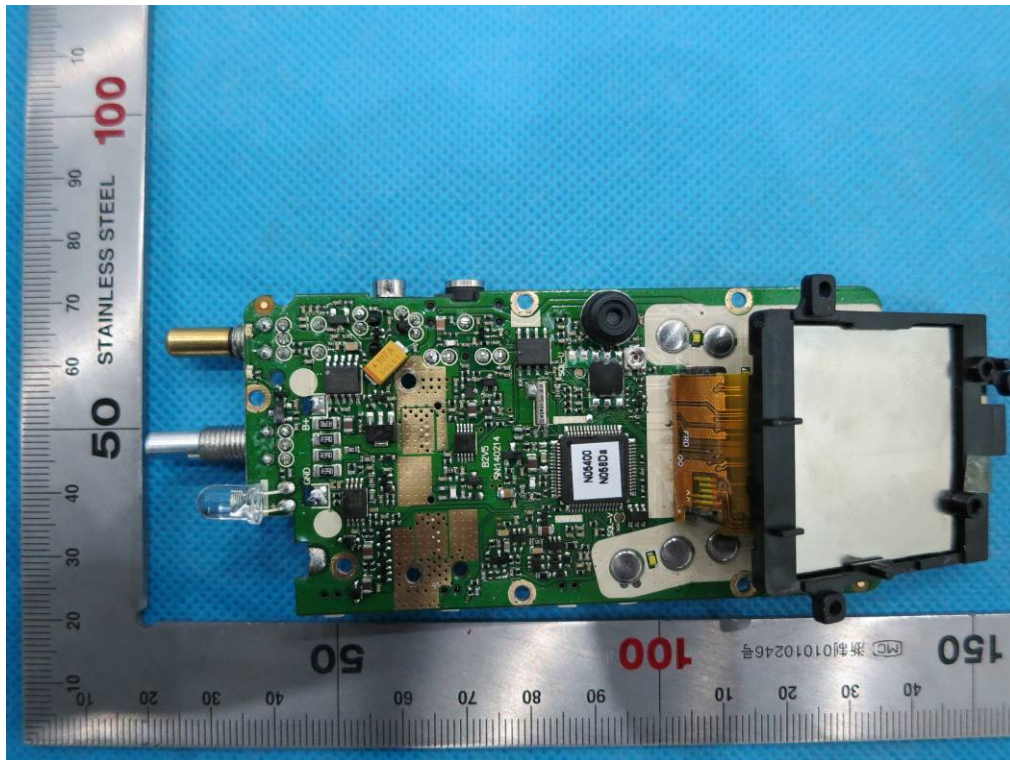

INTERNAL VIEW-3 OF EUT

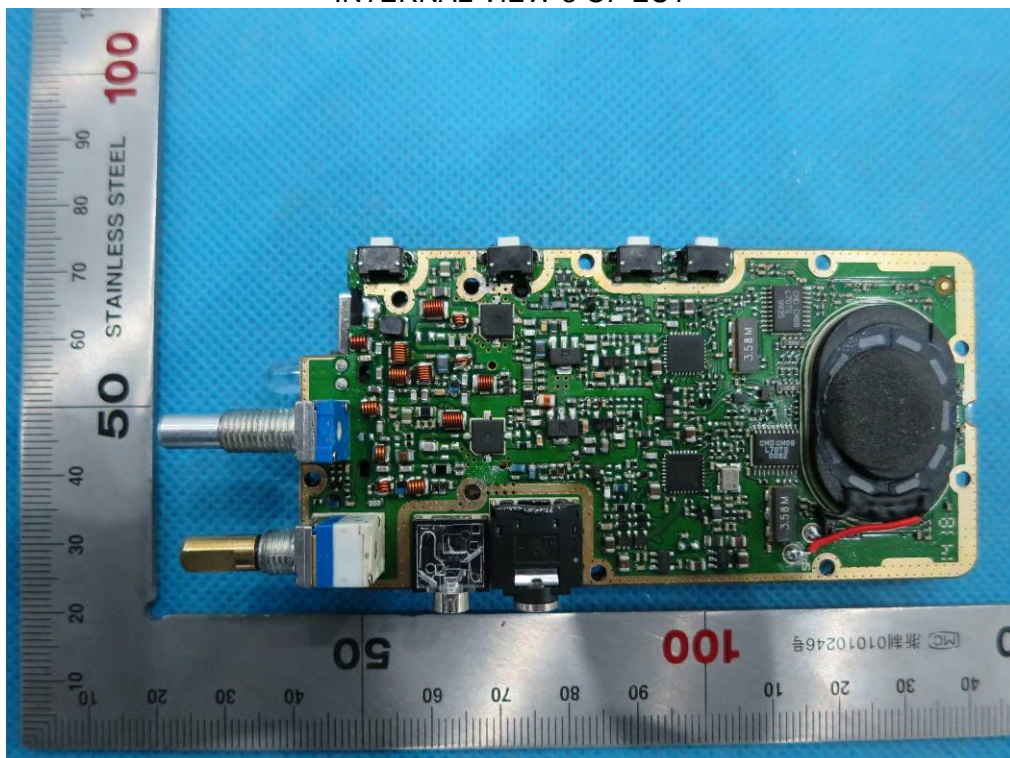

FRONT VIEW OF EUT (ADAPTER)



BACK VIEW OF EUT (ADAPTER)



----END OF REPORT----