



# FCC RF Test Report

APPLICANT : Brightstar Corporation  
EQUIPMENT : mobile phone  
BRAND NAME : Avvio  
MODEL NAME : 515  
FCC ID : WVBAVVIO515  
STANDARD : FCC 47 CFR Part 2, 22(H), 24(E)  
CLASSIFICATION : PCS Licensed Transmitter Held to Ear (PCE)  
Tx/Rx FREQUENCY RANGE : GSM850 : 824.2 ~ 848.8 MHz /  
869.2 ~ 893.8 MHz  
GSM1900 : 1850.2 ~ 1909.8 MHz /  
1930.2 ~ 1989.8 MHz  
MAX. ERP/EIRP POWER : GSM850 (GSM) : 0.46 W  
GSM1900 (GSM) : 0.73 W  
EMISSION DESIGNATOR : 246KGXW

The product was received on Sep. 23, 2011 and completely tested on Sep. 28, 2011. We, SPORTON INTERNATIONAL (KUNSHAN) INC., would like to declare that the tested sample has been evaluated in accordance with the procedures given in ANSI / TIA / EIA-603-C-2004 and shown compliance with the applicable technical standards.

The test results in this report apply exclusively to the tested model / sample. Without written approval of SPORTON INTERNATIONAL (KUNSHAN) INC., the test report shall not be reproduced except in full.

Reviewed by:

Jones Tsai / Manager



**SPORTON INTERNATIONAL (KUNSHAN) INC.**  
**No. 3-2, PingXiang Road, Kunshan, Jiangsu Province, P.R.C.**



# TABLE OF CONTENTS

**REVISION HISTORY..... 3**

**SUMMARY OF TEST RESULT ..... 4**

**1 GENERAL DESCRIPTION ..... 5**

    1.1 Applicant..... 5

    1.2 Manufacturer ..... 5

    1.3 Feature of Equipment Under Test..... 5

    1.4 Testing Site ..... 6

    1.5 Applied Standards ..... 6

    1.6 Ancillary Equipment List..... 6

**2 TEST CONFIGURATION OF EQUIPMENT UNDER TEST ..... 7**

    2.1 Test Mode..... 7

    2.2 Connection Diagram of Test System ..... 8

**3 TEST RESULT..... 9**

    3.1 Conducted Output Power Measurement..... 9

    3.2 Effective Radiated Power and Effective Isotropic Radiated Power Measurement ..... 11

    3.3 Occupied Bandwidth Measurement ..... 14

    3.4 Band Edge Measurement..... 17

    3.5 Conducted Emission Measurement ..... 20

    3.6 Field Strength of Spurious Radiation Measurement ..... 26

    3.7 Frequency Stability Measurement..... 32

**4 LIST OF MEASURING EQUIPMENTS ..... 37**

**5 UNCERTAINTY OF EVALUATION..... 38**

**APPENDIX A. PHOTOGRAPHS OF EUT**

**APPENDIX B. SETUP PHOTOGRAPHS**



**SUMMARY OF TEST RESULT**

Report Section	FCC Rule	Description	Limit	Result	Remark
3.1	§2.1046	Conducted Output Power	N/A	PASS	-
3.2	§22.913(a)(2)	Effective Radiated Power	< 7 Watts	PASS	-
3.2	§24.232(c)	Equivalent Isotropic Radiated Power	< 2 Watts	PASS	-
3.3	§2.1049 §22.917(a) §24.238(a)	Occupied Bandwidth	N/A	PASS	-
3.4	§2.1051 §22.917(a) §24.238(a)	Band Edge Measurement	$< 43+10\log_{10}(P[\text{Watts}])$	PASS	-
3.5	§2.1051 §22.917(a) §24.238(a)	Conducted Emission	$< 43+10\log_{10}(P[\text{Watts}])$	PASS	-
3.6	§2.1053 §22.917(a) §24.238(a)	Field Strength of Spurious Radiation	$< 43+10\log_{10}(P[\text{Watts}])$	PASS	Under limit 9.14 dB at 3760 MHz
3.7	§2.1055 §22.355 §24.235	Frequency Stability for Temperature & Voltage	< 2.5 ppm	PASS	-



# 1 General Description

## 1.1 Applicant

**Brightstar Corporation**  
9725 NW 117th Ave., Miami, Florida, United States

## 1.2 Manufacturer

**Skycom Telecommunications Co Limited**  
Room 604, East Block, Shengtang Building, Futian District, Shenzhen, China

## 1.3 Feature of Equipment Under Test

Product Feature & Specification	
Equipment	mobile phone
Brand Name	Avvio
Model Name	515
FCC ID	WVBAVVIO515
Tx Frequency	GSM850 : 824 MHz ~ 849 MHz GSM1900 : 1850 MHz ~ 1910 MHz
Rx Frequency	GSM850 : 869 MHz ~ 894 MHz GSM1900 : 1930 MHz ~ 1990 MHz
Maximum Output Power to Antenna	GSM850 : 32.49 dBm GSM1900 : 29.47 dBm
Maximum ERP/EIRP	GSM850 (GSM) : 0.46 W (26.63 dBm) GSM1900 (GSM) : 0.73 W (28.61 dBm)
Antenna Type	Fixed Internal Antenna
HW Version	X321 V0.2
SW Version	X321_7D_BT_FM_NMI60X_6432_LCD220X176_TC_COMC EL_V10_110920
Type of Modulation	GMSK
Type of Emission	246KGXW
EUT Stage	Identical Prototype

### Remark:

1. For other wireless features of this EUT, the test report will be issued separately.
2. This test report recorded only product characteristics and test results of PCS Licensed Transmitter Held to Ear (PCE).
3. The above EUT's information was declared by manufacturer. Please refer to the specifications or user's manual for more detailed description.

### 1.4 Testing Site

<b>Test Site</b>	SPORTON INTERNATIONAL (KUNSHAN) INC.	
<b>Test Site Location</b>	No. 3-2, PingXiang Road, Kunshan, Jiangsu Province, P.R.C. TEL: +86-0512-5790-0158 FAX: +86-0512-5790-0958	
<b>Test Site No.</b>	<b>Sporton Site No.</b>	
	TH01-KS	03CH01-KS

### 1.5 Applied Standards

According to the specifications of the manufacturer, the EUT must comply with the requirements of the following standards:

- 47 CFR Part 2, 22(H), 24(E)
- ANSI / TIA / EIA-603-C-2004

**Remark:** All test items were verified and recorded according to the standards and without any deviation during the test.

### 1.6 Ancillary Equipment List

Item	Equipment	Trade Name	Model No.	FCC ID	Data Cable	Power Cord
1.	System Simulator	R&S	CMU200	N/A	N/A	Unshielded, 1.8 m

## 2 Test Configuration of Equipment Under Test

### 2.1 Test Mode

During all testing, EUT is in link mode with base station emulator at maximum power level. The spurious emission measurements were carried out in semi-anechoic chamber with 3-meter test range, and EUT is rotated on three test planes to find out the worst emission.

Frequency range investigated for radiated emission is as follows:

1. 30 MHz to 9000 MHz for GSM850.
2. 30 MHz to 19000 MHz for GSM1900.

Test Modes		
Band	Radiated TCs	Conducted TCs
GSM 850	■ GSM Link	■ GSM Link
GSM 1900	■ GSM Link	■ GSM Link

**Note:**

1. The maximum power level is GSM mode for GMSK link, only this mode was used for all tests.
2. Because there are individual antennas for each WWAN and Bluetooth, the co-location test modes are not required.

The conducted power tables are as follows:

Conducted Power (*Unit: dBm)						
Band	GSM850			GSM1900		
Channel	128	189	251	512	661	810
Frequency	824.2	836.4	848.8	1850.2	1880	1909.8
GSM (1 Uplink)	32.32	32.38	32.49	29.37	29.47	29.33
GPRS 8 (1 Uplink) – CS1	32.17	32.25	32.39	29.30	29.41	29.28
GPRS 10 (2 Uplink) – CS1	31.63	31.61	31.74	28.55	28.68	28.59
GPRS 11 (3 Uplink) – CS1	29.87	29.84	29.95	26.82	26.96	26.87
GPRS 12 (4 Uplink) – CS1	28.71	28.69	28.81	25.70	25.88	25.80

## 2.2 Connection Diagram of Test System

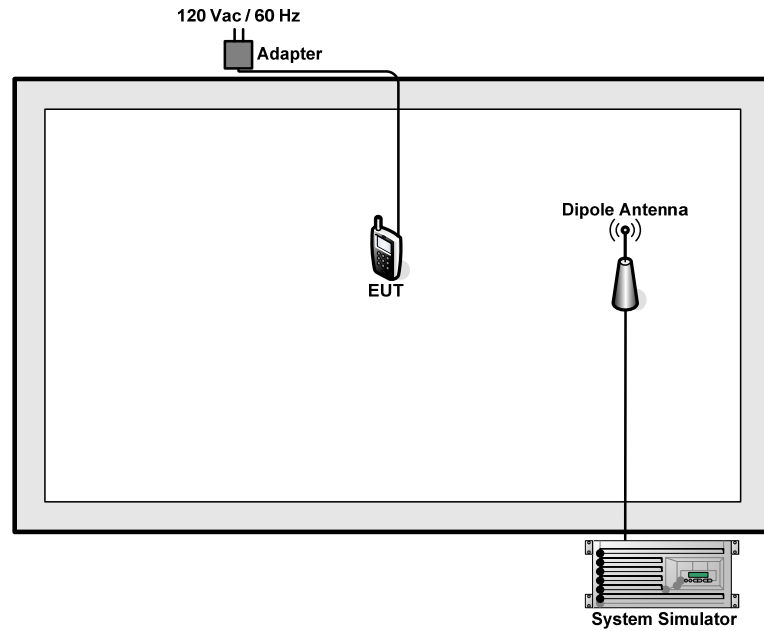



### 3 Test Result

#### 3.1 Conducted Output Power Measurement

##### 3.1.1 Description of the Conducted Output Power Measurement

A base station simulator was used to establish communication with the EUT. Its parameters were set to transmit the maximum power on the EUT. The measured power in the radio frequency on the transmitter output terminals shall be reported.

##### 3.1.2 Measuring Instruments

See list of measuring instruments of this test report.

##### 3.1.3 Test Procedures

1. The transmitter output port was connected to base station.
2. Set EUT at maximum power through base station.
3. Select lowest, middle, and highest channels for each band and different modulation.

##### 3.1.4 Test Setup

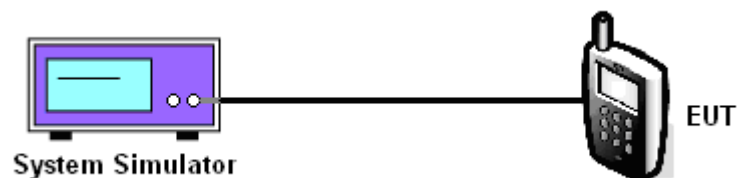

**3.1.5 Test Result of Conducted Output Power**

Cellular Band				
Modes	Channel	Frequency (MHz)	Conducted Power (dBm)	Conducted Power (Watts)
GSM850 (GSM)	128 (Low)	824.2	32.32	1.71
	189 (Mid)	836.4	32.38	1.73
	251 (High)	848.8	32.49	1.77

PCS Band				
Modes	Channel	Frequency (MHz)	Conducted Power (dBm)	Conducted Power (Watts)
GSM1900 (GSM)	512 (Low)	1850.2	29.37	0.86
	661 (Mid)	1880.0	29.47	0.89
	810 (High)	1909.8	29.33	0.86

## 3.2 Effective Radiated Power and Effective Isotropic Radiated Power Measurement

### 3.2.1 Description of the ERP/EIRP Measurement

ERP/EIRP is measured by substitution method according to ANSI / TIA / EIA-603-C-2004. The ERP of mobile transmitters must not exceed 7 Watts for 824 MHz ~ 849 MHz. The EIRP of mobile transmitters are limited to 2 Watts for 1850~1910 MHz.

### 3.2.2 Measuring Instruments

See list of measuring instruments of this test report.

### 3.2.3 Test Procedures

1. The EUT was placed on a turntable with 1.0 meter height in a fully anechoic chamber.
2. The EUT was set at 1.2 meters from the receiving antenna, which was mounted on the antenna tower.
3. The table was rotated 360 degrees to determine the position of the highest radiated power.
4. The height of the receiving antenna is adjusted to look for the maximum ERP/EIRP.
5. Taking the record of maximum ERP/EIRP.
6. A dipole antenna was substituted in place of the EUT and was driven by a signal generator.
7. The conducted power at the terminal of the dipole antenna is measured.
8. Repeat step 3 to step 5 to get the maximum ERP/EIRP of the substitution antenna.
9.  $ERP/EIRP = P_s + E_t - E_s + G_s = P_s + R_t - R_s + G_s$   
Ps (dBm) : Input power to substitution antenna.  
Gs (dBi or dBd) : Substitution antenna Gain.  
 $E_t = R_t + AF$   
 $E_s = R_s + AF$   
AF (dB/m) : Receive antenna factor  
Rt : The highest received signal in spectrum analyzer for EUT.  
Rs : The highest received signal in spectrum analyzer for substitution antenna.

### 3.2.4 Test Setup

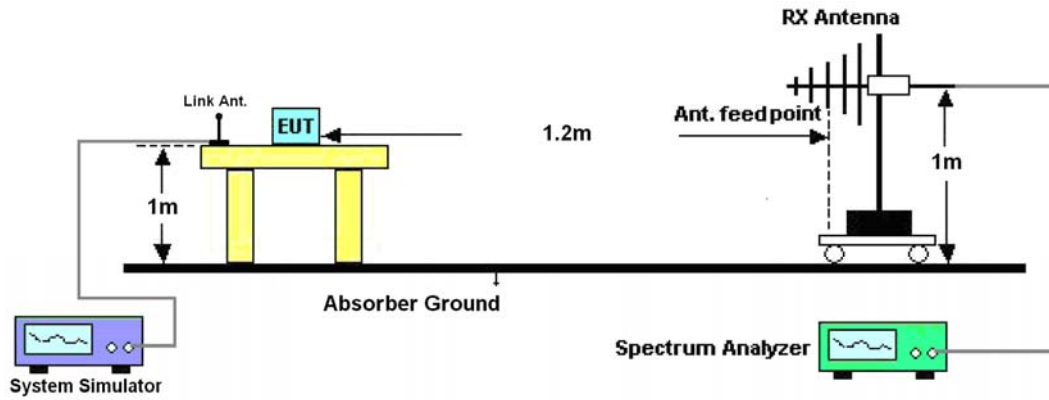

### 3.2.5 Test Result of ERP

GSM850 (GSM) Radiated Power ERP						
Horizontal Polarization						
Frequency (MHz)	Rt (dBm)	Rs (dBm)	Ps (dBm)	Gs (dBd)	ERP (dBm)	ERP (W)
824.20	-21.91	-48.12	0.00	-1.08	25.13	0.33
836.40	-21.69	-48.28	0.00	-0.93	25.66	0.37
848.80	-20.96	-48.35	0.00	-0.76	26.63	0.46
Vertical Polarization						
Frequency (MHz)	Rt (dBm)	Rs (dBm)	Ps (dBm)	Gs (dBd)	ERP (dBm)	ERP (W)
824.20	-32.66	-47.97	0.00	-1.08	14.23	0.03
836.40	-32.34	-48.01	0.00	-0.93	14.74	0.03
848.80	-31.49	-48.05	0.00	-0.76	15.80	0.04

### 3.2.6 Test Result of EIRP

GSM1900 (GSM) Radiated Power EIRP						
Horizontal Polarization						
Frequency (MHz)	Rt (dBm)	Rs (dBm)	Ps (dBm)	Gs (dBi)	EIRP (dBm)	EIRP (W)
1850.20	-26.14	-51.88	0.00	1.96	27.70	0.59
1880.00	-26.38	-52.99	0.00	2.00	28.61	0.73
1909.80	-28.23	-54.28	0.00	1.98	28.03	0.64
Vertical Polarization						
Frequency (MHz)	Rt (dBm)	Rs (dBm)	Ps (dBm)	Gs (dBi)	EIRP (dBm)	EIRP (W)
1850.20	-26.56	-52.13	0.00	1.96	27.53	0.57
1880.00	-26.73	-53.17	0.00	2.00	28.44	0.70
1909.80	-27.90	-54.13	0.00	1.98	28.21	0.66

### 3.3 Occupied Bandwidth Measurement

#### 3.3.1 Description of Occupied Bandwidth Measurement

The emission bandwidth is defined as the width of the signal between two points, located at the 2 sides of the carrier frequency, outside of which all emissions are attenuated at least 26 dB below the transmitter power.

#### 3.3.2 Measuring Instruments

See list of measuring instruments of this test report.

#### 3.3.3 Test Procedures

1. The EUT was connected to Spectrum Analyzer and Base Station via power divider.
2. The 99% and 26 dB occupied bandwidth (BW) of the middle channel for the highest RF powers were measured.

#### 3.3.4 Test Setup

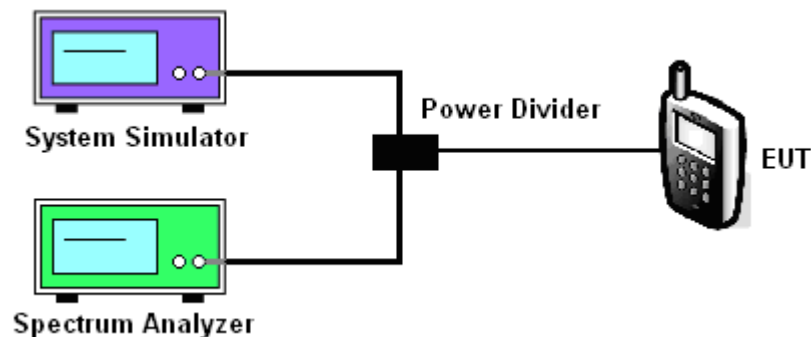



3.3.5 Test Result (Plots) of Occupied Bandwidth

Band :	GSM 850	Power Stage :	High
Test Mode :	GSM Link		

99% Occupied Bandwidth Plot on Channel 189

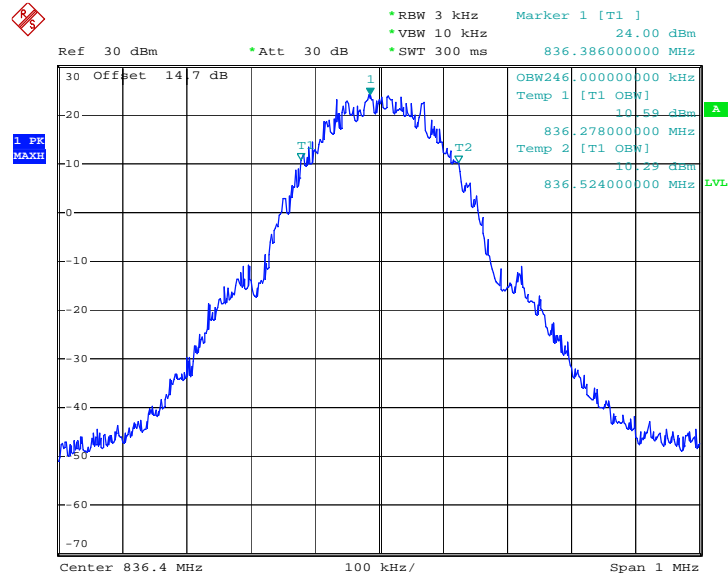

Date: 28.SEP.2011 15:07:12

26dB Bandwidth Plot on Channel 189

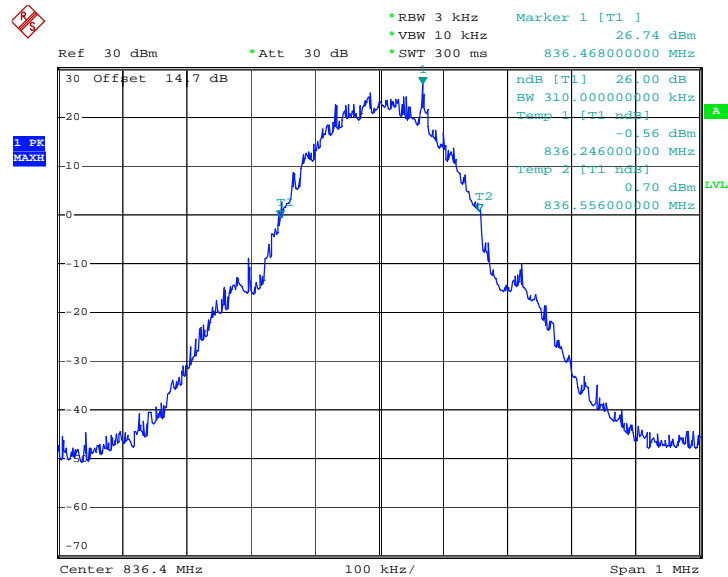

Date: 28.SEP.2011 15:05:53



Band :	GSM 1900	Power Stage :	High
Test Mode :	GSM Link		

99% Occupied Bandwidth Plot on Channel 661

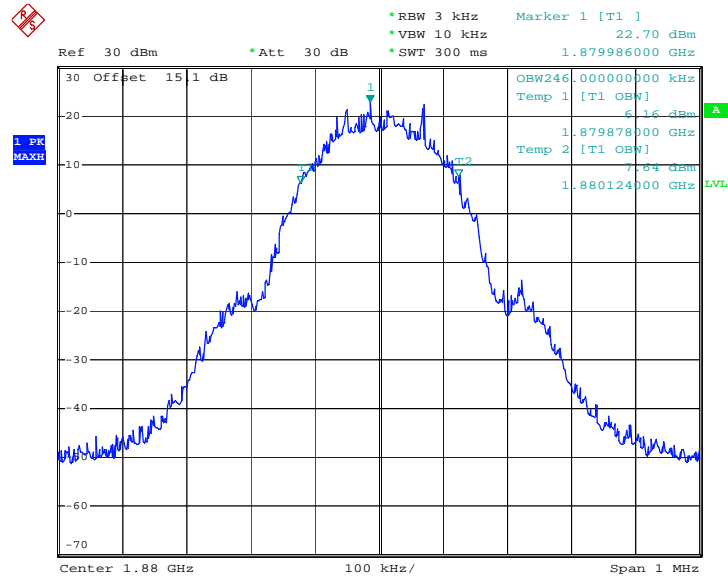

Date: 28.SEP.2011 15:17:16

26dB Bandwidth Plot on Channel 661

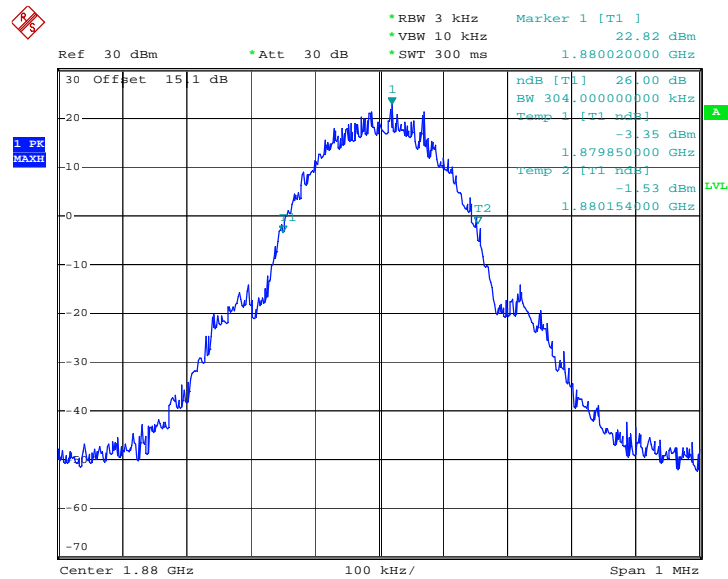

Date: 28.SEP.2011 15:15:58



## 3.4 Band Edge Measurement

### 3.4.1 Description of Band Edge Measurement

The power of any emission outside of the authorized operating frequency ranges must be lower than the transmitter power (P) by a factor of at least  $43 + 10 \log (P)$  dB.

### 3.4.2 Measuring Instruments

See list of measuring instruments of this test report.

### 3.4.3 Test Procedures

1. The EUT was connected to Spectrum Analyzer and Base Station via power divider.
2. The band edges of low and high channels for the highest RF powers were measured. Setting RBW 3kHz for GSM / EDGE, Setting RBW 100kHz for WCDMA.

### 3.4.4 Test Setup

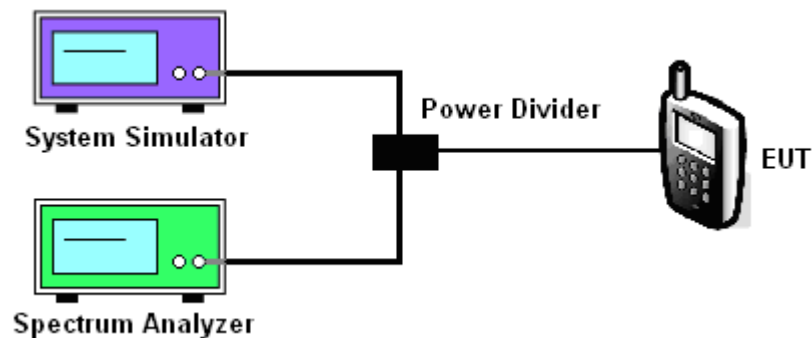

### 3.4.5 Test Result (Plots) of Conducted Band Edge

Band :	GSM850	Power Stage :	High
Test Mode :	GSM Link		

Lower Band Edge Plot on Channel 128

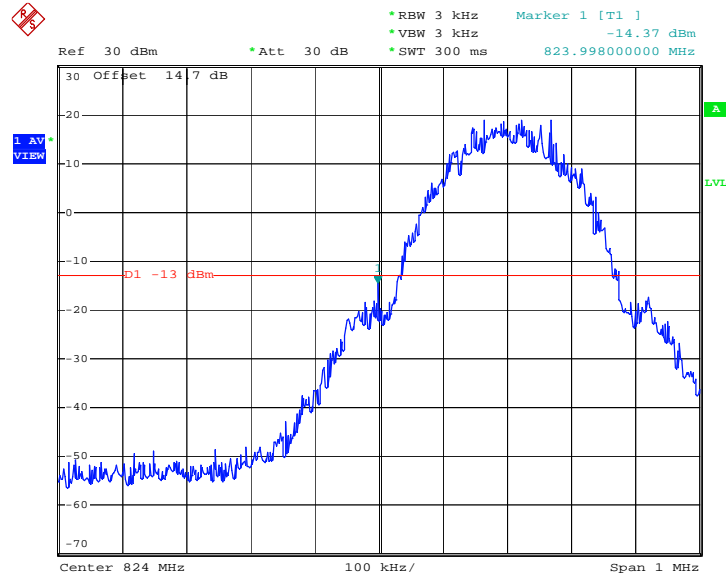

Date: 28.SEP.2011 15:09:04

Higher Band Edge Plot on Channel 251

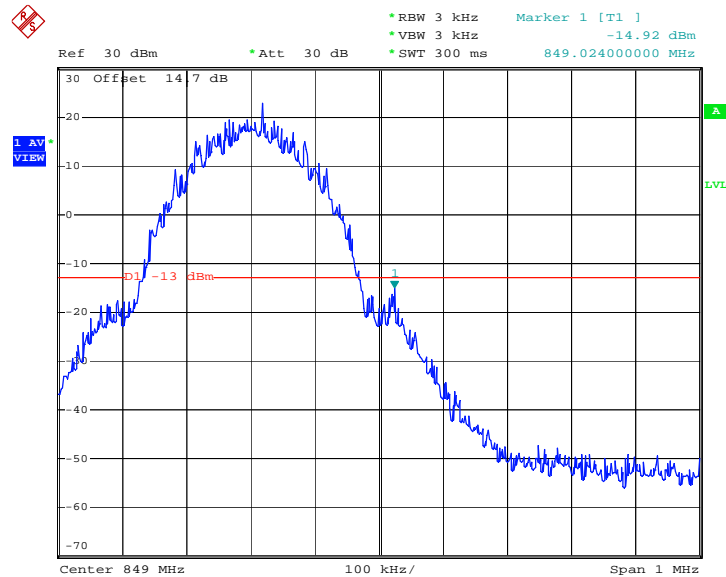

Date: 28.SEP.2011 15:09:30



Band :	GSM1900	Power Stage :	High
Test Mode :	GSM Link		

Lower Band Edge Plot on Channel 512

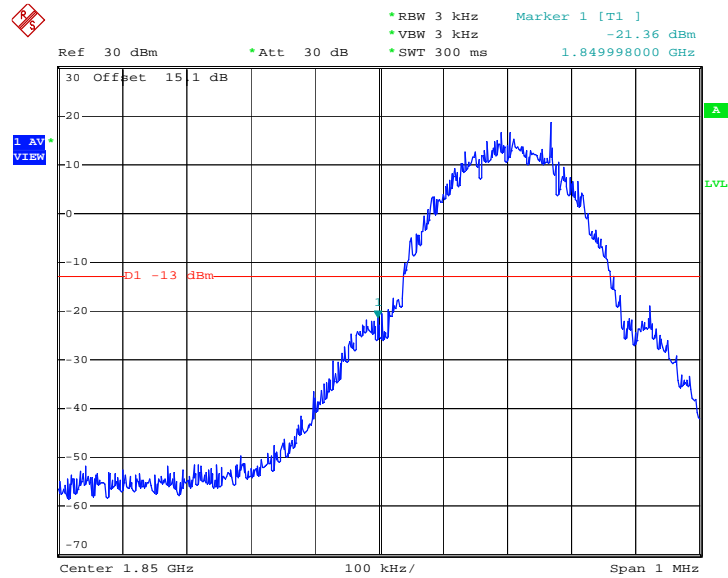

Date: 28.SEP.2011 15:19:08

Higher Band Edge Plot on Channel 810

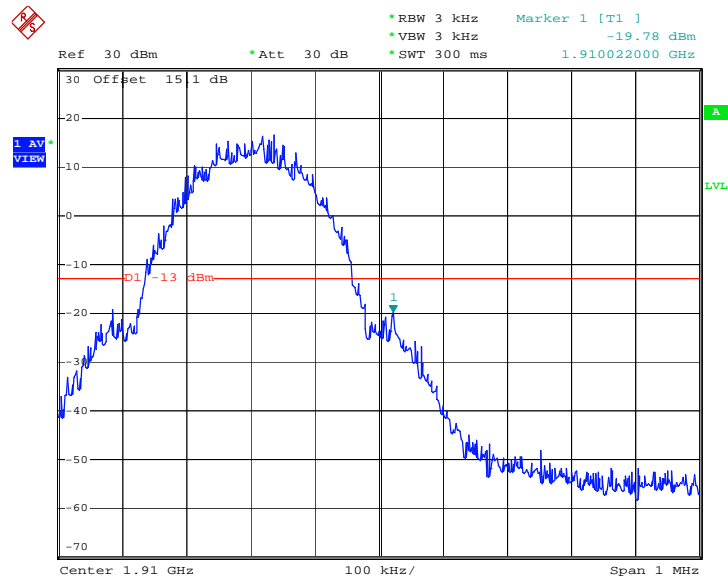

Date: 28.SEP.2011 15:19:34

## 3.5 Conducted Emission Measurement

### 3.5.1 Description of Conducted Emission Measurement

The power of any emission outside of the authorized operating frequency ranges must be lower than the transmitter power (P) by a factor of at least  $43 + 10 \log (P)$  dB.

It is measured by means of a calibrated spectrum analyzer and scanned from 30 MHz up to a frequency including its 10<sup>th</sup> harmonic.

### 3.5.2 Measuring Instruments

See list of measuring instruments of this test report.

### 3.5.3 Test Procedures

3. The EUT was connected to spectrum analyzer and base station via power divider.
4. The middle channel for the highest RF power within the transmitting frequency was measured.
5. The conducted spurious emission for the whole frequency range was taken.

### 3.5.4 Test Setup

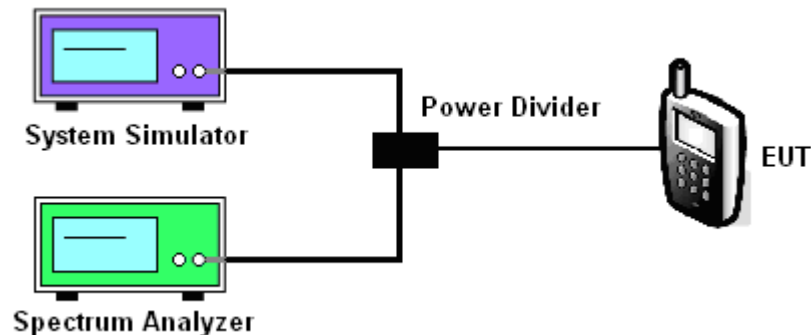

### 3.5.5 Test Result (Plots) of Conducted Emission

Band :	GSM850	Channel :	CH189
Test Mode :	GSM Link		

Conducted Emission Plot between 30MHz ~ 1GHz

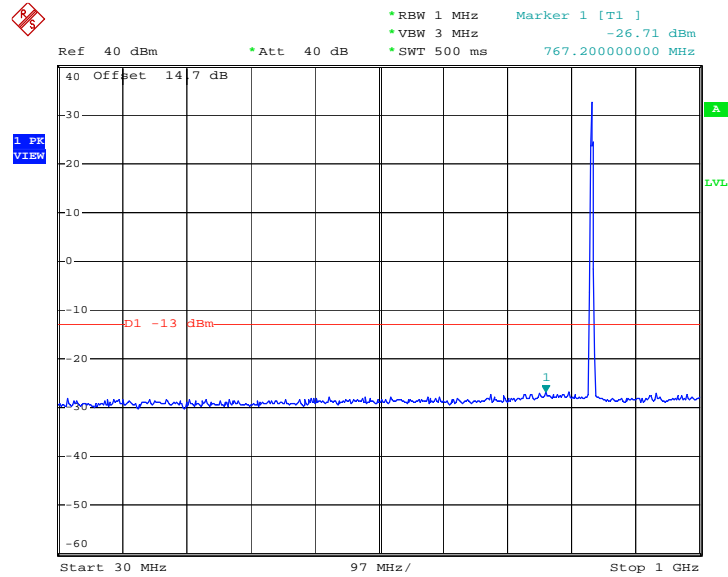

Date: 28.SEP.2011 15:40:43

Conducted Emission Plot between 1GHz ~ 3GHz

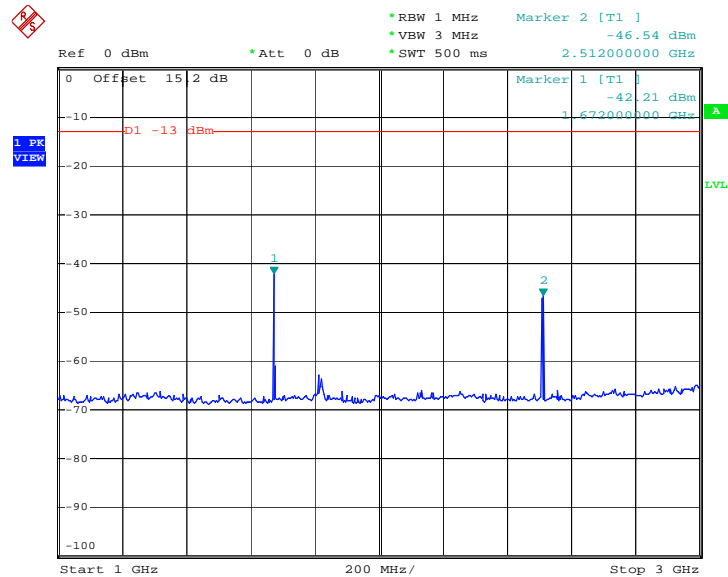

Date: 28.SEP.2011 15:47:41



### Conducted Emission Plot between 3GHz ~ 7GHz

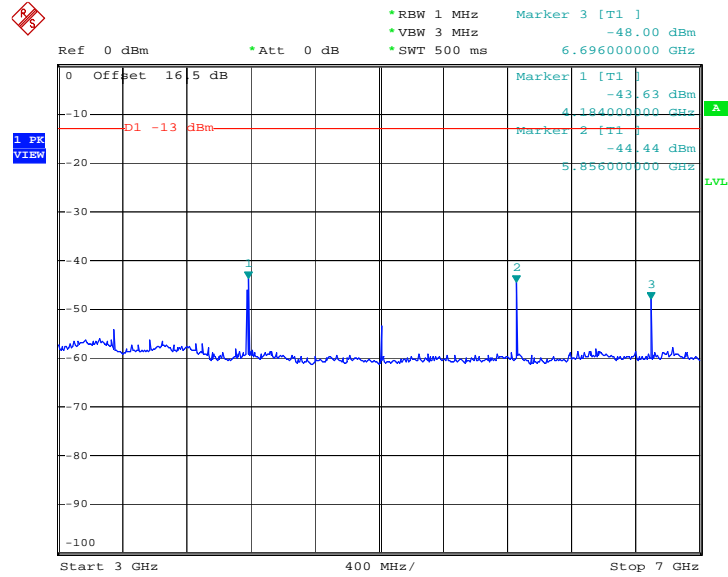

Date : 28.SEP.2011 15:44:18

### Conducted Emission Plot between 7GHz ~ 9GHz

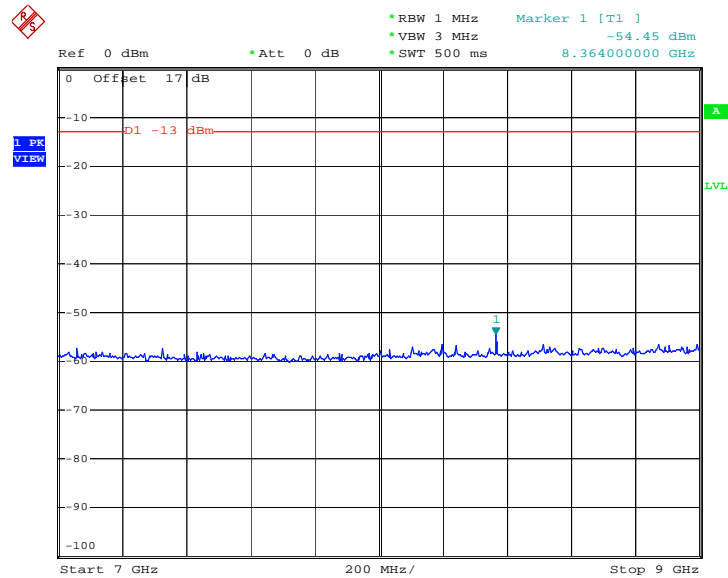

Date : 28.SEP.2011 15:45:52



Band :	GSM1900	Channel :	CH661
Test Mode :	GSM Link		

Conducted Emission Plot between 30MHz ~ 1GHz

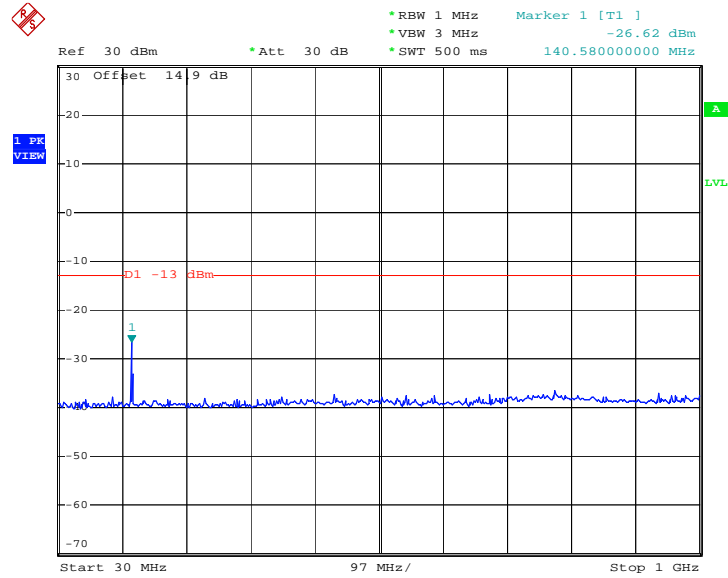

Date: 28.SEP.2011 15:29:07

Conducted Emission Plot between 1GHz ~ 3GHz

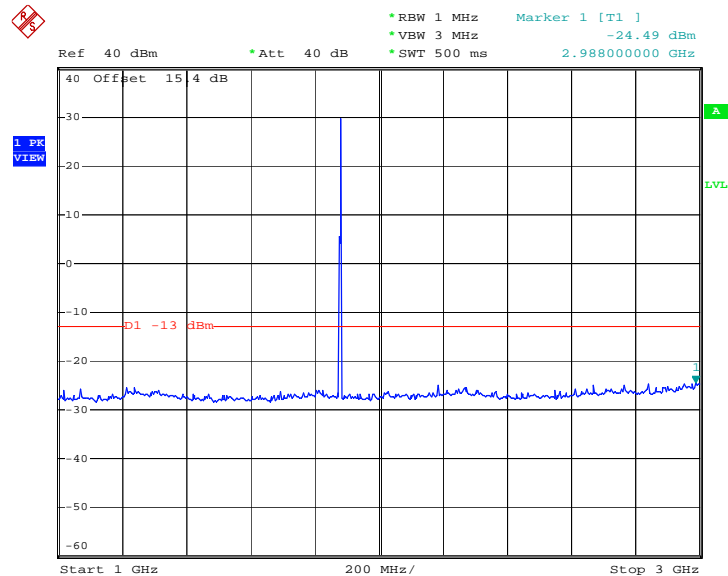

Date: 28.SEP.2011 15:30:46



### Conducted Emission Plot between 3GHz ~ 7GHz

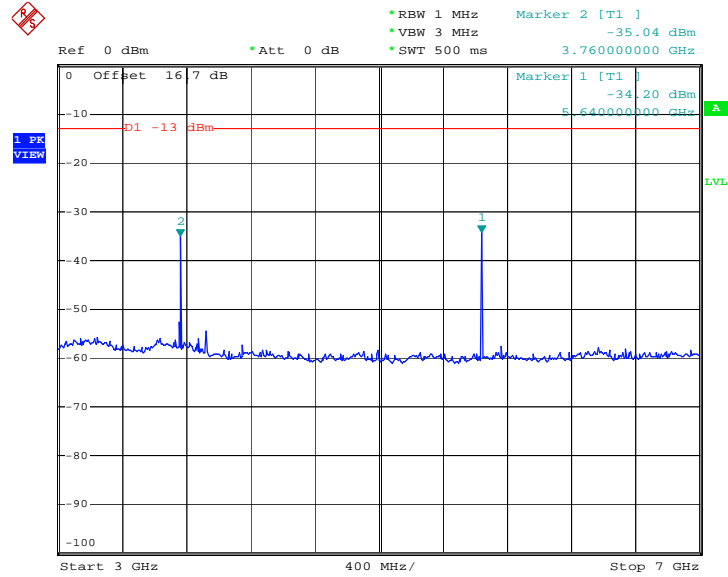

Date: 28.SEP.2011 15:33:01

### Conducted Emission Plot between 7GHz ~ 13.6G

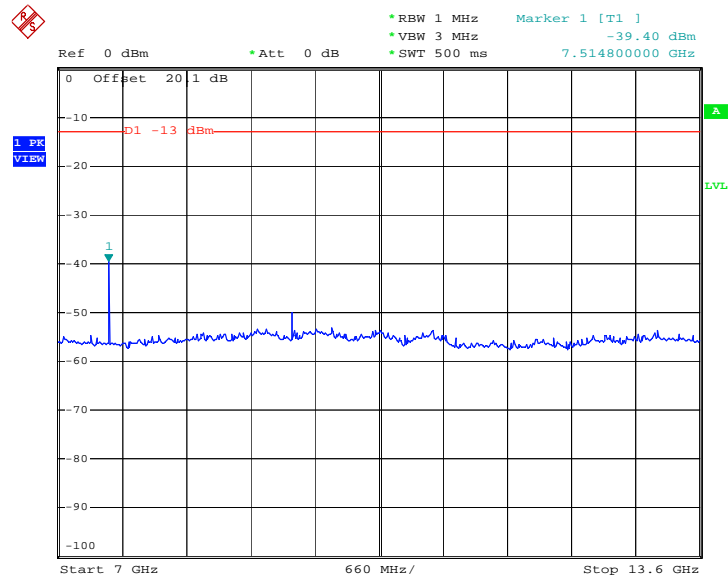

Date: 28.SEP.2011 15:34:49





Conducted Emission Plot between 13.6GHz ~ 19.1GHz

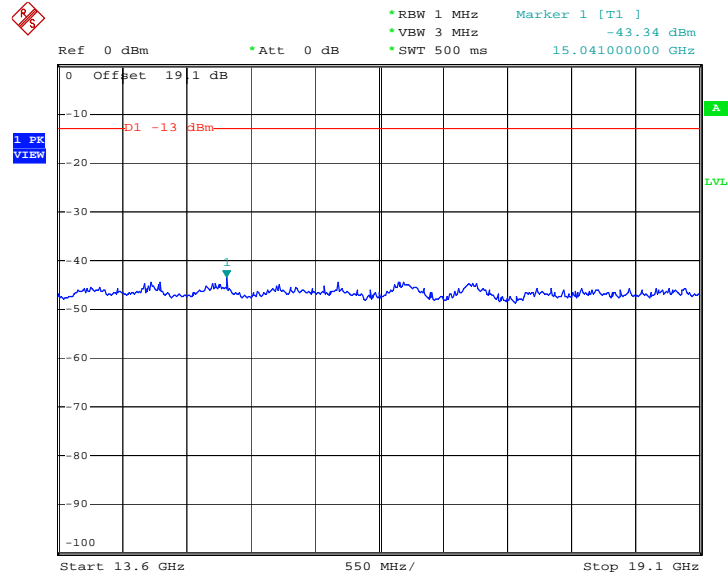

Date: 28.SEP.2011 15:36:32

## 3.6 Field Strength of Spurious Radiation Measurement

### 3.6.1 Description of Field Strength of Spurious Radiated Measurement

The radiated spurious emission was measured by substitution method according to ANSI / TIA / EIA-603-C-2004. The power of any emission outside of the authorized operating frequency ranges must be attenuated below the transmitter power (P) by a factor of at least  $43 + 10 \log (P)$  dB. The spectrum is scanned from 30 MHz up to a frequency including its 10th harmonic.

### 3.6.2 Measuring Instruments

See list of measuring instruments of this test report.

### 3.6.3 Test Procedures

1. The EUT was placed on a rotatable wooden table with 0.8 meter about ground.
2. The EUT was set 3 meters from the receiving antenna, which was mounted on the antenna tower.
3. The table was rotated 360 degrees to determine the position of the highest spurious emission.
4. The height of the receiving antenna is varied between one meter and four meters to search the maximum spurious emission for both horizontal and vertical polarizations.
5. Taking the record of maximum spurious emission.
6. A horn antenna was substituted in place of the EUT and was driven by a signal generator.
7. Tune the output power of signal generator to the same emission level with EUT maximum spurious emission.
8. Taking the record of output power at antenna port.
9. Repeat step 7 to step 8 for another polarization.
10.  $EIRP \text{ (dBm)} = S.G. \text{ Power} - Tx \text{ Cable Loss} + Tx \text{ Antenna Gain}$
11.  $ERP \text{ (dBm)} = EIRP - 2.15$

### 3.6.4 Test Setup

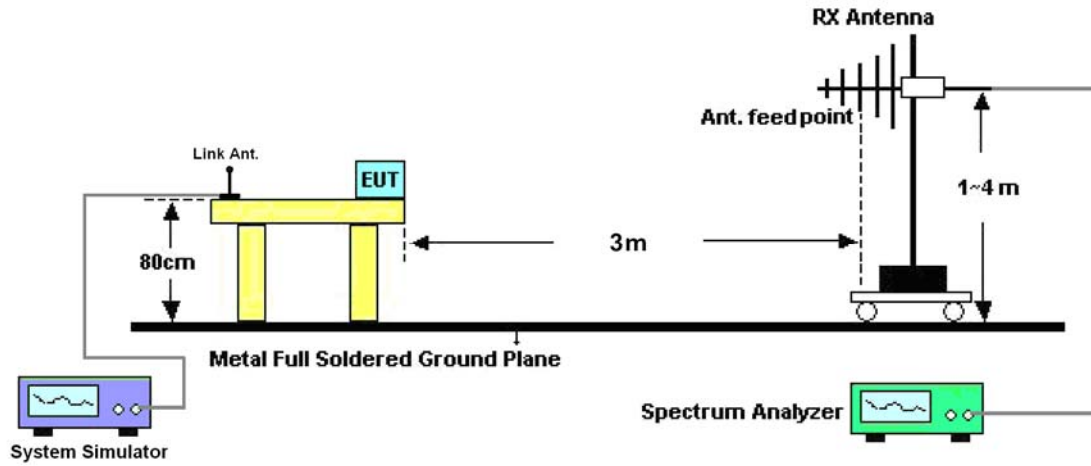



3.6.5 Test Result of Field Strength of Spurious Radiated

Band :	GSM850	Temperature :	21~22°C
Test Mode :	GSM Link	Relative Humidity :	41~42%
Test Engineer :	Chenmy Cheng	Polarization :	Horizontal
Remark :	Spurious emissions within 30-1000MHz were found more than 20dB below limit line.		

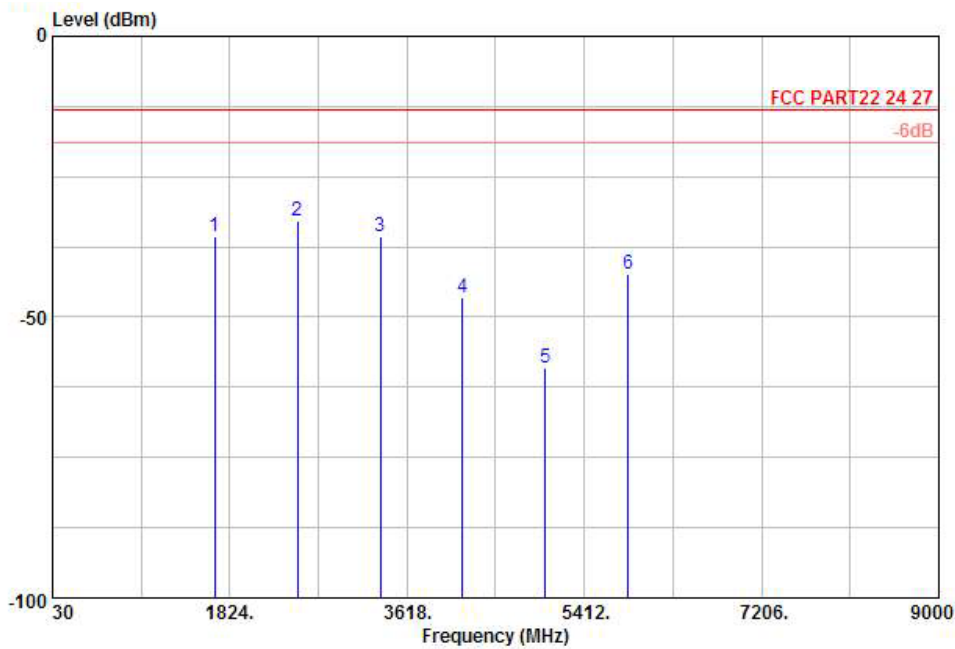

Site : 03CH01-KS  
 Condition: FCC PART22 24 27 HF EIRP FACTOR-09020 HORIZONTAL  
 Project : (FG) 192301

Frequency ( MHz )	ERP ( dBm )	Limit ( dBm )	Over Limit ( dB )	SPA Reading ( dBm )	S.G. Power ( dBm )	TX Cable loss ( dB )	TX Antenna Gain ( dBi )	Polarization ( H/V )	Result
1672	-35.57	-13	-22.57	-35.92	-36.22	0.57	3.37	H	Pass
2510	-32.82	-13	-19.82	-37.59	-35.05	0.78	5.16	H	Pass
3346	-35.57	-13	-22.57	-40.45	-39.21	0.87	6.66	H	Pass
4182	-46.45	-13	-33.45	-50.34	-51.04	0.97	7.71	H	Pass
5018	-59.10	-13	-46.10	-65.30	-64.77	1.09	8.91	H	Pass
5856	-42.27	-13	-29.27	-52.05	-48.71	1.22	9.81	H	Pass



<b>Band :</b>	GSM850	<b>Temperature :</b>	21~22°C
<b>Test Mode :</b>	GSM Link	<b>Relative Humidity :</b>	41~42%
<b>Test Engineer :</b>	Chenmy Cheng	<b>Polarization :</b>	Vertical
<b>Remark :</b>	Spurious emissions within 30-1000MHz were found more than 20dB below limit line.		

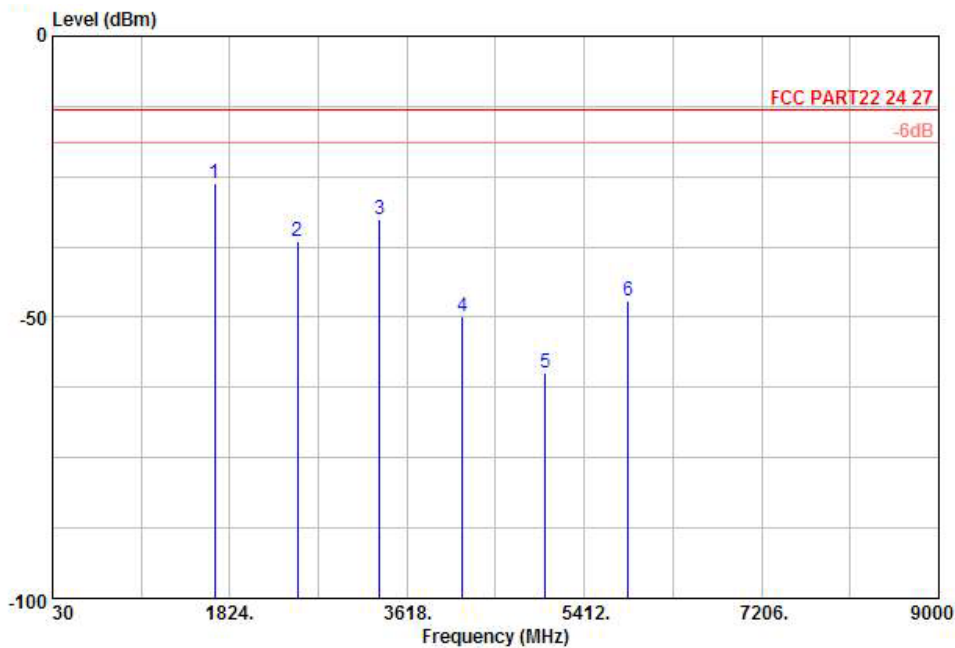

Site : 03CH01-KS  
 Condition: FCC PART22 24 27 HF EIRP FACTOR-09020 VERTICAL  
 Project : (FG) 192301

Frequency ( MHz )	ERP ( dBm )	Limit ( dBm )	Over Limit ( dB )	SPA Reading ( dBm )	S.G. Power ( dBm )	TX Cable loss ( dB )	TX Antenna Gain ( dBi )	Polarization ( H/V )	Result
1672	-26.27	-13	-13.27	-32.55	-26.92	0.57	3.37	V	Pass
2510	-36.55	-13	-23.55	-43.10	-38.78	0.78	5.16	V	Pass
3344	-32.58	-13	-19.58	-39.35	-36.22	0.87	6.66	V	Pass
4182	-49.77	-13	-36.77	-53.61	-54.36	0.97	7.71	V	Pass
5018	-59.76	-13	-46.76	-64.70	-65.43	1.09	8.91	V	Pass
5856	-47.10	-13	-34.10	-55.09	-53.54	1.22	9.81	V	Pass



<b>Band :</b>	GSM1900	<b>Temperature :</b>	21~22°C
<b>Test Mode :</b>	GSM Link	<b>Relative Humidity :</b>	41~42%
<b>Test Engineer :</b>	Chenmy Cheng	<b>Polarization :</b>	Horizontal
<b>Remark :</b>	Spurious emissions within 30-1000MHz were found more than 20dB below limit line.		

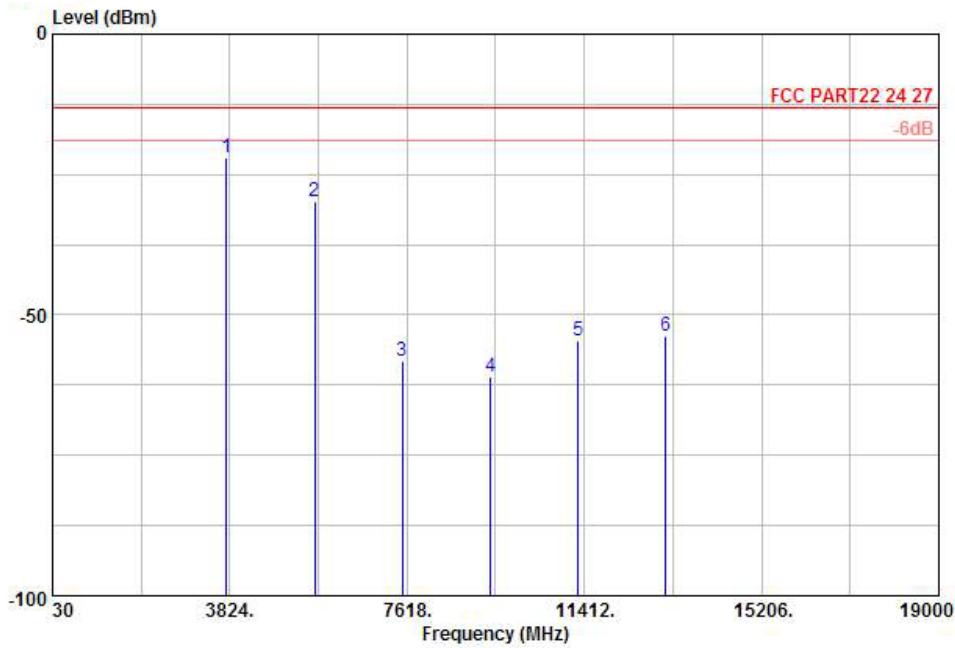

Site : 03CH01-KS  
 Condition: FCC PART22 24 27 HF EIRP FACTOR-09020 HORIZONTAL  
 Project : (FG) 192301

Frequency ( MHz )	EIRP ( dBm )	Limit ( dBm )	Over Limit ( dB )	SPA Reading ( dBm )	S.G. Power ( dBm )	TX Cable loss ( dB )	TX Antenna Gain ( dBi )	Polarization ( H/V )	Result
3760	-22.14	-13	-9.14	-30.03	-28.52	0.78	7.16	H	Pass
5640	-29.88	-13	-16.88	-43.44	-38.42	1.04	9.58	H	Pass
7520	-58.28	-13	-45.28	-63.41	-68.39	1.35	11.46	H	Pass
9400	-61.01	-13	-48.01	-64.27	-72.07	1.75	12.81	H	Pass
11280	-54.49	-13	-41.49	-65.98	-65.58	2	13.09	H	Pass
13160	-53.86	-13	-40.86	-65.16	-65.57	2.04	13.75	H	Pass



<b>Band :</b>	GSM1900	<b>Temperature :</b>	21~22°C
<b>Test Mode :</b>	GSM Link	<b>Relative Humidity :</b>	41~42%
<b>Test Engineer :</b>	Chenmy Cheng	<b>Polarization :</b>	Vertical
<b>Remark :</b>	Spurious emissions within 30-1000MHz were found more than 20dB below limit line.		

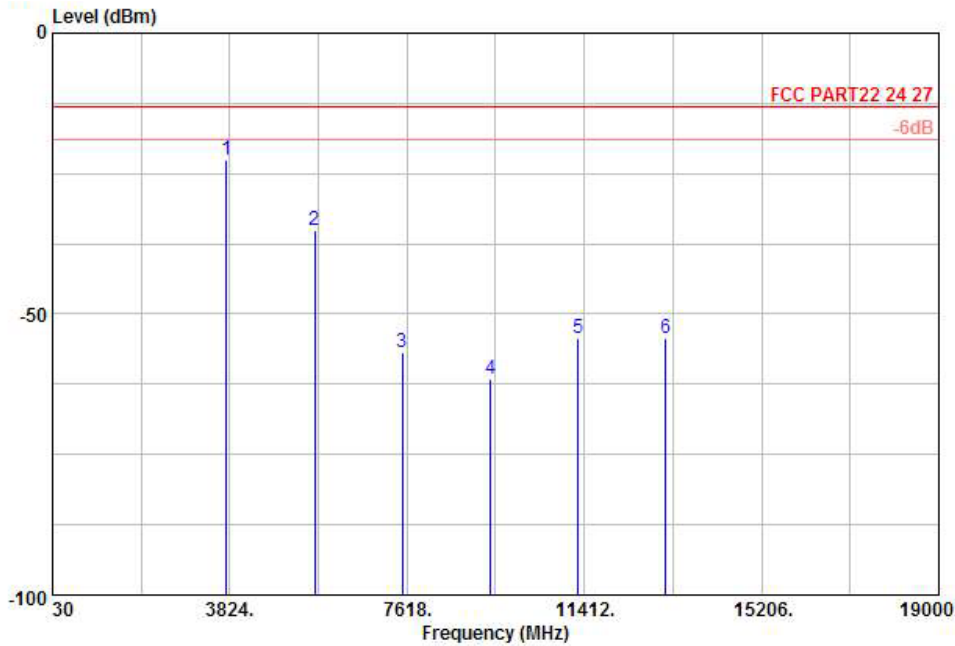

Site : 03CH01-KS  
 Condition: FCC PART22 24 27 HF EIRP FACTOR-09020 VERTICAL  
 Project : (FG) 192301

Frequency ( MHz )	EIRP ( dBm )	Limit ( dBm )	Over Limit ( dB )	SPA Reading ( dBm )	S.G. Power ( dBm )	TX Cable loss ( dB )	TX Antenna Gain ( dBi )	Polarization ( H/V )	Result
3760	-22.47	-13	-9.47	-34.21	-28.85	0.78	7.16	V	Pass
5640	-34.98	-13	-21.98	-48.36	-43.52	1.04	9.58	V	Pass
7520	-56.84	-13	-43.84	-61.33	-66.95	1.35	11.46	V	Pass
9400	-61.53	-13	-48.53	-62.75	-72.59	1.75	12.81	V	Pass
11280	-54.29	-13	-41.29	-65.53	-65.38	2	13.09	V	Pass
13160	-54.43	-13	-41.43	-65.62	-66.14	2.04	13.75	V	Pass

## 3.7 Frequency Stability Measurement

### 3.7.1 Description of Frequency Stability Measurement

The frequency stability shall be measured by variation of ambient temperature and variation of primary supply voltage to ensure that the fundamental emission stays within the authorized frequency block. The frequency stability of the transmitter shall be maintained within  $\pm 0.00025\%$  ( $\pm 2.5\text{ppm}$ ) of the center frequency.

### 3.7.2 Measuring Instruments

See list of measuring instruments of this test report.

### 3.7.3 Test Procedures for Temperature Variation

1. The EUT was set up in the thermal chamber and connected with the base station.
2. With power OFF, the temperature was decreased to  $-30^{\circ}\text{C}$  and the EUT was stabilized for three hours. Power was applied and the maximum change in frequency was recorded within one minute.
3. With power OFF, the temperature was raised in  $10^{\circ}\text{C}$  step up to  $50^{\circ}\text{C}$ . The EUT was stabilized at each step for at least half an hour. Power was applied and the maximum frequency change was recorded within one minute.
4. If the EUT cannot be turned on at  $-30^{\circ}\text{C}$ , the testing lowest temperature will be raised in  $10^{\circ}\text{C}$  step until the EUT can be turned on.

### 3.7.4 Test Procedures for Voltage Variation

1. The EUT was placed in a temperature chamber at  $25\pm 5^{\circ}\text{C}$  and connected with the base station.
2. The power supply voltage to the EUT was varied from BEP to 115% of the nominal value measured at the input to the EUT.
3. The variation in frequency was measured for the worst case.



### 3.7.5 Test Setup

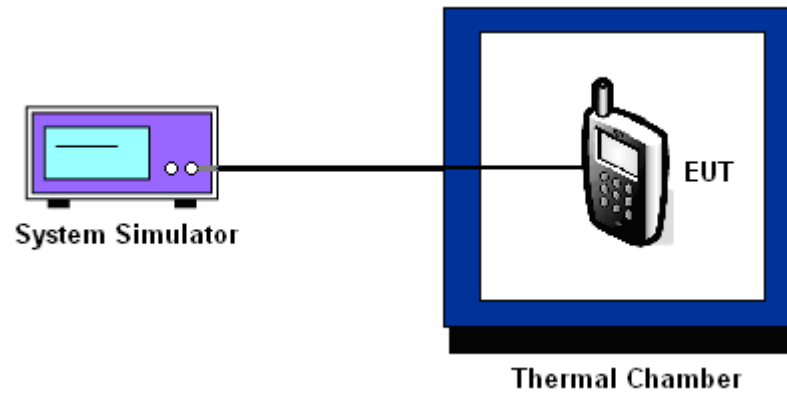



3.7.6 Test Result of Temperature Variation

Band :	GSM 850	Channel :	189
Limit (ppm) :	2.5		

Temperature (°C)	GSM		Result
	Freq. Dev. (Hz)	Deviation (ppm)	
-30	NA	NA	PASS
-20	NA	NA	
-10	NA	NA	
0	-18	-0.02	
10	19	0.02	
20	-26	-0.03	
30	-17	-0.02	
40	-15	-0.02	
50	-21	-0.02	

**Note:** The manufacturer declared that the EUT could work properly between temperatures 0°C~50°C.



Band :	GSM 1900	Channel :	661
Limit (ppm) :	2.5		

Temperature (°C)	GSM		Result
	Freq. Dev. (Hz)	Deviation (ppm)	
-30	NA	NA	PASS
-20	NA	NA	
-10	NA	NA	
0	45	0.02	
10	38	0.02	
20	28	0.01	
30	57	0.03	
40	42	0.02	
50	-33	-0.02	

**Note:** The manufacturer declared that the EUT could work properly between temperatures 0°C~50°C.

**3.7.7 Test Result of Voltage Variation**

Band & Channel	Mode	Voltage (Volt)	Freq. Dev. (Hz)	Deviation (ppm)	Limit (ppm)	Result
GSM 850 CH189	GSM	3.8	-23	-0.03	2.5	PASS
		BEP	-19	-0.02		
		4.2	-24	-0.03		
GSM 1900 CH661	GSM	3.8	28	0.01		
		BEP	37	0.02		
		4.2	-25	-0.01		

**Note:**

1. Normal Voltage = 3.8V.
2. Battery End Point (BEP) = 3.6 V.



## 4 List of Measuring Equipments

Instrument	Manufacturer	Model No.	Serial No.	Characteristics	Calibration Date	Due Date	Remark
Spectrum Analyzer	R&S	FSP40	100319	9kHz~40GHz	Jan. 07, 2011	Jan. 06, 2012	Conducted (TH01-KS)
System Simulator	R&S	CMU200	837587/066	Full-Band	Jan. 07, 2011	Jan. 06, 2012	Conducted (TH01-KS)
DC Power Supply	TOPWARD	GPS-3030D	E1884515	N/A	Aug. 23, 2011	Aug. 22, 2012	Conducted (TH01-KS)
Thermal Chamber	Ten Billion	TTC-B3S	TBN-960502	N/A	Jan. 17, 2011	Jan. 16, 2012	Conducted (TH01-KS)
EMI Test Receiver	R&S	ESCI	100534	9kHz~3GHz	Nov. 16, 2010	Nov. 15, 2011	Radiation (03CH01-KS)
Spectrum Analyzer	R&S	FSP40	100319	9kHz~40GHz	Jan. 07, 2011	Jan. 06, 2012	Radiation (03CH01-KS)
Bilog Antenna	SCHAFFNER	CBL6112D	23182	25MHz~2GHz	Dec. 07, 2010	Dec. 06, 2011	Radiation (03CH01-KS)
Double Ridge Horn Antenna	EMCO	3117	00075959	1GHz~18GHz	Jan. 07, 2011	Jan. 06, 2012	Radiation (03CH01-KS)
Amplifier	Wireless	FPA-6592G	060004	30MHz~2GHz	Dec. 09, 2010	Dec. 08, 2011	Radiation (03CH01-KS)
Active Horn Antenna	com-power	AHA-118	701023	1GHz-18GHz	Nov. 09, 2010	Nov. 08, 2011	Radiation (03CH01-KS)
SHE-EHF Horn	Schwarzbeck	BBHA9170	BBHA170249	15GHz-40GHz	Oct. 15,2010	Oct. 14,2011	Radiation (03CH01-KS)
System Simulator	R&S	CMU200	837587/066	Full-Band	Jan. 07, 2011	Jan. 06, 2012	Radiation (03CH01-KS)

## 5 Uncertainty of Evaluation

### Uncertainty of Radiated Emission Measurement (30 MHz ~ 1000 MHz)

Contribution	Uncertainty of $X_i$		$u(X_i)$
	dB	Probability Distribution	
Receiver Reading	0.41	Normal (k=2)	0.21
Antenna Factor Calibration	0.83	Normal (k=2)	0.42
Cable Loss Calibration	0.25	Normal (k=2)	0.13
Pre-Amplifier Gain Calibration	0.27	Normal (k=2)	0.14
RCV/SPA Specification	2.50	Rectangular	0.72
Antenna Factor Interpolation for Frequency	1.00	Rectangular	0.29
Site Imperfection	1.43	Rectangular	0.83
Mismatch	+0.39 / -0.41	U-Shape	0.28
<b>Combined Standard Uncertainty <math>U_c(y)</math></b>	<b>1.27</b>		
<b>Measuring Uncertainty for a Level of Confidence of 95% (<math>U = 2U_c(y)</math>)</b>	<b>2.54</b>		

### Uncertainty of Radiated Emission Measurement (1 GHz ~ 40 GHz)

Contribution	Uncertainty of $X_i$		$u(X_i)$	$C_i$	$C_i * u(X_i)$
	dB	Probability Distribution			
Receiver Reading	$\pm 0.10$	Normal (k=2)	0.10	1	0.10
Antenna Factor Calibration	$\pm 1.70$	Normal (k=2)	0.85	1	0.85
Cable Loss Calibration	$\pm 0.50$	Normal (k=2)	0.25	1	0.25
Receiver Correction	$\pm 2.00$	Rectangular	1.15	1	1.15
Antenna Factor Directional	$\pm 1.50$	Rectangular	0.87	1	0.87
Site Imperfection	$\pm 2.80$	Triangular	1.14	1	1.14
Mismatch Receiver VSWR $\Gamma_1 = 0.197$ Antenna VSWR $\Gamma_2 = 0.194$ Uncertainty = $20\text{Log}(1-\Gamma_1*\Gamma_2)$	+0.34 / -0.35	U-Shape	0.244	1	0.244
<b>Combined Standard Uncertainty <math>U_c(y)</math></b>	<b>2.36</b>				
<b>Measuring Uncertainty for a Level of Confidence of 95% (<math>U = 2U_c(y)</math>)</b>	<b>4.72</b>				



## **Appendix A. Photographs of EUT**

Please refer to Sporton report number EP192301 as below.