

# COMOSAR Dipole 835 MHz Calibration Report



Ref: CR-280-3-08-SATB-B

Page: 1/6

Issue: B

Date: 2009/10/05

## DIPOLE 835 MHZ CALIBRATION REPORT

Prepared By: LUC Jérôme, SATIMO  
Project Description: SAR TEST BENCH  
Prepared For (End User): Shenzhen Morlab Communication Technology

This document is issued by SATIMO, in confidence and is not to be reproduced in whole or in part without the prior written permission. The information contained herein is to be used only for the purpose for which it is submitted and is not to be released in whole or in part without the prior written permission of SATIMO.

# COMOSAR Dipole 835 MHz Calibration Report



Ref: CR-280-3-08-SATB-B

Page: 2/6

Issue: B

Date: 2009/10/05

## DIPOLE 835 MHz CALIBRATION REPORT

**DATE:** 19/02/2009

**REFERENCE:** SN 36/08 DIPC99

**OBJECT:** COMOSAR IEEE REFERENCE DIPOLE

**MANUFACTURER:** SATIMO

**SERIAL NUMBER:** SN 36/08 DIPC99

**CUSTOMER:** Shenzhen Morlab Communication Technology

**CONTRACT:** PF2130108b\_SAR\_Morlab

**DATE OF CALIBRATION:** 23/09/2009

### WARRANTY:

This Calibration certificate may not be reproduced other than in full. Calibration certificates without signature and seal are not valid. This documentation contains property information which is protected by copyright. All right are reserved. No part of this document may be photocopied, reproduced without the prior written agreement of SATIMO. SATIMO shall not be liable for errors contained herein or for incidental or consequential in connection with the furnishing, performance or use of this material. Warranty doesn't apply to Normal wear, Normal tear, Improper use, Improper maintain, Improper installation.

Date

2009/10/05

SAR TEAM MANAGER

*JS*

**SATIMO Bretagne**  
Technopôle Brest Iroise  
Zone du Vernis  
225 rue Pierre Rivoalon  
29200 BREST

# COMOSAR Dipole 835 MHz Calibration Report



Ref: CR-280-3-08-SATB-B

Page: 3/6

Issue: B

Date: 2009/10/05

## PRODUCT DESCRIPTION

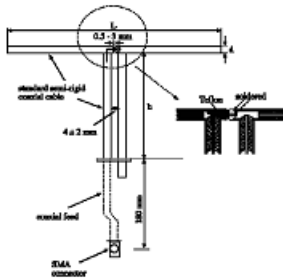

Dimension: L=161 mm / h=89.8mm / d=3.6 mm

## CALIBRATION TEST EQUIPMENT

TYPE	IDENTIFICATION	DATE OF CALIBRATION
Vector Network Analyzer	HP8753D (SN: 5410A08882)	10-05-2009

## MEASUREMENT PROCEDURE

We placed the dipole under the flat part of SAM phantom fill with 835 MHz head liquid.

# COMOSAR Dipole 835 MHz Calibration Report



Ref: CR-280-3-08-SATB-B

Page: 4/6

Issue: B

Date: 2009/10/05

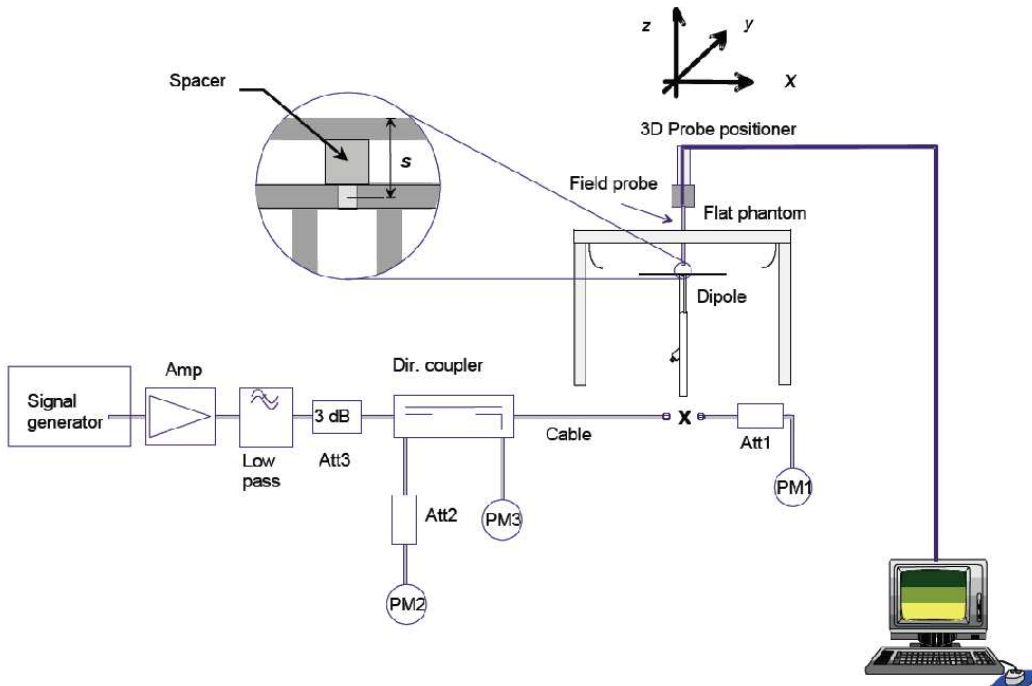

Calibration was performed according to IEEE Std P1528-2003 and OET bulletin 65 Supplement C (Ed. 01-01)

**VSWR at 835 MHz: -24.77 dB.**

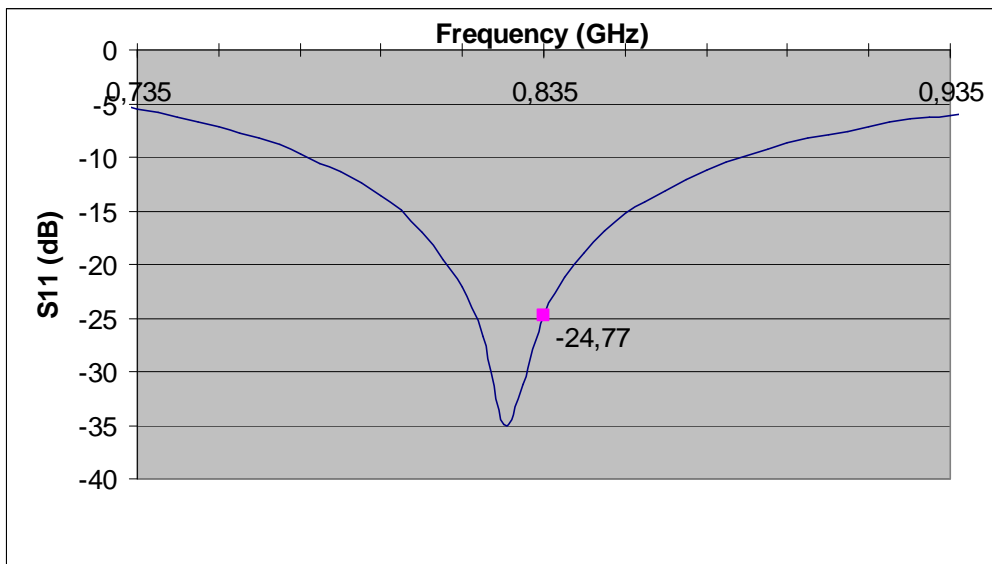

# COMOSAR Dipole 835 MHz Calibration Report



Ref: CR-280-3-08-SATB-B

Page: 5/6

Issue: B

Date: 2009/10/05

## SAR MEASUREMENT EQUIPEMENT

<b>Voltmeter</b>	Keithley (2000, SN:1000572)	Date of calibration: 01-07-2009
<b>Signal generator</b>	Rohde&Schwarz (SML_03, SN:101868)	Date of calibration: 15-11-2008
<b>Power amplifier</b>	Nuclétudes (ALB216, SN:10800)	Date of calibration: 24-10-2008
<b>Power meter</b>	Rohde&Schwarz (NRVD, SN:101066)	Date of calibration: 04-07-2009
<b>Probe</b>	SATIMO Bretagne (SN:EP37) CF (30.41,29.18,32.33)	Date of calibration: 19-06-2009

## SAR MEASUREMENT CONDITION

<b>Software</b>	OpenSAR V3
<b>Phantom</b>	SATIMO Bretagne (SN: SN_20_07_SAM42)
<b>Liquid</b>	SATIMO Bretagne (Last Calibration: 18 09 08) Head Liquid Values: eps' : 41,20 sigma : 0,872
<b>Distance between the center of the dipole and the liquid (set with a spacer)</b>	15 mm
<b>Area scan resolution</b>	dx=8mm/dy=8mm
<b>Zoom scan resolution</b>	dx=8mm/dy=8m/dz=5mm
<b>Frequency</b>	835 MHz
<b>Input power</b>	30 dBm
<b>Expanded uncertainty (K=1)</b>	8.09%

## SAR MEASUREMENT RESULT

	10g	1g
SAR measured	<b>6,364 W/Kg</b>	<b>9,805 W/Kg</b>
Liquid : HL	<b>+ 2,64 %</b>	<b>+ 3,21 %</b>
Input power : 1W		

# COMOSAR Dipole 835 MHz Calibration Report



Ref: CR-280-3-08-SATB-B

Page: 6/6

Issue: B

Date: 2009/10/05

## SAR MEASUREMENT PLOTS

