



NVLAP LAB CODE 200707-0



SAR EVALUATION REPORT

For

Brightstar Corporation

9725 NW 117th Ave., #300 Miami,

Florida 33178, USA

FCC ID: WVBAWIO20X

Report Type: Original Report	Product Type: GSM Mobile Phone
Test Engineer: Eric Zhang	<i>Eric Zhang</i>
Report Number: RSZ09081401-SAR	
Report Date: 2009-07-30	
Reviewed By: William Chen EMC Engineer	<i>William . Chen .</i>
Prepared By:	Bay Area Compliance Laboratories Corp. (Shenzhen) 6/F, the 3rd Phase of WanLi Industrial Building, ShiHua Road, FuTian Free Trade Zone Shenzhen, Guangdong, China Tel: +86-755-33320018 Fax: +86-755-33320008

Note: This test report is prepared for the customer shown above and for the device described herein. It may not be duplicated or used in part without prior written consent from Bay Area Compliance Laboratories Corp. (Shenzhen). This report **must not** be used by the customer to claim product certification, approval, or endorsement by NVLAP*, NIST, or any agency of the Federal Government.

* This report may contain data that are not covered by the NVLAP accreditation and are marked with an asterisk "*".

Summary of Test Results	
Rule Part(s):	CFR 47 §2.1093
Test Procedure(s):	FCC OET Bulletin 65C IEEE1528-2003
Device Type:	Portable device
Exposure Category	Population/Uncontrolled
Modulation:	GMSK
TX Frequency Range:	824-849 MHz (Cellular Band) 1850-1910 MHz (PCS Band)
Maximum Conducted Power Tested:	31.86 dBm (Cellular Band) 28.64 dBm (PCS Band)
Antenna Type(s):	Internal Antenna
Body-Worn Accessories:	Headset
Face-Head Accessories:	None
Max. SAR Level(s) Measured:	1.046 W/Kg 1g Head Tissue (Cellular Band) 0.456 W/Kg 1g Body Tissue (Cellular Band) 1.071 W/Kg 1g Head Tissue (PCS Band) 0.423 W/Kg 1g Body Tissue (PCS Band)

This wireless device has been shown to be capable of compliance for localized specific absorption rate (SAR) for General Population/Uncontrolled Exposure limits specified in ANSI/IEEE Standards and has been tested in accordance with the measurement procedures specified in FCC OET 65 Supplement C and IEEE 1528-2003.

The results and statements contained in this report pertain only to the device(s) evaluated.



EUT Photo

TABLE OF CONTENTS

REFERENCE, STANDARDS AND GUIDELINES 4
 SAR LIMITS 5

EUT DESCRIPTION 6
 TECHNICAL SPECIFICATION 6
 EUT PHOTO 6

FACILITIES AND ACCREDITATION 7

DESCRIPTION OF TEST SYSTEM 8

EQUIPMENT LIST AND CALIBRATION 15
 EQUIPMENTS LIST & CALIBRATION INFO 15

SAR MEASUREMENT SYSTEM VERIFICATION 16
 LIQUID VERIFICATION..... 16
 SYSTEM ACCURACY VERIFICATION 19

EUT TEST STRATEGY AND METHODOLOGY 20
 TEST POSITIONS FOR DEVICE OPERATING NEXT TO A PERSON’S EAR 20
 CHEEK/TOUCH POSITION 21
 EAR/TILT POSITION..... 21
 TEST POSITIONS FOR BODY-WORN AND OTHER CONFIGURATIONS 22
 SAR EVALUATION PROCEDURE 23

SAR MEASUREMENT RESULTS 24
 SAR TEST DATA 24

APPENDIX A – MEASUREMENT UNCERTAINTY 26

APPENDIX B – PROBE CALIBRATION CERTIFICATES 27

APPENDIX C – DIPOLE CALIBRATION CERTIFICATES 67

APPENDIX D – SAR SYSTEM VALIDATION DATA 87

APPENDIX E – EUT SCAN RESULTS..... 91

APPENDIX F – CONDUCTED OUTPUT POWER MEASUREMENT 109
 TEST PROCEDURE 109
 TEST EQUIPMENT LIST AND DETAILS..... 109
 TEST RESULTS 109

APPENDIX G – EUT TEST POSITION PHOTOS 110
 BODY-WORN SETUP PHOTO 110
 LEFT HEAD TOUCH SETUP PHOTO 111
 LEFT HEAD TILT SETUP PHOTO 111
 RIGHT HEAD TOUCH SETUP PHOTO 112
 RIGHT HEAD TILT SETUP PHOTO 112

APPENDIX H – EUT PHOTOS..... 113
 EUT - TOP VIEW 113
 EUT - BOTTOM VIEW 113
 EUT – LEFT SIDE VIEW 114
 EUT - HEADSET 115

APPENDIX I - INFORMATIVE REFERENCES..... 116

APPENDIX J - PRODUCT SIMILAR DECLARATION LETTER 117

REFERENCE, STANDARDS AND GUIDELINES

FCC:

The Report and Order requires routine SAR evaluation prior to equipment authorization of portable transmitter devices, including portable telephones. For consumer products, the applicable limit is 1.6 mW/g as recommended by the ANSI/IEEE standard C95.1-1992 [6] for an uncontrolled environment (Paragraph 65). According to the Supplement C of OET Bulletin 65 "Evaluating Compliance with FCC Guide-lines for Human Exposure to Radio frequency Electromagnetic Fields", released on Jun 29, 2001 by the FCC, the device should be evaluated at maximum output power (radiated from the antenna) under "worst-case" conditions for normal or intended use, incorporating normal antenna operating positions, device peak performance frequencies and positions for maximum RF energy coupling.

This report describes the methodology and results of experiments performed on wireless data terminal. The objective was to determine if there is RF radiation and if radiation is found, what is the extent of radiation with respect to safety limits. SAR (Specific Absorption Rate) is the measure of RF exposure determined by the amount of RF energy absorbed by human body (or its parts) – to determine how the RF energy couples to the body or head which is a primary health concern for body worn devices. The limit below which the exposure to RF is considered safe by regulatory bodies in North America is 1.6 mW/g average over 1 gram of tissue mass.

CE:

The order requires routine SAR evaluation prior to equipment authorization of portable transmitter devices, including portable telephones. For consumer products, the applicable limit is 2 mW/g as recommended by the EN50360 for an uncontrolled environment. According to the Standard, the device should be evaluated at maximum output power (radiated from the antenna) under "worst-case" conditions for normal or intended use, incorporating normal antenna operating positions, device peak performance frequencies and positions for maximum RF energy coupling.

This report describes the methodology and results of experiments performed on wireless data terminal. The objective was to determine if there is RF radiation and if radiation is found, what is the extent of radiation with respect to safety limits. SAR (Specific Absorption Rate) is the measure of RF exposure determined by the amount of RF energy absorbed by human body (or its parts) – to determine how the RF energy couples to the body or head which is a primary health concern for body worn devices. The limit below which the exposure to RF is considered safe by regulatory bodies in Europe is 2 mW/g average over 10 gram of tissue mass.

The test configurations were laid out on a specially designed test fixture to ensure the reproducibility of measurements. Each configuration was scanned for SAR. Analysis of each scan was carried out to characterize the above effects in the device.

SAR Limits

FCC Limit (1g Tissue)

EXPOSURE LIMITS	SAR (W/kg)	
	(General Population / Uncontrolled Exposure Environment)	(Occupational / Controlled Exposure Environment)
Spatial Average (averaged over the whole body)	0.08	0.4
Spatial Peak (averaged over any 1 g of tissue)	1.60	8.0
Spatial Peak (hands/wrists/feet/ankles averaged over 10 g)	4.0	20.0

CE Limit (10g Tissue)

EXPOSURE LIMITS	SAR (W/kg)	
	(General Population / Uncontrolled Exposure Environment)	(Occupational / Controlled Exposure Environment)
Spatial Average (averaged over the whole body)	0.08	0.4
Spatial Peak (averaged over any 1 g of tissue)	2.0	10
Spatial Peak (hands/wrists/feet/ankles averaged over 10 g)	4.0	20.0

Population/Uncontrolled Environments are defined as locations where there is the exposure of individual who have no knowledge or control of their exposure.

Occupational/Controlled Environments are defined as locations where there is exposure that may be incurred by people who are aware of the potential for exposure (i.e. as a result of employment or occupation).

EUT DESCRIPTION

This Bay Area Compliance Laboratories Corp. test report has been prepared on behalf of Brightstar Corporation and their product, FCC ID: WVBAWIO20X or the EUT (Equipment Under Test) as referred to in the rest of this report.

***Note:** The series products, Model: C3017, Avvio205, Avvio 205A, Avvio 205E, Avvio 207, Avvio 207A, Avvio 207E, we select C3017 to test, there is no electrical change has been made to the equipment, which was explained in the Appendix J Product Similar Declaration Letter

Technical Specification

Item	Content
Modulation	GMSK
Frequency Band	Cellular Band: 824-849 MHz 869-894 MHz PCS Band: 1850-1910 MHz 1930-1990 MHz
Dimensions (L*W*H)	110mm (L)×47 mm (W)×13 mm (H)
Weight	70g
Power Source	3.7 Vdc/830mAh Rechargeable Battery
Normal Operation	Head and Body-worn

EUT Photo



*Model: C3017
Please refer to Appendix H*

FACILITIES AND ACCREDITATION

The test site used by Bay Area Compliance Laboratories Corp. (Shenzhen) to collect data is located at
6/F, the 3rd Phase of WanLi Industrial Building,
Shi Hua Road, Fu Tian Free Trade Zone,
Shenzhen, Guangdong, P.R. of China

Additionally, Bay Area Compliance Laboratories Corp. (Shenzhen) is a National Institute of Standards and Technology (NIST) accredited laboratory, under the National Voluntary Laboratory Accredited Program (Lab Code 200707-0).



NVLAP LAB CODE 200707-0

The current scope of accreditations can be found at <http://ts.nist.gov/Standards/scopes/2007070.htm>

DESCRIPTION OF TEST SYSTEM

These measurements were performed with ALSAS 10 Universal Integrated SAR Measurement system from APREL Laboratories.



ALSAS-10U System Description

ALSAS-10-U is fully compliant with the technical and scientific requirements of IEEE 1528, IEC 62209, CENELEC, ARIB, ACA, and the Federal Communications Commission. The system comprises of a six axes articulated robot which utilizes a dedicated controller. ALSAS-10U uses the latest methodologies. And FDTD modeling to provide a platform which is repeatable with minimum uncertainty.

Applications

Predefined measurement procedures compliant with the guidelines of CENELEC, IEEE, IEC, FCC, etc are utilized during the assessment for the device. Automatic detection for all SAR maxima are embedded within the core architecture for the system, ensuring that peak locations used for centering the zoom scan are within a 1mm resolution and a 0.05mm repeatable position. System operation range currently available up-to 6 GHz in simulated tissue.

Area Scans

Area scans are defined prior to the measurement process being executed with a user defined variable spacing between each measurement point (integral) allowing low uncertainty measurements to be conducted. Scans defined for FCC applications utilize a 10mm² step integral, with 1mm interpolation used to locate the peak SAR area used for zoom scan assessments. Where the system identifies multiple SAR peaks (which are within 25% of peak value) the system will provide the user with the option of assessing each peak location individually for zoom scan averaging.

Zoom Scan (Cube Scan Averaging)

The averaging zoom scan volume utilized in the ALSAS-10U software is in the shape of a cube and the side dimension of a 1 g or 10 g mass is dependent on the density of the liquid representing the simulated tissue. A density of 1000 kg/m³ is used to represent the head and body tissue density and not the phantom liquid density, in order to be consistent with the definition of the liquid dielectric properties, i.e. the side length of the 1 g cube is 10mm, with the side length of the 10 g cube 21,5mm.

When the cube intersects with the surface of the phantom, it is oriented so that 3 vertices touch the surface of the shell or the center of a face is tangent to the surface. The face of the cube closest to the surface is modified in order to conform to the tangent surface.

The zoom scan integer steps can be user defined so as to reduce uncertainty, but normal practice for typical test applications (including FCC) utilize a physical step of 5x5x8 (8mmx8mmx5mm) providing a volume of 32mm in the X & Y axis, and 35mm in the Z axis.

ALSAS-10U Interpolation and Extrapolation Uncertainty

The overall uncertainty for the methodology and algorithms the used during the SAR calculation was evaluated using the data from IEEE 1528 based on the example f3 algorithm:

$$f_3(x, y, z) = A \frac{a^2}{\frac{a^2}{4} + x'^2 + y'^2} \cdot \left(e^{-\frac{2z}{a}} + \frac{a^2}{2(a + 2z)^2} \right)$$

Isotropic E-Field Probe

The isotropic E-Field probe has been fully calibrated and assessed for isotropicity, and boundary effect within a controlled environment. Depending on the frequency for which the probe is calibrated the method utilized for calibration will change.

The E-Field probe utilizes a triangular sensor arrangement as detailed in the diagram below:

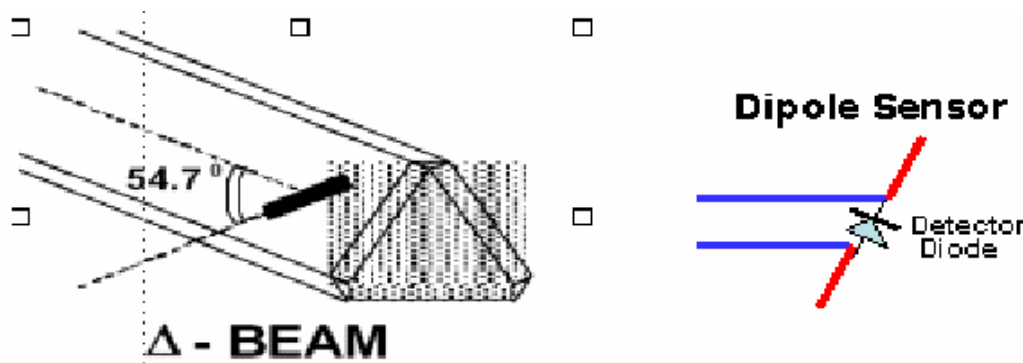

SAR is assessed with a calibrated probe which moves at a default height of 5mm from the center of the diode, which is mounted to the sensor, to the phantom surface (in the Z Axis). The 5mm offset height has been selected so as to minimize any resultant boundary effect due to the probe being in close proximity to the phantom surface.

The following algorithm is an example of the function used by the system for linearization of the output from the probe when measuring complex modulation schemes.

$$V_i = U_i + U_i^2 \cdot \frac{cf}{dcp_i}$$

Isotropic E-Field Probe Specification

Calibration in Air	Frequency Dependent Below 2 GHz Calibration in air performed in a TEM Cell Above 2 GHz Calibration in air performed in waveguide
Sensitivity	0.70 $\mu\text{V}/(\text{V}/\text{m})^2$ to 0.85 $\mu\text{V}/(\text{V}/\text{m})^2$
Dynamic Range	0.0005 W/kg to 100 W/kg
Isotropic Response	Better than 0.2 dB
Diode Compression Point (DCP)	Calibration for Specific Frequency
Probe Tip Radius	< 5 mm
Sensor Offset	1.56 (+/- 0.02 mm)
Probe Length	290 mm
Video Bandwidth	@ 500 Hz: 1 dB @ 1.02 kHz: 3 dB
Boundary Effect	Less than 2% for distance greater than 2.4 mm
Spatial Resolution	Diameter less than 5 mm Compliant with Standards

Boundary Detection Unit and Probe Mounting Device

ALSAS-10U incorporates a boundary detection unit with a sensitivity of 0.05mm for detecting all types of surfaces. The robust design allows for detection during probe tilt (probe normalize) exercises, and utilizes a second stage emergency stop. The signal electronics are fed directly into the robot controller for high accuracy surface detection in lateral and axial detection modes (X, Y, & Z).

The probe is mounted directly onto the Boundary Detection unit for accurate tooling and displacement calculations controlled by the robot kinematics. The probe is connect to an isolated probe interconnect where the output stage of the probe is fed directly into the amplifier stage of the Daq-Paq.

Daq-Paq (Analog to Digital Electronics)

ALSAS-10U incorporates a fully calibrated Daq-Paq (analog to digital conversion system) which has a 4 channel input stage, sent via a 2 stage auto-set amplifier module. The input signal is amplified accordingly so as to offer a dynamic range from 5 μV to 800mV. Integration of the fields measured is carried out at board level utilizing a Co-Processor which then sends the measured fields down into the main computational module in digitized form via an RS232 communications port. Probe linearity and duty cycle compensation is carried out within the main Daq-Paq module.

ADC	12 Bit
Amplifier Range	20 mV to 200 mV and 150 mV to 800 mV
Field Integration	Local Co-Processor utilizing proprietary integration algorithms
Number of Input Channels	4 in total 3 dedicated and 1 spare
Communication	Packet data via RS232

Axis Articulated Robot

ALSAS-10U utilizes a six axis articulated robot, which is controlled using a Pentium based real-time movement controller. The movement kinematics engine utilizes proprietary (Thermo CRS) interpolation and extrapolation algorithms, which allow full freedom of movement for each of the six joints within the working envelope. Utilization of joint 6 allows for full probe rotation with a tolerance better than 0.05mm around the central axis.



Robot/Controller Manufacturer	Thermo CRS
Number of Axis	Six independently controlled axis
Positioning Repeatability	0.05 mm
Controller Type	Single phase Pentium based C500C
Robot Reach	710 mm
Communication	RS232 and LAN compatible

ALSAS Universal Workstation

ALSAS Universal workstation allows for repeatability and fast adaptability. It allows users to do calibration, testing and measurements using different types of phantoms with one set up, which significantly speeds up the measurement process.

Universal Device Positioner

The universal device positioner allows complete freedom of movement of the EUT. Developed to hold a EUT in a free-space scenario any additional loading attributable to the material used in the construction of the positioner has been eliminated. Repeatability has been enhanced through the linear scales which form the design used to indicate positioning for any given test scenario in all major axes. A 15° tilt indicator is included for the of aid cheek to tilt movements for head SAR analysis. Overall uncertainty for measurements have been reduced due to the design of the Universal device positioner, which allows positioning of a device in as near to a free-space scenario as possible, and by providing the means for complete repeatability.



Phantom Types

The ALSAS-10U allows the integration of multiple phantom types. SAM Phantoms fully compliant with IEEE 1528, Universal Phantom, and Universal Flat.

APREL SAM Phantoms

The SAM phantoms developed using the IEEE SAM CAD file. They are fully compliant with the requirements for both IEEE 1528 and FCC Supplement C. Both the left and right SAM phantoms are interchangeable, transparent and include the IEEE 1528 grid with visible NF and MB lines.

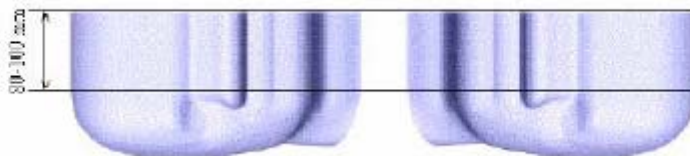

APREL Laboratories Universal Phantom

The Universal Phantom is used on the ALSAS-10U as a system validation phantom. The Universal Phantom has been fully validated both experimentally from 800MHz to 6GHz and numerically using XFDTD numerical software.

The shell thickness is 2mm overall, with a 4mm spacer located at the NF/MB intersection providing an overall thickness of 6mm in line with the requirements of IEEE-1528.

The design allows for fast and accurate measurements, of handsets, by allowing the conservative SAR to be evaluated at on frequency for both left and right head experiments in one measurement.



Tissue Dielectric Parameters for Head and Body Phantoms

The head tissue dielectric parameters recommended by the IEEE SCC-34/SC-2 in P1528 have been incorporated in the following table. These head parameters are derived from planar layer models simulating the highest expected SAR for the dielectric properties and tissue thickness variations in a human head. Other head and body tissue parameters that have not been specified in P1528 are derived from the tissue dielectric parameters computed from the 4-Cole-Cole equations described in Reference [12] and extrapolated according to the head parameters specified in P1528.

Ingredients (% by weight)	Frequency (MHz)									
	450		835		915		1900		2450	
Tissue Type	Head	Body	Head	Body	Head	Body	Head	Body	Head	Body
Water	38.56	51.16	41.45	52.4	41.05	56.0	54.9	40.4	62.7	73.2
Salt (NaCl)	3.95	1.49	1.45	1.4	1.35	0.76	0.18	0.5	0.5	0.04
Sugar	56.32	46.78	56.0	45.0	56.5	41.76	0.0	58.0	0.0	0.0
HEC	0.98	0.52	1.0	1.0	1.0	1.21	0.0	1.0	0.0	0.0
Bactericide	0.19	0.05	0.1	0.1	0.1	0.27	0.0	0.1	0.0	0.0
Triton x-100	0.0	0.0	0.0	0.0	0.0	0.0	0.0	0.0	36.8	0.0
DGBE	0.0	0.0	0.0	0.0	0.0	0.0	44.92	0.0	0.0	26.7
Dielectric Constant	43.42	58.0	42.54	56.1	42.0	56.8	39.9	54.0	39.8	52.5
Conductivity (s/m)	0.85	0.83	0.91	0.95	1.0	1.07	1.42	1.45	1.88	1.78

IEEE SCC-34/SC-2 P1528 Recommended Tissue Dielectric Parameters

Frequency (MHz)	Head Tissue		Body Tissue	
	ϵ_r	σ (S/m)	ϵ_r	σ (S/m)
150	52.3	0.76	61.9	0.80
300	45.3	0.87	58.2	0.92
450	43.5	0.87	56.7	0.94
835	41.5	0.90	55.2	0.97
900	41.5	0.97	55.0	1.05
915	41.5	0.98	55.0	1.06
1450	40.5	1.20	54.0	1.30
1610	40.3	1.29	53.8	1.40
1800-2000	40.0	1.40	53.3	1.52
2450	39.2	1.80	52.7	1.95
3000	38.5	2.40	52.0	2.73
5800	35.3	5.27	48.2	6.00

EQUIPMENT LIST AND CALIBRATION

Equipments List & Calibration Info

Equipment	Model	Calibration Due Date	S/N:
CRS F3 robot	ALS-F3	N/A	RAF0805352
CRS F3 Software	ALS-F3-SW	N/A	N/A
CRS C500C controller	ALS-C500	N/A	RCF0805379
Probe mounting device & Boundary Detection Sensor System	ALS-PMDPS-3	N/A	120-00270
Universal Work Station	ALS-UWS	N/A	100-00157
Data Acquisition Package	ALS-DAQ-PAQ-3	N/A	110-00212
Miniature E-Field Probe	ALS-E-020	2009-08-01	273
Dipole, 835MHz	ALS-D-835-S-2	2009-09-01	180-00558
Dipole,1900MHz	ALS-D-1900-S-2	2009-09-01	210-00710
Dipole Spacer	ALS-DS-U	N/A	250-00907
R&S, universal Radio Communication Tester	CMU200	2009-09-25	1100.0008.02
Device holder/Positioner	ALS-H-E-SET-2	N/A	170-00510
Left ear SAM phantom	ALS-P-SAM-L	N/A	130-00311
Right ear SAM phantom	ALS-P-SAM-R	N/A	140-00359
UniPhantom	ALS-P-UP-1	N/A	150-00413
Simulated Tissue 835 MHz Head	ALS-T-835-1-H	Each Time	270-01002
Simulated Tissue 835 MHz Body	ALS-T-835-1-B	Each Time	270-02101
Simulated Tissue 1900 MHz Head	ALS-T-1900-1-H	Each Time	295-01103
Simulated Tissue 1900 MHz Body	ALS-T-1900-1-B	Each Time	295-02102
Signal Generator	HP8341B	2009-11-06	2624A00116
Power Amplifier	5S1G4	N/A	71377
Spectrum Analyzer	FSEM30	2009-08-28	849720/019

SAR MEASUREMENT SYSTEM VERIFICATION

Liquid Verification

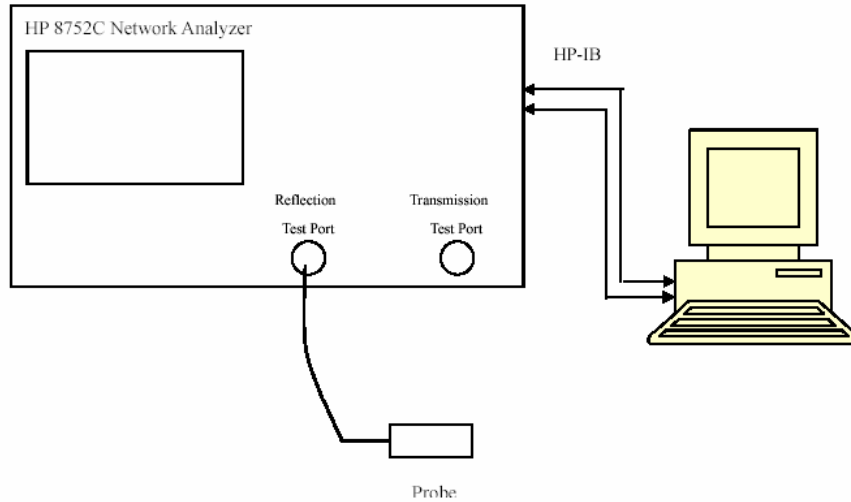

Liquid Verification Setup Block Diagram

Liquid Verification Results

Frequency (MHz)	Liquid Type	Liquid Parameter		Result
		ϵ_r	σ (S/m)	
850	Head	41.13	0.90	In Tolerance
850	Body	55.57	1.00	In Tolerance
1900	Head	39.54	1.45	In Tolerance
1900	Body	53.58	1.54	In Tolerance

Please refer to the following tables.

850 MHz Head				850 MHz Body		
Frequency	e'	e''		Frequency	e'	e''
824000000	41.239070	19.482276		824000000	55.668542	21.530923
824500000	41.140096	19.438513		824500000	55.570684	21.543467
825000000	41.149027	19.439575		825000000	55.605128	21.534734
825500000	41.093419	19.437139		825500000	55.615639	21.506951
826000000	41.079131	19.449876		826000000	55.551883	21.534899
826500000	41.115811	19.416892		826500000	55.561189	21.518760
827000000	41.106112	19.465370		827000000	55.607230	21.511223
827500000	41.159633	19.417159		827500000	55.603061	21.488985
828000000	41.130211	19.412942		828000000	55.565919	21.467992
828500000	41.151852	19.478996		828500000	55.564279	21.511702
829000000	41.169770	19.493285		829000000	55.616283	21.490643
829500000	41.187689	19.507523		829500000	55.592683	21.475779
830000000	41.180639	19.507586		830000000	55.601988	21.459639
830500000	41.176895	19.443662		830500000	55.588179	21.441135
831000000	41.139007	19.483833		831000000	55.561235	21.505312
831500000	41.119598	19.476861		831500000	55.576610	21.475777
832000000	41.106195	19.415846		832000000	55.563949	21.401485
832500000	41.143589	19.424587		832500000	55.556597	21.458148
833000000	41.110251	19.442519		833000000	55.513916	21.450688
833500000	41.114200	19.481412		833500000	55.589985	21.464520
834000000	41.142296	19.419475		834000000	55.591319	21.412762
834500000	41.133890	19.451310		834500000	55.577944	21.438400
835000000	41.131179	19.480386		835000000	55.572569	21.435096
835500000	41.142485	19.419139		835500000	55.602858	21.436792
836000000	41.156945	19.439272		836000000	55.533659	21.373552
836500000	41.100397	19.484485		836500000	55.541507	21.396532
837000000	41.151657	19.431812		837000000	55.490113	21.365190
837500000	41.098311	19.413797		837500000	55.551842	21.356530
838000000	41.157568	19.390089		838000000	55.537646	21.393412
838500000	41.103906	19.481145		838500000	55.501076	21.400406
839000000	41.133552	19.481247		839000000	55.552419	21.379132
839500000	41.129112	19.434003		839500000	55.504966	21.357499
840000000	41.110203	19.427124		840000000	55.467860	21.348343
840500000	41.122111	19.401220		840500000	55.492727	21.315382
841000000	41.144114	19.429276		841000000	55.512465	21.311738
841500000	41.130107	19.384938		841500000	55.489085	21.352011
842000000	41.111298	19.378114		842000000	55.497484	21.347217
842500000	41.107465	19.387657		842500000	55.478524	21.342098
843000000	41.106362	19.406702		843000000	55.459608	21.336973
843500000	41.088303	19.420256		843500000	55.456775	21.331085
844000000	41.081846	19.420219		844000000	55.486778	21.339667
844500000	41.061892	19.372708		844500000	55.425933	21.394351
845000000	41.054123	19.403856		845000000	55.467502	21.376602
845500000	41.034228	19.356449		845500000	55.385403	21.320091
846000000	40.976493	19.391583		846000000	55.355785	21.286687
846500000	41.032361	19.394267		846500000	55.419313	21.325480
847000000	41.021999	19.344299		847000000	55.412183	21.294243
847500000	40.998214	19.390150		847500000	55.406230	21.349145
848000000	40.987891	19.340260		848000000	55.389749	21.321557
848500000	40.985761	19.390053		848500000	55.370856	21.370616
849000000	40.963361	19.333536		849000000	55.367495	21.348738

1900 MHz Head				1900 MHz Body		
Frequency	e'	e''		Frequency	e'	e''
185000000	39.478610	13.366870		185000000	53.645454	14.480796
185120000	39.418751	13.361087		185120000	53.622284	14.466712
185240000	39.456570	13.396661		185240000	53.686385	14.479179
185360000	39.443260	13.374058		185360000	53.669560	14.422185
185480000	39.413738	13.373502		185480000	53.754054	14.494712
185600000	39.430893	13.370912		185600000	53.719638	14.505759
185720000	39.414608	13.377163		185720000	53.694041	14.463921
185840000	39.388352	13.386597		185840000	53.613155	14.464384
185960000	39.396932	13.365389		185960000	53.642919	14.455040
186080000	39.409803	13.365474		186080000	53.556430	14.416007
186200000	39.375788	13.400745		186200000	53.570107	14.450965
186320000	39.360663	13.394299		186320000	53.593462	14.488532
186440000	39.358201	13.412881		186440000	53.604894	14.454745
186560000	39.345819	13.410752		186560000	53.595596	14.443386
186680000	39.364041	13.491163		186680000	53.553135	14.428334
186800000	39.392506	13.559249		186800000	53.564825	14.427820
186920000	39.493048	13.723217		186920000	53.529032	14.436675
187040000	39.554675	13.824789		187040000	53.495102	14.447518
187160000	39.559667	13.883734		187160000	53.611296	14.471867
187280000	39.543492	13.865688		187280000	53.627067	14.508877
187400000	39.524983	13.858146		187400000	53.659030	14.534766
187520000	39.551338	13.993799		187520000	53.641599	14.489694
187640000	39.574590	13.981024		187640000	53.691150	14.559330
187760000	39.546801	13.925198		187760000	53.693190	14.556309
187880000	39.560899	13.969257		187880000	53.721560	14.577895
188000000	39.495501	13.868142		188000000	53.780839	14.608722
188120000	39.535303	13.871902		188120000	53.731026	14.585635
188240000	39.504845	13.812059		188240000	53.732655	14.594078
188360000	39.507685	13.800156		188360000	53.686126	14.586724
188480000	39.473094	13.767013		188480000	53.698143	14.581953
188600000	39.480759	13.758075		188600000	53.686913	14.617227
188720000	39.504933	13.732735		188720000	53.635219	14.595973
188840000	39.492803	13.730387		188840000	53.633579	14.592512
188960000	39.501626	13.699787		188960000	53.686970	14.624701
189080000	39.474963	13.721608		189080000	53.736286	14.615732
189200000	39.506741	13.727231		189200000	53.722501	14.623523
189320000	39.499494	13.694925		189320000	53.678710	14.602670
189440000	39.494753	13.708799		189440000	53.595103	14.558673
189560000	39.515118	13.724611		189560000	53.618449	14.610688
189680000	39.486809	13.729607		189680000	53.576622	14.591972
189800000	39.494827	13.735322		189800000	53.580847	14.590659
189920000	39.517498	13.707838		189920000	53.609008	14.574837
190040000	39.535207	13.719325		190040000	53.586037	14.600908
190160000	39.530520	13.733152		190160000	53.570919	14.570423
190280000	39.542786	13.736113		190280000	53.575195	14.569059
190400000	39.519174	13.720275		190400000	53.580079	14.552262
190520000	39.538399	13.724717		190520000	53.606396	14.582854
190640000	39.549488	13.716496		190640000	53.680534	14.580350
190760000	39.545513	13.694078		190760000	53.601410	14.529376
190880000	39.500272	13.686243		190880000	53.587596	14.596964
191000000	39.507106	13.722396		191000000	53.496302	14.560935

System Accuracy Verification

Prior to the assessment, the system validation kit was used to test whether the system was operating within its specifications of $\pm 10\%$. The validation results are tabulated below. And also the corresponding SAR plot is attached as well in the SAR plots files.

System Verification Setup Block Diagram

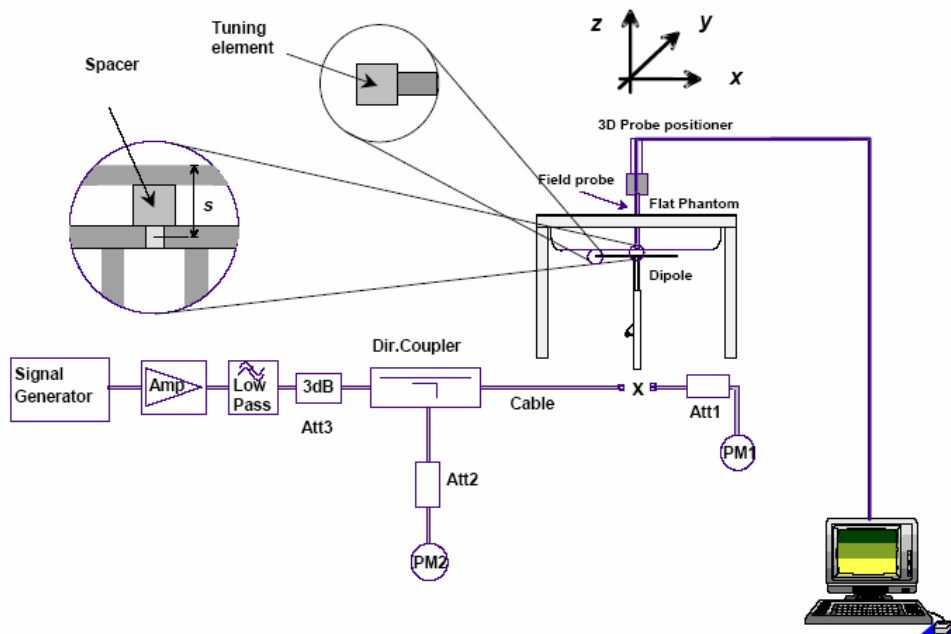

System Accuracy Check Results

Frequency (MHz)	1 g SAR (W/Kg)	10 g SAR (W/Kg)	Result
835	9.651	6.042	In Tolerance
1900	40.328	20.137	In Tolerance

* Note: All SAR values are normalized to 1 Watt forward power.

IEEE P1528 recommended reference value for Head Tissue

Frequency (MHz)	1 g SAR (W/Kg)	10 g SAR (W/Kg)	Local SAR at surface (above feed point)	Local SAR at surface (v=2cm offset from feed point)
300	3.0	2.0	4.4	2.1
450	4.9	3.3	7.2	3.2
835	9.5	6.2	14.1	4.9
900	10.8	6.9	16.4	5.4
1450	29.0	16.0	50.2	6.5
1800	38.1	19.8	69.5	6.8
1900	39.7	20.5	72.1	6.6
2000	41.1	21.1	74.6	6.5
2450	52.4	24.0	104.2	7.7
3000	63.8	25.7	140.2	9.5

EUT TEST STRATEGY AND METHODOLOGY

Test Positions for Device Operating Next to a Person’s Ear

This category includes most wireless handsets with fixed, retractable or internal antennas located toward the top half of the device, with or without a foldout, sliding or similar keypad cover. The handset should have its earpiece located within the upper ¼ of the device, either along the centerline or off-centered, as perceived by its users. This type of handset should be positioned in a normal operating position with the “test device reference point” located along the “vertical centerline” on the front of the device aligned to the “ear reference point”. The “test device reference point” should be located at the same level as the center of the earpiece region. The “vertical centerline” should bisect the front surface of the handset at its top and bottom edges. A “ear reference point” is located on the outer surface of the head phantom on each ear spacer. It is located 1.5 cm above the center of the ear canal entrance in the “phantom reference plane” defined by the three lines joining the center of each “ear reference point” (left and right) and the tip of the mouth.

A handset should be initially positioned with the earpiece region pressed against the ear spacer of a head phantom. For the SCC-34/SC-2 head phantom, the device should be positioned parallel to the “N-F” line defined along the base of the ear spacer that contains the “ear reference point”. For interim head phantoms, the device should be positioned parallel to the cheek for maximum RF energy coupling. The “test device reference point” is aligned to the “ear reference point” on the head phantom and the “vertical centerline” is aligned to the “phantom reference plane”. This is called the “initial ear position”. While maintaining these three alignments, the body of the handset is gradually adjusted to each of the following positions for evaluating SAR:

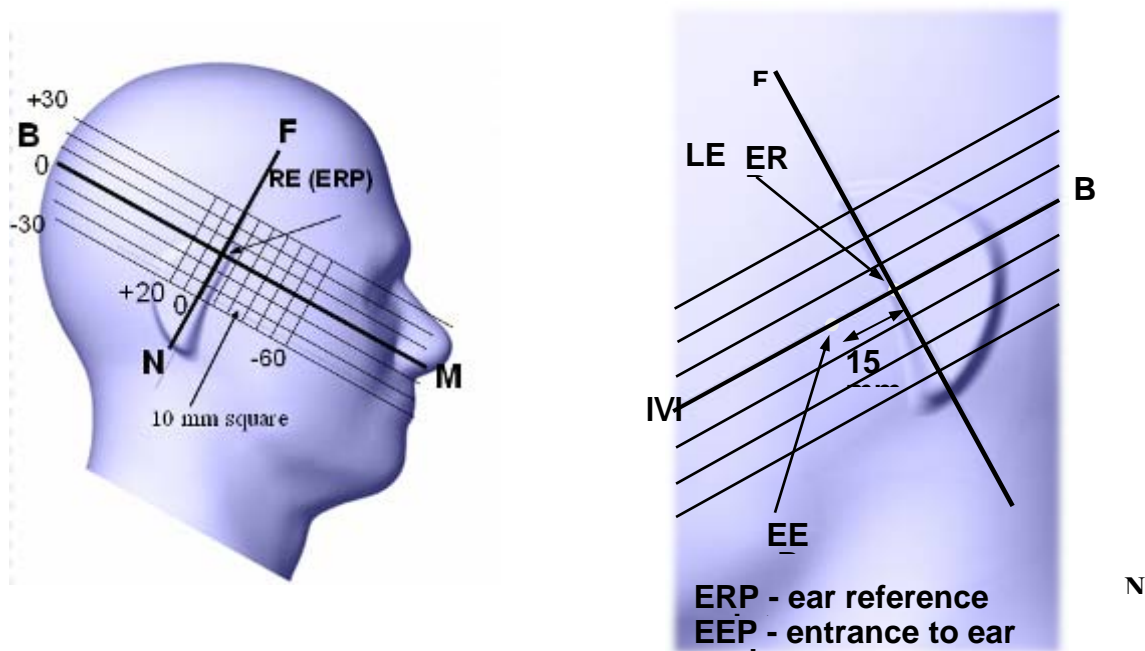

Cheek/Touch Position

The device is brought toward the mouth of the head phantom by pivoting against the “ear reference point” or along the “N-F” line for the SCC-34/SC-2 head phantom.

This test position is established:

- When any point on the display, keypad or mouthpiece portions of the handset is in contact with the phantom.
- (or) When any portion of a foldout, sliding or similar keypad cover opened to its intended self-adjusting normal use position is in contact with the cheek or mouth of the phantom.

For existing head phantoms – when the handset loses contact with the phantom at the pivoting point, rotation should continue until the device touches the cheek of the phantom or breaks its last contact from the ear spacer.

Check /Touch Position

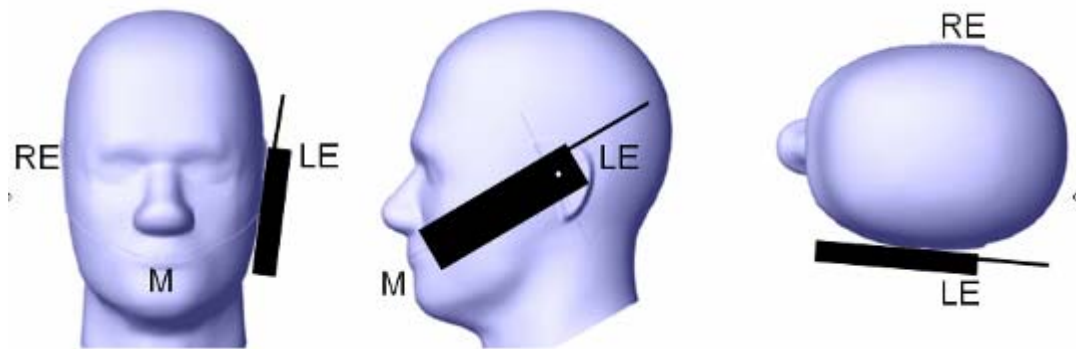

Ear/Tilt Position

With the handset aligned in the “Cheek/Touch Position”:

1) If the earpiece of the handset is not in full contact with the phantom’s ear spacer (in the “Cheek/Touch position”) and the peak SAR location for the “Cheek/Touch” position is located at the ear spacer region or corresponds to the earpiece region of the handset, the device should be returned to the “initial ear position” by rotating it away from the mouth until the earpiece is in full contact with the ear spacer.

2) (otherwise) The handset should be moved (translated) away from the cheek perpendicular to the line passes through both “ear reference points” (note: one of these ear reference points may not physically exist on a split head model) for approximate 2-3 cm. While it is in this position, the device handset is tilted away from the mouth with respect to the “test device reference point” until the inside angle between the vertical centerline on the front surface of the phone and the horizontal line passing through the ear reference point is by 15 80°. After the tilt, it is then moved (translated) back toward the head perpendicular to the line passes through both “ear reference points” until the device touches the phantom or the ear spacer. If the antenna touches the head first, the positioning process should be repeated with a tilt angle less than 15° so that the device and its antenna would touch the phantom simultaneously. This test position may require a device holder or positioner to achieve the translation and tilting with acceptable positioning repeatability.

If a device is also designed to transmit with its keypad cover closed for operating in the head position, such positions should also be considered in the SAR evaluation. The device should be tested on the left and right side of the head phantom in the “Cheek/Touch” and “Ear/Tilt” positions. When applicable, each configuration should be tested with the antenna in its fully extended and fully retracted positions. These test configurations should be tested at the high, middle and low frequency channels of each operating mode; for example, AMPS, CDMA, and TDMA. If the SAR measured at the middle channel for each test configuration (left, right, Cheek/Touch, Tile/Ear, extended and retracted) is at least 2.0 dB lower than the SAR limit, testing at the high and low channels is optional for such test configuration(s). If the transmission band of the test device is less than 10 MHz, testing at the high and low frequency channels is optional.

Ear /Tilt 15° Position

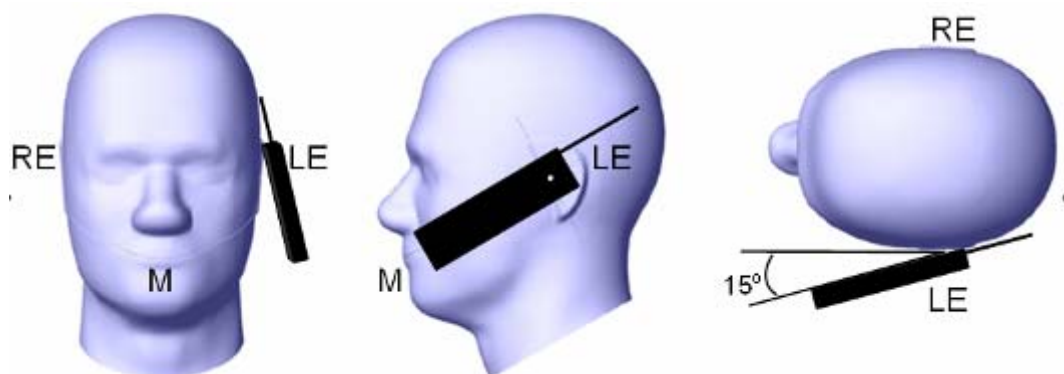

Test positions for body-worn and other configurations

Body-worn operating configurations should be tested with the belt-clips and holsters attached to the device and positioned against a flat phantom in normal use configurations. Devices with a headset output should be tested with a headset connected to the device. When multiple accessories that do not contain metallic components are supplied with the device, the device may be tested with only the accessory that dictates the closest spacing to the body. When multiple accessories that contain metallic components are supplied with the device, the device must be tested with each accessory that contains a unique metallic component. If multiple accessories share an identical metallic component (e.g., the same metallic belt-clip used with different holsters with no other metallic components), only the accessory that dictates the closest spacing to the body must be tested.

Body-worn accessories may not always be supplied or available as options for some devices that are intended to be authorized for body-worn use. A separation distance of 1.5 cm between the back of the device and a flat phantom is recommended for testing body-worn SAR compliance under such circumstances. Other separation distances may be used, but they should not exceed 2.5 cm. In these cases, the device may use body-worn accessories that provide a separation distance greater than that tested for the device provided however that the accessory contains no metallic components.

SAR Evaluation Procedure

The evaluation was performed with the following procedure:

Step 1: Measurement of the SAR value at a fixed location above the ear point or central position was used as a reference value for assessing the power drop. The SAR at this point is measured at the start of the test and then again at the end of the testing.

Step 2: The SAR distribution at the exposed side of the head was measured at a distance of 4 mm from the inner surface of the shell. The area covered the entire dimension of the head or EUT and the horizontal grid spacing was 15 mm x 15 mm. Based on these data, the area of the maximum absorption was determined by spline interpolation. The first Area Scan covers the entire dimension of the EUT to ensure that the hotspot was correctly identified.

Step 3: Around this point, a volume of 30 mm x 30 mm x 21 mm was assessed by measuring 5 x 5 x 7 points. On the basis of this data set, the spatial peak SAR value was evaluated under the following procedure:

- 1) The data at the surface were extrapolated, since the center of the dipoles is 1.2 mm away from the tip of the probe and the distance between the surface and the lowest measuring point is 1.3 mm. The extrapolation was based on a least square algorithm. A polynomial of the fourth order was calculated through the points in z-axes. This polynomial was then used to evaluate the points between the surface and the probe tip.
- 2) The maximum interpolated value was searched with a straightforward algorithm. Around this maximum the SAR values averaged over the spatial volumes (1 g or 10 g) were computed by the 3D-Spline interpolation algorithm. The 3D-Spline is composed of three one dimensional splines with the "Not a knot"-condition (in x, y and z-directions). The volume was integrated with the trapezoidal-algorithm. One thousand points (10 x 10 x 10) were interpolated to calculate the averages.

All neighboring volumes were evaluated until no neighboring volume with a higher average value was found.

Step 4: Re-measurement of the SAR value at the same location as in Step 1. If the value changed by more than 5%, the evaluation was repeated.

SAR MEASUREMENT RESULTS

This page summarizes the results of the performed dosimetric evaluation. The plots with the corresponding SAR distributions, which reveal information about the location of the maximum SAR with respect to the device, could be found in Appendix E.

SAR Test Data

Environmental Conditions

Temperature:	23° C
Relative Humidity:	50%
ATM Pressure:	1003 mbar

* Testing was performed by Eric Zhang on 2009-07-29.

Cellular Band:

EUT Position	Frequency (MHz)	Test Type	Test Mode	Antenna Type	Liquid	Phantom	Accessories	1g SAR Value (W/Kg)	FCC Limit (W/Kg)	Ref. Plot #
Left Head Cheek	824.2	Head	GSM	Integral	Head	Left Head	-	1.030	1.6	1
Left Head Cheek	836.6	Head	GSM	Integral	Head	Left Head	-	0.894	1.6	2
Left Head Cheek	848.8	Head	GSM	Integral	Head	Left Head	-	0.904	1.6	3
Left Head Tilt	824.2	Head	GSM	Integral	Head	Left Head	-	0.635	1.6	4
Right Head Cheek	824.2	Head	GSM	Integral	Head	Right Head	-	1.046	1.6	5
Right Head Cheek	836.6	Head	GSM	Integral	Head	Right Head	-	0.989	1.6	6
Right Head Cheek	848.8	Head	GSM	Integral	Head	Right Head	-	0.994	1.6	7
Right Head Tilt	824.2	Head	GSM	Integral	Head	Right Head	-	0.517	1.6	8
Body-Worn Back	824.2	Body	GSM	Integral	Body	Flat	Headset	0.456	1.6	9

PCS Band:

EUT Position	Frequency (MHz)	Test Type	Test Mode	Antenna Type	Liquid	Phantom	Accessories	1g SAR Value (W/Kg)	FCC Limit (W/Kg)	Ref. Plot #
Left Head Cheek	1909.8	Head	GSM	Integral	Head	Left Head	-	0.983	1.6	10
Left Head Cheek	1850.2	Head	GSM	Integral	Head	Left Head	-	0.935	1.6	11
Left Head Cheek	1880.0	Head	GSM	Integral	Head	Left Head	-	0.924	1.6	12
Left Head Tilt	1909.8	Head	GSM	Integral	Head	Left Head	-	0.498	1.6	13
Right Head Cheek	1909.8	Head	GSM	Integral	Head	Right Head	-	1.071	1.6	14
Right Head Cheek	1850.2	Head	GSM	Integral	Head	Right Head	-	1.030	1.6	15
Right Head Cheek	1880.0	Head	GSM	Integral	Head	Right Head	-	0.989	1.6	16
Right Head Tilt	1909.8	Head	GSM	Integral	Head	Right Head	-	0.443	1.6	17
Body-Worn Back	1909.8	Body	GSM	Integral	Body	Flat	Headset	0.423	1.6	18

APPENDIX A – MEASUREMENT UNCERTAINTY

The uncertainty budget has been determined for the measurement system and is given in the following Table.

Exposure Assessment Measurement Uncertainty

Source of Uncertainty	Tolerance Value	Probability Distribution	Divisor	c_i^1 (1-g)	c_i^1 (10-g)	Standard Uncertainty (1-g) %	Standard Uncertainty (10-g) %
Measurement System							
Probe Calibration	3.5	normal	1	1	1	3.5	3.5
Axial Isotropy	3.7	rectangular	$\sqrt{3}$	$(1-cp)^{1/2}$	$(\frac{1-cp}{2})^1$	1.5	1.5
Hemispherical Isotropy	10.9	rectangular	$\sqrt{3}$	\sqrt{cp}	\sqrt{cp}	4.4	4.4
Boundary Effect	1.0	rectangular	$\sqrt{3}$	1	1	0.6	0.6
Linearity	4.7	rectangular	$\sqrt{3}$	1	1	2.7	2.7
Detection Limit	1.0	rectangular	$\sqrt{3}$	1	1	0.6	0.6
Readout Electronics	1.0	normal	1	1	1	1.0	1.0
Response Time	0.8	rectangular	$\sqrt{3}$	1	1	0.5	0.5
Integration Time	1.7	rectangular	$\sqrt{3}$	1	1	1.0	1.0
RF Ambient Condition	3.0	rectangular	$\sqrt{3}$	1	1	1.7	1.7
Probe Positioner Mech.	0.4	rectangular	$\sqrt{3}$	1	1	0.2	0.2
Restriction							
Probe Positioning with respect to Phantom Shell	2.9	rectangular	$\sqrt{3}$	1	1	1.7	1.7
Extrapolation and Integration	3.7	rectangular	$\sqrt{3}$	1	1	2.1	2.1
Test Sample Positioning	4.0	normal	1	1	1	4.0	4.0
Device Holder Uncertainty	2.0	normal	1	1	1	2.0	2.0
Drift of Output Power	3.2	rectangular	$\sqrt{3}$	1	1	1.8	1.8
Phantom and Setup							
Phantom Uncertainty(shape & thickness tolerance)	3.4	rectangular	$\sqrt{3}$	1	1	2.0	2.0
Liquid Conductivity(target)	5.0	rectangular	$\sqrt{3}$	0.7	0.5	2.0	1.4
Liquid Conductivity(meas.)	0.0	normal	1	0.7	0.5	0.0	0.0
Liquid Permittivity(target)	5.0	rectangular	$\sqrt{3}$	0.6	0.5	1.7	1.4
Liquid Permittivity(meas.)	0.0	normal	1	0.6	0.5	0.0	0.0
Combined Uncertainty		RSS				9.4	9.2
Combined Uncertainty (coverage factor=2)		Normal(k=2)				18.8	18.5

APPENDIX B – PROBE CALIBRATION CERTIFICATES

NCL CALIBRATION LABORATORIES

Calibration File No.: CP-871

Client.: BACL

CERTIFICATE OF CALIBRATION

It is certified that the equipment identified below has been calibrated in the
NCL CALIBRATION LABORATORIES by qualified personnel following recognized
procedures and using transfer standards traceable to NRC/NIST.

Equipment: Miniature Isotropic RF Probe 835 MHz

Manufacturer: APREL Laboratories

Model No.: E-020

Serial No.: 273

Calibration Procedure: SSI/DRB-TP-D01-032-E020-V2

Project No: BACB-ALSAS10U-5323

Calibrated: 1st August 2008

Released on: 1st September 2008

This Calibration Certificate is Incomplete Unless Accompanied with the Calibration Results Summary

Released By: _____

NCL CALIBRATION LABORATORIES

51 SPECTRUM WAY
NEPEAN, ONTARIO
CANADA K2R 1E8

Division of APREL Lab.
TEL: (613) 820-4988
FAX: (613) 820-4161

NCL Calibration Laboratories

Division of APREL Laboratories.

Introduction

This Calibration Report reproduces the results of the calibration performed in line with the SSI/DRB-TP-D01-032-E020-V2 E-Field Probe Calibration Procedure. The results contained within this report are for APREL E-Field Probe E-020 273.

References

- SSI/DRB-TP-D01-032-E020-V2 E-Field Probe Calibration Procedure
- IEEE 1528 "Recommended Practice for Determining the Peak Spatial-Average Specific Absorption Rate (SAR) in the Human Body Due to Wireless Communications Devices; Experimental Techniques"
- SSI-TP-011 Tissue Calibration Procedure

Conditions

Probe 273 was a new probe taken from stock prior to calibration.

Ambient Temperature of the Laboratory: 22 °C +/- 0.5°C
Temperature of the Tissue: 21 °C +/- 0.5°C

We the undersigned attest that to the best of our knowledge the calibration of this probe has been accurately conducted and that all information contained within this report has been reviewed for accuracy.

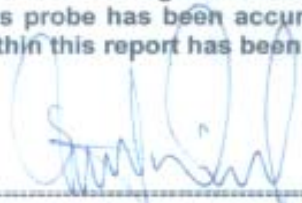

Stuart Nicol



Jesse Hones

Page 2 of 10
This page has been reviewed for content and attested to on Page 2 of this document.

NCL Calibration Laboratories

Division of APREL Laboratories.

Calibration Results Summary

Probe Type:	E-Field Probe E-020
Serial Number:	273
Frequency:	835 MHz
Sensor Offset:	1.56 mm
Sensor Length:	2.5 mm
Tip Enclosure:	Ertalyte*
Tip Diameter:	<5 mm
Tip Length:	60 mm
Total Length:	290 mm

*Resistive to recommended tissue recipes per IEEE-1528

Sensitivity in Air

Channel X:	1.2 $\mu\text{V}/(\text{V}/\text{m})^2$
Channel Y:	1.2 $\mu\text{V}/(\text{V}/\text{m})^2$
Channel Z:	1.2 $\mu\text{V}/(\text{V}/\text{m})^2$
Diode Compression Point:	95 mV

Page 3 of 10

This page has been reviewed for content and attested to on Page 2 of this document.

NCL Calibration LaboratoriesDivision of APREL Laboratories.

Sensitivity in Head Tissue Measured**Frequency:** 835 MHz**Epsilon:** 41.24 (+/-5%)**Sigma:** 0.87 S/m (+/-5%)**ConvF****Channel X:** 6.5**Channel Y:** 6.5**Channel Z:** 6.5

Tissue sensitivity values were calculated using the load impedance of the APREL Laboratories Daq-Paq.

Boundary Effect:

Uncertainty resulting from the boundary effect is less than 2% for the distance between the tip of the probe and the tissue boundary, when less than 2.44mm.

Spatial Resolution:

The measured probe tip diameter is 5 mm (+/- 0.01 mm) and therefore meets the requirements of SSI/DRB-TP-D01-032 for spatial resolution.

Page 4 of 10

This page has been reviewed for content and attested to on Page 2 of this document.

NCL Calibration Laboratories

Division of APREL Laboratories.

Receiving Pattern 835 MHz (Air)



NCL Calibration Laboratories

Division of APREL Laboratories.

Isotropy Error 835 MHz (Air)

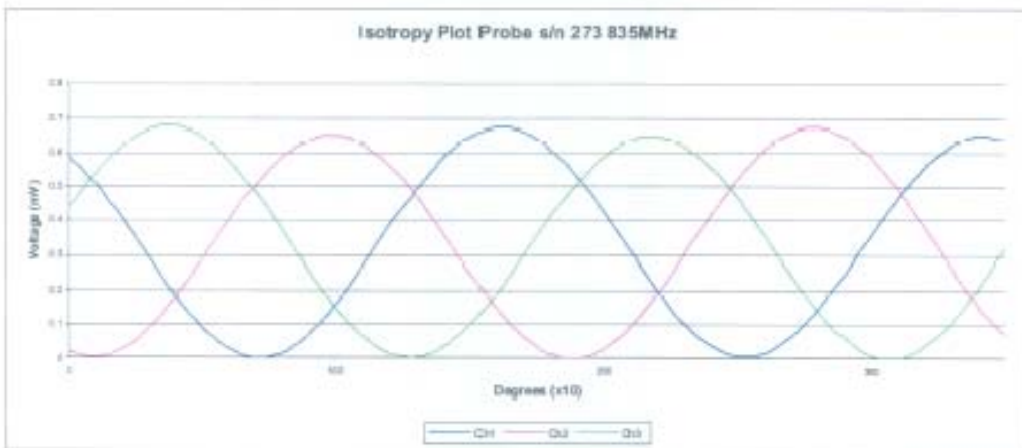
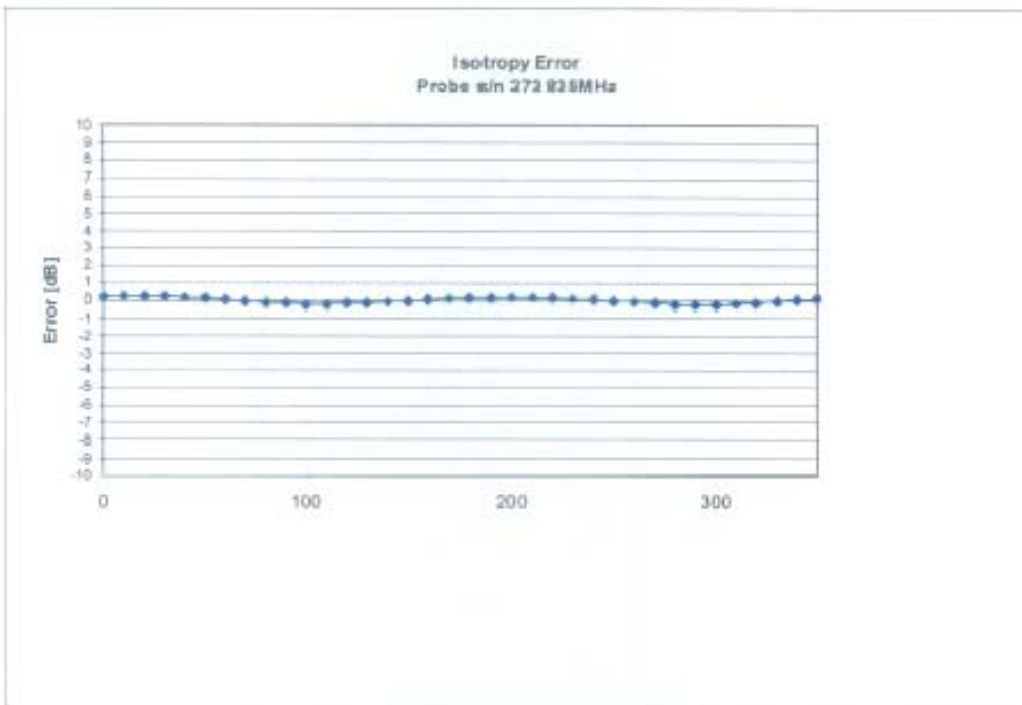

Isotropy Tissue:

0.10 dB

Page 6 of 10

This page has been reviewed for content and attested to on Page 2 of this document.

NCL Calibration Laboratories

Division of APREL Laboratories.

Dynamic Range

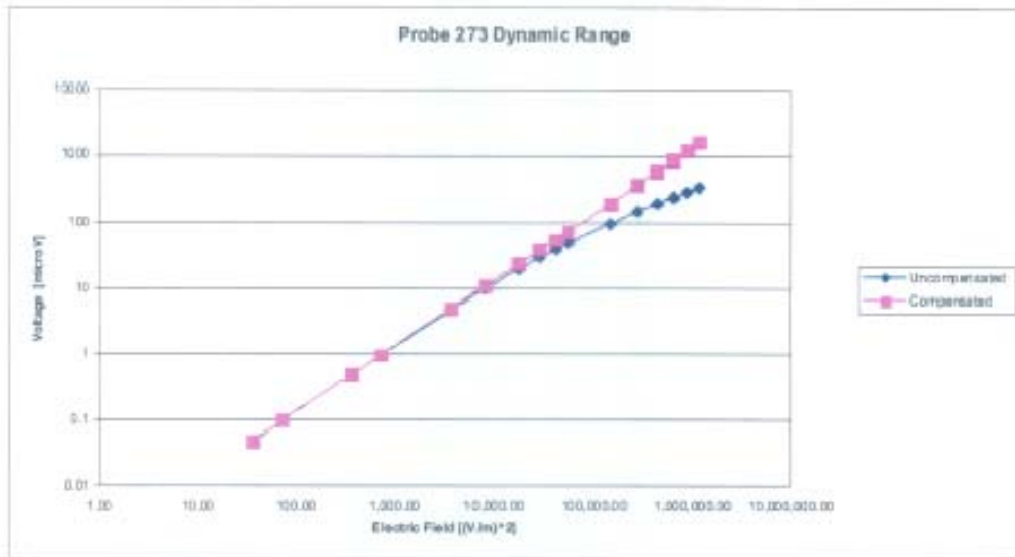

NCL Calibration Laboratories

Division of APREL Laboratories.

Video Bandwidth

Probe Frequency Characteristics

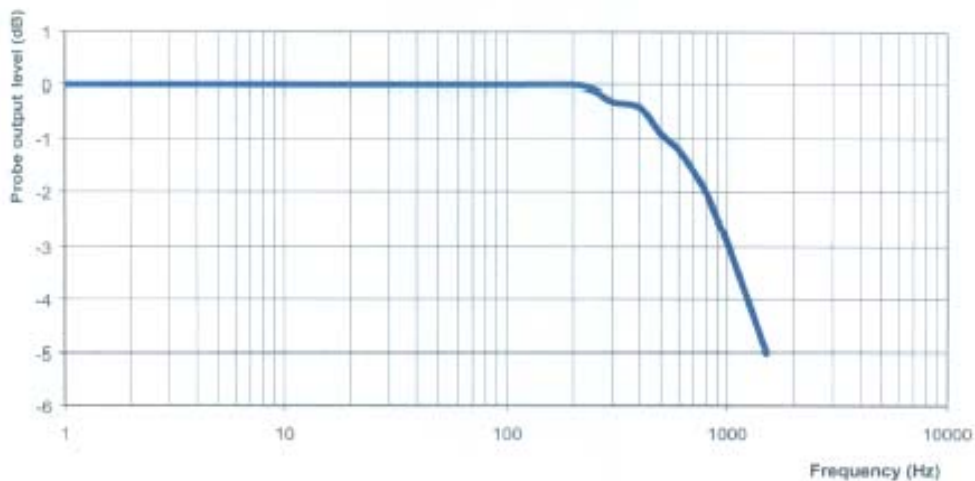

Video Bandwidth at 500 Hz 1 dB
Video Bandwidth at 1.02 KHz: 3 dB

NCL Calibration LaboratoriesDivision of APREL Laboratories.

Conversion Factor Uncertainty Assessment

Frequency: 835MHz
Epsilon: 41.24 (+/-5%) **Sigma:** 0.87 S/m (+/-5%)

ConvF

Channel X: 6.5 7%(K=2)
Channel Y: 6.5 7%(K=2)
Channel Z: 6.5 7%(K=2)

To minimize the uncertainty calculation all tissue sensitivity values were calculated using a load impedance of 5 M Ω .

Boundary Effect:

For a distance of 2.5mm the evaluated uncertainty (increase in the probe sensitivity) is less than 2%.

Page 9 of 10

This page has been reviewed for content and attested to on Page 2 of this document.

NCL Calibration Laboratories

Division of APREL Laboratories.

Test Equipment

The test equipment used during Probe Calibration, manufacturer, model number and, current calibration status are listed and located on the main APREL server R:\NCL\Calibration Equipment\Instrument List May 2008.

Page 10 of 10

This page has been reviewed for content and attested to on Page 2 of this document.

NCL CALIBRATION LABORATORIES

Calibration File No.: CP-872

Client.: BACL

CERTIFICATE OF CALIBRATION

It is certified that the equipment identified below has been calibrated in the **NCL CALIBRATION LABORATORIES** by qualified personnel following recognized procedures and using transfer standards traceable to NRC/NIST.

Equipment: Miniature isotropic RF Probe 835 MHz

Manufacturer: APREL Laboratories

Model No.: E-020

Serial No.: 273

Calibration in Body Tissue

Calibration Procedure: SSI/DRB-TP-D01-032-E020-V2

Project No: BACL-ALSAS10U-5323

Calibrated: 1st September 2008

Released on: 1st September 2008

This Calibration Certificate is Incomplete Unless Accompanied with the Calibration Results Summary

Released By: _____



NCL CALIBRATION LABORATORIES

51 SPECTRUM WAY
NEPEAN, ONTARIO
CANADA K2R 1E8

Division of APREL Lab.
TEL: (613) 820-4898
FAX: (613) 820-4161

NCL Calibration Laboratories

Division of APREL Laboratories.

Introduction

This Calibration Report reproduces the results of the calibration performed in line with the SSI/DRB-TP-D01-032-E020-V2 E-Field Probe Calibration Procedure. The results contained within this report are for APREL E-Field Probe E-020 273.

References

SSI/DRB-TP-D01-032-E020-V2 E-Field Probe Calibration Procedure
IEEE 1528 "Recommended Practice for Determining the Peak Spatial-Average Specific Absorption Rate (SAR) in the Human Body Due to Wireless Communications Devices: Experimental Techniques"
SSI-TP-011 Tissue Calibration Procedure

Conditions

Probe 273 was a new probe taken from stock prior to calibration.

Ambient Temperature of the Laboratory: 22 °C +/- 0.5°C
Temperature of the Tissue: 21 °C +/- 0.5°C

We the undersigned attest that to the best of our knowledge the calibration of this probe has been accurately conducted and that all information contained within this report has been reviewed for accuracy.



Stuart Nicol

Jesse Hones

Page 2 of 10

This page has been reviewed for content and attested to on Page 2 of this document.

NCL Calibration Laboratories

Division of APREL Laboratories.

Calibration Results Summary

Probe Type:	E-Field Probe E-020
Serial Number:	273
Frequency:	835 MHz
Sensor Offset:	1.56 mm
Sensor Length:	2.5 mm
Tip Enclosure:	Ertalyte*
Tip Diameter:	<5 mm
Tip Length:	60 mm
Total Length:	290 mm

*Resistive to recommended tissue recipes per IEEE-1528

Sensitivity in Air

Channel X:	1.2 $\mu\text{V}/(\text{V}/\text{m})^2$
Channel Y:	1.2 $\mu\text{V}/(\text{V}/\text{m})^2$
Channel Z:	1.2 $\mu\text{V}/(\text{V}/\text{m})^2$
Diode Compression Point:	95 mV

Page 3 of 10

This page has been reviewed for content and attested to on Page 2 of this document.

NCL Calibration Laboratories

Division of APREL Laboratories.

Sensitivity in Body Tissue Measured

Frequency: 835 MHz
Epsilon: 56.16 (+/-5%) **Sigma:** 0.99 S/m (+/-10%)

ConvF

Channel X: 6.7
Channel Y: 6.7
Channel Z: 6.7

Tissue sensitivity values were calculated using the load impedance of the APREL Laboratories Daq-Paq.

Boundary Effect:

Uncertainty resulting from the boundary effect is less than 2% for the distance between the tip of the probe and the tissue boundary, when less than 2.44mm.

Spatial Resolution:

The measured probe tip diameter is 5 mm (+/- 0.01 mm) and therefore meets the requirements of SSI/DRB-TP-D01-032 for spatial resolution.

Page 4 of 10

This page has been reviewed for content and attested to on Page 2 of this document.

NCL Calibration Laboratories

Division of APREL Laboratories.

Receiving Pattern 835 MHz (Air)

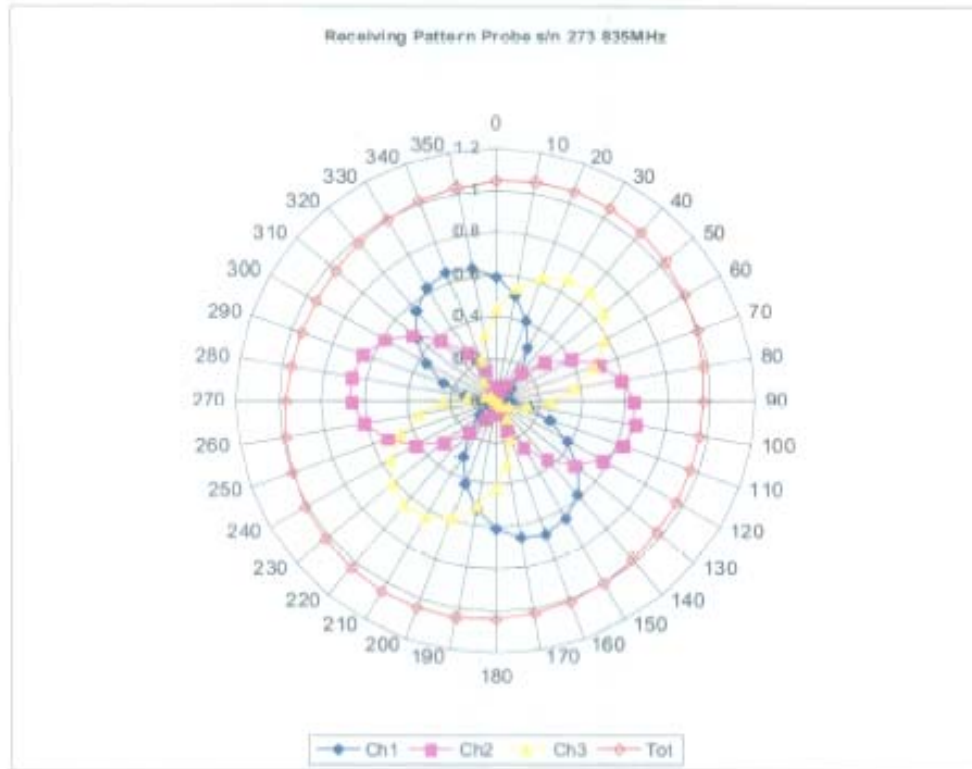

Page 5 of 10

This page has been reviewed for content and attested to on Page 2 of this document.

NCL Calibration Laboratories

Division of APREL Laboratories.

Isotropy Error 835 MHz (Air)

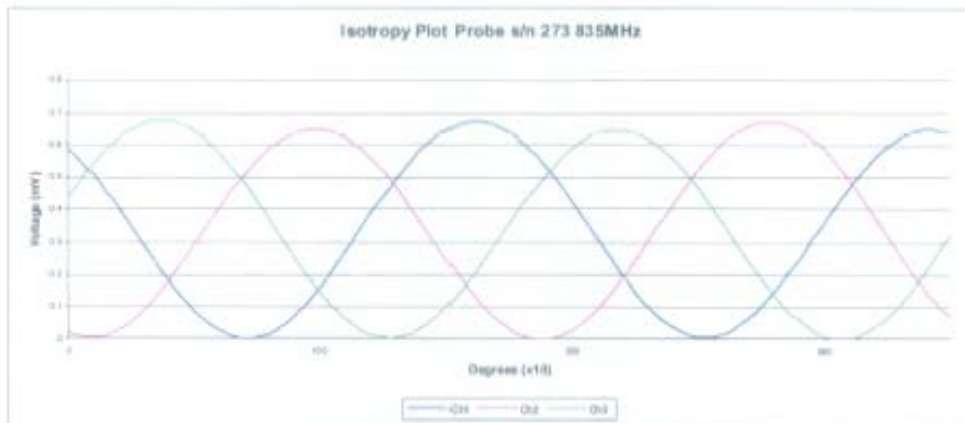
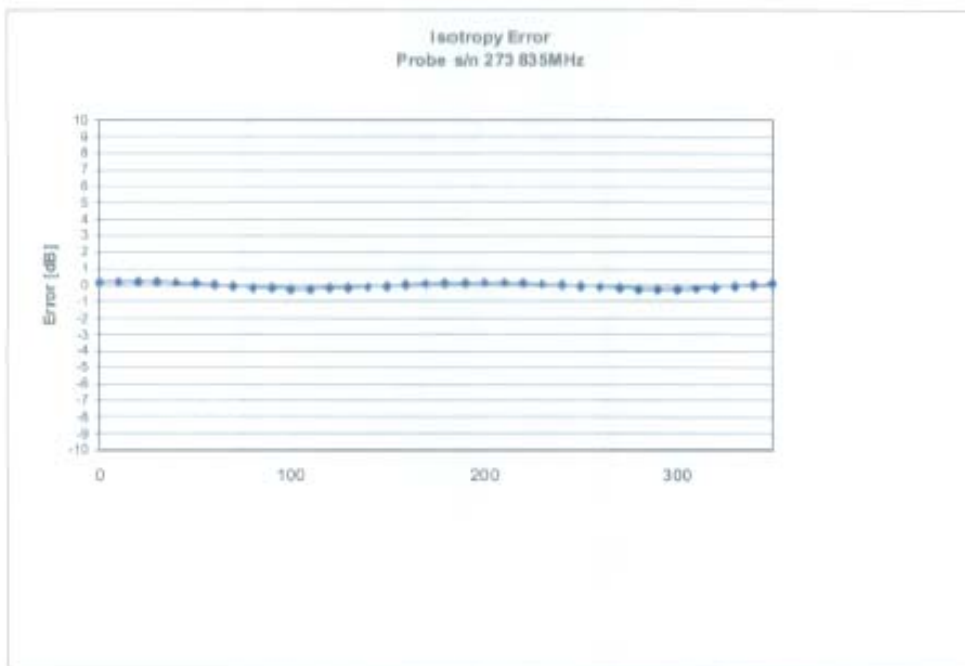

Isotropicity in Tissue: 0.10 dB

NCL Calibration Laboratories

Division of APREL Laboratories,

Dynamic Range



Page 7 of 10

This page has been reviewed for content and attested to on Page 2 of this document.

NCL Calibration Laboratories

Division of APREL Laboratories.

Video Bandwidth

Probe Frequency Characteristics

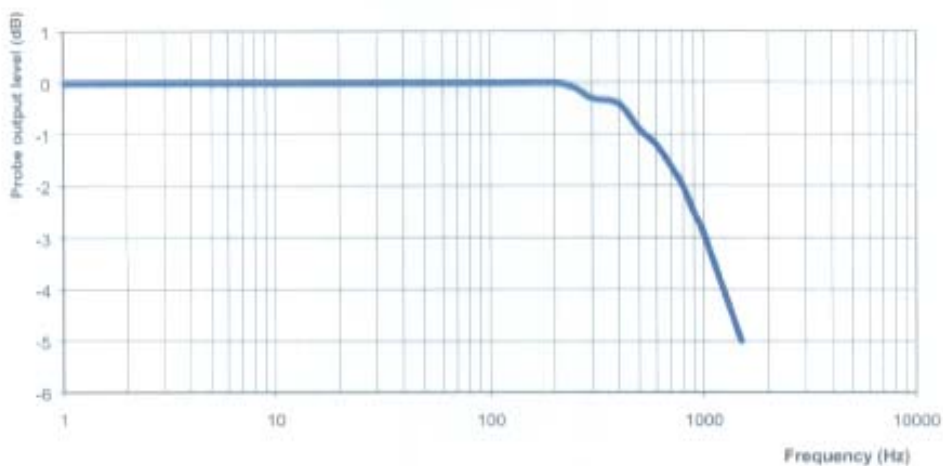

Video Bandwidth at 500 Hz 1 dB
Video Bandwidth at 1.02 KHz: 3 dB

Page 8 of 10
This page has been reviewed for content and attested to on Page 2 of this document.

NCL Calibration Laboratories

Division of APREL Laboratories.

Conversion Factor Uncertainty Assessment

Frequency:	835MHz
Epsilon: 56.16 (+/-5%)	Sigma: 0.99 S/m (+/-10%)
ConvF	
Channel X: 6.7	7%(K=2)
Channel Y: 6.7	7%(K=2)
Channel Z: 6.7	7%(K=2)

To minimize the uncertainty calculation all tissue sensitivity values were calculated using a load impedance of 5 MΩ.

Boundary Effect:

For a distance of 2.4mm the evaluated uncertainty (increase in the probe sensitivity) is less than 2%.

Page 9 of 10
This page has been reviewed for content and attested to on Page 2 of this document.

NCL Calibration Laboratories

Division of APREL Laboratories.

Test Equipment

The test equipment used during Probe Calibration, manufacturer, model number and, current calibration status are listed and located on the main APREL server R:\NCL\Calibration Equipment\Instrument List May 2008.

Page 10 of 10

This page has been reviewed for content and attested to on Page 2 of this document.

NCL CALIBRATION LABORATORIES

Calibration File No.: CP-877

Client.: BACL

CERTIFICATE OF CALIBRATION

It is certified that the equipment identified below has been calibrated in the **NCL CALIBRATION LABORATORIES** by qualified personnel following recognized procedures and using transfer standards traceable to NRC/NIST.

Equipment: Miniature Isotropic RF Probe 1900 MHz

Manufacturer: APREL Laboratories

Model No.: E-020

Serial No.: 273

Calibration Procedure: SSI/DRB-TP-D01-032-E020-V2

Project No: BACB-ALSAS10U-5323

Calibrated: 1st August 2008
Released on: 1st September 2008

This Calibration Certificate is Incomplete Unless Accompanied with the Calibration Results Summary

Released By: _____

NCL CALIBRATION LABORATORIES

51 SPECTRUM WAY
NEPEAN, ONTARIO
CANADA K2R 1E8

Division of APREL Lab.
TEL: (613) 820-4988
FAX: (613) 820-4161

NCL Calibration Laboratories

Division of APREL Laboratories.

Introduction

This Calibration Report reproduces the results of the calibration performed in line with the SSI/DRB-TP-D01-032-E020-V2 E-Field Probe Calibration Procedure. The results contained within this report are for APREL E-Field Probe E-020 273.

References

SSI/DRB-TP-D01-032-E020-V2 E-Field Probe Calibration Procedure
IEEE 1528 "Recommended Practice for Determining the Peak Spatial-Average Specific Absorption Rate (SAR) in the Human Body Due to Wireless Communications Devices: Experimental Techniques"
SSI-TP-011 Tissue Calibration Procedure

Conditions

Probe 273 was a new probe taken from stock prior to calibration.

Ambient Temperature of the Laboratory: 22 °C +/- 0.5°C

Temperature of the Tissue: 21 °C +/- 0.5°C

We the undersigned attest that to the best of our knowledge the calibration of this probe has been accurately conducted and that all information contained within this report has been reviewed for accuracy.



Stuart Nicol



Jesse Hones

Page 2 of 10

This page has been reviewed for content and attested to on Page 2 of this document.

NCL Calibration Laboratories

Division of APREL Laboratories.

Calibration Results Summary

Probe Type:	E-Field Probe E-020
Serial Number:	273
Frequency:	1900 MHz
Sensor Offset:	1.56 mm
Sensor Length:	2.5 mm
Tip Enclosure:	Ertalyte*
Tip Diameter:	<5 mm
Tip Length:	60 mm
Total Length:	290 mm

*Resistive to recommended tissue recipes per IEEE-1528

Sensitivity in Air

Channel X:	1.2 $\mu\text{V}/(\text{V}/\text{m})^2$
Channel Y:	1.2 $\mu\text{V}/(\text{V}/\text{m})^2$
Channel Z:	1.2 $\mu\text{V}/(\text{V}/\text{m})^2$
Diode Compression Point:	95 mV

Page 3 of 10

This page has been reviewed for content and attested to on Page 2 of this document.

NCL Calibration Laboratories

Division of APREL Laboratories.

Sensitivity in Head Tissue Measured

Frequency: 1900 MHz
Epsilon: 38.50 (+/-5%) **Sigma:** 1.40 S/m (+/- 5%)

ConvF

Channel X: 5.25
Channel Y: 5.25
Channel Z: 5.25

Tissue sensitivity values were calculated using the load impedance of the APREL Laboratories Daq-Paq.

Boundary Effect:

Uncertainty resulting from the boundary effect is less than 2% for the distance between the tip of the probe and the tissue boundary, when less than 2.44mm.

Spatial Resolution:

The measured probe tip diameter is 5 mm (+/- 0.01 mm) and therefore meets the requirements of SSI/DRB-TP-D01-032 for spatial resolution.

Page 4 of 10
This page has been reviewed for content and attested to on Page 2 of this document.

NCL Calibration Laboratories

Division of APREL Laboratories.

Receiving Pattern 1900 MHz (Air)



Page 5 of 10

This page has been reviewed for content and attested to on Page 2 of this document.

NCL Calibration Laboratories

Division of APREL Laboratories.

Isotropy Error 1900 MHz (Air)

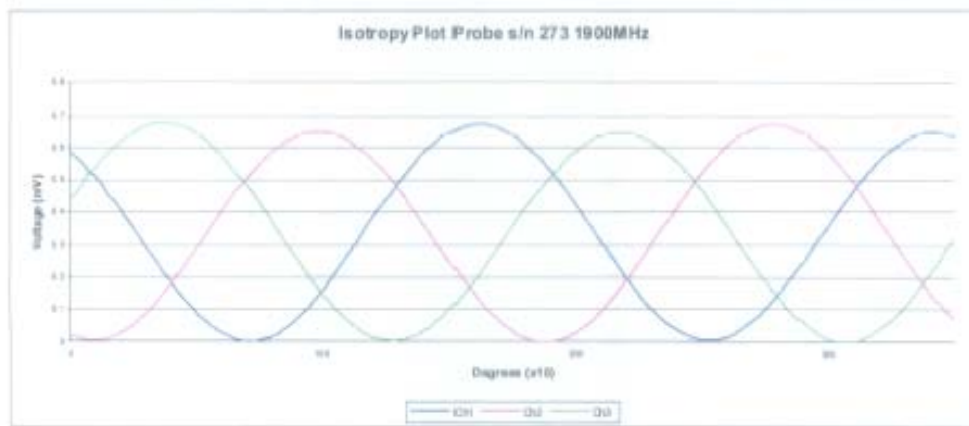
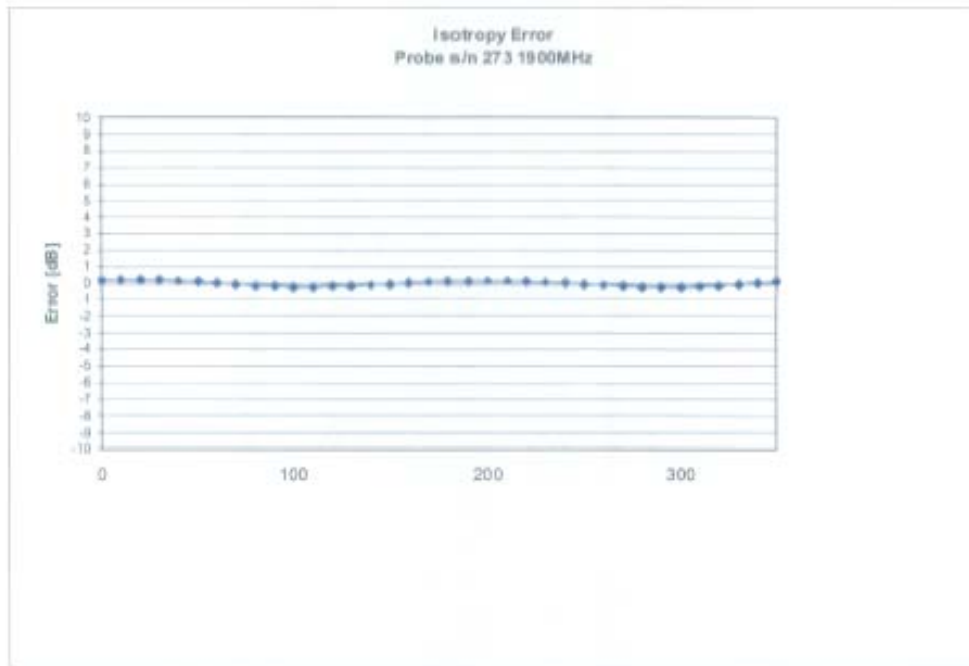

Isotropicity in Tissue:

0.10 dB

NCL Calibration Laboratories

Division of APREL Laboratories.

Dynamic Range



NCL Calibration Laboratories

Division of APREL Laboratories.

Video Bandwidth

Probe Frequency Characteristics

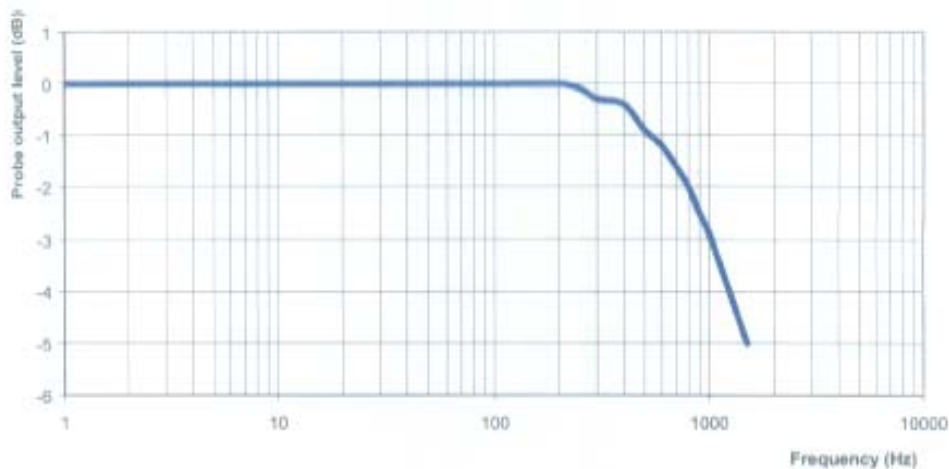

Video Bandwidth at 500 Hz 1 dB
Video Bandwidth at 1.02 KHz: 3 dB

Page 8 of 10
This page has been reviewed for content and attested to on Page 2 of this document.

NCL Calibration Laboratories

Division of APREL Laboratories.

Conversion Factor Uncertainty Assessment

Frequency:	1900MHz
Epsilon: 38.50 (+/-5%)	Sigma: 1.40 S/m (+/-5%)
ConvF	
Channel X: 5.25	7%(K=2)
Channel Y: 5.25	7%(K=2)
Channel Z: 5.25	7%(K=2)

To minimize the uncertainty calculation all tissue sensitivity values were calculated using a load impedance of 5 MΩ.

Boundary Effect:

For a distance of 2.4mm the evaluated uncertainty (increase in the probe sensitivity) is less than 2%.

NCL Calibration Laboratories

Division of APREL Laboratories.

Test Equipment

The test equipment used during Probe Calibration, manufacturer, model number and, current calibration status are listed and located on the main APREL server R:\NCL\Calibration Equipment\Instrument List May 2008.

Page 10 of 10

This page has been reviewed for content and attested to on Page 2 of this document.

NCL CALIBRATION LABORATORIES

Calibration File No.: CP-278

Client.: BACL

C E R T I F I C A T E O F C A L I B R A T I O N

It is certified that the equipment identified below has been calibrated in the **NCL CALIBRATION LABORATORIES** by qualified personnel following recognized procedures and using transfer standards traceable to NRC/NIST.

Equipment: Miniature Isotropic RF Probe 1900 MHz

Manufacturer: APREL Laboratories

Model No.: E-020

Serial No.: 273

Calibration in Body Tissue

Calibration Procedure: SSI/DRB-TP-D01-032-E020-V2

Project No: BACB-ALSAS10U-5323

Calibrated: 1st August 2008

Released on: 1st September 2008

This Calibration Certificate is incomplete unless accompanied with the Calibration Results Summary

Released By: _____



NCL CALIBRATION LABORATORIES

51 SPECTRUM WAY
NEPEAN, ONTARIO
CANADA K2R 1E8

Division of APREL Lab.
TEL: (613) 820-4988
FAX: (613) 820-4161

NCL Calibration Laboratories

Division of APREL Laboratories.

Introduction

This Calibration Report reproduces the results of the calibration performed in line with the SSI/DRB-TP-D01-032-E020-V2 E-Field Probe Calibration Procedure. The results contained within this report are for APREL E-Field Probe E-020 273.

References

SSI/DRB-TP-D01-032-E020-V2 E-Field Probe Calibration Procedure
IEEE 1528 "Recommended Practice for Determining the Peak Spatial-Average Specific Absorption Rate (SAR) in the Human Body Due to Wireless Communications Devices: Experimental Techniques"
SSI-TP-011 Tissue Calibration Procedure

Conditions

Probe 273 was a new probe taken from stock prior to calibration.

Ambient Temperature of the Laboratory: 22 °C +/- 0.5°C
Temperature of the Tissue: 21 °C +/- 0.5°C

We the undersigned attest that to the best of our knowledge the calibration of this probe has been accurately conducted and that all information contained within this report has been reviewed for accuracy.



Stuart Nicol

Jesse Hones

Page 2 of 10

This page has been reviewed for content and attested to on Page 2 of this document.

NCL Calibration Laboratories

Division of APREL Laboratories.

Calibration Results Summary

Probe Type:	E-Field Probe E-020
Serial Number:	273
Frequency:	1900 MHz
Sensor Offset:	1.56 mm
Sensor Length:	2.5 mm
Tip Enclosure:	Ertalyte*
Tip Diameter:	<5 mm
Tip Length:	60 mm
Total Length:	290 mm

*Resistive to recommended tissue recipes per IEEE-1528

Sensitivity in Air

Channel X:	1.2 $\mu\text{V}/(\text{V}/\text{m})^2$
Channel Y:	1.2 $\mu\text{V}/(\text{V}/\text{m})^2$
Channel Z:	1.2 $\mu\text{V}/(\text{V}/\text{m})^2$
Diode Compression Point:	95 mV

Page 3 of 10

This page has been reviewed for content and attested to on Page 2 of this document.

NCL Calibration LaboratoriesDivision of APREL Laboratories.

Sensitivity in Body Tissue Measured**Frequency:** 1900 MHz**Epsilon:** 53.05 (+/-5%) **Sigma:** 1.58 S/m (+/-5%)**ConvF****Channel X:** 5.15**Channel Y:** 5.15**Channel Z:** 5.15

Tissue sensitivity values were calculated using the load impedance of the APREL Laboratories Daq-Paq.

Boundary Effect:

Uncertainty resulting from the boundary effect is less than 2% for the distance between the tip of the probe and the tissue boundary, when less than 2.44mm.

Spatial Resolution:

The measured probe tip diameter is 5 mm (+/- 0.01 mm) and therefore meets the requirements of SSI/DRB-TP-D01-032 for spatial resolution.

Page 4 of 10

This page has been reviewed for content and attested to on Page 2 of this document.

NCL Calibration Laboratories

Division of APREL Laboratories.

Receiving Pattern 1900 MHz (Air)

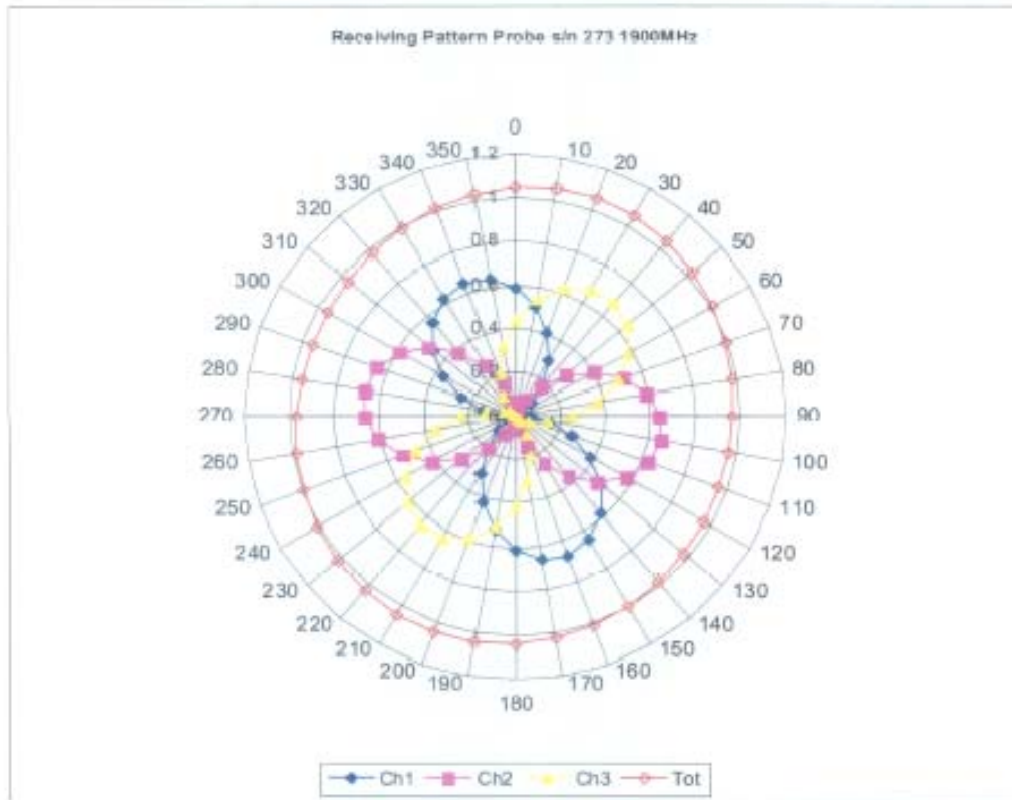

NCL Calibration Laboratories

Division of APREL Laboratories.

Isotropy Error 1900 MHz (Air)

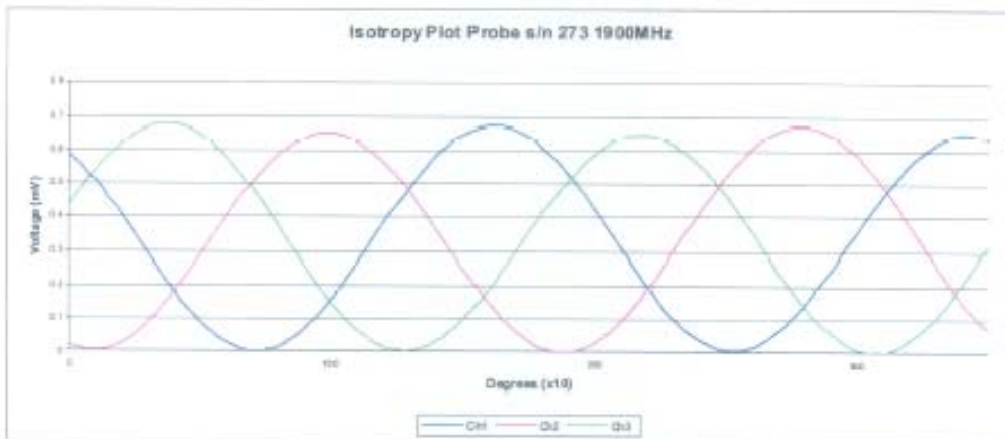
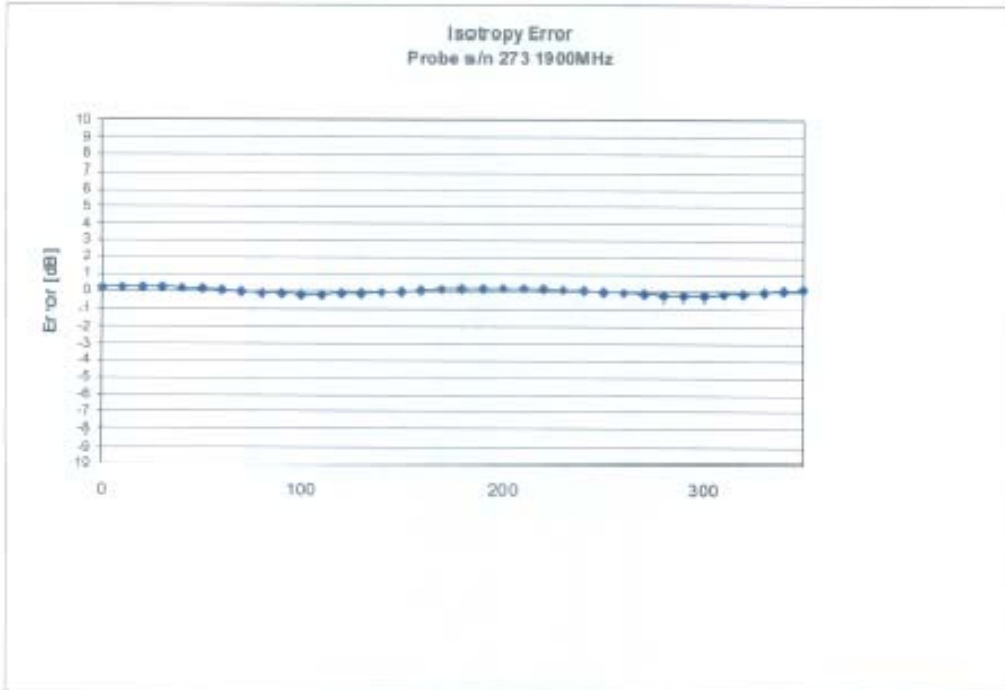

Isotropicity in Tissue:

0.10 dB

Page 6 of 10

This page has been reviewed for content and attested to on Page 2 of this document.

NCL Calibration Laboratories

Division of APREL Laboratories.

Dynamic Range

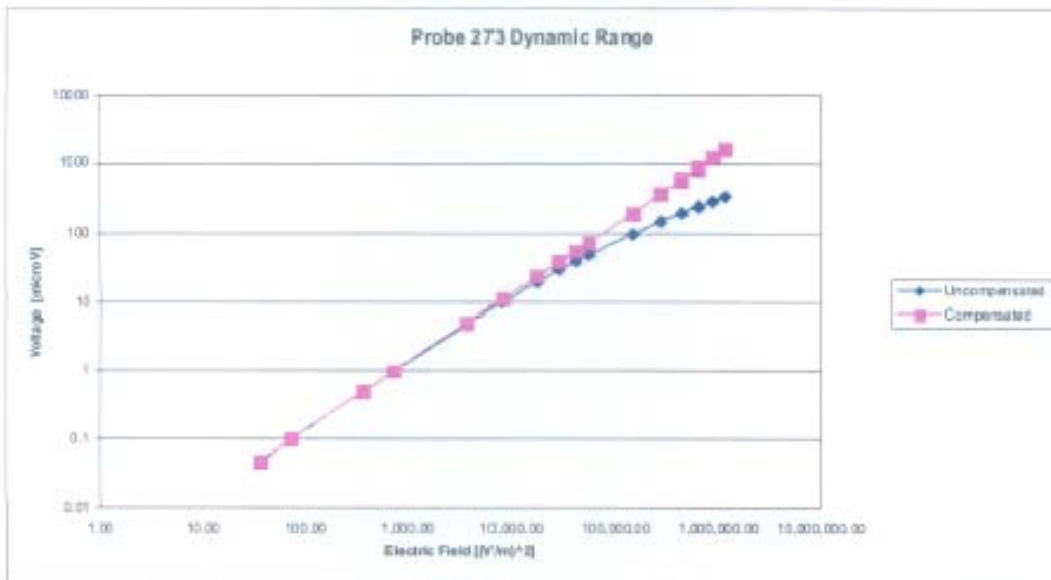

NCL Calibration Laboratories

Division of APREL Laboratories,

Video Bandwidth

Probe Frequency Characteristics

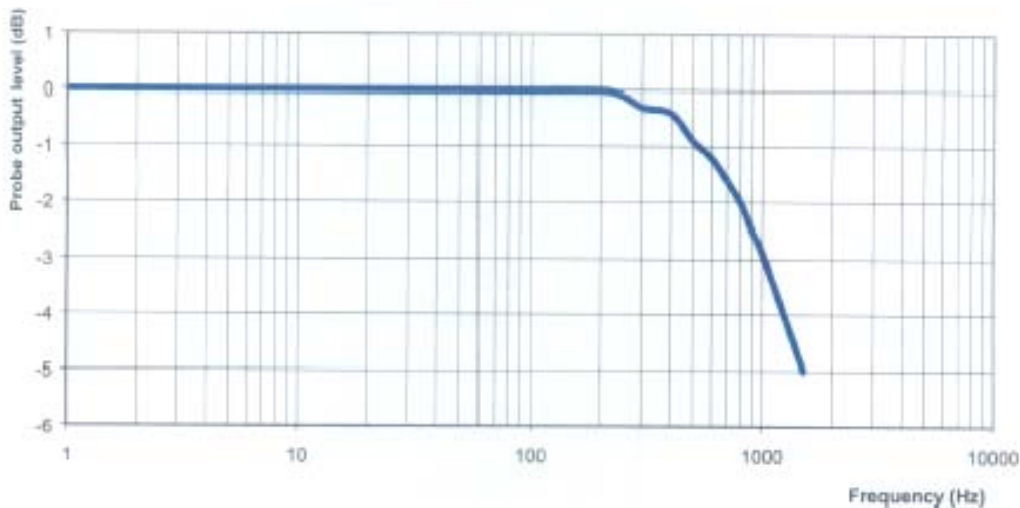

Video Bandwidth at 500 Hz 1 dB
Video Bandwidth at 1.02 KHz: 3 dB

NCL Calibration LaboratoriesDivision of APREL Laboratories.

Conversion Factor Uncertainty Assessment

Frequency:		1900MHz	
Epsilon:	53.05 (+/-5%)	Sigma:	1.58 S/m (+/-5%)
ConvF			
Channel X:	5.15		7%(K=2)
Channel Y:	5.15		7%(K=2)
Channel Z:	5.15		7%(K=2)

To minimize the uncertainty calculation all tissue sensitivity values were calculated using a load impedance of 5 M Ω .

Boundary Effect:

For a distance of 2.4mm the evaluated uncertainty (increase in the probe sensitivity) is less than 2%.

Page 9 of 10

This page has been reviewed for content and attested to on Page 2 of this document.

NCL Calibration Laboratories

Division of APREL Laboratories.

Test Equipment

The test equipment used during Probe Calibration, manufacturer, model number and, current calibration status are listed and located on the main APREL server R:\NCL\Calibration Equipment\Instrument List May 2008.

Page 10 of 10

This page has been reviewed for content and attested to on Page 2 of this document.

APPENDIX C – DIPOLE CALIBRATION CERTIFICATES

NCL CALIBRATION LABORATORIES

Calibration File No: DC-917
Project Number: BACL-ALSAS10U-5323

CERTIFICATE OF CALIBRATION

It is certified that the equipment identified below has been calibrated in the
NCL CALIBRATION LABORATORIES by qualified personnel following recognized
procedures and using transfer standards traceable to NRC/NIST.

Validation Dipole

Manufacturer: APREL Laboratories

Part number: ALS-D-835-S-2

Frequency: 835 MHz

Serial No: 180-00558

Customer: Bay Area Compliance Laboratory

Calibrated: 1st September 2008
Released on: 1st September 2008

This Calibration Certificate is Incomplete Unless Accompanied with the Calibration Results Summary

Released By: _____

NCL CALIBRATION LABORATORIES

51 SPECTRUM WAY
NEPEAN, ONTARIO
CANADA K2R 1E6

Division of APREL Lab.
TEL: (613) 820-4988
FAX: (613) 820-4162

NCL Calibration Laboratories

Division of APREL Laboratories.

Conditions

Dipole 180-00558 was new and taken from stock prior to calibration.

Ambient Temperature of the Laboratory: 22 °C +/- 0.5°C

Temperature of the Tissue: 21 °C +/- 0.5°C

We the undersigned attest that to the best of our knowledge the calibration of this device has been accurately conducted and that all information contained within this report has been reviewed for accuracy.



Stuart Nicol



C. Teodorian

This page has been reviewed for content and attested to by signature within this document.

NCL Calibration Laboratories

Division of APREL Laboratories.

Calibration Results Summary

The following results relate the Calibrated Dipole and should be used as a quick reference for the user.

Mechanical Dimensions

Length: 162.2 mm
Height: 89.4 mm

Electrical Specification

SWR: 1.018 U
Return Loss: -41.371 dB
Impedance: 51.739 Ω

System Validation Results

Frequency	1 Gram	10 Gram	Peak
835 MHz	9.49	6.1	14.21

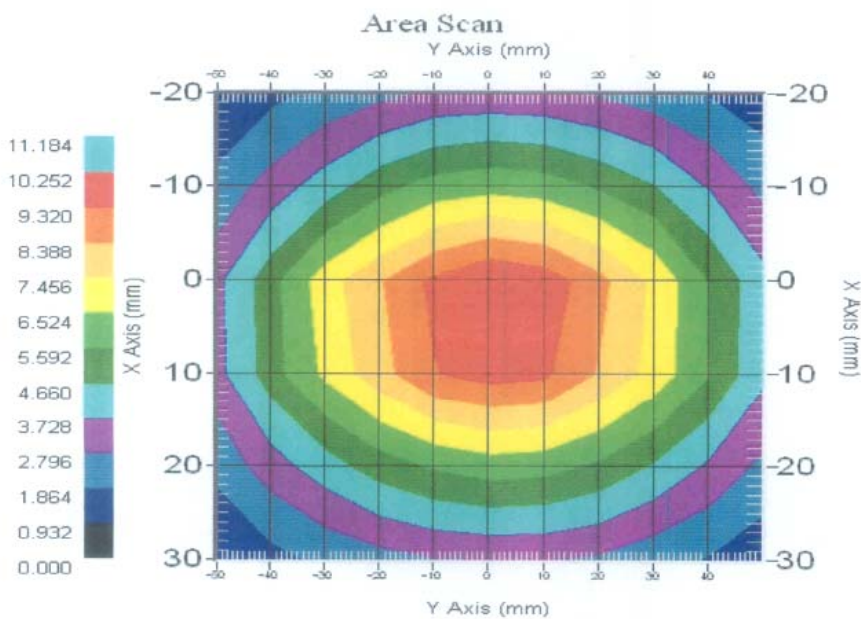

This page has been reviewed for content and attested to by signature within this document.

NCL Calibration Laboratories

Division of APREL Laboratories.

Introduction

This Calibration Report has been produced in line with the SSI Dipole Calibration Procedure SSI-TP-018-ALSAS. The results contained within this report are for Validation Dipole 180-00558. The calibration routine consisted of a three-step process. Step 1 was a mechanical verification of the dipole to ensure that it meets the mechanical specifications. Step 2 was an Electrical Calibration for the Validation Dipole, where the SWR, Impedance, and the Return loss were assessed. Step 3 involved a System Validation using the ALSAS-10U, along with APREL E-020 130 MHz to 26 GHz E-Field Probe Serial Number 212.

References

SSI-TP-018-ALSAS Dipole Calibration Procedure
SSI-TP-016 Tissue Calibration Procedure
IEEE 1528 "Recommended Practice for Determining the Peak Spatial-Average Specific Absorption Rate (SAR) in the Human Body Due to Wireless Communications Devices: Experimental Techniques"

Conditions

Dipole 180-00558 was new taken from stock.

Ambient Temperature of the Laboratory: 22 °C +/- 0.5°C
Temperature of the Tissue: 20 °C +/- 0.5°C

This page has been reviewed for content and attested to by signature within this document.

4

NCL Calibration Laboratories

Division of APREL Laboratories.

Dipole Calibration Results

Mechanical Verification

APREL Length	APREL Height	Measured Length	Measured Height
161.0 mm	89.8 mm	162.2 mm	89.4 mm

Tissue Validation

Head Tissue 835MHz	Measured
Dielectric constant, ϵ_r	41.12
Conductivity, σ [S/m]	0.92

This page has been reviewed for content and attested to by signature within this document.

NCL Calibration Laboratories

Division of APREL Laboratories.

Electrical Calibration

Test	Result
S11 RL	-41.371 dB
SWR	1.018 U
Impedance	51.739 Ω

The Following Graphs are the results as displayed on the Vector Network Analyzer.

S11 Parameter Return Loss

S11 FORWARD REFLECTION

LOG MAGNITUDE REF=-37.890 dB 10.000 dB/DIV



CH 1 - S11
REFERENCE PLANE
1.0000 cm

MARKER 2
0.835019 GHz
-41.371 dB

MARKER TO MAX
MARKER TO MIN

1 0.790484 GHz
-10.003 dB

3 0.885531 GHz
-10.088 dB

MARKER READOUT
FUNCTIONS

This page has been reviewed for content and attested to by signature within this document.

NCL Calibration Laboratories

Division of APREL Laboratories.

SWR

S11 FORWARD REFLECTION

SWR REF=500.000 mU 1.000 U/DIV

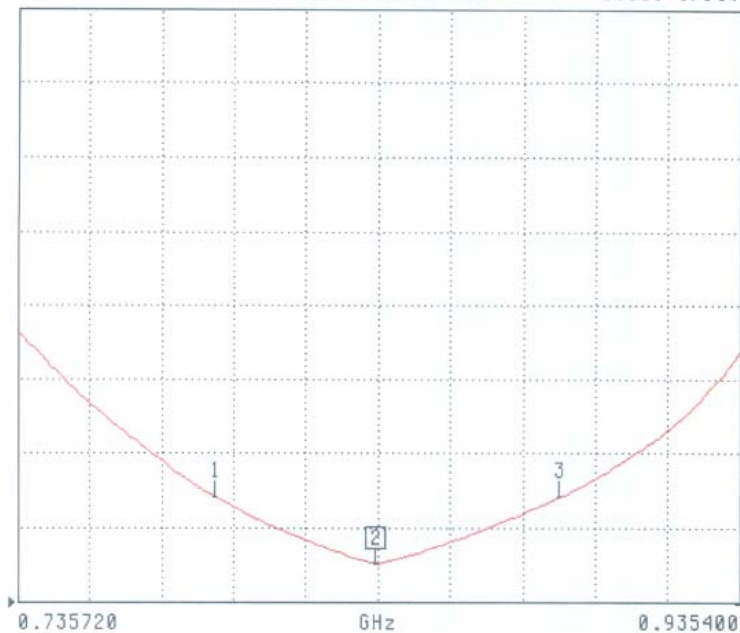

CH 1 - S11
REFERENCE PLANE
1.0000 cm

MARKER 2
0.835019 GHz
1.018 U

MARKER TO MAX
MARKER TO MIN

1 0.790484 GHz
1.925 U

3 0.885531 GHz
1.911 U

MARKER READOUT
FUNCTIONS

This page has been reviewed for content and attested to by signature within this document.

7

NCL Calibration Laboratories

Division of APREL Laboratories.

Smith Chart Dipole Impedance

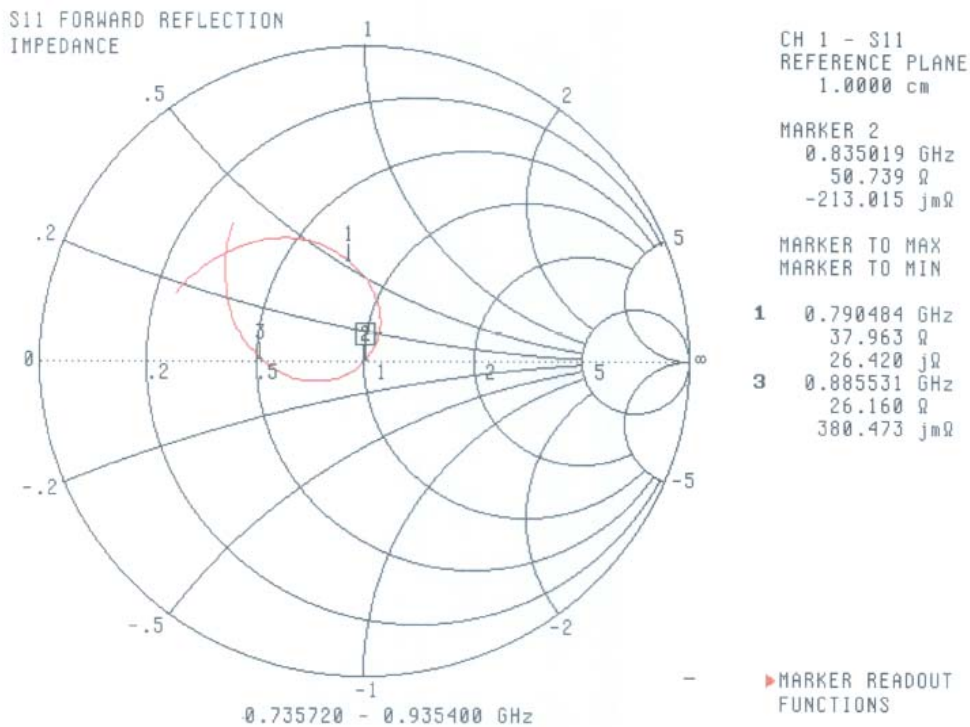

This page has been reviewed for content and attested to by signature within this document.

NCL Calibration Laboratories

Division of APREL Laboratories.

System Validation Results Using the Electrically Calibrated Dipole

Head Tissue Frequency	1 Gram	10 Gram	Peak Above Feed Point
835 MHz	9.49	6.1	14.21

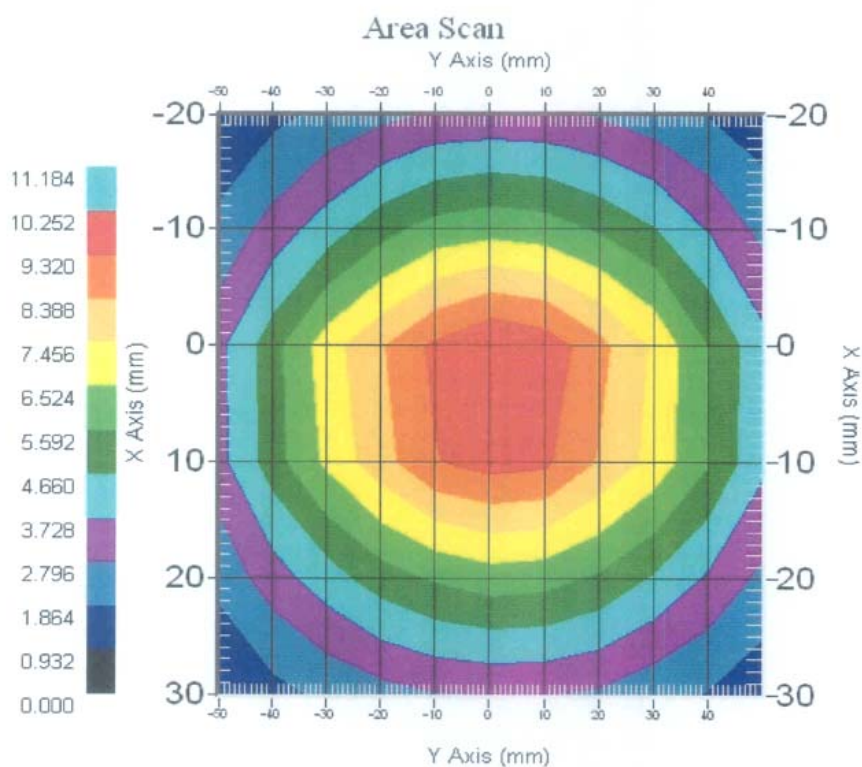

This page has been reviewed for content and attested to by signature within this document.

NCL Calibration Laboratories

Division of APREL Laboratories.

Test Equipment

The test equipment used during Probe Calibration, manufacturer, model number and, current calibration status are listed and located on the main APREL server R:\NCL\Calibration Equipment\Instrument List 2008.

This page has been reviewed for content and attested to by signature within this document.

10

NCL CALIBRATION LABORATORIES

Calibration File No: DC-920
Project Number: BACL-ALSAS10U-5323

CERTIFICATE OF CALIBRATION

It is certified that the equipment identified below has been calibrated in the
NCL CALIBRATION LABORATORIES by qualified personnel following recognized
procedures and using transfer standards traceable to NRC/NIST.

Validation Dipole

Manufacturer: APREL Laboratories
Part number: ALS-D-1900-S-2
Frequency: 1900 MHz
Serial No: 210-00710

Customer: Bay Area Compliance Laboratory

Calibrated: 1st September 2008
Released on: 1st September 2008

This Calibration Certificate is incomplete unless accompanied with the Calibration Results Summary

Released By: _____

NCL CALIBRATION LABORATORIES

51 SPECTRUM WAY
NEPEAN, ONTARIO
CANADA K2R 1E6

Division of APREL Lab.
TEL: (613) 820-4988
FAX: (613) 820-4162

NCL Calibration Laboratories

Division of APREL Laboratories.

Conditions

Dipole 210-00710 was new and taken from stock prior to calibration.

Ambient Temperature of the Laboratory: 22 °C +/- 0.5°C

Temperature of the Tissue: 21 °C +/- 0.5°C

We the undersigned attest that to the best of our knowledge the calibration of this device has been accurately conducted and that all information contained within this report has been reviewed for accuracy.



Stuart Nicol



C. Teodorian

This page has been reviewed for content and attested to by signature within this document.

NCL Calibration Laboratories

Division of APREL Laboratories.

Calibration Results Summary

The following results relate the Calibrated Dipole and should be used as a quick reference for the user.

Mechanical Dimensions

Length: 67.1 mm
Height: 38.9 mm

Electrical Specification

SWR: 1.059 U
Return Loss: -30.831 dB
Impedance: 50.914 Ω

System Validation Results

Frequency	1 Gram	10 Gram	Peak
1900 MHz	38.7	20.5	69.7

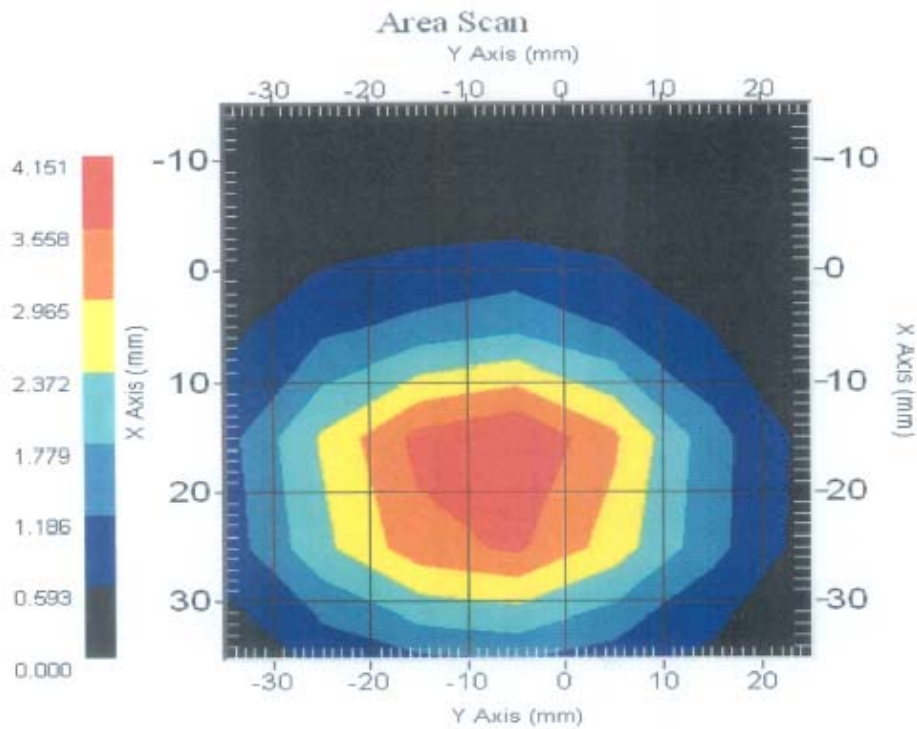

This page has been reviewed for content and attested to by signature within this document.

NCL Calibration Laboratories

Division of APREL Laboratories.

Introduction

This Calibration Report has been produced in line with the SSI Dipole Calibration Procedure SSI-TP-018-ALSAS. The results contained within this report are for Validation Dipole 210-00710. The calibration routine consisted of a three-step process. Step 1 was a mechanical verification of the dipole to ensure that it meets the mechanical specifications. Step 2 was an Electrical Calibration for the Validation Dipole, where the SWR, Impedance, and the Return loss were assessed. Step 3 involved a System Validation using the ALSAS-10U, along with APREL E-020 130 MHz to 26 GHz E-Field Probe Serial Number 212.

References

SSI-TP-018-ALSAS Dipole Calibration Procedure
SSI-TP-016 Tissue Calibration Procedure
IEEE 1528 "Recommended Practice for Determining the Peak Spatial-Average Specific Absorption Rate (SAR) in the Human Body Due to Wireless Communications Devices: Experimental Techniques"

Conditions

Dipole 210-00710 was new taken from stock.

Ambient Temperature of the Laboratory: 22 °C +/- 0.5°C
Temperature of the Tissue: 20 °C +/- 0.5°C

This page has been reviewed for content and attested to by signature within this document.

4

NCL Calibration Laboratories

Division of APREL Laboratories.

Dipole Calibration Results

Mechanical Verification

APREL Length	APREL Height	Measured Length	Measured Height
68.0 mm	39.5 mm	67.1mm	38.9 mm

Tissue Validation

Head Tissue 1900 MHz	Measured
Dielectric constant, ϵ_r	40.03
Conductivity, σ [S/m]	1.38

This page has been reviewed for content and attested to by signature within this document.

NCL Calibration Laboratories

Division of APREL Laboratories.

Electrical Calibration

Test	Result
S11 R/L	-30.831 dB
SWR	1.059 U
Impedance	50.914 Ω

The Following Graphs are the results as displayed on the Vector Network Analyzer.

S11 Parameter Return Loss



This page has been reviewed for content and attested to by signature within this document.

NCL Calibration Laboratories

Division of APREL Laboratories.

SWR

S11 FORWARD REFLECTION

SWR REF=449.865 mU 900.000 mU/DIV



CH 1 - S11
REFERENCE PLANE
5.1000 mm

MARKER 2
1.900000 GHz
1.059 U

MARKER TO MAX
MARKER TO MIN

1 1.860000 GHz
1.241 U

3 1.957500 GHz
1.229 U

▶ MARKER READOUT
FUNCTIONS

This page has been reviewed for content and attested to by signature within this document.

NCL Calibration Laboratories

Division of APREL Laboratories.

Smith Chart Dipole Impedance

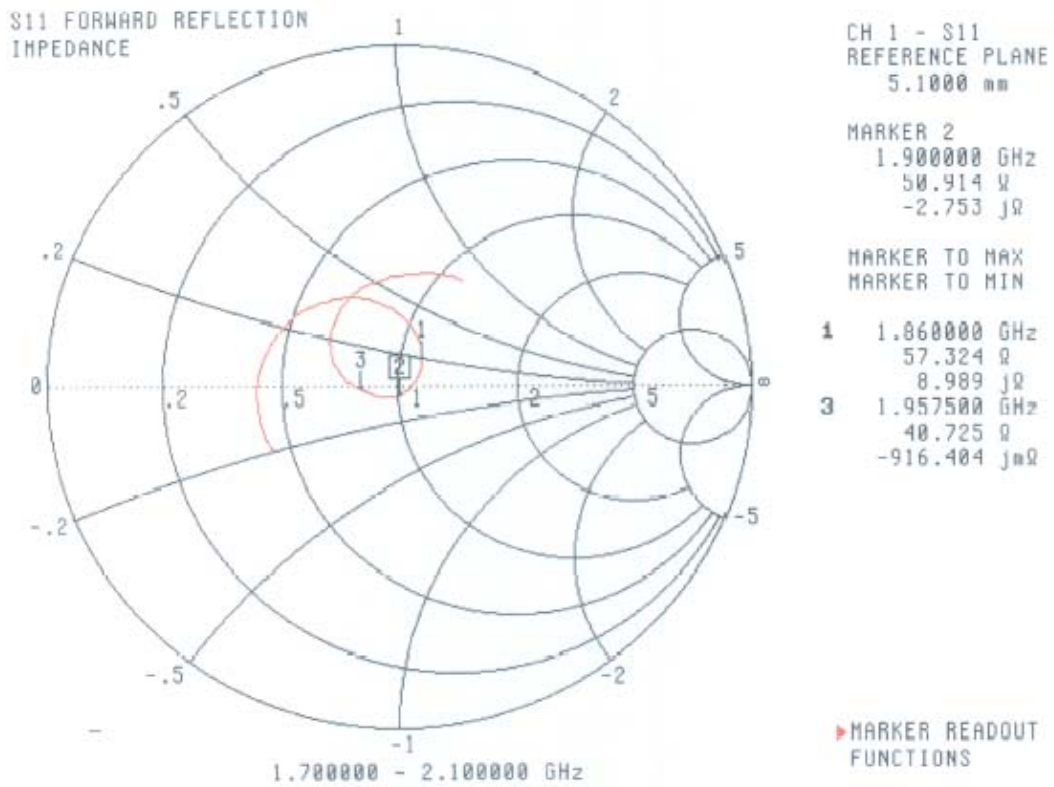

This page has been reviewed for content and attested to by signature within this document. 8

NCL Calibration Laboratories

Division of APREL Laboratories.

System Validation Results Using the Electrically Calibrated Dipole

Head Tissue Frequency	1 Gram	10 Gram	Peak Above Feed Point
1900 MHz	38.7	20.5	69.7

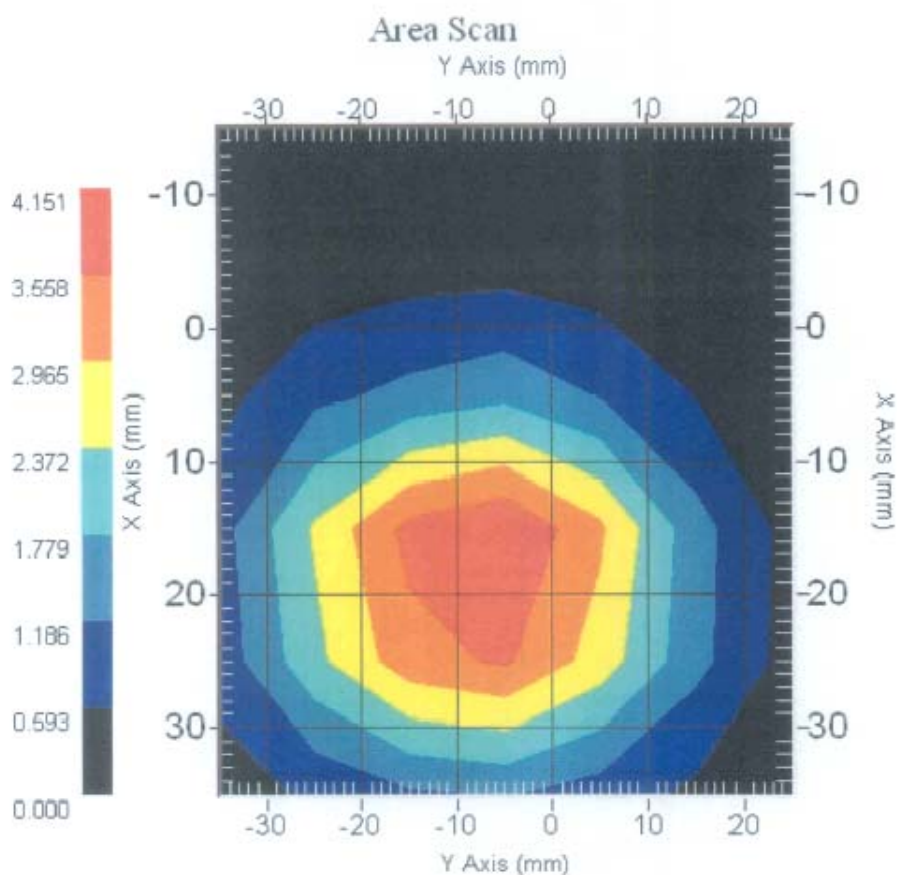

This page has been reviewed for content and attested to by signature within this document.

NCL Calibration Laboratories

Division of APREL Laboratories.

Test Equipment

The test equipment used during Probe Calibration, manufacturer, model number and, current calibration status are listed and located on the main APREL server R:\NCL\Calibration Equipment\Instrument List 2007.

This page has been reviewed for content and attested to by signature within this document.

APPENDIX D – SAR SYSTEM VALIDATION DATA

Test Laboratory: Bay Area Compliance Lab Corp. (Shenzhen)**System Performance Check 835 MHz Head Tissue****Dipole 835 MHz; Type: ALS-D-835-S-2; S/N: 180-00558**

Product Data

Device Name : Dipole 835 MHz
Serial No. : 180-00558
Type : Dipole
Model : ALS-D-835-S-2
Frequency : 835.00 MHz
Max. Transmit Pwr : 1 W
Drift Time : 3 min(s)
Power Drift-Start : 10.066 W/kg
Power Drift-Finish : 9.926 W/kg
Power Drift (%) : -1.391

Phantom Data

Name : APREL-Uni
Type : Uni-Phantom
Size (mm) : 280 x 280 x 200
Serial No. : System Default
Location : Center
Description : Default
Phantom Data

Tissue Data

Type : HEAD
Serial No. : 270-01002
Frequency : 835.00 MHz
Last Calib. Date : 22-July-2009
Temperature : 20.00 °C
Ambient Temp. : 20.00 °C
Humidity : 50.00 RH%
Epsilon : 41.13 F/m
Sigma : 0.90 S/m
Density : 1000.00 kg/cu. m

Probe Data

Name : E-Field
Model : E-020
Type : E-Field Triangle
Serial No. : 273
Last Calib. Date : 01-Aug-2008
Frequency : 835.00 MHz
Duty Cycle Factor : 1
Conversion Factor : 6.5
Probe Sensitivity : 1.20 1.20 1.20 $\mu\text{V}/(\text{V}/\text{m})^2$
Compression Point : 95.00 mV
Offset : 1.56 mm

Measurement Data

Crest Factor : 1
Scan Type : Complete
Tissue Temp. : 21.00 °C
Ambient Temp. : 21.00 °C
Area Scan : 7x9x1 : Measurement x=10mm, y=10mm, z=4mm
Zoom Scan : 7x7x7 : Measurement x=5mm, y=5mm, z=5mm

1 gram SAR value : 9.651 W/kg
10 gram SAR value : 6.042 W/kg
Area Scan Peak SAR : 10.936 W/kg
Zoom Scan Peak SAR : 15.013 W/kg

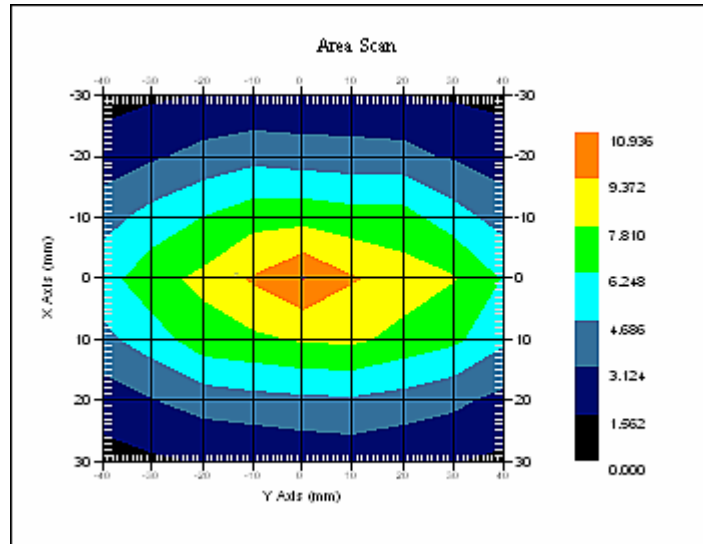

835 MHz System Validation

Test Laboratory: Bay Area Compliance Lab Corp. (Shenzhen)**System Performance Check 1900 MHz Head Tissue****Dipole 1900 MHz; Type: ALS-D-1900-S-2; S/N: 210-00710**

Product Data

Device Name : Dipole 1900MHz
Serial No. : 210-00710
Type : Dipole
Model : ALS-D-1900-S-2
Frequency : 1900.00 MHz
Max. Transmit Pwr : 1 W
Drift Time : 3 min(s)
Power Drift-Start : 43.370 W/kg
Power Drift-Finish : 41.609 W/kg
Power Drift (%) : -4.059

Phantom Data

Name : APREL-Uni
Type : Uni-Phantom
Size (mm) : 280 x 280 x 200
Serial No. : System Default
Location : Center
Description : Default

Tissue Data

Type : HEAD
Serial No. : 295-01103
Frequency : 1900.00 MHz
Last Calib. Date : 22-July-2009
Temperature : 20.00 °C
Ambient Temp. : 20.00 °C
Humidity : 56.00 RH%
Epsilon : 39.54 F/m
Sigma : 1.45 S/m
Density : 1000.00 kg/cu. m

Probe Data

Name : E-Field
Model : E-020
Type : E-Field Triangle
Serial No. : 273
Last Calib. Date : 01-Aug-2008
Frequency : 1900.00 MHz
Duty Cycle Factor : 1
Conversion Factor : 5.25
Probe Sensitivity : 1.20 1.20 1.20 $\mu\text{V}/(\text{V}/\text{m})^2$
Compression Point : 95.00 mV
Offset : 1.56 mm

Measurement Data

Crest Factor : 1
Scan Type : Complete
Tissue Temp. : 20.00 °C
Ambient Temp. : 20.00 °C
Area Scan : 7x9x1 : Measurement x=10mm, y=10mm, z=4mm
Zoom Scan : 7x7x7 : Measurement x=5mm, y=5mm, z=5mm

1 gram SAR value : 40.328 W/kg
10 gram SAR value : 20.137 W/kg
Area Scan Peak SAR : 44.786 W/kg
Zoom Scan Peak SAR : 75.567 W/kg

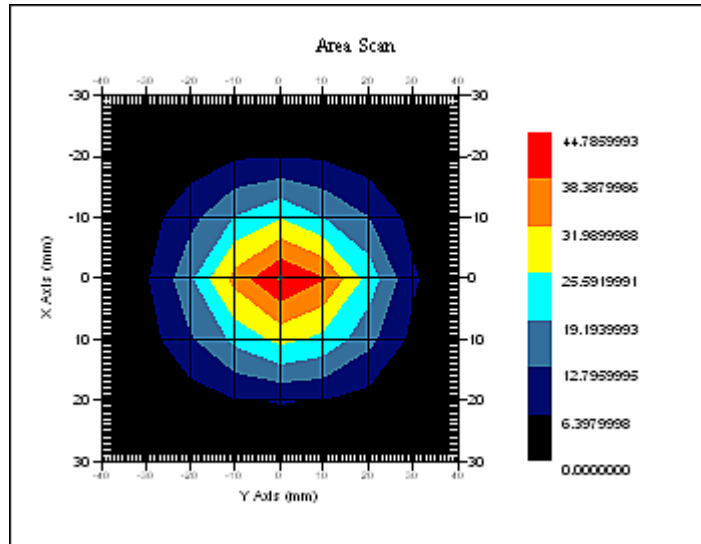

1900 MHz System Validation

APPENDIX E – EUT SCAN RESULTS

Test Laboratory: Bay Area Compliance Lab Corp. (Shenzhen)

Left Head Cheek (835 MHz Low Channel)

Measurement Data

Test mode : GSM
 Crest Factor : 8
 Scan Type : Complete
 Area Scan : 11x6x1: Measurement x=10mm, y=10mm, z=4mm
 Zoom Scan : 7x7x7: Measurement x=5mm, y=5mm, z=5mm
 Power Drift-Start : 0.075 W/kg
 Power Drift-Finish : 0.075 W/kg
 Power Drift (%) : -0.882

Tissue Data

Type : HEAD
 Frequency : 835.00 MHz
 Epsilon : 41.13 F/m
 Sigma : 0.90 S/m
 Density : 1000.00 kg/cu. m

Probe Data

Serial No. : 273
 Frequency : 835.00 MHz
 Duty Cycle Factor : 8
 Conversion Factor : 6.5
 Probe Sensitivity : 1.20 1.20 1.20 $\mu\text{V}/(\text{V/m})^2$
 Compression Point : 95.00 mV
 Offset : 1.56 mm

1 gram SAR value : 1.030 W/kg
 10 gram SAR value : 0.643 W/kg
 Area Scan Peak SAR : 1.147 W/kg
 Zoom Scan Peak SAR : 1.511 W/kg

Plot 1#

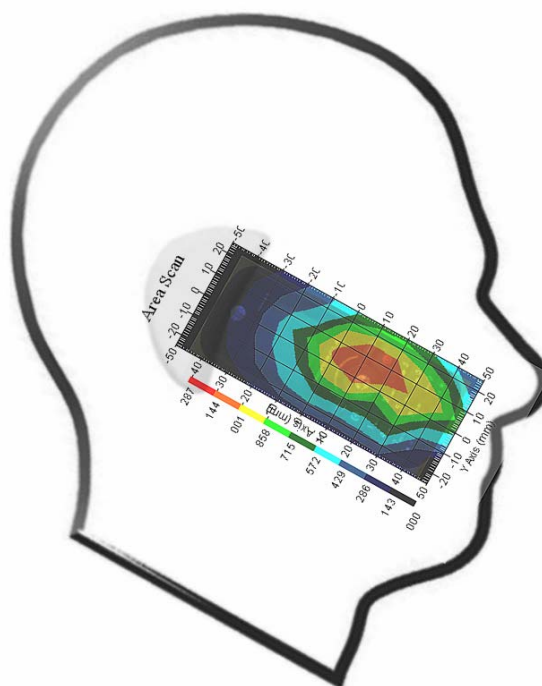

Test Laboratory: Bay Area Compliance Lab Corp. (Shenzhen)**Left Head Cheek (835 MHz Middle Channel)**

Measurement Data

Test mode : GSM
 Crest Factor : 8
 Scan Type : Complete
 Area Scan : 11x6x1: Measurement x=10mm, y=10mm, z=4mm
 Zoom Scan : 7x7x7: Measurement x=5mm, y=5mm, z=5mm
 Power Drift-Start : 0.074 W/kg
 Power Drift-Finish : 0.075 W/kg
 Power Drift (%) : 1.422

Tissue Data

Type : HEAD
 Frequency : 835.00 MHz
 Epsilon : 41.13 F/m
 Sigma : 0.90 S/m
 Density : 1000.00 kg/cu. m

Probe Data

Serial No. : 273
 Frequency : 835.00 MHz
 Duty Cycle Factor : 8
 Conversion Factor : 6.5
 Probe Sensitivity : 1.20 1.20 1.20 $\mu\text{V}/(\text{V}/\text{m})^2$
 Compression Point : 95.00 mV
 Offset : 1.56 mm

1 gram SAR value : 0.894 W/kg
 10 gram SAR value : 0.584 W/kg
 Area Scan Peak SAR : 0.988 W/kg
 Zoom Scan Peak SAR : 1.681 W/kg

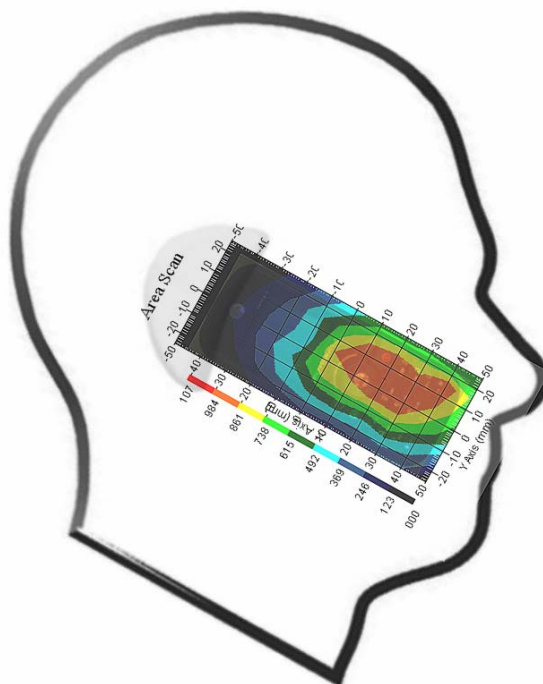
Plot 2#

Test Laboratory: Bay Area Compliance Lab Corp. (Shenzhen)**Left Head Cheek (835 MHz High Channel)**

Measurement Data

Test mode : GSM
Crest Factor : 8
Scan Type : Complete
Area Scan : 11x6x1: Measurement x=10mm, y=10mm, z=4mm
Zoom Scan : 7x7x7: Measurement x=5mm, y=5mm, z=5mm
Power Drift-Start : 0.072 W/kg
Power Drift-Finish : 0.073 W/kg
Power Drift (%) : 1.488

Tissue Data

Type : HEAD
Frequency : 835.00 MHz
Epsilon : 41.13 F/m
Sigma : 0.90 S/m
Density : 1000.00 kg/cu. m

Probe Data

Serial No. : 273
Frequency : 835.00 MHz
Duty Cycle Factor : 8
Conversion Factor : 6.5
Probe Sensitivity : 1.20 1.20 1.20 $\mu\text{V}/(\text{V}/\text{m})^2$
Compression Point : 95.00 mV
Offset : 1.56 mm

1 gram SAR value : 0.904 W/kg
10 gram SAR value : 0.564 W/kg
Area Scan Peak SAR : 0.958 W/kg
Zoom Scan Peak SAR : 1.221 W/kg

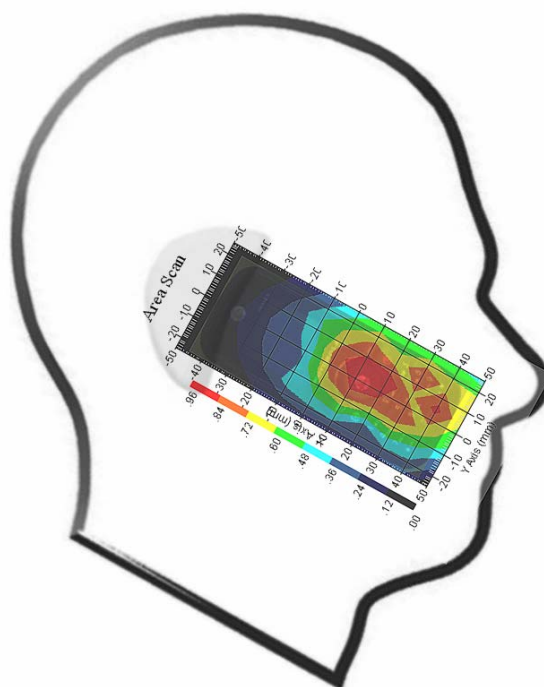
Plot 3#

Test Laboratory: Bay Area Compliance Lab Corp. (Shenzhen)**Left Head Tilt (835 MHz Low Channel)**

Measurement Data

Test mode : GSM
 Crest Factor : 8
 Scan Type : Complete
 Area Scan : 11x6x1 : Measurement x=10mm, y=10mm, z=4mm
 Zoom Scan : 7x7x7 : Measurement x=5mm, y=5mm, z=5mm
 Power Drift-Start : 0.120 W/kg
 Power Drift-Finish : 0.119 W/kg
 Power Drift (%) : -0.015

Tissue Data

Type : HEAD
 Frequency : 835.00 MHz
 Epsilon : 41.13 F/m
 Sigma : 0.90 S/m
 Density : 1000.00 kg/cu. m

Probe Data

Serial No. : 273
 Frequency : 835.00 MHz
 Duty Cycle Factor : 8
 Conversion Factor : 6.5
 Probe Sensitivity : 1.20 1.20 1.20 $\mu\text{V}/(\text{V}/\text{m})^2$
 Compression Point : 95.00 mV
 Offset : 1.56 mm

1 gram SAR value : 0.635 W/kg
 10 gram SAR value : 0.418 W/kg
 Area Scan Peak SAR : 0.665 W/kg
 Zoom Scan Peak SAR : 0.930 W/kg

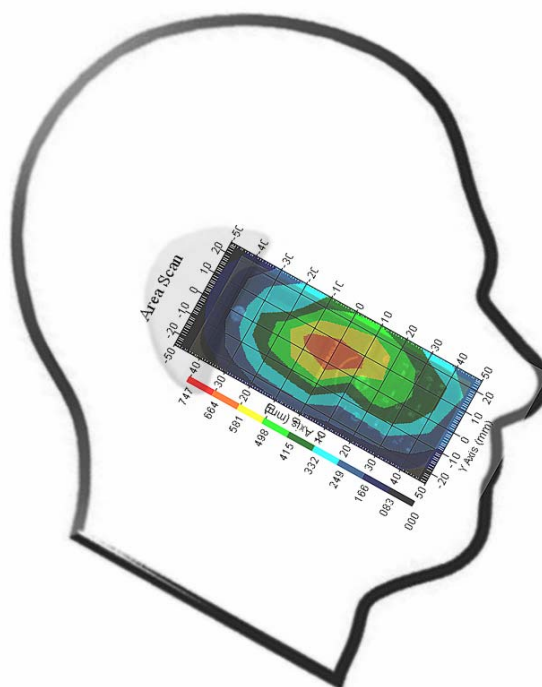
Plot 4#

Test Laboratory: Bay Area Compliance Lab Corp. (Shenzhen)**Right Head Cheek (835 MHz Low Channel)**

Measurement Data

Test mode : GSM
Crest Factor : 8
Scan Type : Complete
Area Scan : 11x6x1 : Measurement x=10mm, y=10mm, z=4mm
Zoom Scan : 7x7x7 : Measurement x=5mm, y=5mm, z=5mm
Power Drift-Start : 0.078 W/kg
Power Drift-Finish : 0.076 W/kg
Power Drift (%) : -2.469

Tissue Data

Type : HEAD
Frequency : 835.00 MHz
Epsilon : 41.13 F/m
Sigma : 0.90 S/m
Density : 1000.00 kg/cu. m

Probe Data

Serial No. : 273
Frequency : 835.00 MHz
Duty Cycle Factor : 8
Conversion Factor : 6.5
Probe Sensitivity : 1.20 1.20 1.20 $\mu\text{V}/(\text{V}/\text{m})^2$
Compression Point : 95.00 mV
Offset : 1.56 mm

1 gram SAR value : 1.046 W/kg
10 gram SAR value : 0.694 W/kg
Area Scan Peak SAR : 1.138 W/kg
Zoom Scan Peak SAR : 1.751 W/kg

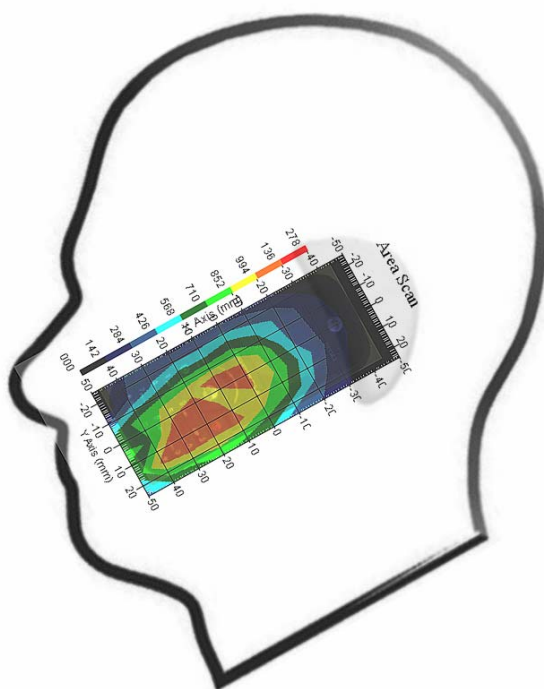
Plot 5#

Test Laboratory: Bay Area Compliance Lab Corp. (Shenzhen)**Right Head Cheek (835 MHz Middle Channel)**

Measurement Data

Test mode : GSM
Crest Factor : 8
Scan Type : Complete
Area Scan : 11x6x1 : Measurement x=10mm, y=10mm, z=4mm
Zoom Scan : 7x7x7 : Measurement x=5mm, y=5mm, z=5mm
Power Drift-Start : 0.075 W/kg
Power Drift-Finish : 0.072 W/kg
Power Drift (%) : -4.673

Tissue Data

Type : HEAD
Frequency : 835.00 MHz
Epsilon : 41.13 F/m
Sigma : 0.90 S/m
Density : 1000.00 kg/cu. m

Probe Data

Serial No. : 273
Frequency : 835.00 MHz
Duty Cycle Factor : 8
Conversion Factor : 6.5
Probe Sensitivity : 1.20 1.20 1.20 $\mu\text{V}/(\text{V}/\text{m})^2$
Compression Point : 95.00 mV
Offset : 1.56 mm

1 gram SAR value : 0.989 W/kg
10 gram SAR value : 0.522 W/kg
Area Scan Peak SAR : 1.234 W/kg
Zoom Scan Peak SAR : 1.451 W/kg

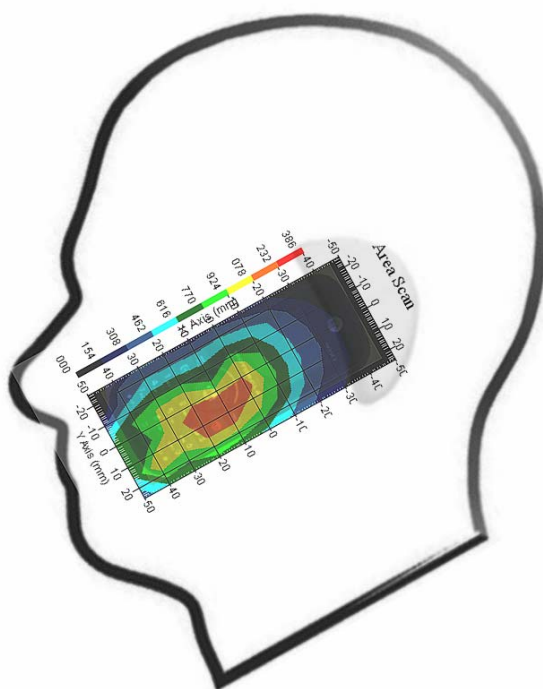
Plot 6#

Test Laboratory: Bay Area Compliance Lab Corp. (Shenzhen)**Right Head Cheek (835 MHz High Channel)**

Measurement Data

Test mode : GSM
Crest Factor : 8
Scan Type : Complete
Area Scan : 11x6x1 : Measurement x=10mm, y=10mm, z=4mm
Zoom Scan : 7x7x7 : Measurement x=5mm, y=5mm, z=5mm
Power Drift-Start : 0.079 W/kg
Power Drift-Finish : 0.075 W/kg
Power Drift (%) : 4.834

Tissue Data

Type : HEAD
Frequency : 835.00 MHz
Epsilon : 41.13 F/m
Sigma : 0.90 S/m
Density : 1000.00 kg/cu. m

Probe Data

Serial No. : 273
Frequency : 835.00 MHz
Duty Cycle Factor : 8
Conversion Factor : 6.5
Probe Sensitivity : 1.20 1.20 1.20 $\mu\text{V}/(\text{V}/\text{m})^2$
Compression Point : 95.00 mV
Offset : 1.56 mm

1 gram SAR value : 0.994 W/kg
10 gram SAR value : 0.844 W/kg
Area Scan Peak SAR : 1.098 W/kg
Zoom Scan Peak SAR : 1.161 W/kg

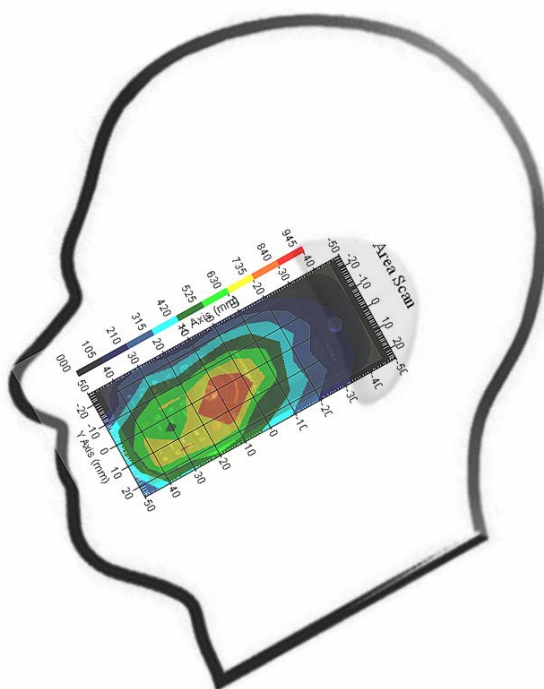
Plot 7#

Test Laboratory: Bay Area Compliance Lab Corp. (Shenzhen)**Right Head Tilt (835 MHz Low Channel)**

Measurement Data

Test mode : GSM
Crest Factor : 8
Scan Type : Complete
Area Scan : 11x6x1 : Measurement x=10mm, y=10mm, z=4mm
Zoom Scan : 7x7x7 : Measurement x=5mm, y=5mm, z=5mm
Power Drift-Start : 0.164 W/kg
Power Drift-Finish : 0.159 W/kg
Power Drift (%) : -3.242

Tissue Data

Type : HEAD
Frequency : 835.00 MHz
Epsilon : 41.13 F/m
Sigma : 0.90 S/m
Density : 1000.00 kg/cu. m

Probe Data

Serial No. : 273
Frequency : 835.00 MHz
Duty Cycle Factor : 8
Conversion Factor : 6.5
Probe Sensitivity : 1.20 1.20 1.20 $\mu\text{V}/(\text{V}/\text{m})^2$
Compression Point : 95.00 mV
Offset : 1.56 mm

1 gram SAR value : 0.517 W/kg
10 gram SAR value : 0.360 W/kg
Area Scan Peak SAR : 0.617 W/kg
Zoom Scan Peak SAR : 0.860 W/kg

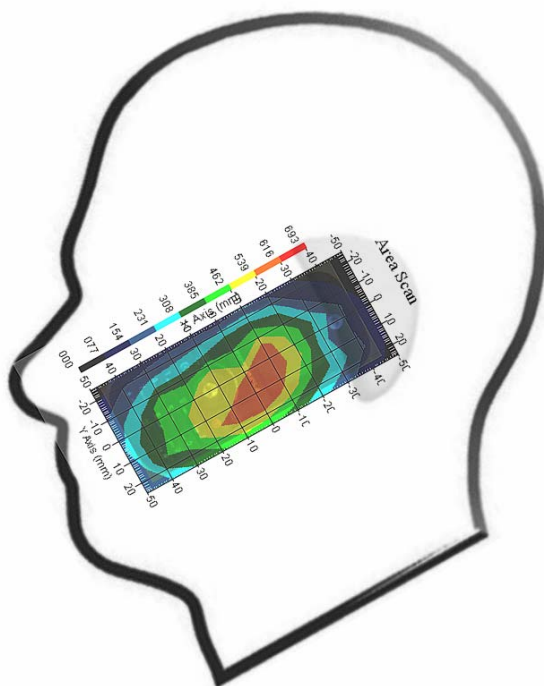
Plot 8#

Test Laboratory: Bay Area Compliance Lab Corp. (Shenzhen)**Body- worn Back (835 MHz Low Channel)**

Measurement Data

Test mode : GSM
Crest Factor : 8
Scan Type : Complete
Area Scan : 6x12x1 : Measurement x=10mm, y=10mm, z=4mm
Zoom Scan : 7x7x7 : Measurement x=5mm, y=5mm, z=5mm
Power Drift-Start : 0.093 W/kg
Power Drift-Finish : 0.089 W/kg
Power Drift (%) : -4.763

Tissue Data

Type : BODY
Frequency : 835.00 MHz
Epsilon : 55.57 F/m
Sigma : 1.00 S/m
Density : 1000.00 kg/cu. m

Probe Data

Serial No. : 273
Frequency : 835.00 MHz
Duty Cycle Factor : 8
Conversion Factor : 6.7
Probe Sensitivity : 1.20 1.20 1.20 $\mu\text{V}/(\text{V}/\text{m})^2$
Compression Point : 95.00 mV
Offset : 1.56 mm

1 gram SAR value : 0.456 W/kg
10 gram SAR value : 0.292 W/kg
Area Scan Peak SAR : 0.469 W/kg
Zoom Scan Peak SAR : 0.850 W/kg

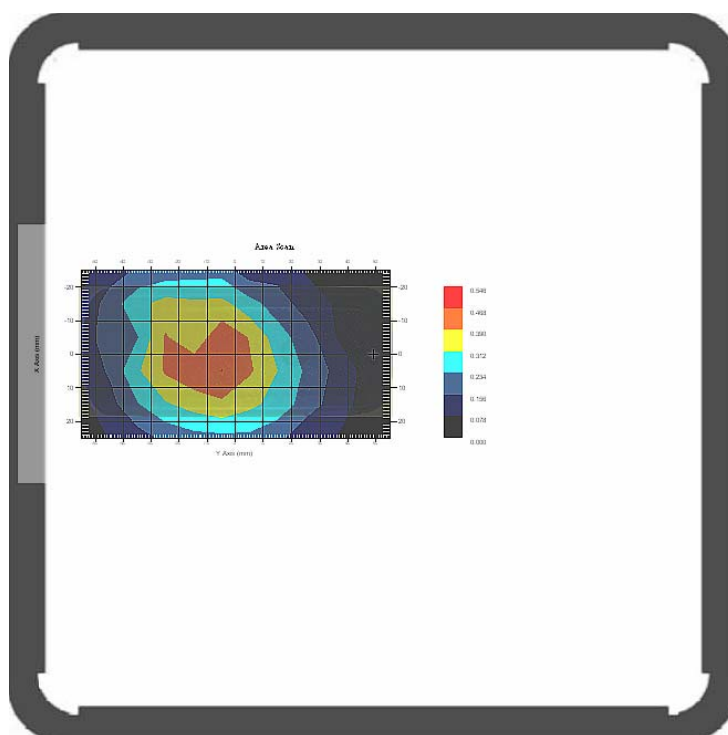
Plot 9#

Test Laboratory: Bay Area Compliance Lab Corp. (Shenzhen)**Left Head Cheek (1900 MHz High Channel)**

Measurement Data

Test mode : GSM
Crest Factor : 8
Scan Type: : Complete
Area Scan : 11x6x1 : Measurement x=10mm, y=10mm, z=4mm
Zoom Scan : 7x7x7 : Measurement x=5mm, y=5mm, z=5mm
Power Drift-Start : 0.014 W/kg
Power Drift-Finish : 0.013 W/kg
Power Drift (%) : -2.552

Tissue Data

Type : HEAD
Frequency : 1900.00 MHz
Epsilon : 39.54 F/m
Sigma : 1.45 S/m
Density : 1000.00 kg/cu. m

Probe Data

Serial No. : 273
Frequency : 1900.00 MHz
Duty Cycle Factor : 8
Conversion Factor : 5.25
Probe Sensitivity : 1.20 1.20 1.20 $\mu\text{V}/(\text{V/m})^2$
Compression Point : 95.00 mV
Offset : 1.56 mm

1 gram SAR value : 0.983 W/kg
10 gram SAR value : 0.645 W/kg
Area Scan Peak SAR : 1.022 W/kg
Zoom Scan Peak SAR : 1.131 W/kg

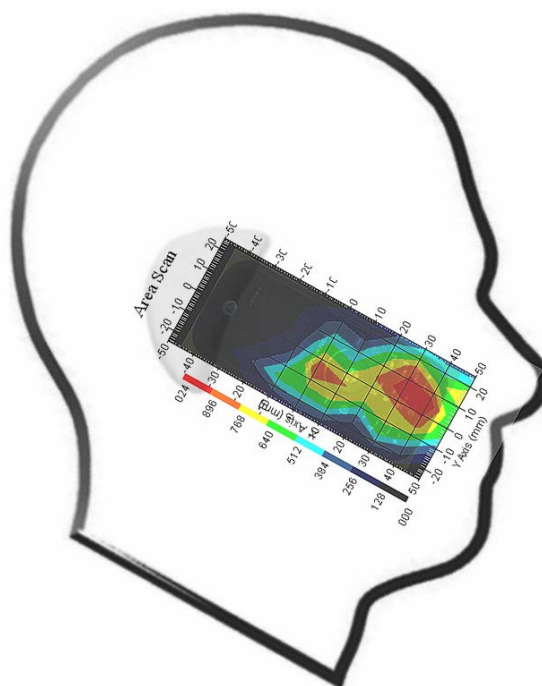
Plot 10#

Test Laboratory: Bay Area Compliance Lab Corp. (Shenzhen)**Left Head Cheek (1900 MHz Low Channel)**

Measurement Data

Test mode : GSM
Crest Factor : 8
Scan Type: : Complete
Area Scan : 11x6x1 : Measurement x=10mm, y=10mm, z=4mm
Zoom Scan : 7x7x7 : Measurement x=5mm, y=5mm, z=5mm
Power Drift-Start : 0.014 W/kg
Power Drift-Finish : 0.013 W/kg
Power Drift (%) : -2.552

Tissue Data

Type : HEAD
Frequency : 1900.00 MHz
Epsilon : 39.54 F/m
Sigma : 1.45 S/m
Density : 1000.00 kg/cu. m

Probe Data

Serial No. : 273
Frequency : 1900.00 MHz
Duty Cycle Factor : 8
Conversion Factor : 5.25
Probe Sensitivity : 1.20 1.20 1.20 $\mu\text{V}/(\text{V}/\text{m})^2$
Compression Point : 95.00 mV
Offset : 1.56 mm

1 gram SAR value : 0.935 W/kg
10 gram SAR value : 0.779 W/kg
Area Scan Peak SAR : 1.029 W/kg
Zoom Scan Peak SAR : 1.191 W/kg

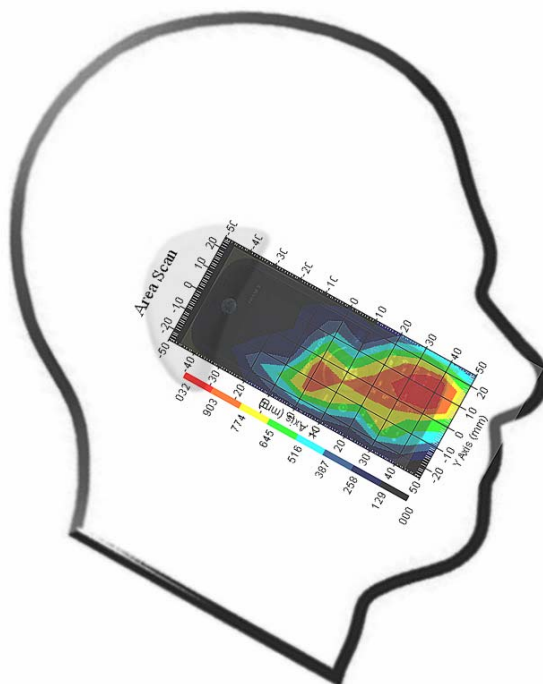
Plot 11#

Test Laboratory: Bay Area Compliance Lab Corp. (Shenzhen)**Left Head Cheek (1900 MHz Middle Channel)**

Measurement Data

Test mode : GSM
 Crest Factor : 8
 Scan Type: : Complete
 Area Scan : 11x6x1 : Measurement x=10mm, y=10mm, z=4mm
 Zoom Scan : 7x7x7 : Measurement x=5mm, y=5mm, z=5mm
 Power Drift-Start : 0.013 W/kg
 Power Drift-Finish : 0.013 W/kg
 Power Drift (%) : -1.259

Tissue Data

Type : HEAD
 Frequency : 1900.00 MHz
 Epsilon : 39.54 F/m
 Sigma : 1.45 S/m
 Density : 1000.00 kg/cu. m

Probe Data

Serial No. : 273
 Frequency : 1900.00 MHz
 Duty Cycle Factor : 8
 Conversion Factor : 5.25
 Probe Sensitivity : 1.20 1.20 1.20 $\mu\text{V}/(\text{V}/\text{m})^2$
 Compression Point : 95.00 mV
 Offset : 1.56 mm

1 gram SAR value : 0.924 W/kg
 10 gram SAR value : 0.686 W/kg
 Area Scan Peak SAR : 1.076 W/kg
 Zoom Scan Peak SAR : 2.171 W/kg

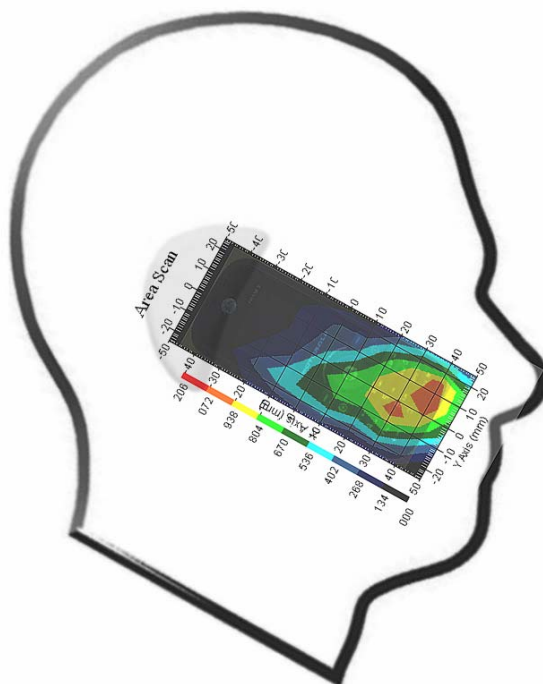
Plot 12#

Test Laboratory: Bay Area Compliance Lab Corp. (Shenzhen)**Left Head Tilt (1900 MHz High Channel)**

Measurement Data

Test mode : GSM
Crest Factor : 8
Scan Type: : Complete
Area Scan : 11x6x1 : Measurement x=10mm, y=10mm, z=4mm
Zoom Scan : 7x7x7 : Measurement x=5mm, y=5mm, z=5mm
Power Drift-Start : 0.200 W/kg
Power Drift-Finish : 0.190 W/kg
Power Drift (%) : -4.868

Tissue Data

Type : HEAD
Frequency : 1900.00 MHz
Epsilon : 39.54 F/m
Sigma : 1.45 S/m
Density : 1000.00 kg/cu. m

Probe Data

Serial No. : 273
Frequency : 1900.00 MHz
Duty Cycle Factor : 8
Conversion Factor : 5.25
Probe Sensitivity : 1.20 1.20 1.20 $\mu\text{V}/(\text{V}/\text{m})^2$
Compression Point : 95.00 mV
Offset : 1.56 mm

1 gram SAR value : 0.498 W/kg
10 gram SAR value : 0.251 W/kg
Area Scan Peak SAR : 0.548 W/kg
Zoom Scan Peak SAR : 0.880 W/kg

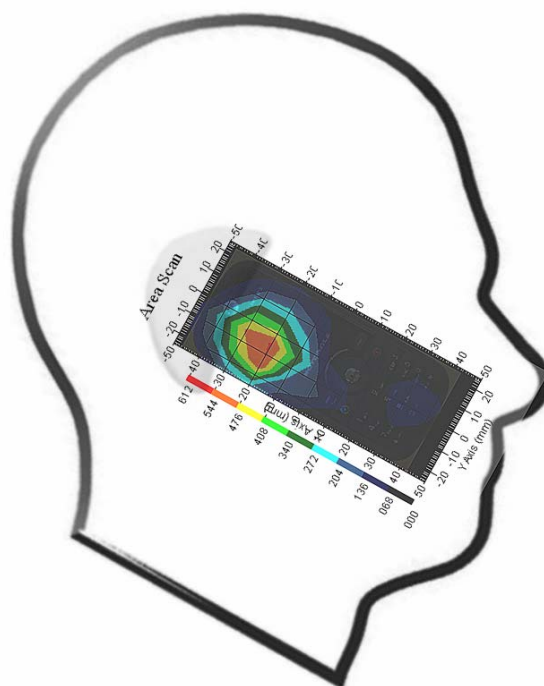
Plot 13#

Test Laboratory: Bay Area Compliance Lab Corp. (Shenzhen)**Right Head Cheek (1900 MHz High Channel)**

Measurement Data

Test mode : GSM
Crest Factor : 8
Scan Type: : Complete
Area Scan : 11x6x1 : Measurement x=10mm, y=10mm, z=4mm
Zoom Scan : 7x7x7 : Measurement x=5mm, y=5mm, z=5mm
Power Drift-Start : 0.063 W/kg
Power Drift-Finish : 0.060 W/kg
Power Drift (%) : -4.607

Tissue Data

Type : HEAD
Frequency : 1900.00 MHz
Epsilon : 39.54 F/m
Sigma : 1.45 S/m
Density : 1000.00 kg/cu. m

Probe Data

Serial No. : 273
Frequency : 1900.00 MHz
Duty Cycle Factor : 8
Conversion Factor : 5.25
Probe Sensitivity : 1.20 1.20 1.20 $\mu\text{V}/(\text{V/m})^2$
Compression Point : 95.00 mV
Offset : 1.56 mm

1 gram SAR value : 1.071 W/kg
10 gram SAR value : 0.621 W/kg
Area Scan Peak SAR : 1.453 W/kg
Zoom Scan Peak SAR : 1.871 W/kg

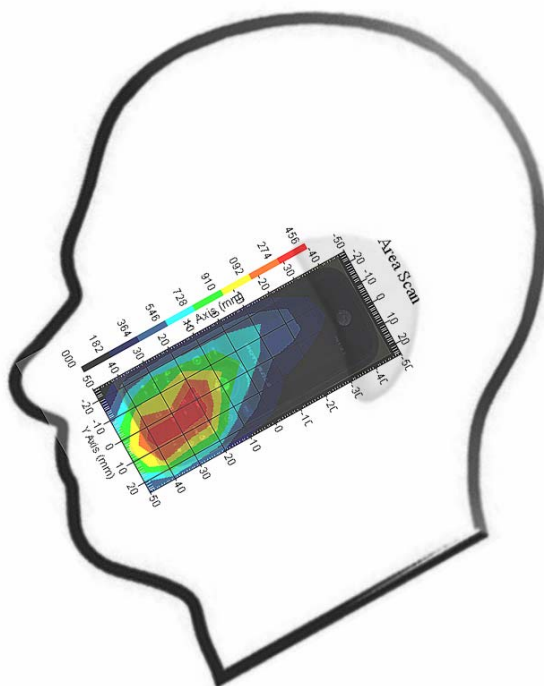
Plot 14#

Test Laboratory: Bay Area Compliance Lab Corp. (Shenzhen)**Right Head Cheek (1900 MHz Low Channel)**

Measurement Data

Test mode : GSM
Crest Factor : 8
Scan Type: : Complete
Area Scan : 11x6x1 : Measurement x=10mm, y=10mm, z=4mm
Zoom Scan : 7x7x7 : Measurement x=5mm, y=5mm, z=5mm
Power Drift-Start : 0.050 W/kg
Power Drift-Finish : 0.050 W/kg
Power Drift (%) : -0.407

Tissue Data

Type : HEAD
Frequency : 1900.00 MHz
Epsilon : 39.54 F/m
Sigma : 1.45 S/m
Density : 1000.00 kg/cu. m

Probe Data

Serial No. : 273
Frequency : 1900.00 MHz
Duty Cycle Factor : 8
Conversion Factor : 5.25
Probe Sensitivity : 1.20 1.20 1.20 $\mu\text{V}/(\text{V}/\text{m})^2$
Compression Point : 95.00 mV
Offset : 1.56 mm

1 gram SAR value : 1.030 W/kg
10 gram SAR value : 0.528 W/kg
Area Scan Peak SAR : 1.429 W/kg
Zoom Scan Peak SAR : 1.761 W/kg

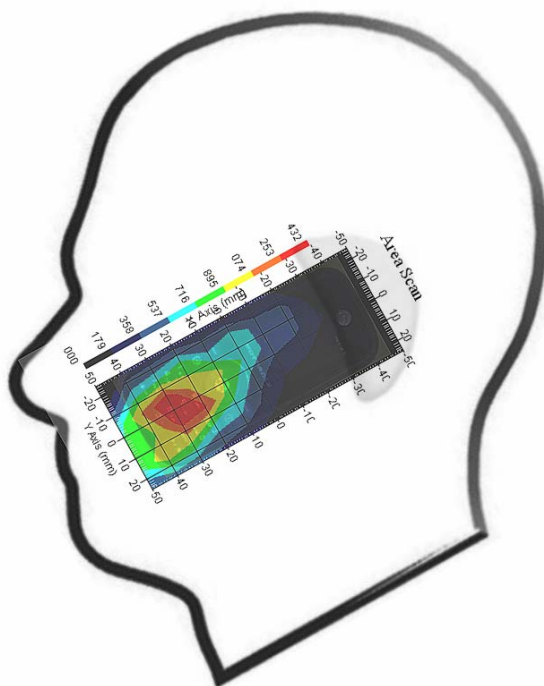
Plot 15#

Test Laboratory: Bay Area Compliance Lab Corp. (Shenzhen)**Right Head Cheek (1900 MHz Middle Channel)**

Measurement Data

Test mode : GSM
Crest Factor : 8
Scan Type: : Complete
Area Scan : 11x6x1 : Measurement x=10mm, y=10mm, z=4mm
Zoom Scan : 7x7x7 : Measurement x=5mm, y=5mm, z=5mm
Power Drift-Start : 0.052 W/kg
Power Drift-Finish : 0.054 W/kg
Power Drift (%) : 3.559

Tissue Data

Type : HEAD
Frequency : 1900.00 MHz
Epsilon : 39.54 F/m
Sigma : 1.45 S/m
Density : 1000.00 kg/cu. m

Probe Data

Serial No. : 273
Frequency : 1900.00 MHz
Duty Cycle Factor : 8
Conversion Factor : 5.25
Probe Sensitivity : 1.20 1.20 1.20 $\mu\text{V}/(\text{V/m})^2$
Compression Point : 95.00 mV
Offset : 1.56 mm

1 gram SAR value : 0.989 W/kg
10 gram SAR value : 0.574 W/kg
Area Scan Peak SAR : 1.323 W/kg
Zoom Scan Peak SAR : 1.911 W/kg

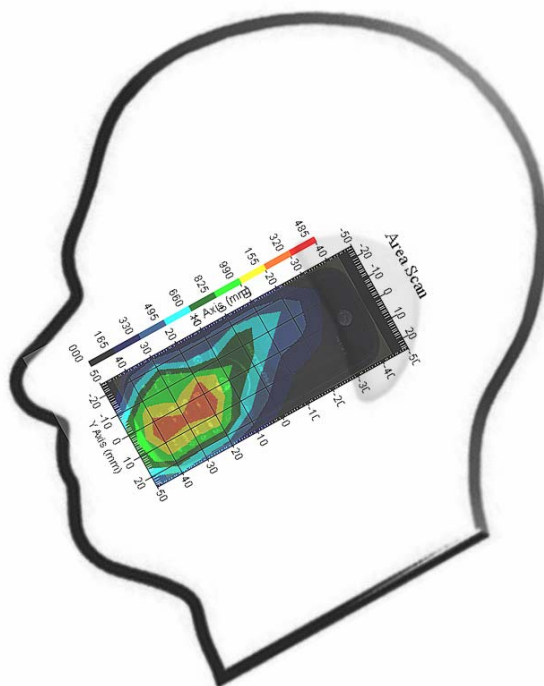
Plot 16#

Test Laboratory: Bay Area Compliance Lab Corp. (Shenzhen)**Right Head Tilt (1900 MHz High Channel)**

Measurement Data

Test mode : GSM
Crest Factor : 8
Scan Type: : Complete
Area Scan : 11x6x1 : Measurement x=10mm, y=10mm, z=4mm
Zoom Scan : 7x7x7 : Measurement x=5mm, y=5mm, z=5mm
Power Drift-Start : 0.241 W/kg
Power Drift-Finish : 0.230 W/kg
Power Drift (%) : -4.379

Tissue Data

Type : HEAD
Frequency : 1900.00 MHz
Epsilon : 39.54 F/m
Sigma : 1.45 S/m
Density : 1000.00 kg/cu. m

Probe Data

Serial No. : 273
Frequency : 1900.00 MHz
Duty Cycle Factor : 8
Conversion Factor : 5.25
Probe Sensitivity : 1.20 1.20 1.20 $\mu\text{V}/(\text{V}/\text{m})^2$
Compression Point : 95.00 mV
Offset : 1.56 mm

1 gram SAR value : 0.443 W/kg
10 gram SAR value : 0.199 W/kg
Area Scan Peak SAR : 0.552 W/kg
Zoom Scan Peak SAR : 0.870 W/kg

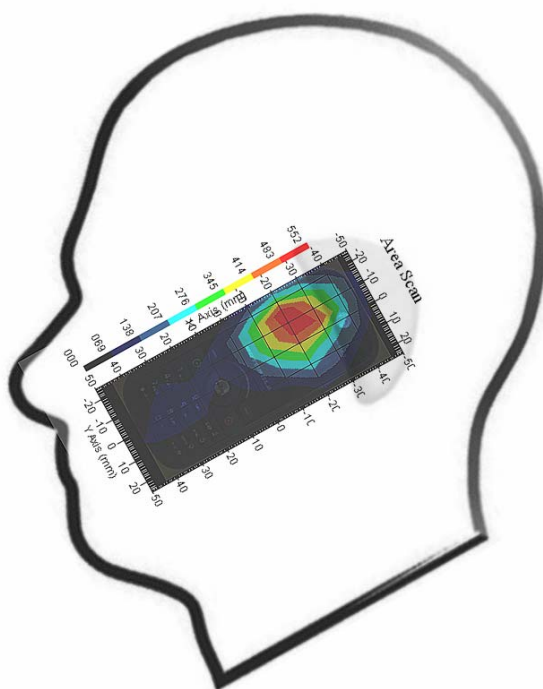
Plot 17#

Test Laboratory: Bay Area Compliance Lab Corp. (Shenzhen)**Body- worn Back (1900 MHz High Channel)**

Measurement Data

Test mode : GSM
Crest Factor : 8
Scan Type : Complete
Area Scan : 6x12x1 : Measurement x=10mm, y=10mm, z=4mm
Zoom Scan : 7x7x7 : Measurement x=5mm, y=5mm, z=5mm
Power Drift-Start : 0.196 W/kg
Power Drift-Finish : 0.202 W/kg
Power Drift (%) : 3.332

Tissue Data

Type : BODY
Frequency : 1900.00 MHz
Epsilon : 53.58 F/m
Sigma : 1.54 S/m
Density : 1000.00 kg/cu. m

Probe Data

Serial No. : 273
Frequency : 1900.00 MHz
Duty Cycle Factor : 8
Conversion Factor : 5.15
Probe Sensitivity : 1.20 1.20 1.20 $\mu\text{V}/(\text{V}/\text{m})^2$
Compression Point : 95.00 mV
Offset : 1.56 mm

1 gram SAR value : 0.423 W/kg
10 gram SAR value : 0.231 W/kg
Area Scan Peak SAR : 0.467 W/kg
Zoom Scan Peak SAR : 0.710 W/kg

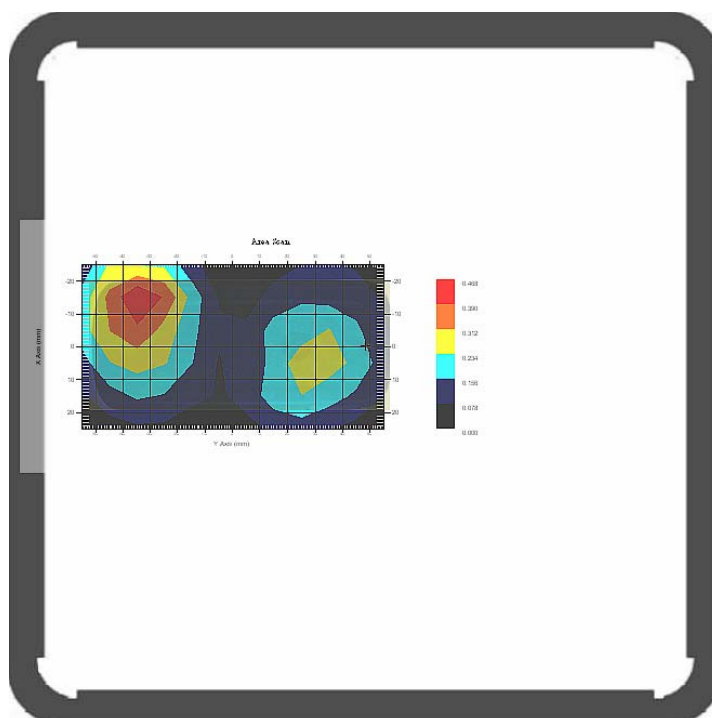
Plot 18#

APPENDIX F – CONDUCTED OUTPUT POWER MEASUREMENT

Test Procedure

The RF output of the transmitter was connected to the input of the spectrum analyzer through sufficient attenuation.

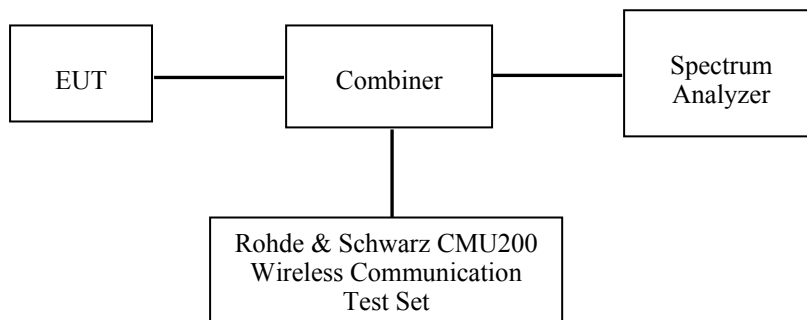

Test Equipment List and Details

Manufacturer	Equipment Description	Model No.	Serial No.	Calibration Date
Rohde & Schwarz	Communication Tester	CMU200	1100.0008.02	2008-09-26
Rohde & Schwarz	Spectrum Analyzer	FSEM30	849720/019	2008-08-28

Test Results

Band	Frequency (MHz)	Conducted Output Power	
		(dBm)	(Watts)
Cellular	824.2	31.86	1.535
	836.6	31.79	1.510
	848.8	31.80	1.514
PCS	1850.2	28.33	0.681
	1880.0	28.22	0.664
	1909.8	28.64	0.731

APPENDIX G – EUT TEST POSITION PHOTOS

Body-worn Setup Photo

(back touch the flat phantom with 1.5 cm distance)

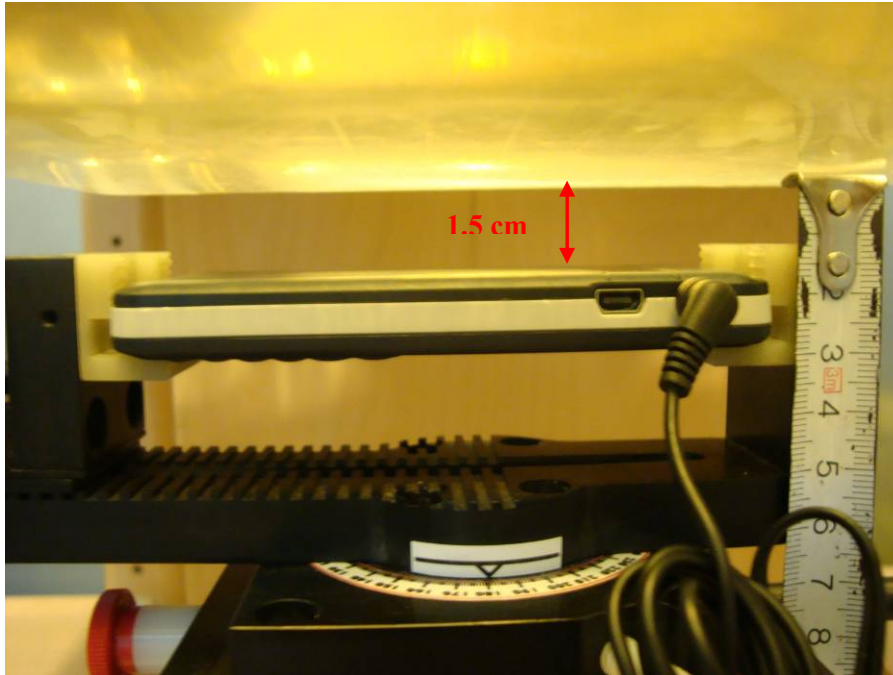

Left Head Touch Setup Photo

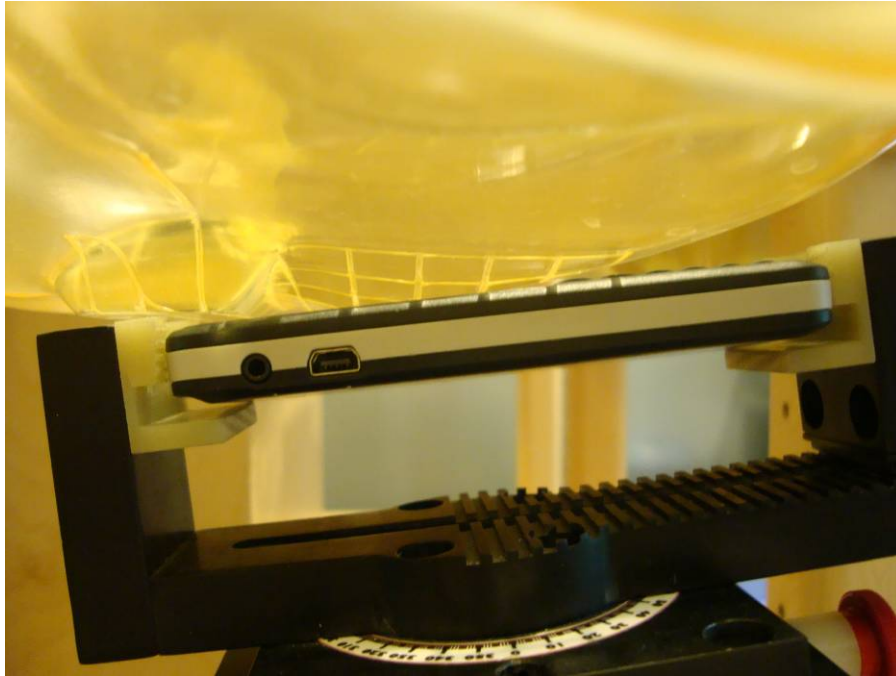

Left Head Tilt Setup Photo

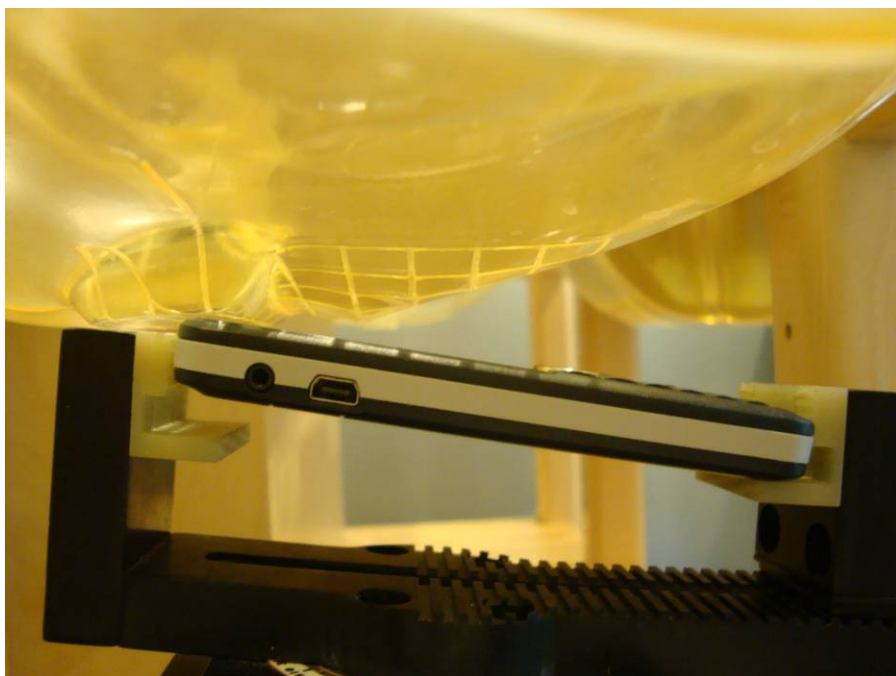

Right Head Touch Setup Photo

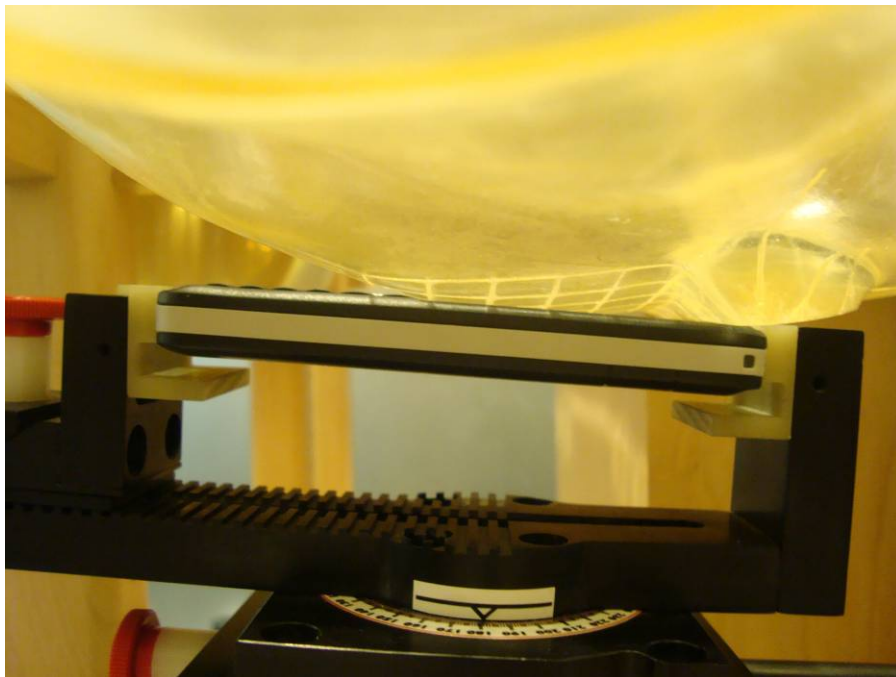

Right Head Tilt Setup Photo

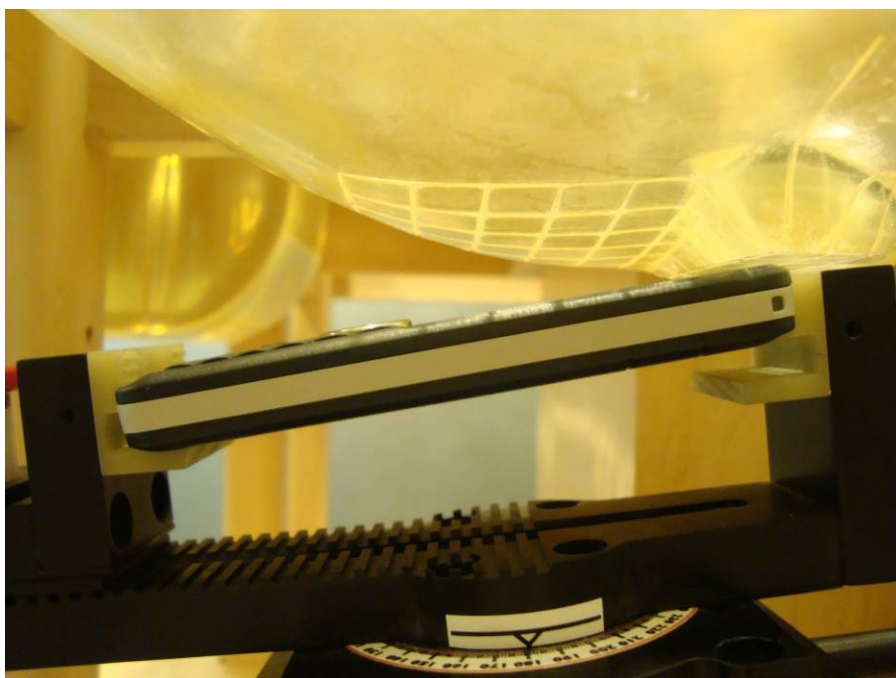

APPENDIX H – EUT PHOTOS

EUT - Top View



EUT - Bottom View



EUT- Uncovered View



EUT – Left Side View



EUT - Headset



APPENDIX I - INFORMATIVE REFERENCES

- [1] Federal Communications Commission, "Report and order: Guidelines for evaluating the environmental effects of radiofrequency radiation", Tech. Rep. FCC 96-326, FCC, Washington, D.C. 20554, 1996.
- [2] David L. Means Kwok Chan, Robert F. Cleveland, "Evaluating compliance with FCC guidelines for human exposure to radiofrequency electromagnetic fields", Tech. Rep., Federal Communication Commission, Office of Engineering & Technology, Washington, DC, 1997.
- [3] Thomas Schmid, Oliver Egger, and Niels Kuster, "Automated E-field scanning system for dosimetric assessments", IEEE Transactions on Microwave Theory and Techniques, vol. 44, pp. 105-113, Jan. 1996.
- [4] Niels Kuster, Ralph Kastle, and Thomas Schmid, "Dosimetric evaluation of mobile communications equipment with known precision", IEEE Transactions on Communications, vol. E80-B, no. 5, pp. 645-652, May 1997.
- [5] CENELEC, "Considerations for evaluating of human exposure to electromagnetic fields (EMFs) from mobile telecommunication equipment (MTE) in the frequency range 30MHz - 6GHz", Tech. Rep., CENELEC, European Committee for Electrotechnical Standardization, Brussels, 1997.
- [6] ANSI, ANSI/IEEE C95.1-1992: IEEE Standard for Safety Levels with Respect to Human Exposure to Radio Frequency Electromagnetic Fields, 3 kHz to 300 GHz, The Institute of Electrical and Electronics Engineers, Inc., New York, NY 10017, 1992.
- [7] Katja Pokovic, Thomas Schmid, and Niels Kuster, "Robust setup for precise calibration of E-field probes in tissue simulating liquids at mobile communications frequencies", in ICECOM '97, Dubrovnik, October 15-17, 1997, pp. 120-24.
- [8] Katja Pokovic, Thomas Schmid, and Niels Kuster, "E-field probe with improved isotropy in brain simulating liquids", in Proceedings of the ELMAR, Zadar, Croatia, 23-25 June, 1996, pp. 172-175.
- [9] Volker Hombach, Klaus Meier, Michael Burkhardt, Eberhard Kuhn, and Niels Kuster, "The dependence of EM energy absorption upon human head modeling at 900 MHz", IEEE Transactions on Microwave Theory and Techniques, vol. 44, no. 10, pp. 1865-1873, Oct. 1996.
- [10] Klaus Meier, Ralf Kastle, Volker Hombach, Roger Tay, and Niels Kuster, "The dependence of EM energy absorption upon human head modeling at 1800 MHz", IEEE Transactions on Microwave Theory and Techniques, Oct. 1997, in press.
- [11] W. Gander, Computermathematik, Birkhaeuser, Basel, 1992.
- [12] W. H. Press, S. A. Teukolsky, W. T. Vetterling, and B. P. Flannery, Numerical Recipes in C, The Art of Scientific Computing, Second Edition, Cambridge University Press, 1992. Dosimetric Evaluation of Sample device, month 1998 9
- [13] NIS81 NAMAS, "The treatment of uncertainty in EMC measurement", Tech. Rep., NAMAS Executive, National Physical Laboratory, Teddington, Middlesex, England, 1994.
- [14] Barry N. Taylor and Christ E. Kuyatt, "Guidelines for evaluating and expressing the uncertainty of NIST measurement results", Tech. Rep., National Institute of Standards and Technology, 1994. Dosimetric Evaluation of Sample device, month 1998 10.

APPENDIX J - PRODUCT SIMILAR DECLARATION LETTER



Brightstar

Brightstar Corporation

9725 NW 117th Ave.,#300 Miami, Florida United States

Product Similarity Declaration

To Whom It May Concern,

We, Brightstar Corporation, hereby declare that our GSM Mobile Phone, Model Number: Avvio205/ Avvio 205A/Avvio 205E/Avvio 207/ Avvio 207A/Avvio 207E are electrically identical with the Model Number: C3017 that was certified by BACL. They are named differently due to marketing purposes.

Please contact me if you have any question.

Signature:



Typed or Printed Name: Welton Giolo

Title: project manager

Company Name: Brightstar Corporation

******* END OF REPORT *******