



FCC RF Test Report

APPLICANT : Brightstar Corporation
EQUIPMENT : Mobile Phone
BRAND NAME : Avvio
MODEL NAME : Avvio L800S, Avvio L800
FCC ID : WVBAL800X
STANDARD : FCC Part 15 Subpart C §15.247
CLASSIFICATION : (DSS) Spread Spectrum Transmitter

The product was received on Aug. 05, 2015 and testing was completed on Sep. 06, 2015. We, SPORTON INTERNATIONAL (SHENZHEN) INC., would like to declare that the tested sample has been evaluated in accordance with the test procedures and has been in compliance with the applicable technical standards.

The test results in this report apply exclusively to the tested model / sample. Without written approval of SPORTON INTERNATIONAL (SHENZHEN) INC., the test report shall not be reproduced except in full.

Reviewed by: Joseph Lin / Supervisor

Approved by: Jones Tsai / Manager



SPORTON INTERNATIONAL (SHENZHEN) INC.

**1F & 2F, Building A, Morning Business Center, No. 4003 ShiGu Rd., Xili Town,
Nanshan District, Shenzhen, Guangdong, P. R. China**



TABLE OF CONTENTS

REVISION HISTORY..... 3

SUMMARY OF TEST RESULT 4

1 GENERAL DESCRIPTION..... 5

 1.1 Applicant..... 5

 1.2 Manufacturer..... 5

 1.3 Product Feature of Equipment Under Test..... 5

 1.4 Product Specification subjective to this standard 6

 1.5 Modification of EUT 6

 1.6 Testing Location 6

 1.7 Applicable Standards..... 7

2 TEST CONFIGURATION OF EQUIPMENT UNDER TEST..... 8

 2.1 Descriptions of Test Mode 8

 2.2 Test Mode..... 9

 2.3 Connection Diagram of Test System..... 10

 2.4 Support Unit used in test configuration and system 11

 2.5 EUT Operation Test Setup 11

 2.6 Measurement Results Explanation Example..... 11

3 TEST RESULT 12

 3.1 Number of Channel Measurement 12

 3.2 Hopping Channel Separation Measurement 14

 3.3 Dwell Time Measurement..... 21

 3.4 20dB Bandwidth Measurement 24

 3.5 Peak Output Power Measurement 31

 3.6 Conducted Band Edges Measurement 33

 3.7 Conducted Spurious Emission Measurement 40

 3.8 Radiated Band Edges and Spurious Emission Measurement 50

 3.9 AC Conducted Emission Measurement..... 56

 3.10 Antenna Requirements..... 60

4 LIST OF MEASURING EQUIPMENT..... 61

5 UNCERTAINTY OF EVALUATION..... 62

APPENDIX A. RADIATED TEST RESULTS

APPENDIX B. SETUP PHOTOGRAPHS

**SUMMARY OF TEST RESULT**

Report Section	FCC Rule	Description	Limit	Result	Remark
3.1	15.247(a)(1)	Number of Channels	$\geq 15\text{Chs}$	Pass	-
3.2	15.247(a)(1)	Hopping Channel Separation	$\geq 2/3$ of 20dB BW	Pass	-
3.3	15.247(a)(1)	Dwell Time of Each Channel	$\leq 0.4\text{sec}$ in 31.6sec period	Pass	-
3.4	15.247(a)(1)	20dB Bandwidth	NA	Pass	-
3.5	15.247(b)(1)	Peak Output Power	$\leq 125\text{ mW}$	Pass	-
3.6	15.247(d)	Conducted Band Edges	$\leq 20\text{dBc}$	Pass	-
3.7	15.247(d)	Conducted Spurious Emission	$\leq 20\text{dBc}$	Pass	-
3.8	15.247(d)	Radiated Band Edges and Radiated Spurious Emission	15.209(a) & 15.247(d)	Pass	Under limit 7.61 dB at 49.400 MHz
3.9	15.207	AC Conducted Emission	15.207(a)	Pass	Under limit 6.11 dB at 0.410 MHz
3.10	15.203 & 15.247(b)	Antenna Requirement	N/A	Pass	-



1 General Description

1.1 Applicant

Brightstar Corporation

9725 NW 117th Ave., Miami, Florida, FL 33178, United States

1.2 Manufacturer

Heng Da Chuang Xin Technology Limited

Rm14H Taibang Building, 4 Rd. High Tech South, Nanshan, SZ, P. R. C. 518000

1.3 Product Feature of Equipment Under Test

Product Feature	
Equipment	Mobile Phone
Brand Name	Avvio
Model Name	Avvio L800S, Avvio L800
FCC ID	WVBAL800X
EUT supports Radios application	GSM/GPRS/EGPRS/WCDMA/HSPA/HSPA+/DC-HSDPA/LTE/ WLAN2.4GHz 802.11b/g/n HT20/HT40/ Bluetooth v3.0 + EDR/Bluetooth v4.0 LE
IMEI Code	Conducted: 358151060000352 Conduction: 358151060000311 Radiation: 358151060000345
HW Version	M326B
SW Version	AVVIO_L800_V1_0_1
EUT Stage	Production Unit

Remark:

1. The above EUT's information was declared by manufacturer. Please refer to the specifications or user's manual for more detailed description.
2. The difference of the two samples (Model Name: Avvio L800S, Avvio L800): Avvio L800 is single SIM card, Avvio L800S is dual SIM card. We only choose dual SIM sample to perform full tests.



1.4 Product Specification subjective to this standard

Product Specification subjective to this standard	
Tx/Rx Frequency Range	2402 MHz ~ 2480 MHz
Number of Channels	79
Carrier Frequency of Each Channel	2402+n*1 MHz; n=0~78
Maximum Output Power to Antenna	Bluetooth BR(1Mbps) : 3.91 dBm (0.00246 W) Bluetooth EDR (2Mbps) : 3.08 dBm (0.00203 W) Bluetooth EDR (3Mbps) : 3.32 dBm (0.00215 W)
Antenna Type / Gain	PIFA Antenna with gain -1.00 dBi
Type of Modulation	Bluetooth BR (1Mbps) : GFSK Bluetooth EDR (2Mbps) : $\pi/4$ -DQPSK Bluetooth EDR (3Mbps) : 8-DPSK

1.5 Modification of EUT

No modifications are made to the EUT during all test items.

1.6 Testing Location

Test Site	SPORTON INTERNATIONAL (SHENZHEN) INC.	
Test Site Location	1F & 2F, Building A, Morning Business Center, No. 4003 ShiGu Rd., Xili Town, Nanshan District, Shenzhen, Guangdong, P. R. China TEL: +86-755-8637-9589 FAX: +86-755-8637-9595	
Test Site No.	Sporton Site No.	
	TH01-SZ	CO01-SZ

Test Site	SPORTON INTERNATIONAL (SHENZHEN) INC.	
Test Site Location	No. 3 Building, the third floor of south, Shahe River west, Fengzeyuan warehouse, Nanshan District, Shenzhen, Guangdong, P. R. China TEL: +86-755-3320-2398	
Test Site No.	Sporton Site No.	FCC Registration No.
	03CH02-SZ	566869

Note: The test site complies with ANSI C63.4 2009 requirement.



1.7 Applicable Standards

According to the specifications of the manufacturer, the EUT must comply with the requirements of the following standards:

- ♦ FCC Part 15 Subpart C §15.247
- ♦ FCC Public Notice DA 00-705
- ♦ ANSI C63.10-2013

Remark:

1. All test items were verified and recorded according to the standards and without any deviation during the test.
2. FCC permits the use of the 1.5 meter table as an alternative in C63.10-2013 through inquiry tracking number 961829.
3. This EUT has also been tested and complied with the requirements of FCC Part 15, Subpart B, recorded in a separate test report.

2 Test Configuration of Equipment Under Test

2.1 Descriptions of Test Mode

Preliminary tests were performed in different data rates and recorded the RF output power in the following table:

Channel	Frequency	Bluetooth RF Output Power		
		Data Rate / Modulation		
		GFSK	$\pi/4$ -DQPSK	8-DPSK
		1Mbps	2Mbps	3Mbps
Ch00	2402MHz	3.91 dBm	3.08 dBm	3.32 dBm
Ch39	2441MHz	0.85 dBm	0.38 dBm	0.45 dBm
Ch78	2480MHz	2.30 dBm	1.54 dBm	1.73 dBm

Remark:

1. All the test data for each data rate were verified, but only the worst case was reported.
 2. The data rate was set in 1Mbps for all the test items due to the highest RF output power.
- a. The EUT has been associated with peripherals and configuration operated in a manner tended to maximize its emission characteristics in a typical application. Frequency range investigated: conduction (150 kHz to 30 MHz), radiation (9 kHz to the 10th harmonic of the highest fundamental frequency or to 40 GHz, whichever is lower). Pre-scanned tests, X, Y, Z in three orthogonal panels, and different data rates were conducted to determine the final configuration (Y plane as worst plane) from all possible combinations, and the worst mode of radiated spurious emissions is Bluetooth 1Mbps mode, and recorded in this report.
- b. AC power line Conducted Emission was tested under maximum output power.



2.2 Test Mode

The following summary table is showing all test modes to demonstrate in compliance with the standard.

Summary table of Test Cases			
Test Item	Data Rate / Modulation		
	Bluetooth BR 1Mbps GFSK	Bluetooth EDR 2Mbps $\pi/4$ -DQPSK	Bluetooth EDR 3Mbps 8-DPSK
Conducted Test Cases	Mode 1: CH00_2402 MHz Mode 2: CH39_2441 MHz Mode 3: CH78_2480 MHz	Mode 4: CH00_2402 MHz Mode 5: CH39_2441 MHz Mode 6: CH78_2480 MHz	Mode 7: CH00_2402 MHz Mode 8: CH39_2441 MHz Mode 9: CH78_2480 MHz
Radiated Test Cases	Bluetooth BR 1Mbps GFSK		
	Mode 1: CH00_2402 MHz Mode 2: CH39_2441 MHz Mode 3: CH78_2480 MHz		
AC Conducted Emission	Mode 1 :GSM850 Idle + Bluetooth Link + WLAN Link + Earphone + USB Cable (Charging from Adapter)		
Remark:			
<ol style="list-style-type: none"> For radiated test cases, the worst mode data rate 1Mbps was reported only, because this data rate has the highest RF output power at preliminary tests, and no other significantly frequencies found in conducted spurious emission. For radiated test cases, the tests were performed with adapter, earphone and USB cable. 			

2.3 Connection Diagram of Test System

<Bluetooth Tx Mode>

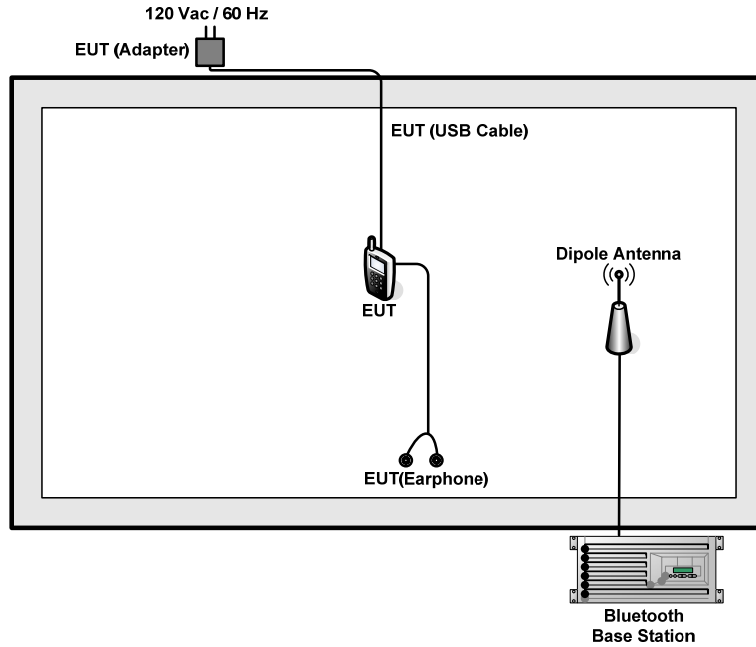

<AC Conducted Emission Mode>

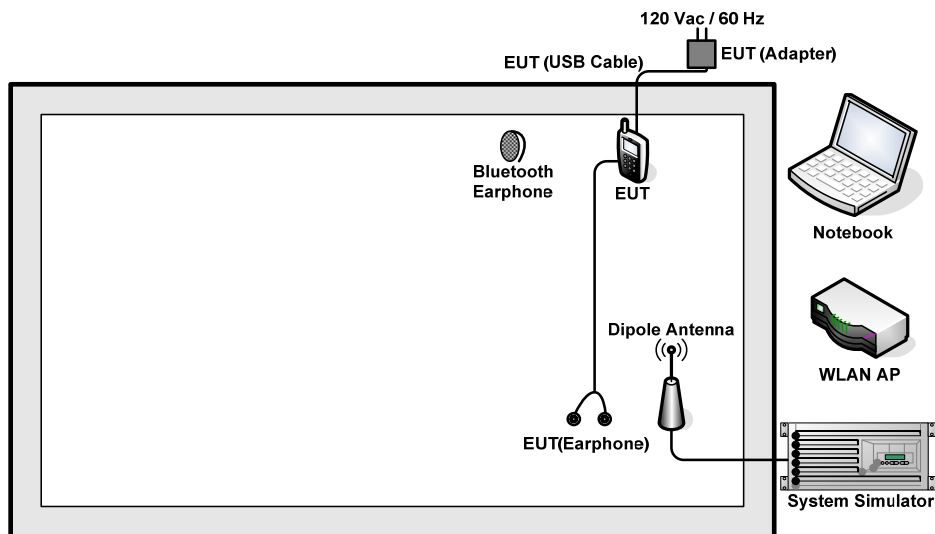

2.4 Support Unit used in test configuration and system

Item	Equipment	Trade Name	Model Name	FCC ID	Data Cable	Power Cord
1.	Bluetooth Base Station	R&S	CBT	N/A	N/A	Unshielded, 1.8 m
2.	System Simulator	R&S	CMU 200	N/A	N/A	Unshielded, 1.8 m
3.	WLAN AP	D-Link	DIR-628	KA2DIR628A2	N/A	Unshielded, 1.8 m
4.	Notebook	Lenovo	E540	FCC DoC	N/A	AC I/P: Unshielded, 1.2 m DC O/P: Shielded, 1.8 m
5.	Bluetooth Earphone	Nokia	BH-108	PYAHS-107W	N/A	N/A

2.5 EUT Operation Test Setup

For Bluetooth function, the engineering test program was provided and enabled to make EUT connect with Bluetooth base station to continuous transmit/receive.

For AC power line conducted emissions, the EUT was set to connect with the WLAN AP under large package sizes transmission.

2.6 Measurement Results Explanation Example

For all conducted test items:

The offset level is set in the spectrum analyzer to compensate the RF cable loss and attenuator factor between EUT conducted output port and spectrum analyzer. With the offset compensation, the spectrum analyzer reading level is exactly the EUT RF output level.

Example:

The spectrum analyzer offset is derived from RF cable loss and attenuator factor.

Offset = RF cable loss + attenuator factor.

Following shows an offset computation example with cable loss 5.0 dB and 10dB attenuator.

$$\begin{aligned} \text{Offset(dB)} &= \text{RF cable loss(dB)} + \text{attenuator factor(dB)}. \\ &= 5.0 + 10 = 15.0 \text{ (dB)} \end{aligned}$$

3 Test Result

3.1 Number of Channel Measurement

3.1.1 Limits of Number of Hopping Frequency

Frequency hopping systems in the 2400-2483.5 MHz band shall use at least 15 channels.

3.1.2 Measuring Instruments

The measuring equipment is listed in the section 4 of this test report.

3.1.3 Test Procedure

1. The testing follows FCC Public Notice DA 00-705 Measurement Guidelines.
2. The RF output of EUT was connected to the spectrum analyzer by RF cable and attenuator. The path loss was compensated to the results for each measurement.
3. Set to the maximum power setting and enable the EUT transmit continuously.
4. Enable the EUT hopping function.
5. Use the following spectrum analyzer settings: Span = the frequency band of operation; RBW \geq 1% of the span; VBW \geq RBW; Sweep = auto; Detector function = peak; Trace = max hold.
6. The number of hopping frequency used is defined as the number of total channel.
7. Record the measurement data derived from spectrum analyzer.

3.1.4 Test Setup

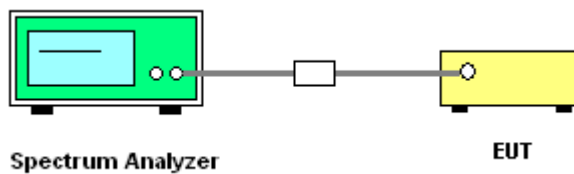

3.1.5 Test Result of Number of Hopping Frequency

Test Mode :	1Mbps	Temperature :	24~26°C
Test Engineer :	Sam Zheng	Relative Humidity :	50~53%
Number of Hopping (Channel)	Adaptive Frequency Hopping (Channel)	Limits (Channel)	Pass/Fail
79	20	> 15	Pass



Number of Hopping Channel Plot on Channel 00 - 78

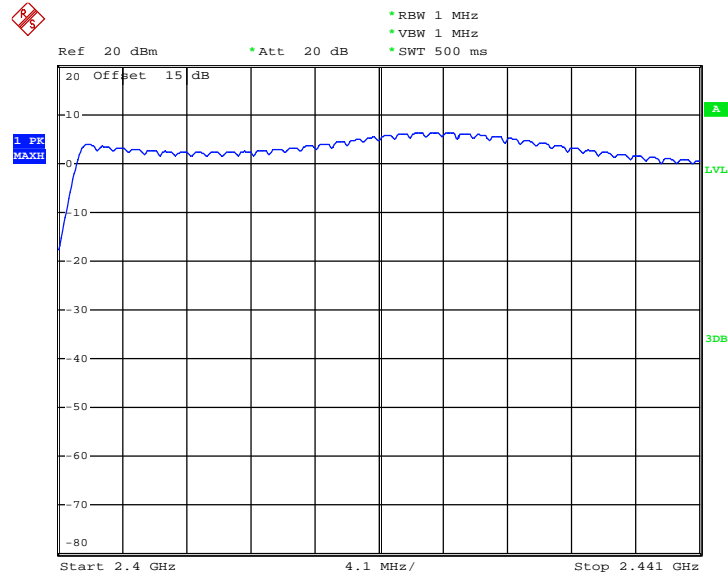

Date: 20.AUG.2015 22:51:51

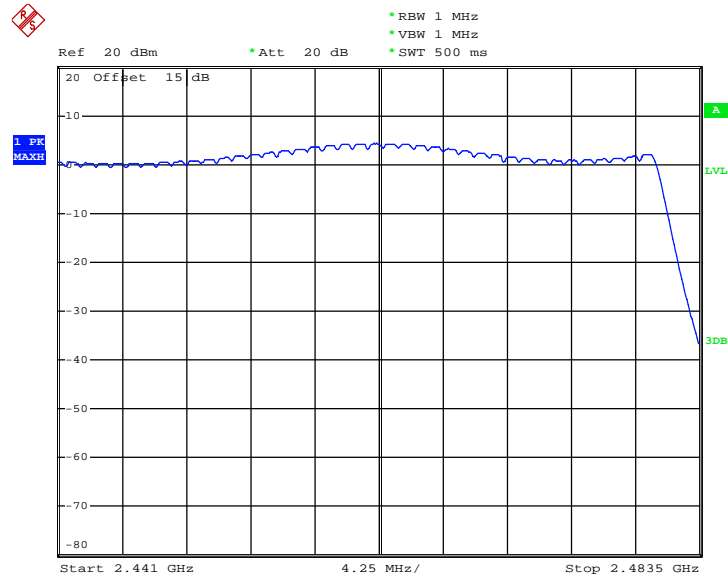

Date: 20.AUG.2015 22:55:45

3.2 Hopping Channel Separation Measurement

3.2.1 Limit of Hopping Channel Separation

Frequency hopping systems operating in the 2400-2483.5 MHz band may have hopping channel carrier frequencies that are separated by 25 kHz or two-thirds of the 20 dB bandwidth of the hopping channel, whichever is greater.

3.2.2 Measuring Instruments

The measuring equipment is listed in the section 4 of this test report.

3.2.3 Test Procedures

1. The testing follows FCC Public Notice DA 00-705 Measurement Guidelines.
2. The RF output of EUT was connected to the spectrum analyzer by RF cable and attenuator. The path loss was compensated to the results for each measurement.
3. Set to the maximum power setting and enable the EUT transmit continuously.
4. Enable the EUT hopping function.
5. Use the following spectrum analyzer settings:
Span = wide enough to capture the peaks of two adjacent channels; RBW \geq 1% of the span;
VBW \geq RBW; Sweep = auto; Detector function = peak; Trace = max hold.
6. Measure and record the results in the test report.

3.2.4 Test Setup

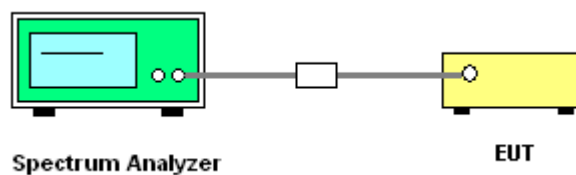



3.2.5 Test Result of Hopping Channel Separation

Test Mode :	1Mbps	Temperature :	24~26°C
Test Engineer :	Sam Zheng	Relative Humidity :	50~53%

Channel	Frequency (MHz)	Frequency Separation (MHz)	(2/3 of 20dB BW) Limits (MHz)	Pass/Fail
00	2402	1.146	0.6213	Pass
39	2441	1.002	0.6187	Pass
78	2480	1.008	0.5973	Pass

Channel Separation Plot on Channel 00 - 01

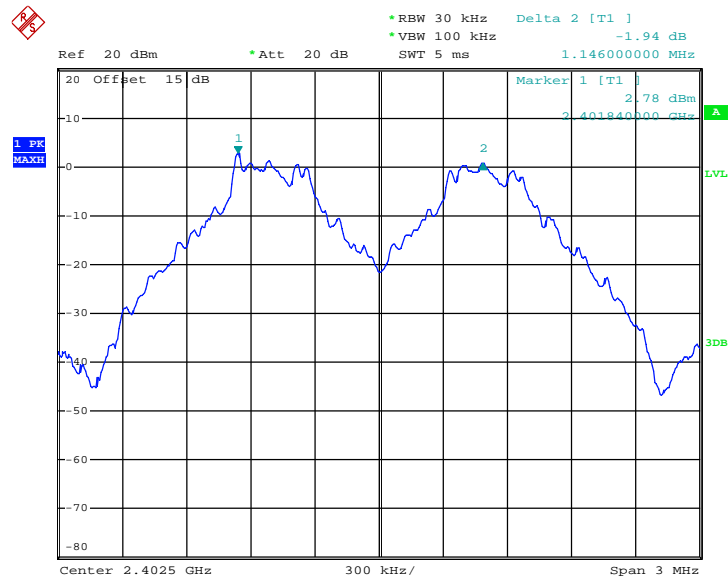

Date: 20.AUG.2015 21:03:24



Channel Separation Plot on Channel 39 - 40

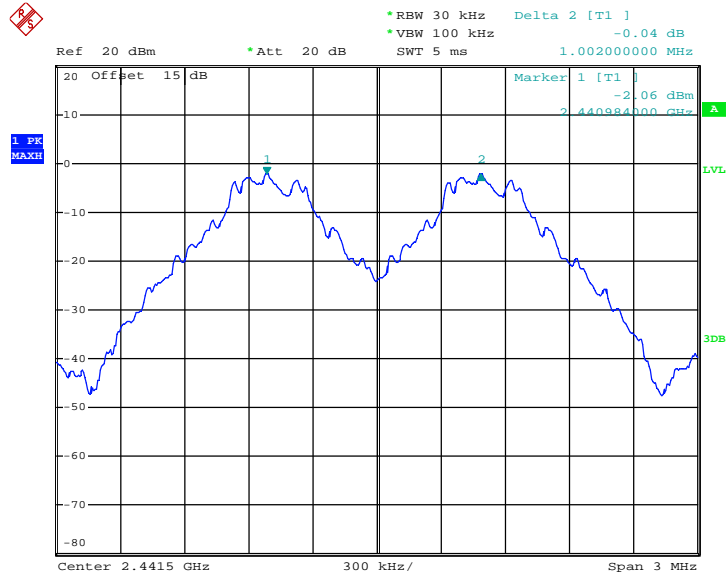

Date: 20.AUG.2015 21:04:27

Channel Separation Plot on Channel 77 - 78

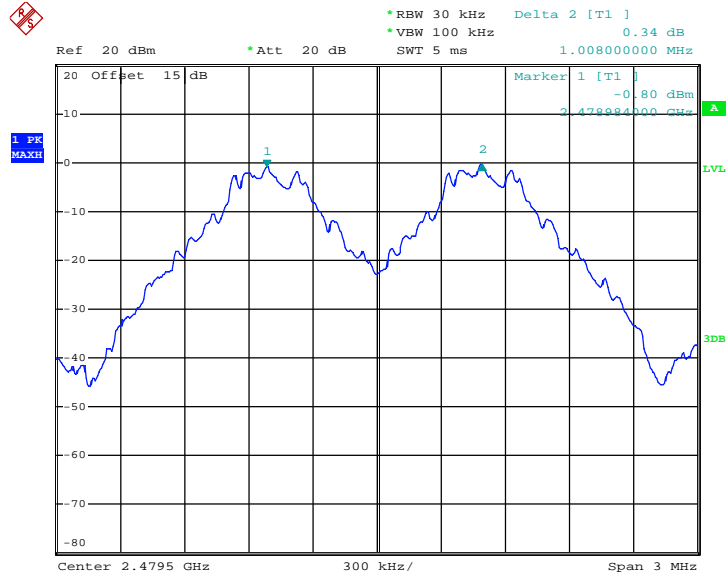

Date: 20.AUG.2015 21:05:12



Test Mode :	2Mbps	Temperature :	24~26°C
Test Engineer :	Sam Zheng	Relative Humidity :	50~53%

Channel	Frequency (MHz)	Frequency Separation (MHz)	(2/3 of 20dB BW) Limits (MHz)	Pass/Fail
00	2402	1.002	0.8440	Pass
39	2441	1.002	0.8440	Pass
78	2480	1.002	0.8280	Pass

Channel Separation Plot on Channel 00 - 01

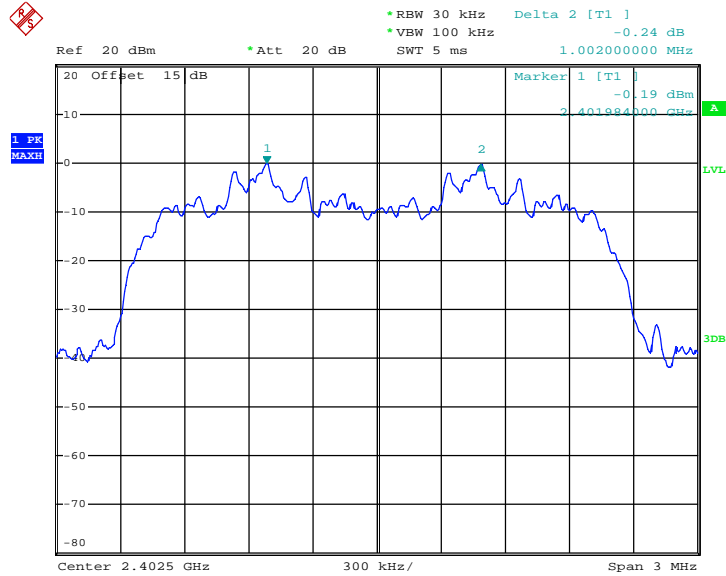

Date: 20.AUG.2015 21:30:12



Channel Separation Plot on Channel 39 - 40

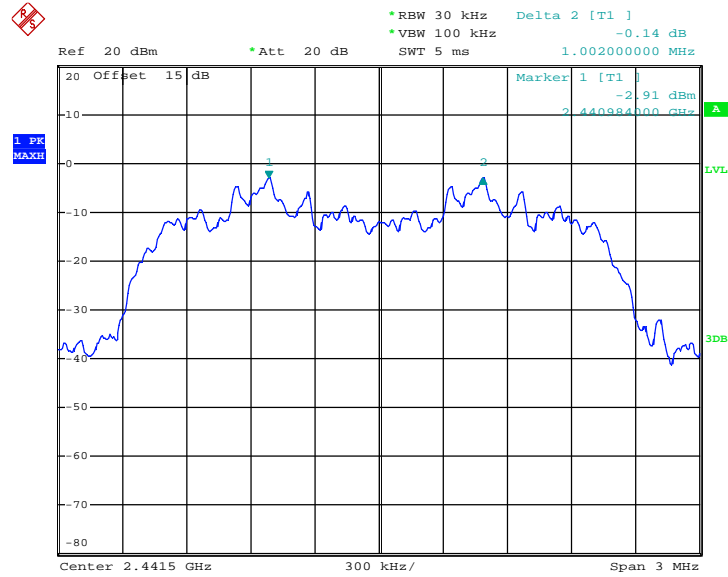

Date: 20.AUG.2015 21:29:12

Channel Separation Plot on Channel 77 - 78

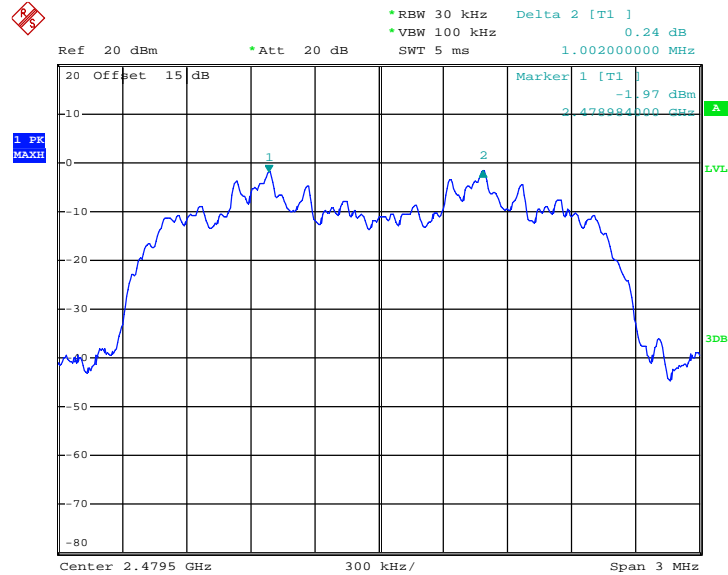

Date: 20.AUG.2015 21:07:28



Test Mode :	3Mbps	Temperature :	24~26°C
Test Engineer :	Sam Zheng	Relative Humidity :	50~53%

Channel	Frequency (MHz)	Frequency Separation (MHz)	(2/3 of 20dB BW) Limits (MHz)	Pass/Fail
00	2402	1.002	0.8280	Pass
39	2441	1.002	0.8280	Pass
78	2480	1.008	0.8240	Pass

Channel Separation Plot on Channel 00 - 01

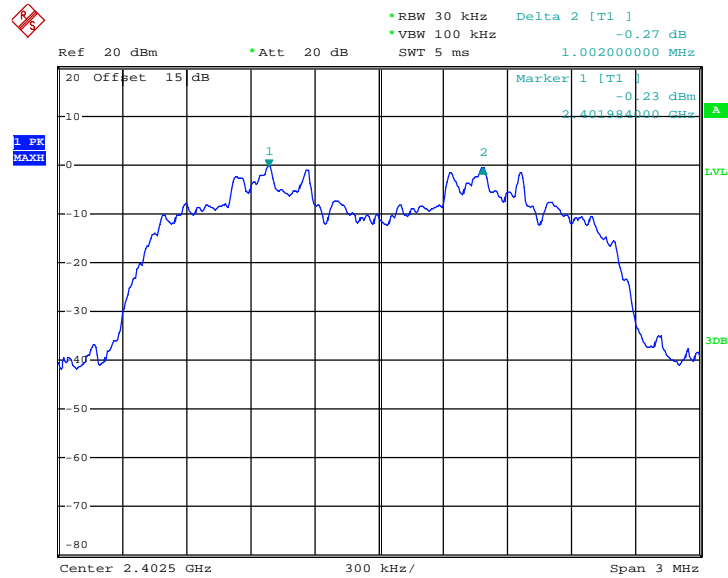

Date: 20.AUG.2015 21:08:10



Channel Separation Plot on Channel 39 - 40

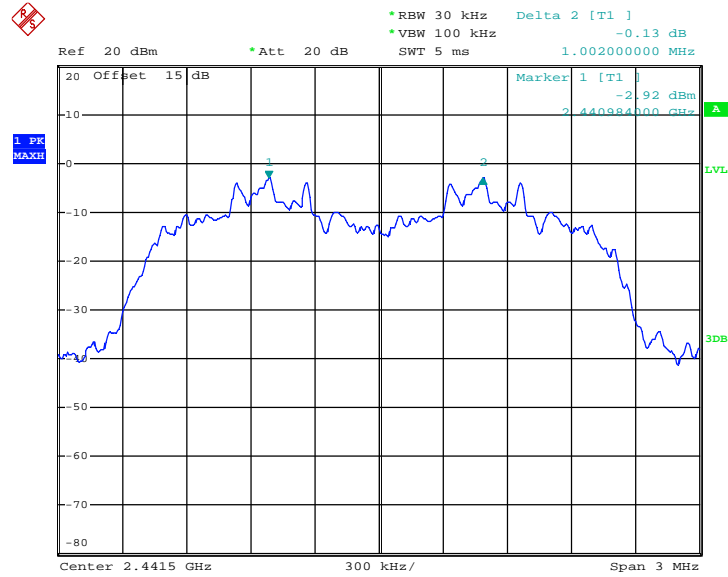

Date: 20.AUG.2015 21:08:52

Channel Separation Plot on Channel 77 - 78

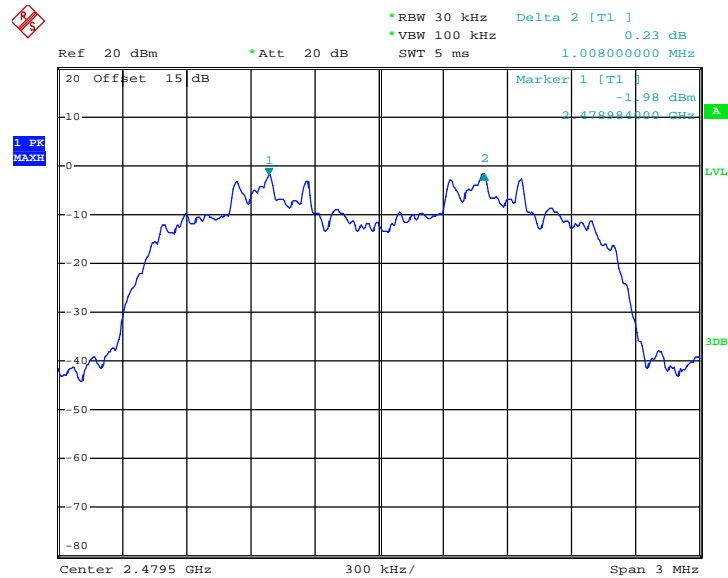

Date: 20.AUG.2015 21:09:49

3.3 Dwell Time Measurement

3.3.1 Limit of Dwell Time

The average time of occupancy on any channel shall not be greater than 0.4 seconds within a period of 0.4 seconds multiplied by the number of hopping channels employed.

3.3.2 Measuring Instruments

The measuring equipment is listed in the section 4 of this test report.

3.3.3 Test Procedures

1. The testing follows FCC Public Notice DA 00-705 Measurement Guidelines.
2. The RF output of EUT was connected to the spectrum analyzer by RF cable and attenuator. The path loss was compensated to the results for each measurement.
3. Set to the maximum power setting and enable the EUT transmit continuously.
4. Enable the EUT hopping function.
5. Use the following spectrum analyzer settings: Span = zero span, centered on a hopping channel; RBW = 1 MHz; VBW \geq RBW; Sweep = as necessary to capture the entire dwell time per hopping channel; Detector function = peak; Trace = max hold.
6. Measure and record the results in the test report.

3.3.4 Test Setup

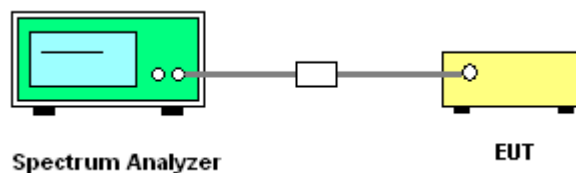



3.3.5 Test Result of Dwell Time

Test Mode :	DH5	Temperature :	24~26°C
Test Engineer :	Sam Zheng	Relative Humidity :	50~53%

Mode	Hopping Channel Number	Hops Over Occupancy Time(hops)	Package Transfer Time (msec)	Dwell Time (sec)	Limits (sec)	Pass/Fail
Normal	79	106.67	2.884	0.31	0.4	Pass
AFH	20	53.33	2.884	0.15	0.4	Pass

Remark:

- In normal mode, hopping rate is 1600 hops/s with 6 slots in 79 hopping channels.
With channel hopping rate (1600 / 6 / 79) in Occupancy Time Limit (0.4 x 79) (s),
Hops Over Occupancy Time comes to (1600 / 6 / 79) x (0.4 x 79) = 106.67 hops.
- In AFH mode, hopping rate is 800 hops/s with 6 slots in 20 hopping channels.
With channel hopping rate (800 / 6 / 20) in Occupancy Time Limit (0.4 x 20) (s),
Hops Over Occupancy Time comes to (800 / 6 / 20) x (0.4 x 20) = 53.33 hops.
- Dwell Time(s) = Hops Over Occupancy Time (hops) x Package Transfer Time



Package Transfer Time Plot

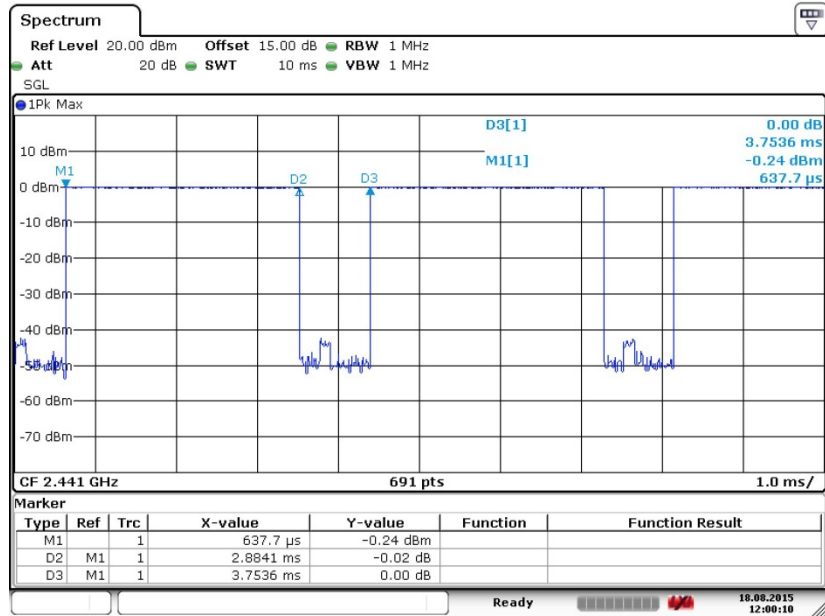

Date: 18.AUG.2015 12:00:10

3.4 20dB Bandwidth Measurement

3.4.1 Limit of 20dB Bandwidth

Reporting only

3.4.2 Measuring Instruments

The measuring equipment is listed in the section 4 of this test report.

3.4.3 Test Procedures

1. The testing follows FCC Public Notice DA 00-705 Measurement Guidelines.
2. The RF output of EUT was connected to the spectrum analyzer by RF cable and attenuator. The path loss was compensated to the results for each measurement.
3. Set to the maximum power setting and enable the EUT transmit continuously.
4. Use the following spectrum analyzer settings for 20dB Bandwidth measurement.
Span = approximately 2 to 3 times the 20 dB bandwidth, centered on a hopping channel;
RBW \geq 1% of the 20 dB bandwidth; VBW \geq RBW; Sweep = auto; Detector function = peak;
Trace = max hold.
5. Measure and record the results in the test report.

3.4.4 Test Setup

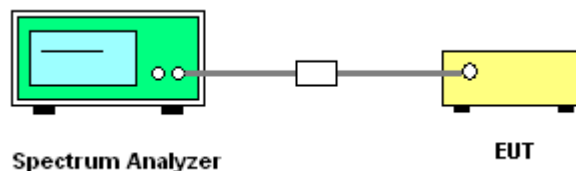



3.4.5 Test Result of 20dB Bandwidth

Test Mode :	1Mbps	Temperature :	24~26°C
Test Engineer :	Sam Zheng	Relative Humidity :	50~53%

Channel	Frequency (MHz)	20dB Bandwidth (MHz)
00	2402	0.932
39	2441	0.928
78	2480	0.896

20 dB Bandwidth Plot on Channel 00

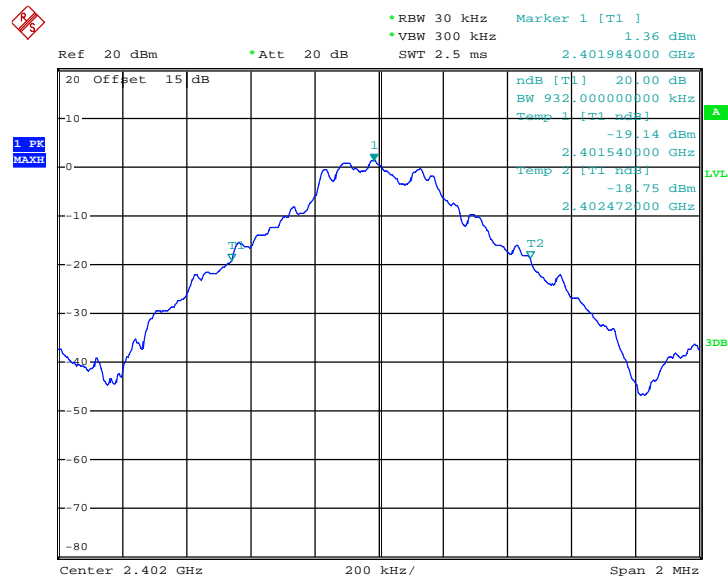

Date: 20.AUG.2015 21:12:40



20 dB Bandwidth Plot on Channel 39

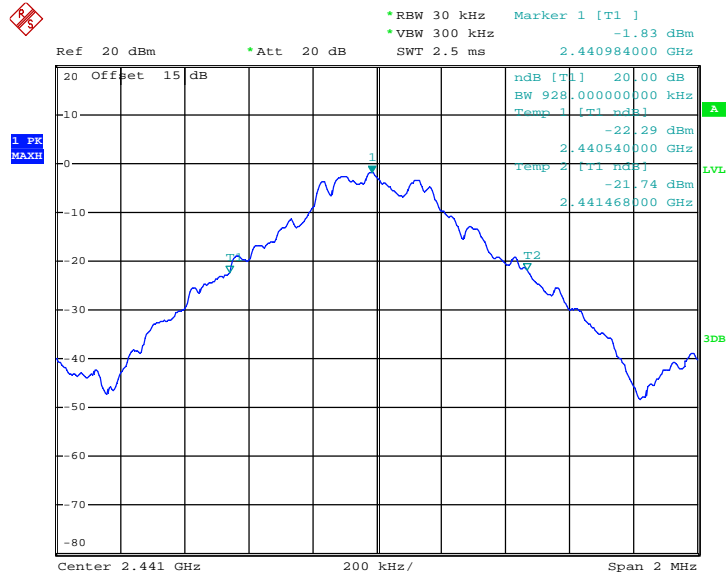

Date: 20.AUG.2015 21:13:30

20 dB Bandwidth Plot on Channel 78

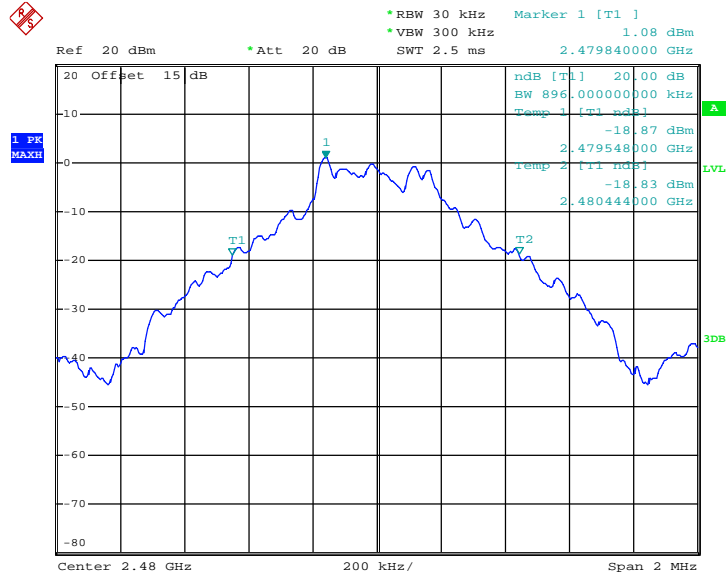

Date: 20.AUG.2015 21:14:05



Test Mode :	2Mbps	Temperature :	24~26°C
Test Engineer :	Sam Zheng	Relative Humidity :	50~53%

Channel	Frequency (MHz)	20dB Bandwidth (MHz)
00	2402	1.266
39	2441	1.266
78	2480	1.242

20 dB Bandwidth Plot on Channel 00

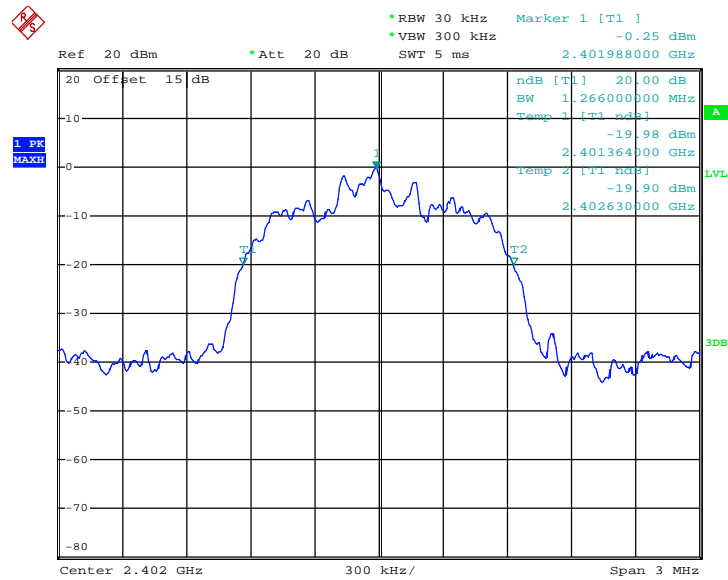

Date: 20.AUG.2015 21:14:34



20 dB Bandwidth Plot on Channel 39

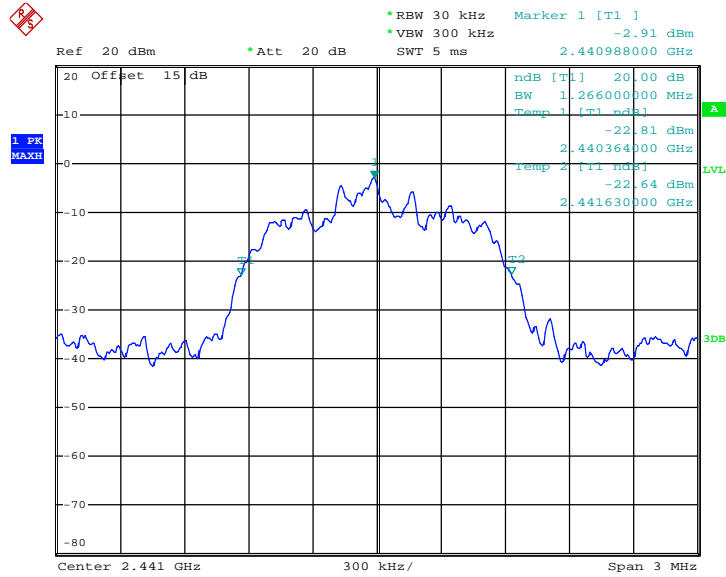

Date: 20.AUG.2015 21:15:27

20 dB Bandwidth Plot on Channel 78

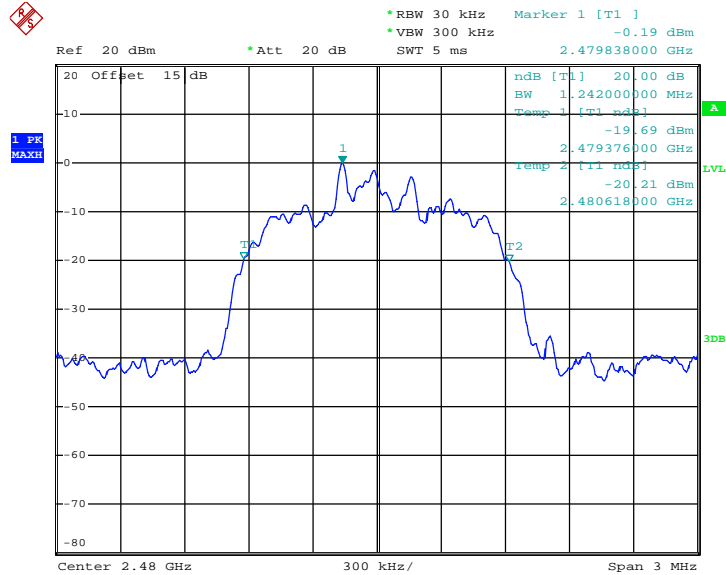

Date: 20.AUG.2015 21:16:22



Test Mode :	3Mbps	Temperature :	24~26°C
Test Engineer :	Sam Zheng	Relative Humidity :	50~53%

Channel	Frequency (MHz)	20dB Bandwidth (MHz)
00	2402	1.242
39	2441	1.242
78	2480	1.236

20 dB Bandwidth Plot on Channel 00

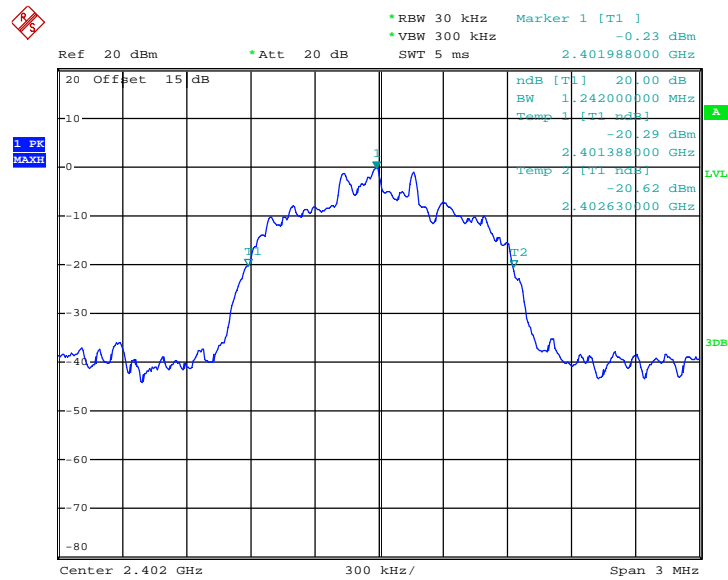

Date: 20.AUG.2015 21:16:46



20 dB Bandwidth Plot on Channel 39

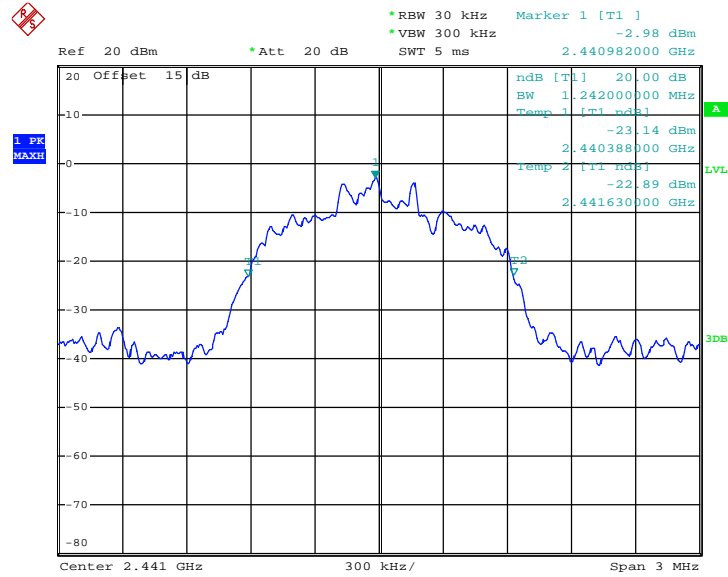

Date: 20.AUG.2015 21:17:06

20 dB Bandwidth Plot on Channel 78

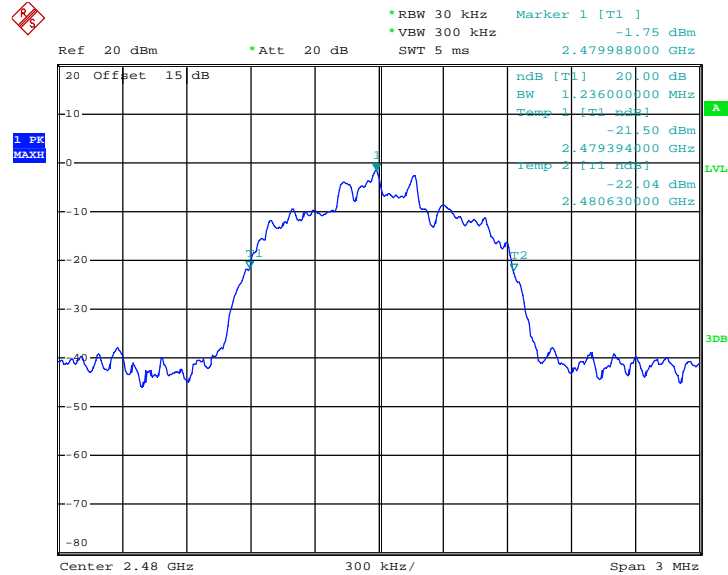

Date: 20.AUG.2015 21:17:26

3.5 Peak Output Power Measurement

3.5.1 Limit of Peak Output Power

Section 15.247 (b) The maximum peak conducted output power of the intentional radiator shall not exceed the following: (1) For frequency hopping systems operating in the 2400-2483.5 MHz band employing at least 75 non-overlapping hopping channels, and all frequency hopping systems in the 5725-5850 MHz band: 1 watt. For all other frequency hopping systems in the 2400-2483.5 MHz band 0.125 watts.

3.5.2 Measuring Instruments

The measuring equipment is listed in the section 4 of this test report.

3.5.3 Test Procedures

1. The testing follows FCC Public Notice DA 00-705 Measurement Guidelines.
2. The RF output of EUT was connected to the power meter by RF cable and attenuator. The path loss was compensated to the results for each measurement.
3. Set to the maximum power setting and enable the EUT transmit continuously.
4. Measure the conducted output power with cable loss and record the results in the test report.
5. Measure and record the results in the test report.

3.5.4 Test Setup

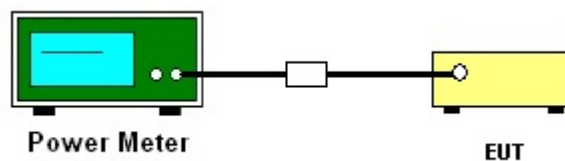



3.5.5 Test Result of Peak Output Power

Test Mode :	1Mbps	Temperature :	24~26°C
Test Engineer :	Sam Zheng	Relative Humidity :	50~53%

Channel	Frequency (MHz)	RF Power (dBm)		
		GFSK	Max. Limits (dBm)	Pass/Fail
		1 Mbps		
00	2402	3.91	20.97	Pass
39	2441	0.85	20.97	Pass
78	2480	2.30	20.97	Pass

Test Mode :	2Mbps	Temperature :	24~26°C
Test Engineer :	Sam Zheng	Relative Humidity :	50~53%

Channel	Frequency (MHz)	RF Power (dBm)		
		$\pi/4$ -DQPSK	Max. Limits (dBm)	Pass/Fail
		2 Mbps		
00	2402	3.08	20.97	Pass
39	2441	0.38	20.97	Pass
78	2480	1.54	20.97	Pass

Test Mode :	3Mbps	Temperature :	24~26°C
Test Engineer :	Sam Zheng	Relative Humidity :	50~53%

Channel	Frequency (MHz)	RF Power (dBm)		
		8-DPSK	Max. Limits (dBm)	Pass/Fail
		3 Mbps		
00	2402	3.32	20.97	Pass
39	2441	0.45	20.97	Pass
78	2480	1.73	20.97	Pass

3.6 Conducted Band Edges Measurement

3.6.1 Limit of Band Edges

In any 100 kHz bandwidth outside the intentional radiation frequency band, the radio frequency power shall be at least 20 dB below the highest level of the radiated power. In addition, radiated emissions which fall in the restricted bands must also comply with the radiated emission limits.

3.6.2 Measuring Instruments

The measuring equipment is listed in the section 4 of this test report.

3.6.3 Test Procedures

1. The testing follows the guidelines in Band-edge Compliance of RF Conducted Emissions of FCC Public Notice DA 00-705 Measurement Guidelines.
2. Set to the maximum power setting and enable the EUT transmit continuously.
3. Set RBW = 100kHz ($\geq 1\%$ span=10MHz), VBW = 300kHz (\geq RBW). Band edge emissions must be at least 20 dB down from the highest emission level within the authorized band as measured with a 100kHz RBW. The attenuation shall be 30 dB instead of 20 dB when RMS conducted output power procedure is used.
4. Enable hopping function of the EUT and then repeat step 2. and 3.
5. Measure and record the results in the test report.

3.6.4 Test Setup

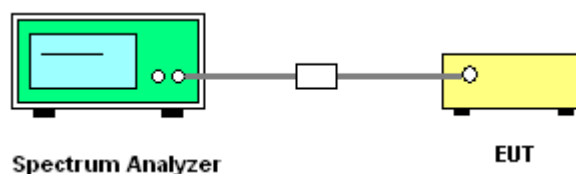



3.6.5 Test Result of Conducted Band Edges

Test Mode :	1Mbps	Temperature :	24~26°C
Test Channel :	00 and 78	Relative Humidity :	50~53%
		Test Engineer :	Sam Zheng

Low Band Edge Plot on Channel 00

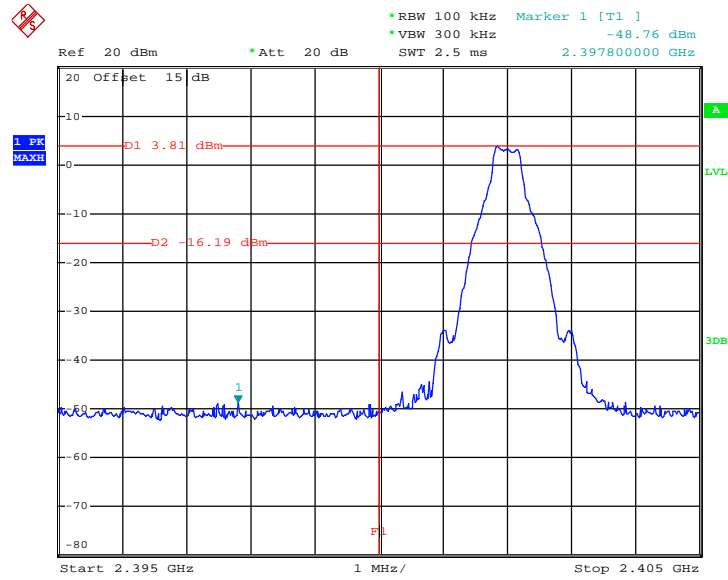

Date: 20.AUG.2015 21:32:41

High Band Edge Plot on Channel 78

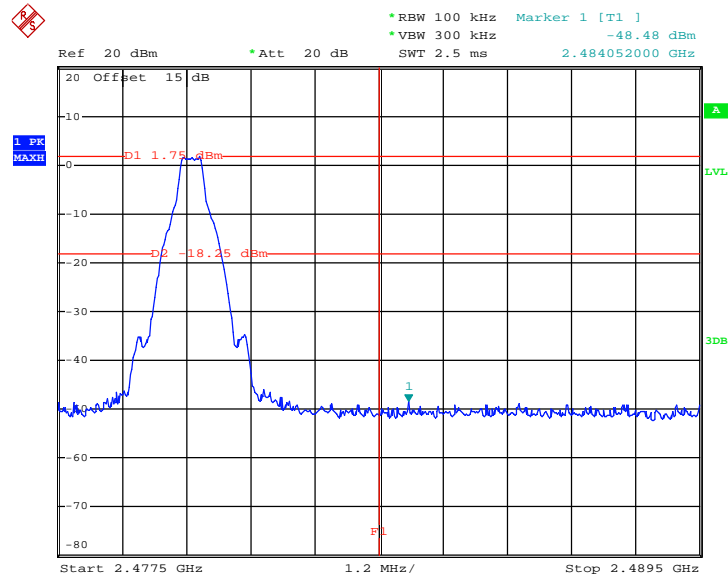

Date: 20.AUG.2015 21:36:18



Test Mode :	2Mbps	Temperature :	24~26°C
Test Channel :	00 and 78	Relative Humidity :	50~53%
		Test Engineer :	Sam Zheng

Low Band Edge Plot on Channel 00

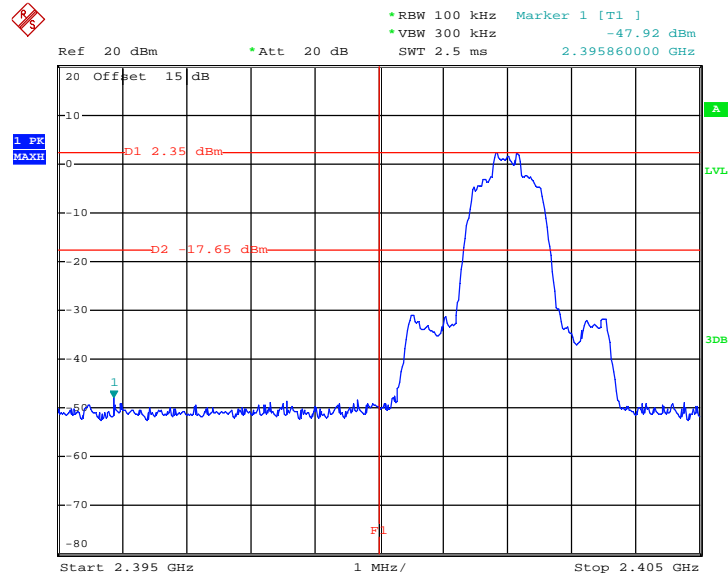

Date: 20.AUG.2015 21:47:20

High Band Edge Plot on Channel 78

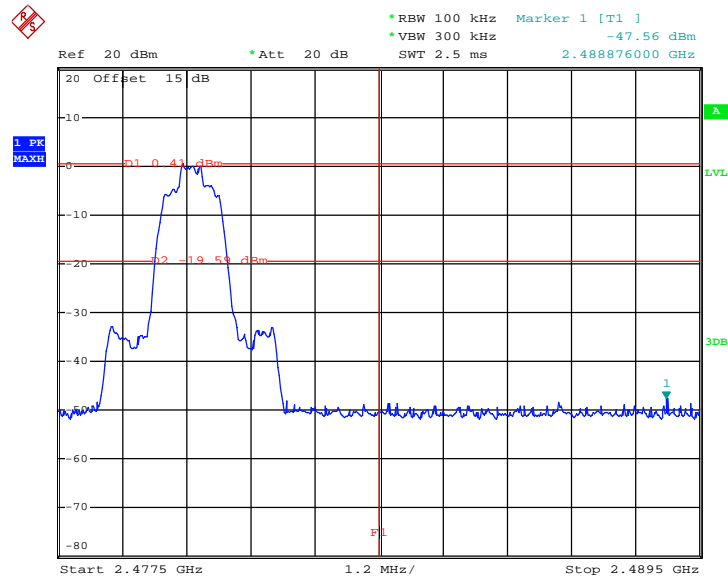

Date: 20.AUG.2015 21:52:20



Test Mode :	3Mbps	Temperature :	24~26°C
Test Channel :	00 and 78	Relative Humidity :	50~53%
		Test Engineer :	Sam Zheng

Low Band Edge Plot on Channel 00

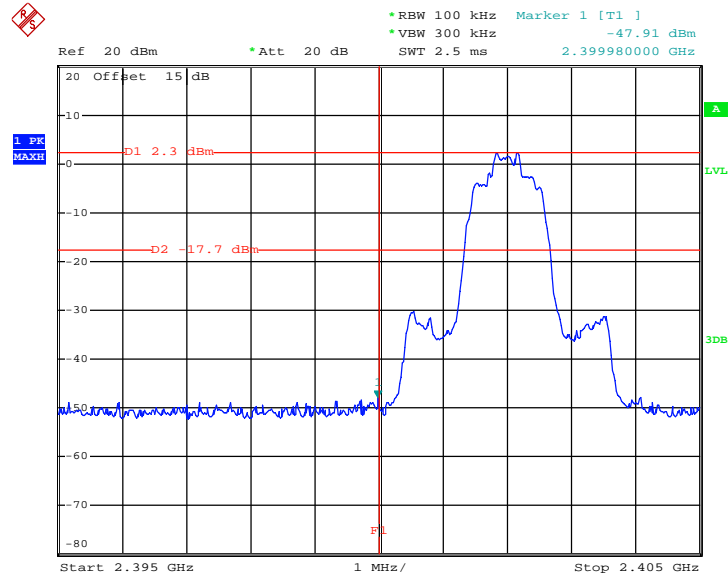

Date: 20.AUG.2015 22:09:07

High Band Edge Plot on Channel 78

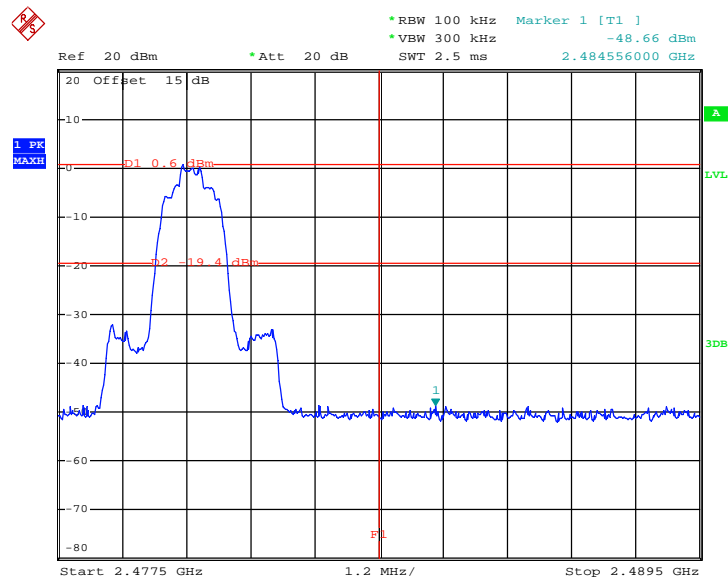

Date: 20.AUG.2015 22:15:10



3.6.6 Test Result of Conducted Hopping Mode Band Edges

Test Mode :	1Mbps	Temperature :	24~26°C
Test Engineer :	Sam Zheng	Relative Humidity :	50~53%

1Mbps Hopping Mode Low Band Edge Plot

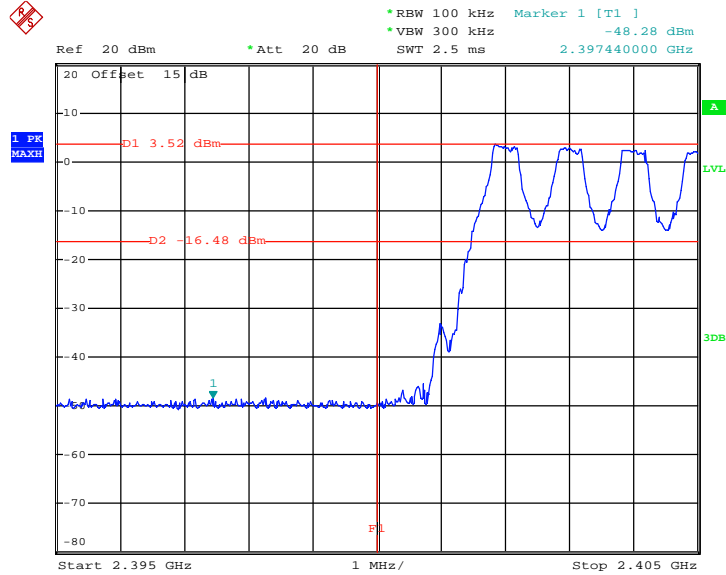

Date: 20.AUG.2015 21:35:54

1Mbps Hopping Mode High Band Edge Plot

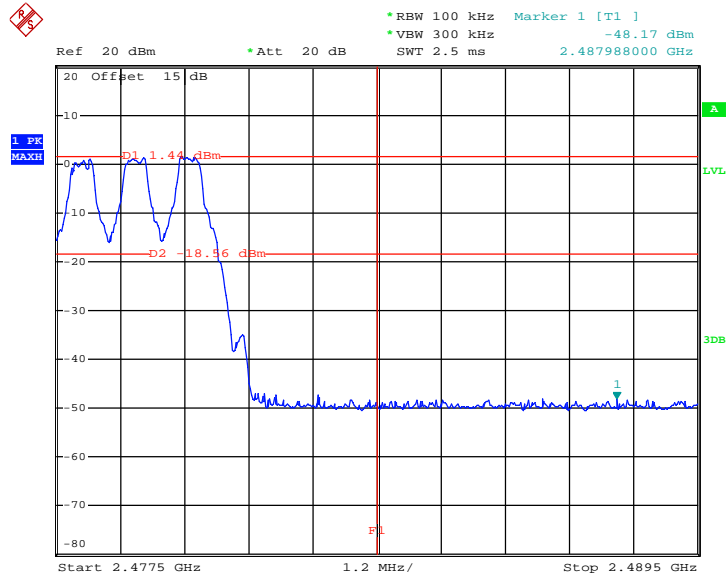

Date: 20.AUG.2015 21:39:43



Test Mode :	2Mbps	Temperature :	24~26°C
Test Engineer :	Sam Zheng	Relative Humidity :	50~53%

2Mbps Hopping Mode Low Band Edge Plot

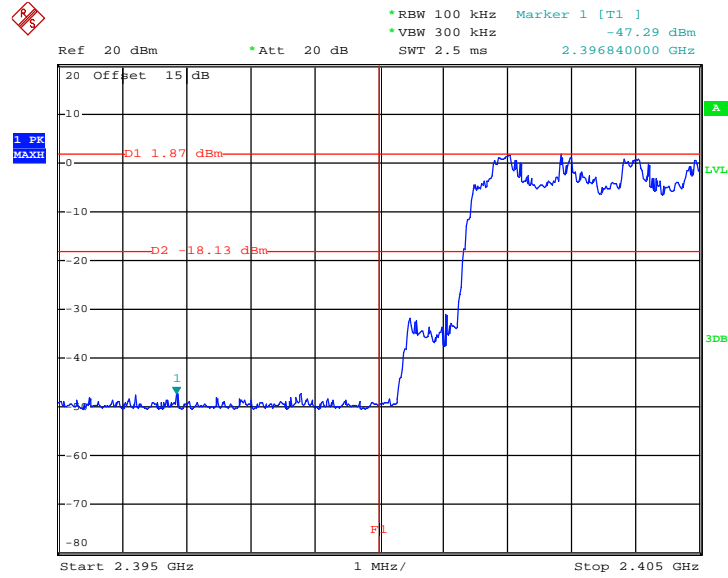

Date: 20.AUG.2015 21:51:56

2Mbps Hopping Mode High Band Edge Plot

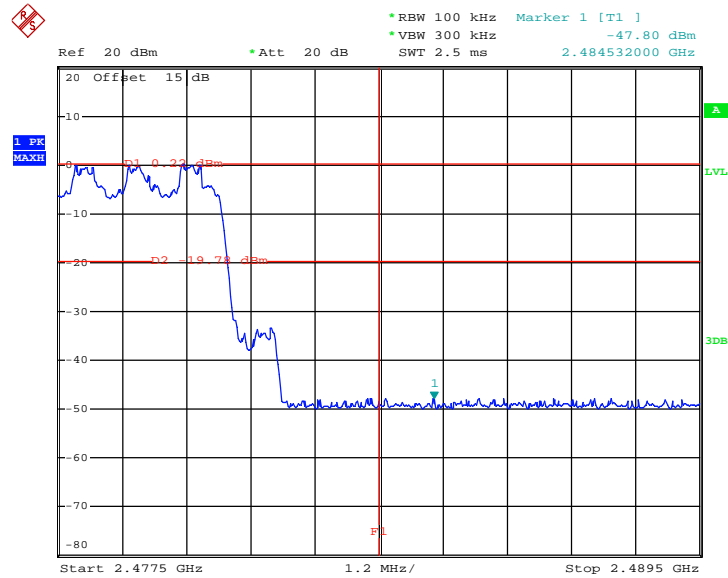

Date: 20.AUG.2015 21:59:43



Test Mode :	3Mbps	Temperature :	24~26°C
Test Engineer :	Sam Zheng	Relative Humidity :	50~53%

3Mbps Hopping Mode Low Band Edge Plot

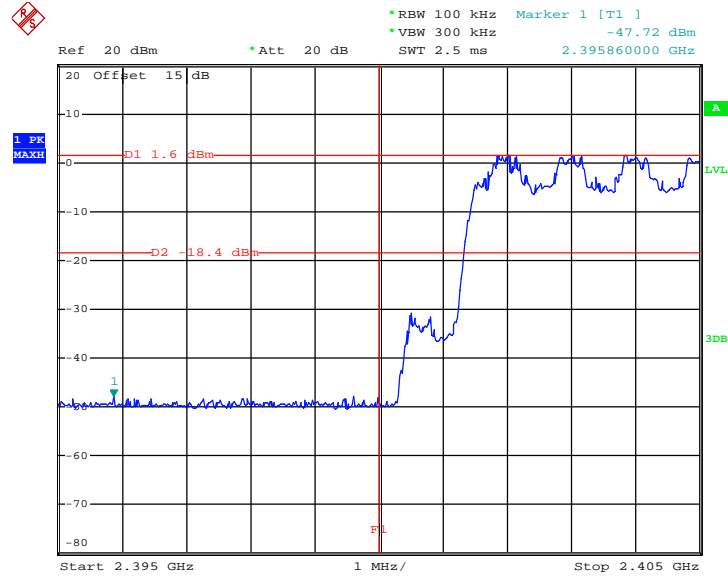

Date: 20.AUG.2015 22:14:47

3Mbps Hopping Mode High Band Edge Plot

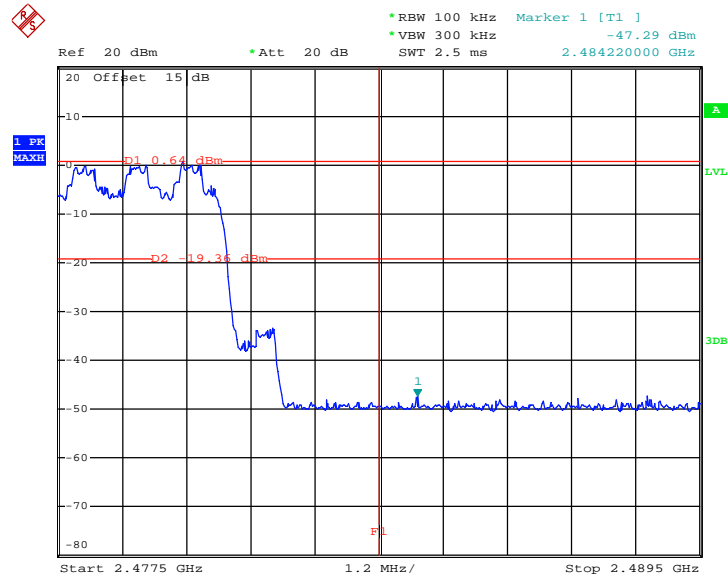

Date: 20.AUG.2015 22:18:44

3.7 Conducted Spurious Emission Measurement

3.7.1 Limit of Spurious Emission Measurement

In any 100 kHz bandwidth outside the intentional radiation frequency band, the radio frequency power shall be at least 20 dB below the highest level of the radiated power. In addition, radiated emissions which fall in the restricted bands must also comply with the radiated emission limits.

3.7.2 Measuring Instruments

The measuring equipment is listed in the section 4 of this test report.

3.7.3 Test Procedure

1. The testing follows the guidelines in Spurious RF Conducted Emissions of FCC Public Notice DA 00-705 Measurement Guidelines
2. The RF output of EUT was connected to the spectrum analyzer by RF cable and attenuator. The path loss was compensated to the results for each measurement.
3. Set to the maximum power setting and enable the EUT transmit continuously.
4. Set RBW = 100 kHz, VBW = 300kHz, scan up through 10th harmonic. All harmonics / spurs must be at least 20 dB down from the highest emission level within the authorized band as measured with a 100 kHz RBW.
5. Measure and record the results in the test report.
6. The RF fundamental frequency should be excluded against the limit line in the operating frequency band.

3.7.4 Test Setup

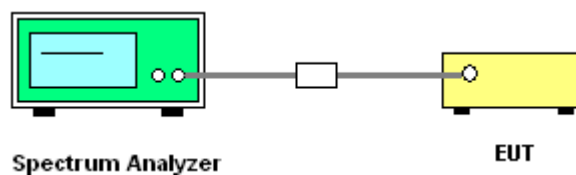



3.7.5 Test Result of Conducted Spurious Emission

Test Mode :	1Mbps	Temperature :	24~26°C
Test Channel :	00	Relative Humidity :	50~53%
		Test Engineer :	Sam Zheng

1Mbps CSE Plot on Ch 00 between 30MHz ~ 3 GHz

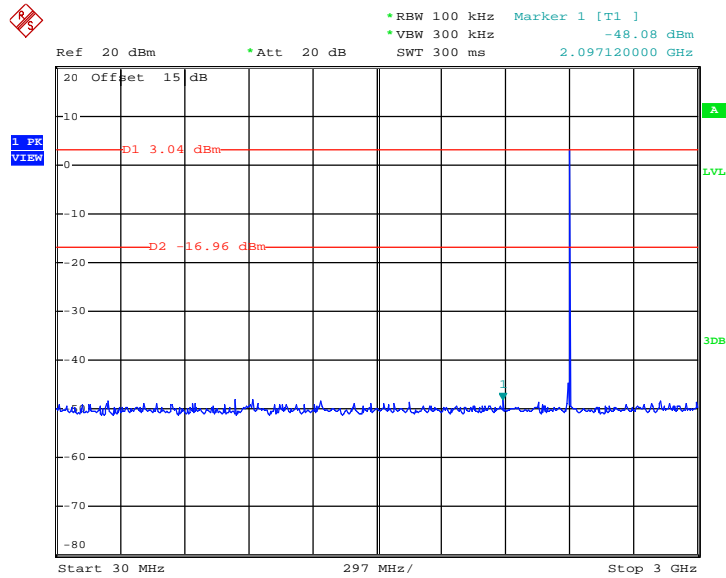

Date: 20.AUG.2015 21:42:07

1Mbps CSE Plot on Ch 00 between 2 GHz ~ 25 GHz

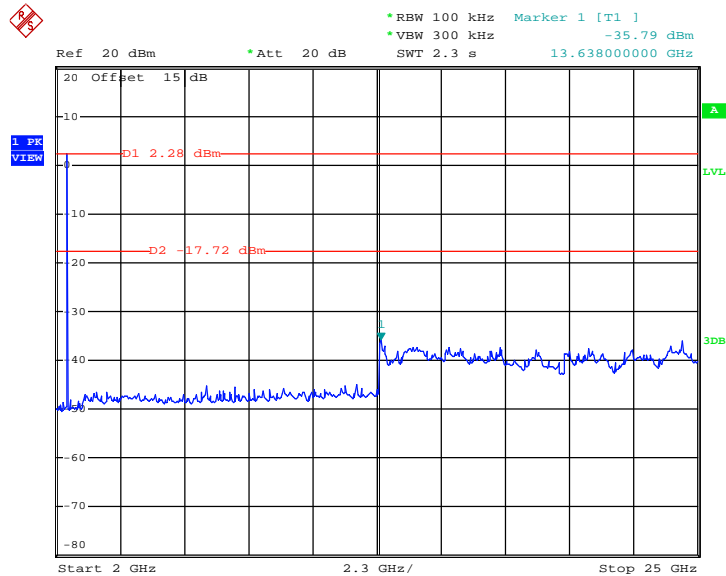

Date: 20.AUG.2015 21:42:29



Test Mode :	1Mbps	Temperature :	24~26°C
Test Channel :	39	Relative Humidity :	50~53%
		Test Engineer :	Sam Zheng

1Mbps CSE Plot on Ch 39 between 30MHz ~ 3 GHz

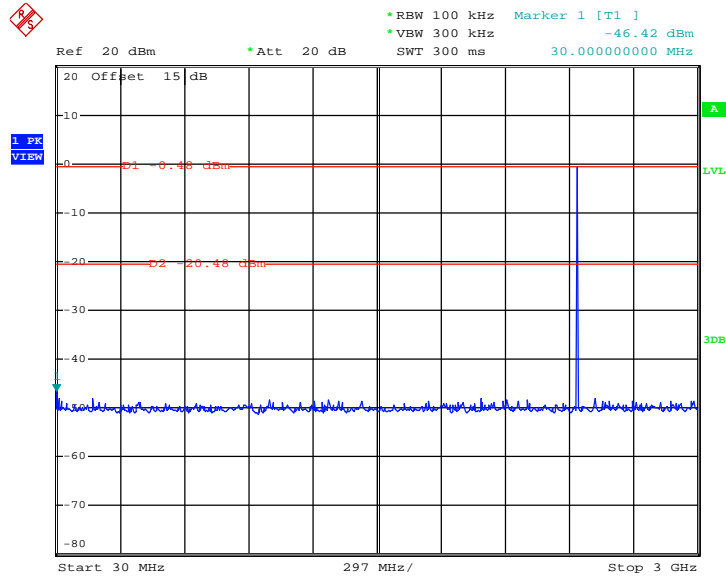

Date: 20.AUG.2015 21:45:36

1Mbps CSE Plot on Ch 39 between 2 GHz ~ 25 GHz

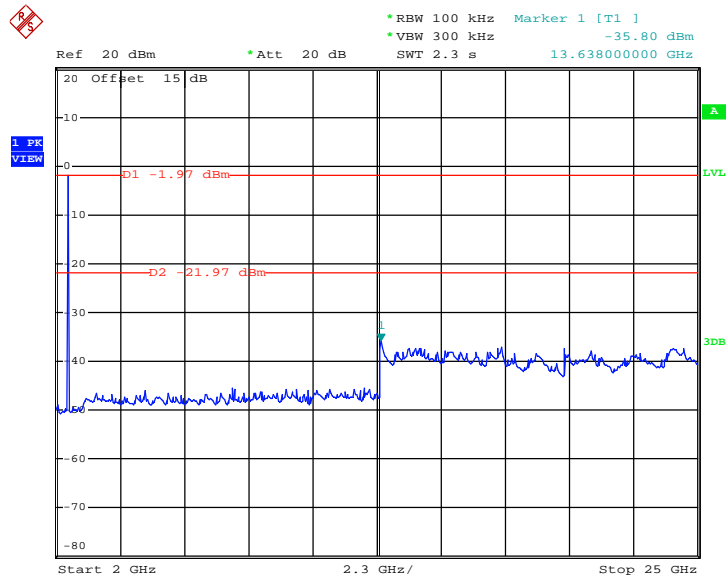

Date: 20.AUG.2015 21:45:57



Test Mode :	1Mbps	Temperature :	24~26°C
Test Channel :	78	Relative Humidity :	50~53%
		Test Engineer :	Sam Zheng

1Mbps CSE Plot on Ch 78 between 30MHz ~ 3 GHz

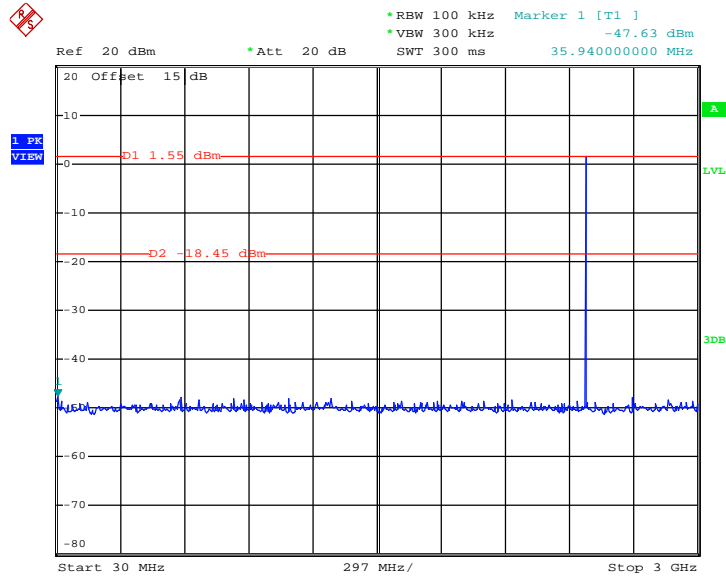

Date: 20.AUG.2015 21:46:28

1Mbps CSE Plot on Ch 78 between 2 GHz ~ 25 GHz

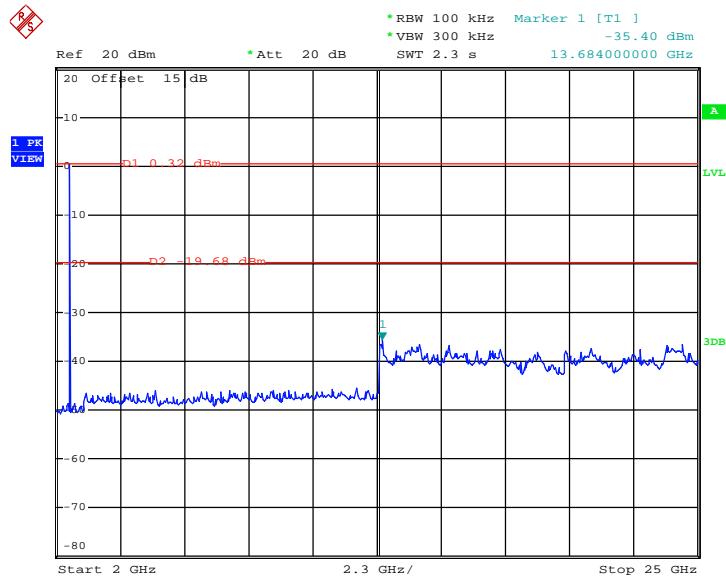

Date: 20.AUG.2015 21:46:50



Test Mode :	2Mbps	Temperature :	24~26°C
Test Channel :	00	Relative Humidity :	50~53%
		Test Engineer :	Sam Zheng

2Mbps CSE Plot on Ch 00 between 30MHz ~ 3 GHz

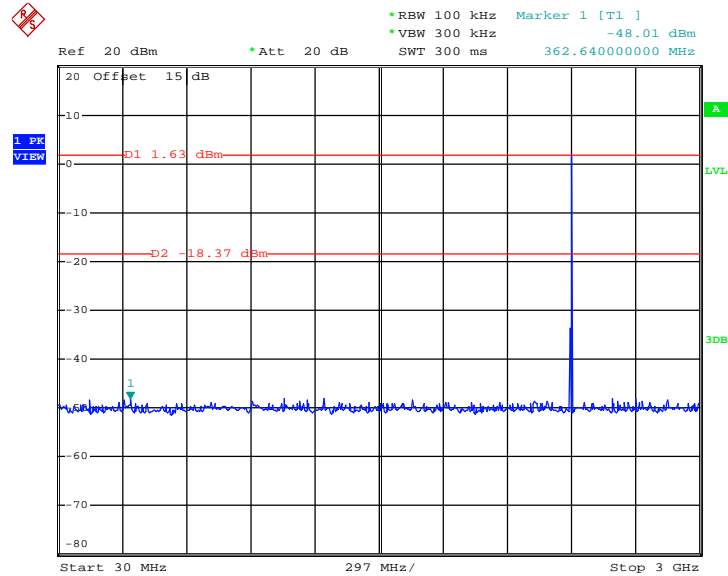

Date: 20.AUG.2015 22:04:41

2Mbps CSE Plot on Ch 00 between 2 GHz ~ 25 GHz

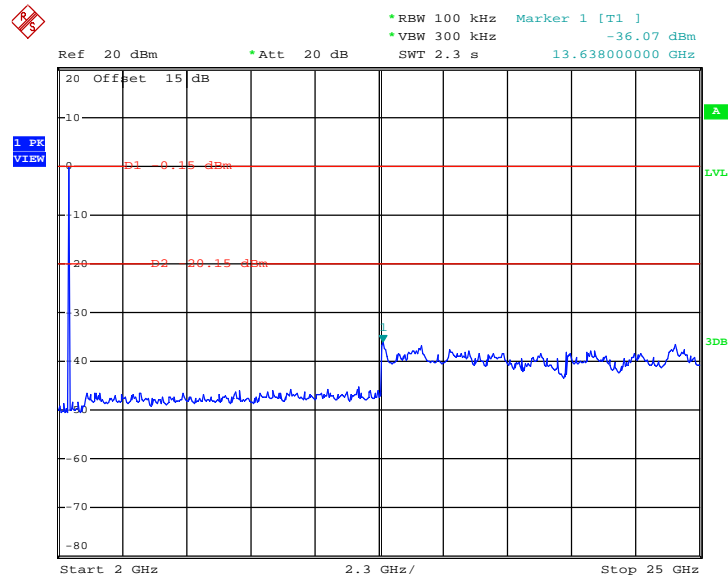

Date: 20.AUG.2015 22:05:02



Test Mode :	2Mbps	Temperature :	24~26°C
Test Channel :	39	Relative Humidity :	50~53%
		Test Engineer :	Sam Zheng

2Mbps CSE Plot on Ch 39 between 30MHz ~ 3 GHz

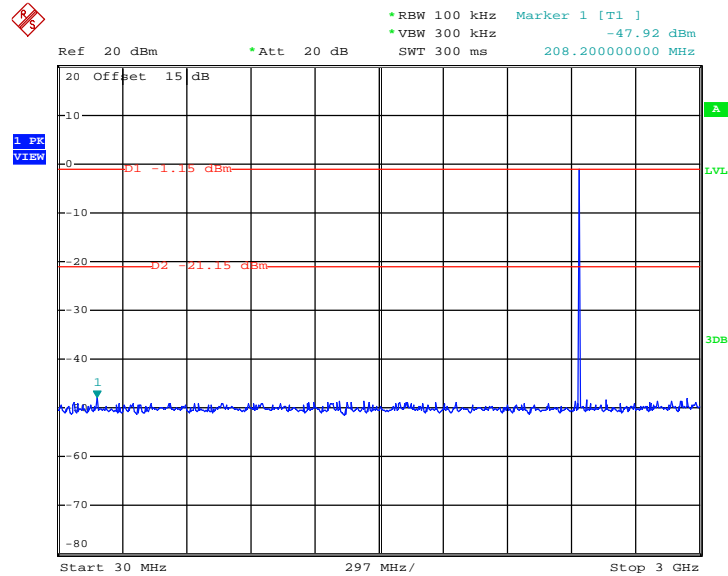

Date: 20.AUG.2015 22:06:25

2Mbps CSE Plot on Ch 39 between 2 GHz ~ 25 GHz

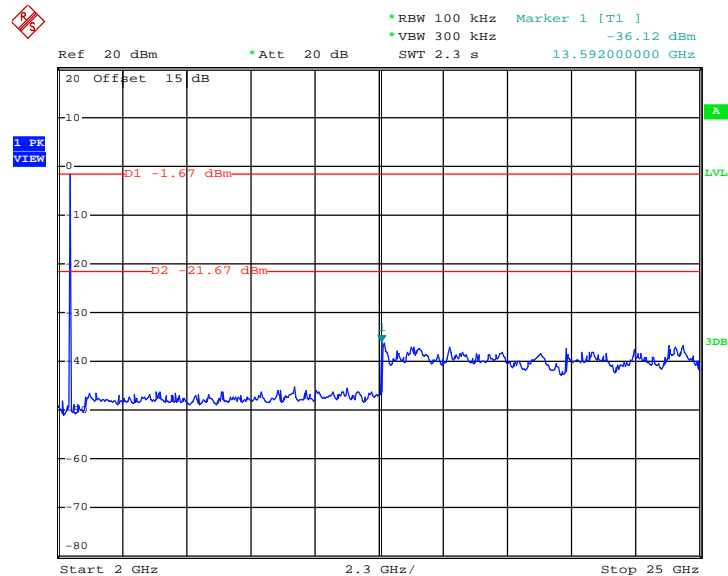

Date: 20.AUG.2015 22:06:47



Test Mode :	2Mbps	Temperature :	24~26°C
Test Channel :	78	Relative Humidity :	50~53%
		Test Engineer :	Sam Zheng

2Mbps CSE Plot on Ch 78 between 30MHz ~ 3 GHz

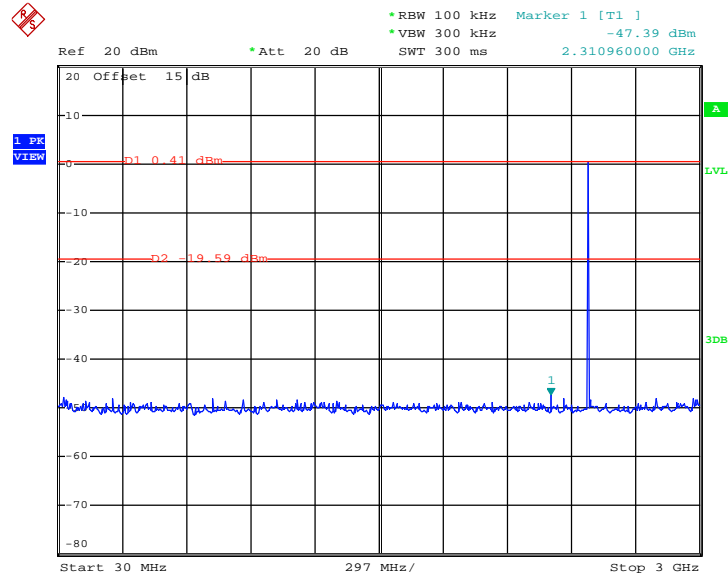

Date: 20.AUG.2015 22:07:19

2Mbps CSE Plot on Ch 78 between 2 GHz ~ 25 GHz

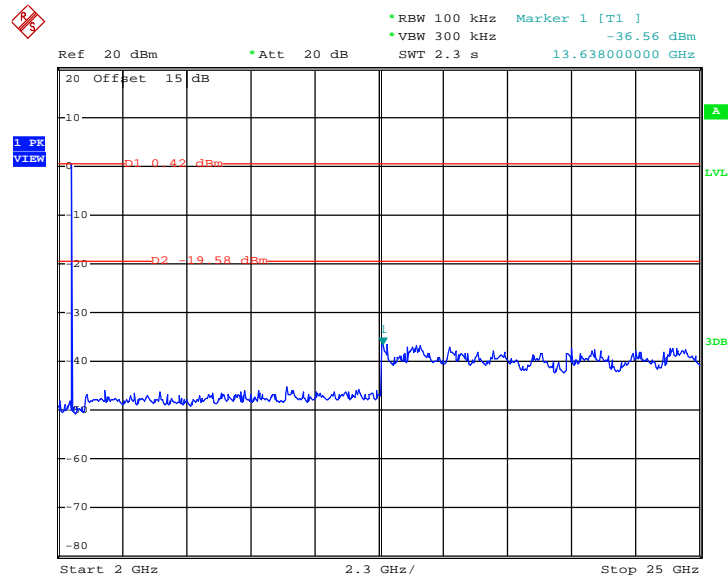

Date: 20.AUG.2015 22:07:41



Test Mode :	3Mbps	Temperature :	24~26°C
Test Channel :	00	Relative Humidity :	50~53%
		Test Engineer :	Sam Zheng

3Mbps CSE Plot on Ch 00 between 30MHz ~ 3 GHz

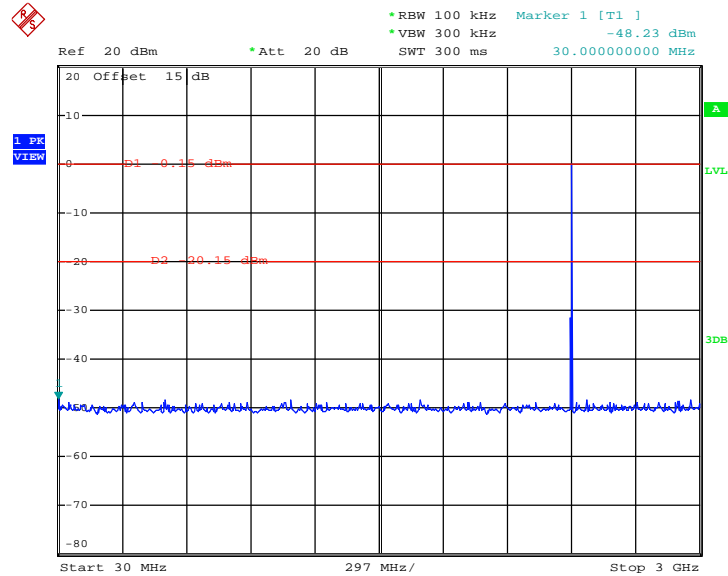

Date: 20.AUG.2015 22:22:23

3Mbps CSE Plot on Ch 00 between 2 GHz ~ 25 GHz

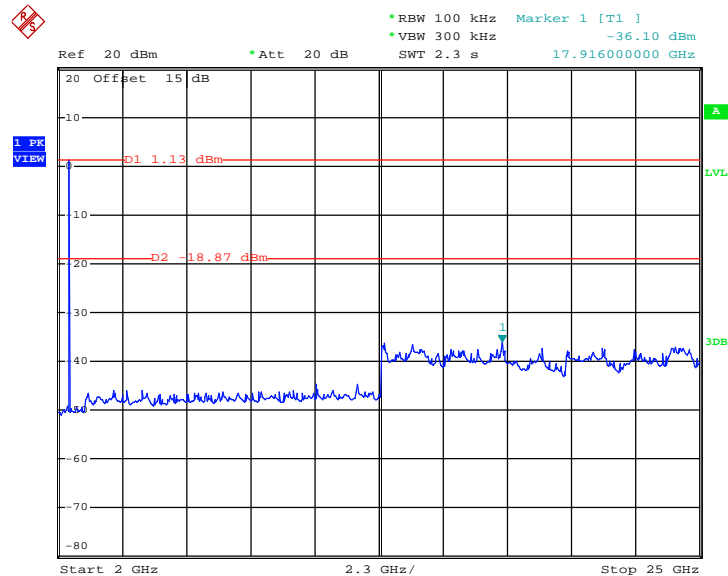

Date: 20.AUG.2015 22:22:45



Test Mode :	3Mbps	Temperature :	24~26°C
Test Channel :	39	Relative Humidity :	50~53%
		Test Engineer :	Sam Zheng

3Mbps CSE Plot on Ch 39 between 30MHz ~ 3 GHz

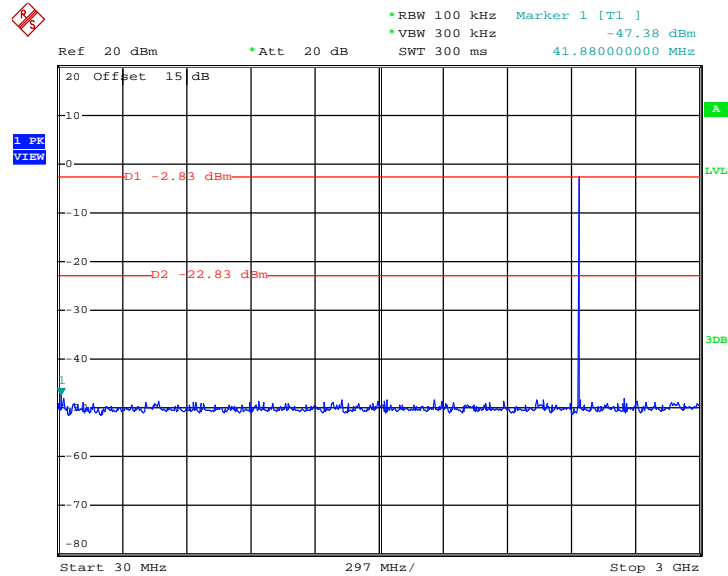

Date: 20.AUG.2015 22:37:08

3Mbps CSE Plot on Ch 39 between 2 GHz ~ 25 GHz

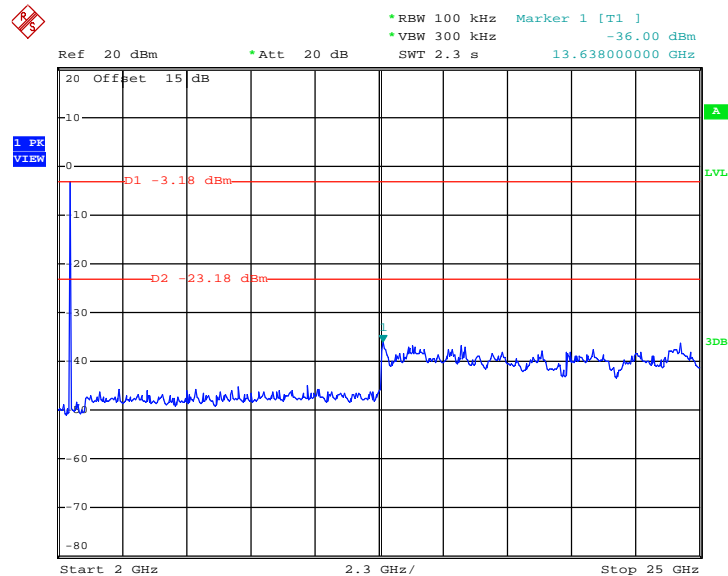

Date: 20.AUG.2015 22:37:29



Test Mode :	3Mbps	Temperature :	24~26°C
Test Channel :	78	Relative Humidity :	50~53%
		Test Engineer :	Sam Zheng

3Mbps CSE Plot on Ch 78 between 30MHz ~ 3 GHz

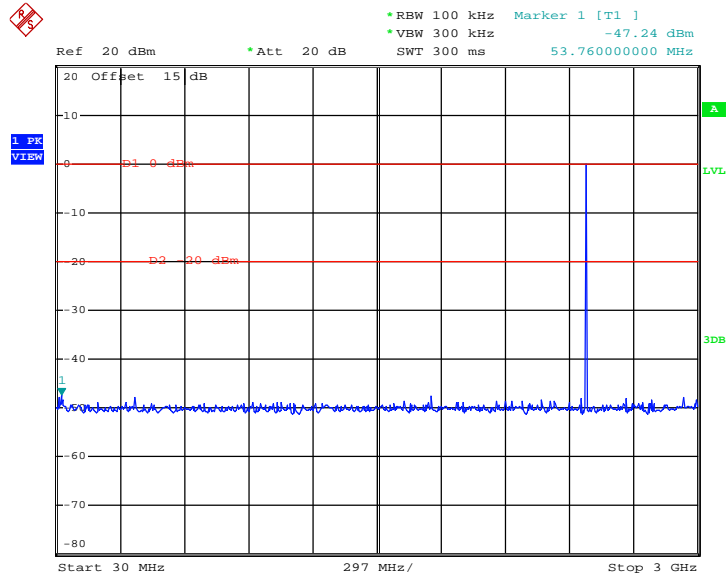

Date: 20.AUG.2015 22:34:42

3Mbps CSE Plot on Ch 78 between 2 GHz ~ 25 GHz

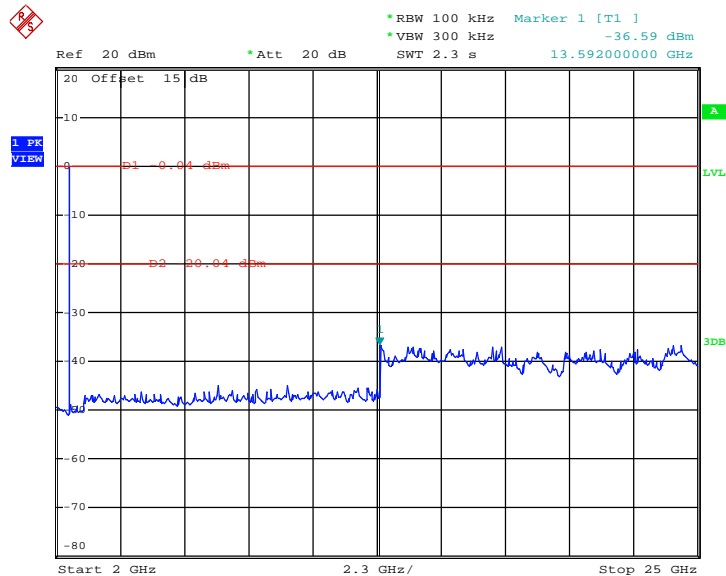

Date: 20.AUG.2015 22:35:04



3.8 Radiated Band Edges and Spurious Emission Measurement

3.8.1 Limit of Radiated Band Edges and Spurious Emission

In any 100 kHz bandwidth outside the intentional radiator frequency band, all harmonics/spurious must be at least 20 dB below the highest emission level within the authorized band. In addition, radiated emissions which fall in the restricted bands must also comply with the FCC section 15.209 limits as below.

Frequency (MHz)	Field Strength (microvolts/meter)	Measurement Distance (meters)
0.009 – 0.490	2400/F(kHz)	300
0.490 – 1.705	24000/F(kHz)	30
1.705 – 30.0	30	30
30 – 88	100	3
88 – 216	150	3
216 - 960	200	3
Above 960	500	3

3.8.2 Measuring Instruments

The measuring equipment is listed in the section 4 of this test report.



3.8.3 Test Procedures

1. The testing follows the guidelines in Spurious Radiated Emissions of FCC Public Notice DA 00-705 Measurement Guidelines.
2. The EUT was placed on a turntable with 0.8 meter for frequency below 1GHz and 1.5 meter for frequency above 1GHz respectively above ground.
3. The EUT was set 3 meters from the interference receiving antenna, which was mounted on the top of a variable height antenna tower.
4. For each suspected emission, the EUT was arranged to its worst case and then tune the Antenna tower (from 1 m to 4 m) and turntable (from 0 degree to 360 degrees) to find the maximum reading. A pre-amp and a high pass filter are used for the test in order to get better signal level to comply with the guidelines.
5. Set to the maximum power setting and enable the EUT transmit continuously.
6. Use the following spectrum analyzer settings:
 - (1) Span shall wide enough to fully capture the emission being measured;
 - (2) Set RBW=100 kHz for $f < 1 \text{ GHz}$, RBW=1MHz for $f > 1\text{GHz}$; VBW \geq RBW; Sweep = auto; Detector function = peak; Trace = max hold for peak
 - (3) For average measurement: use duty cycle correction factor method per 15.35(c).
Duty cycle = On time/100 milliseconds
On time = $N_1 * L_1 + N_2 * L_2 + \dots + N_{n-1} * L_{n-1} + N_n * L_n$
Where N_1 is number of type 1 pulses, L_1 is length of type 1 pulses, etc.
Average Emission Level = Peak Emission Level + $20 * \log(\text{Duty cycle})$
7. Corrected Reading: Antenna Factor + Cable Loss + Read Level - Preamp Factor = Level

Note: The average levels were calculated from the peak level corrected with duty cycle correction factor (-24.82dB) derived from $20 \log(\text{dwell time}/100\text{ms})$. This correction is only for signals that hop with the fundamental signal, such as band-edge and harmonic. Other spurious signals that are independent of the hopping signal would not use this correction.

3.8.4 Test Setup

For radiated emissions below 30MHz

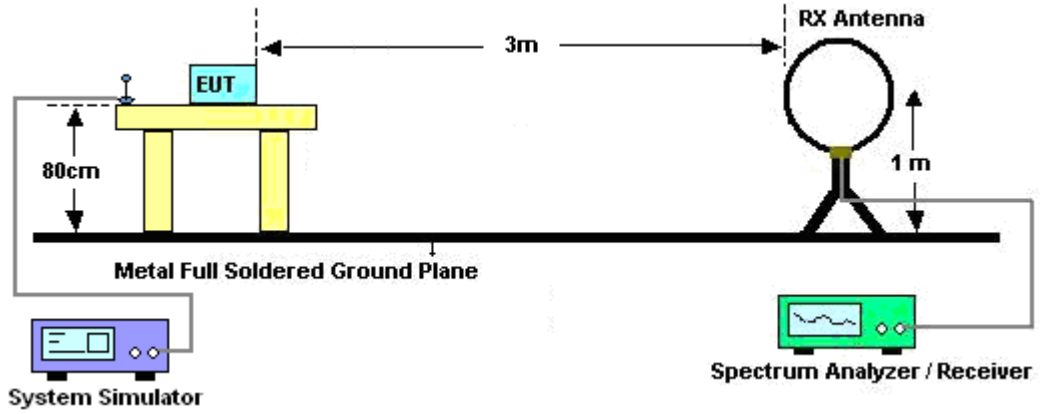

For radiated emissions from 30MHz to 1GHz

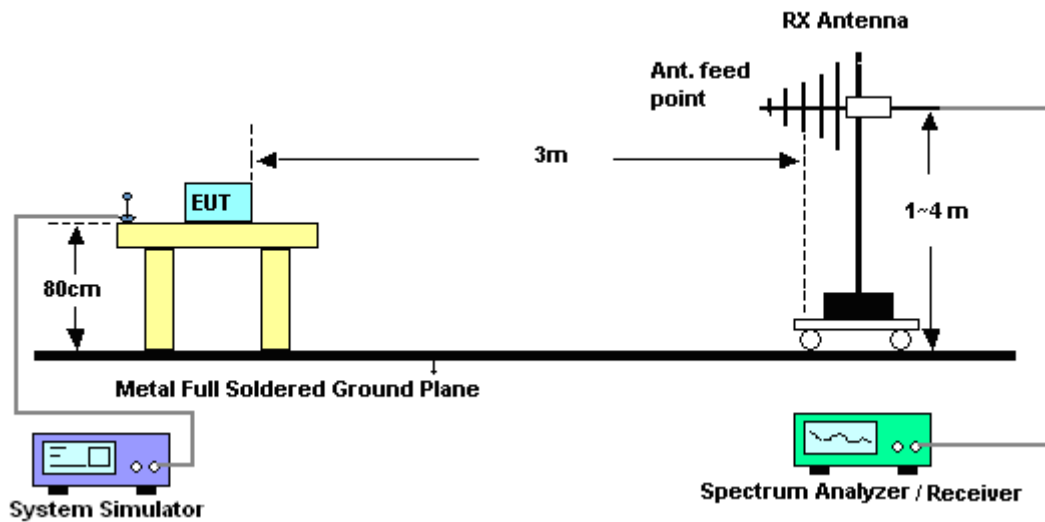

For radiated emissions above 1GHz

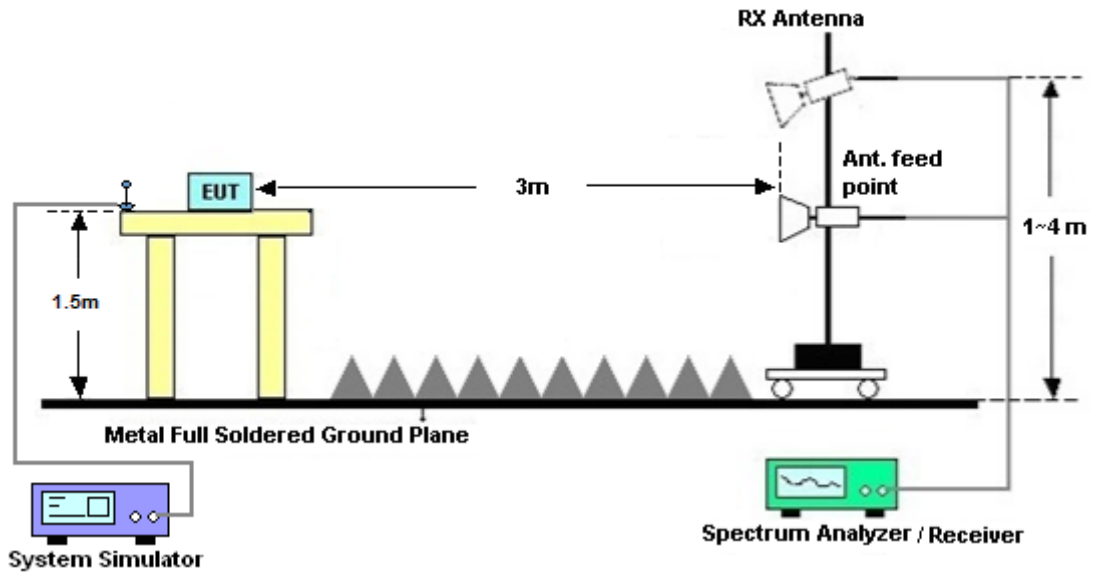

3.8.5 Test Results of Radiated Spurious Emissions (9 kHz ~ 30 MHz)

The low frequency, which started from 9 kHz to 30MHz, was pre-scanned and the result which was 20dB lower than the limit line per 15.31(o) was not reported.



3.8.6 Duty cycle correction factor for average measurement

DH5 on time (One Pulse) Plot on Channel 39

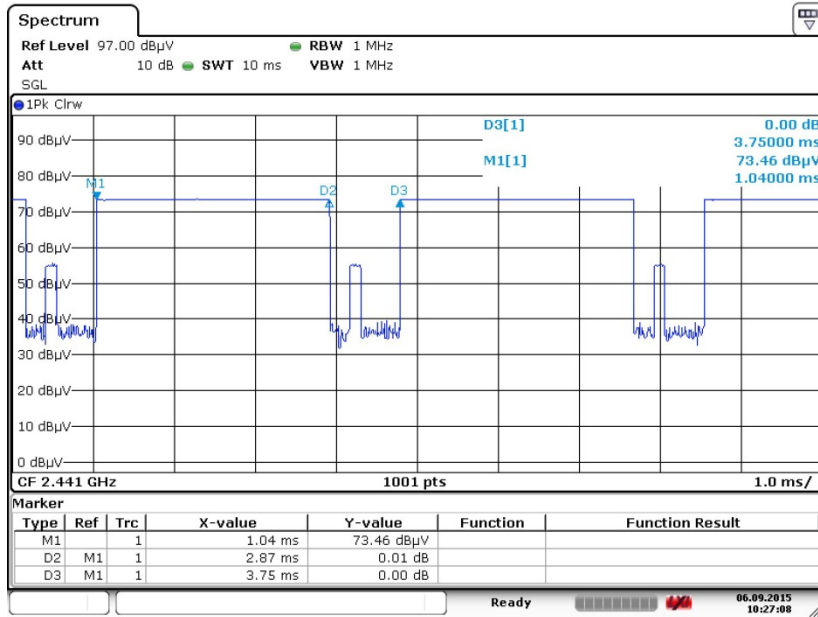

Date: 6.SEP.2015 10:27:08

DH5 on time (Count Pulses) Plot on Channel 39

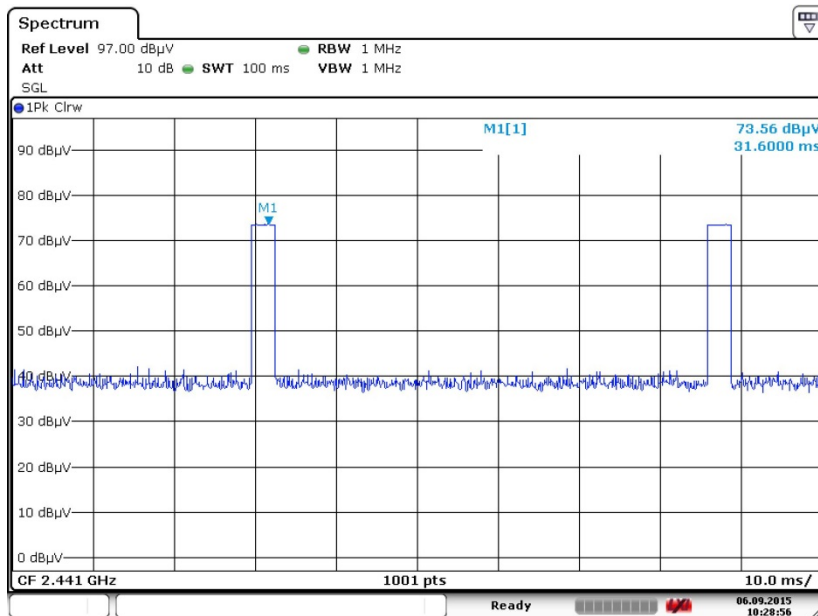

Date: 6.SEP.2015 10:28:56

Note:

1. Worst case Duty cycle = on time/100 milliseconds = $2 * 2.87 / 100 = 5.74 \%$
2. Worst case Duty cycle correction factor = $20 * \log(\text{Duty cycle}) = -24.82 \text{ dB}$
3. DH5 has the highest duty cycle worst case and is reported.



Duty Cycle Correction Factor Consideration for AFH mode:

Bluetooth normal hopping rate is 1600Hz and reduced to 800Hz in AFH mode; due to the reduced number of hopping frequencies, with the same packet configuration the dwell time in each channel frequency within 100msec period is longer in AFH mode than normal mode.

In AFH mode, the minimum hopping frequencies are 20, to get the longest dwell time DH5 packet is observed; the period to have DH5 packet completing one hopping sequence is

$$2.87 \text{ ms} \times 20 \text{ channels} = 57.4 \text{ ms}$$

There cannot be 2 complete hopping sequences within 100ms period, considering the random hopping behavior, maximum 2 hops can be possibly observed within the period. $[100\text{ms} / 57.4\text{ms}] = 2 \text{ hops}$

Thus, the maximum possible ON time:

$$2.87 \text{ ms} \times 2 = 5.74 \text{ ms}$$

Worst case Duty Cycle Correction factor, which is derived from the maximum possible ON time,

$$20 \times \log(5.74 \text{ ms}/100\text{ms}) = -24.82 \text{ dB}$$

3.8.7 Test Result of Radiated Spurious at Band Edges

Please refer to Appendix A.

3.8.8 Test Result of Radiated Spurious Emission (30MHz ~ 10th Harmonic)

Please refer to Appendix A.

3.9 AC Conducted Emission Measurement

3.9.1 Limit of AC Conducted Emission

For equipment that is designed to be connected to the public utility (AC) power line, the radio frequency voltage that is conducted back onto the AC power line on any frequency or frequencies within the band 150 kHz to 30 MHz shall not exceed the limits in the following table.

Frequency of emission (MHz)	Conducted limit (dB μ V)	
	Quasi-peak	Average
0.15-0.5	66 to 56*	56 to 46*
0.5-5	56	46
5-30	60	50

*Decreases with the logarithm of the frequency.

3.9.2 Measuring Instruments

The measuring equipment is listed in the section 4 of this test report.

3.9.3 Test Procedures

1. The EUT was placed 0.4 meter from the conducting wall of the shielding room was kept at least 80 centimeters from any other grounded conducting surface.
2. Connect EUT to the power mains through a line impedance stabilization network (LISN).
3. All the support units are connecting to the other LISN.
4. The LISN provides 50 ohm coupling impedance for the measuring instrument.
5. The FCC states that a 50 ohm, 50 microhenry LISN should be used.
6. Both sides of AC line were checked for maximum conducted interference.
7. The frequency range from 150 kHz to 30 MHz was searched.
8. Set the test-receiver system to Peak Detect Function and specified bandwidth (IF Bandwidth = 9kHz) with Maximum Hold Mode. Then measurement is also conducted by Average Detector and Quasi-Peak Detector Function respectively.

3.9.4 Test Setup

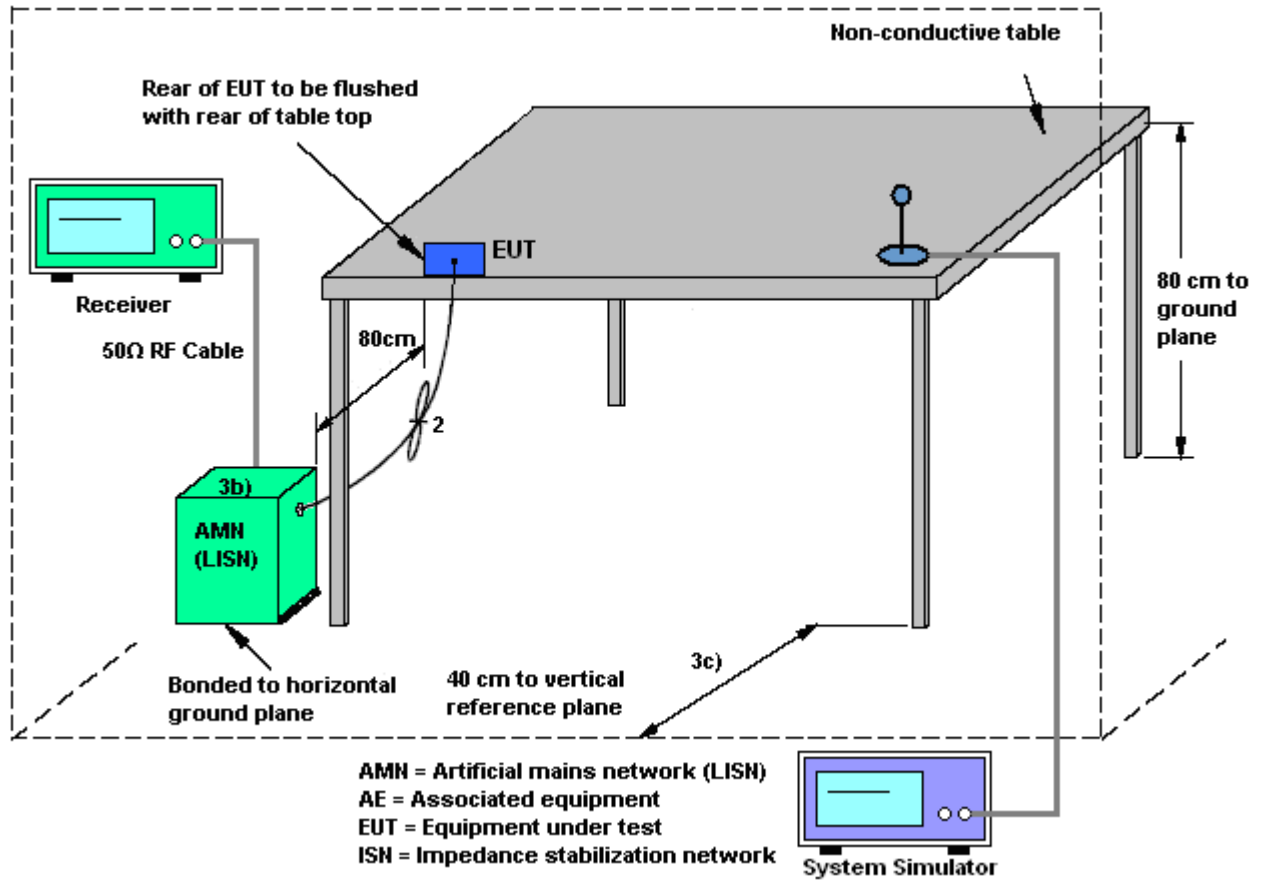



3.9.5 Test Result of AC Conducted Emission

Test Mode :	Mode 1	Temperature :	21~23°C
Test Engineer :	Jacky Yang	Relative Humidity :	41~43%
Test Voltage :	120Vac / 60Hz	Phase :	Line
Function Type :	GSM850 Idle + Bluetooth Link + WLAN Link + Earphone + USB Cable (Charging from Adapter)		

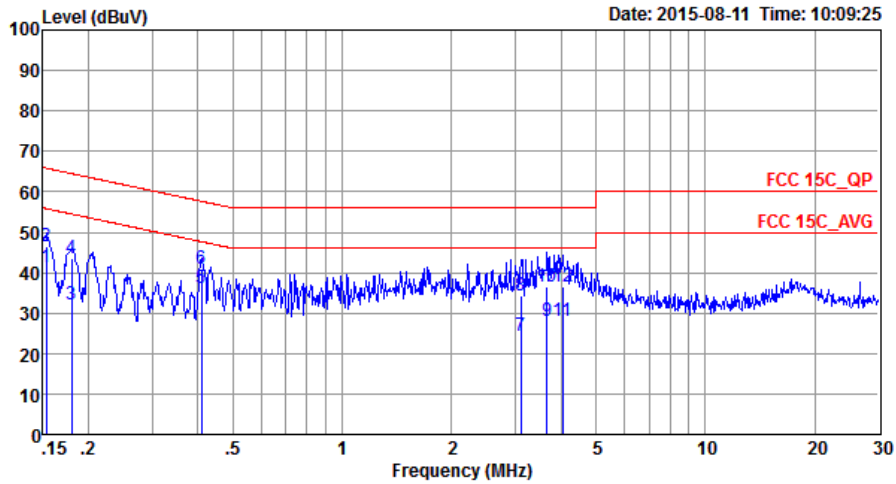

Site : CO01-SZ
 Condition: FCC 15C_QP LISN_L_20150304 LINE
 Mode : Mode 1

	Freq	Level	Over	Limit	Read	LISN	Cable	
	MHz	dBuV	Limit	Line	Level	Factor	Loss	Remark
			dB	dBuV	dBuV	dB	dB	
1	0.15	41.29	-14.53	55.82	30.49	0.44	10.36	Average
2	0.15	46.49	-19.33	65.82	35.69	0.44	10.36	QP
3	0.18	32.11	-22.39	54.50	21.30	0.49	10.32	Average
4	0.18	43.51	-20.99	64.50	32.70	0.49	10.32	QP
5 *	0.41	36.02	-11.62	47.64	25.30	0.55	10.17	Average
6	0.41	41.02	-16.62	57.64	30.30	0.55	10.17	QP
7	3.11	24.37	-21.63	46.00	13.61	0.55	10.21	Average
8	3.11	34.47	-21.53	56.00	23.71	0.55	10.21	QP
9	3.66	28.01	-17.99	46.00	17.20	0.59	10.22	Average
10	3.66	36.51	-19.49	56.00	25.70	0.59	10.22	QP
11	4.05	28.14	-17.86	46.00	17.30	0.61	10.23	Average
12	4.05	36.64	-19.36	56.00	25.80	0.61	10.23	QP



Test Mode :	Mode 1	Temperature :	21~23°C
Test Engineer :	Jacky Yang	Relative Humidity :	41~43%
Test Voltage :	120Vac / 60Hz	Phase :	Neutral
Function Type :	GSM850 Idle + Bluetooth Link + WLAN Link + Earphone + USB Cable (Charging from Adapter)		

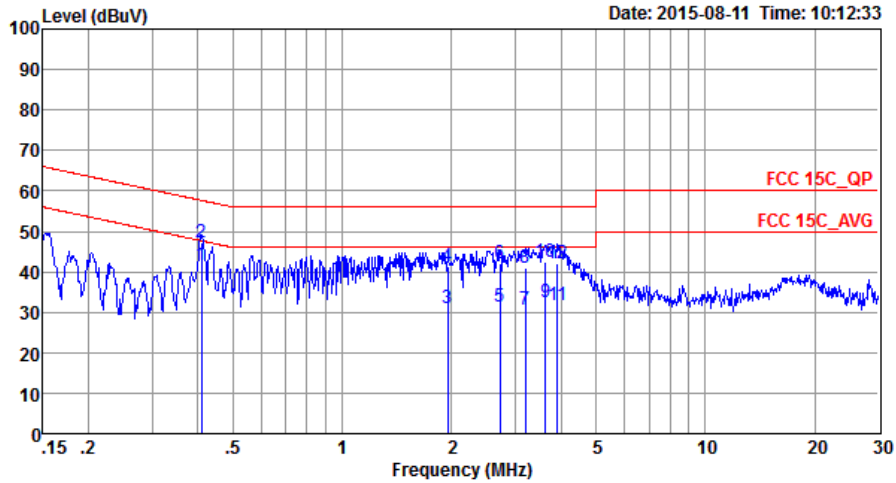

Site : C001-SZ
 Condition: FCC 15C_QP LISN_N_20150304 NEUTRAL
 Mode : Mode 1

	Freq	Level	Over Limit	Limit Line	Read Level	LISN Factor	Cable Loss	Remark
	MHz	dBuV	dB	dBuV	dBuV	dB	dB	
1 *	0.41	41.53	-6.11	47.64	30.80	0.56	10.17	Average
2	0.41	47.13	-10.51	57.64	36.40	0.56	10.17	QP
3	1.95	31.06	-14.94	46.00	20.30	0.57	10.19	Average
4	1.95	41.46	-14.54	56.00	30.70	0.57	10.19	QP
5	2.72	31.40	-14.60	46.00	20.59	0.60	10.21	Average
6	2.72	42.00	-14.00	56.00	31.19	0.60	10.21	QP
7	3.19	30.53	-15.47	46.00	19.71	0.61	10.21	Average
8	3.19	40.93	-15.07	56.00	30.11	0.61	10.21	QP
9	3.62	32.44	-13.56	46.00	21.60	0.62	10.22	Average
10	3.62	42.54	-13.46	56.00	31.70	0.62	10.22	QP
11	3.92	31.65	-14.35	46.00	20.79	0.63	10.23	Average
12	3.92	41.95	-14.05	56.00	31.09	0.63	10.23	QP



3.10 Antenna Requirements

3.10.1 Standard Applicable

If directional gain of transmitting antennas is greater than 6dBi, the power shall be reduced by the same level in dB comparing to gain minus 6dBi. The use of a permanently attached antenna or of an antenna that uses a unique coupling to the intentional radiator shall be considered sufficient to comply with the FCC rule.

3.10.2 Antenna Anti-Replacement Construction

An embedded-in antenna design is used.

3.10.3 Antenna Gain

The antenna peak gain of EUT is less than 6 dBi. Therefore, it is not necessary to reduce maximum peak output power limit.



4 List of Measuring Equipment

Instrument	Manufacturer	Model No.	Serial No.	Characteristics	Calibration Date	Test Date	Due Date	Remark
Spectrum Analyzer	R&S	FSP30	101400	9kHz~30GHz	Jan. 28, 2015	Aug. 18, 2015~ Aug. 20, 2015	Jan. 27, 2016	Conducted (TH01-SZ)
Spectrum Analyzer	R&S	FSV40	101078	9kHz~40GHz	May 05, 2015	Aug. 18, 2015~ Aug. 20, 2015	May 04, 2016	Conducted (TH01-SZ)
Pulse Power Sensor	Anritsu	MA2411B	1207253	30MHz~40GHz	Jan. 28, 2015	Aug. 18, 2015~ Aug. 20, 2015	Jan. 27, 2016	Conducted (TH01-SZ)
Power Meter	Anritsu	ML2495A	1218010	50MHz Bandwidth	Jan. 28, 2015	Aug. 18, 2015~ Aug. 20, 2015	Jan. 27, 2016	Conducted (TH01-SZ)
EMI Test Receiver	R&S	ESR7	101404	9kHz~7GHz; Max 30dBm	Oct. 14, 2014	Sep. 06, 2015	Oct. 13, 2015	Radiation (03CH02-SZ)
Spectrum Analyzer	R&S	FSV40	101041	10kHz~40GHz; Max 30dBm	Oct. 15, 2014	Sep. 06, 2015	Oct. 14, 2015	Radiation (03CH02-SZ)
Loop Antenna	R&S	HFH2-Z2	100354	9kHz~30MHz	May 06, 2015	Sep. 06, 2015	May 05, 2016	Radiation (03CH02-SZ)
Bilog Antenna	TeseQ	CBL6112D	23188	30MHz~2GHz	Nov. 07, 2014	Sep. 06, 2015	Nov. 06, 2015	Radiation (03CH02-SZ)
Double Ridge Horn Antenna	SCHWARZBE CK	BBHA 9120D	9120D-1285	1GHz~18GHz	Jan. 20, 2015	Sep. 06, 2015	Jan. 19, 2016	Radiation (03CH02-SZ)
SHF-EHF Horn	com-power	AH-840	101071	18GHz~40GHz	Sep. 03, 2015	Sep. 06, 2015	Sep. 02, 2016	Radiation (03CH02-SZ)
Amplifier	ADVANTEST	BB525C	E9007003	9kHz~3000MHz / 30 dB	Jan. 28, 2015	Sep. 06, 2015	Jan. 27, 2016	Radiation (03CH02-SZ)
Amplifier	Agilent	8449B	3008A01023	1GHz~26.5GHz	Oct. 29, 2014	Sep. 06, 2015	Oct. 28, 2015	Radiation (03CH02-SZ)
AC Power Source	Chroma	61601	6160100024 70	N/A	NCR	Sep. 06, 2015	NCR	Radiation (03CH02-SZ)
Turn Table	Chaintek	T-200	N/A	0~360 degree	NCR	Sep. 06, 2015	NCR	Radiation (03CH02-SZ)
Antenna Mast	Chaintek	MBS-400	N/A	1 m~4 m	NCR	Sep. 06, 2015	NCR	Radiation (03CH02-SZ)
EMI Receiver	R&S	ESC17	100724	9kHz~3GHz;	Jan. 28, 2015	Aug. 11, 2015	Jan. 27, 2016	Conduction (CO01-SZ)
AC LISN	EMCO	3816/2SH	103892	9kHz~30MHz	Feb. 02, 2015	Aug. 11, 2015	Feb. 01, 2016	Conduction (CO01-SZ)
AC LISN (for auxiliary equipment)	MessTec	AN3016	16850	9kHz~30MHz	Feb. 02, 2015	Aug. 11, 2015	Feb. 01, 2016	Conduction (CO01-SZ)
AC Power Source	Chroma	61602	6160200008 91	100Vac~250Vac	Sep. 29, 2014	Aug. 11, 2015	Sep. 28, 2015	Conduction (CO01-SZ)
Pulse Limiter	COM-POWER	LIT-153 Transient Limiter	53139	150kHz~30MHz	Oct. 24, 2014	Aug. 11, 2015	Oct. 23, 2015	Conduction (CO01-SZ)



5 Uncertainty of Evaluation

Uncertainty of Conducted Emission Measurement (150 kHz ~ 30 MHz)

Measuring Uncertainty for a Level of Confidence of 95% ($U = 2Uc(y)$)	2.3dB
---	-------

Uncertainty of Radiated Emission Measurement (30 MHz ~ 1000 MHz)

Measuring Uncertainty for a Level of Confidence of 95% ($U = 2Uc(y)$)	4.5dB
---	-------



Appendix A. Radiated Test Results

15C 2.4GHz 2400~2483.5MHz

BT (Band Edge @ 3m)

BT	Note	Frequency	Level	Over	Limit	Read	Antenna	Cable	Preamp	Ant	Table	Peak	Pol.
		(MHz)	(dBμV/m)	(dB)	(dBμV/m)	(dBμV)	(dB/m)	(dB)	(dB)	(cm)	(deg)	(P/A)	(H/V)
BT CH00 2402MHz		2364.08	41.49	-32.51	74	42.35	27.13	9.2	37.19	238	316	P	H
		2364.08	16.67	-37.33	54	-	-	-	-	238	316	A	H
	*	2402	74.56	-	-	75.22	27.25	9.32	37.23	238	316	P	H
	*	2402	49.74	-	-	-	-	-	-	238	316	A	H
		2382.15	41.78	-32.22	74	42.48	27.19	9.32	37.21	170	354	P	V
		2382.15	16.96	-37.04	54	-	-	-	-	170	354	A	V
	*	2402	79.75	-	-	80.41	27.25	9.32	37.23	170	354	P	V
	*	2402	54.93	-	-	-	-	-	-	170	354	A	V
BT CH 39 2441MHz		2369.09	40.95	-33.05	74	41.65	27.19	9.32	37.21	228	299	P	H
		2369.09	16.13	-37.87	54	-	-	-	-	228	299	A	H
	*	2441	69.45	-	-	69.87	27.42	9.43	37.27	228	299	P	H
	*	2441	44.63	-	-	-	-	-	-	228	299	A	H
		2495.06	41.62	-32.38	74	41.68	27.6	9.66	37.32	228	299	P	H
		2495.06	16.8	-37.2	54	-	-	-	-	228	299	A	H
		2366.05	41.62	-32.38	74	42.48	27.13	9.2	37.19	186	167	P	V
		2366.05	16.8	-37.2	54	-	-	-	-	186	167	A	V
	*	2441	73.68	-	-	74.1	27.42	9.43	37.27	186	167	P	V
	*	2441	48.86	-	-	-	-	-	-	186	167	A	V
		2498.1	41.94	-32.06	74	42	27.6	9.66	37.32	186	167	P	V
		2498.1	17.12	-36.88	54	-	-	-	-	186	167	A	V



BT CH 78 2480MHz	*	2480	68.4	-	-	68.61	27.54	9.55	37.3	152	93	P	H
	*	2480	43.58	-	-	-	-	-	-	152	93	A	H
		2495.94	42.56	-31.44	74	42.62	27.6	9.66	37.32	152	93	P	H
		2495.94	17.74	-36.26	54	-	-	-	-	152	93	A	H
	*	2480	74.61	-	-	74.82	27.54	9.55	37.3	176	151	P	V
	*	2480	49.79	-	-	-	-	-	-	176	151	A	V
		2498.32	43.45	-30.55	74	43.51	27.6	9.66	37.32	176	151	P	V
		2498.32	18.63	-35.37	54	-	-	-	-	176	151	A	V
Remark	1. No other spurious found. 2. All results are PASS against Peak and Average limit line.												



**15C 2.4GHz 2400~2483.5MHz
BT (Harmonic @ 3m)**

BT	Note	Frequency	Level	Over	Limit	Read	Antenna	Cable	Preamp	Ant	Table	Peak	Pol.
				Limit	Line	Level	Factor	Loss	Factor	Pos	Pos	Avg.	
		(MHz)	(dBμV/m)	(dB)	(dBμV/m)	(dBμV)	(dB/m)	(dB)	(dB)	(cm)	(deg)	(P/A)	(H/V)
BT CH 00 2402MHz		4804	35.66	-38.34	74	27.67	31.22	13.27	36.5	186	360	P	H
		4804	36.3	-37.7	74	28.31	31.22	13.27	36.5	186	360	P	V
BT CH 39 2441MHz		4882	46.44	-27.56	74	38.05	31.36	13.48	36.45	186	360	P	H
		7323	53.08	-20.92	74	38.14	35.98	16.59	37.63	186	360	P	H
		7323	28.26	-25.74	54					186	360	A	H
		4882	46.79	-27.21	74	38.4	31.36	13.48	36.45	186	360	P	V
		7323	56.82	-17.18	74	41.88	35.98	16.59	37.63	186	360	P	V
		7323	32	-22	54					186	360	A	V
BT CH 78 2480MHz		4960	45.75	-28.25	74	36.92	31.53	13.69	36.39	186	360	P	H
		7440	51.95	-22.05	74	36.73	36.16	16.7	37.64	186	360	P	H
		7440	27.13	-26.87	54					186	360	A	H
		4960	46.14	-27.86	74	37.31	31.53	13.69	36.39	186	360	P	V
		7440	54.62	-19.38	74	39.4	36.16	16.7	37.64	186	360	P	V
		7440	29.8	-24.2	54					186	360	A	V
Remark	1. No other spurious found. 2. All results are PASS against Peak and Average limit line.												



15C Emission below 1GHz

2.4GHz BT (LF)

BT	Note	Frequency	Level	Over	Limit	Read	Antenna	Cable	Preamp	Ant	Table	Peak	Pol.
		(MHz)	(dBμV/m)	(dB)	(dBμV/m)	(dBμV)	(dB/m)	(dB)	(dB)	(cm)	(deg)	(P/A)	(H/V)
2.4GHz BT LF		59.1	30.54	-9.46	40	52.89	6.52	1.68	30.55	200	100	P	H
		173.56	25.81	-17.69	43.5	42.19	11.49	2.58	30.45	-	-	P	H
		274.44	26.81	-19.19	46	40.34	13.73	3.06	30.32	-	-	P	H
		299.66	26.09	-19.91	46	39.39	13.7	3.28	30.28	-	-	P	H
		538.28	22.44	-23.56	46	29.43	18.47	4.42	29.88	-	-	P	H
		893.3	28.41	-17.59	46	30.15	21.75	5.76	29.25	-	-	P	H
		49.4	32.39	-7.61	40	52.83	8.9	1.22	30.56	100	350	P	V
		103.72	23.59	-19.91	43.5	39.78	12.32	2.01	30.52	-	-	P	V
		119.24	23.86	-19.64	43.5	39.49	12.86	2.01	30.5	-	-	P	V
		370.47	17.85	-28.15	46	28.97	15.38	3.67	30.17	-	-	P	V
		642.07	23.15	-22.85	46	28.64	19.54	4.69	29.72	-	-	P	V
	910.76	27.82	-18.18	46	29.5	21.78	5.76	29.22	-	-	P	V	
Remark	1. No other spurious found. 2. All results are PASS against limit line.												



Note symbol

*	Fundamental Frequency which can be ignored. However, the level of any unwanted emissions shall not exceed the level of the fundamental frequency per 15.209(c).
!	Test result is over limit line.
P/A	Peak or Average
H/V	Horizontal or Vertical



A calculation example for radiated spurious emission is shown as below:

WIFI	Note	Frequency	Level	Over	Limit	Read	Antenna	Cable	Preamp	Ant	Table	Peak	Pol.
Ant.				Limit	Line	Level	Factor	Loss	Factor	Pos	Pos	Avg.	
1+2		(MHz)	(dBμV/m)	(dB)	(dBμV/m)	(dBμV)	(dB/m)	(dB)	(dB)	(cm)	(deg)	(P/A)	(H/V)
802.11b		2390	55.45	-18.55	74	54.51	32.22	4.58	35.86	103	308	P	H
CH 01													
2412MHz		2390	43.54	-10.46	54	42.6	32.22	4.58	35.86	103	308	A	H

1. Level(dBμV/m) =

Antenna Factor(dB/m) + Cable Loss(dB) + Read Level(dBμV) - Preamp Factor(dB)

2. Over Limit(dB) = Level(dBμV/m) – Limit Line(dBμV/m)

For Peak Limit @ 2390MHz:

1. Level(dBμV/m)

= Antenna Factor(dB/m) + Cable Loss(dB) + Read Level(dBμV) - Preamp Factor(dB)

= 32.22(dB/m) + 4.58(dB) + 54.51(dBμV) – 35.86 (dB)

= 55.45 (dBμV/m)

2. Over Limit(dB)

= Level(dBμV/m) – Limit Line(dBμV/m)

= 55.45(dBμV/m) – 74(dBμV/m)

= -18.55(dB)

For Average Limit @ 2390MHz:

1. Level(dBμV/m)

= Antenna Factor(dB/m) + Cable Loss(dB) + Read Level(dBμV) - Preamp Factor(dB)

= 32.22(dB/m) + 4.58(dB) + 42.6(dBμV) – 35.86 (dB)

= 43.54 (dBμV/m)

2. Over Limit(dB)

= Level(dBμV/m) – Limit Line(dBμV/m)

= 43.54(dBμV/m) – 54(dBμV/m)

= -10.46(dB)

Both peak and average measured complies with the limit line, so test result is “PASS”.