



FCC Test Report

APPLICANT : Brightstar Corporation
EQUIPMENT : Mobile Phone
BRAND NAME : Avvio
MODEL NAME : Avvio L640
FCC ID : WVBAL640X
STANDARD : FCC 47 CFR FCC Part 15 Subpart B
CLASSIFICATION : Certification

The product was received on Jul. 06, 2016 and testing was completed on Jul. 22, 2016. We, SPORTON INTERNATIONAL (SHENZHEN) INC., would like to declare that the tested sample has been evaluated in accordance with the test procedures given in ANSI C63.4-2014 and has been in compliance with the applicable technical standards.

The test results in this report apply exclusively to the tested model / sample. Without written approval of SPORTON INTERNATIONAL (SHENZHEN) INC., the test report shall not be reproduced except in full.

Prepared by: Ken Chen / Manager

Approved by: Jones Tsai / Manager



SPORTON INTERNATIONAL (SHENZHEN) INC.

**1F & 2F, Building A, Morning Business Center, No. 4003 ShiGu Rd., Xili Town,
Nanshan District, Shenzhen, Guangdong, P. R. China**



TABLE OF CONTENTS

REVISION HISTORY.....3

SUMMARY OF TEST RESULT4

1. GENERAL DESCRIPTION5

 1.1. Applicant.....5

 1.2. Manufacturer5

 1.3. Product Feature of Equipment Under Test5

 1.4. Product Specification of Equipment Under Test6

 1.5. Modification of EUT7

 1.6. Test Location7

 1.7. Applicable Standards7

2. TEST CONFIGURATION OF EQUIPMENT UNDER TEST.....8

 2.1. Test Mode8

 2.2. Connection Diagram of Test System 10

 2.3. Support Unit used in test configuration and system..... 11

 2.4. EUT Operation Test Setup 11

3. TEST RESULT12

 3.1. Test of AC Conducted Emission Measurement12

 3.2. Test of Radiated Emission Measurement20

4. LIST OF MEASURING EQUIPMENT24

5. UNCERTAINTY OF EVALUATION25

APPENDIX A. SETUP PHOTOGRAPHS



SUMMARY OF TEST RESULT

Report Section	FCC Rule	Description	Limit	Result	Remark
3.1	15.107	AC Conducted Emission	< 15.107 limits	PASS	Under limit 3.72 dB at 0.480 MHz
3.2	15.109	Radiated Emission	< 15.109 limits	PASS	Under limit 3.15 dB at 240.060 MHz for Quasi-Peak



1. General Description

1.1. Applicant

Brightstar Corporation
9725 NW 117th Ave., Miami, Florida, FL 33178, United States

1.2. Manufacturer

Heng Da Chuang Xin Technology Limited
Rm14H Taibang Building, 4 Rd. High Tech South, Nanshan, SZ, P. R. C. 518000

1.3. Product Feature of Equipment Under Test

Product Feature	
Equipment	Mobile Phone
Brand Name	Avvio
Model Name	Avvio L640
FCC ID	WVBAL640X
EUT supports Radios application	GSM/GPRS/EGPRS/WCDMA/HSPA/HSPA+/DC-HSDPA/LTE/ WLAN 2.4GHz 802.11b/g/n HT20/HT40/ Bluetooth v3.0 + EDR/Bluetooth v4.0 LE
IMEI Code	Conduction: 357275070002255 Radiation: 357275070002255
HW Version	V03
SW Version	Avvio_L640_Claro_V1.00
EUT Stage	Production Unit

Remark: The above EUT's information was declared by manufacturer. Please refer to the specifications or user's manual for more detailed description.



1.4. Product Specification of Equipment Under Test

Standards-related Product Specification	
Tx Frequency	GSM850: 824.2 MHz ~ 848.8 MHz GSM1900: 1850.2 MHz ~ 1909.8MHz WCDMA Band V: 826.4 MHz ~ 846.6 MHz WCDMA Band II: 1852.4 MHz ~ 1907.6 MHz LTE Band 2 : 1850.7 MHz ~ 1909.3 MHz LTE Band 4 : 1710.7 MHz ~ 1754.3 MHz LTE Band 7 : 2502.5 MHz ~ 2567.5 MHz 802.11b/g/n: 2412 MHz ~ 2462 MHz Bluetooth: 2402 MHz ~ 2480 MHz
Rx Frequency	GSM850: 869.2 MHz ~ 893.8 MHz GSM1900: 1930.2 MHz ~ 1989.8 MHz WCDMA Band V: 871.4 MHz ~ 891.6 MHz WCDMA Band II: 1932.4 MHz ~ 1987.6 MHz LTE Band 2 : 1930.7 MHz ~ 1989.3 MHz LTE Band 4 : 2110.7 MHz ~ 2154.3 MHz LTE Band 7 : 2622.5 MHz ~ 2687.5 MHz 802.11b/g/n: 2412 MHz ~ 2462 MHz Bluetooth: 2402 MHz ~ 2480 MHz GPS : 1.57542 GHz FM: 88MHz ~ 108 MHz
Antenna Type	WWAN : FPC Antenna WLAN : PIFA Antenna Bluetooth : PIFA Antenna GPS : PIFA Antenna
Type of Modulation	GSM: GMSK GPRS: GMSK EDGE(MCS 0-4): GMSK / (MCS 5-9): 8PSK WCDMA : QPSK (Uplink) HSDPA/DC-HSDPA : QPSK (Uplink) HSUPA : QPSK (Uplink) HSPA+ : 16QAM (Uplink) DC-HSDPA : 64QAM LTE: QPSK / 16QAM 802.11b : DSSS (DBPSK / DQPSK / CCK) 802.11g/n : OFDM (BPSK / QPSK / 16QAM / 64QAM) Bluetooth (1Mbps) : GFSK Bluetooth (2Mbps) : $\pi/4$ -DQPSK Bluetooth (3Mbps) : 8-DPSK Bluetooth LE : GFSK GPS : BPSK FM



1.5. Modification of EUT

No modifications are made to the EUT during all test items.

1.6. Test Location

Test Site	SPORTON INTERNATIONAL (SHENZHEN) INC.	
Test Site Location	1F & 2F, Building A, Morning Business Center, No. 4003 ShiGu Rd., Xili Town, Nanshan District, Shenzhen, Guangdong, P. R. China TEL: +86-755-8637-9589 FAX: +86-755-8637-9595	
Test Site No.	Sporton Site No.	
	CO01-SZ	

Test Site	SPORTON INTERNATIONAL (SHENZHEN) INC.	
Test Site Location	No. 3 Building, the third floor of south, Shahe River west, Fengzeyuan warehouse, Nanshan District, Shenzhen, Guangdong, P. R. China TEL: +86-755- 3320-2398	
Test Site No.	Sporton Site No.	FCC Registration No.
	03CH03-SZ	565805

Note: The test site complies with ANSI C63.4 2014 requirement.

1.7. Applicable Standards

According to the specifications of the manufacturer, the EUT must comply with the requirements of the following standards:

- ♦ FCC 47 CFR FCC Part 15 Subpart B
- ♦ ANSI C63.4-2014

Remark: All test items were verified and recorded according to the standards and without any deviation during the test.



2. Test Configuration of Equipment Under Test

2.1. Test Mode

The EUT has been associated with peripherals pursuant to ANSI C63.4-2014 and configuration operated in a manner tended to maximize its emission characteristics in a typical application.

Frequency range investigated: conduction (150 kHz to 30 MHz), radiation (30MHz to the 5th harmonic of the highest fundamental frequency or to 40 GHz, whichever is lower).

The following tables are showing the test modes as the worst cases and recorded in this report.

Item	EUT Configuration	Test Condition		
		EMI AC	EMI RE<1G	EMI RE≥1G
1.	Charging Mode (EUT with adapter)	☒	☒	Note 1
2.	Data application transferred mode (EUT with notebook)	☒	☒	☒

Abbreviations:

- EMI AC: AC conducted emissions
- EMI RE ≥ 1G: EUT radiated emissions ≥ 1GHz
- EMI RE < 1G: EUT radiated emissions < 1GHz

Note 1: Testing for this mode is not required or not the worst case.

Remark: For signal above 1GHz, the worst case was test item 2.



Test Items	EUT Configure Mode	Function Type
AC Conducted Emission	1/2	Mode 1: GSM850 Idle + Bluetooth Idle + WLAN Idle + USB Cable (Charging from Adapter) + Earphone + Camera(Front) <Fig.1> Mode 2: GSM1900 Idle + Bluetooth Idle + WLAN Idle + USB Cable (Charging from Adapter) + Earphone + Camera(Back) <Fig.1> Mode 3: WCDMA Band V Idle + Bluetooth Idle + WLAN Idle + USB Cable (Charging from Adapter) + Earphone + MPEG4 <Fig.1> Mode 4: WCDMA Band II Idle + Bluetooth Idle + WLAN Idle + USB Cable (Data Link with Notebook) + Earphone + GPS Rx + FM Rx <Fig.2>
Radiated Emissions < 1GHz	1/2	Mode 1: GSM850 Idle + Bluetooth Idle + WLAN Idle + USB Cable (Charging from Adapter) + Earphone + Camera(Front) <Fig.1> Mode 2: GSM1900 Idle + Bluetooth Idle + WLAN Idle + USB Cable (Charging from Adapter) + Earphone + Camera(Back) <Fig.1> Mode 3: WCDMA Band V Idle + Bluetooth Idle + WLAN Idle + USB Cable (Charging from Adapter) + Earphone + MPEG4 <Fig.1> Mode 4: WCDMA Band II Idle + Bluetooth Idle + WLAN Idle + USB Cable (Data Link with Notebook) + Earphone + GPS Rx + FM Rx <Fig.2>
Radiated Emissions ≥ 1GHz	2	Mode 1: WCDMA Band II Idle + Bluetooth Idle + WLAN Idle + USB Cable (Data Link with Notebook) + Earphone + GPS Rx + FM Rx <Fig.2>
Remark: <ol style="list-style-type: none"> The worst case of AC is mode 3, and the USB Link mode of AC is mode 4, the test data of these modes are reported. The worst case of RE < 1G is mode 4, only the test data of this mode is reported. Data Link with notebook means data application transferred mode between EUT and notebook. 		

2.2. Connection Diagram of Test System

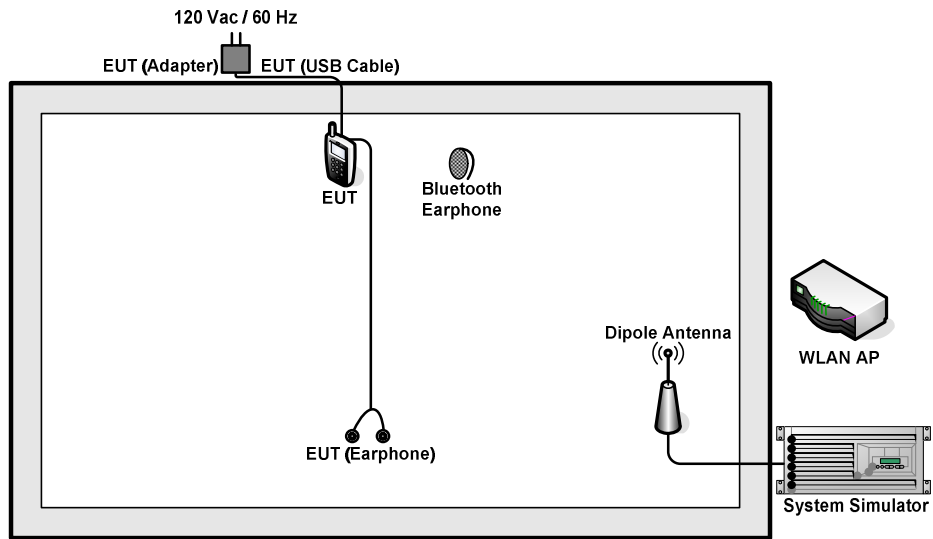

<Fig.1>

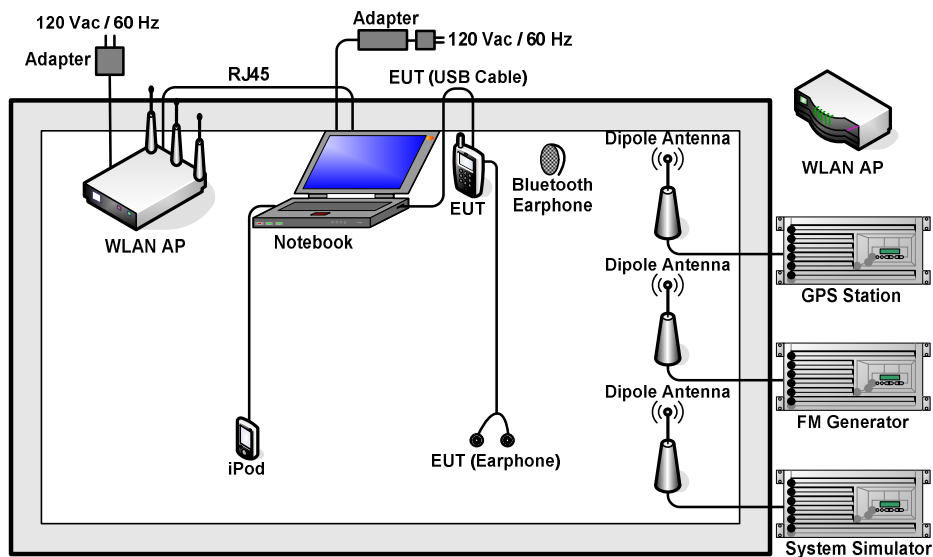

<Fig.2>

2.3. Support Unit used in test configuration and system

Item	Equipment	Trade Name	Model Name	FCC ID	Data Cable	Power Cord
1.	System Simulator	Anritsu	MT8820C	N/A	N/A	Unshielded, 1.8 m
2.	FM Generator	R&S	CMU200	N/A	N/A	Unshielded, 1.8 m
3.	GPS Station	ADIVIC	MP9000	N/A	N/A	Unshielded, 1.8 m
4.	WLAN AP	ASUS	RT-AC66U	MSQ-TRAC66U	N/A	Unshielded, 1.8 m
5.	WLAN AP	D-Link	DIR-820L	KA2IR820LAI	N/A	Unshielded, 1.8 m
6.	Bluetooth Earphone	Samsung	HS3000	A3LHS30000	N/A	N/A
7.	Bluetooth Earphone	Lenovo	LBH-520	FCC DoC	N/A	N/A
8.	Notebook	Lenovo	E540	N/A	N/A	AC I/P: Unshielded, 1.8 m DC O/P: Shielded, 1.8 m
9.	iPod	Apple	MC525 ZP/A	FCC DoC	Shielded, 1.2 m	N/A
10.	SD Card	SanDisk	4G class 4	FCC DoC	N/A	N/A

2.4. EUT Operation Test Setup

The EUT was in GSM or WCDMA idle mode during the testing. The EUT was synchronized to the BCCH, and is in continuous receiving mode by setting system simulator's paging reorganization.

At the same time, the EUT was attached to the Bluetooth earphone or WLAN AP, and the following programs installed in the EUT were programmed during the test.

1. Data application is transferred between notebook and EUT via USB cable.
2. Execute "GPS Test" to make the EUT receive continuous signals from GPS station.
3. Execute "Video player" to play MPEG4 files.
4. Turn on camera to capture images.
5. Turn on FM function.



3. Test Result

3.1. Test of AC Conducted Emission Measurement

3.1.1 Limits of AC Conducted Emission

For equipment that is designed to be connected to the public utility (AC) power line, the radio frequency voltage that is conducted back onto the AC power line on any frequency or frequencies within the band 150 kHz to 30 MHz shall not exceed the limits in the following table.

Frequency of emission (MHz)	Conducted limit (dBuV)	
	Quasi-peak	Average
0.15-0.5	66 to 56*	56 to 46*
0.5-5	56	46
5-30	60	50

*Decreases with the logarithm of the frequency.

3.1.2 Measuring Instruments

The measuring equipment is listed in the section 4 of this test report.

3.1.3 Test Procedure

1. The EUT was placed 0.4 meter from the conducting wall of the shielding room was kept at least 80 centimeters from any other grounded conducting surface.
2. Connect EUT to the power mains through a line impedance stabilization network (LISN).
3. All the support units are connecting to the other LISN.
4. The LISN provides 50 ohm coupling impedance for the measuring instrument.
5. The FCC states that a 50 ohm, 50 microhenry LISN should be used.
6. Both sides of AC line were checked for maximum conducted interference.
7. The frequency range from 150 kHz to 30 MHz was searched.
8. Set the test-receiver system to Peak Detect Function and specified bandwidth (IF Bandwidth = 9kHz) with Maximum Hold Mode. Then measurement is also conducted by Average Detector and Quasi-Peak Detector Function respectively.

3.1.4 Test Setup

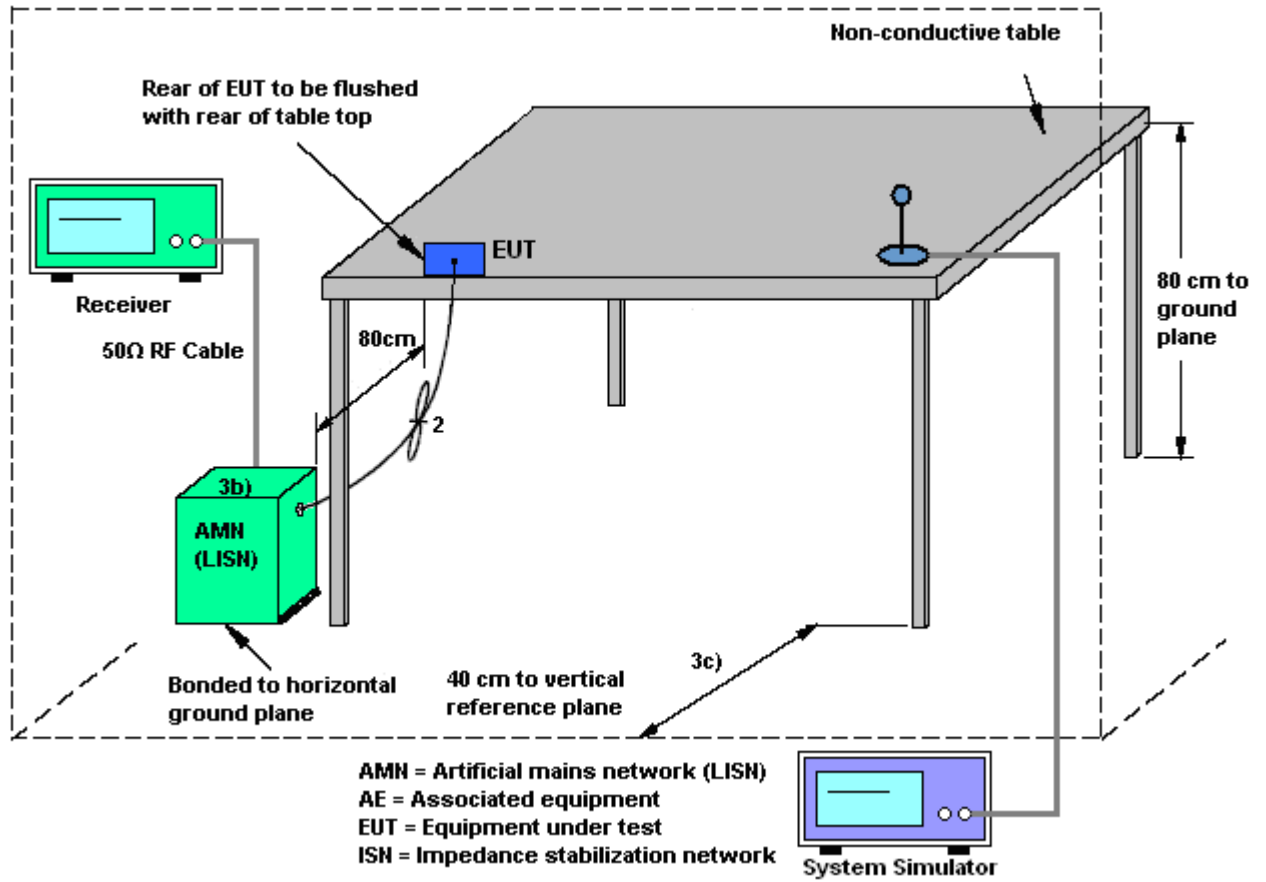



3.1.5 Test Result of AC Conducted Emission

Test Mode :	Mode 3	Temperature :	21~23°C
Test Engineer :	Tao Cheng	Relative Humidity :	41~43%
Test Voltage :	120Vac / 60Hz	Phase :	Line
Function Type :	WCDMA Band V Idle + Bluetooth Idle + WLAN Idle + USB Cable (Charging from Adapter) + Earphone + MPEG4		

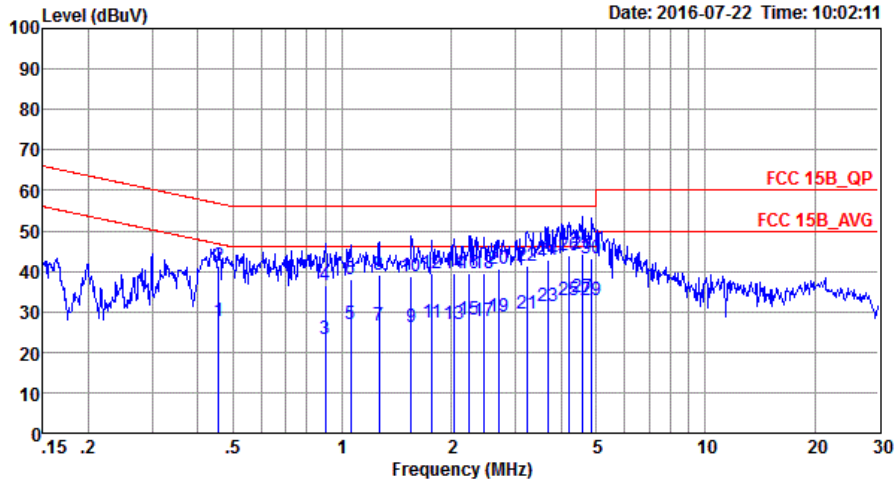

Site : CO01-SZ
 Condition: FCC 15B_QP LISN_20160509 LINE
 Project : (FC) 670610
 Mode : Mode 3
 IMEI : 357275070002255

	Freq	Level	Over Limit	Limit Line	Read Level	LISN Factor	Cable Loss	Remark
	MHz	dBuV	dB	dBuV	dBuV	dB	dB	
1	0.46	27.64	-19.12	46.76	17.30	0.11	10.23	Average
2	0.46	41.34	-15.42	56.76	31.00	0.11	10.23	QP
3	0.90	23.07	-22.93	46.00	12.80	0.11	10.16	Average
4	0.90	36.47	-19.53	56.00	26.20	0.11	10.16	QP
5	1.05	26.97	-19.03	46.00	16.70	0.11	10.16	Average
6	1.05	38.07	-17.93	56.00	27.80	0.11	10.16	QP
7	1.26	26.47	-19.53	46.00	16.20	0.11	10.16	Average
8	1.26	38.97	-17.03	56.00	28.70	0.11	10.16	QP
9	1.55	26.08	-19.92	46.00	15.80	0.11	10.17	Average
10	1.55	38.78	-17.22	56.00	28.50	0.11	10.17	QP
11	1.77	27.38	-18.62	46.00	17.10	0.11	10.17	Average
12	1.77	39.58	-16.42	56.00	29.30	0.11	10.17	QP
13	2.03	26.98	-19.02	46.00	16.70	0.11	10.17	Average
14	2.03	39.48	-16.52	56.00	29.20	0.11	10.17	QP
15	2.24	27.99	-18.01	46.00	17.70	0.11	10.18	Average
16	2.24	39.59	-16.41	56.00	29.30	0.11	10.18	QP



Test Mode :	Mode 3	Temperature :	21~23°C
Test Engineer :	Tao Cheng	Relative Humidity :	41~43%
Test Voltage :	120Vac / 60Hz	Phase :	Line
Function Type :	WCDMA Band V Idle + Bluetooth Idle + WLAN Idle + USB Cable (Charging from Adapter) + Earphone + MPEG4		

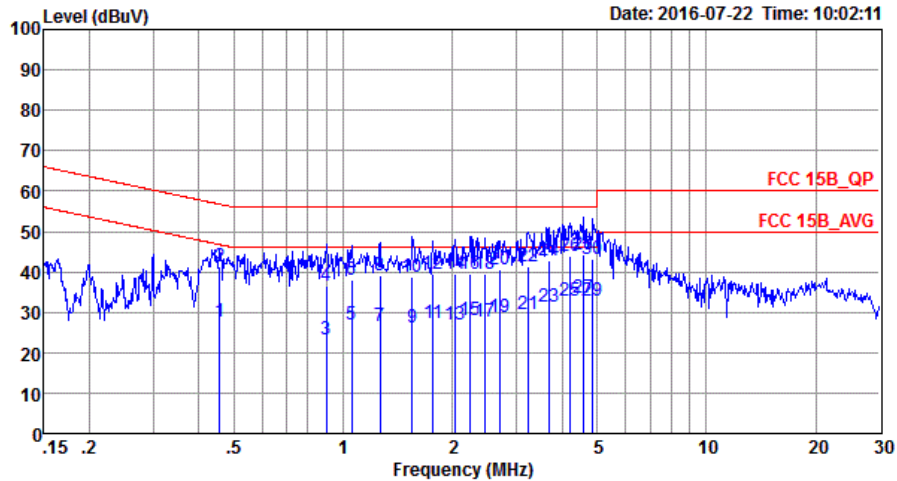

Site : C001-SZ
 Condition: FCC 15B_QP LISN_20160509 LINE
 Project : (FC) 670610
 Mode : Mode 3
 IMEI : 357275070002255

	Freq	Level	Over Limit	Limit Line	Read Level	LISN Factor	Cable Loss	Remark
	MHz	dBuV	dB	dBuV	dBuV	dB	dB	
17	2.46	27.70	-18.30	46.00	17.40	0.12	10.18	Average
18	2.46	39.30	-16.70	56.00	29.00	0.12	10.18	QP
19	2.69	28.91	-17.09	46.00	18.60	0.12	10.19	Average
20	2.69	40.41	-15.59	56.00	30.10	0.12	10.19	QP
21	3.22	29.53	-16.47	46.00	19.21	0.12	10.20	Average
22	3.22	41.33	-14.67	56.00	31.01	0.12	10.20	QP
23	3.70	31.24	-14.76	46.00	20.90	0.13	10.21	Average
24	3.70	42.64	-13.36	56.00	32.30	0.13	10.21	QP
25	4.22	32.86	-13.14	46.00	22.50	0.13	10.23	Average
26	4.22	43.76	-12.24	56.00	33.40	0.13	10.23	QP
27	4.60	33.68	-12.32	46.00	23.30	0.14	10.24	Average
28 *	4.60	44.18	-11.82	56.00	33.80	0.14	10.24	QP
29	4.87	32.89	-13.11	46.00	22.50	0.14	10.25	Average
30	4.87	43.29	-12.71	56.00	32.90	0.14	10.25	QP



Test Mode :	Mode 3	Temperature :	21~23°C
Test Engineer :	Tao Cheng	Relative Humidity :	41~43%
Test Voltage :	120Vac / 60Hz	Phase :	Neutral
Function Type :	WCDMA Band V Idle + Bluetooth Idle + WLAN Idle + USB Cable (Charging from Adapter) + Earphone + MPEG4		

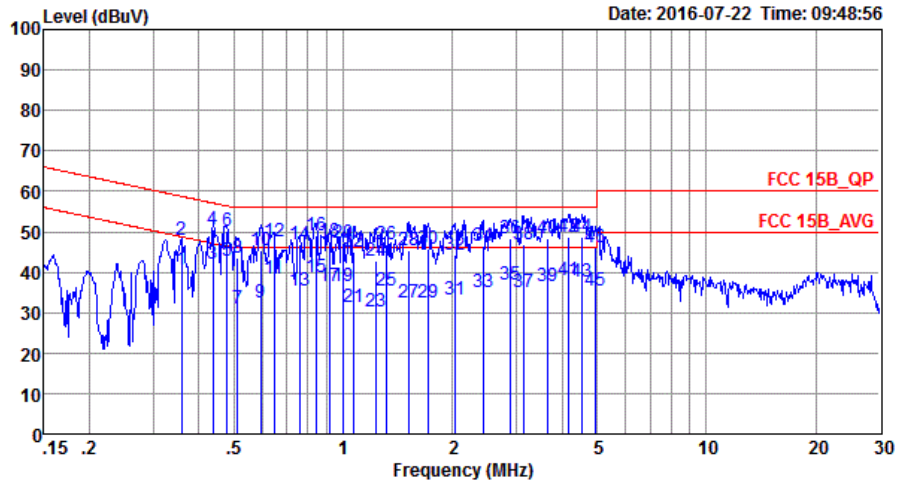

Site : C001-SZ
 Condition: FCC 15B_QP LISN_20160509 NEUTRAL
 Project : (FC)670610
 Mode : Mode 3
 IMEI : 357275070002255

	Freq	Level	Over	Limit	Read	LISN	Cable	
	MHz	dBuV	dB	dBuV	dBuV	dB	dB	Remark
1	0.36	40.72	-8.02	48.74	30.30	0.11	10.31	Average
2	0.36	47.92	-10.82	58.74	37.50	0.11	10.31	QP
3	0.44	42.15	-4.96	47.11	31.80	0.11	10.24	Average
4	0.44	50.65	-6.46	57.11	40.30	0.11	10.24	QP
5 *	0.48	42.64	-3.72	46.36	32.30	0.11	10.23	Average
6	0.48	50.24	-6.12	56.36	39.90	0.11	10.23	QP
7	0.51	30.83	-15.17	46.00	20.50	0.11	10.22	Average
8	0.51	43.63	-12.37	56.00	33.30	0.11	10.22	QP
9	0.59	32.30	-13.70	46.00	22.00	0.11	10.19	Average
10	0.59	45.30	-10.70	56.00	35.00	0.11	10.19	QP
11	0.64	38.28	-7.72	46.00	27.99	0.11	10.18	Average
12	0.64	47.49	-8.51	56.00	37.20	0.11	10.18	QP
13	0.76	35.27	-10.73	46.00	25.00	0.11	10.16	Average
14	0.76	46.77	-9.23	56.00	36.50	0.11	10.16	QP
15	0.84	38.57	-7.43	46.00	28.30	0.11	10.16	Average
16	0.84	49.17	-6.83	56.00	38.90	0.11	10.16	QP
17	0.92	36.37	-9.63	46.00	26.10	0.11	10.16	Average
18	0.92	47.57	-8.43	56.00	37.30	0.11	10.16	QP
19	1.00	36.47	-9.53	46.00	26.20	0.11	10.16	Average
20	1.00	47.37	-8.63	56.00	37.10	0.11	10.16	QP
21	1.07	31.47	-14.53	46.00	21.20	0.11	10.16	Average
22	1.07	44.97	-11.03	56.00	34.70	0.11	10.16	QP
23	1.23	30.17	-15.83	46.00	19.90	0.11	10.16	Average
24	1.23	42.67	-13.33	56.00	32.40	0.11	10.16	QP



Test Mode :	Mode 3	Temperature :	21~23°C
Test Engineer :	Tao Cheng	Relative Humidity :	41~43%
Test Voltage :	120Vac / 60Hz	Phase :	Neutral
Function Type :	WCDMA Band V Idle + Bluetooth Idle + WLAN Idle + USB Cable (Charging from Adapter) + Earphone + MPEG4		

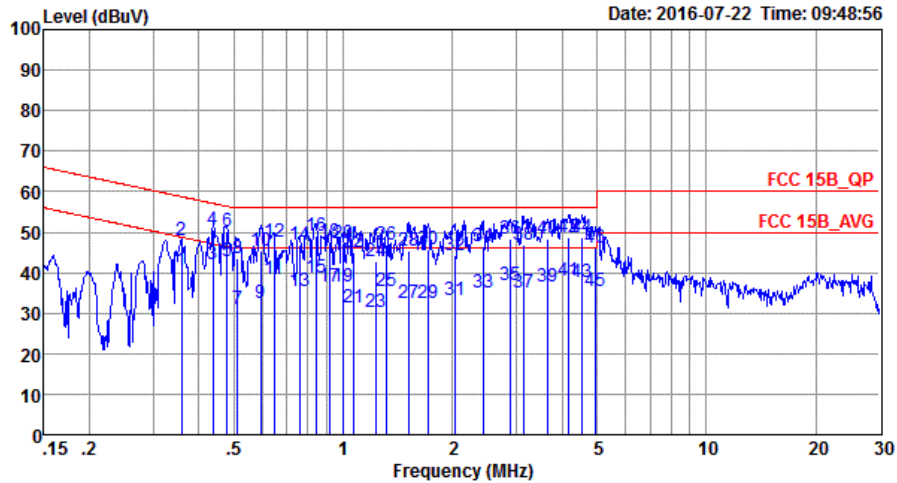

Site : C001-SZ
 Condition: FCC 15B_QP LISN_20160509 NEUTRAL
 Project : (FC)670610
 Mode : Mode 3
 IMEI : 357275070002255

	Freq	Level	Over	Limit	Read	LISN	Cable	Remark
	MHz	dBuV	dB	dBuV	dBuV	dB	dB	
25	1.32	35.57	-10.43	46.00	25.30	0.11	10.16	Average
26	1.32	46.97	-9.03	56.00	36.70	0.11	10.16	QP
27	1.51	32.48	-13.52	46.00	22.20	0.11	10.17	Average
28	1.51	45.48	-10.52	56.00	35.20	0.11	10.17	QP
29	1.71	32.58	-13.42	46.00	22.30	0.11	10.17	Average
30	1.71	45.58	-10.42	56.00	35.30	0.11	10.17	QP
31	2.03	33.18	-12.82	46.00	22.90	0.11	10.17	Average
32	2.03	44.38	-11.62	56.00	34.10	0.11	10.17	QP
33	2.43	35.20	-10.80	46.00	24.90	0.12	10.18	Average
34	2.43	46.60	-9.40	56.00	36.30	0.12	10.18	QP
35	2.88	36.72	-9.28	46.00	26.40	0.12	10.20	Average
36	2.88	48.52	-7.48	56.00	38.20	0.12	10.20	QP
37	3.14	35.23	-10.77	46.00	24.91	0.12	10.20	Average
38	3.14	47.03	-8.97	56.00	36.71	0.12	10.20	QP
39	3.66	36.64	-9.36	46.00	26.30	0.13	10.21	Average
40	3.66	48.24	-7.76	56.00	37.90	0.13	10.21	QP
41	4.16	37.96	-8.04	46.00	27.60	0.13	10.23	Average
42	4.16	48.86	-7.14	56.00	38.50	0.13	10.23	QP
43	4.55	37.58	-8.42	46.00	27.20	0.14	10.24	Average
44	4.55	48.78	-7.22	56.00	38.40	0.14	10.24	QP
45	4.95	35.50	-10.50	46.00	25.10	0.15	10.25	Average
46	4.95	46.20	-9.80	56.00	35.80	0.15	10.25	QP



Test Mode :	Mode 4	Temperature :	21~23°C
Test Engineer :	Tao Cheng	Relative Humidity :	41~43%
Test Voltage :	120Vac / 60Hz	Phase :	Line
Function Type :	WCDMA Band II Idle + Bluetooth Idle + WLAN Idle + USB Cable (Data Link with Notebook) + Earphone + GPS Rx + FM Rx		

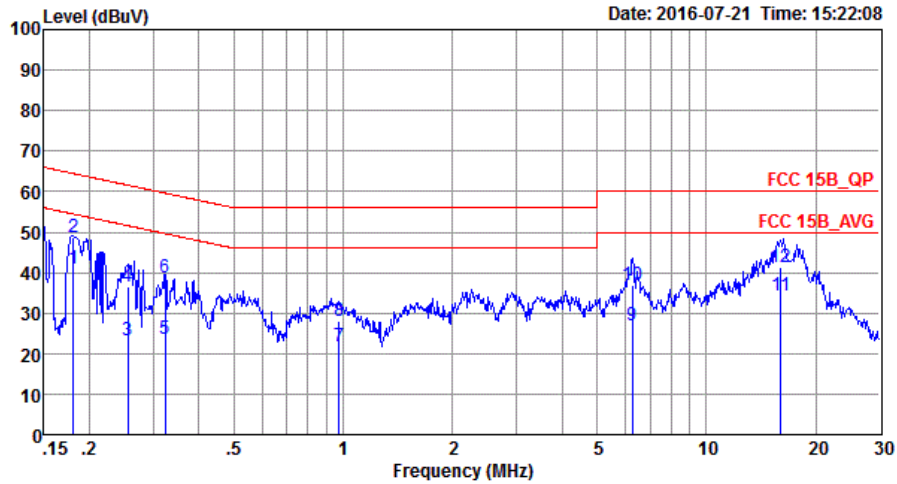

Site : CO01-SZ
 Condition: FCC 15B_QP LISN_20160509 LINE
 Project : (FC)670610
 Mode : Mode 4
 IMEI : 357275070002255

	Freq	Level	Over	Limit	Read	LISN	Cable	
	MHz	dBuV	Limit	Line	Level	Factor	Loss	Remark
			dB	dBuV	dBuV	dB	dB	
1 *	0.18	40.96	-13.50	54.46	30.30	0.12	10.54	Average
2	0.18	48.56	-15.90	64.46	37.90	0.12	10.54	QP
3	0.25	23.16	-28.44	51.60	12.60	0.11	10.45	Average
4	0.25	36.66	-24.94	61.60	26.10	0.11	10.45	QP
5	0.32	23.59	-26.03	49.62	13.10	0.11	10.38	Average
6	0.32	38.59	-21.03	59.62	28.10	0.11	10.38	QP
7	0.97	21.67	-24.33	46.00	11.40	0.11	10.16	Average
8	0.97	28.07	-27.93	56.00	17.80	0.11	10.16	QP
9	6.25	26.95	-23.05	50.00	16.51	0.16	10.28	Average
10	6.25	36.75	-23.25	60.00	26.31	0.16	10.28	QP
11	16.05	34.17	-15.83	50.00	23.40	0.31	10.46	Average
12	16.05	41.47	-18.53	60.00	30.70	0.31	10.46	QP



Test Mode :	Mode 4	Temperature :	21~23°C
Test Engineer :	Tao Cheng	Relative Humidity :	41~43%
Test Voltage :	120Vac / 60Hz	Phase :	Neutral
Function Type :	WCDMA Band II Idle + Bluetooth Idle + WLAN Idle + USB Cable (Data Link with Notebook) + Earphone + GPS Rx + FM Rx		

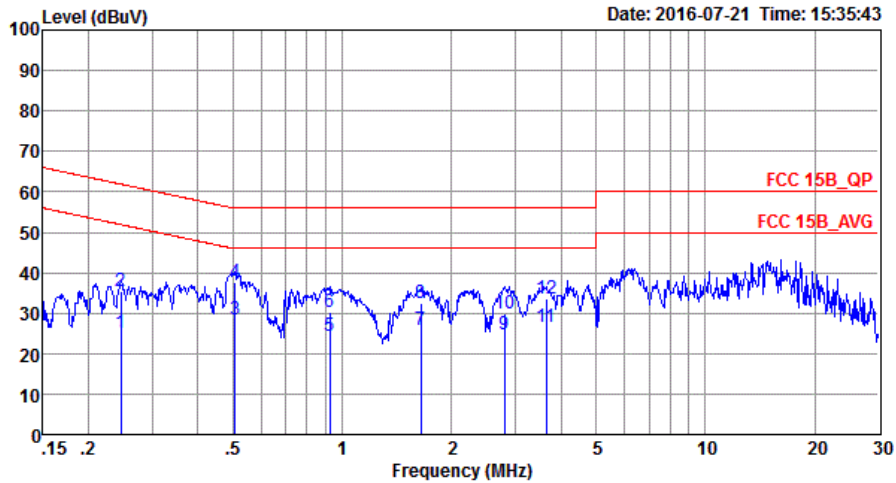

Site : CO01-SZ
 Condition: FCC 15B_QP LISN_20160509 NEUTRAL
 Project : (FC) 670610
 Mode : Mode 4
 IMEI : 357275070002255

	Freq	Level	Over Limit	Limit Line	Read Level	LISN Factor	Cable Loss	Remark
	MHz	dBuV	dB	dBuV	dBuV	dB	dB	
1	0.25	25.17	-26.74	51.91	14.60	0.11	10.46	Average
2	0.25	35.47	-26.44	61.91	24.90	0.11	10.46	QP
3 *	0.51	28.43	-17.57	46.00	18.10	0.11	10.22	Average
4	0.51	37.63	-18.37	56.00	27.30	0.11	10.22	QP
5	0.92	24.37	-21.63	46.00	14.10	0.11	10.16	Average
6	0.92	30.37	-25.63	56.00	20.10	0.11	10.16	QP
7	1.64	25.98	-20.02	46.00	15.70	0.11	10.17	Average
8	1.64	32.38	-23.62	56.00	22.10	0.11	10.17	QP
9	2.79	24.81	-21.19	46.00	14.50	0.12	10.19	Average
10	2.79	29.91	-26.09	56.00	19.60	0.12	10.19	QP
11	3.64	26.54	-19.46	46.00	16.20	0.13	10.21	Average
12	3.64	33.44	-22.56	56.00	23.10	0.13	10.21	QP



3.2. Test of Radiated Emission Measurement

3.2.1. Limit of Radiated Emission

The emissions from an unintentional radiator shall not exceed the field strength levels specified in the following table:

Frequency (MHz)	Field Strength (microvolts/meter)	Measurement Distance (meters)
30 – 88	100	3
88 – 216	150	3
216 - 960	200	3
Above 960	500	3

3.2.2. Measuring Instruments

The measuring equipment is listed in the section 4 of this test report.

3.2.3. Test Procedures

1. The EUT was placed on a turntable with 0.8 meter above ground.
2. The EUT was set 3 meters from the interference receiving antenna, which was mounted on the top of a variable height antenna tower.
3. The table was rotated 360 degrees to determine the position of the highest radiation.
4. The antenna height is adjusted between one to four meters above ground to find the maximum value of the field strength for both horizontal polarization and vertical polarization of the antenna.
5. For each suspected emission, the EUT was arranged to its worst case and then tune the antenna tower (from 1 m to 4 m) and turntable (from 0 degree to 360 degrees) to find the maximum reading.
6. Set the test-receiver system to Peak Detect Function and specified bandwidth with Maximum Hold Mode (RBW=120kHz/VBW=300kHz for frequency below 1GHz; RBW=1MHz VBW=3MHz (Peak), RBW=1MHz/VBW=10Hz (Average) for frequency above 1GHz).
7. If the emission level of the EUT in peak mode was 3 dB lower than the limit specified, peak values of EUT will be reported. Otherwise, the emission will be repeated by using the quasi-peak method and reported.
8. Emission level (dBµV/m) = 20 log Emission level (µV/m)
9. Corrected Reading: Antenna Factor + Cable Loss + Read Level - Preamp Factor = Level

3.2.4. Test Setup of Radiated Emission

For radiated emissions from 30MHz to 1GHz

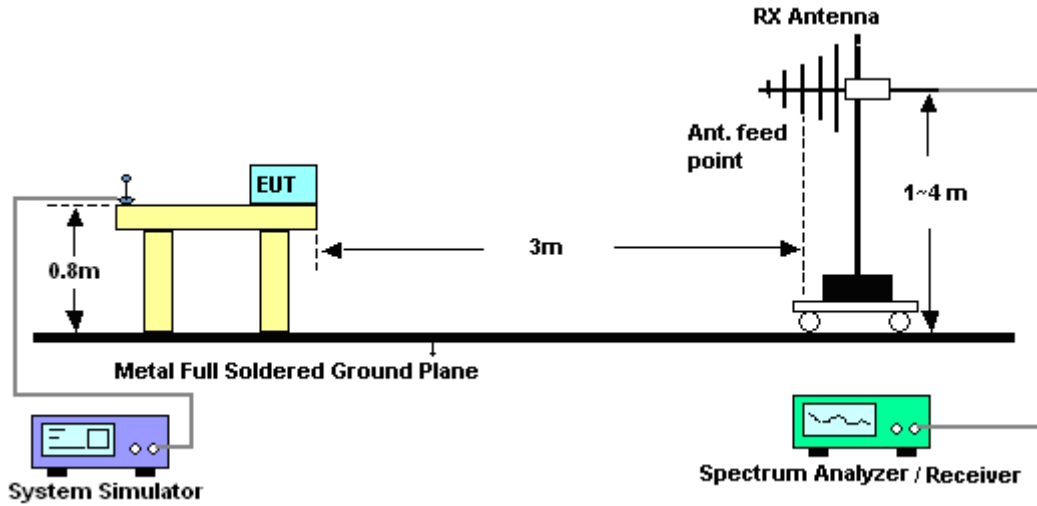

For radiated emissions above 1GHz

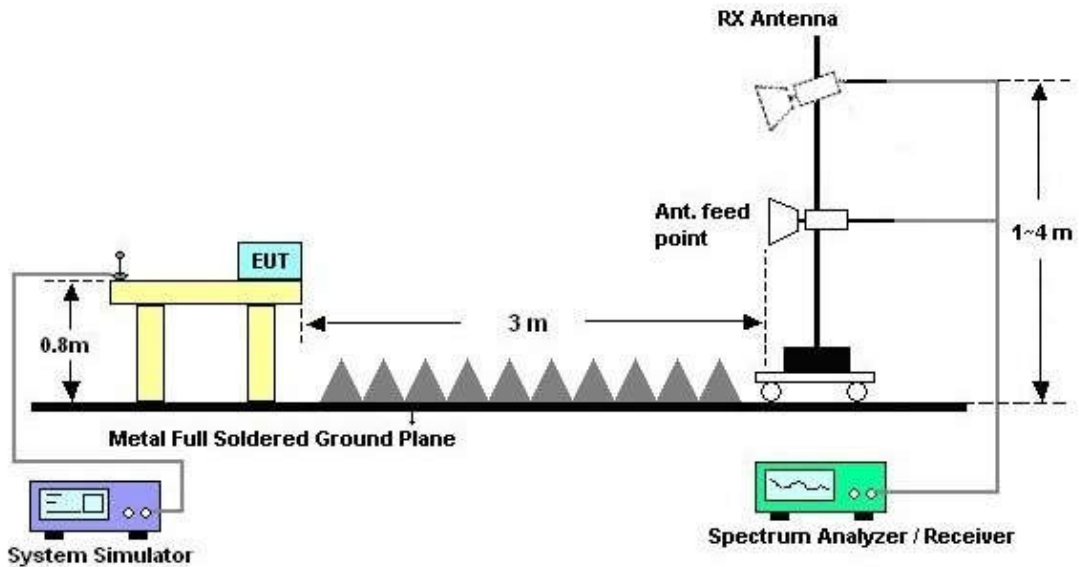



3.2.5. Test Result of Radiated Emission

Test Mode :	Mode 4	Temperature :	23~25°C
Test Engineer :	Jeff Yao	Relative Humidity :	48~52%
Test Distance :	3m	Polarization :	Horizontal
Function Type :	WCDMA Band II Idle + Bluetooth Idle + WLAN Idle + USB Cable (Data Link with Notebook) + Earphone + GPS Rx + FM Rx		
Remark :	#1 is FM signal which can be ignored. #8 is system simulator signal which can be ignored.		

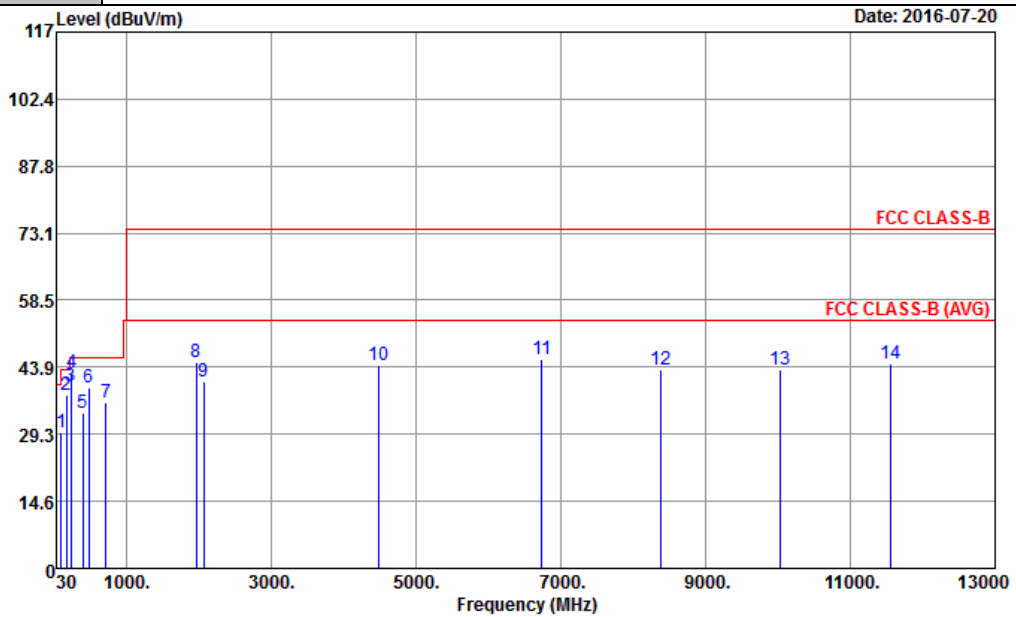

Site : 03CH03-SZ
 Condition : FCC CLASS-B 3m LF_ANT(23188)6_15101 HORIZONTAL
 Project : (FC) 670610
 Mode : Mode 4
 IMEI : 357275070002255
 Plane : Y

	Freq	Level	Over	Limit	ReadAntenna	Cable	Preamp	A/Pos	T/Pos	Remark	
	MHz	dBuV/m	Limit	Line	Level	Factor	Loss	Factor	cm	deg	
			dB	dBuV/m	dBuV	dB/m	dB	dB			
1	98.04	29.50			35.87	18.28	1.14	25.79	---	---	Peak
2	165.81	37.93	-5.57	43.50	45.28	16.88	1.20	25.43	100	142	QP
3	228.72	39.61	-6.39	46.00	47.27	15.99	1.54	25.19	---	---	Peak
4	240.06	42.85	-3.15	46.00	50.20	16.27	1.54	25.16	100	14	QP
5	399.40	34.02	-11.98	46.00	34.70	23.10	2.03	25.81	---	---	Peak
6	479.90	39.60	-6.40	46.00	40.34	23.37	2.12	26.23	---	---	Peak
7	720.00	36.32	-9.68	46.00	33.30	26.70	2.65	26.33	---	---	Peak
8	1960.00	45.12			67.43	31.74	4.59	58.64	---	---	Peak
9	2066.00	40.72	-33.28	74.00	62.47	32.27	4.71	58.73	---	---	Peak
10	4480.00	44.48	-29.52	74.00	62.97	34.19	7.16	59.84	---	---	Peak
11	6740.00	45.78	-28.22	74.00	58.46	36.20	9.03	57.91	100	0	Peak
12	8378.00	43.50	-30.50	74.00	53.64	36.27	11.07	57.48	---	---	Peak
13	10038.00	43.33	-30.67	74.00	52.06	38.14	12.03	58.90	---	---	Peak
14	11550.00	44.54	-29.46	74.00	52.52	39.23	12.60	59.81	---	---	Peak



Test Mode :	Mode 4	Temperature :	23~25°C
Test Engineer :	Jeff Yao	Relative Humidity :	48~52%
Test Distance :	3m	Polarization :	Vertical
Function Type :	WCDMA Band II Idle + Bluetooth Idle + WLAN Idle + USB Cable (Data Link with Notebook) + Earphone + GPS Rx + FM Rx		
Remark :	#2 is FM signal which can be ignored. #8 is system simulator signal which can be ignored.		

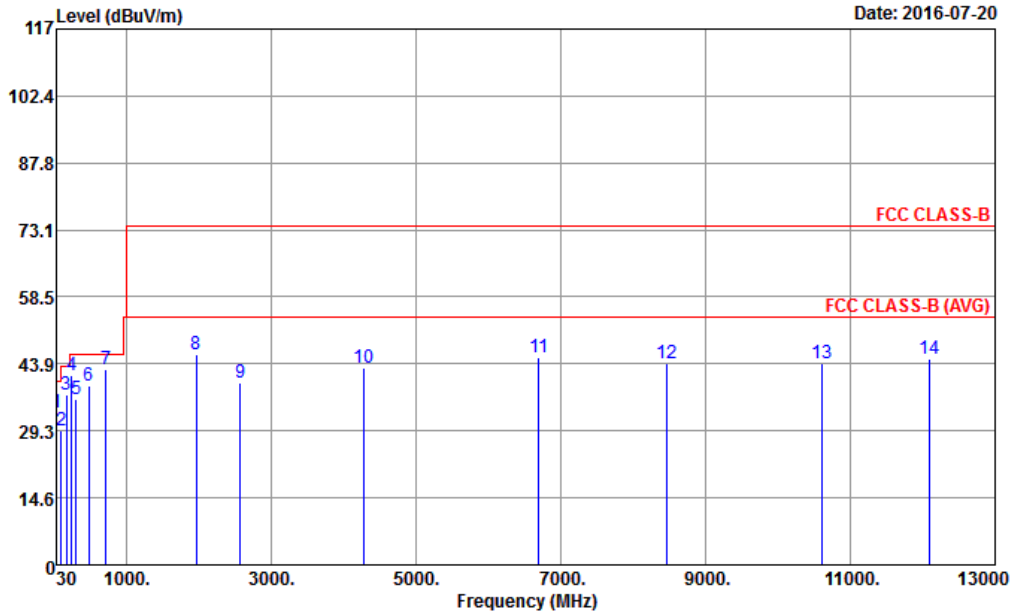

Site : 03CH03-SZ
 Condition : FCC CLASS-B 3m LF_ANT(23188)6_15101 VERTICAL
 Project : (FC) 670610
 Mode : Mode 4
 IMEI : 357275070002255
 Plane : Y

	Freq	Level	Over	Limit	ReadAntenna	Cable	Preamp	A/Pos	T/Pos	Remark	
	MHz	dBuV/m	dB	dBuV/m	dBuV	dB/m	dB	dB	cm	deg	
1	30.00	33.35	-6.65	40.00	32.07	26.60	0.75	26.07	---	---	Peak
2	98.04	29.31			35.68	18.28	1.14	25.79	---	---	Peak
3	165.54	37.30	-6.20	43.50	44.65	16.88	1.20	25.43	---	---	Peak
4	240.06	41.43	-4.57	46.00	48.78	16.27	1.54	25.16	---	---	Peak
5	300.00	36.24	-9.76	46.00	41.07	18.50	1.71	25.04	---	---	Peak
6	479.90	39.18	-6.82	46.00	39.92	23.37	2.12	26.23	---	---	Peak
7	720.00	42.66	-3.34	46.00	39.64	26.70	2.65	26.33	100	175	QP
8	1960.00	46.07			68.38	31.74	4.59	58.64	---	---	Peak
9	2572.00	39.88	-34.12	74.00	60.64	32.75	5.31	58.82	---	---	Peak
10	4284.00	43.16	-30.84	74.00	62.01	34.07	6.98	59.90	---	---	Peak
11	6696.00	45.20	-28.80	74.00	57.84	36.22	8.99	57.85	100	0	Peak
12	8472.00	43.87	-30.13	74.00	53.98	36.21	11.06	57.38	---	---	Peak
13	10604.00	44.12	-29.88	74.00	52.34	38.56	12.37	59.15	---	---	Peak
14	12086.00	44.94	-29.06	74.00	53.12	39.47	12.67	60.32	---	---	Peak



4. List of Measuring Equipment

Instrument	Manufacturer	Model No.	Serial No.	Characteristics	Calibration Date	Test Date	Due Date	Remark
EMI Receiver	R&S	ESCI7	100724	9kHz~3GHz;	Nov. 23, 2015	Jul. 21, 2016~ Jul. 22, 2016	Nov. 22, 2016	Conduction (CO01-SZ)
AC LISN	EMCO	3816/2SH	00103892	9kHz~30MHz	Jan. 12, 2016	Jul. 21, 2016~ Jul. 22, 2016	Jan. 11, 2017	Conduction (CO01-SZ)
AC LISN (for auxiliary equipment)	MessTec	3816/2SH	00103912	9kHz~30MHz	Jan. 12, 2016	Jul. 21, 2016~ Jul. 22, 2016	Jan. 11, 2017	Conduction (CO01-SZ)
AC Power Source	Chroma	61602	616020000891	100Vac~250Vac	Jul. 16, 2016	Jul. 21, 2016~ Jul. 22, 2016	Jul. 15, 2017	Conduction (CO01-SZ)
Pulse Limiter	COM-POWER	LIT-153 Transient Limiter	53139	150kHz~30MHz	Oct. 20, 2015	Jul. 21, 2016~ Jul. 22, 2016	Oct. 19, 2016	Conduction (CO01-SZ)
EMI Test Receiver&SA	KEYSIGHT	N9038A	MY54450083	20Hz~8.4GHz	May 07, 2016	Jul. 20, 2016	May 06, 2017	Radiation (03CH03-SZ)
EXA Spectrum Analyzer	KEYSIGHT	N9010A	MY55150246	10Hz~44GHz	May 07, 2016	Jul. 20, 2016	May 06, 2017	Radiation (03CH03-SZ)
Bilog Antenna	TeseQ	CBL6112D	35408	30MHz~2GHz	May 21, 2016	Jul. 20, 2016	May 20, 2017	Radiation (03CH03-SZ)
Double Ridge Horn Antenna	SCHWARZBE CK	BBHA9120D	9120D-1355	1GHz~18GHz	May 07, 2016	Jul. 20, 2016	May 06, 2017	Radiation (03CH03-SZ)
Amplifier	Burgeon	BPA-530	102210	0.01Hz ~3000MHz	Oct. 20, 2015	Jul. 20, 2016	Oct. 19, 2016	Radiation (03CH03-SZ)
HF Amplifier	MITEQ	AMF-7D-001018 00-30-10P-R	1943528	1GHz~18GHz	Oct. 20, 2015	Jul. 20, 2016	Oct. 19, 2016	Radiation (03CH03-SZ)
AC Power Source	Chroma	61601	616010001985	N/A	NCR	Jul. 20, 2016	NCR	Radiation (03CH03-SZ)
Turn Table	EM	EM1000	N/A	0~360 degree	NCR	Jul. 20, 2016	NCR	Radiation (03CH03-SZ)
Antenna Mast	EM	EM1000	N/A	1 m~4 m	NCR	Jul. 20, 2016	NCR	Radiation (03CH03-SZ)

NCR: No Calibration Required



5. Uncertainty of Evaluation

Uncertainty of Conducted Emission Measurement (150 kHz ~ 30 MHz)

Measuring Uncertainty for a Level of Confidence of 95% ($U = 2Uc(y)$)	2.5dB
---	-------

Uncertainty of Radiated Emission Measurement (30 MHz ~ 1000 MHz)

Measuring Uncertainty for a Level of Confidence of 95% ($U = 2Uc(y)$)	5.1dB
---	-------

Uncertainty of Radiated Emission Measurement (1GHz ~ 18GHz)

Measuring Uncertainty for a Level of Confidence of 95% ($U = 2Uc(y)$)	5.0dB
---	-------