

FCC SAR Test Report

APPLICANT : Brightstar Corporation
EQUIPMENT : Mobile Phone
BRAND NAME : Avvio
MODEL NAME : Avvio L640
FCC ID : WVBAL640X
STANDARD : FCC 47 CFR Part 2 (2.1093)
ANSI/IEEE C95.1-1992
IEEE 1528-2013

We, SPORTON INTERNATIONAL (SHENZHEN) INC., would like to declare that the tested sample has been evaluated in accordance with the procedures and had been in compliance with the applicable technical standards.

The test results in this report apply exclusively to the tested model / sample. Without written approval of SPORTON INTERNATIONAL (SHENZHEN) INC., the test report shall not be reproduced except in full.



Prepared by: Mark Qu / Manager



Approved by: Jones Tsai / Manager

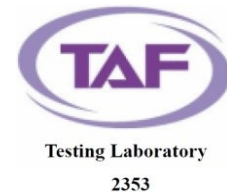

SPORTON INTERNATIONAL (SHENZHEN) INC.
1F & 2F, Building A, Morning Business Center, No. 4003 ShiGu Rd., Xili Town,
Nanshan District, Shenzhen, Guangdong, P. R. China



Table of Contents

1. Statement of Compliance 4
2. Administration Data 5
3. Guidance Standard 5
4. Equipment Under Test (EUT) Information 6
4.1 General Information 6
4.2 General LTE SAR Test and Reporting Considerations 7
5. RF Exposure Limits 9
5.1 Uncontrolled Environment 9
5.2 Controlled Environment 9
6. Specific Absorption Rate (SAR) 10
6.1 Introduction 10
6.2 SAR Definition 10
7. System Description and Setup 11
7.1 E-Field Probe 12
7.2 Data Acquisition Electronics (DAE) 12
7.3 Phantom 13
7.4 Device Holder 14
8. Measurement Procedures 15
8.1 Spatial Peak SAR Evaluation 15
8.2 Power Reference Measurement 16
8.3 Area Scan 16
8.4 Zoom Scan 17
8.5 Volume Scan Procedures 17
8.6 Power Drift Monitoring 17
9. Test Equipment List 18
10. System Verification 19
10.1 Tissue Verification 19
10.2 System Performance Check Results 20
11. RF Exposure Positions 21
11.1 Ear and handset reference point 21
11.2 Definition of the cheek position 22
11.3 Definition of the tilt position 23
11.4 Body Worn Accessory 24
11.5 Wireless Router 24
12. Conducted RF Output Power (Unit: dBm) 25
13. Bluetooth Exclusions Applied 45
14. Antenna Location 46
15. SAR Test Results 47
15.1 Head SAR 49
15.2 Hotspot SAR 52
15.3 Body Worn Accessory SAR 55
15.4 Repeated SAR Measurement 57
16. Simultaneous Transmission Analysis 58
16.1 Head Exposure Conditions 59
16.2 Hotspot Exposure Conditions 60
16.3 Body-Worn Accessory Exposure Conditions 62
17. Uncertainty Assessment 63
18. References 65
Appendix A. Plots of System Performance Check
Appendix B. Plots of High SAR Measurement
Appendix C. DASy Calibration Certificate
Appendix D. Test Setup Photos



Revision History

REPORT NO.	VERSION	DESCRIPTION	ISSUED DATE
FA670610	Rev. 01	Initial issue of report	Aug. 19, 2016



1. Statement of Compliance

The maximum results of Specific Absorption Rate (SAR) found during testing for **Brightstar Corporation, Mobile Phone, Avvio L640** are as follows.

Equipment Class	Frequency Band		Highest 1g SAR Summary			Highest Simultaneous Transmission 1g SAR (W/kg)
			Head (Separation 0mm)	Body-worn (Separation 10mm)	Hotspot (Separation 10mm)	
			1g SAR (W/kg)			
Licensed	GSM	GSM850	0.26	0.42	0.42	0.98
		GSM1900	<0.10	0.50	0.71	
	WCDMA	Band V	0.14	0.22	0.22	
		Band II	0.14	0.55	0.79	
	LTE	Band 28	<0.10	0.10	0.10	
		Band 4	0.13	0.62	0.98	
		Band 2	0.11	0.43	0.63	
	Band 7	<0.10	0.37	0.42		
DTS	WLAN	2.4GHz WLAN	<0.10	<0.10	<0.10	0.98
Date of Testing:			2016/08/02 ~ 2016/08/12			

This device is in compliance with Specific Absorption Rate (SAR) for general population/uncontrolled exposure limits (1.6 W/kg) specified in FCC 47 CFR part 2 (2.1093) and ANSI/IEEE C95.1-1992, and had been tested in accordance with the measurement methods and procedures specified in IEEE 1528-2013 and FCC KDB publications



2. Administration Data

Testing Laboratory	
Test Site	SPORTON INTERNATIONAL (SHENZHEN) INC.
Test Site Location	1F & 2F, Building A, Morning Business Center, No. 4003 ShiGu Rd., Xili Town, Nanshan District, Shenzhen, Guangdong, P. R. China TEL: +86-755-8637-9589 FAX: +86-755-8637-9595

Applicant	
Company Name	Brightstar Corporation
Address	9725 NW 117th Ave., Miami, Florida, FL 33178, United States

Manufacturer	
Company Name	Heng Da Chuang Xin Technology Limited
Address	Rm14H Taibang Building, 4 Rd. High Tech South, Nanshan, SZ, P. R. C. 518000

3. Guidance Standard

The Specific Absorption Rate (SAR) testing specification, method, and procedure for this device is in accordance with the following standards:

- FCC 47 CFR Part 2 (2.1093)
- ANSI/IEEE C95.1-1992
- IEEE 1528-2013
- FCC KDB 865664 D01 SAR Measurement 100 MHz to 6 GHz v01r04
- FCC KDB 865664 D02 SAR Reporting v01r02
- FCC KDB 447498 D01 General RF Exposure Guidance v06
- FCC KDB 648474 D04 SAR Evaluation Considerations for Wireless Handsets v01r03
- FCC KDB 248227 D01 802.11 Wi-Fi SAR v02r02
- FCC KDB 941225 D01 3G SAR Procedures v03r01
- FCC KDB 941225 D05 SAR for LTE Devices v02r05
- FCC KDB 941225 D06 Hotspot Mode SAR v02r01

4. Equipment Under Test (EUT) Information

4.1 General Information

Product Feature & Specification	
Equipment Name	Mobile Phone
Brand Name	Avvio
Model Name	Avvio L640
FCC ID	WVBAL640X
IMEI Code	357275070002222
Wireless Technology and Frequency Range	GSM850: 824.2 MHz ~ 848.8 MHz GSM1900: 1850.2 MHz ~ 1909.8 MHz WCDMA Band II: 1852.4 MHz ~ 1907.6 MHz WCDMA Band V: 826.4 MHz ~ 846.6 MHz LTE Band 2: 1850.7 MHz ~ 1909.3 MHz LTE Band 4: 1710.7 MHz ~ 1754.3 MHz LTE Band 7: 2502.5 MHz ~ 2567.5 MHz LTE Band 28: 704.5 MHz ~ 746.5 MHz WLAN 2.4GHz Band: 2412 MHz ~ 2462 MHz Bluetooth: 2402 MHz ~ 2480 MHz
Mode	<ul style="list-style-type: none"> · GSM/GPRS/EGPRS · RMC/AMR 12.2Kbps · HSDPA · HSUPA · DC-HSDPA · HSPA+ · LTE: QPSK, 16QAM · 802.11b/g/n HT20/HT40 · Bluetooth v3.0+EDR, Bluetooth v4.0 LE
HW Version	V03
SW Version	Avvio_L640_Claro_V1.00
GSM / (E)GPRS Transfer mode	Class B – EUT cannot support Packet Switched and Circuit Switched Network simultaneously but can automatically switch between Packet and Circuit Switched Network.
EUT Stage	Production Unit
Remark: <ol style="list-style-type: none"> 1. This device 2.4GHz WLAN supports Hotspot operation. 2. This device supported VoIP in GPRS, EGRPS, WCDMA and LTE (e.g. 3rd party VoIP). 3. This device supports GRPS/EGRPS mode up to multi-slot class 12. 4. This device does not support DTM operation. 	



4.2 General LTE SAR Test and Reporting Considerations

Summarized necessary items addressed in KDB 941225 D05 v02r05																																							
FCC ID	WVBAL640X																																						
Equipment Name	Mobile Phone																																						
Operating Frequency Range of each LTE transmission band	LTE Band 2: 1850.7 MHz ~ 1909.3 MHz LTE Band 4: 1710.7 MHz ~ 1754.3 MHz LTE Band 7: 2502.5 MHz ~ 2567.5 MHz LTE Band 28: 704.5 MHz ~ 746.5 MHz																																						
Channel Bandwidth	LTE Band 2: 1.4MHz, 3MHz, 5MHz, 10MHz, 15MHz, 20MHz LTE Band 4: 1.4MHz, 3MHz, 5MHz, 10MHz, 15MHz, 20MHz LTE Band 7: 5MHz, 10MHz, 15MHz, 20MHz LTE Band 28: 3MHz, 5MHz, 10MHz, 15MHz, 20MHz																																						
uplink modulations used	QPSK, and 16QAM																																						
LTE Voice / Data requirements	Data only																																						
LTE MPR permanently built-in by design	<p style="text-align: center;">Table 6.2.3-1: Maximum Power Reduction (MPR) for Power Class 3</p> <table border="1"> <thead> <tr> <th rowspan="2">Modulation</th> <th colspan="6">Channel bandwidth / Transmission bandwidth (RB)</th> <th rowspan="2">MPR (dB)</th> </tr> <tr> <th>1.4 MHz</th> <th>3.0 MHz</th> <th>5 MHz</th> <th>10 MHz</th> <th>15 MHz</th> <th>20 MHz</th> </tr> </thead> <tbody> <tr> <td>QPSK</td> <td>>5</td> <td>>4</td> <td>>8</td> <td>>12</td> <td>>16</td> <td>>18</td> <td>≤ 1</td> </tr> <tr> <td>16 QAM</td> <td>≤ 5</td> <td>≤ 4</td> <td>≤ 8</td> <td>≤ 12</td> <td>≤ 16</td> <td>≤ 18</td> <td>≤ 1</td> </tr> <tr> <td>16 QAM</td> <td>>5</td> <td>>4</td> <td>>8</td> <td>>12</td> <td>>16</td> <td>>18</td> <td>≤ 2</td> </tr> </tbody> </table>	Modulation	Channel bandwidth / Transmission bandwidth (RB)						MPR (dB)	1.4 MHz	3.0 MHz	5 MHz	10 MHz	15 MHz	20 MHz	QPSK	>5	>4	>8	>12	>16	>18	≤ 1	16 QAM	≤ 5	≤ 4	≤ 8	≤ 12	≤ 16	≤ 18	≤ 1	16 QAM	>5	>4	>8	>12	>16	>18	≤ 2
Modulation	Channel bandwidth / Transmission bandwidth (RB)						MPR (dB)																																
	1.4 MHz	3.0 MHz	5 MHz	10 MHz	15 MHz	20 MHz																																	
QPSK	>5	>4	>8	>12	>16	>18	≤ 1																																
16 QAM	≤ 5	≤ 4	≤ 8	≤ 12	≤ 16	≤ 18	≤ 1																																
16 QAM	>5	>4	>8	>12	>16	>18	≤ 2																																
LTE A-MPR	In the base station simulator configuration, Network Setting value is set to NS_01 to disable A-MPR during SAR testing and the LTE SAR tests was transmitting on all TTI frames (Maximum TTI)																																						
Spectrum plots for RB configuration	A properly configured base station simulator was used for the SAR and power measurement; therefore, spectrum plots for each RB allocation and offset configuration are not included in the SAR report.																																						
LTE Release	R9,Cat 4																																						



Transmission (H, M, L) channel numbers and frequencies in each LTE band												
LTE Band 2												
	Bandwidth 1.4 MHz		Bandwidth 3 MHz		Bandwidth 5 MHz		Bandwidth 10 MHz		Bandwidth 15 MHz		Bandwidth 20 MHz	
	Ch. #	Freq. (MHz)	Ch. #	Freq. (MHz)	Ch. #	Freq. (MHz)	Ch. #	Freq. (MHz)	Ch. #	Freq. (MHz)	Ch. #	Freq. (MHz)
L	18607	1850.7	18615	1851.5	18625	1852.5	18650	1855	18675	1857.5	18700	1860
M	18900	1880	18900	1880	18900	1880	18900	1880	18900	1880	18900	1880
H	19193	1909.3	19185	1908.5	19175	1907.5	19150	1905	19125	1902.5	19100	1900
LTE Band 4												
	Bandwidth 1.4 MHz		Bandwidth 3 MHz		Bandwidth 5 MHz		Bandwidth 10 MHz		Bandwidth 15 MHz		Bandwidth 20 MHz	
	Ch. #	Freq. (MHz)	Ch. #	Freq. (MHz)	Ch. #	Freq. (MHz)	Ch. #	Freq. (MHz)	Ch. #	Freq. (MHz)	Ch. #	Freq. (MHz)
L	19957	1710.7	19965	1711.5	19975	1712.5	20000	1715	20025	1717.5	20050	1720
M	20175	1732.5	20175	1732.5	20175	1732.5	20175	1732.5	20175	1732.5	20175	1732.5
H	20393	1754.3	20385	1753.5	20375	1752.5	20350	1750	20325	1747.5	20300	1745
LTE Band 7												
	Bandwidth 5 MHz		Bandwidth 10 MHz		Bandwidth 15 MHz		Bandwidth 20 MHz					
	Ch. #	Freq. (MHz)	Ch. #	Freq. (MHz)	Ch. #	Freq. (MHz)	Ch. #	Freq. (MHz)				
L	20775	2502.5	20800	2505	20825	2507.5	20850	2510				
M	21100	2535	21100	2535	21100	2535	21100	2535				
H	21425	2567.5	21400	2565	21375	2562.5	21350	2560				
LTE Band 28												
	Bandwidth 3 MHz		Bandwidth 5 MHz		Bandwidth 10 MHz		Bandwidth 15 MHz		Bandwidth 20 MHz			
	Ch. #	Freq. (MHz)	Ch. #	Freq. (MHz)	Ch. #	Freq. (MHz)	Ch. #	Freq. (MHz)	Ch. #	Freq. (MHz)		
L	27225	704.5	27235	705.5	27260	708	27285	710.5	27310	713		
M	27410	723	27410	723	27410	723	27410	723	27410	723		
H	27645	746.5	27635	745.5	27610	743	27585	740.5	27560	738		



5. RF Exposure Limits

5.1 Uncontrolled Environment

Uncontrolled Environments are defined as locations where there is the exposure of individuals who have no knowledge or control of their exposure. The general population/uncontrolled exposure limits are applicable to situations in which the general public may be exposed or in which persons who are exposed as a consequence of their employment may not be made fully aware of the potential for exposure or cannot exercise control over their exposure. Members of the general public would come under this category when exposure is not employment-related; for example, in the case of a wireless transmitter that exposes persons in its vicinity.

5.2 Controlled Environment

Controlled Environments are defined as locations where there is exposure that may be incurred by persons who are aware of the potential for exposure, (i.e. as a result of employment or occupation). In general, occupational/controlled exposure limits are applicable to situations in which persons are exposed as a consequence of their employment, who have been made fully aware of the potential for exposure and can exercise control over their exposure. The exposure category is also applicable when the exposure is of a transient nature due to incidental passage through a location where the exposure levels may be higher than the general population/uncontrolled limits, but the exposed person is fully aware of the potential for exposure and can exercise control over his or her exposure by leaving the area or by some other appropriate means.

Limits for Occupational/Controlled Exposure (W/kg)

Whole-Body	Partial-Body	Hands, Wrists, Feet and Ankles
0.4	8.0	20.0

Limits for General Population/Uncontrolled Exposure (W/kg)

Whole-Body	Partial-Body	Hands, Wrists, Feet and Ankles
0.08	1.6	4.0

1. Whole-Body SAR is averaged over the entire body, partial-body SAR is averaged over any 1gram of tissue defined as a tissue volume in the shape of a cube. SAR for hands, wrists, feet and ankles is averaged over any 10 grams of tissue defined as a tissue volume in the shape of a cube.

6. Specific Absorption Rate (SAR)

6.1 Introduction

SAR is related to the rate at which energy is absorbed per unit mass in an object exposed to a radio field. The SAR distribution in a biological body is complicated and is usually carried out by experimental techniques or numerical modeling. The standard recommends limits for two tiers of groups, occupational/controlled and general population/uncontrolled, based on a person's awareness and ability to exercise control over his or her exposure. In general, occupational/controlled exposure limits are higher than the limits for general population/uncontrolled.

6.2 SAR Definition

The SAR definition is the time derivative (rate) of the incremental energy (dW) absorbed by (dissipated in) an incremental mass (dm) contained in a volume element (dv) of a given density (ρ). The equation description is as below:

$$SAR = \frac{d}{dt} \left(\frac{dW}{dm} \right) = \frac{d}{dt} \left(\frac{dW}{\rho dv} \right)$$

SAR is expressed in units of Watts per kilogram (W/kg)

$$SAR = \frac{\sigma |E|^2}{\rho}$$

Where: σ is the conductivity of the tissue, ρ is the mass density of the tissue and E is the RMS electrical field strength.

7. System Description and Setup

The DASY system used for performing compliance tests consists of the following items:

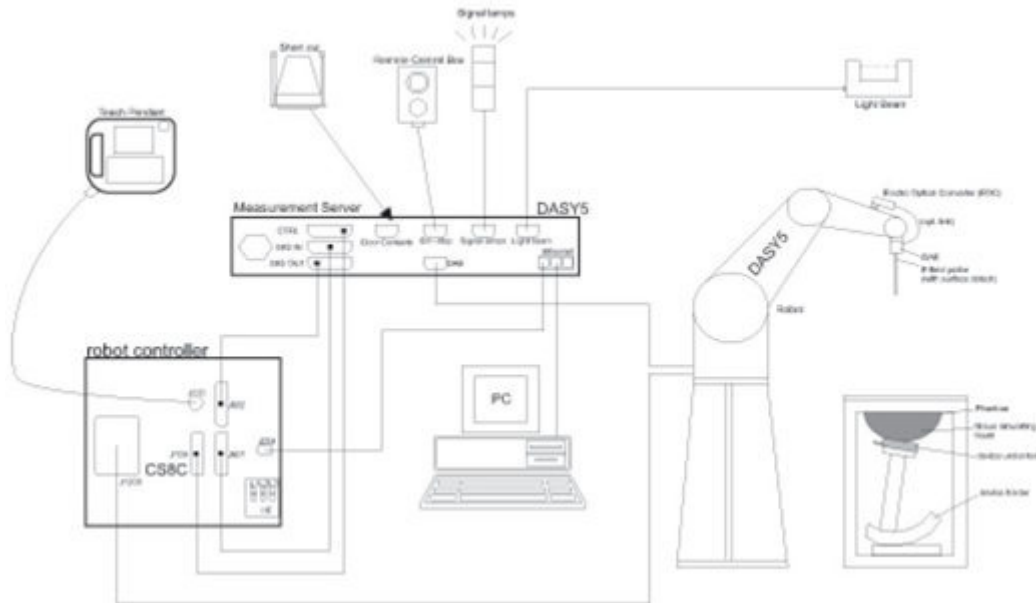

- A standard high precision 6-axis robot with controller, teach pendant and software. An arm extension for accommodating the data acquisition electronics (DAE).
- An isotropic Field probe optimized and calibrated for the targeted measurement.
- A data acquisition electronics (DAE) which performs the signal amplification, signal multiplexing, AD-conversion, offset measurements, mechanical surface detection, collision detection, etc. The unit is battery powered with standard or rechargeable batteries. The signal is optically transmitted to the EOC.
- The Electro-optical converter (EOC) performs the conversion from optical to electrical signals for the digital communication to the DAE. To use optical surface detection, a special version of the EOC is required. The EOC signal is transmitted to the measurement server.
- The function of the measurement server is to perform the time critical tasks such as signal filtering, control of the robot operation and fast movement interrupts.
- The Light Beam used is for probe alignment. This improves the (absolute) accuracy of the probe positioning.
- A computer running WinXP or Win7 and the DASY5 software.
- Remote control and teach pendant as well as additional circuitry for robot safety such as warning lamps, etc.
- The phantom, the device holder and other accessories according to the targeted measurement.

7.1 E-Field Probe

The SAR measurement is conducted with the dosimetric probe (manufactured by SPEAG).The probe is specially designed and calibrated for use in liquid with high permittivity. The dosimetric probe has special calibration in liquid at different frequency. This probe has a built in optical surface detection system to prevent from collision with phantom.

<EX3DV4 Probe>

Construction	Symmetric design with triangular core Built-in shielding against static charges PEEK enclosure material (resistant to organic solvents, e.g., DGBE)	
Frequency	10 MHz – >6 GHz Linearity: ±0.2 dB (30 MHz – 6 GHz)	
Directivity	±0.3 dB in TSL (rotation around probe axis) ±0.5 dB in TSL (rotation normal to probe axis)	
Dynamic Range	10 µW/g – >100 mW/g Linearity: ±0.2 dB (noise: typically <1 µW/g)	
Dimensions	Overall length: 337 mm (tip: 20 mm) Tip diameter: 2.5 mm (body: 12 mm) Typical distance from probe tip to dipole centers: 1 mm	

7.2 Data Acquisition Electronics (DAE)

The data acquisition electronics (DAE) consists of a highly sensitive electrometer-grade preamplifier with auto-zeroing, a channel and gain-switching multiplexer, a fast 16 bit AD-converter and a command decoder and control logic unit. Transmission to the measurement server is accomplished through an optical downlink for data and status information as well as an optical uplink for commands and the clock.

The input impedance of the DAE is 200 MOhm; the inputs are symmetrical and floating. Common mode rejection is above 80 dB.



Fig 5.1 Photo of DAE

7.3 Phantom

<SAM Twin Phantom>

Shell Thickness	2 ± 0.2 mm; Center ear point: 6 ± 0.2 mm
Filling Volume	Approx. 25 liters
Dimensions	Length: 1000 mm; Width: 500 mm; Height: adjustable feet
Measurement Areas	Left Hand, Right Hand, Flat Phantom



The bottom plate contains three pair of bolts for locking the device holder. The device holder positions are adjusted to the standard measurement positions in the three sections. A white cover is provided to tap the phantom during off-periods to prevent water evaporation and changes in the liquid parameters. On the phantom top, three reference markers are provided to identify the phantom position with respect to the robot.

<ELI Phantom>

Shell Thickness	2 ± 0.2 mm (sagging: <1%)
Filling Volume	Approx. 30 liters
Dimensions	Major ellipse axis: 600 mm Minor axis: 400 mm

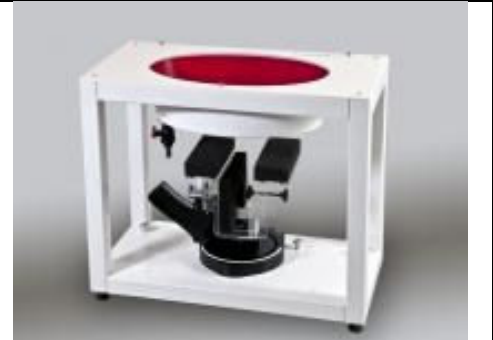

The ELI phantom is intended for compliance testing of handheld and body-mounted wireless devices in the frequency range of 30 MHz to 6 GHz. ELI4 is fully compatible with standard and all known tissue simulating liquids.

7.4 Device Holder

<Mounting Device for Hand-Held Transmitter>

In combination with the Twin SAM V5.0/V5.0c or ELI phantoms, the Mounting Device for Hand-Held Transmitters enables rotation of the mounted transmitter device to specified spherical coordinates. At the heads, the rotation axis is at the ear opening. Transmitter devices can be easily and accurately positioned according to IEC 62209-1, IEEE 1528, FCC, or other specifications. The device holder can be locked for positioning at different phantom sections (left head, right head, flat). And upgrade kit to Mounting Device to enable easy mounting of wider devices like big smart-phones, e-books, small tablets, etc. It holds devices with width up to 140 mm.



Mounting Device for Hand-Held Transmitters



Mounting Device Adaptor for Wide-Phones

<Mounting Device for Laptops and other Body-Worn Transmitters>

The extension is lightweight and made of POM, acrylic glass and foam. It fits easily on the upper part of the mounting device in place of the phone positioned. The extension is fully compatible with the SAM Twin and ELI phantoms.



Mounting Device for Laptops

8. Measurement Procedures

The measurement procedures are as follows:

<Conducted power measurement>

- (a) For WWAN power measurement, use base station simulator to configure EUT WWAN transmission in conducted connection with RF cable, at maximum power in each supported wireless interface and frequency band.
- (b) Read the WWAN RF power level from the base station simulator.
- (c) For WLAN/BT power measurement, use engineering software to configure EUT WLAN/BT continuously transmission, at maximum RF power in each supported wireless interface and frequency band
- (d) Connect EUT RF port through RF cable to the power meter, and measure WLAN/BT output power

<SAR measurement>

- (a) Use base station simulator to configure EUT WWAN transmission in radiated connection, and engineering software to configure EUT WLAN/BT continuously transmission, at maximum RF power, in the highest power channel.
- (b) Place the EUT in the positions as Appendix D demonstrates.
- (c) Set scan area, grid size and other setting on the DASY software.
- (d) Measure SAR results for the highest power channel on each testing position.
- (e) Find out the largest SAR result on these testing positions of each band
- (f) Measure SAR results for other channels in worst SAR testing position if the reported SAR of highest power channel is larger than 0.8 W/kg

According to the test standard, the recommended procedure for assessing the peak spatial-average SAR value consists of the following steps:

- (a) Power reference measurement
- (b) Area scan
- (c) Zoom scan
- (d) Power drift measurement

8.1 Spatial Peak SAR Evaluation

The procedure for spatial peak SAR evaluation has been implemented according to the test standard. It can be conducted for 1g and 10g, as well as for user-specific masses. The DASY software includes all numerical procedures necessary to evaluate the spatial peak SAR value.

The base for the evaluation is a "cube" measurement. The measured volume must include the 1g and 10g cubes with the highest averaged SAR values. For that purpose, the center of the measured volume is aligned to the interpolated peak SAR value of a previously performed area scan.

The entire evaluation of the spatial peak values is performed within the post-processing engine (SEMCAD). The system always gives the maximum values for the 1g and 10g cubes. The algorithm to find the cube with highest averaged SAR is divided into the following stages:

- (a) Extraction of the measured data (grid and values) from the Zoom Scan
- (b) Calculation of the SAR value at every measurement point based on all stored data (A/D values and measurement parameters)
- (c) Generation of a high-resolution mesh within the measured volume
- (d) Interpolation of all measured values from the measurement grid to the high-resolution grid
- (e) Extrapolation of the entire 3-D field distribution to the phantom surface over the distance from sensor to surface
- (f) Calculation of the averaged SAR within masses of 1g and 10g

8.2 Power Reference Measurement

The Power Reference Measurement and Power Drift Measurements are for monitoring the power drift of the device under test in the batch process. The minimum distance of probe sensors to surface determines the closest measurement point to phantom surface. This distance cannot be smaller than the distance of sensor calibration points to probe tip as defined in the probe properties.

8.3 Area Scan

The area scan is used as a fast scan in two dimensions to find the area of high field values, before doing a fine measurement around the hot spot. The sophisticated interpolation routines implemented in DASY software can find the maximum found in the scanned area, within a range of the global maximum. The range (in dB0) is specified in the standards for compliance testing. For example, a 2 dB range is required in IEEE standard 1528 and IEC 62209 standards, whereby 3 dB is a requirement when compliance is assessed in accordance with the ARIB standard (Japan), if only one zoom scan follows the area scan, then only the absolute maximum will be taken as reference. For cases where multiple maximums are detected, the number of zoom scans has to be increased accordingly.

Area scan parameters extracted from FCC KDB 865664 D01v01r04 SAR measurement 100 MHz to 6 GHz.

	≤ 3 GHz	> 3 GHz
Maximum distance from closest measurement point (geometric center of probe sensors) to phantom surface	5 ± 1 mm	$\frac{1}{2} \cdot \delta \cdot \ln(2) \pm 0.5$ mm
Maximum probe angle from probe axis to phantom surface normal at the measurement location	30° ± 1°	20° ± 1°
Maximum area scan spatial resolution: $\Delta x_{Area}, \Delta y_{Area}$	≤ 2 GHz: ≤ 15 mm 2 – 3 GHz: ≤ 12 mm	3 – 4 GHz: ≤ 12 mm 4 – 6 GHz: ≤ 10 mm
	When the x or y dimension of the test device, in the measurement plane orientation, is smaller than the above, the measurement resolution must be ≤ the corresponding x or y dimension of the test device with at least one measurement point on the test device.	

8.4 Zoom Scan

Zoom scans are used assess the peak spatial SAR values within a cubic averaging volume containing 1 gram and 10 gram of simulated tissue. The zoom scan measures points (refer to table below) within a cube shoes base faces are centered on the maxima found in a preceding area scan job within the same procedure. When the measurement is done, the zoom scan evaluates the averaged SAR for 1 gram and 10 gram and displays these values next to the job's label.

Zoom scan parameters extracted from FCC KDB 865664 D01v01r04 SAR measurement 100 MHz to 6 GHz.

		≤ 3 GHz	> 3 GHz	
Maximum zoom scan spatial resolution: $\Delta x_{Zoom}, \Delta y_{Zoom}$		≤ 2 GHz: ≤ 8 mm 2 – 3 GHz: ≤ 5 mm*	3 – 4 GHz: ≤ 5 mm* 4 – 6 GHz: ≤ 4 mm*	
Maximum zoom scan spatial resolution, normal to phantom surface	uniform grid: $\Delta z_{Zoom}(n)$	≤ 5 mm	3 – 4 GHz: ≤ 4 mm 4 – 5 GHz: ≤ 3 mm 5 – 6 GHz: ≤ 2 mm	
	graded grid	$\Delta z_{Zoom}(1)$: between 1 st two points closest to phantom surface	≤ 4 mm	3 – 4 GHz: ≤ 3 mm 4 – 5 GHz: ≤ 2.5 mm 5 – 6 GHz: ≤ 2 mm
		$\Delta z_{Zoom}(n>1)$: between subsequent points	$\leq 1.5 \cdot \Delta z_{Zoom}(n-1)$	
Minimum zoom scan volume	x, y, z	≥ 30 mm	3 – 4 GHz: ≥ 28 mm 4 – 5 GHz: ≥ 25 mm 5 – 6 GHz: ≥ 22 mm	
Note: δ is the penetration depth of a plane-wave at normal incidence to the tissue medium; see draft standard IEEE P1528-2011 for details. * When zoom scan is required and the <i>reported</i> SAR from the <i>area scan based 1-g SAR estimation</i> procedures of KDB 447498 is ≤ 1.4 W/kg, ≤ 8 mm, ≤ 7 mm and ≤ 5 mm zoom scan resolution may be applied, respectively, for 2 GHz to 3 GHz, 3 GHz to 4 GHz and 4 GHz to 6 GHz.				

8.5 Volume Scan Procedures

The volume scan is used for assess overlapping SAR distributions for antennas transmitting in different frequency bands. It is equivalent to an oversized zoom scan used in standalone measurements. The measurement volume will be used to enclose all the simultaneous transmitting antennas. For antennas transmitting simultaneously in different frequency bands, the volume scan is measured separately in each frequency band. In order to sum correctly to compute the 1g aggregate SAR, the EUT remain in the same test position for all measurements and all volume scan use the same spatial resolution and grid spacing. When all volume scan were completed, the software, SEMCAD postprocessor can combine and subsequently superpose these measurement data to calculating the multiband SAR.

8.6 Power Drift Monitoring

All SAR testing is under the EUT install full charged battery and transmit maximum output power. In DASY measurement software, the power reference measurement and power drift measurement procedures are used for monitoring the power drift of EUT during SAR test. Both these procedures measure the field at a specified reference position before and after the SAR testing. The software will calculate the field difference in dB. If the power drifts more than 5%, the SAR will be retested.



9. Test Equipment List

Manufacturer	Name of Equipment	Type/Model	Serial Number	Calibration	
				Last Cal.	Due Date
SPEAG	750MHz System Validation Kit	D750V3	1099	Nov. 24, 2015	Nov. 23, 2016
SPEAG	835MHz System Validation Kit	D835V2	4d162	Nov. 24, 2015	Nov. 23, 2016
SPEAG	1750MHz System Validation Kit	D1750V2	1137	May 18, 2016	May 17, 2017
SPEAG	1900MHz System Validation Kit	D1900V2	5d182	Nov. 23, 2015	Nov. 22, 2016
SPEAG	2450MHz System Validation Kit	D2450V2	924	Feb. 24, 2016	Feb. 23, 2017
SPEAG	2600MHz System Validation Kit	D2600V2	1070	Nov. 25, 2015	Nov. 24, 2016
SPEAG	Data Acquisition Electronics	DAE4	914	Jan. 07, 2016	Jan. 06, 2017
SPEAG	Dosimetric E-Field Probe	EX3DV4	3578	May 11, 2016	May 10, 2017
SPEAG	SAM Twin Phantom	QD 000 P40 CD	TP-1670	NCR	NCR
SPEAG	Phone Positioner	N/A	N/A	NCR	NCR
Anritsu	Radio communication analyzer	MT8820C	6201300653	Aug. 25, 2015	Aug. 24, 2016
Agilent	Wireless Communication Test Set	E5515C	MY50267224	Jul. 16, 2016	Jul. 15, 2017
Agilent	Network Analyzer	E5071C	MY46523671	Dec. 31, 2015	Dec. 30, 2016
Speag	Dielectric Assessment KIT	DAK-3.5	1071	Nov. 24, 2015	Nov. 23, 2016
Agilent	Signal Generator	N5181A	MY50145381	Jan. 12, 2016	Jan. 11, 2017
Anritsu	Power Sensor	MA2411B	1306099	Jan. 12, 2016	Jan. 11, 2017
Anritsu	Power Meter	ML2495A	1349001	Jan. 12, 2016	Jan. 11, 2017
Anritsu	Power Sensor	MA2411B	1207253	Jan. 12, 2016	Jan. 11, 2017
Anritsu	Power Meter	ML2495A	1218010	Jan. 12, 2016	Jan. 11, 2017
R&S	Spectrum Analyzer	FSP7	101634	Jul. 16, 2016	Jul. 15, 2017
ARRA	Power Divider	A3200-2	N/A	Note 1	
PASTERNAK	Dual Directional Coupler	PE2214-10	N/A	Note 1	
Agilent	Dual Directional Coupler	778D	50422	Note 1	
AR	Amplifier	5S1G4	333096	Note 1	
mini-circuits	Amplifier	ZVE-3W-83+	162601250	Note 1	
MCL	Attenuation1	BW-S10W5	N/A	Note 1	
Weinschel	Attenuation2	3M-20	N/A	Note 1	
Zhongjilianhe	Attenuation3	MVE2214-03	N/A	Note 1	

General Note:

1. Prior to system verification and validation, the path loss from the signal generator to the system check source and the power meter, which includes the amplifier, cable, attenuator and directional coupler, was measured by the network analyzer. The reading of the power meter was offset by the path loss difference between the path to the power meter and the path to the system check source to monitor the actual power level fed to the system check source.



10. System Verification

10.1 Tissue Verification

The following tissue formulations are provided for reference only as some of the parameters have not been thoroughly verified. The composition of ingredients may be modified accordingly to achieve the desired target tissue parameters required for routine SAR evaluation.

Frequency (MHz)	Water (%)	Sugar (%)	Cellulose (%)	Salt (%)	Preventol (%)	DGBE (%)	Conductivity (σ)	Permittivity (ϵ_r)
For Head								
750	41.1	57.0	0.2	1.4	0.2	0	0.89	41.9
835	40.3	57.9	0.2	1.4	0.2	0	0.90	41.5
1800, 1900, 2000	55.2	0	0	0.3	0	44.5	1.40	40.0
2450	55.0	0	0	0	0	45.0	1.80	39.2
2600	54.8	0	0	0.1	0	45.1	1.96	39.0
For Body								
750	51.7	47.2	0	0.9	0.1	0	0.96	55.5
835	50.8	48.2	0	0.9	0.1	0	0.97	55.2
1800, 1900, 2000	70.2	0	0	0.4	0	29.4	1.52	53.3
2450	68.6	0	0	0	0	31.4	1.95	52.7
2600	68.1	0	0	0.1	0	31.8	2.16	52.5

<Tissue Dielectric Parameter Check Results>

Frequency (MHz)	Tissue Type	Liquid Temp. (°C)	Conductivity (σ)	Permittivity (ϵ_r)	Conductivity Target (σ)	Permittivity Target (ϵ_r)	Delta (σ) (%)	Delta (ϵ_r) (%)	Limit (%)	Date
750	Head	22.6	0.880	40.797	0.89	41.90	-1.12	-2.63	±5	2016/8/4
835	Head	22.5	0.886	41.952	0.90	41.50	-1.56	1.09	±5	2016/8/4
1750	Head	22.7	1.373	41.392	1.37	40.10	0.22	3.22	±5	2016/8/5
1900	Head	22.6	1.415	41.124	1.40	40.00	1.07	2.81	±5	2016/8/5
2450	Head	22.5	1.746	39.247	1.80	39.20	-3.00	0.12	±5	2016/8/12
2600	Head	22.5	2.050	38.344	1.96	39.00	4.59	-1.68	±5	2016/8/5
750	Body	22.6	0.961	53.914	0.96	55.50	0.10	-2.86	±5	2016/8/2
835	Body	22.6	1.011	56.243	0.97	55.20	4.23	1.89	±5	2016/8/2
1750	Body	22.8	1.527	52.020	1.49	53.40	2.48	-2.58	±5	2016/8/3
1900	Body	22.7	1.508	54.618	1.52	53.30	-0.79	2.47	±5	2016/8/3
2450	Body	22.8	1.909	50.971	1.95	52.70	-2.10	-3.28	±5	2016/8/12
2600	Body	22.9	2.165	53.823	2.16	52.50	0.23	2.52	±5	2016/8/4

10.2 System Performance Check Results

Comparing to the original SAR value provided by SPEAG, the verification data should be within its specification of 10 %. Below table shows the target SAR and measured SAR after normalized to 1W input power. The table below indicates the system performance check can meet the variation criterion and the plots can be referred to Appendix A of this report.

Date	Frequency (MHz)	Tissue Type	Input Power (mW)	Dipole S/N	Probe S/N	DAE S/N	Measured 1g SAR (W/kg)	Targeted 1g SAR (W/kg)	Normalized 1g SAR (W/kg)	Deviation (%)
2016/8/4	750	Head	250	D750V3-1099	EX3DV4 - SN3578	DAE4 Sn914	2.09	8.17	8.36	2.33
2016/8/4	835	Head	250	D835V2-4d162	EX3DV4 - SN3578	DAE4 Sn914	2.28	9.14	9.12	-0.22
2016/8/5	1750	Head	250	D1750V2-1137	EX3DV4 - SN3578	DAE4 Sn914	9.66	36.50	38.64	5.86
2016/8/5	1900	Head	250	D1900V2-5d182	EX3DV4 - SN3578	DAE4 Sn914	10.20	39.60	40.8	3.03
2016/8/12	2450	Head	250	D2450V2-924	EX3DV4 - SN3578	DAE4 Sn914	12.80	52.50	51.2	-2.48
2016/8/5	2600	Head	250	D2600V2-1070	EX3DV4 - SN3578	DAE4 Sn914	14.80	58.10	59.2	1.89
2016/8/2	750	Body	250	D750V3-1099	EX3DV4 - SN3578	DAE4 Sn914	2.15	8.82	8.6	-2.49
2016/8/2	835	Body	250	D835V2-4d162	EX3DV4 - SN3578	DAE4 Sn914	2.44	9.51	9.76	2.63
2016/8/3	1750	Body	250	D1750V2-1137	EX3DV4 - SN3578	DAE4 Sn914	8.86	37.40	35.44	-5.24
2016/8/3	1900	Body	250	D1900V2-5d182	EX3DV4 - SN3578	DAE4 Sn914	9.84	40.60	39.36	-3.05
2016/8/12	2450	Body	250	D2450V2-924	EX3DV4 - SN3578	DAE4 Sn914	13.40	51.40	53.6	4.28
2016/8/4	2600	Body	250	D2600V2-1070	EX3DV4 - SN3578	DAE4 Sn914	13.50	54.20	54	-0.37

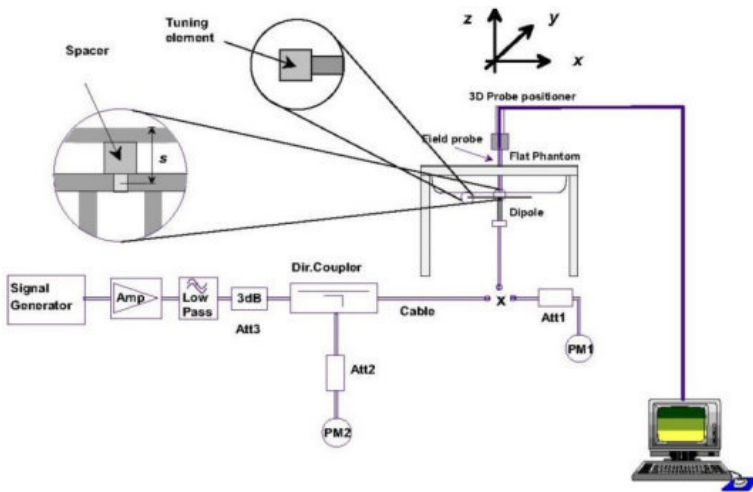

Fig 8.3.1 System Performance Check Setup

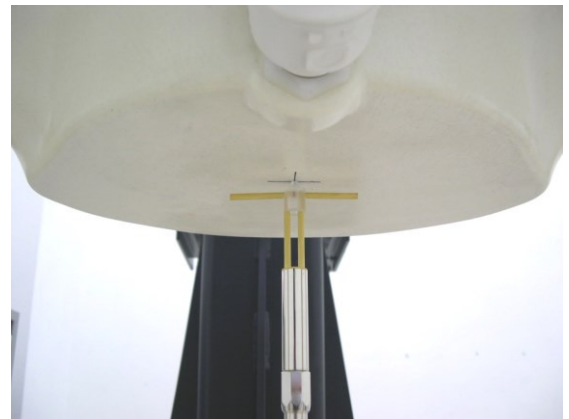

Fig 8.3.2 Setup Photo

11. RF Exposure Positions

11.1 Ear and handset reference point

Figure 9.1.1 shows the front, back, and side views of the SAM phantom. The center-of-mouth reference point is labeled “M,” the left ear reference point (ERP) is marked “LE,” and the right ERP is marked “RE.” Each ERP is 15 mm along the B-M (back-mouth) line behind the entrance-to-ear-canal (EEC) point, as shown in Figure 9.1.2 The Reference Plane is defined as passing through the two ear reference points and point M. The line N-F (neck-front), also called the reference pivoting line, is normal to the Reference Plane and perpendicular to both a line passing through RE and LE and the B-M line (see Figure 9.1.3). Both N-F and B-M lines should be marked on the exterior of the phantom shell to facilitate handset positioning. Posterior to the N-F line the ear shape is a flat surface with 6 mm thickness at each ERP, and forward of the N-F line the ear is truncated, as illustrated in Figure 9.1.2. The ear truncation is introduced to preclude the ear lobe from interfering with handset tilt, which could lead to unstable positioning at the cheek.

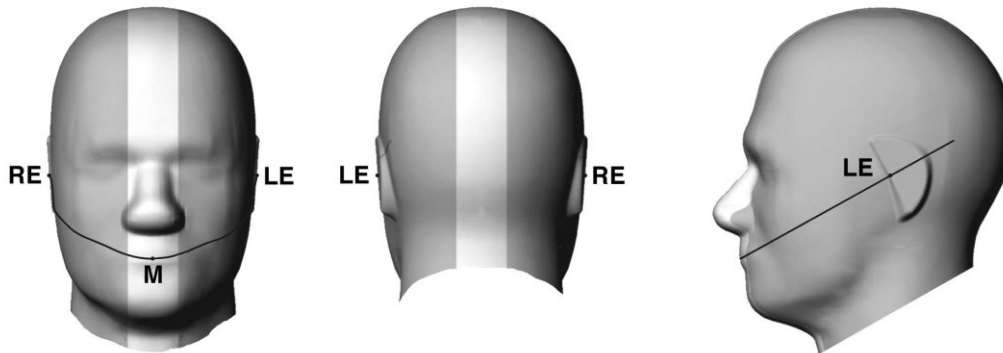

Fig 9.1.1 Front, back, and side views of SAM twin phantom

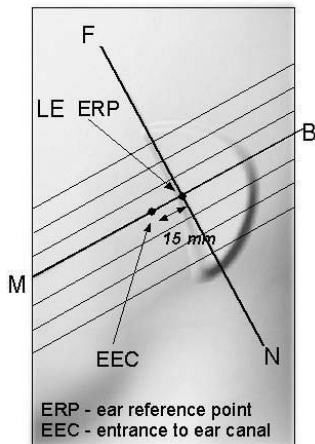

Fig 9.1.2 Close-up side view of phantom showing the ear region.

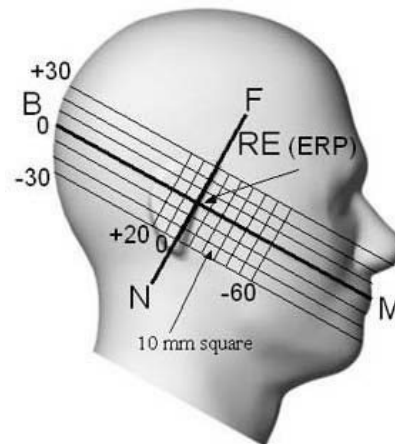

Fig 9.1.3 Side view of the phantom showing relevant markings and seven cross-sectional plane locations

11.2 Definition of the cheek position

1. Ready the handset for talk operation, if necessary. For example, for handsets with a cover piece (flip cover), open the cover. If the handset can transmit with the cover closed, both configurations must be tested.
2. Define two imaginary lines on the handset—the vertical centerline and the horizontal line. The vertical centerline passes through two points on the front side of the handset—the midpoint of the width w_t of the handset at the level of the acoustic output (point A in Figure 9.2.1 and Figure 9.2.2), and the midpoint of the width w_b of the bottom of the handset (point B). The horizontal line is perpendicular to the vertical centerline and passes through the center of the acoustic output (see Figure 9.2.1). The two lines intersect at point A. Note that for many handsets, point A coincides with the center of the acoustic output; however, the acoustic output may be located elsewhere on the horizontal line. Also note that the vertical centerline is not necessarily parallel to the front face of the handset (see Figure 9.2.2), especially for clamshell handsets, handsets with flip covers, and other irregularly-shaped handsets.
3. Position the handset close to the surface of the phantom such that point A is on the (virtual) extension of the line passing through points RE and LE on the phantom (see Figure 9.2.3), such that the plane defined by the vertical centerline and the horizontal line of the handset is approximately parallel to the sagittal plane of the phantom.
4. Translate the handset towards the phantom along the line passing through RE and LE until handset point A touches the pinna at the ERP.
5. While maintaining the handset in this plane, rotate it around the LE-RE line until the vertical centerline is in the plane normal to the plane containing B-M and N-F lines, i.e., the Reference Plane.
6. Rotate the handset around the vertical centerline until the handset (horizontal line) is parallel to the N-F line.
7. While maintaining the vertical centerline in the Reference Plane, keeping point A on the line passing through RE and LE, and maintaining the handset contact with the pinna, rotate the handset about the N-F line until any point on the handset is in contact with a phantom point below the pinna on the cheek. See Figure 9.2.3. The actual rotation angles should be documented in the test report.

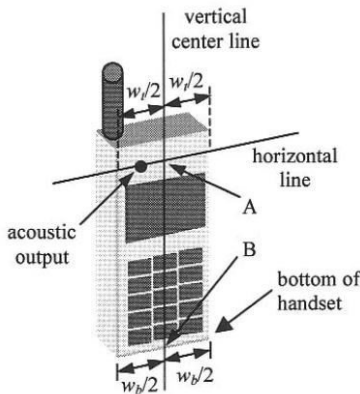

Fig 9.2.1 Handset vertical and horizontal reference lines—“fixed case”

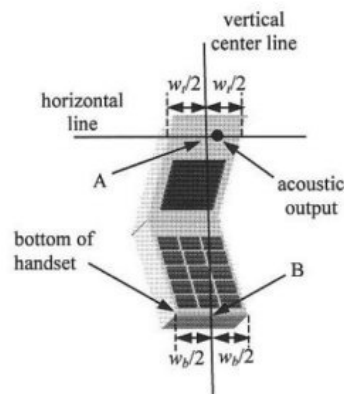

Fig 9.2.2 Handset vertical and horizontal reference lines—“clam-shell case”

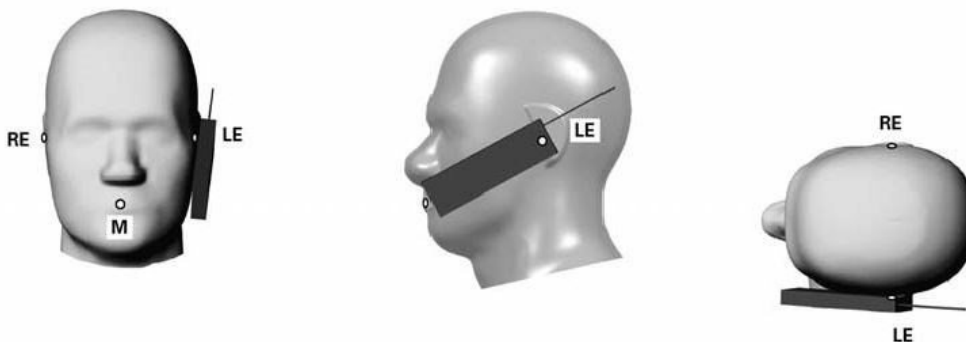

Fig 9.2.3 cheek or touch position. The reference points for the right ear (RE), left ear (LE), and mouth (M), which establish the Reference Plane for handset positioning, are indicated.

11.3 Definition of the tilt position

1. Ready the handset for talk operation, if necessary. For example, for handsets with a cover piece (flip cover), open the cover. If the handset can transmit with the cover closed, both configurations must be tested.
2. While maintaining the orientation of the handset, move the handset away from the pinna along the line passing through RE and LE far enough to allow a rotation of the handset away from the cheek by 15°.
3. Rotate the handset around the horizontal line by 15°.
4. While maintaining the orientation of the handset, move the handset towards the phantom on the line passing through RE and LE until any part of the handset touches the ear. The tilt position is obtained when the contact point is on the pinna. See Figure 9.3.1. If contact occurs at any location other than the pinna, e.g., the antenna at the back of the phantom head, the angle of the handset should be reduced. In this case, the tilt position is obtained if any point on the handset is in contact with the pinna and a second point

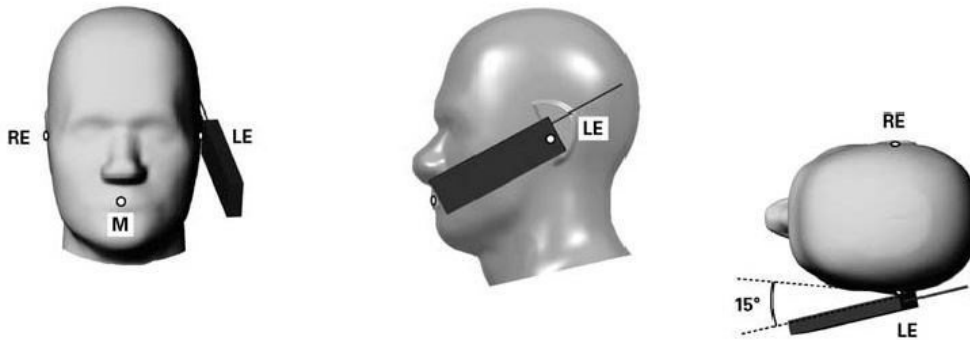

Fig 9.3.1 Tilt position. The reference points for the right ear (RE), left ear (LE), and mouth (M), which define the Reference Plane for handset positioning, are indicated.

11.4 Body Worn Accessory

Body-worn operating configurations are tested with the belt-clips and holsters attached to the device and positioned against a flat phantom in a normal use configuration (see Figure 9.4). Per KDB648474 D04v01r03, body-worn accessory exposure is typically related to voice mode operations when handsets are carried in body-worn accessories. The body-worn accessory procedures in FCC KDB 447498 D01v06 should be used to test for body-worn accessory SAR compliance, without a headset connected to it. This enables the test results for such configuration to be compatible with that required for hotspot mode when the body-worn accessory test separation distance is greater than or equal to that required for hotspot mode, when applicable. When the reported SAR for body-worn accessory, measured without a headset connected to the handset is $< 1.2 \text{ W/kg}$, the highest reported SAR configuration for that wireless mode and frequency band should be repeated for that body-worn accessory with a handset attached to the handset.

Accessories for body-worn operation configurations are divided into two categories: those that do not contain metallic components and those that do contain metallic components and those that do contain metallic components. When multiple accessories that do not contain metallic components are supplied with the device, the device is tested with only the accessory that dictates the closest spacing to the body. Then multiple accessories that contain metallic components are test with the device with each accessory. If multiple accessories share an identical metallic component (i.e. the same metallic belt-clip used with different holsters with no other metallic components) only the accessory that dictates the closest spacing to the body is tested.

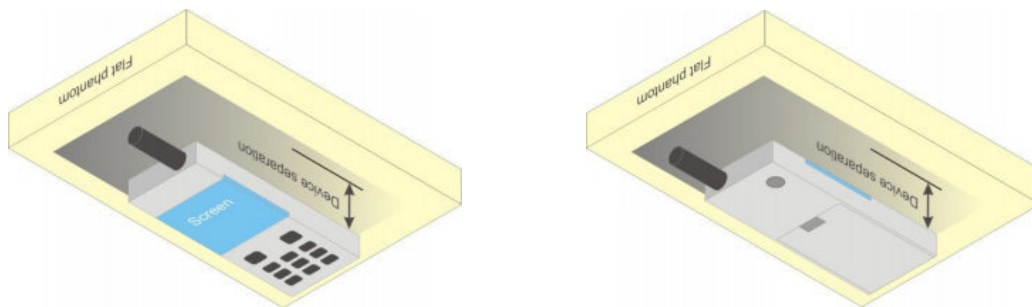

Fig 9.4 Body Worn Position

11.5 Wireless Router

Some battery-operated handsets have the capability to transmit and receive user through simultaneous transmission of WIFI simultaneously with a separate licensed transmitter. The FCC has provided guidance in FCC KDB Publication 941225 D06 v02r01 where SAR test considerations for handsets ($L \times W \geq 9 \text{ cm} \times 5 \text{ cm}$) are based on a composite test separation distance of 10mm from the front, back and edges of the device containing transmitting antennas within 2.5cm of their edges, determined from general mixed use conditions for this type of devices. Since the hotspot SAR results may overlap with the body-worn accessory SAR requirements, the more conservative configurations can be considered, thus excluding some body-worn accessory SAR tests.

When the user enables the personal wireless router functions for the handset, actual operations include simultaneous transmission of both the WIFI transmitter and another licensed transmitter. Both transmitters often do not transmit at the same transmitting frequency and thus cannot be evaluated for SAR under actual use conditions due to the limitations of the SAR assessment probes. Therefore, SAR must be evaluated for each frequency transmission and mode separately and spatially summed with the WIFI transmitter according to FCC KDB Publication 447498 D01v06 publication procedures. The "Portable Hotspot" feature on the handset was NOT activated during SAR assessments, to ensure the SAR measurements were evaluated for a single transmission frequency RF signal at a time.

12. Conducted RF Output Power (Unit: dBm)

<GSM Conducted Power>

1. Per KDB 447498 D01v06, the maximum output power channel is used for SAR testing and for further SAR test reduction.
2. Per KDB 941225 D01v03r01, for SAR test reduction for GSM / GPRS / EDGE modes is determined by the source-based time-averaged output power including tune-up tolerance. The mode with highest specified time-averaged output power should be tested for SAR compliance in the applicable exposure conditions. For modes with the same specified maximum output power and tolerance, the higher number time-slot configuration should be tested. Therefore, the GPRS (4Tx slots) for GSM850/GSM1900 is considered as the primary mode.
3. Other configurations of GSM / GPRS / EDGE are considered as secondary modes. The 3G SAR test reduction procedure is applied, when the maximum output power and tune-up tolerance specified for production units in a secondary mode is $\leq \frac{1}{4}$ dB higher than the primary mode, SAR measurement is not required for the secondary mode

GSM850 TX Channel	Burst Average Power (dBm)			Tune-up Limit (dBm)	Frame-Average Power (dBm)			Tune-up Limit (dBm)
	128	189	251		128	189	251	
Frequency (MHz)	824.2	836.4	848.8		824.2	836.4	848.8	
GSM 1 Tx slot	32.06	32.05	32.03	32.50	23.06	23.05	23.03	23.50
GPRS 1 Tx slot	32.04	31.02	32.00	32.50	23.04	22.02	23.00	23.50
GPRS 2 Tx slots	31.37	31.35	31.34	31.50	25.37	25.35	25.34	25.50
GPRS 3 Tx slots	29.68	29.64	29.62	30.00	25.42	25.38	25.36	25.74
GPRS 4 Tx slots	28.59	28.54	28.52	29.00	25.59	25.54	25.52	26.00
EDGE 1 Tx slot	26.20	26.04	25.86	26.50	17.20	17.04	16.86	17.50
EDGE 2 Tx slots	25.23	25.06	24.80	25.50	19.23	19.06	18.80	19.50
EDGE 3 Tx slots	23.21	23.03	22.79	23.50	18.95	18.77	18.53	19.24
EDGE 4 Tx slots	22.09	21.94	21.71	22.50	19.09	18.94	18.71	19.50

Remark: The frame-averaged power is linearly scaled the maximum burst averaged power over 8 time slots.

The calculated method are shown as below:

Frame-averaged power = Maximum burst averaged power (1 Tx Slot) - 9 dB

Frame-averaged power = Maximum burst averaged power (2 Tx Slots) - 6 dB

Frame-averaged power = Maximum burst averaged power (3 Tx Slots) - 4.26 dB

Frame-averaged power = Maximum burst averaged power (4 Tx Slots) - 3 dB

GSM1900 TX Channel	Burst Average Power (dBm)			Tune-up Limit (dBm)	Frame-Average Power (dBm)			Tune-up Limit (dBm)
	512	661	810		512	661	810	
Frequency (MHz)	1850.2	1880	1909.8		1850.2	1880	1909.8	
GSM 1 Tx slot	28.94	28.95	28.96	29.50	19.94	19.95	19.96	20.50
GPRS 1 Tx slot	28.93	28.94	28.95	29.50	19.93	19.94	19.95	20.50
GPRS 2 Tx slots	28.38	28.41	28.43	29.00	22.38	22.41	22.43	23.00
GPRS 3 Tx slots	26.70	26.74	26.76	27.00	22.44	22.48	22.50	22.74
GPRS 4 Tx slots	25.64	25.66	25.68	26.00	22.64	22.66	22.68	23.00
EDGE 1 Tx slot	25.86	25.46	25.20	26.00	16.86	16.46	16.20	17.00
EDGE 2 Tx slots	24.80	24.46	24.14	25.00	18.80	18.46	18.14	19.00
EDGE 3 Tx slots	22.63	22.32	22.01	23.00	18.37	18.06	17.75	18.74
EDGE 4 Tx slots	21.33	21.07	20.76	21.50	18.33	18.07	17.76	18.50

Remark: The frame-averaged power is linearly scaled the maximum burst averaged power over 8 time slots.

The calculated method are shown as below:

Frame-averaged power = Maximum burst averaged power (1 Tx Slot) - 9 dB

Frame-averaged power = Maximum burst averaged power (2 Tx Slots) - 6 dB

Frame-averaged power = Maximum burst averaged power (3 Tx Slots) - 4.26 dB

Frame-averaged power = Maximum burst averaged power (4 Tx Slots) - 3 dB

<WCDMA Conducted Power>

1. The following tests were conducted according to the test requirements outlines in 3GPP TS 34.121 specification.
2. The procedures in KDB 941225 D01v03r01 are applied for 3GPP Rel. 6 HSPA to configure the device in the required sub-test mode(s) to determine SAR test exclusion.
3. For HSPA+ devices supporting 16 QAM in the uplink, power measurements procedure is according to the configurations in Table C.11.1.4 of 3GPP TS 34.121-1.
4. For DC-HSDPA, the device was configured according to the H-Set 12, Fixed Reference Channel (FRC) configuration in Table C.8.1.12 of 3GPP TS 34.121-1, with the primary and the secondary serving HS-DSCH Cell enabled during the power measurement.

A summary of these settings are illustrated below:

HSDPA Setup Configuration:

- a. The EUT was connected to Base Station Agilent E5515C referred to the Setup Configuration.
- b. The RF path losses were compensated into the measurements.
- c. A call was established between EUT and Base Station with following setting:
 - i. Set Gain Factors (β_c and β_d) and parameters were set according to each
 - ii. Specific sub-test in the following table, C10.1.4, quoted from the TS 34.121
 - iii. Set RMC 12.2Kbps + HSDPA mode.
 - iv. Set Cell Power = -86 dBm
 - v. Set HS-DSCH Configuration Type to FRC (H-set 1, QPSK)
 - vi. Select HSDPA Uplink Parameters
 - vii. Set Delta ACK, Delta NACK and Delta CQI = 8
 - viii. Set Ack-Nack Repetition Factor to 3
 - ix. Set CQI Feedback Cycle (k) to 4 ms
 - x. Set CQI Repetition Factor to 2
 - xi. Power Ctrl Mode = All Up bits
- d. The transmitted maximum output power was recorded.

Table C.10.1.4: β values for transmitter characteristics tests with HS-DPCCH

Sub-test	β_c	β_d	β_d (SF)	β_c/β_d	β_{HS} (Note 1, Note 2)	CM (dB) (Note 3)	MPR (dB) (Note 3)
1	2/15	15/15	64	2/15	4/15	0.0	0.0
2	12/15 (Note 4)	15/15 (Note 4)	64	12/15 (Note 4)	24/15	1.0	0.0
3	15/15	8/15	64	15/8	30/15	1.5	0.5
4	15/15	4/15	64	15/4	30/15	1.5	0.5

Note 1: Δ_{ACK} , Δ_{NACK} and $\Delta_{CQI} = 30/15$ with $\beta_{HS} = 30/15 * \beta_c$.

Note 2: For the HS-DPCCH power mask requirement test in clause 5.2C, 5.7A, and the Error Vector Magnitude (EVM) with HS-DPCCH test in clause 5.13.1A, and HSDPA EVM with phase discontinuity in clause 5.13.1AA, Δ_{ACK} and $\Delta_{NACK} = 30/15$ with $\beta_{HS} = 30/15 * \beta_c$, and $\Delta_{CQI} = 24/15$ with $\beta_{HS} = 24/15 * \beta_c$.

Note 3: CM = 1 for $\beta_c/\beta_d = 12/15$, $\beta_{HS}/\beta_c = 24/15$. For all other combinations of DPDCCH, DPCCH and HS-DPCCH the MPR is based on the relative CM difference. This is applicable for only UEs that support HSDPA in release 6 and later releases.

Note 4: For subtest 2 the β_c/β_d ratio of 12/15 for the TFC during the measurement period (TF1, TF0) is achieved by setting the signalled gain factors for the reference TFC (TF1, TF1) to $\beta_c = 11/15$ and $\beta_d = 15/15$.

Setup Configuration

HSUPA Setup Configuration:

- a. The EUT was connected to Base Station Agilent E5515C referred to the Setup Configuration.
- b. The RF path losses were compensated into the measurements.
- c. A call was established between EUT and Base Station with following setting * :
 - i. Call Configs = 5.2B, 5.9B, 5.10B, and 5.13.2B with QPSK
 - ii. Set the Gain Factors (β_c and β_d) and parameters (AG Index) were set according to each specific sub-test in the following table, C11.1.3, quoted from the TS 34.121
 - iii. Set Cell Power = -86 dBm
 - iv. Set Channel Type = 12.2k + HSPA
 - v. Set UE Target Power
 - vi. Power Ctrl Mode= Alternating bits
 - vii. Set and observe the E-TFCl
 - viii. Confirm that E-TFCl is equal to the target E-TFCl of 75 for sub-test 1, and other subtest's E-TFCl
- d. The transmitted maximum output power was recorded.

Table C.11.1.3: β values for transmitter characteristics tests with HS-DPCCH and E-DCH

Sub-test	β_c	β_d	β_d (SF)	β_c/β_d	β_{HS} (Note 1)	β_{ec}	β_{ed} (Note 5) (Note 6)	β_{ed} (SF)	β_{ed} (Codes)	CM (dB) (Note 2)	MPR (dB) (Note 2)	AG Index (Note 6)	E-TFCl
1	11/15 (Note 3)	15/15 (Note 3)	64	11/15 (Note 3)	22/15	209/25	1309/225	4	1	1.0	0.0	20	75
2	6/15	15/15	64	6/15	12/15	12/15	94/75	4	1	3.0	2.0	12	67
3	15/15	9/15	64	15/9	30/15	30/15	$\beta_{ed1}: 47/15$ $\beta_{ed2}: 47/15$	4 4	2	2.0	1.0	15	92
4	2/15	15/15	64	2/15	4/15	2/15	56/75	4	1	3.0	2.0	17	71
5	15/15 (Note 4)	15/15 (Note 4)	64	15/15 (Note 4)	30/15	24/15	134/15	4	1	1.0	0.0	21	81

Note 1: $\Delta_{ACK}, \Delta_{NACK}$ and $\Delta_{CQI} = 30/15$ with $\beta_{hs} = 30/15 * \beta_c$.

Note 2: CM = 1 for $\beta_c/\beta_d = 12/15, \beta_{hs}/\beta_c = 24/15$. For all other combinations of DPDCH, DPCCH, HS- DPCCH, E-DPDCH and E-DPCCH the MPR is based on the relative CM difference.

Note 3: For subtest 1 the β_c/β_d ratio of 11/15 for the TFC during the measurement period (TF1, TF0) is achieved by setting the signalled gain factors for the reference TFC (TF1, TF1) to $\beta_c = 10/15$ and $\beta_d = 15/15$.

Note 4: For subtest 5 the β_c/β_d ratio of 15/15 for the TFC during the measurement period (TF1, TF0) is achieved by setting the signalled gain factors for the reference TFC (TF1, TF1) to $\beta_c = 14/15$ and $\beta_d = 15/15$.

Note 5: In case of testing by UE using E-DPDCH Physical Layer category 1, Sub-test 3 is omitted according to TS25.306 Table 5.1g.

Note 6: β_{ed} can not be set directly, it is set by Absolute Grant Value.

Setup Configuration

DC-HSDPA 3GPP release 8 Setup Configuration:

- a. The EUT was connected to Base Station Agilent E5515C referred to the Setup Configuration below
- b. The RF path losses were compensated into the measurements.
- c. A call was established between EUT and Base Station with following setting:
 - i. Set RMC 12.2Kbps + HSDPA mode.
 - ii. Set Cell Power = -25 dBm
 - iii. Set HS-DSCH Configuration Type to FRC (H-set 12, QPSK)
 - iv. Select HSDPA Uplink Parameters
 - v. Set Gain Factors (β_c and β_d) and parameters were set according to each Specific sub-test in the following table, C10.1.4, quoted from the TS 34.121
 - a). Subtest 1: $\beta_c/\beta_d=2/15$
 - b). Subtest 2: $\beta_c/\beta_d=12/15$
 - c). Subtest 3: $\beta_c/\beta_d=15/8$
 - d). Subtest 4: $\beta_c/\beta_d=15/4$
 - vi. Set Delta ACK, Delta NACK and Delta CQI = 8
 - vii. Set Ack-Nack Repetition Factor to 3
 - viii. Set CQI Feedback Cycle (k) to 4 ms
 - ix. Set CQI Repetition Factor to 2
 - x. Power Ctrl Mode = All Up bits
- d. The transmitted maximum output power was recorded.

The following tests were conducted according to the test requirements outlines in 3GPP TS 34.121 specification. A summary of these settings are illustrated below:

C.8.1.12 Fixed Reference Channel Definition H-Set 12

Table C.8.1.12: Fixed Reference Channel H-Set 12

Parameter	Unit	Value
Nominal Avg. Inf. Bit Rate	kbps	60
Inter-TTI Distance	TTI's	1
Number of HARQ Processes	Processes	6
Information Bit Payload (N_{INF})	Bits	120
Number Code Blocks	Blocks	1
Binary Channel Bits Per TTI	Bits	960
Total Available SML's in UE	SML's	19200
Number of SML's per HARQ Proc.	SML's	3200
Coding Rate		0.15
Number of Physical Channel Codes	Codes	1
Modulation		QPSK
Note 1: The RMC is intended to be used for DC-HSDPA mode and both cells shall transmit with identical parameters as listed in the table. Note 2: Maximum number of transmission is limited to 1, i.e., retransmission is not allowed. The redundancy and constellation version 0 shall be used.		

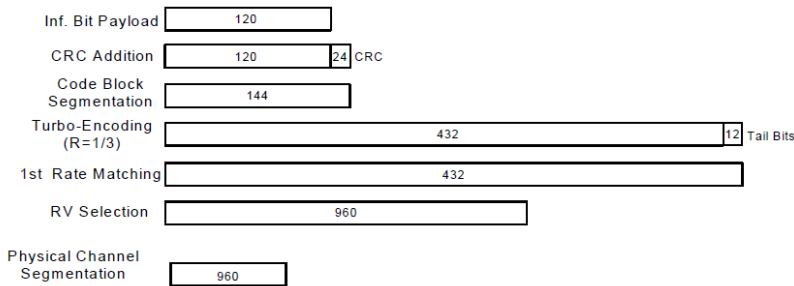

Figure C.8.19: Coding rate for Fixed reference Channel H-Set 12 (QPSK)

Setup Configuration

HSPA+ 3GPP release 7 (uplink category 7) 16QAM, Setup Configuration:

- a. The EUT was connected to Base Station Agilent E5515C referred to the Setup Configuration.
- b. The RF path losses were compensated into the measurements.
- c. A call was established between EUT and Base Station with following setting * :
 - i. Call Configs = 5.2E:HSPA+:UL with 16QAM
 - ii. Set the Gain Factors (β_c and β_d) and parameters (AG Index) were set according to each specific sub-test in the following table, C11.1.4, quoted from the TS 34.121-1 s5.2E
 - iii. Set Channel Parm
 - iv. Set Cell Power = -86 dBm
 - v. Set Channel Type = HSPA
 - vi. Set UE Target Power =21 dBm
 - vii. Power Ctrl Mode= All Up Bits
 - viii. Set Manual Uplink DPCH Bc/Bd = Manual
 - ix. Set Manual Uplink DPCH Bc and Bd=15,15(for 34.121-1 v8.10.0 table C11.1.4 sub-test 1)
 - x. Set HSPA Conn DL Channel Levels
 - xi. Set HS-SCCH Configs
 - xii. Set RB Test Mode Setup
 - xiii. Set Common HSUPA Parameters
 - xiv. Set Serving Grant
 - xv. Confirm that E-TFCI is equal to the target E-TFCI of 105 for sub-test 1, and other subtest's E-TFCI
- d. The transmitted maximum output power was recorded.

Table C.11.1.4: β values for transmitter characteristics tests with HS-DPCCH and E-DCH with 16QAM

Sub-test	β_c (Note 3)	β_d	β_{HS} (Note 1)	β_{ec}	β_{ed} (2xSF2) (Note 4)	β_{ed} (2xSF4) (Note 4)	CM (dB) (Note 2)	MPR (dB) (Note 2)	AG Index (Note 4)	E-TFCI (Note 5)	E-TFCI (boost)
1	1	0	30/15	30/15	β_{ed1} : 30/15 β_{ed2} : 30/15	β_{ed3} : 24/15 β_{ed4} : 24/15	3.5	2.5	14	105	105

Note 1: $\Delta_{ACK}, \Delta_{NACK}$ and $\Delta_{CQI} = 30/15$ with $\beta_{HS} = 30/15 * \beta_c$.

Note 2: CM = 3.5 and the MPR is based on the relative CM difference, MPR = MAX(CM-1,0).

Note 3: DPDCH is not configured, therefore the β_c is set to 1 and $\beta_d = 0$ by default.

Note 4: β_{ed} can not be set directly; it is set by Absolute Grant Value.

Note 5: All the sub-tests require the UE to transmit 2SF2+2SF4 16QAM EDCH and they apply for UE using E-DPDCH category 7. E-DCH TTI is set to 2ms TTI and E-DCH table index = 2. To support these E-DCH configurations DPDCH is not allocated. The UE is signaled to use the extrapolation algorithm.

Setup Configuration



<WCDMA Conducted Power>

General Note:

- Per KDB 941225 D01v03r01, for SAR testing is measured using a 12.2 kbps RMC with TPC bits configured to all "1's".
- Per KDB 941225 D01v03r01, RMC 12.2kbps setting is used to evaluate SAR. If the maximum output power and tune-up tolerance specified for production units in HSDPA / HSUPA / DC-HSDPA / HSPA+ is $\leq \frac{1}{4}$ dB higher than RMC 12.2Kbps or when the highest reported SAR of the RMC12.2Kbps is scaled by the ratio of specified maximum output power and tune-up tolerance of HSDPA / HSUPA / DC-HSDPA / HSPA+ to RMC12.2Kbps and the adjusted SAR is ≤ 1.2 W/kg, SAR measurement is not required for HSDPA / HSUPA / DC-HSDPA / HSPA+.

Band		WCDMA Band II			Tune-up Limit (dBm)	WCDMA Band V			Tune-up Limit (dBm)
TX Channel		9262	9400	9538		4132	4182	4233	
Rx Channel		9662	9800	9938		4357	4407	4458	
Frequency (MHz)		1852.4	1880	1907.6		826.4	836.4	846.6	
3GPP Rel 99	AMR 12.2Kbps	22.30	22.43	22.36	23.00	21.61	21.90	21.71	22.50
3GPP Rel 99	RMC 12.2Kbps	22.31	22.45	22.38	23.00	21.63	21.92	21.74	22.50
3GPP Rel 6	HSDPA Subtest-1	21.91	22.00	21.87	22.50	21.36	21.61	21.48	22.00
3GPP Rel 6	HSDPA Subtest-2	21.90	22.03	21.81	22.50	21.37	21.61	21.44	22.00
3GPP Rel 6	HSDPA Subtest-3	21.90	22.00	21.84	22.50	21.37	21.61	21.44	22.00
3GPP Rel 6	HSDPA Subtest-4	21.92	22.02	21.87	22.50	21.38	21.61	21.48	22.00
3GPP Rel 8	DC-HSDPA Subtest-1	22.11	22.19	22.09	22.50	21.72	21.83	21.76	22.00
3GPP Rel 8	DC-HSDPA Subtest-2	22.20	22.15	22.13	22.50	21.61	21.72	21.66	22.00
3GPP Rel 8	DC-HSDPA Subtest-3	21.99	22.01	22.09	22.50	21.57	21.59	21.55	22.00
3GPP Rel 8	DC-HSDPA Subtest-4	22.16	22.21	22.19	22.50	21.79	21.85	21.77	22.00
3GPP Rel 6	HSUPA Subtest-1	18.74	18.96	18.73	19.50	18.16	18.42	18.28	19.00
3GPP Rel 6	HSUPA Subtest-2	18.72	18.86	18.72	19.00	18.19	18.42	18.30	19.00
3GPP Rel 6	HSUPA Subtest-3	19.73	19.85	19.73	20.00	19.20	19.46	19.32	20.00
3GPP Rel 6	HSUPA Subtest-4	18.18	18.28	18.20	19.00	17.65	17.90	17.77	18.50
3GPP Rel 6	HSUPA Subtest-5	20.70	20.80	20.70	21.00	20.10	20.40	20.30	21.00
3GPP Rel 7	HSPA+ (16QAM) Subtest-1	21.99	22.22	22.09	22.50	21.40	21.76	21.70	22.00



<LTE Conducted Power>

General Note:

1. Anritsu MT8820C base station simulator was used to setup the connection with EUT; the frequency band, channel bandwidth, RB allocation configuration, modulation type are set in the base station simulator to configure EUT transmitting at maximum power and at different configurations which are requested to be reported to FCC, for conducted power measurement and SAR testing.
2. Per KDB 941225 D05v02r05, when a properly configured base station simulator is used for the SAR and power measurements, spectrum plots for each RB allocation and offset configuration is not required.
3. Per KDB 941225 D05v02r05, start with the largest channel bandwidth and measure SAR for QPSK with 1 RB allocation, using the RB offset and required test channel combination with the highest maximum output power for RB offsets at the upper edge, middle and lower edge of each required test channel.
4. Per KDB 941225 D05v02r05, 50% RB allocation for QPSK SAR testing follows 1RB QPSK allocation procedure.
5. Per KDB 941225 D05v02r05, For QPSK with 100% RB allocation, SAR is not required when the highest maximum output power for 100 % RB allocation is less than the highest maximum output power in 50% and 1 RB allocations and the highest reported SAR for 1 RB and 50% RB allocation are ≤ 0.8 W/kg. Otherwise, SAR is measured for the highest output power channel; and if the reported SAR is > 1.45 W/kg, the remaining required test channels must also be tested.
6. Per KDB 941225 D05v02r05, 16QAM output power for each RB allocation configuration is $>$ not $\frac{1}{2}$ dB higher than the same configuration in QPSK and the reported SAR for the QPSK configuration is ≤ 1.45 W/kg; Per KDB 941225 D05v02r05, 16QAM SAR testing is not required.
7. Per KDB 941225 D05v02r05, Smaller bandwidth output power for each RB allocation configuration is $>$ not $\frac{1}{2}$ dB higher than the same configuration in the largest supported bandwidth, and the reported SAR for the largest supported bandwidth is ≤ 1.45 W/kg; Per KDB 941225 D05v02r05, smaller bandwidth SAR testing is not required.
8. For LTE B4/B28 the maximum bandwidth does not support three non-overlapping channels, per KDB 941225 D05v02r05, when a device supports overlapping channel assignment in a channel bandwidth configuration, the middle channel of the group of overlapping channels should be selected for testing.



<LTE Band 2>

BW [MHz]	Modulation	RB Size	RB Offset	Power Low Ch. / Freq.	Power Middle Ch. / Freq.	Power High Ch. / Freq.	Tune-up limit (dBm)	MPR (dB)
Channel				18700	18900	19100		
Frequency (MHz)				1860	1880	1900		
20	QPSK	1	0	21.08	21.17	21.16	21.50	0
20	QPSK	1	49	20.96	21.04	21.05		
20	QPSK	1	99	20.99	21.04	21.09		
20	QPSK	50	0	20.05	20.15	20.13	20.50	1
20	QPSK	50	24	20.00	20.08	20.09		
20	QPSK	50	50	19.98	20.08	20.11		
20	QPSK	100	0	20.00	20.12	20.11		
20	16QAM	1	0	20.31	20.45	20.40	21.00	0.5
20	16QAM	1	49	20.28	20.40	20.39		
20	16QAM	1	99	20.27	20.39	20.37		
20	16QAM	50	0	19.09	19.15	19.14	19.50	2
20	16QAM	50	24	19.02	19.10	19.12		
20	16QAM	50	50	19.01	19.10	19.13		
20	16QAM	100	0	19.03	19.11	19.11		
Channel				18675	18900	19125	Tune-up limit (dBm)	MPR (dB)
Frequency (MHz)				1857.5	1880	1902.5		
15	QPSK	1	0	20.97	21.04	21.10	21.50	0
15	QPSK	1	37	20.88	20.99	21.04		
15	QPSK	1	74	20.91	21.04	21.07		
15	QPSK	36	0	19.99	20.09	20.06	20.50	1
15	QPSK	36	20	19.96	20.06	20.04		
15	QPSK	36	39	19.98	20.03	20.05		
15	QPSK	75	0	19.95	20.01	20.07		
15	16QAM	1	0	20.20	20.54	20.54	21.00	0.5
15	16QAM	1	37	20.22	20.50	20.52		
15	16QAM	1	74	20.19	20.46	20.48		
15	16QAM	36	0	19.00	19.07	19.08	19.50	2
15	16QAM	36	20	18.98	19.08	19.07		
15	16QAM	36	39	18.98	19.03	19.08		
15	16QAM	75	0	18.96	19.06	19.08		



Channel				18650	18900	19150	Tune-up limit (dBm)	MPR (dB)
Frequency (MHz)				1855	1880	1905		
10	QPSK	1	0	21.02	21.10	21.03	21.50	0
10	QPSK	1	25	20.99	21.01	21.00		
10	QPSK	1	49	20.95	20.99	20.89		
10	QPSK	25	0	19.97	20.04	20.03	20.50	1
10	QPSK	25	12	19.94	20.03	20.01		
10	QPSK	25	25	19.95	20.03	20.00		
10	QPSK	50	0	19.95	20.01	20.03	21.00	0.5
10	16QAM	1	0	19.92	19.97	20.03		
10	16QAM	1	25	20.15	20.01	20.05		
10	16QAM	1	49	19.86	19.97	20.03	19.50	2
10	16QAM	25	0	19.07	19.07	19.05		
10	16QAM	25	12	19.04	19.05	19.03		
10	16QAM	25	25	19.04	19.05	19.06	18.98	19.10
10	16QAM	50	0	18.98	19.10	19.06		
10	16QAM	50	0	18.98	19.10	19.06		
Channel				18625	18900	19175	Tune-up limit (dBm)	MPR (dB)
Frequency (MHz)				1852.5	1880	1907.5		
5	QPSK	1	0	20.90	21.02	20.90	21.50	0
5	QPSK	1	12	20.91	21.02	20.94		
5	QPSK	1	24	20.79	20.86	20.84		
5	QPSK	12	0	20.00	20.07	20.02	20.50	1
5	QPSK	12	7	20.01	20.03	20.03		
5	QPSK	12	13	19.98	20.06	20.03		
5	QPSK	25	0	19.94	19.99	19.97	21.00	0.5
5	16QAM	1	0	20.15	20.58	20.19		
5	16QAM	1	12	20.23	20.25	20.19		
5	16QAM	1	24	20.10	20.52	20.13	19.50	2
5	16QAM	12	0	19.11	19.06	19.11		
5	16QAM	12	7	19.02	19.11	19.11		
5	16QAM	12	13	18.98	19.11	19.00	18.99	19.07
5	16QAM	25	0	18.99	19.07	19.00		



Channel				18615	18900	19185	Tune-up limit (dBm)	MPR (dB)
Frequency (MHz)				1851.5	1880	1908.5		
3	QPSK	1	0	20.93	20.97	20.92	21.50	0
3	QPSK	1	8	21.01	20.99	21.01		
3	QPSK	1	14	20.89	20.94	20.95		
3	QPSK	8	0	20.01	20.02	20.03	20.50	1
3	QPSK	8	4	19.98	20.04	20.01		
3	QPSK	8	7	19.98	20.01	20.01		
3	QPSK	15	0	19.98	20.02	19.96	21.00	0.5
3	16QAM	1	0	20.28	20.47	20.06		
3	16QAM	1	8	20.39	20.45	19.90		
3	16QAM	1	14	20.34	20.11	19.84	19.50	2
3	16QAM	8	0	19.08	19.14	19.18		
3	16QAM	8	4	19.05	19.15	19.15		
3	16QAM	8	7	19.09	19.17	19.16	18.99	19.16
3	16QAM	15	0	18.99	19.16	19.08		
Channel				18607	18900	19193	Tune-up limit (dBm)	MPR (dB)
Frequency (MHz)				1850.7	1880	1909.3		
1.4	QPSK	1	0	20.91	20.92	20.90	21.50	0
1.4	QPSK	1	3	21.01	21.03	20.98		
1.4	QPSK	1	5	20.90	20.89	20.90		
1.4	QPSK	3	0	21.04	21.06	21.03		
1.4	QPSK	3	1	21.02	20.98	21.00		
1.4	QPSK	3	3	20.99	21.06	21.04	20.50	1
1.4	QPSK	6	0	20.03	20.02	20.00	21.00	0.5
1.4	16QAM	1	0	19.95	20.20	20.43		
1.4	16QAM	1	3	20.04	20.25	20.22		
1.4	16QAM	1	5	19.92	20.15	20.40		
1.4	16QAM	3	0	19.92	20.14	20.06		
1.4	16QAM	3	1	19.87	20.10	20.02		
1.4	16QAM	3	3	20.11	20.12	20.03	19.50	2
1.4	16QAM	6	0	19.04	19.19	19.27		



<LTE Band 4>

BW [MHz]	Modulation	RB Size	RB Offset	Power Low Ch. / Freq.	Power Middle Ch. / Freq.	Power High Ch. / Freq.	Tune-up limit (dBm)	MPR (dB)
Channel				20050	20175	20300		
Frequency (MHz)				1720	1732.5	1745		
20	QPSK	1	0	20.67	20.85	21.00		
20	QPSK	1	49	20.58	20.82	20.83	21.50	0
20	QPSK	1	99	20.64	20.83	20.87		
20	QPSK	50	0	19.69	19.88	19.94		
20	QPSK	50	24	19.68	19.85	19.85	20.50	1
20	QPSK	50	50	19.63	19.83	19.80		
20	QPSK	100	0	19.64	19.83	19.86		
20	16QAM	1	0	19.95	20.06	20.26	21.00	0.5
20	16QAM	1	49	19.89	20.12	20.10		
20	16QAM	1	99	19.98	20.09	19.93		
20	16QAM	50	0	18.63	18.84	18.95	19.50	2
20	16QAM	50	24	18.61	18.88	18.84		
20	16QAM	50	50	18.68	18.89	18.80		
20	16QAM	100	0	18.62	18.84	18.85		
Channel				20025	20175	20325	Tune-up limit (dBm)	MPR (dB)
Frequency (MHz)				1717.5	1732.5	1747.5		
15	QPSK	1	0	20.70	20.84	20.98	21.50	0
15	QPSK	1	37	20.64	20.96	20.86		
15	QPSK	1	74	20.66	20.92	20.67		
15	QPSK	36	0	19.70	19.87	19.95	20.50	1
15	QPSK	36	20	19.66	19.92	19.88		
15	QPSK	36	39	19.69	19.90	19.80		
15	QPSK	75	0	19.71	19.89	19.84		
15	16QAM	1	0	20.21	20.07	20.15	21.00	0.5
15	16QAM	1	37	20.17	20.18	20.00		
15	16QAM	1	74	20.19	20.09	19.88		
15	16QAM	36	0	18.67	18.85	18.91	19.50	2
15	16QAM	36	20	18.64	18.90	18.85		
15	16QAM	36	39	18.63	18.92	18.79		
15	16QAM	75	0	18.67	18.93	18.87		
15	16QAM	75	0	18.67	18.93	18.87		



Channel				20000	20175	20350	Tune-up limit (dBm)	MPR (dB)
Frequency (MHz)				1715	1732.5	1750		
10	QPSK	1	0	20.59	20.72	20.79	21.50	0
10	QPSK	1	25	20.49	20.83	20.71		
10	QPSK	1	49	20.50	20.74	20.60		
10	QPSK	25	0	19.66	19.86	19.82	20.50	1
10	QPSK	25	12	19.63	19.89	19.82		
10	QPSK	25	25	19.64	19.88	19.75		
10	QPSK	50	0	19.63	19.87	19.79	21.00	0.5
10	16QAM	1	0	19.88	20.37	20.08		
10	16QAM	1	25	19.77	20.10	19.97		
10	16QAM	1	49	19.75	20.07	19.86	19.50	2
10	16QAM	25	0	18.66	18.88	18.87		
10	16QAM	25	12	18.65	18.93	18.74		
10	16QAM	25	25	18.65	18.93	18.73	18.66	18.90
10	16QAM	50	0	18.66	18.90	18.83		
Channel				19975	20175	20375	Tune-up limit (dBm)	MPR (dB)
Frequency (MHz)				1712.5	1732.5	1752.5		
5	QPSK	1	0	20.60	20.82	20.68	21.50	0
5	QPSK	1	12	20.58	20.91	20.62		
5	QPSK	1	24	20.49	20.80	20.57		
5	QPSK	12	0	19.71	19.92	19.79	20.50	1
5	QPSK	12	7	19.66	19.92	19.72		
5	QPSK	12	13	19.66	19.93	19.73		
5	QPSK	25	0	19.63	19.85	19.74	21.00	0.5
5	16QAM	1	0	19.66	20.05	20.20		
5	16QAM	1	12	19.76	20.09	20.15		
5	16QAM	1	24	19.52	20.02	20.06	19.50	2
5	16QAM	12	0	18.69	18.95	18.81		
5	16QAM	12	7	18.65	18.93	18.77		
5	16QAM	12	13	18.67	18.94	18.76	18.57	18.87
5	16QAM	25	0	18.57	18.87	18.73		



Channel				19965	20175	20385	Tune-up limit (dBm)	MPR (dB)
Frequency (MHz)				1711.5	1732.5	1753.5		
3	QPSK	1	0	20.57	20.80	20.63	21.50	0
3	QPSK	1	8	20.61	20.88	20.60		
3	QPSK	1	14	20.52	20.77	20.57		
3	QPSK	8	0	19.66	19.91	19.76	20.50	1
3	QPSK	8	4	19.67	19.92	19.76		
3	QPSK	8	7	19.66	19.90	19.73		
3	QPSK	15	0	19.59	19.88	19.66	21.00	0.5
3	16QAM	1	0	19.97	19.76	19.62		
3	16QAM	1	8	19.95	19.81	19.64		
3	16QAM	1	14	19.44	19.75	19.59	19.50	2
3	16QAM	8	0	18.78	19.04	18.74		
3	16QAM	8	4	18.79	19.06	18.73		
3	16QAM	8	7	18.74	18.91	18.76	18.67	18.93
3	16QAM	15	0	18.67	18.93	18.63		
Channel				19957	20175	20393	Tune-up limit (dBm)	MPR (dB)
Frequency (MHz)				1710.7	1732.5	1754.3		
1.4	QPSK	1	0	20.52	20.81	20.60	21.50	0
1.4	QPSK	1	3	20.54	20.84	20.55		
1.4	QPSK	1	5	20.53	20.79	20.58		
1.4	QPSK	3	0	20.69	20.94	20.76		
1.4	QPSK	3	1	20.55	20.90	20.71		
1.4	QPSK	3	3	20.64	20.92	20.72	20.50	1
1.4	QPSK	6	0	19.61	19.93	19.68	21.00	0.5
1.4	16QAM	1	0	19.70	19.83	19.81		
1.4	16QAM	1	3	19.55	19.89	20.10		
1.4	16QAM	1	5	19.68	19.84	19.75		
1.4	16QAM	3	0	19.69	19.81	19.77		
1.4	16QAM	3	1	19.66	19.75	19.76		
1.4	16QAM	3	3	19.63	19.78	19.77	19.50	2
1.4	16QAM	6	0	18.56	19.03	18.81		



<LTE Band 7>

BW [MHz]	Modulation	RB Size	RB Offset	Measured Power			Tune-up limit (dBm)	MPR (dB)
				Channel	20850	21100		
Frequency (MHz)				2510	2535	2560		
20	QPSK	1	0	20.91	21.32	21.42	22.00	0
20	QPSK	1	49	20.94	21.35	21.48		
20	QPSK	1	99	21.20	21.47	21.52		
20	QPSK	50	0	19.99	20.35	20.50	21.00	1
20	QPSK	50	24	20.01	20.37	20.49		
20	QPSK	50	50	20.11	20.45	20.55		
20	QPSK	100	0	20.05	20.39	20.49	21.00	1
20	16QAM	1	0	20.18	20.59	20.69		
20	16QAM	1	49	20.22	20.62	20.79		
20	16QAM	1	99	20.40	20.73	20.83	20.00	2
20	16QAM	50	0	19.00	19.38	19.48		
20	16QAM	50	24	19.01	19.40	19.47		
20	16QAM	50	50	19.13	19.47	19.60	20.00	2
20	16QAM	100	0	19.05	19.42	19.49		
20	16QAM	100	0	19.05	19.42	19.49		
Channel				20825	21100	21375	Tune-up limit (dBm)	MPR (dB)
Frequency (MHz)				2507.5	2535	2562.5		
15	QPSK	1	0	20.97	21.39	21.44	22.00	0
15	QPSK	1	37	20.98	21.43	21.10		
15	QPSK	1	74	21.16	21.48	21.39		
15	QPSK	36	0	19.98	20.44	20.34	21.00	1
15	QPSK	36	20	19.98	20.44	20.25		
15	QPSK	36	39	20.10	20.49	20.23		
15	QPSK	75	0	20.02	20.43	20.29	21.00	1
15	16QAM	1	0	20.31	20.87	20.58		
15	16QAM	1	37	20.34	20.84	20.29		
15	16QAM	1	74	20.40	20.94	20.55	20.00	2
15	16QAM	36	0	19.01	19.42	19.47		
15	16QAM	36	20	19.02	19.48	19.43		
15	16QAM	36	39	19.10	19.42	19.44	20.00	2
15	16QAM	75	0	19.03	19.41	19.49		



Channel				20800	21100	21400	Tune-up limit (dBm)	MPR (dB)
Frequency (MHz)				2505	2535	2565		
10	QPSK	1	0	20.75	20.92	20.71	22.00	0
10	QPSK	1	25	20.93	21.10	20.74		
10	QPSK	1	49	20.91	21.27	20.80		
10	QPSK	25	0	20.03	20.22	19.76	21.00	1
10	QPSK	25	12	20.04	20.32	19.77		
10	QPSK	25	25	19.99	20.44	19.80		
10	QPSK	50	0	20.06	20.34	19.80	21.00	1
10	16QAM	1	0	19.94	20.46	20.18		
10	16QAM	1	25	20.04	20.67	20.12		
10	16QAM	1	49	20.12	20.62	20.18	20.00	2
10	16QAM	25	0	18.96	19.30	18.91		
10	16QAM	25	12	18.96	19.35	18.91		
10	16QAM	25	25	18.96	19.43	18.97	20.00	2
10	16QAM	50	0	18.99	19.40	19.01		
Channel				20775	21100	21425	Tune-up limit (dBm)	MPR (dB)
Frequency (MHz)				2502.5	2535	2567.5		
5	QPSK	1	0	20.94	21.26	21.20	22.00	0
5	QPSK	1	12	20.82	21.05	20.75		
5	QPSK	1	24	20.79	21.24	21.30		
5	QPSK	12	0	20.02	20.37	19.89	21.00	1
5	QPSK	12	7	20.00	20.36	19.81		
5	QPSK	12	13	20.02	20.42	19.87		
5	QPSK	25	0	19.96	20.40	19.89	21.00	1
5	16QAM	1	0	20.11	20.57	20.47		
5	16QAM	1	12	20.09	20.51	20.04		
5	16QAM	1	24	20.02	20.55	20.72	20.00	2
5	16QAM	12	0	18.89	19.37	18.96		
5	16QAM	12	7	18.87	19.36	18.89		
5	16QAM	12	13	18.97	19.39	18.91	20.00	2
5	16QAM	25	0	18.89	19.39	18.90		



<LTE Band 28>

BW [MHz]	Modulation	RB Size	RB Offset	Power Low Ch. / Freq.	Power Middle Ch. / Freq.	Power High Ch. / Freq.	Tune-up limit (dBm)	MPR (dB)
Channel				27310	27410	27560		
Frequency (MHz)				713	723	738		
20	QPSK	1	0	22.11	21.83	21.71		
20	QPSK	1	49	21.92	21.58	21.15	22.50	0
20	QPSK	1	99	21.82	21.35	21.68		
20	QPSK	50	0	21.15	20.78	20.40		
20	QPSK	50	24	21.04	20.70	20.19	21.50	1
20	QPSK	50	50	20.95	20.73	20.32		
20	QPSK	100	0	21.03	20.75	20.33		
20	16QAM	1	0	21.41	21.08	20.95	21.50	1
20	16QAM	1	49	21.21	20.88	20.47		
20	16QAM	1	99	21.12	20.68	21.00		
20	16QAM	50	0	20.15	19.72	19.36	20.50	2
20	16QAM	50	24	20.04	19.65	19.16		
20	16QAM	50	50	19.90	19.73	19.28		
20	16QAM	100	0	20.02	19.68	19.29		
Channel				27285	27410	27585	Tune-up limit (dBm)	MPR (dB)
Frequency (MHz)				710.5	723	740.5		
15	QPSK	1	0	22.04	21.58	21.36	22.50	0
15	QPSK	1	37	21.58	21.60	21.07		
15	QPSK	1	74	21.21	20.51	21.10		
15	QPSK	36	0	21.28	20.80	20.27	21.50	1
15	QPSK	36	20	20.82	20.75	20.22		
15	QPSK	36	39	20.38	20.32	20.45		
15	QPSK	75	0	20.90	20.68	20.32		
15	16QAM	1	0	21.20	20.79	20.61	21.50	1
15	16QAM	1	37	20.81	20.81	20.55		
15	16QAM	1	74	20.39	19.50	20.59		
15	16QAM	36	0	20.27	19.74	19.23	20.50	2
15	16QAM	36	20	19.94	19.68	19.18		
15	16QAM	36	39	19.46	19.37	19.41		
15	16QAM	75	0	20.02	19.75	19.27		



Channel				27260	27410	27610	Tune-up limit (dBm)	MPR (dB)
Frequency (MHz)				708	723	743		
10	QPSK	1	0	22.00	21.82	21.04	22.50	0
10	QPSK	1	25	21.88	21.56	21.13		
10	QPSK	1	49	21.01	20.73	20.84		
10	QPSK	25	0	21.30	20.73	20.08	21.50	1
10	QPSK	25	12	21.12	20.64	20.24		
10	QPSK	25	25	20.80	20.73	20.45		
10	QPSK	50	0	21.09	20.75	20.28	21.50	1
10	16QAM	1	0	21.31	20.78	20.12		
10	16QAM	1	25	21.09	20.55	20.21		
10	16QAM	1	49	20.26	19.75	19.88	20.50	2
10	16QAM	25	0	20.34	19.67	19.05		
10	16QAM	25	12	20.26	19.62	19.19		
10	16QAM	25	25	19.96	19.75	19.39	20.50	2
10	16QAM	50	0	20.17	19.68	19.20		
Channel				27235	27410	27635	Tune-up limit (dBm)	MPR (dB)
Frequency (MHz)				705.5	723	745.5		
5	QPSK	1	0	22.03	21.60	21.17	22.50	0
5	QPSK	1	12	22.07	21.55	21.35		
5	QPSK	1	24	22.06	21.42	21.55		
5	QPSK	12	0	21.30	20.74	20.31	21.50	1
5	QPSK	12	7	21.30	20.66	20.44		
5	QPSK	12	13	21.33	20.64	20.52		
5	QPSK	25	0	21.29	20.61	20.42	21.50	1
5	16QAM	1	0	21.46	21.16	20.68		
5	16QAM	1	12	21.43	21.06	20.90		
5	16QAM	1	24	21.45	21.00	21.08	20.50	2
5	16QAM	12	0	20.33	19.71	19.24		
5	16QAM	12	7	20.33	19.66	19.36		
5	16QAM	12	13	20.34	19.55	19.56	20.50	2
5	16QAM	25	0	20.31	19.61	19.41		



Channel				27225	27410	27645	Tune-up limit (dBm)	MPR (dB)
Frequency (MHz)				704.5	723	746.5		
3	QPSK	1	0	22.09	21.54	21.17	22.50	0
3	QPSK	1	8	22.04	21.51	21.42		
3	QPSK	1	14	22.02	21.44	21.43		
3	QPSK	8	0	21.32	20.68	20.46	21.50	1
3	QPSK	8	4	21.32	20.68	20.52		
3	QPSK	8	7	21.34	20.62	20.58		
3	QPSK	15	0	21.29	20.63	20.50		
3	16QAM	1	0	21.13	20.72	20.67	21.50	1
3	16QAM	1	8	21.16	20.74	20.92		
3	16QAM	1	14	21.17	20.65	20.93		
3	16QAM	8	0	20.29	19.70	19.43	20.50	2
3	16QAM	8	4	20.34	19.66	19.57		
3	16QAM	8	7	20.32	19.65	19.65		
3	16QAM	15	0	20.27	19.56	19.54		

**<WLAN Conducted Power>****General Note:**

1. Per KDB 248227 D01v02r02, SAR test reduction is determined according to 802.11 transmission mode configurations and certain exposure conditions with multiple test positions. In the 2.4 GHz band, separate SAR procedures are applied to DSSS and OFDM configurations to simplify DSSS test requirements. For OFDM, in both 2.4 and 5 GHz bands, an initial test configuration must be determined for each standalone and aggregated frequency band, according to the transmission mode configuration with the highest maximum output power specified for production units to perform SAR measurements. If the same highest maximum output power applies to different combinations of channel bandwidths, modulations and data rates, additional procedures are applied to determine which test configurations require SAR measurement. When applicable, an initial test position may be applied to reduce the number of SAR measurements required for next to the ear, UMPC mini-tablet or hotspot mode configurations with multiple test positions.
2. For 2.4 GHz 802.11b DSSS, either the initial test position procedure for multiple exposure test positions or the DSSS procedure for fixed exposure position is applied; these are mutually exclusive. For 2.4 GHz and 5 GHz OFDM configurations, the initial test configuration is applied to measure SAR using either the initial test position procedure for multiple exposure test position configurations or the initial test configuration procedures for fixed exposure test conditions. Based on the reported SAR of the measured configurations and maximum output power of the transmission mode configurations that are not included in the initial test configuration, the subsequent test configuration and initial test position procedures are applied to determine if SAR measurements are required for the remaining OFDM transmission configurations. In general, the number of test channels that require SAR measurement is minimized based on maximum output power measured for the test sample(s).
3. For OFDM transmission configurations in the 2.4 GHz and 5 GHz bands, When the same maximum power is specified for multiple transmission modes in a frequency band, the largest channel bandwidth, lowest order modulation, lowest data rate and lowest order 802.11a/g/n/ac mode is used for SAR measurement, on the highest measured output power channel for each frequency band.
4. DSSS and OFDM configurations are considered separately according to the required SAR procedures. SAR is measured in the initial test position using the 802.11 transmission mode configuration required by the DSSS procedure or initial test configuration and subsequent test configuration(s) according to the OFDM procedures.18 The initial test position procedure is described in the following:
 - a. When the reported SAR of the initial test position is ≤ 0.4 W/kg, further SAR measurement is not required for the other test positions in that exposure configuration and 802.11 transmission mode combinations within the frequency band or aggregated band.
 - b. When the reported SAR of the test position is > 0.4 W/kg, SAR is repeated for the 802.11 transmission mode configuration tested in the initial test position to measure the subsequent next closet/smallest test separation distance and maximum coupling test position on the highest maximum output power channel, until the report SAR is ≤ 0.8 W/kg or all required test position are tested.
 - c. For all positions/configurations, when the reported SAR is > 0.8 W/kg, SAR is measured for these test positions/configurations on the subsequent next highest measured output power channel(s) until the reported SAR is ≤ 1.2 W/kg or all required channels are tested.



<2.4GHz WLAN>

	Mode	Channel	Frequency (MHz)	Data Rate	Average power (dBm)	Tune-Up Limit	Duty Cycle %
2.4GHz WLAN	802.11b	CH 1	2412	1Mbps	13.73	14.50	98.19
		CH 6	2437		13.71	14.50	
		CH 11	2462		14.09	14.50	
	802.11g	CH 1	2412	6Mbps	11.80	12.50	89.14
		CH 6	2437		11.95	12.50	
		CH 11	2462		11.88	12.50	
	802.11n-HT20	CH 1	2412	MCS0	11.79	12.50	88.48
		CH 6	2437		11.98	12.50	
		CH 11	2462		12.21	12.50	
	802.11n-HT40	CH 3	2422	MCS0	10.58	11.50	79.32
		CH 6	2437		10.13	11.50	
		CH 9	2452		11.17	11.50	



13. Bluetooth Exclusions Applied

Mode Band	Average power(dBm)	
	Bluetooth v3.0+EDR	Bluetooth v4.0 LE
2.4GHz Bluetooth	7.50	0.50

Note:

- Per KDB 447498 D01v06, the 1-g and 10-g SAR test exclusion thresholds for 100 MHz to 6 GHz at *test separation distances* ≤ 50 mm are determined by:

$$[(\text{max. power of channel, including tune-up tolerance, mW}) / (\text{min. test separation distance, mm})] \cdot [\sqrt{f(\text{GHz})}] \leq 3.0$$
for 1-g SAR and ≤ 7.5 for 10-g extremity SAR
 - f(GHz) is the RF channel transmit frequency in GHz
 - Power and distance are rounded to the nearest mW and mm before calculation
 - The result is rounded to one decimal place for comparison

Bluetooth Max Power (dBm)	Separation Distance (mm)	Frequency (GHz)	exclusion thresholds
7.50	10	2.48	0.9

Note:

Per KDB 447498 D01v06, the test exclusion threshold is 0.9 which is <= 3, SAR testing is not required.

14. Antenna Location

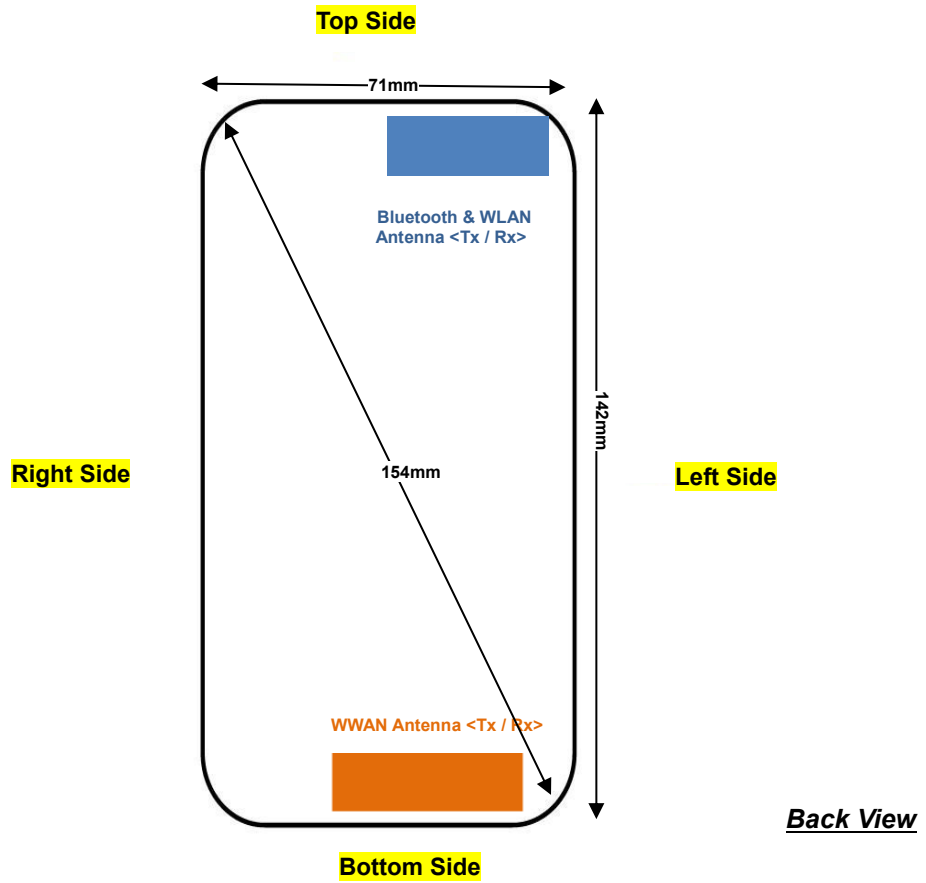

Distance of the Antenna to the EUT surface/edge						
Antennas	Back	Front	Top Side	Bottom Side	Right Side	Left Side
WWAN Main	≤ 25mm	≤ 25mm	125mm	≤ 25mm	30mm	≤ 25mm
BT&WLAN	≤ 25mm	≤ 25mm	≤ 25mm	125mm	41mm	≤ 25mm

Positions for SAR tests; Hotspot mode						
Antennas	Back	Front	Top Side	Bottom Side	Right Side	Left Side
WWAN Main	Yes	Yes	No	Yes	No	Yes
BT&WLAN	Yes	Yes	Yes	No	No	Yes

General Note:

Referring to KDB 941225 D06 v02r01, when the overall device length and width are ≥ 9cm*5cm, the test distance is 10 mm. SAR must be measured for all sides and surfaces with a transmitting antenna located within 25mm from that surface or edge



15. SAR Test Results

General Note:

1. Per KDB 447498 D01v06, the reported SAR is the measured SAR value adjusted for maximum tune-up tolerance.
 - a. Tune-up scaling Factor = tune-up limit power (mW) / EUT RF power (mW), where tune-up limit is the maximum rated power among all production units.
 - b. For SAR testing of WLAN signal with non-100% duty cycle, the measured SAR is scaled-up by the duty cycle scaling factor which is equal to "1/(duty cycle)"
 - c. For WWAN: Reported SAR(W/kg)= Measured SAR(W/kg)*Tune-up Scaling Factor
 - d. For WLAN: Reported SAR(W/kg)= Measured SAR(W/kg)* Duty Cycle scaling factor * Tune-up scaling factor
2. Per KDB 447498 D01v06, for each exposure position, testing of other required channels within the operating mode of a frequency band is not required when the *reported* 1-g or 10-g SAR for the mid-band or highest output power channel is:
 - ≤ 0.8 W/kg or 2.0 W/kg, for 1-g or 10-g respectively, when the transmission band is ≤ 100 MHz
 - ≤ 0.6 W/kg or 1.5 W/kg, for 1-g or 10-g respectively, when the transmission band is between 100 MHz and 200 MHz
 - ≤ 0.4 W/kg or 1.0 W/kg, for 1-g or 10-g respectively, when the transmission band is ≥ 200 MHz
3. Per KDB 865664 D01v01r04, for each frequency band, repeated SAR measurement is required only when the measured SAR is ≥ 0.8 W/kg.
4. Per KDB 648474 D04v01r03, when the reported SAR for a body-worn accessory measured without a headset connected to the handset is ≤ 1.2 W/kg, SAR testing with a headset connected to the handset is not required.

GSM Note:

1. Per KDB 941225 D01v03r01, for SAR test reduction for GSM / GPRS / EDGE modes is determined by the source-based time-averaged output power including tune-up tolerance. The mode with highest specified time-averaged output power should be tested for SAR compliance in the applicable exposure conditions. For modes with the same specified maximum output power and tolerance, the higher number time-slot configuration should be tested. Therefore, the GPRS (4Tx slots) for GSM850/GSM1900 is considered as the primary mode.
2. Other configurations of GSM / GPRS / EDGE are considered as secondary modes. The 3G SAR test reduction procedure is applied, when the maximum output power and tune-up tolerance specified for production units in a secondary mode is $\leq \frac{1}{4}$ dB higher than the primary mode, SAR measurement is not required for the secondary mode.

UMTS Note:

1. Per KDB 941225 D01v03r01, for SAR testing is measured using a 12.2 kbps RMC with TPC bits configured to all "1's".
2. Per KDB 941225 D01v03r01, RMC 12.2kbps setting is used to evaluate SAR. If the maximum output power and tune-up tolerance specified for production units in HSDPA / HSUPA / DC-HSDPA / HSPA+ is $\leq \frac{1}{4}$ dB higher than RMC 12.2Kbps or when the highest reported SAR of the RMC12.2Kbps is scaled by the ratio of specified maximum output power and tune-up tolerance of HSDPA / HSUPA / DC-HSDPA / HSPA+ to RMC12.2Kbps and the adjusted SAR is ≤ 1.2 W/kg, SAR measurement is not required for HSDPA / HSUPA / DC-HSDPA / HSPA+.

**LTE Note:**

1. Per KDB 941225 D05v02r05, start with the largest channel bandwidth and measure SAR for QPSK with 1 RB allocation, using the RB offset and required test channel combination with the highest maximum output power for RB offsets at the upper edge, middle and lower edge of each required test channel.
2. Per KDB 941225 D05v02r05, 50% RB allocation for QPSK SAR testing follows 1RB QPSK allocation procedure.
3. Per KDB 941225 D05v02r05, For QPSK with 100% RB allocation, SAR is not required when the highest maximum output power for 100 % RB allocation is less than the highest maximum output power in 50% and 1 RB allocations and the highest reported SAR for 1 RB and 50% RB allocation are ≤ 0.8 W/kg. Otherwise, SAR is measured for the highest output power channel; and if the reported SAR is > 1.45 W/kg, the remaining required test channels must also be tested.
4. Per KDB 941225 D05v02r05, 16QAM output power for each RB allocation configuration is $>$ not $\frac{1}{2}$ dB higher than the same configuration in QPSK and the reported SAR for the QPSK configuration is ≤ 1.45 W/kg; Per KDB 941225 D05v02r05, 16QAM SAR testing is not required.
5. Per KDB 941225 D05v02r05, Smaller bandwidth output power for each RB allocation configuration is $>$ not $\frac{1}{2}$ dB higher than the same configuration in the largest supported bandwidth, and the reported SAR for the largest supported bandwidth is ≤ 1.45 W/kg; Per KDB 941225 D05v02r05, smaller bandwidth SAR testing is not required.
6. For LTE B28 / B4 the maximum bandwidth does not support three non-overlapping channels, per KDB 941225 D05v02r05, when a device supports overlapping channel assignment in a channel bandwidth configuration, the middle channel of the group of overlapping channels should be selected for testing.

WLAN Note:

1. Per KDB 248227 D01v02r02, for 2.4GHz 802.11g/n SAR testing is not required when the highest reported SAR for DSSS is adjusted by the ratio of OFDM to DSSS specified maximum output power and the adjusted SAR is ≤ 1.2 W/kg.
2. When the reported SAR of the test position is > 0.4 W/kg, SAR is repeated for the 802.11 transmission mode configuration tested in the initial test position to measure the subsequent next closet/smallest test separation distance and maximum coupling test position on the highest maximum output power channel, until the report SAR is ≤ 0.8 W/kg or all required test position are tested.
3. For all positions / configurations, when the reported SAR is > 0.8 W/kg, SAR is measured for these test positions / configurations on the subsequent next highest measured output power channel(s) until the reported SAR is ≤ 1.2 W/kg or all required channels are tested.
4. During SAR testing the WLAN transmission was verified using a spectrum analyzer.



15.1 Head SAR

<GSM SAR>

Plot No.	Band	Mode	Test Position	Ch.	Freq. (MHz)	Average Power (dBm)	Tune-Up Limit (dBm)	Tune-up Scaling Factor	Power Drift (dB)	Measured 1g SAR (W/kg)	Reported 1g SAR (W/kg)
01	GSM850	GPRS(4 Tx slots)	Right Cheek	128	824.2	28.59	29	1.099	0.08	0.238	0.262
	GSM850	GPRS(4 Tx slots)	Right Tilted	128	824.2	28.59	29	1.099	-0.07	0.125	0.137
	GSM850	GPRS(4 Tx slots)	Left Cheek	128	824.2	28.59	29	1.099	-0.07	0.200	0.220
	GSM850	GPRS(4 Tx slots)	Left Tilted	128	824.2	28.59	29	1.099	0.01	0.093	0.102
	GSM1900	GPRS(4 Tx slots)	Right Cheek	810	1909.8	25.68	26	1.076	0.08	0.048	0.052
	GSM1900	GPRS(4 Tx slots)	Right Tilted	810	1909.8	25.68	26	1.076	0.05	0.027	0.029
02	GSM1900	GPRS(4 Tx slots)	Left Cheek	810	1909.8	25.68	26	1.076	0.02	0.086	0.093
	GSM1900	GPRS(4 Tx slots)	Left Tilted	810	1909.8	25.68	26	1.076	0.02	0.018	0.019

<WCDMA SAR>

Plot No.	Band	Mode	Test Position	Ch.	Freq. (MHz)	Average Power (dBm)	Tune-Up Limit (dBm)	Tune-up Scaling Factor	Power Drift (dB)	Measured 1g SAR (W/kg)	Reported 1g SAR (W/kg)
03	WCDMA Band V	RMC 12.2Kbps	Right Cheek	4182	836.4	21.92	22.5	1.143	0.04	0.122	0.139
	WCDMA Band V	RMC 12.2Kbps	Right Tilted	4182	836.4	21.92	22.5	1.143	-0.04	0.064	0.073
	WCDMA Band V	RMC 12.2Kbps	Left Cheek	4182	836.4	21.92	22.5	1.143	0.14	0.106	0.121
	WCDMA Band V	RMC 12.2Kbps	Left Tilted	4182	836.4	21.92	22.5	1.143	0.01	0.050	0.057
	WCDMA Band II	RMC 12.2Kbps	Right Cheek	9400	1880	22.45	23	1.135	-0.08	0.061	0.069
	WCDMA Band II	RMC 12.2Kbps	Right Tilted	9400	1880	22.45	23	1.135	0.05	0.034	0.039
04	WCDMA Band II	RMC 12.2Kbps	Left Cheek	9400	1880	22.45	23	1.135	0.06	0.123	0.140
	WCDMA Band II	RMC 12.2Kbps	Left Tilted	9400	1880	22.45	23	1.135	0.03	0.034	0.039



<LTE SAR>

Plot No.	Band	BW (MHz)	Modulation	RB Size	RB offset	Test Position	Ch.	Freq. (MHz)	Average Power (dBm)	Tune-Up Limit (dBm)	Tune-up Scaling Factor	Power Drift (dB)	Measured 1g SAR (W/kg)	Reported 1g SAR (W/kg)
05	LTE Band 28	20M	QPSK	1RB	0Offset	Right Cheek	27410	723	21.83	22.5	1.167	-0.03	0.038	0.044
	LTE Band 28	20M	QPSK	1RB	0Offset	Right Tilted	27410	723	21.83	22.5	1.167	0.05	0.027	0.032
	LTE Band 28	20M	QPSK	1RB	0Offset	Left Cheek	27410	723	21.83	22.5	1.167	-0.11	0.037	0.043
	LTE Band 28	20M	QPSK	1RB	0Offset	Left Tilted	27410	723	21.83	22.5	1.167	-0.08	0.013	0.015
	LTE Band 28	20M	QPSK	50RB	0Offset	Right Cheek	27410	723	20.78	21.5	1.180	0.07	0.034	0.040
	LTE Band 28	20M	QPSK	50RB	0Offset	Right Tilted	27410	723	20.78	21.5	1.180	0.1	0.022	0.026
	LTE Band 28	20M	QPSK	50RB	0Offset	Left Cheek	27410	723	20.78	21.5	1.180	0.03	0.034	0.040
	LTE Band 28	20M	QPSK	50RB	0Offset	Left Tilted	27410	723	20.78	21.5	1.180	-0.02	0.021	0.025
	LTE Band 4	20M	QPSK	1RB	0Offset	Right Cheek	20175	1732.5	20.85	21.5	1.161	0.06	0.073	0.085
	LTE Band 4	20M	QPSK	1RB	0Offset	Right Tilted	20175	1732.5	20.85	21.5	1.161	0.09	0.032	0.037
06	LTE Band 4	20M	QPSK	1RB	0Offset	Left Cheek	20175	1732.5	20.85	21.5	1.161	0.01	0.115	0.134
	LTE Band 4	20M	QPSK	1RB	0Offset	Left Tilted	20175	1732.5	20.85	21.5	1.161	0.17	0.045	0.052
	LTE Band 4	20M	QPSK	50RB	0Offset	Right Cheek	20175	1732.5	19.88	20.5	1.153	-0.08	0.058	0.067
	LTE Band 4	20M	QPSK	50RB	0Offset	Right Tilted	20175	1732.5	19.88	20.5	1.153	0.05	0.023	0.027
	LTE Band 4	20M	QPSK	50RB	0Offset	Left Cheek	20175	1732.5	19.88	20.5	1.153	0.06	0.090	0.104
	LTE Band 4	20M	QPSK	50RB	0Offset	Left Tilted	20175	1732.5	19.88	20.5	1.153	0.06	0.035	0.040



Plot No.	Band	BW (MHz)	Modulation	RB Size	RB offset	Test Position	Ch.	Freq. (MHz)	Average Power (dBm)	Tune-Up Limit (dBm)	Tune-up Scaling Factor	Power Drift (dB)	Measured 1g SAR (W/kg)	Reported 1g SAR (W/kg)
07	LTE Band 2	20M	QPSK	1RB	0Offset	Right Cheek	18900	1880	21.17	21.5	1.079	-0.08	0.047	0.051
	LTE Band 2	20M	QPSK	1RB	0Offset	Right Tilted	18900	1880	21.17	21.5	1.079	0.08	0.025	0.027
	LTE Band 2	20M	QPSK	1RB	0Offset	Left Cheek	18900	1880	21.17	21.5	1.079	0.05	0.099	0.107
	LTE Band 2	20M	QPSK	1RB	0Offset	Left Tilted	18900	1880	21.17	21.5	1.079	-0.08	0.034	0.037
	LTE Band 2	20M	QPSK	50RB	0Offset	Right Cheek	18900	1880	20.15	20.5	1.084	0.09	0.036	0.039
	LTE Band 2	20M	QPSK	50RB	0Offset	Right Tilted	18900	1880	20.15	20.5	1.084	-0.02	0.021	0.023
	LTE Band 2	20M	QPSK	50RB	0Offset	Left Cheek	18900	1880	20.15	20.5	1.084	-0.04	0.077	0.083
	LTE Band 2	20M	QPSK	50RB	0Offset	Left Tilted	18900	1880	20.15	20.5	1.084	-0.02	0.025	0.027
08	LTE Band 7	20M	QPSK	1RB	99Offset	Right Cheek	21350	2560	21.52	22	1.117	0.09	0.020	0.022
	LTE Band 7	20M	QPSK	1RB	99Offset	Right Tilted	21350	2560	21.52	22	1.117	-0.07	0.017	0.019
	LTE Band 7	20M	QPSK	1RB	99Offset	Left Cheek	21350	2560	21.52	22	1.117	-0.02	0.029	0.032
	LTE Band 7	20M	QPSK	1RB	99Offset	Left Tilted	21350	2560	21.52	22	1.117	0.02	0.009	0.010
	LTE Band 7	20M	QPSK	50RB	50Offset	Right Cheek	21350	2560	20.55	21	1.109	0.14	0.015	0.017
	LTE Band 7	20M	QPSK	50RB	50Offset	Right Tilted	21350	2560	20.55	21	1.109	-0.15	0.008	0.009
	LTE Band 7	20M	QPSK	50RB	50Offset	Left Cheek	21350	2560	20.55	21	1.109	-0.14	0.025	0.028
	LTE Band 7	20M	QPSK	50RB	50Offset	Left Tilted	21350	2560	20.55	21	1.109	-0.09	0.007	0.008

<WLAN SAR>

Plot No.	Band	Mode	Test Position	Ch.	Freq. (MHz)	Average Power (dBm)	Tune-Up Limit (dBm)	Tune-up Scaling Factor	Duty Cycle %	Duty Cycle Scaling Factor	Power Drift (dB)	Peak SAR	Measured 1g SAR (W/kg)	Reported 1g SAR (W/kg)
09	WLAN 2.4GHz	802.11b 1Mbps	Right Cheek	11	2462	14.09	14.50	1.099	98.19	1.018	0.06	0.00599	0.001	0.001
	WLAN 2.4GHz	802.11b 1Mbps	Right Tilted	11	2462	14.09	14.50	1.099	98.19	1.018		0.00026		
	WLAN 2.4GHz	802.11b 1Mbps	Left Cheek	11	2462	14.09	14.50	1.099	98.19	1.018		0.00041		
	WLAN 2.4GHz	802.11b 1Mbps	Left Tilted	11	2462	14.09	14.50	1.099	98.19	1.018		0.00014		



15.2 Hotspot SAR

<GSM SAR>

Plot No.	Band	Mode	Test Position	Gap (mm)	Ch.	Freq. (MHz)	Average Power (dBm)	Tune-Up Limit (dBm)	Tune-up Scaling Factor	Power Drift (dB)	Measured 1g SAR (W/kg)	Reported 1g SAR (W/kg)
10	GSM850	GPRS(4 Tx slots)	Front	10	128	824.2	28.59	29	1.099	-0.01	0.380	0.418
	GSM850	GPRS(4 Tx slots)	Back	10	128	824.2	28.59	29	1.099	0.04	0.343	0.377
	GSM850	GPRS(4 Tx slots)	Left Side	10	128	824.2	28.59	29	1.099	0.02	0.264	0.290
	GSM850	GPRS(4 Tx slots)	Bottom Side	10	128	824.2	28.59	29	1.099	-0.01	0.191	0.210
	GSM1900	GPRS(4 Tx slots)	Front	10	810	1909.8	25.68	26	1.076	0.02	0.466	0.502
	GSM1900	GPRS(4 Tx slots)	Back	10	810	1909.8	25.68	26	1.076	0.02	0.272	0.293
	GSM1900	GPRS(4 Tx slots)	Left Side	10	810	1909.8	25.68	26	1.076	-0.01	0.082	0.088
11	GSM1900	GPRS(4 Tx slots)	Bottom Side	10	810	1909.8	25.68	26	1.076	-0.09	0.662	0.713

<WCDMA SAR>

Plot No.	Band	Mode	Test Position	Gap (mm)	Ch.	Freq. (MHz)	Average Power (dBm)	Tune-Up Limit (dBm)	Tune-up Scaling Factor	Power Drift (dB)	Measured 1g SAR (W/kg)	Reported 1g SAR (W/kg)
12	WCDMA Band V	RMC 12.2Kbps	Front	10	4182	836.4	21.92	22.5	1.143	-0.06	0.194	0.222
	WCDMA Band V	RMC 12.2Kbps	Back	10	4182	836.4	21.92	22.5	1.143	0.02	0.170	0.194
	WCDMA Band V	RMC 12.2Kbps	Left Side	10	4182	836.4	21.92	22.5	1.143	-0.06	0.115	0.131
	WCDMA Band V	RMC 12.2Kbps	Bottom Side	10	4182	836.4	21.92	22.5	1.143	0.07	0.106	0.121
	WCDMA Band II	RMC 12.2Kbps	Front	10	9400	1880	22.45	23	1.135	-0.02	0.483	0.548
	WCDMA Band II	RMC 12.2Kbps	Back	10	9400	1880	22.45	23	1.135	-0.04	0.280	0.318
	WCDMA Band II	RMC 12.2Kbps	Left Side	10	9400	1880	22.45	23	1.135	0.01	0.083	0.094
13	WCDMA Band II	RMC 12.2Kbps	Bottom Side	10	9400	1880	22.45	23	1.135	0.05	0.696	0.790



<LTE SAR>

Plot No.	Band	BW (MHz)	Modulation	RB Size	RB offset	Test Position	Gap (mm)	Ch.	Freq. (MHz)	Average Power (dBm)	Tune-Up Limit (dBm)	Tune-up Scaling Factor	Power Drift (dB)	Measured 1g SAR (W/kg)	Reported 1g SAR (W/kg)
14	LTE Band 28	20M	QPSK	1RB	0Offset	Front	10	27410	723	21.83	22.5	1.167	0.02	0.085	0.099
	LTE Band 28	20M	QPSK	1RB	0Offset	Back	10	27410	723	21.83	22.5	1.167	-0.05	0.088	0.103
	LTE Band 28	20M	QPSK	1RB	0Offset	Left Side	10	27410	723	21.83	22.5	1.167	-0.08	0.039	0.046
	LTE Band 28	20M	QPSK	1RB	0Offset	Bottom Side	10	27410	723	21.83	22.5	1.167	-0.06	0.022	0.026
	LTE Band 28	20M	QPSK	50RB	0Offset	Front	10	27410	723	20.78	21.5	1.180	-0.07	0.076	0.090
	LTE Band 28	20M	QPSK	50RB	0Offset	Back	10	27410	723	20.78	21.5	1.180	0.06	0.082	0.097
15	LTE Band 28	20M	QPSK	50RB	0Offset	Left Side	10	27410	723	20.78	21.5	1.180	0.05	0.035	0.041
	LTE Band 28	20M	QPSK	50RB	0Offset	Bottom Side	10	27410	723	20.78	21.5	1.180	-0.09	0.021	0.025
	LTE Band 4	20M	QPSK	1RB	0Offset	Front	10	20175	1732.5	20.85	21.5	1.161	-0.02	0.534	0.620
	LTE Band 4	20M	QPSK	1RB	0Offset	Back	10	20175	1732.5	20.85	21.5	1.161	0.02	0.303	0.352
	LTE Band 4	20M	QPSK	1RB	0Offset	Left Side	10	20175	1732.5	20.85	21.5	1.161	-0.09	0.082	0.095
	LTE Band 4	20M	QPSK	1RB	0Offset	Bottom Side	10	20175	1732.5	20.85	21.5	1.161	0.12	0.846	0.983
	LTE Band 4	20M	QPSK	50RB	0Offset	Front	10	20175	1732.5	19.88	20.5	1.153	0.03	0.430	0.496
	LTE Band 4	20M	QPSK	50RB	0Offset	Back	10	20175	1732.5	19.88	20.5	1.153	-0.07	0.253	0.292
	LTE Band 4	20M	QPSK	50RB	0Offset	Left Side	10	20175	1732.5	19.88	20.5	1.153	0.08	0.067	0.077
	LTE Band 4	20M	QPSK	50RB	0Offset	Bottom Side	10	20175	1732.5	19.88	20.5	1.153	-0.04	0.685	0.790
LTE Band 4	20M	QPSK	100RB	0Offset	Bottom Side	10	20175	1732.5	19.83	20.5	1.167	-0.16	0.656	0.765	



Plot No.	Band	BW (MHz)	Modulation	RB Size	RB offset	Test Position	Gap (mm)	Ch.	Freq. (MHz)	Average Power (dBm)	Tune-Up Limit (dBm)	Tune-up Scaling Factor	Power Drift (dB)	Measured 1g SAR (W/kg)	Reported 1g SAR (W/kg)
	LTE Band 2	20M	QPSK	1RB	0Offset	Front	10	18900	1880	21.17	21.5	1.079	-0.14	0.395	0.426
	LTE Band 2	20M	QPSK	1RB	0Offset	Back	10	18900	1880	21.17	21.5	1.079	-0.06	0.239	0.258
	LTE Band 2	20M	QPSK	1RB	0Offset	Left Side	10	18900	1880	21.17	21.5	1.079	-0.02	0.067	0.072
16	LTE Band 2	20M	QPSK	1RB	0Offset	Bottom Side	10	18900	1880	21.17	21.5	1.079	-0.02	0.579	0.625
	LTE Band 2	20M	QPSK	50RB	0Offset	Front	10	18900	1880	20.15	20.5	1.084	-0.07	0.310	0.336
	LTE Band 2	20M	QPSK	50RB	0Offset	Back	10	18900	1880	20.15	20.5	1.084	-0.06	0.187	0.203
	LTE Band 2	20M	QPSK	50RB	0Offset	Left Side	10	18900	1880	20.15	20.5	1.084	0.02	0.053	0.057
	LTE Band 2	20M	QPSK	50RB	0Offset	Bottom Side	10	18900	1880	20.15	20.5	1.084	-0.03	0.460	0.499
	LTE Band 7	20M	QPSK	1RB	99Offset	Front	10	21350	2560	21.52	22	1.117	-0.02	0.168	0.188
	LTE Band 7	20M	QPSK	1RB	99Offset	Back	10	21350	2560	21.52	22	1.117	-0.09	0.334	0.373
	LTE Band 7	20M	QPSK	1RB	99Offset	Left Side	10	21350	2560	21.52	22	1.117	0.01	0.084	0.094
17	LTE Band 7	20M	QPSK	1RB	99Offset	Bottom Side	10	21350	2560	21.52	22	1.117	-0.05	0.372	0.415
	LTE Band 7	20M	QPSK	50RB	50Offset	Front	10	21350	2560	20.55	21	1.109	0.04	0.128	0.142
	LTE Band 7	20M	QPSK	50RB	50Offset	Back	10	21350	2560	20.55	21	1.109	-0.06	0.271	0.301
	LTE Band 7	20M	QPSK	50RB	50Offset	Left Side	10	21350	2560	20.55	21	1.109	-0.03	0.065	0.072
	LTE Band 7	20M	QPSK	50RB	50Offset	Bottom Side	10	21350	2560	20.55	21	1.109	-0.07	0.285	0.316

<WLAN SAR>

Plot No.	Band	Mode	Test Position	Gap (mm)	Ch.	Freq. (MHz)	Average Power (dBm)	Tune-Up Limit (dBm)	Tune-up Scaling Factor	Duty Cycle %	Duty Cycle Scaling Factor	Power Drift (dB)	Peak SAR	Measured 1g SAR (W/kg)	Reported 1g SAR (W/kg)
	WLAN 2.4GHz	802.11b 1Mbps	Front	10	11	2462	14.09	14.50	1.099	98.19	1.018		0.00502		
18	WLAN 2.4GHz	802.11b 1Mbps	Back	10	11	2462	14.09	14.50	1.099	98.19	1.018	0.13	0.0181	0.016	0.018
	WLAN 2.4GHz	802.11b 1Mbps	Left Side	10	11	2462	14.09	14.50	1.099	98.19	1.018		0.00166		
	WLAN 2.4GHz	802.11b 1Mbps	Top Side	10	11	2462	14.09	14.50	1.099	98.19	1.018		0.00119		



15.3 Body Worn Accessory SAR

<GSM SAR>

Plot No.	Band	Mode	Test Position	Gap (mm)	Ch.	Freq. (MHz)	Average Power (dBm)	Tune-Up Limit (dBm)	Tune-up Scaling Factor	Power Drift (dB)	Measured 1g SAR (W/kg)	Reported 1g SAR (W/kg)
10	GSM850	GPRS(4 Tx slots)	Front	10	128	824.2	28.59	29	1.099	-0.01	0.380	0.418
	GSM850	GPRS(4 Tx slots)	Back	10	128	824.2	28.59	29	1.099	0.04	0.343	0.377
19	GSM1900	GPRS(4 Tx slots)	Front	10	810	1909.8	25.68	26	1.076	0.02	0.466	0.502
	GSM1900	GPRS(4 Tx slots)	Back	10	810	1909.8	25.68	26	1.076	0.02	0.272	0.293

<WCDMA SAR>

Plot No.	Band	Mode	Test Position	Gap (mm)	Ch.	Freq. (MHz)	Average Power (dBm)	Tune-Up Limit (dBm)	Tune-up Scaling Factor	Power Drift (dB)	Measured 1g SAR (W/kg)	Reported 1g SAR (W/kg)
12	WCDMA Band V	RMC 12.2Kbps	Front	10	4182	836.4	21.92	22.5	1.143	-0.06	0.194	0.222
	WCDMA Band V	RMC 12.2Kbps	Back	10	4182	836.4	21.92	22.5	1.143	0.02	0.170	0.194
20	WCDMA Band II	RMC 12.2Kbps	Front	10	9400	1880	22.45	23	1.135	-0.02	0.483	0.548
	WCDMA Band II	RMC 12.2Kbps	Back	10	9400	1880	22.45	23	1.135	-0.04	0.280	0.318



<LTE SAR>

Plot No.	Band	BW (MHz)	Modulation	RB Size	RB offset	Test Position	Gap (mm)	Ch.	Freq. (MHz)	Average Power (dBm)	Tune-Up Limit (dBm)	Tune-up Scaling Factor	Power Drift (dB)	Measured 1g SAR (W/kg)	Reported 1g SAR (W/kg)
14	LTE Band 28	20M	QPSK	1RB	0Offset	Front	10	27410	723	21.83	22.5	1.167	0.02	0.085	0.099
	LTE Band 28	20M	QPSK	1RB	0Offset	Back	10	27410	723	21.83	22.5	1.167	-0.05	0.088	0.103
	LTE Band 28	20M	QPSK	50RB	0Offset	Front	10	27410	723	20.78	21.5	1.180	-0.07	0.076	0.090
	LTE Band 28	20M	QPSK	50RB	0Offset	Back	10	27410	723	20.78	21.5	1.180	0.06	0.082	0.097
21	LTE Band 4	20M	QPSK	1RB	0Offset	Front	10	20175	1732.5	20.85	21.5	1.161	-0.02	0.534	0.620
	LTE Band 4	20M	QPSK	1RB	0Offset	Back	10	20175	1732.5	20.85	21.5	1.161	0.02	0.303	0.352
	LTE Band 4	20M	QPSK	50RB	0Offset	Front	10	20175	1732.5	19.88	20.5	1.153	0.03	0.430	0.496
	LTE Band 4	20M	QPSK	50RB	0Offset	Back	10	20175	1732.5	19.88	20.5	1.153	-0.07	0.253	0.292
22	LTE Band 2	20M	QPSK	1RB	0Offset	Front	10	18900	1880	21.17	21.5	1.079	-0.14	0.395	0.426
	LTE Band 2	20M	QPSK	1RB	0Offset	Back	10	18900	1880	21.17	21.5	1.079	-0.06	0.239	0.258
	LTE Band 2	20M	QPSK	50RB	0Offset	Front	10	18900	1880	20.15	20.5	1.084	-0.07	0.310	0.336
	LTE Band 2	20M	QPSK	50RB	0Offset	Back	10	18900	1880	20.15	20.5	1.084	-0.06	0.187	0.203
	LTE Band 7	20M	QPSK	1RB	99Offset	Front	10	21350	2560	21.52	22	1.117	-0.02	0.168	0.188
	LTE Band 7	20M	QPSK	1RB	99Offset	Back	10	21350	2560	21.52	22	1.117	-0.09	0.334	0.373
23	LTE Band 7	20M	QPSK	50RB	50Offset	Front	10	21350	2560	20.55	21	1.109	0.04	0.128	0.142
	LTE Band 7	20M	QPSK	50RB	50Offset	Back	10	21350	2560	20.55	21	1.109	-0.06	0.271	0.301

<WLAN SAR>

Plot No.	Band	Mode	Test Position	Gap (mm)	Ch.	Freq. (MHz)	Average Power (dBm)	Tune-Up Limit (dBm)	Tune-up Scaling Factor	Duty Cycle %	Duty Cycle Scaling Factor	Power Drift (dB)	Peak SAR	Measured 1g SAR (W/kg)	Reported 1g SAR (W/kg)
18	WLAN 2.4GHz	802.11b 1Mbps	Front	10	11	2462	14.09	14.50	1.099	98.19	1.018		0.00502		
	WLAN 2.4GHz	802.11b 1Mbps	Back	10	11	2462	14.09	14.50	1.099	98.19	1.018	0.13	0.0181	0.016	0.018

15.4 Repeated SAR Measurement

No.	Band	BW (MHz)	Modulation	RB Size	RB offset	Test Position	Gap (cm)	Ch.	Freq. (MHz)	Average Power (dBm)	Tune-Up Limit (dBm)	Tune-up Scaling Factor	Power Drift (dB)	Measured 1g SAR (W/kg)	Ratio	Reported 1g SAR (W/kg)
1st	LTE Band 4	20M	QPSK	1RB	0Offset	Bottom Side	10	20175	1732.5	20.85	21.5	1.161	0.12	0.846	1	0.983
2nd	LTE Band 4	20M	QPSK	1RB	0Offset	Bottom Side	10	20175	1732.5	20.85	21.5	1.161	0.14	0.814	1.039	0.945

General Note:

1. Per KDB 865664 D01v01r04, for each frequency band, repeated SAR measurement is required only when the measured SAR is $\geq 0.8W/kg$.
2. Per KDB 865664 D01v01r04, if the ratio among the repeated measurement is ≤ 1.2 and the measured SAR $< 1.45W/kg$, only one repeated measurement is required.
3. The ratio is the difference in percentage between original and repeated *measured SAR*.
4. All measurement SAR result is scaled-up to account for tune-up tolerance and is compliant.

16. Simultaneous Transmission Analysis

NO.	Simultaneous Transmission Configurations	Portable Handset			Note
		Head	Body-worn	Hotspot	
1.	GSM Voice + WLAN2.4GHz	Yes	Yes		
2.	GPRS/EDGE + WLAN2.4GHz	Yes	Yes	Yes	Hotspot
3.	WCDMA + WLAN2.4GHz	Yes	Yes	Yes	Hotspot
4.	LTE + WLAN2.4GHz	Yes	Yes	Yes	Hotspot
5.	GSM Voice + Bluetooth		Yes		
6.	GPRS/EDGE + Bluetooth		Yes		WWAN VoIP
7.	WCDMA+ Bluetooth		Yes		WWAN VoIP
8.	LTE + Bluetooth		Yes		WWAN VoIP

General Note:

1. This device supported VoIP in GPRS, EGPRS, WCDMA and LTE (e.g. 3rd party VoIP).
2. This device 2.4GHz WLAN supports Hotspot operation.
3. WLAN and Bluetooth share the same antenna, and cannot transmit simultaneously.
4. EUT will choose each GSM, WCDMA and LTE according to the network signal condition; therefore, they will not operate simultaneously at any moment.
5. Chose the worse zoom scan SAR of WLAN2.4GHz SAR for co-located with WWAN analysis.
6. The Scaled SAR summation is calculated based on the same configuration and test position.
7. Per KDB 447498 D01v06, simultaneous transmission SAR is compliant if,
 - i) Scalar SAR summation < 1.6W/kg.
 - ii) $SPLSR = (SAR1 + SAR2)^{1.5} / (\text{min. separation distance, mm})$, and the peak separation distance is determined from the square root of $[(x1-x2)^2 + (y1-y2)^2 + (z1-z2)^2]$, where (x1, y1, z1) and (x2, y2, z2) are the coordinates of the extrapolated peak SAR locations in the zoom scan.
 - iii) If $SPLSR \leq 0.04$, simultaneously transmission SAR measurement is not necessary.
 - iv) Simultaneously transmission SAR measurement, and the reported multi-band SAR < 1.6W/kg.
8. For simultaneous transmission analysis, Bluetooth SAR is estimated per KDB 447498 D01v06 based on the formula below.
 - i) $(\text{max. power of channel, including tune-up tolerance, mW}) / (\text{min. test separation distance, mm}) \cdot [\sqrt{f(\text{GHz})} / x] \text{ W/kg}$ for test separation distances $\leq 50 \text{ mm}$; where $x = 7.5$ for 1-g SAR, and $x = 18.75$ for 10-g SAR.
 - ii) When the minimum separation distance is < 5mm, the distance is used 5mm to determine SAR test exclusion.
 - iii) 0.4 W/kg for 1-g SAR and 1.0 W/kg for 10-g SAR, when the test separation distances is > 50 mm.

Bluetooth Max Power	Exposure Position	Body worn
	Test separation	10 mm
7.50 dBm	Estimated SAR (W/kg)	0.126 W/kg



16.1 Head Exposure Conditions

WWAN Band		Exposure Position	1	2	1+2 Summed 1g SAR (W/kg)
			WWAN	2.4GHz WLAN	
			1g SAR (W/kg)	1g SAR (W/kg)	
GSM	GSM850	Right Cheek	0.262	0.001	0.26
		Right Tilted	0.137	0.001	0.14
		Left Cheek	0.220	0.001	0.22
		Left Tilted	0.102	0.001	0.10
	GSM1900	Right Cheek	0.052	0.001	0.05
		Right Tilted	0.029	0.001	0.03
		Left Cheek	0.093	0.001	0.09
		Left Tilted	0.019	0.001	0.02
WCDMA	Band V	Right Cheek	0.139	0.001	0.14
		Right Tilted	0.073	0.001	0.07
		Left Cheek	0.121	0.001	0.12
		Left Tilted	0.057	0.001	0.06
	Band II	Right Cheek	0.069	0.001	0.07
		Right Tilted	0.039	0.001	0.04
		Left Cheek	0.140	0.001	0.14
		Left Tilted	0.039	0.001	0.04
LTE	Band 28	Right Cheek	0.044	0.001	0.05
		Right Tilted	0.032	0.001	0.03
		Left Cheek	0.043	0.001	0.04
		Left Tilted	0.025	0.001	0.03
	Band 4	Right Cheek	0.085	0.001	0.09
		Right Tilted	0.037	0.001	0.04
		Left Cheek	0.134	0.001	0.14
		Left Tilted	0.052	0.001	0.05
	Band 2	Right Cheek	0.051	0.001	0.05
		Right Tilted	0.027	0.001	0.03
		Left Cheek	0.107	0.001	0.11
		Left Tilted	0.037	0.001	0.04
	Band 7	Right Cheek	0.022	0.001	0.02
		Right Tilted	0.019	0.001	0.02
		Left Cheek	0.032	0.001	0.03
		Left Tilted	0.010	0.001	0.01

16.2 Hotspot Exposure Conditions

WWAN Band		Exposure Position	1	2	1+2 Summed 1g SAR (W/kg)
			WWAN	2.4GHz WLAN	
			1g SAR (W/kg)	1g SAR (W/kg)	
GSM	GSM850	Front	0.418	0.018	0.44
		Back	0.377	0.018	0.40
		Left side	0.290	0.018	0.31
		Top side		0.018	0.02
		Bottom side	0.210		0.21
	GSM1900	Front	0.502	0.018	0.52
		Back	0.293	0.018	0.31
		Left side	0.088	0.018	0.11
		Top side		0.018	0.02
		Bottom side	0.713		0.71
WCDMA	Band V	Front	0.222	0.018	0.24
		Back	0.194	0.018	0.21
		Left side	0.131	0.018	0.15
		Top side		0.018	0.02
		Bottom side	0.121		0.12
	Band II	Front	0.548	0.018	0.57
		Back	0.318	0.018	0.34
		Left side	0.094	0.018	0.11
		Top side		0.018	0.02
		Bottom side	0.790		0.79



WWAN Band		Exposure Position	1	2	1+2 Summed 1g SAR (W/kg)
			WWAN	2.4GHz WLAN	
			1g SAR (W/kg)	1g SAR (W/kg)	
LTE	Band 28	Front	0.099	0.018	0.12
		Back	0.103	0.018	0.12
		Left side	0.046	0.018	0.06
		Top side		0.018	0.02
		Bottom side	0.026		0.03
	Band 4	Front	0.620	0.018	0.64
		Back	0.352	0.018	0.37
		Left side	0.095	0.018	0.11
		Top side		0.018	0.02
		Bottom side	0.983		0.98
	Band 2	Front	0.426	0.018	0.44
		Back	0.258	0.018	0.28
		Left side	0.072	0.018	0.09
		Top side		0.018	0.02
		Bottom side	0.625		0.63
	Band 7	Front	0.188	0.018	0.21
		Back	0.373	0.018	0.39
		Left side	0.094	0.018	0.11
		Top side		0.018	0.02
		Bottom side	0.415		0.42



16.3 Body-Worn Accessory Exposure Conditions

WWAN Band		Exposure Position	1	2	3	1+2 Summed 1g SAR (W/kg)	1+3 Summed 1g SAR (W/kg)
			WWAN	2.4GHz WLAN	Bluetooth		
			1g SAR (W/kg)	1g SAR (W/kg)	Estimated 1g SAR (W/kg)		
GSM	GSM850	Front	0.418	0.018	0.126	0.44	0.54
		Back	0.377	0.018	0.126	0.40	0.50
	GSM1900	Front	0.502	0.018	0.126	0.52	0.63
		Back	0.293	0.018	0.126	0.31	0.42
WCDMA	Band V	Front	0.222	0.018	0.126	0.24	0.35
		Back	0.194	0.018	0.126	0.21	0.32
	Band II	Front	0.548	0.018	0.126	0.57	0.67
		Back	0.318	0.018	0.126	0.34	0.44
LTE	Band 28	Front	0.099	0.018	0.126	0.12	0.23
		Back	0.103	0.018	0.126	0.12	0.23
	Band 4	Front	0.620	0.018	0.126	0.64	0.75
		Back	0.352	0.018	0.126	0.37	0.48
	Band 2	Front	0.426	0.018	0.126	0.44	0.55
		Back	0.258	0.018	0.126	0.28	0.38
	Band 7	Front	0.188	0.018	0.126	0.21	0.31
		Back	0.373	0.018	0.126	0.39	0.50

Test Engineer : Luke Lu

17. Uncertainty Assessment

The component of uncertainty may generally be categorized according to the methods used to evaluate them. The evaluation of uncertainty by the statistical analysis of a series of observations is termed a Type A evaluation of uncertainty. The evaluation of uncertainty by means other than the statistical analysis of a series of observation is termed a Type B evaluation of uncertainty. Each component of uncertainty, however evaluated, is represented by an estimated standard deviation, termed standard uncertainty, which is determined by the positive square root of the estimated variance.

A Type A evaluation of standard uncertainty may be based on any valid statistical method for treating data. This includes calculating the standard deviation of the mean of a series of independent observations; using the method of least squares to fit a curve to the data in order to estimate the parameter of the curve and their standard deviations; or carrying out an analysis of variance in order to identify and quantify random effects in certain kinds of measurement.

A type B evaluation of standard uncertainty is typically based on scientific judgment using all of the relevant information available. These may include previous measurement data, experience, and knowledge of the behavior and properties of relevant materials and instruments, manufacture’s specification, data provided in calibration reports and uncertainties assigned to reference data taken from handbooks. Broadly speaking, the uncertainty is either obtained from an outdoor source or obtained from an assumed distribution, such as the normal distribution, rectangular or triangular distributions indicated in table below.

Uncertainty Distributions	Normal	Rectangular	Triangular	U-Shape
Multi-plying Factor ^(a)	1/k ^(b)	1/√3	1/√6	1/√2

(a) standard uncertainty is determined as the product of the multiplying factor and the estimated range of variations in the measured quantity

(b) κ is the coverage factor

Table 17.1. Standard Uncertainty for Assumed Distribution

The combined standard uncertainty of the measurement result represents the estimated standard deviation of the result. It is obtained by combining the individual standard uncertainties of both Type A and Type B evaluation using the usual “root-sum-squares” (RSS) methods of combining standard deviations by taking the positive square root of the estimated variances.

Expanded uncertainty is a measure of uncertainty that defines an interval about the measurement result within which the measured value is confidently believed to lie. It is obtained by multiplying the combined standard uncertainty by a coverage factor. Typically, the coverage factor ranges from 2 to 3. Using a coverage factor allows the true value of a measured quantity to be specified with a defined probability within the specified uncertainty range. For purpose of this document, a coverage factor two is used, which corresponds to confidence interval of about 95 %. The DASY uncertainty Budget is shown in the following tables.

Error Description	Uncertainty Value (±%)	Probability	Divisor	(Ci) 1g	(Ci) 10g	Standard Uncertainty (1g) (±%)	Standard Uncertainty (10g) (±%)
Measurement System							
Probe Calibration	6.0	N	1	1	1	6.0	6.0
Axial Isotropy	4.7	R	1.732	0.7	0.7	1.9	1.9
Hemispherical Isotropy	9.6	R	1.732	0.7	0.7	3.9	3.9
Boundary Effects	1.0	R	1.732	1	1	0.6	0.6
Linearity	4.7	R	1.732	1	1	2.7	2.7
System Detection Limits	1.0	R	1.732	1	1	0.6	0.6
Modulation Response	3.2	R	1.732	1	1	1.8	1.8
Readout Electronics	0.3	N	1	1	1	0.3	0.3
Response Time	0.0	R	1.732	1	1	0.0	0.0
Integration Time	2.6	R	1.732	1	1	1.5	1.5
RF Ambient Noise	3.0	R	1.732	1	1	1.7	1.7
RF Ambient Reflections	3.0	R	1.732	1	1	1.7	1.7
Probe Positioner	0.4	R	1.732	1	1	0.2	0.2
Probe Positioning	2.9	R	1.732	1	1	1.7	1.7
Max. SAR Eval.	2.0	R	1.732	1	1	1.2	1.2
Test Sample Related							
Device Positioning	3.0	N	1	1	1	3.0	3.0
Device Holder	3.6	N	1	1	1	3.6	3.6
Power Drift	5.0	R	1.732	1	1	2.9	2.9
Power Scaling	0.0	R	1.732	1	1	0.0	0.0
Phantom and Setup							
Phantom Uncertainty	6.1	R	1.732	1	1	3.5	3.5
SAR correction	0.0	R	1.732	1	0.84	0.0	0.0
Liquid Conductivity Repeatability	0.2	N	1	0.78	0.71	0.1	0.1
Liquid Conductivity (target)	5.0	R	1.732	0.78	0.71	2.3	2.0
Liquid Conductivity (mea.)	2.5	R	1.732	0.78	0.71	1.1	1.0
Temp. unc. - Conductivity	3.4	R	1.732	0.78	0.71	1.5	1.4
Liquid Permittivity Repeatability	0.15	N	1	0.23	0.26	0.0	0.0
Liquid Permittivity (target)	5.0	R	1.732	0.23	0.26	0.7	0.8
Liquid Permittivity (mea.)	2.5	R	1.732	0.23	0.26	0.3	0.4
Temp. unc. - Permittivity	0.83	R	1.732	0.23	0.26	0.1	0.1
Combined Std. Uncertainty						11.4%	11.4%
Coverage Factor for 95 %						K=2	K=2
Expanded STD Uncertainty						22.9%	22.7%

Table 17.2. Uncertainty Budget for frequency range 300 MHz to 3 GHz



18. References

- [1] FCC 47 CFR Part 2 "Frequency Allocations and Radio Treaty Matters; General Rules and Regulations"
- [2] ANSI/IEEE Std. C95.1-1992, "IEEE Standard for Safety Levels with Respect to Human Exposure to Radio Frequency Electromagnetic Fields, 3 kHz to 300 GHz", September 1992
- [3] IEEE Std. 1528-2013, "IEEE Recommended Practice for Determining the Peak Spatial-Average Specific Absorption Rate (SAR) in the Human Head from Wireless Communications Devices: Measurement Techniques", Sep 2013
- [4] SPEAG DASY System Handbook
- [5] FCC KDB 248227 D01 v02r02, "SAR Guidance for IEEE 802.11 (WiFi) Transmitters", Oct 2015.
- [6] FCC KDB 447498 D01 v06, "Mobile and Portable Device RF Exposure Procedures and Equipment Authorization Policies", Oct 2015
- [7] FCC KDB 648474 D04 v01r03, "SAR Evaluation Considerations for Wireless Handsets", Oct 2015.
- [8] FCC KDB 941225 D01 v03r01, "3G SAR MEAUREMENT PROCEDURES", Oct 2015
- [9] FCC KDB 941225 D05 v02r05, "SAR Evaluation Considerations for LTE Devices", Dec 2015
- [10] FCC KDB 941225 D06 v02r01, "SAR Evaluation Procedures for Portable Devices with Wireless Router Capabilities", Oct 2015.
- [11] FCC KDB 865664 D01 v01r04, "SAR Measurement Requirements for 100 MHz to 6 GHz", Aug 2015.
- [12] FCC KDB 865664 D02 v01r02, "RF Exposure Compliance Reporting and Documentation Considerations" Oct 2015.



Appendix A. Plots of System Performance Check

The plots are shown as follows.

System Check_Head_750MHz_160804

DUT: D750V3-SN:1099

Communication System: UID 0, CW (0); Frequency: 750 MHz; Duty Cycle: 1:1
Medium: HSL_750_160804 Medium parameters used: $f = 750$ MHz; $\sigma = 0.88$ S/m; $\epsilon_r = 40.797$; $\rho = 1000$ kg/m³
Ambient Temperature : 23.6 °C; Liquid Temperature : 22.6 °C

DASY5 Configuration:

- Probe: EX3DV4 - SN3578; ConvF(9.65, 9.65, 9.65); Calibrated: 2016.05.11;
- Sensor-Surface: 2mm (Mechanical Surface Detection)
- Electronics: DAE4 Sn914; Calibrated: 2016.01.07
- Phantom: SAM1; Type: QD000P40CD; Serial: TP:1670
- Measurement SW: DASY52, Version 52.8 (8); SEMCAD X Version 14.6.10 (7331)

Pin=250mW/Area Scan (61x61x1): Interpolated grid: dx=15mm, dy=15mm
Maximum value of SAR (interpolated) = 2.80 W/kg

Pin=250mW/Zoom Scan (5x5x7)/Cube 0: Measurement grid: dx=8mm, dy=8mm, dz=5mm
Reference Value = 63.98 V/m; Power Drift = 0.03 dB
Peak SAR (extrapolated) = 3.42 W/kg
SAR(1 g) = 2.09 W/kg; SAR(10 g) = 1.36 W/kg
Maximum value of SAR (measured) = 2.91 W/kg

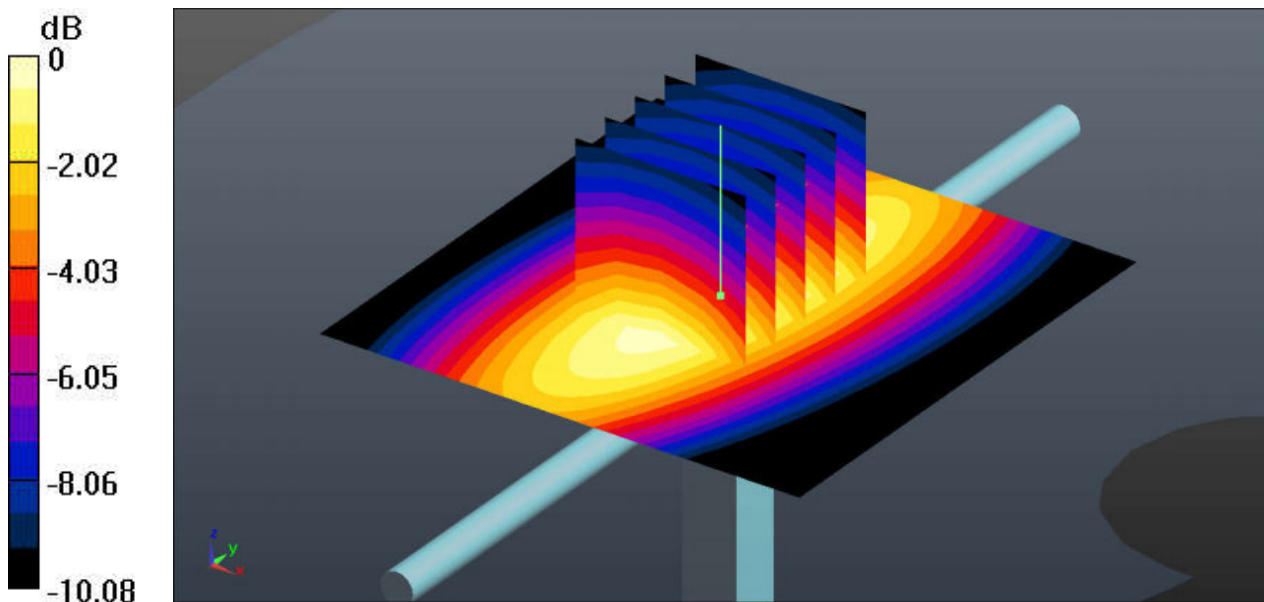

0 dB = 2.91 W/kg

System Check_Head_835MHz_160804

DUT: D835V2-SN:4d162

Communication System: UID 0, CW; Frequency: 835 MHz; Duty Cycle: 1:1

Medium: HSL_835_160804 Medium parameters used: $f = 835 \text{ MHz}$; $\sigma = 0.886 \text{ S/m}$; $\epsilon_r = 41.952$; $\rho = 1000 \text{ kg/m}^3$

Ambient Temperature : $23.6 \text{ }^\circ\text{C}$; Liquid Temperature : $22.5 \text{ }^\circ\text{C}$

DASY5 Configuration:

- Probe: EX3DV4 - SN3578; ConvF(9.48, 9.48, 9.48); Calibrated: 2016.05.11;
- Sensor-Surface: 2mm (Mechanical Surface Detection)
- Electronics: DAE4 Sn914; Calibrated: 2016.01.07
- Phantom: SAM1; Type: QD000P40CD; Serial: TP:1670
- Measurement SW: DASY52, Version 52.8 (8); SEMCAD X Version 14.6.10 (7331)

Pin=250mW/Area Scan (61x61x1): Interpolated grid: $dx=15\text{mm}$, $dy=15\text{mm}$

Maximum value of SAR (interpolated) = 2.96 W/kg

Pin=250mW/Zoom Scan (5x5x7)/Cube 0: Measurement grid: $dx=8\text{mm}$, $dy=8\text{mm}$, $dz=5\text{mm}$

Reference Value = 61.66 V/m ; Power Drift = -0.01 dB

Peak SAR (extrapolated) = 3.55 W/kg

SAR(1 g) = 2.28 W/kg ; SAR(10 g) = 1.49 W/kg

Maximum value of SAR (measured) = 2.97 W/kg

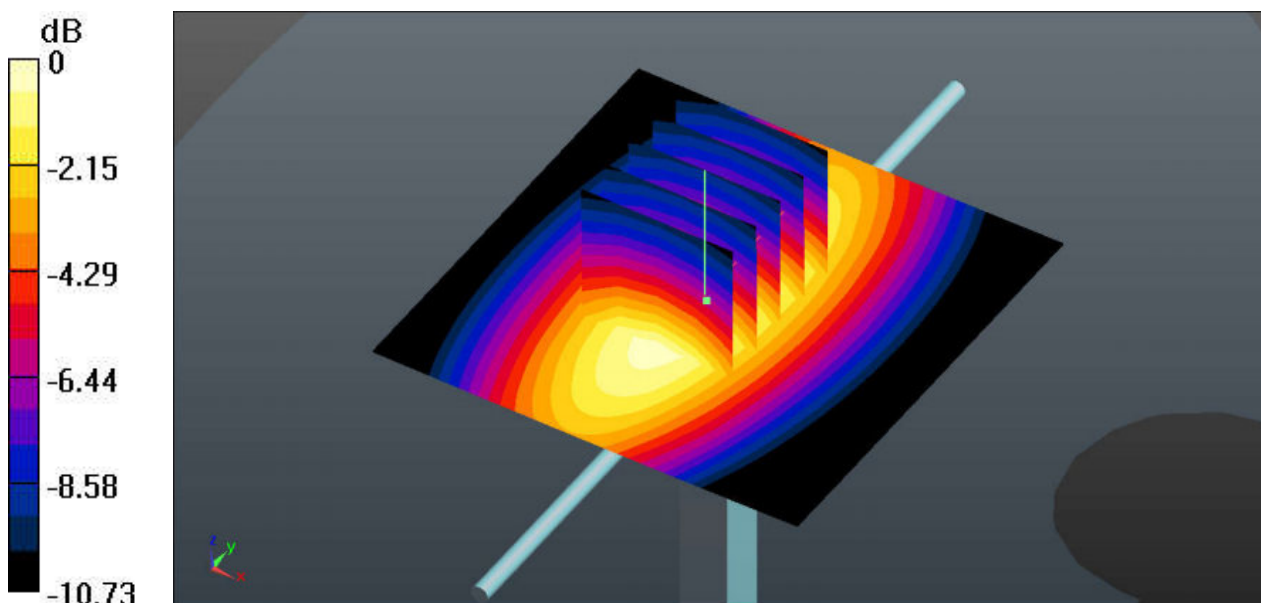

0 dB = 2.97 W/kg

System Check_Head_1750MHz_160805

DUT: D1750V2-SN:1137

Communication System: UID 0, CW; Frequency: 1750 MHz; Duty Cycle: 1:1
Medium: HSL_1800_160805 Medium parameters used: $f = 1750$ MHz; $\sigma = 1.373$ S/m; $\epsilon_r = 41.392$;
 $\rho = 1000$ kg/m³
Ambient Temperature : 23.4 °C ; Liquid Temperature : 22.7 °C

DASY5 Configuration:

- Probe: EX3DV4 - SN3578; ConvF(8.35, 8.35, 8.35); Calibrated: 2016.05.11;
- Sensor-Surface: 2mm (Mechanical Surface Detection)
- Electronics: DAE4 Sn914; Calibrated: 2016.01.07
- Phantom: SAM1; Type: QD000P40CD; Serial: TP:1670
- Measurement SW: DASY52, Version 52.8 (8); SEMCAD X Version 14.6.10 (7331)

Pin=250mW/Area Scan (61x61x1): Interpolated grid: dx=15mm, dy=15mm
Maximum value of SAR (interpolated) = 13.7 W/kg

Pin=250mW/Zoom Scan (5x5x7)/Cube 0: Measurement grid: dx=8mm, dy=8mm, dz=5mm
Reference Value = 101.5 V/m; Power Drift = 0.01 dB
Peak SAR (extrapolated) = 17.2 W/kg
SAR(1 g) = 9.66 W/kg; SAR(10 g) = 5.12 W/kg
Maximum value of SAR (measured) = 13.6 W/kg

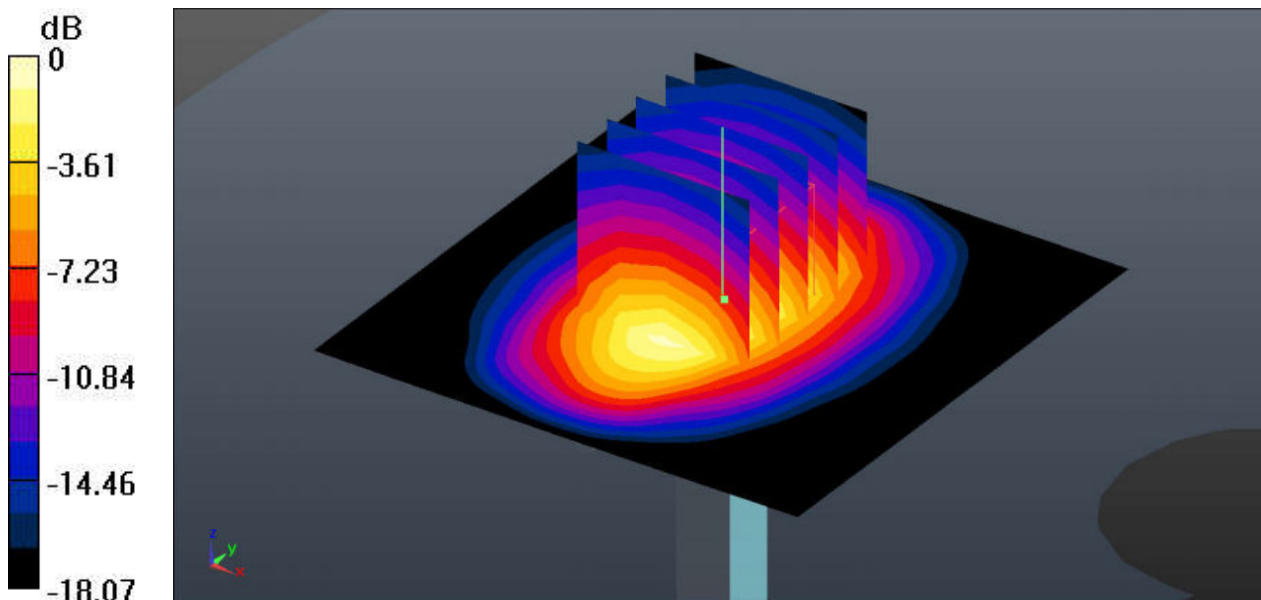

0 dB = 13.6 W/kg

System Check_Head_1900MHz_160805

DUT: D1900V2-SN:5d182

Communication System: UID 0, CW; Frequency: 1900 MHz; Duty Cycle: 1:1
Medium: HSL_1900_160805 Medium parameters used: $f = 1900$ MHz; $\sigma = 1.415$ S/m; $\epsilon_r = 41.124$;
 $\rho = 1000$ kg/m³
Ambient Temperature : 23.4 °C; Liquid Temperature : 22.6 °C

DASY5 Configuration:

- Probe: EX3DV4 - SN3578; ConvF(7.99, 7.99, 7.99); Calibrated: 2016.05.11;
- Sensor-Surface: 2mm (Mechanical Surface Detection)
- Electronics: DAE4 Sn914; Calibrated: 2016.01.07
- Phantom: SAM1; Type: QD000P40CD; Serial: TP:1670
- Measurement SW: DASY52, Version 52.8 (8); SEMCAD X Version 14.6.10 (7331)

Pin=250mW/Area Scan (61x61x1): Interpolated grid: dx=15mm, dy=15mm
Maximum value of SAR (interpolated) = 14.6 W/kg

Pin=250mW/Zoom Scan (5x5x7)/Cube 0: Measurement grid: dx=8mm, dy=8mm, dz=5mm
Reference Value = 104.1 V/m; Power Drift = -0.02 dB
Peak SAR (extrapolated) = 18.4 W/kg
SAR(1 g) = 10.2 W/kg; SAR(10 g) = 5.36 W/kg
Maximum value of SAR (measured) = 14.5 W/kg

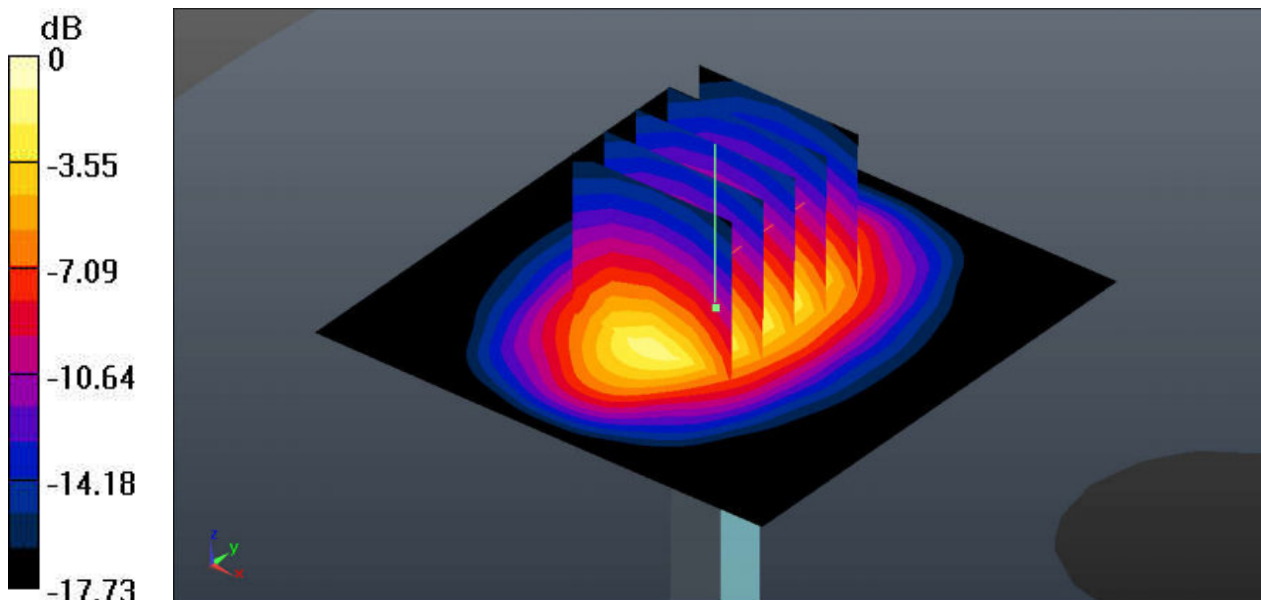

0 dB = 14.5 W/kg

System Check_Head_2450MHz_160812

DUT: D2450V2-SN:924

Communication System: UID 0, CW; Frequency: 2450 MHz; Duty Cycle: 1:1
Medium: HSL_2450_160812 Medium parameters used: $f = 2450$ MHz; $\sigma = 1.746$ S/m; $\epsilon_r = 39.247$;
 $\rho = 1000$ kg/m³
Ambient Temperature : 23.8 °C; Liquid Temperature : 22.5 °C

DASY5 Configuration:

- Probe: EX3DV4 - SN3578; ConvF(7.28, 7.28, 7.28); Calibrated: 2016.05.11;
- Sensor-Surface: 2mm (Mechanical Surface Detection)
- Electronics: DAE4 Sn914; Calibrated: 2016.01.07
- Phantom: SAM1; Type: QD000P40CD; Serial: TP:1670
- Measurement SW: DASY52, Version 52.8 (8); SEMCAD X Version 14.6.10 (7331)

Pin=250mW/Area Scan (81x81x1): Interpolated grid: dx=12mm, dy=12mm
Maximum value of SAR (interpolated) = 19.8 W/kg

Pin=250mW/Zoom Scan (7x7x7)/Cube 0: Measurement grid: dx=5mm, dy=5mm, dz=5mm
Reference Value = 91.59 V/m; Power Drift = -0.08 dB
Peak SAR (extrapolated) = 25.9 W/kg
SAR(1 g) = 12.8 W/kg; SAR(10 g) = 5.99 W/kg
Maximum value of SAR (measured) = 19.5 W/kg

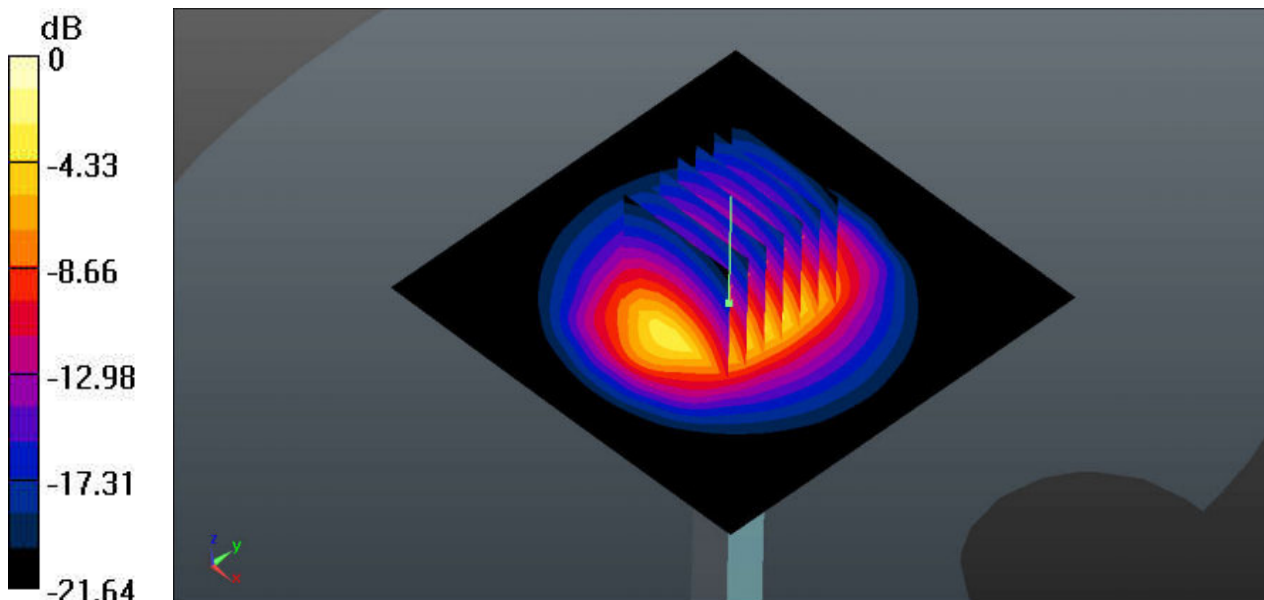

0 dB = 19.8 W/kg

System Check_Head_2600MHz_160805

DUT: D2600V2-SN:1070

Communication System: UID 0, CW; Frequency: 2600 MHz; Duty Cycle: 1:1

Medium: HSL_2600_160805 Medium parameters used: $f = 2600$ MHz; $\sigma = 2.05$ S/m; $\epsilon_r = 38.344$; $\rho = 1000$ kg/m³

Ambient Temperature : 23.7 °C; Liquid Temperature : 22.5 °C

DASY5 Configuration:

- Probe: EX3DV4 - SN3578; ConvF(7.21, 7.21, 7.21); Calibrated: 2016.05.11;
- Sensor-Surface: 2mm (Mechanical Surface Detection)
- Electronics: DAE4 Sn914; Calibrated: 2016.01.07
- Phantom: SAM1; Type: QD000P40CD; Serial: TP:1670
- Measurement SW: DASY52, Version 52.8 (8); SEMCAD X Version 14.6.10 (7331)

Pin=250mW/Area Scan (61x61x1): Interpolated grid: dx=12mm, dy=12mm

Maximum value of SAR (interpolated) = 23.4 W/kg

Pin=250mW/Zoom Scan (7x7x7)/Cube 0: Measurement grid: dx=5mm, dy=5mm, dz=5mm

Reference Value = 104.3 V/m; Power Drift = -0.08 dB

Peak SAR (extrapolated) = 31.4 W/kg

SAR(1 g) = 14.8 W/kg; SAR(10 g) = 6.6 W/kg

Maximum value of SAR (measured) = 22.9 W/kg

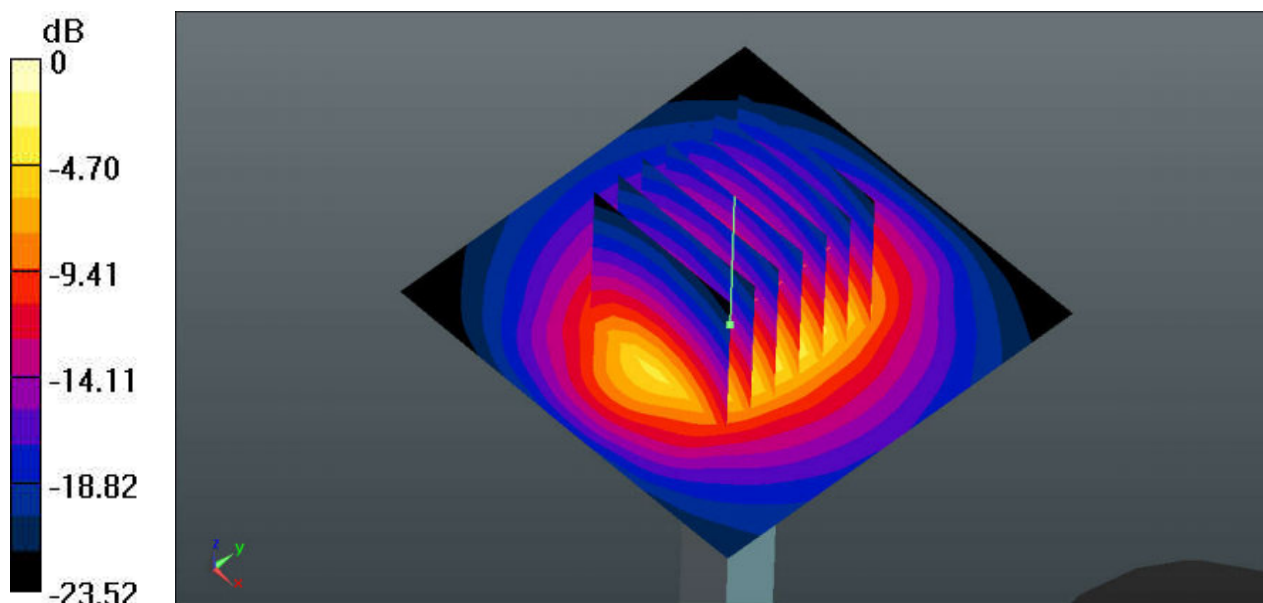

0 dB = 23.4 W/kg

System Check_Body_750MHz_160802

DUT: D750V3-SN:1099

Communication System: UID 0, CW (0); Frequency: 750 MHz; Duty Cycle: 1:1
Medium: MSL_750_160802 Medium parameters used: $f = 750$ MHz; $\sigma = 0.961$ S/m; $\epsilon_r = 53.914$; $\rho = 1000$ kg/m³
Ambient Temperature : 23.5 °C; Liquid Temperature : 22.6 °C

DASY5 Configuration:

- Probe: EX3DV4 - SN3578; ConvF(9.81, 9.81, 9.81); Calibrated: 2016.05.11;
- Sensor-Surface: 2mm (Mechanical Surface Detection)
- Electronics: DAE4 Sn914; Calibrated: 2016.01.07
- Phantom: SAM1; Type: QD000P40CD; Serial: TP:1670
- Measurement SW: DASY52, Version 52.8 (8); SEMCAD X Version 14.6.10 (7331)

Pin=250mW/Area Scan (61x61x1): Interpolated grid: dx=15mm, dy=15mm
Maximum value of SAR (interpolated) = 2.67 W/kg

Pin=250mW/Zoom Scan (5x5x7)/Cube 0: Measurement grid: dx=8mm, dy=8mm, dz=5mm
Reference Value = 53.53 V/m; Power Drift = 0.01 dB
Peak SAR (extrapolated) = 3.09 W/kg
SAR(1 g) = 2.15 W/kg; SAR(10 g) = 1.45 W/kg
Maximum value of SAR (measured) = 2.68 W/kg

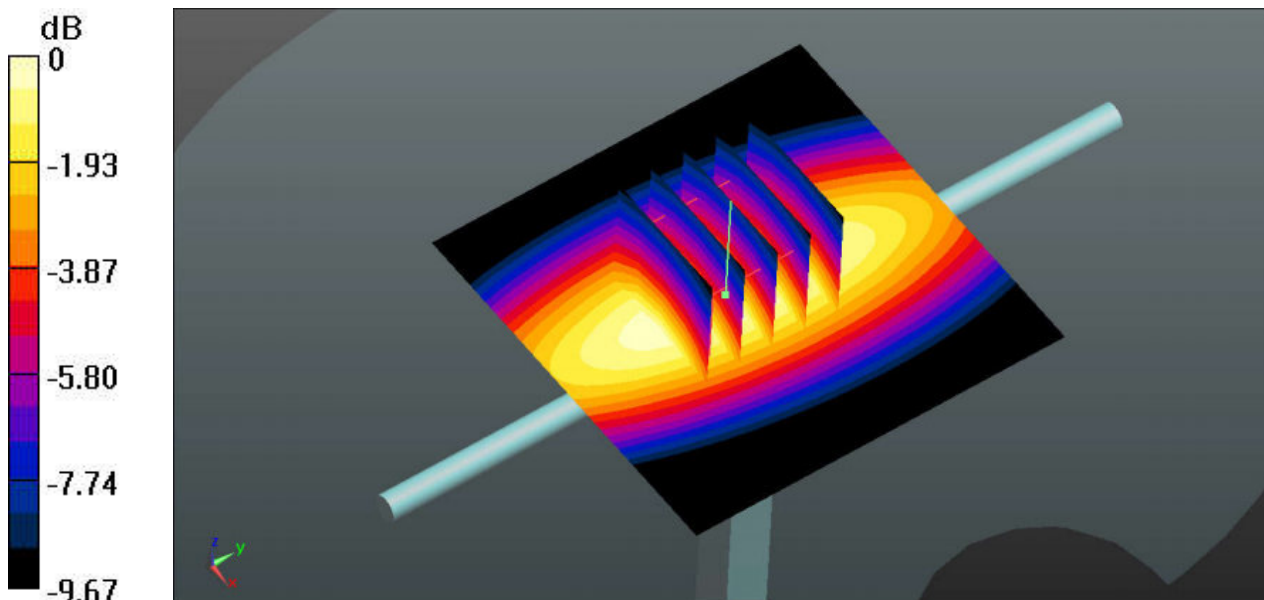

0 dB = 2.67 W/kg

System Check_Body_835MHz_160802

DUT: D835V2-SN:4d162

Communication System: UID 0, CW; Frequency: 835 MHz; Duty Cycle: 1:1

Medium: MSL_835_160802 Medium parameters used: $f = 835$ MHz; $\sigma = 1.011$ S/m; $\epsilon_r = 56.243$; $\rho = 1000$ kg/m³

Ambient Temperature : 23.4 °C; Liquid Temperature : 22.6 °C

DASY5 Configuration:

- Probe: EX3DV4 - SN3578; ConvF(9.53, 9.53, 9.53); Calibrated: 2016.05.11;
- Sensor-Surface: 2mm (Mechanical Surface Detection)
- Electronics: DAE4 Sn914; Calibrated: 2016.01.07
- Phantom: SAM1; Type: QD000P40CD; Serial: TP:1670
- Measurement SW: DASY52, Version 52.8 (8); SEMCAD X Version 14.6.10 (7331)

Pin=250mW/Area Scan (61x61x1): Interpolated grid: dx=15mm, dy=15mm

Maximum value of SAR (interpolated) = 3.05 W/kg

Pin=250mW/Zoom Scan (5x5x7)/Cube 0: Measurement grid: dx=8mm, dy=8mm, dz=5mm

Reference Value = 56.46 V/m; Power Drift = 0.01 dB

Peak SAR (extrapolated) = 3.54 W/kg

SAR(1 g) = 2.44 W/kg; SAR(10 g) = 1.61 W/kg

Maximum value of SAR (measured) = 3.06 W/kg

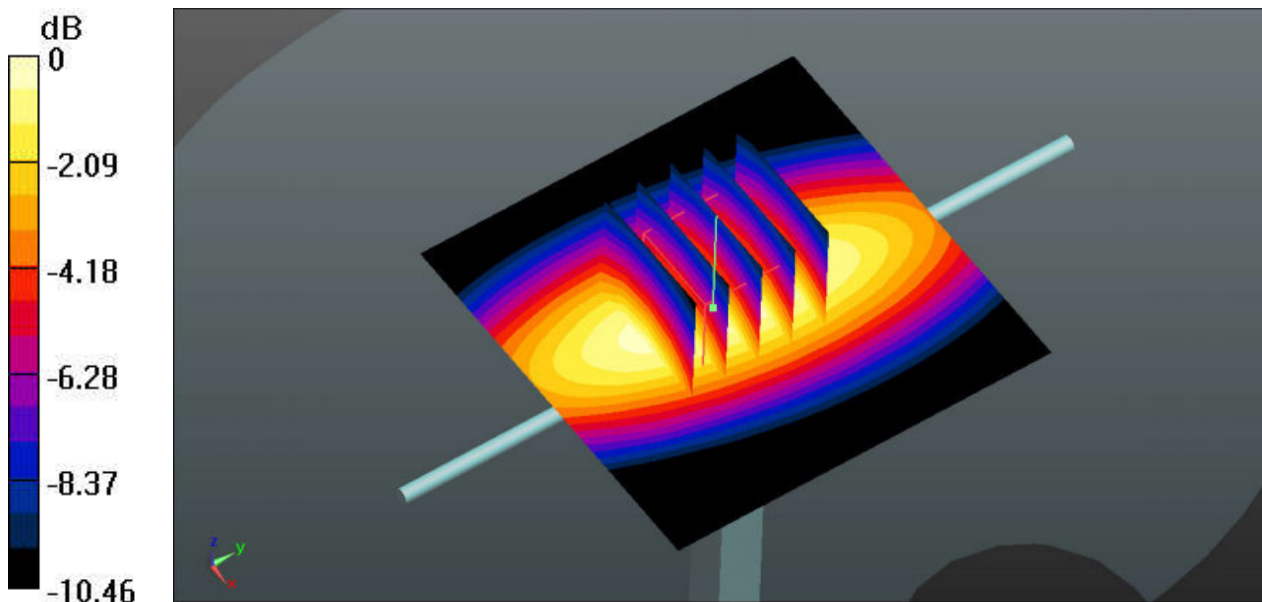

0 dB = 3.05 W/kg

System Check_Body_1750MHz_160803

DUT: D1750V2-SN:1137

Communication System: UID 0, CW; Frequency: 1750 MHz; Duty Cycle: 1:1

Medium: MSL_1800_160803 Medium parameters used: $f = 1750$ MHz; $\sigma = 1.527$ S/m; $\epsilon_r = 52.02$; $\rho = 1000$ kg/m³

Ambient Temperature : 23.4 °C; Liquid Temperature : 22.8 °C

DASY5 Configuration:

- Probe: EX3DV4 - SN3578; ConvF(8.02, 8.02, 8.02); Calibrated: 2016.05.11;
- Sensor-Surface: 2mm (Mechanical Surface Detection)
- Electronics: DAE4 Sn914; Calibrated: 2016.01.07
- Phantom: SAM1; Type: QD000P40CD; Serial: TP:1670
- Measurement SW: DASY52, Version 52.8 (8); SEMCAD X Version 14.6.10 (7331)

Pin=250mW/Area Scan (61x61x1): Interpolated grid: dx=15mm, dy=15mm

Maximum value of SAR (interpolated) = 12.5 W/kg

Pin=250mW/Zoom Scan (5x5x7)/Cube 0: Measurement grid: dx=8mm, dy=8mm, dz=5mm

Reference Value = 93.48 V/m; Power Drift = -0.05 dB

Peak SAR (extrapolated) = 15.3 W/kg

SAR(1 g) = 8.86 W/kg; SAR(10 g) = 4.75 W/kg

Maximum value of SAR (measured) = 12.4 W/kg

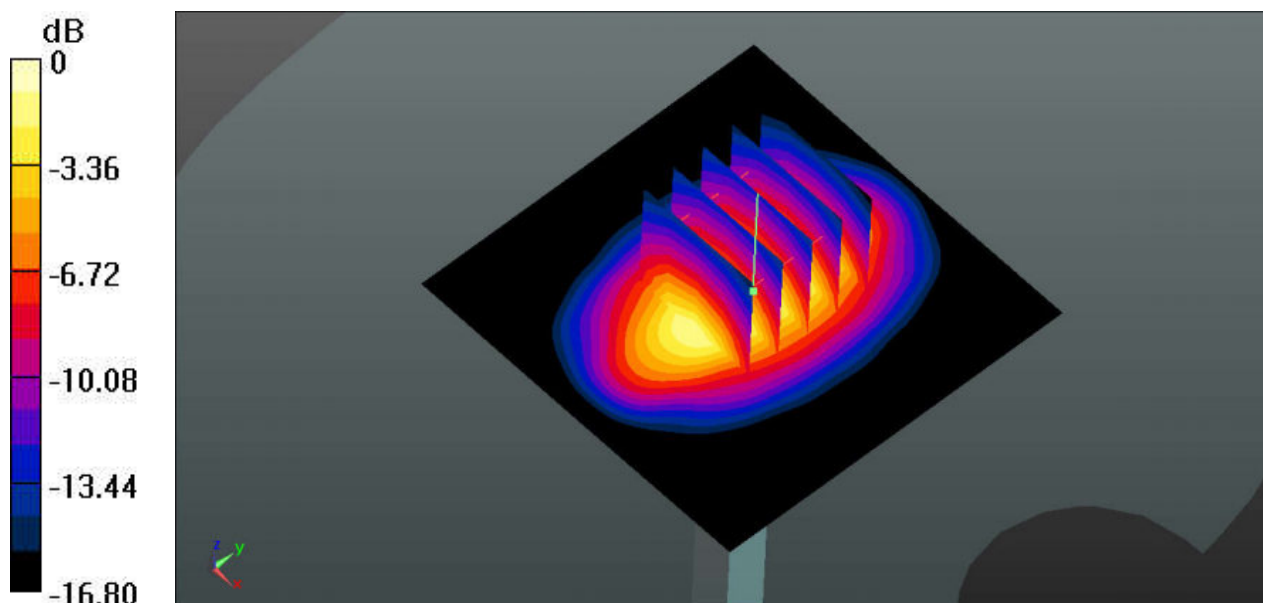

0 dB = 12.5 W/kg

System Check_Body_1900MHz_160803

DUT: D1900V2-SN:5d182

Communication System: UID 0, CW; Frequency: 1900 MHz; Duty Cycle: 1:1
Medium: MSL_1900_160803 Medium parameters used: $f = 1900$ MHz; $\sigma = 1.508$ S/m; $\epsilon_r = 54.618$;
 $\rho = 1000$ kg/m³
Ambient Temperature : 23.4 °C; Liquid Temperature : 22.7 °C

DASY5 Configuration:

- Probe: EX3DV4 - SN3578; ConvF(7.78, 7.78, 7.78); Calibrated: 2016.05.11;
- Sensor-Surface: 2mm (Mechanical Surface Detection)
- Electronics: DAE4 Sn914; Calibrated: 2016.01.07
- Phantom: SAM1; Type: QD000P40CD; Serial: TP:1670
- Measurement SW: DASY52, Version 52.8 (8); SEMCAD X Version 14.6.10 (7331)

Pin=250mW/Area Scan (61x61x1): Interpolated grid: dx=15mm, dy=15mm
Maximum value of SAR (interpolated) = 14.1 W/kg

Pin=250mW/Zoom Scan (5x5x7)/Cube 0: Measurement grid: dx=8mm, dy=8mm, dz=5mm
Reference Value = 84.77 V/m; Power Drift = -0.03 dB
Peak SAR (extrapolated) = 17.8 W/kg
SAR(1 g) = 9.84 W/kg; SAR(10 g) = 5.07 W/kg
Maximum value of SAR (measured) = 14.0 W/kg

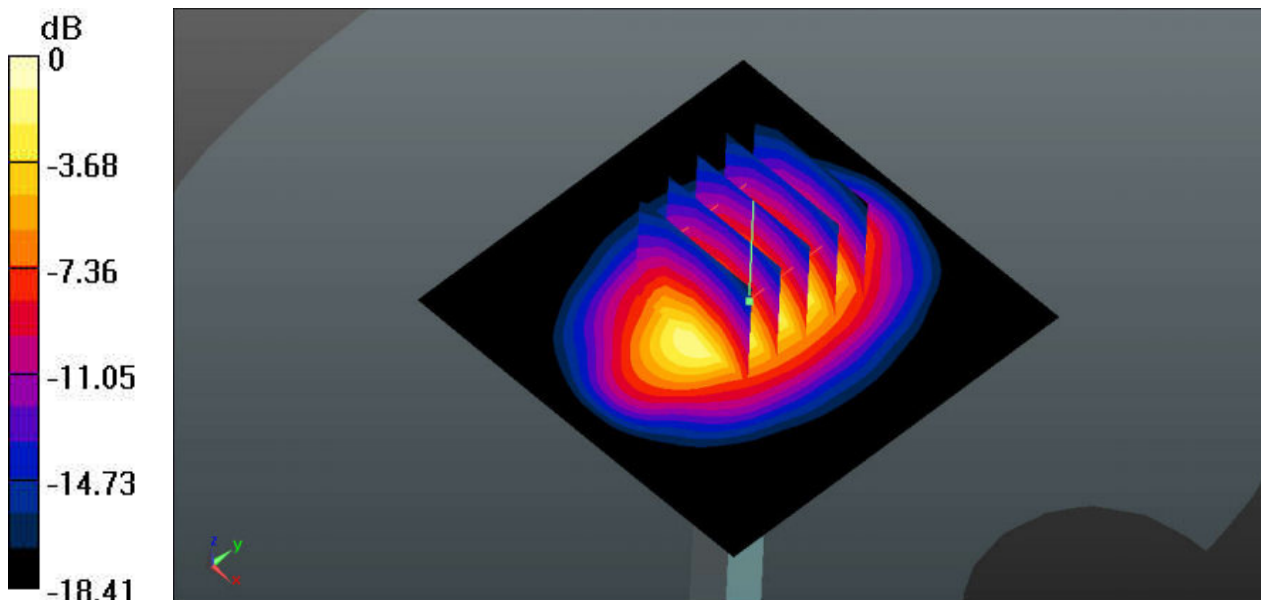

0 dB = 14.1 W/kg

System Check_Body_2450MHz_160812

DUT: D2450V2-SN:924

Communication System: UID 0, CW; Frequency: 2450 MHz; Duty Cycle: 1:1
Medium: MSL_2450_160812 Medium parameters used: $f = 2450$ MHz; $\sigma = 1.909$ S/m; $\epsilon_r = 50.971$;
 $\rho = 1000$ kg/m³
Ambient Temperature : 23.8 °C; Liquid Temperature : 22.8 °C

DASY5 Configuration:

- Probe: EX3DV4 - SN3578; ConvF(7.41, 7.41, 7.41); Calibrated: 2016.05.11;
- Sensor-Surface: 2mm (Mechanical Surface Detection)
- Electronics: DAE4 Sn914; Calibrated: 2016.01.07
- Phantom: SAM1; Type: QD000P40CD; Serial: TP:1670
- Measurement SW: DASY52, Version 52.8 (8); SEMCAD X Version 14.6.10 (7331)

Pin=250mW/Area Scan (81x81x1): Interpolated grid: dx=12mm, dy=12mm
Maximum value of SAR (interpolated) = 20.7 W/kg

Pin=250mW/Zoom Scan (7x7x7)/Cube 0: Measurement grid: dx=5mm, dy=5mm, dz=5mm
Reference Value = 87.47 V/m; Power Drift = -0.06 dB
Peak SAR (extrapolated) = 27.7 W/kg
SAR(1 g) = 13.4 W/kg; SAR(10 g) = 6.21 W/kg
Maximum value of SAR (measured) = 20.6 W/kg

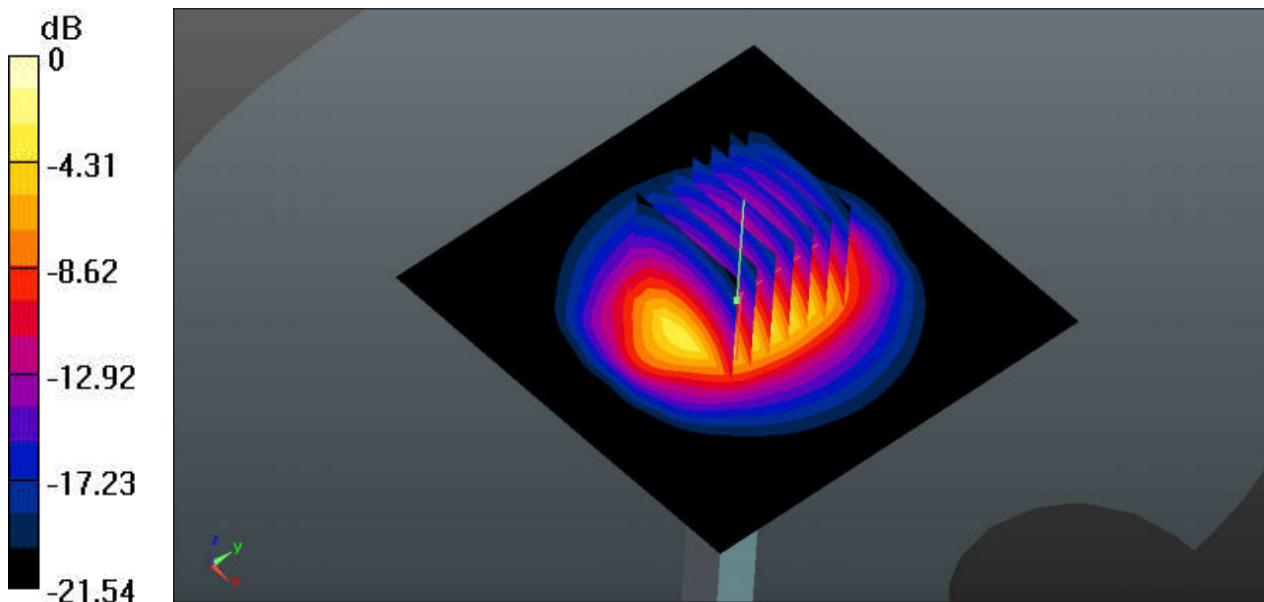

0 dB = 20.7 W/kg

System Check_Body_2600MHz_160804

DUT: D2600V2-SN:1070

Communication System: UID 0, CW; Frequency: 2600 MHz; Duty Cycle: 1:1
Medium: MSL_2600_160804 Medium parameters used: $f = 2600$ MHz; $\sigma = 2.165$ S/m; $\epsilon_r = 53.823$;
 $\rho = 1000$ kg/m³
Ambient Temperature : 23.4 °C; Liquid Temperature : 22.9 °C

DASY5 Configuration:

- Probe: EX3DV4 - SN3578; ConvF(7.17, 7.17, 7.17); Calibrated: 2016.05.11;
- Sensor-Surface: 2mm (Mechanical Surface Detection)
- Electronics: DAE4 Sn914; Calibrated: 2016.01.07
- Phantom: SAM1; Type: QD000P40CD; Serial: TP:1670
- Measurement SW: DASY52, Version 52.8 (8); SEMCAD X Version 14.6.10 (7331)

Pin=250mW/Area Scan (71x71x1): Interpolated grid: dx=12mm, dy=12mm
Maximum value of SAR (interpolated) = 21.5 W/kg

Pin=250mW/Zoom Scan (7x7x7)/Cube 0: Measurement grid: dx=5mm, dy=5mm, dz=5mm
Reference Value = 99.93 V/m; Power Drift = -0.08 dB
Peak SAR (extrapolated) = 28.9 W/kg
SAR(1 g) = 13.5 W/kg; SAR(10 g) = 5.95 W/kg
Maximum value of SAR (measured) = 21.2 W/kg

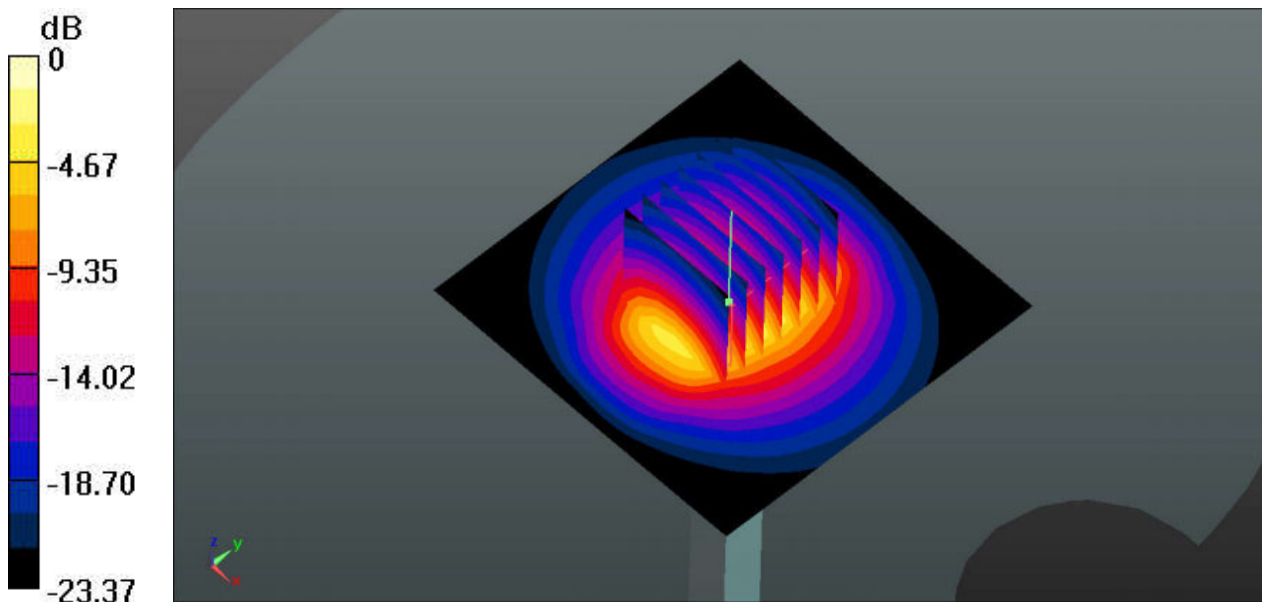

0 dB = 21.5 W/kg



Appendix B. Plots of High SAR Measurement

The plots are shown as follows.

01_GSM850_GPRS(4 Tx slots)_Right Cheek_Ch128

Communication System: UID 0, GPRS/EDGE12 (0); Frequency: 824.2 MHz; Duty Cycle: 1:2.08
Medium: HSL_835_160804 Medium parameters used: $f = 824.2$ MHz; $\sigma = 0.886$ S/m; $\epsilon_r = 42.095$;
 $\rho = 1000$ kg/m³
Ambient Temperature : 23.6 °C; Liquid Temperature : 22.5 °C

DASY5 Configuration:

- Probe: EX3DV4 - SN3578; ConvF(9.48, 9.48, 9.48); Calibrated: 2016.05.11;
- Sensor-Surface: 2mm (Mechanical Surface Detection)
- Electronics: DAE4 Sn914; Calibrated: 2016.01.07
- Phantom: SAM1; Type: QD000P40CD; Serial: TP:1670
- Measurement SW: DASY52, Version 52.8 (8); SEMCAD X Version 14.6.10 (7331)

Ch128/Area Scan (71x121x1): Interpolated grid: dx=15mm, dy=15mm
Maximum value of SAR (interpolated) = 0.275 W/kg

Ch128/Zoom Scan (5x5x7)/Cube 0: Measurement grid: dx=8mm, dy=8mm, dz=5mm
Reference Value = 1.454 V/m; Power Drift = 0.08 dB
Peak SAR (extrapolated) = 0.292 W/kg
SAR(1 g) = 0.238 W/kg; SAR(10 g) = 0.184 W/kg
Maximum value of SAR (measured) = 0.267 W/kg

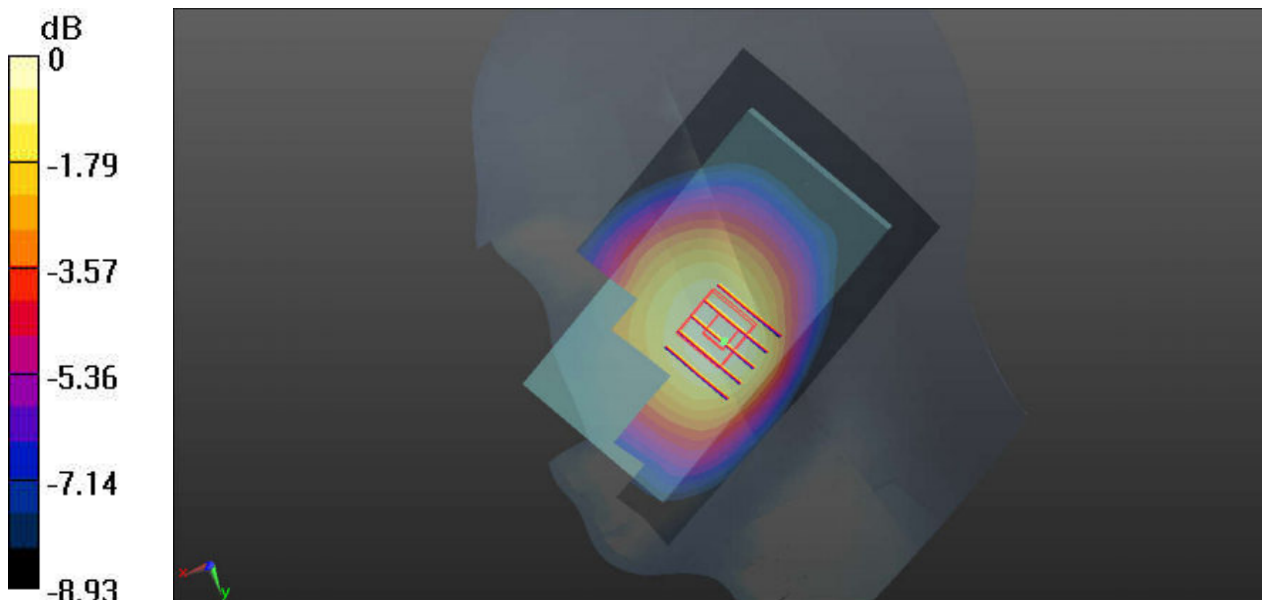

0 dB = 0.275 W/kg

02_GSM1900_GPRS(4 Tx slots)_Left Cheek_Ch810

Communication System: UID 0, GPRS/EDGE12 (0); Frequency: 1909.8 MHz; Duty Cycle: 1:2.08
Medium: HSL_1900_160805 Medium parameters used: $f = 1909.8$ MHz; $\sigma = 1.421$ S/m; $\epsilon_r = 41.093$; $\rho = 1000$ kg/m³
Ambient Temperature : 23.4 °C; Liquid Temperature : 22.6 °C

DASY5 Configuration:

- Probe: EX3DV4 - SN3578; ConvF(7.99, 7.99, 7.99); Calibrated: 2016.05.11;
- Sensor-Surface: 2mm (Mechanical Surface Detection)
- Electronics: DAE4 Sn914; Calibrated: 2016.01.07
- Phantom: SAM1; Type: QD000P40CD; Serial: TP:1670
- Measurement SW: DASY52, Version 52.8 (8); SEMCAD X Version 14.6.10 (7331)

Ch810/Area Scan (71x121x1): Interpolated grid: dx=15mm, dy=15mm
Maximum value of SAR (interpolated) = 0.114 W/kg

Ch810/Zoom Scan (5x5x7)/Cube 0: Measurement grid: dx=8mm, dy=8mm, dz=5mm
Reference Value = 0 V/m; Power Drift = 0.02 dB
Peak SAR (extrapolated) = 0.134 W/kg
SAR(1 g) = 0.086 W/kg; SAR(10 g) = 0.053 W/kg
Maximum value of SAR (measured) = 0.113 W/kg

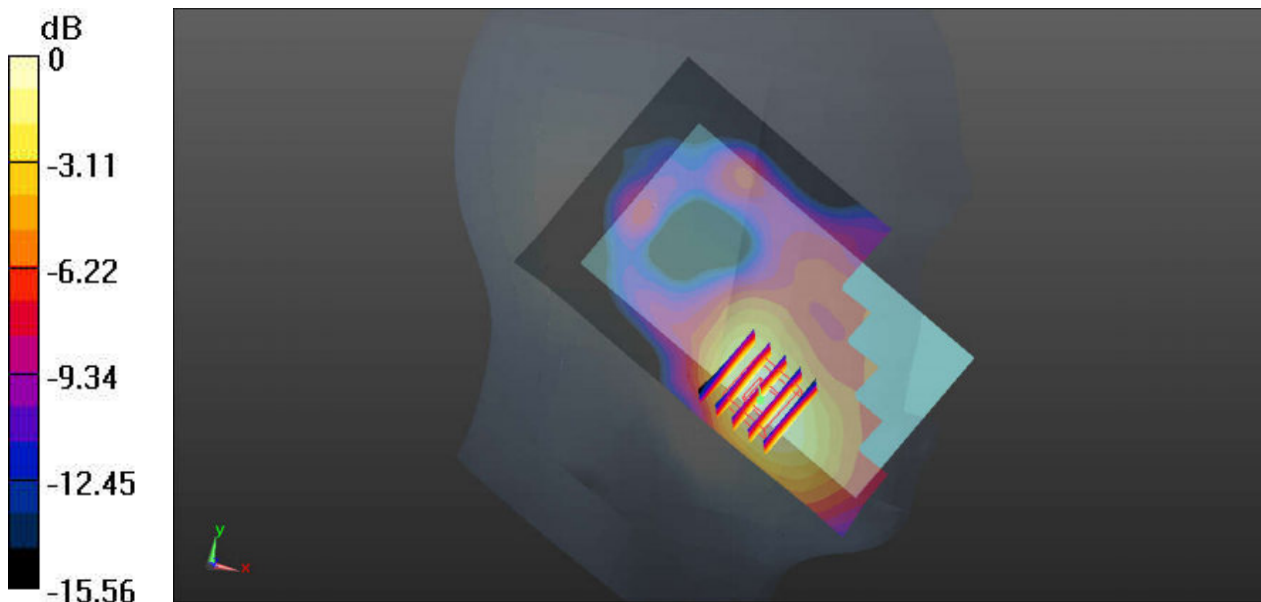

0 dB = 0.113 W/kg

03_WCDMA Band V_RMC 12.2Kbps_Right Cheek_Ch4182

Communication System: UID 0, UMTS (0); Frequency: 836.4 MHz; Duty Cycle: 1:1
 Medium: HSL_835_160804 Medium parameters used: $f = 836.4$ MHz; $\sigma = 0.885$ S/m; $\epsilon_r = 41.921$;
 $\rho = 1000$ kg/m³
 Ambient Temperature : 23.6 °C; Liquid Temperature : 22.5 °C

DASY5 Configuration:

- Probe: EX3DV4 - SN3578; ConvF(9.48, 9.48, 9.48); Calibrated: 2016.05.11;
- Sensor-Surface: 2mm (Mechanical Surface Detection)
- Electronics: DAE4 Sn914; Calibrated: 2016.01.07
- Phantom: SAM1; Type: QD000P40CD; Serial: TP:1670
- Measurement SW: DASY52, Version 52.8 (8); SEMCAD X Version 14.6.10 (7331)

Ch4182/Area Scan (71x121x1): Interpolated grid: dx=15mm, dy=15mm
 Maximum value of SAR (interpolated) = 0.138 W/kg

Ch4182/Zoom Scan (5x5x7)/Cube 0: Measurement grid: dx=8mm, dy=8mm, dz=5mm
 Reference Value = 1.042 V/m; Power Drift = 0.04 dB
 Peak SAR (extrapolated) = 0.147 W/kg
SAR(1 g) = 0.122 W/kg; SAR(10 g) = 0.095 W/kg
 Maximum value of SAR (measured) = 0.136 W/kg

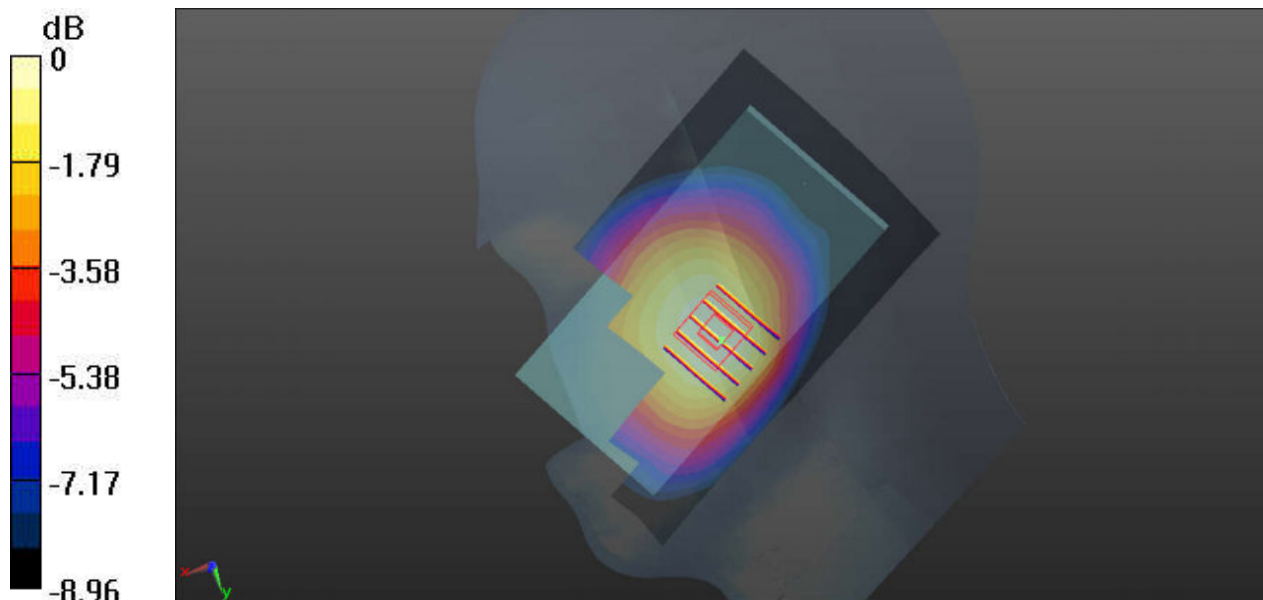

0 dB = 0.138 W/kg

04_WCDMA Band II_RMC 12.2Kbps_Left Cheek_Ch9400

Communication System: UID 0, UMTS (0); Frequency: 1880 MHz; Duty Cycle: 1:1
Medium: HSL_1900_160805 Medium parameters used: $f = 1880$ MHz; $\sigma = 1.401$ S/m; $\epsilon_r = 41.188$;
 $\rho = 1000$ kg/m³
Ambient Temperature : 23.4 °C; Liquid Temperature : 22.6 °C

DASY5 Configuration:

- Probe: EX3DV4 - SN3578; ConvF(7.99, 7.99, 7.99); Calibrated: 2016.05.11;
- Sensor-Surface: 2mm (Mechanical Surface Detection)
- Electronics: DAE4 Sn914; Calibrated: 2016.01.07
- Phantom: SAM1; Type: QD000P40CD; Serial: TP:1670
- Measurement SW: DASY52, Version 52.8 (8); SEMCAD X Version 14.6.10 (7331)

Ch9400/Area Scan (71x121x1): Interpolated grid: dx=15mm, dy=15mm
Maximum value of SAR (interpolated) = 0.160 W/kg

Ch9400/Zoom Scan (5x5x7)/Cube 0: Measurement grid: dx=8mm, dy=8mm, dz=5mm
Reference Value = 1.037 V/m; Power Drift = 0.06 dB
Peak SAR (extrapolated) = 0.187 W/kg
SAR(1 g) = 0.123 W/kg; SAR(10 g) = 0.077 W/kg
Maximum value of SAR (measured) = 0.159 W/kg

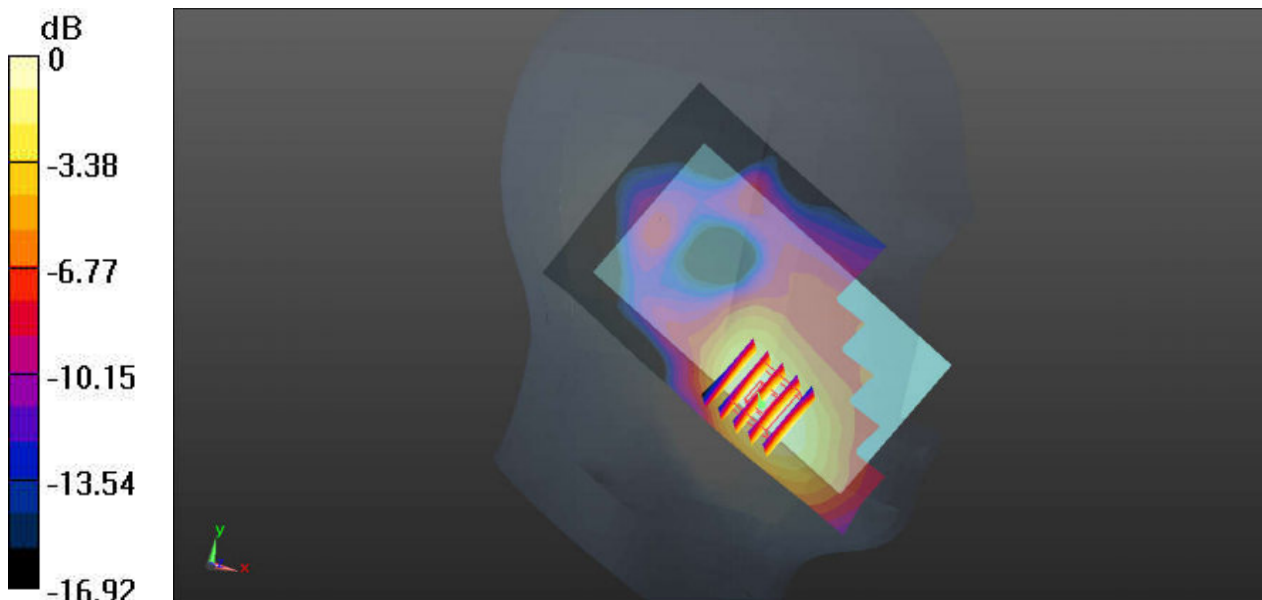

0 dB = 0.159 W/kg

05_LTE Band 28_20M_QPSK_1RB_0Offset_Right Cheek_Ch27410

Communication System: UID 0, LTE (0); Frequency: 723 MHz; Duty Cycle: 1:1
Medium: HSL_750_160804 Medium parameters used: $f = 723 \text{ MHz}$; $\sigma = 0.872 \text{ S/m}$; $\epsilon_r = 41.463$; $\rho = 1000 \text{ kg/m}^3$
Ambient Temperature : $23.6 \text{ }^\circ\text{C}$; Liquid Temperature : $22.6 \text{ }^\circ\text{C}$

DASY5 Configuration:

- Probe: EX3DV4 - SN3578; ConvF(9.65, 9.65, 9.65); Calibrated: 2016.05.11;
- Sensor-Surface: 2mm (Mechanical Surface Detection)
- Electronics: DAE4 Sn914; Calibrated: 2016.01.07
- Phantom: SAM1; Type: QD000P40CD; Serial: TP:1670
- Measurement SW: DASY52, Version 52.8 (8); SEMCAD X Version 14.6.10 (7331)

Ch27410/Area Scan (71x121x1): Interpolated grid: $dx=15\text{mm}$, $dy=15\text{mm}$
Maximum value of SAR (interpolated) = 0.0437 W/kg

Ch27410/Zoom Scan (5x5x7)/Cube 0: Measurement grid: $dx=8\text{mm}$, $dy=8\text{mm}$, $dz=5\text{mm}$
Reference Value = 1.039 V/m ; Power Drift = -0.03 dB
Peak SAR (extrapolated) = 0.0450 W/kg
SAR(1 g) = 0.038 W/kg ; SAR(10 g) = 0.031 W/kg
Maximum value of SAR (measured) = 0.0424 W/kg

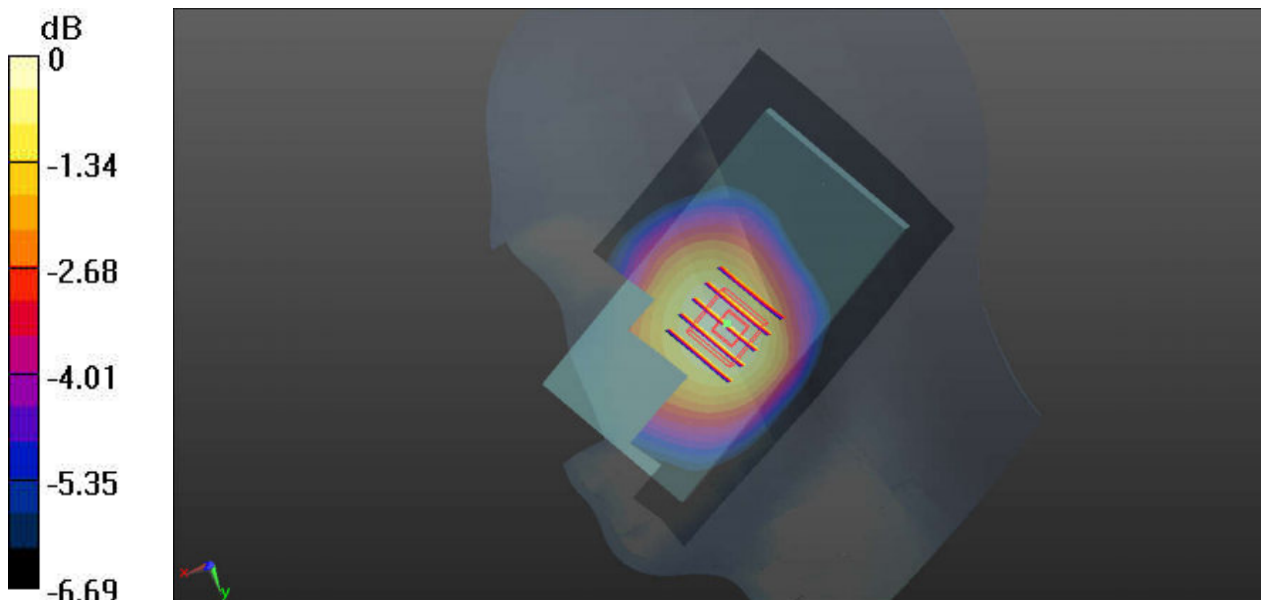

0 dB = 0.0437 W/kg

06_LTE Band 4_20M_QPSK_1RB_0Offset_Left Cheek_Ch20175

Communication System: UID 0, LTE (0); Frequency: 1732.5 MHz; Duty Cycle: 1:1
Medium: HSL_1800_160805 Medium parameters used: $f = 1732.5$ MHz; $\sigma = 1.355$ S/m; $\epsilon_r = 41.479$; $\rho = 1000$ kg/m³
Ambient Temperature : 23.4 °C; Liquid Temperature : 22.7 °C

DASY5 Configuration:

- Probe: EX3DV4 - SN3578; ConvF(8.35, 8.35, 8.35); Calibrated: 2016.05.11;
- Sensor-Surface: 2mm (Mechanical Surface Detection)
- Electronics: DAE4 Sn914; Calibrated: 2016.01.07
- Phantom: SAM1; Type: QD000P40CD; Serial: TP:1670
- Measurement SW: DASY52, Version 52.8 (8); SEMCAD X Version 14.6.10 (7331)

Ch20175/Area Scan (71x121x1): Interpolated grid: dx=15mm, dy=15mm
Maximum value of SAR (interpolated) = 0.143 W/kg

Ch20175/Zoom Scan (5x5x7)/Cube 0: Measurement grid: dx=8mm, dy=8mm, dz=5mm
Reference Value = 0.6620 V/m; Power Drift = 0.01 dB
Peak SAR (extrapolated) = 0.162 W/kg
SAR(1 g) = 0.115 W/kg; SAR(10 g) = 0.076 W/kg
Maximum value of SAR (measured) = 0.141 W/kg

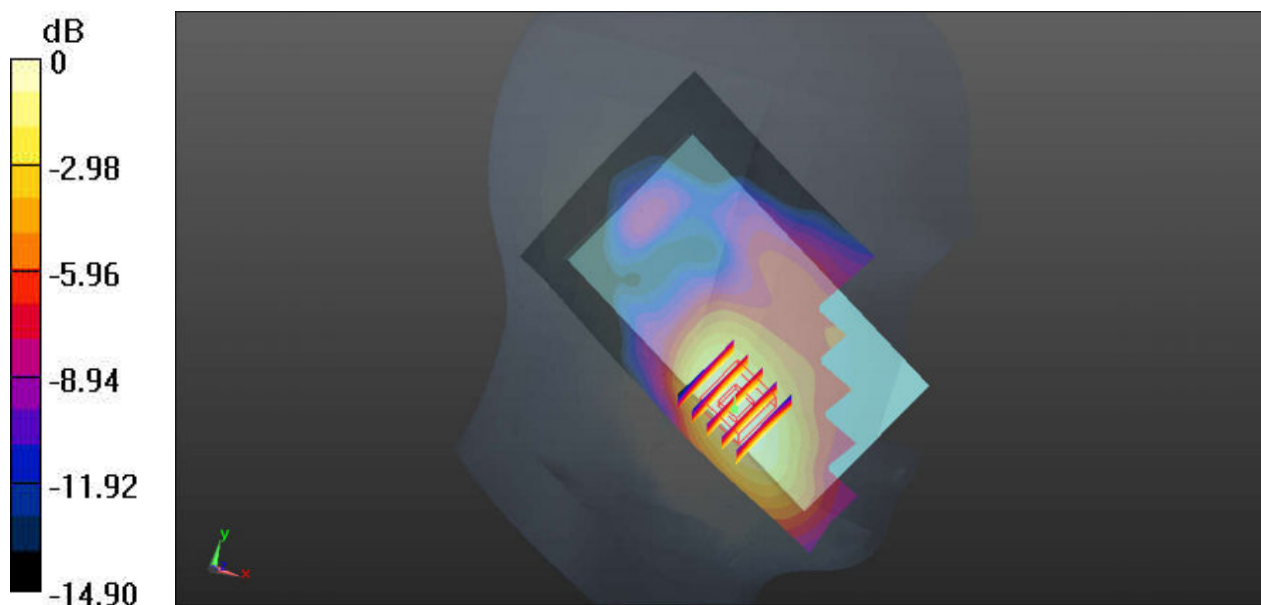

0 dB = 0.141 W/kg

07_LTE Band 2_20M_QPSK_1RB_0Offset_Left Cheek_Ch18900

Communication System: UID 0, LTE (0); Frequency: 1880 MHz; Duty Cycle: 1:1
 Medium: HSL_1900_160805 Medium parameters used: $f = 1880$ MHz; $\sigma = 1.401$ S/m; $\epsilon_r = 41.188$;
 $\rho = 1000$ kg/m³
 Ambient Temperature : 23.4 °C; Liquid Temperature : 22.6 °C

DASY5 Configuration:

- Probe: EX3DV4 - SN3578; ConvF(7.99, 7.99, 7.99); Calibrated: 2016.05.11;
- Sensor-Surface: 2mm (Mechanical Surface Detection)
- Electronics: DAE4 Sn914; Calibrated: 2016.01.07
- Phantom: SAM1; Type: QD000P40CD; Serial: TP:1670
- Measurement SW: DASY52, Version 52.8 (8); SEMCAD X Version 14.6.10 (7331)

Ch18900/Area Scan (71x121x1): Interpolated grid: dx=15mm, dy=15mm
 Maximum value of SAR (interpolated) = 0.131 W/kg

Ch18900/Zoom Scan (5x5x7)/Cube 0: Measurement grid: dx=8mm, dy=8mm, dz=5mm
 Reference Value = 0.7990 V/m; Power Drift = 0.05 dB
 Peak SAR (extrapolated) = 0.150 W/kg
SAR(1 g) = 0.099 W/kg; SAR(10 g) = 0.062 W/kg
 Maximum value of SAR (measured) = 0.125 W/kg

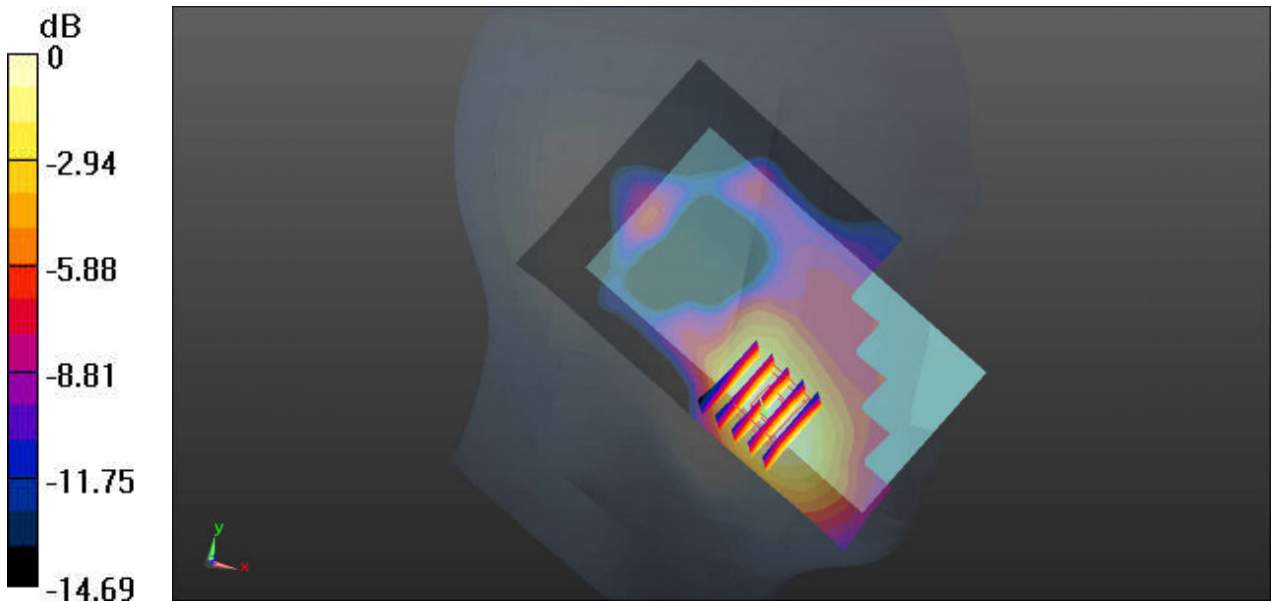

0 dB = 0.125 W/kg

08_LTE Band 7_20M_QPSK_1RB_99Offset_Left Cheek_Ch21350

Communication System: UID 0, LTE (0); Frequency: 2560 MHz; Duty Cycle: 1:1
Medium: HSL_2600_160805 Medium parameters used: $f = 2560$ MHz; $\sigma = 2.003$ S/m; $\epsilon_r = 38.557$;
 $\rho = 1000$ kg/m³
Ambient Temperature : 23.7 °C; Liquid Temperature : 22.5 °C

DASY5 Configuration:

- Probe: EX3DV4 - SN3578; ConvF(7.21, 7.21, 7.21); Calibrated: 2016.05.11;
- Sensor-Surface: 2mm (Mechanical Surface Detection)
- Electronics: DAE4 Sn914; Calibrated: 2016.01.07
- Phantom: SAM1; Type: QD000P40CD; Serial: TP:1670
- Measurement SW: DASY52, Version 52.8 (8); SEMCAD X Version 14.6.10 (7331)

Ch21350/Area Scan (81x141x1): Interpolated grid: dx=12mm, dy=12mm
Maximum value of SAR (interpolated) = 0.0665 W/kg

Ch21350/Zoom Scan (7x7x7)/Cube 0: Measurement grid: dx=5mm, dy=5mm, dz=5mm
Reference Value = 2.623 V/m; Power Drift = -0.02 dB
Peak SAR (extrapolated) = 0.0530 W/kg
SAR(1 g) = 0.029 W/kg; SAR(10 g) = 0.014 W/kg
Maximum value of SAR (measured) = 0.0433 W/kg

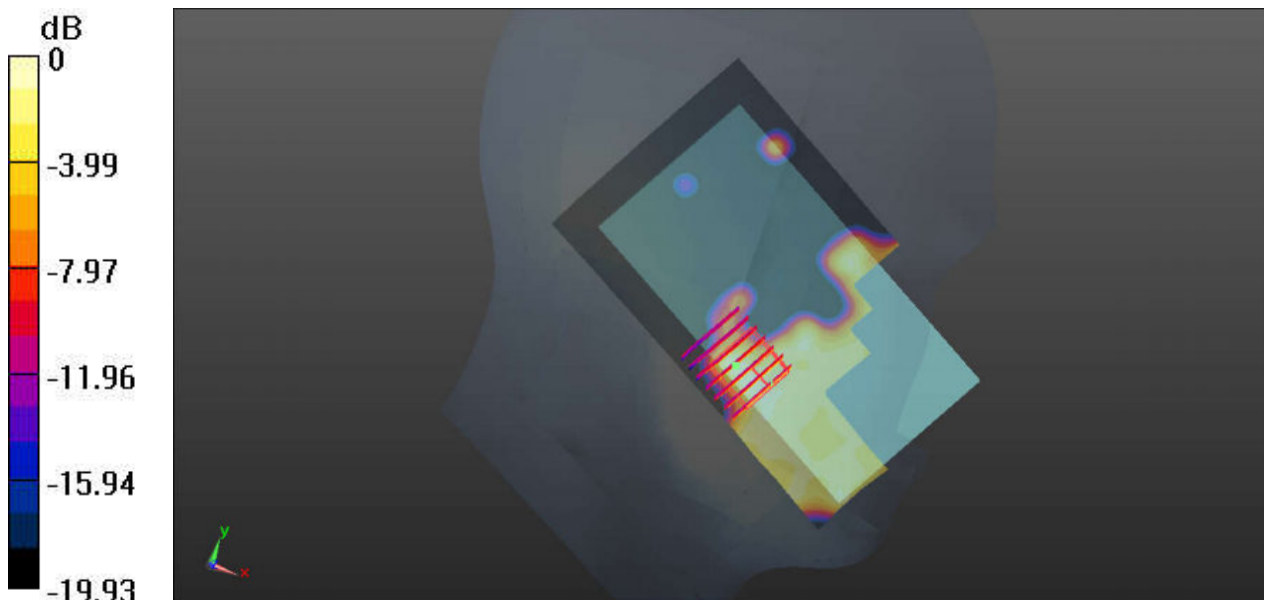

0 dB = 0.0665 W/kg

09_WLAN2.4GHz_802.11b 1Mbps_Right Cheek_Ch11

Communication System: UID 0, WIFI (0); Frequency: 2462 MHz; Duty Cycle: 1:1.018
Medium: HSL_2450_160812 Medium parameters used: $f = 2462$ MHz; $\sigma = 1.761$ S/m; $\epsilon_r = 39.196$;
 $\rho = 1000$ kg/m³
Ambient Temperature : 23.8 °C; Liquid Temperature : 22.5 °C

DASY5 Configuration:

- Probe: EX3DV4 - SN3578; ConvF(7.28, 7.28, 7.28); Calibrated: 2016.05.11;
- Sensor-Surface: 2mm (Mechanical Surface Detection)
- Electronics: DAE4 Sn914; Calibrated: 2016.01.07
- Phantom: SAM1; Type: QD000P40CD; Serial: TP:1670
- Measurement SW: DASY52, Version 52.8 (8); SEMCAD X Version 14.6.10 (7331)

Ch11/Area Scan (81x141x1): Interpolated grid: dx=12mm, dy=12mm
Maximum value of SAR (interpolated) = 0.00599 W/kg

Ch11/Zoom Scan (7x7x7)/Cube 0: Measurement grid: dx=5mm, dy=5mm, dz=5mm
Reference Value = 0 V/m; Power Drift = 0.06 dB
Peak SAR (extrapolated) = 0.00886 W/kg
SAR(1 g) = 0.001114 W/kg; SAR(10 g) = 1.14e-005 W/kg
Maximum value of SAR (measured) = 0.00480 W/kg

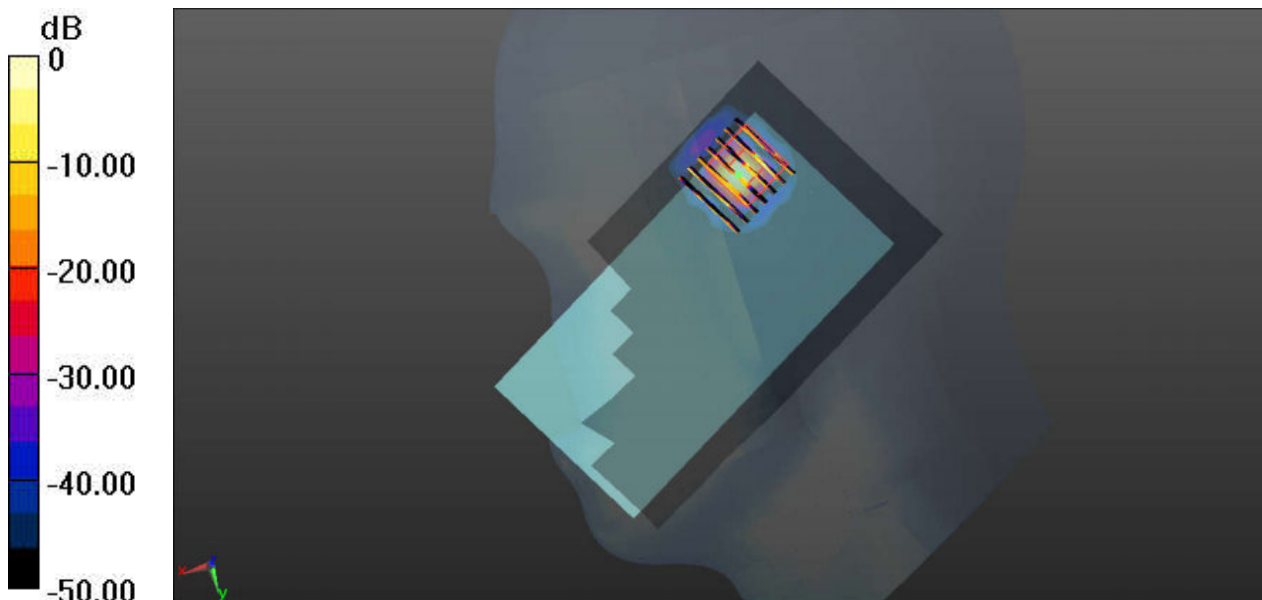

0 dB = 0.00599 W/kg

10_GSM850_GPRS(4 Tx slots)_Front_10mm_Ch128

Communication System: UID 0, GPRS/EDGE12 (0); Frequency: 824.2 MHz; Duty Cycle: 1:2.08
Medium: MSL_835_160802 Medium parameters used: $f = 824.2$ MHz; $\sigma = 1$ S/m; $\epsilon_r = 56.363$; $\rho = 1000$ kg/m³
Ambient Temperature : 23.4 °C; Liquid Temperature : 22.6 °C

DASY5 Configuration:

- Probe: EX3DV4 - SN3578; ConvF(9.53, 9.53, 9.53); Calibrated: 2016.05.11;
- Sensor-Surface: 2mm (Mechanical Surface Detection)
- Electronics: DAE4 Sn914; Calibrated: 2016.01.07
- Phantom: SAM1; Type: QD000P40CD; Serial: TP:1670
- Measurement SW: DASY52, Version 52.8 (8); SEMCAD X Version 14.6.10 (7331)

Ch128/Area Scan (71x121x1): Interpolated grid: dx=15mm, dy=15mm
Maximum value of SAR (interpolated) = 0.509 W/kg

Ch128/Zoom Scan (5x5x7)/Cube 0: Measurement grid: dx=8mm, dy=8mm, dz=5mm
Reference Value = 3.541 V/m; Power Drift = -0.01 dB
Peak SAR (extrapolated) = 0.657 W/kg
SAR(1 g) = 0.380 W/kg; SAR(10 g) = 0.225 W/kg
Maximum value of SAR (measured) = 0.519 W/kg

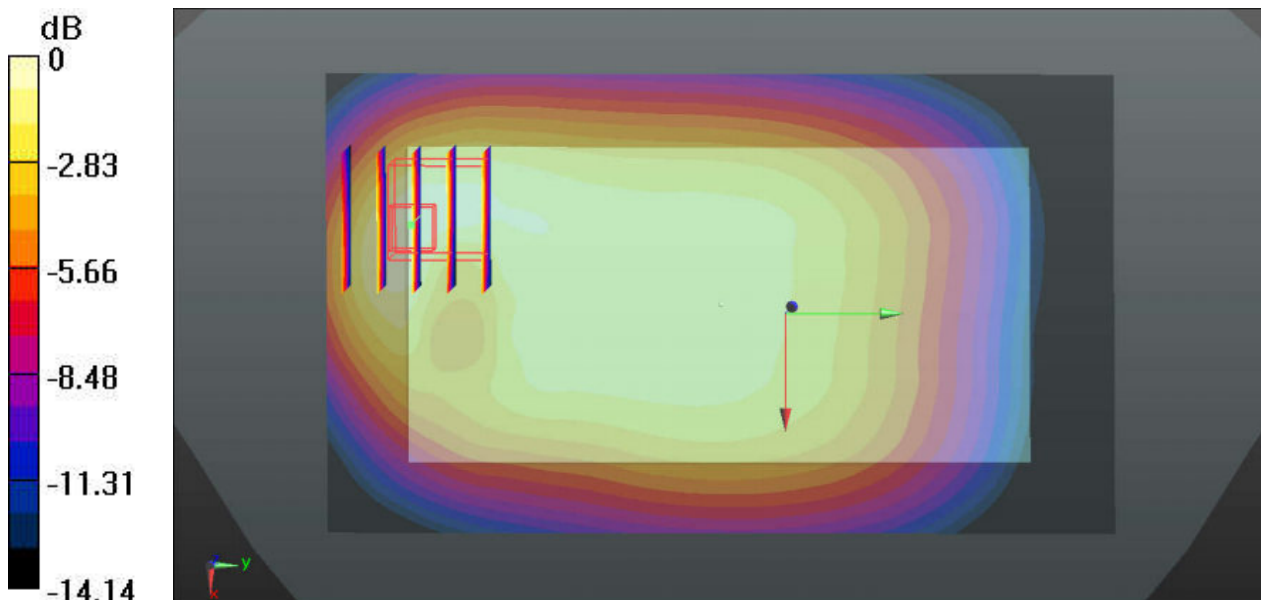

0 dB = 0.519 W/kg

11_GSM1900_GPRS(4 Tx slots)_Bottom Side_10mm_Ch810

Communication System: UID 0, GPRS/EDGE12 (0); Frequency: 1909.8 MHz; Duty Cycle: 1:2.08
Medium: MSL_1900_160803 Medium parameters used: $f = 1909.8$ MHz; $\sigma = 1.515$ S/m; $\epsilon_r = 54.593$; $\rho = 1000$ kg/m³
Ambient Temperature : 23.4 °C ; Liquid Temperature : 22.7 °C

DASY5 Configuration:

- Probe: EX3DV4 - SN3578; ConvF(7.78, 7.78, 7.78); Calibrated: 2016.05.11;
- Sensor-Surface: 2mm (Mechanical Surface Detection)
- Electronics: DAE4 Sn914; Calibrated: 2016.01.07
- Phantom: SAM1; Type: QD000P40CD; Serial: TP:1670
- Measurement SW: DASY52, Version 52.8 (8); SEMCAD X Version 14.6.10 (7331)

Ch810/Area Scan (41x71x1): Interpolated grid: dx=15mm, dy=15mm

Maximum value of SAR (interpolated) = 0.969 W/kg

Ch810/Zoom Scan (5x5x7)/Cube 0: Measurement grid: dx=8mm, dy=8mm, dz=5mm

Reference Value = 3.587 V/m; Power Drift = -0.09 dB

Peak SAR (extrapolated) = 1.12 W/kg

SAR(1 g) = 0.662 W/kg; SAR(10 g) = 0.343 W/kg

Maximum value of SAR (measured) = 0.924 W/kg

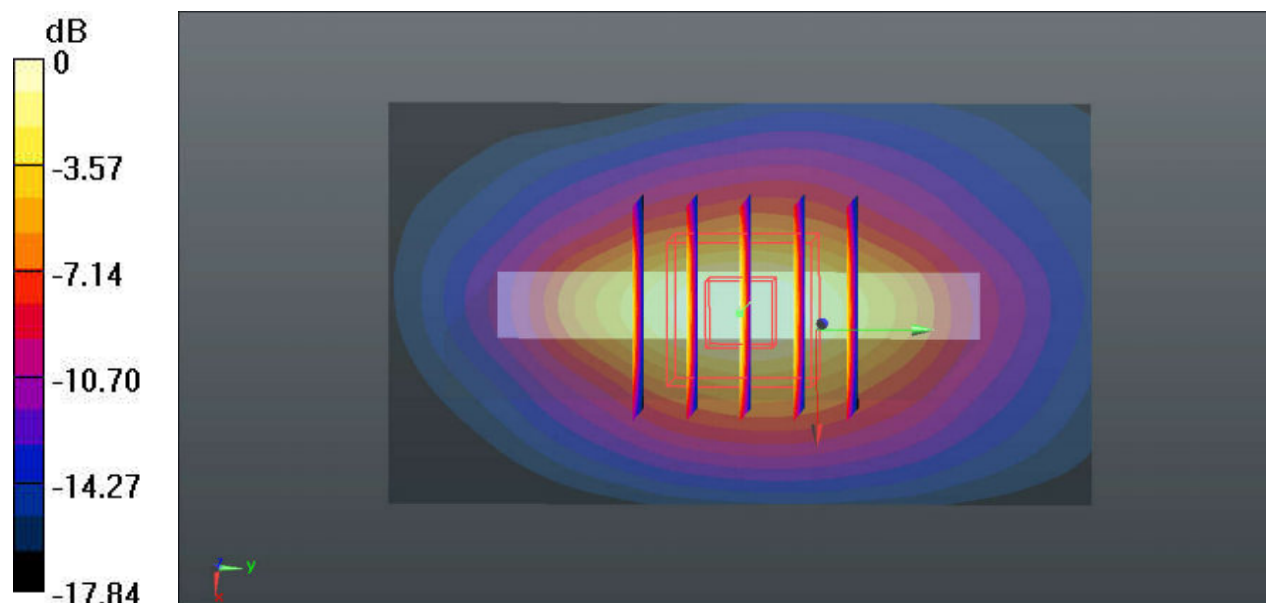

0 dB = 0.924 W/kg

12_WCDMA Band V_RMC 12.2Kbps_Front_10mm_Ch4182

Communication System: UID 0, UMTS (0); Frequency: 836.4 MHz; Duty Cycle: 1:1
Medium: MSL_835_160802 Medium parameters used: $f = 836.4$ MHz; $\sigma = 1.013$ S/m; $\epsilon_r = 56.228$;
 $\rho = 1000$ kg/m³
Ambient Temperature : 23.4 °C; Liquid Temperature : 22.6 °C

DASY5 Configuration:

- Probe: EX3DV4 - SN3578; ConvF(9.53, 9.53, 9.53); Calibrated: 2016.05.11;
- Sensor-Surface: 2mm (Mechanical Surface Detection)
- Electronics: DAE4 Sn914; Calibrated: 2016.01.07
- Phantom: SAM1; Type: QD000P40CD; Serial: TP:1670
- Measurement SW: DASY52, Version 52.8 (8); SEMCAD X Version 14.6.10 (7331)

Ch4182/Area Scan (71x121x1): Interpolated grid: dx=15mm, dy=15mm
Maximum value of SAR (interpolated) = 0.262 W/kg

Ch4182/Zoom Scan (5x5x7)/Cube 0: Measurement grid: dx=8mm, dy=8mm, dz=5mm
Reference Value = 2.623 V/m; Power Drift = -0.06 dB
Peak SAR (extrapolated) = 0.339 W/kg
SAR(1 g) = 0.194 W/kg; SAR(10 g) = 0.112 W/kg
Maximum value of SAR (measured) = 0.265 W/kg

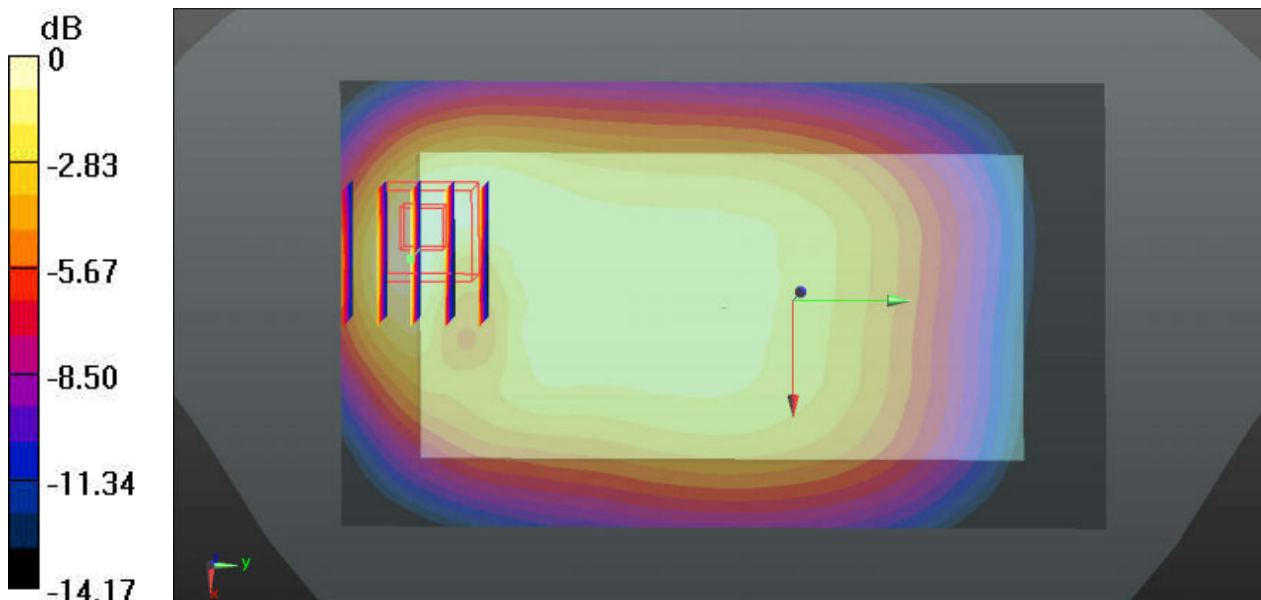

0 dB = 0.265 W/kg

13_WCDMA Band II_RMC 12.2Kbps_Bottom Side_10mm_Ch9400

Communication System: UID 0, UMTS (0); Frequency: 1880 MHz; Duty Cycle: 1:1
Medium: MSL_1900_160803 Medium parameters used: $f = 1880$ MHz; $\sigma = 1.491$ S/m; $\epsilon_r = 54.672$;
 $\rho = 1000$ kg/m³
Ambient Temperature : 23.4 °C; Liquid Temperature : 22.7 °C

DASY5 Configuration:

- Probe: EX3DV4 - SN3578; ConvF(7.78, 7.78, 7.78); Calibrated: 2016.05.11;
- Sensor-Surface: 2mm (Mechanical Surface Detection)
- Electronics: DAE4 Sn914; Calibrated: 2016.01.07
- Phantom: SAM1; Type: QD000P40CD; Serial: TP:1670
- Measurement SW: DASY52, Version 52.8 (8); SEMCAD X Version 14.6.10 (7331)

Ch9400/Area Scan (41x71x1): Interpolated grid: dx=15mm, dy=15mm
Maximum value of SAR (interpolated) = 1.00 W/kg

Ch9400/Zoom Scan (5x5x7)/Cube 0: Measurement grid: dx=8mm, dy=8mm, dz=5mm
Reference Value = 3.659 V/m; Power Drift = 0.05 dB
Peak SAR (extrapolated) = 1.17 W/kg
SAR(1 g) = 0.696 W/kg; SAR(10 g) = 0.362 W/kg
Maximum value of SAR (measured) = 0.971 W/kg

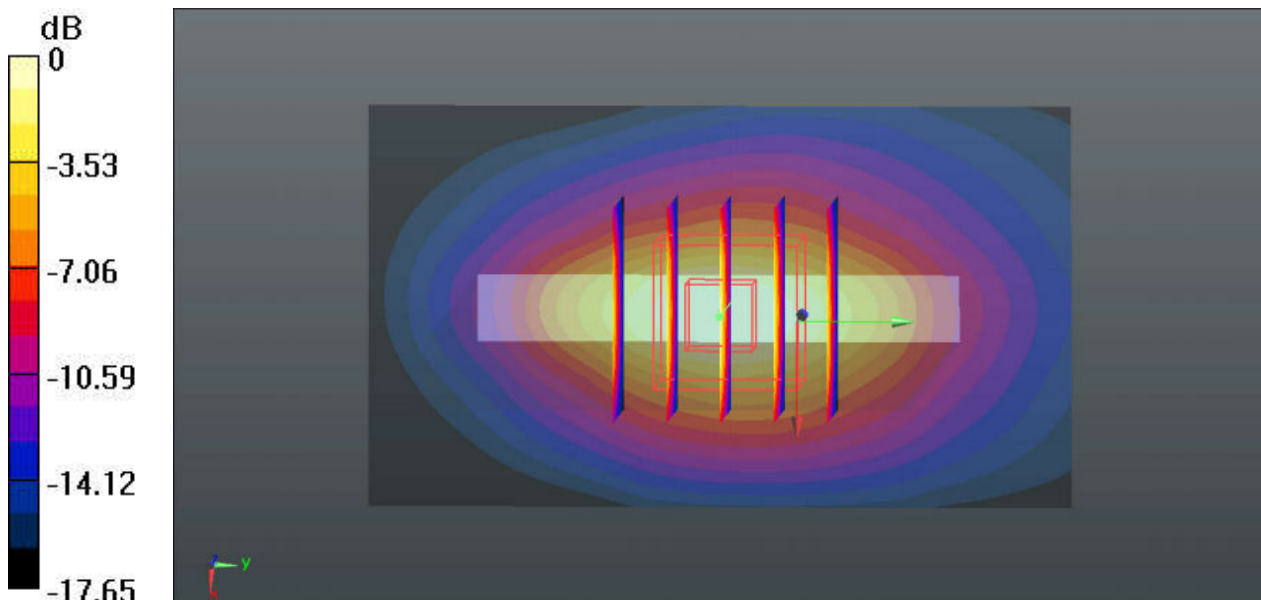

0 dB = 0.971 W/kg

14_LTE Band 28_20M_QPSK_1RB_0Offset_Back_10mm_Ch27410

Communication System: UID 0, LTE (0); Frequency: 723 MHz; Duty Cycle: 1:1
 Medium: MSL_750_160802 Medium parameters used: $f = 723$ MHz; $\sigma = 0.946$ S/m; $\epsilon_r = 54.573$; $\rho = 1000$ kg/m³
 Ambient Temperature : 23.5 °C; Liquid Temperature : 22.6 °C

DASY5 Configuration:

- Probe: EX3DV4 - SN3578; ConvF(9.81, 9.81, 9.81); Calibrated: 2016.05.11;
- Sensor-Surface: 2mm (Mechanical Surface Detection)
- Electronics: DAE4 Sn914; Calibrated: 2016.01.07
- Phantom: SAM1; Type: QD000P40CD; Serial: TP:1670
- Measurement SW: DASY52, Version 52.8 (8); SEMCAD X Version 14.6.10 (7331)

Ch27410/Area Scan (71x121x1): Interpolated grid: dx=15mm, dy=15mm
 Maximum value of SAR (interpolated) = 0.112 W/kg

Ch27410/Zoom Scan (5x5x7)/Cube 0: Measurement grid: dx=8mm, dy=8mm, dz=5mm
 Reference Value = 1.138 V/m; Power Drift = -0.05 dB
 Peak SAR (extrapolated) = 0.135 W/kg
SAR(1 g) = 0.088 W/kg; SAR(10 g) = 0.061 W/kg
 Maximum value of SAR (measured) = 0.110 W/kg

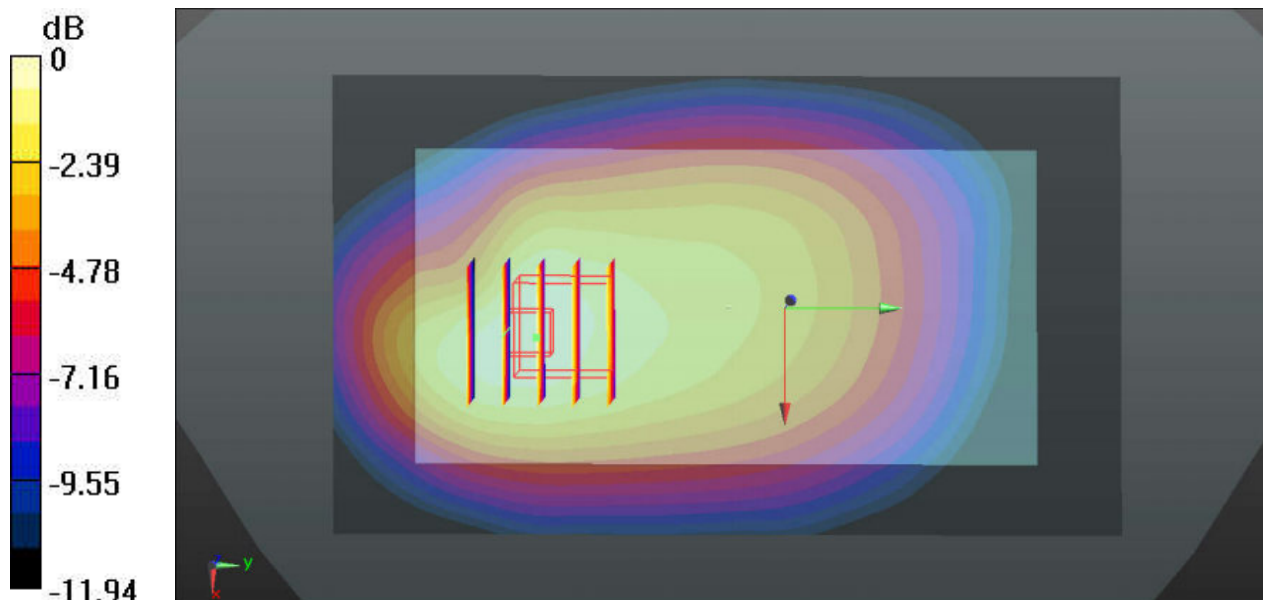

0 dB = 0.110 W/kg

15_LTE Band 4_20M_QPSK_1RB_0Offset_Bottom Side_10mm_Ch20175

Communication System: UID 0, LTE (0); Frequency: 1732.5 MHz; Duty Cycle: 1:1
Medium: MSL_1800_160803 Medium parameters used: $f = 1732.5$ MHz; $\sigma = 1.506$ S/m; $\epsilon_r = 52.091$; $\rho = 1000$ kg/m³
Ambient Temperature : 23.4 °C; Liquid Temperature : 22.8 °C

DASY5 Configuration:

- Probe: EX3DV4 - SN3578; ConvF(8.02, 8.02, 8.02); Calibrated: 2016.05.11;
- Sensor-Surface: 2mm (Mechanical Surface Detection)
- Electronics: DAE4 Sn914; Calibrated: 2016.01.07
- Phantom: SAM1; Type: QD000P40CD; Serial: TP:1670
- Measurement SW: DASY52, Version 52.8 (8); SEMCAD X Version 14.6.10 (7331)

Ch20175/Area Scan (41x71x1): Interpolated grid: dx=15mm, dy=15mm
Maximum value of SAR (interpolated) = 1.19 W/kg

Ch20175/Zoom Scan (5x5x7)/Cube 0: Measurement grid: dx=8mm, dy=8mm, dz=5mm
Reference Value = 3.952 V/m; Power Drift = 0.12 dB
Peak SAR (extrapolated) = 1.37 W/kg
SAR(1 g) = 0.846 W/kg; SAR(10 g) = 0.460 W/kg
Maximum value of SAR (measured) = 1.15 W/kg

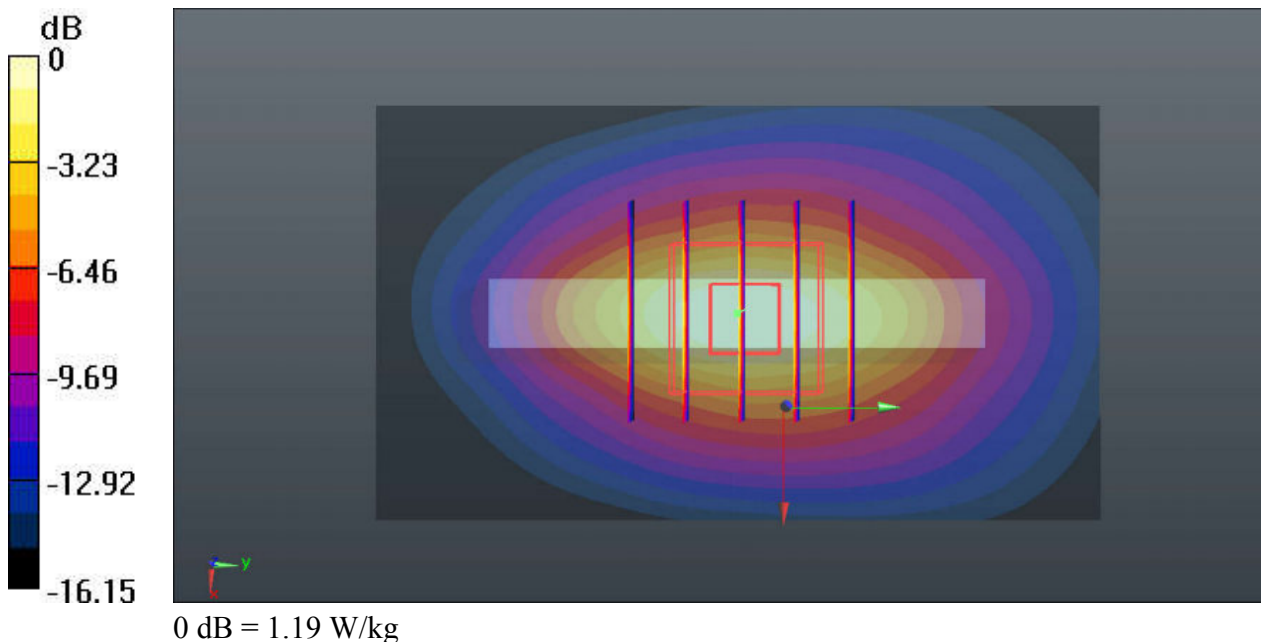

16_LTE Band 2_20M_QPSK_1RB_0Offset_Bottom Side_10mm_Ch18900

Communication System: UID 0, LTE (0); Frequency: 1880 MHz; Duty Cycle: 1:1
Medium: MSL_1900_160803 Medium parameters used: $f = 1880$ MHz; $\sigma = 1.491$ S/m; $\epsilon_r = 54.672$;
 $\rho = 1000$ kg/m³
Ambient Temperature : 23.4 °C; Liquid Temperature : 22.7 °C

DASY5 Configuration:

- Probe: EX3DV4 - SN3578; ConvF(7.78, 7.78, 7.78); Calibrated: 2016.05.11;
- Sensor-Surface: 2mm (Mechanical Surface Detection)
- Electronics: DAE4 Sn914; Calibrated: 2016.01.07
- Phantom: SAM1; Type: QD000P40CD; Serial: TP:1670
- Measurement SW: DASY52, Version 52.8 (8); SEMCAD X Version 14.6.10 (7331)

Ch18900/Area Scan (41x71x1): Interpolated grid: dx=15mm, dy=15mm
Maximum value of SAR (interpolated) = 0.839 W/kg

Ch18900/Zoom Scan (5x5x7)/Cube 0: Measurement grid: dx=8mm, dy=8mm, dz=5mm
Reference Value = 3.493 V/m; Power Drift = -0.02 dB
Peak SAR (extrapolated) = 0.971 W/kg
SAR(1 g) = 0.579 W/kg; SAR(10 g) = 0.302 W/kg
Maximum value of SAR (measured) = 0.806 W/kg

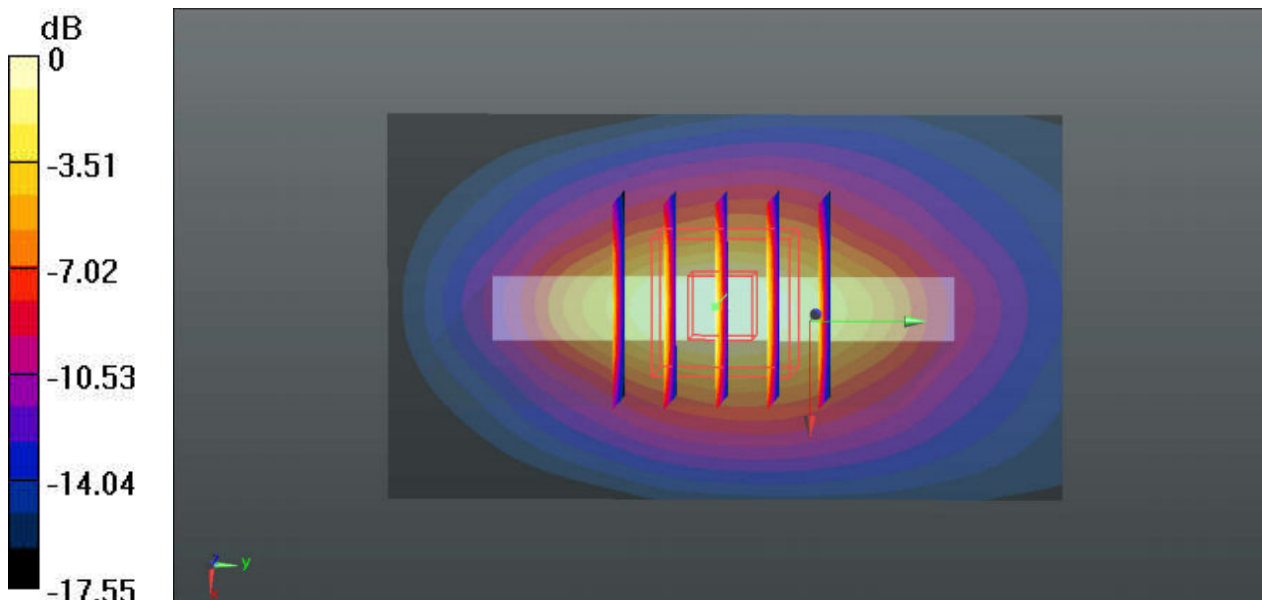

0 dB = 0.806 W/kg

17_LTE Band 7_20M_QPSK_1RB_99Offset_Bottom Side_10mm_Ch21350

Communication System: UID 0, LTE (0); Frequency: 2560 MHz; Duty Cycle: 1:1
Medium: MSL_2600_160804 Medium parameters used: $f = 2560$ MHz; $\sigma = 2.114$ S/m; $\epsilon_r = 53.782$;
 $\rho = 1000$ kg/m³
Ambient Temperature : 23.4 °C; Liquid Temperature : 22.9 °C

DASY5 Configuration:

- Probe: EX3DV4 - SN3578; ConvF(7.17, 7.17, 7.17); Calibrated: 2016.05.11;
- Sensor-Surface: 2mm (Mechanical Surface Detection)
- Electronics: DAE4 Sn914; Calibrated: 2016.01.07
- Phantom: SAM1; Type: QD000P40CD; Serial: TP:1670
- Measurement SW: DASY52, Version 52.8 (8); SEMCAD X Version 14.6.10 (7331)

Ch21350/Area Scan (41x91x1): Interpolated grid: dx=12mm, dy=12mm
Maximum value of SAR (interpolated) = 0.624 W/kg

Ch21350/Zoom Scan (7x7x7)/Cube 0: Measurement grid: dx=5mm, dy=5mm, dz=5mm
Reference Value = 1.491 V/m; Power Drift = -0.05 dB
Peak SAR (extrapolated) = 0.800 W/kg
SAR(1 g) = 0.372 W/kg; SAR(10 g) = 0.167 W/kg
Maximum value of SAR (measured) = 0.572 W/kg

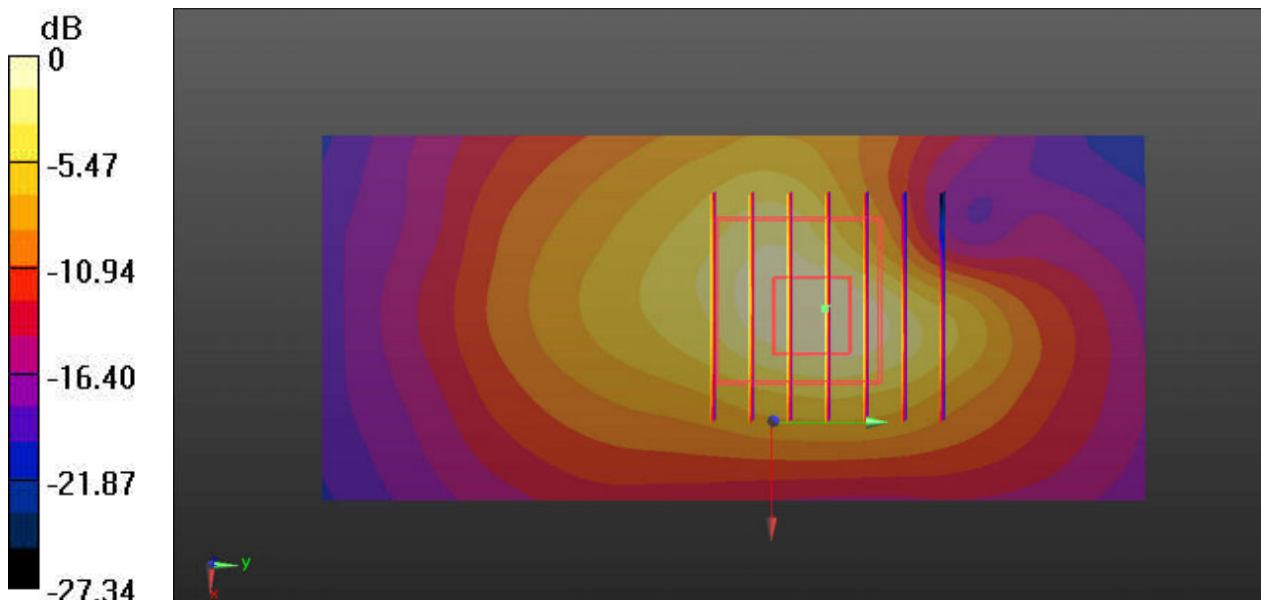

0 dB = 0.624 W/kg

18_WLAN2.4GHz_802.11b 1Mbps_Back_10mm_Ch11

Communication System: UID 0, WIFI (0); Frequency: 2462 MHz; Duty Cycle: 1:1.018
Medium: MSL_2450_160812 Medium parameters used: $f = 2462$ MHz; $\sigma = 1.928$ S/m; $\epsilon_r = 50.903$;
 $\rho = 1000$ kg/m³
Ambient Temperature : 23.8 °C; Liquid Temperature : 22.8 °C

DASY5 Configuration:

- Probe: EX3DV4 - SN3578; ConvF(7.41, 7.41, 7.41); Calibrated: 2016.05.11;
- Sensor-Surface: 2mm (Mechanical Surface Detection)
- Electronics: DAE4 Sn914; Calibrated: 2016.01.07
- Phantom: SAM1; Type: QD000P40CD; Serial: TP:1670
- Measurement SW: DASY52, Version 52.8 (8); SEMCAD X Version 14.6.10 (7331)

Ch11/Area Scan (81x141x1): Interpolated grid: dx=12mm, dy=12mm
Maximum value of SAR (interpolated) = 0.0181 W/kg

Ch11/Zoom Scan (7x7x7)/Cube 0: Measurement grid: dx=5mm, dy=5mm, dz=5mm
Reference Value = 0.3860 V/m; Power Drift = 0.13 dB
Peak SAR (extrapolated) = 0.0420 W/kg
SAR(1 g) = 0.016 W/kg; SAR(10 g) = 0.00507 W/kg
Maximum value of SAR (measured) = 0.0242 W/kg

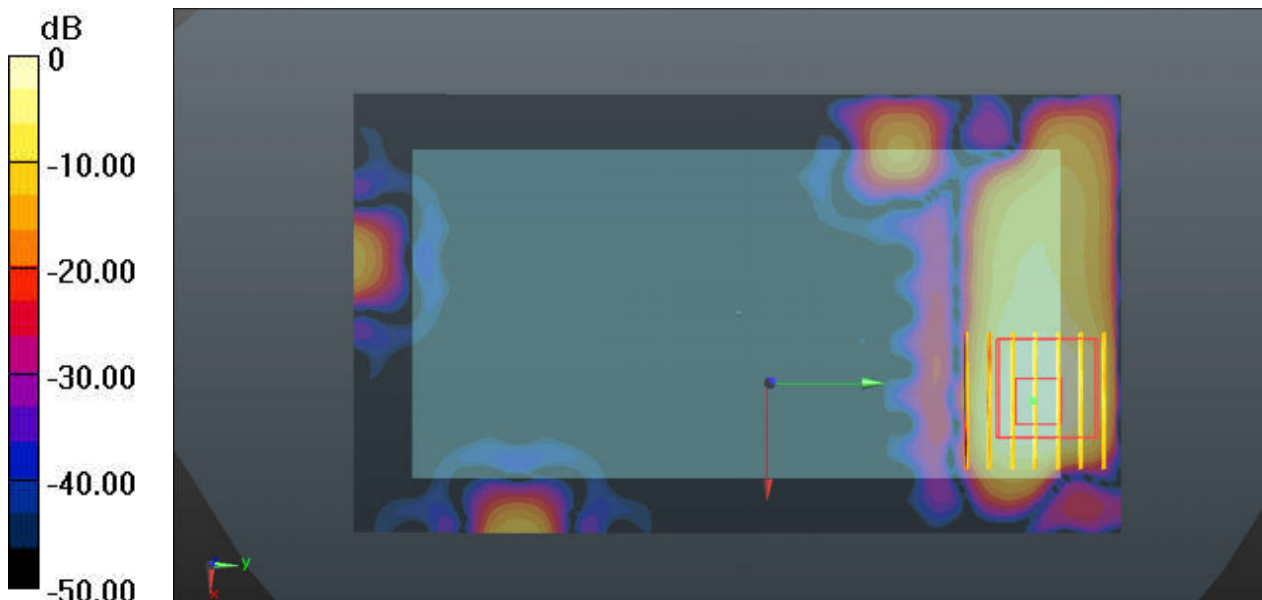

0 dB = 0.0181 W/kg

19_GSM1900_GPRS(4 Tx slots)_Front_10mm_Ch810

Communication System: UID 0, GPRS/EDGE12 (0); Frequency: 1909.8 MHz; Duty Cycle: 1:2.08
Medium: MSL_1900_160803 Medium parameters used: $f = 1910$ MHz; $\sigma = 1.515$ S/m; $\epsilon_r = 54.593$;
 $\rho = 1000$ kg/m³
Ambient Temperature : 23.4 °C; Liquid Temperature : 22.7 °C

DASY5 Configuration:

- Probe: EX3DV4 - SN3578; ConvF(7.78, 7.78, 7.78); Calibrated: 2016.05.11;
- Sensor-Surface: 2mm (Mechanical Surface Detection)
- Electronics: DAE4 Sn914; Calibrated: 2016.01.07
- Phantom: SAM1; Type: QD000P40CD; Serial: TP:1670
- Measurement SW: DASY52, Version 52.8 (8); SEMCAD X Version 14.6.10 (7331)

Ch810/Area Scan (71x121x1): Interpolated grid: dx=15mm, dy=15mm
Maximum value of SAR (interpolated) = 0.561 W/kg

Ch810/Zoom Scan (5x5x7)/Cube 0: Measurement grid: dx=8mm, dy=8mm, dz=5mm
Reference Value = 2.123 V/m; Power Drift = 0.02 dB
Peak SAR (extrapolated) = 0.763 W/kg
SAR(1 g) = 0.466 W/kg; SAR(10 g) = 0.249 W/kg
Maximum value of SAR (measured) = 0.633 W/kg

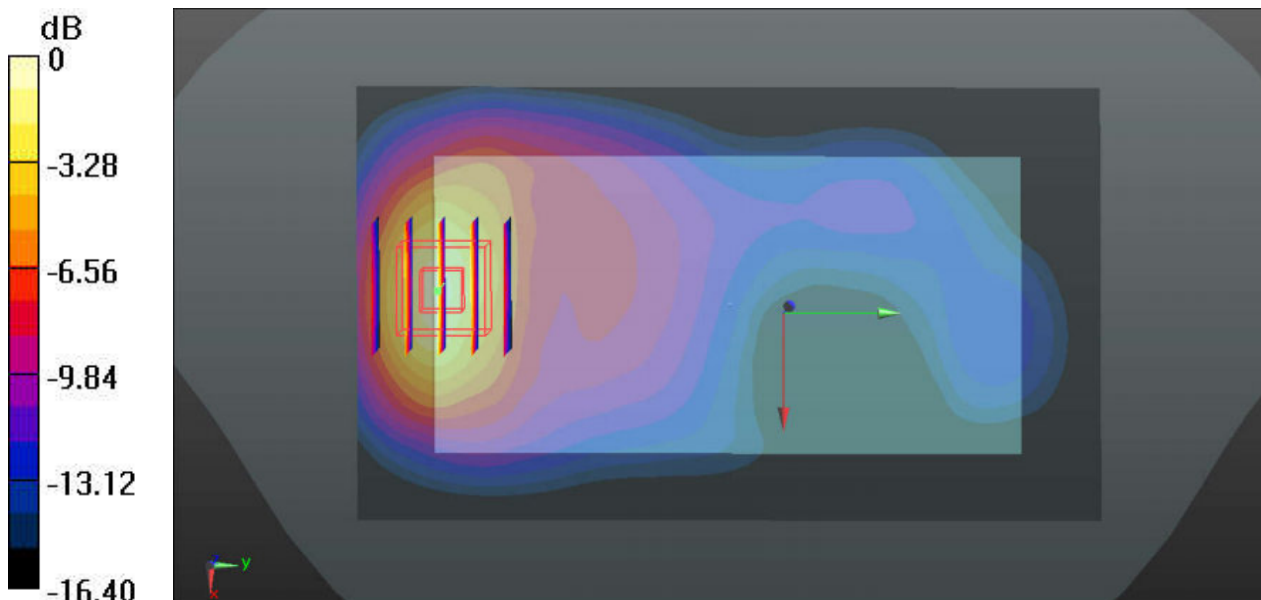

0 dB = 0.633 W/kg

20_WCDMA Band II_RMC 12.2Kbps_Front_10mm_Ch9400

Communication System: UID 0, UMTS (0); Frequency: 1880 MHz; Duty Cycle: 1:1
Medium: MSL_1900_160803 Medium parameters used: $f = 1880$ MHz; $\sigma = 1.491$ S/m; $\epsilon_r = 54.672$;
 $\rho = 1000$ kg/m³
Ambient Temperature : 23.4 °C; Liquid Temperature : 22.7 °C

DASY5 Configuration:

- Probe: EX3DV4 - SN3578; ConvF(7.78, 7.78, 7.78); Calibrated: 2016.05.11;
- Sensor-Surface: 2mm (Mechanical Surface Detection)
- Electronics: DAE4 Sn914; Calibrated: 2016.01.07
- Phantom: SAM1; Type: QD000P40CD; Serial: TP:1670
- Measurement SW: DASY52, Version 52.8 (8); SEMCAD X Version 14.6.10 (7331)

Ch9400/Area Scan (71x121x1): Interpolated grid: dx=15mm, dy=15mm
Maximum value of SAR (interpolated) = 0.582 W/kg

Ch9400/Zoom Scan (5x5x7)/Cube 0: Measurement grid: dx=8mm, dy=8mm, dz=5mm
Reference Value = 2.250 V/m; Power Drift = -0.02 dB
Peak SAR (extrapolated) = 0.788 W/kg
SAR(1 g) = 0.483 W/kg; SAR(10 g) = 0.260 W/kg
Maximum value of SAR (measured) = 0.653 W/kg

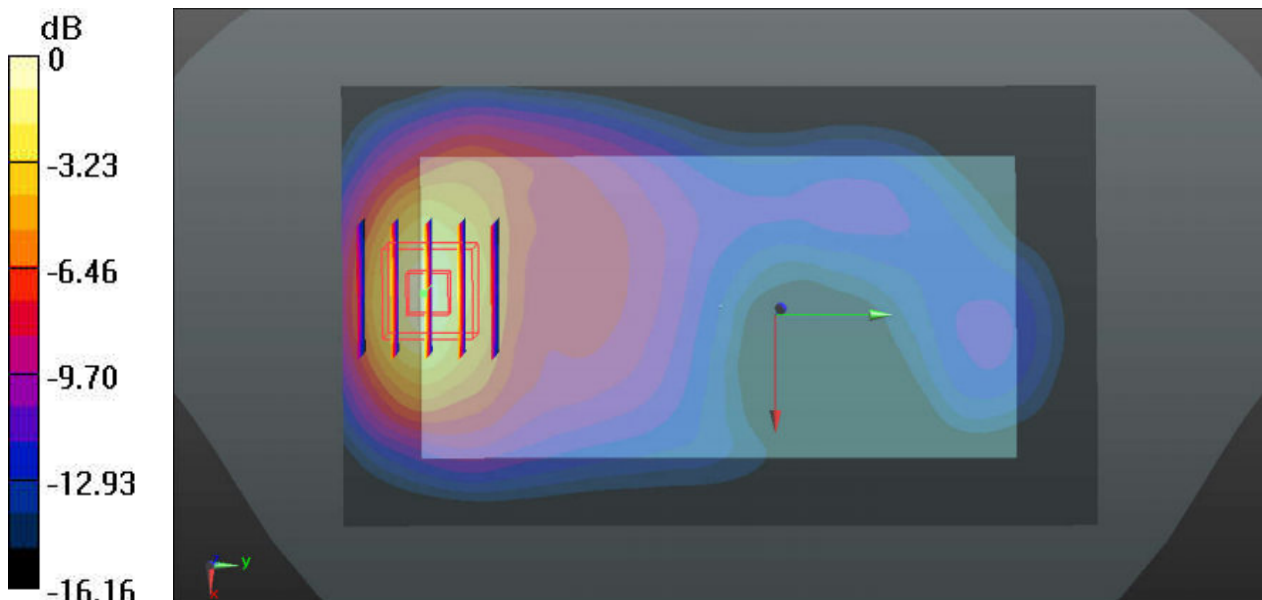

0 dB = 0.653 W/kg

21_LTE Band 4_20M_QPSK_1RB_0Offset_Front_10mm_Ch20175

Communication System: UID 0, LTE (0); Frequency: 1732.5 MHz; Duty Cycle: 1:1
Medium: MSL_1800_160803 Medium parameters used: $f = 1732.5$ MHz; $\sigma = 1.506$ S/m; $\epsilon_r = 52.091$; $\rho = 1000$ kg/m³
Ambient Temperature : 23.4 °C; Liquid Temperature : 22.8 °C

DASY5 Configuration:

- Probe: EX3DV4 - SN3578; ConvF(8.02, 8.02, 8.02); Calibrated: 2016.05.11;
- Sensor-Surface: 2mm (Mechanical Surface Detection)
- Electronics: DAE4 Sn914; Calibrated: 2016.01.07
- Phantom: SAM1; Type: QD000P40CD; Serial: TP:1670
- Measurement SW: DASY52, Version 52.8 (8); SEMCAD X Version 14.6.10 (7331)

Ch20175/Area Scan (71x121x1): Interpolated grid: dx=15mm, dy=15mm
Maximum value of SAR (interpolated) = 0.636 W/kg

Ch20175/Zoom Scan (5x5x7)/Cube 0: Measurement grid: dx=8mm, dy=8mm, dz=5mm
Reference Value = 2.302 V/m; Power Drift = -0.02 dB
Peak SAR (extrapolated) = 0.840 W/kg
SAR(1 g) = 0.534 W/kg; SAR(10 g) = 0.300 W/kg
Maximum value of SAR (measured) = 0.706 W/kg

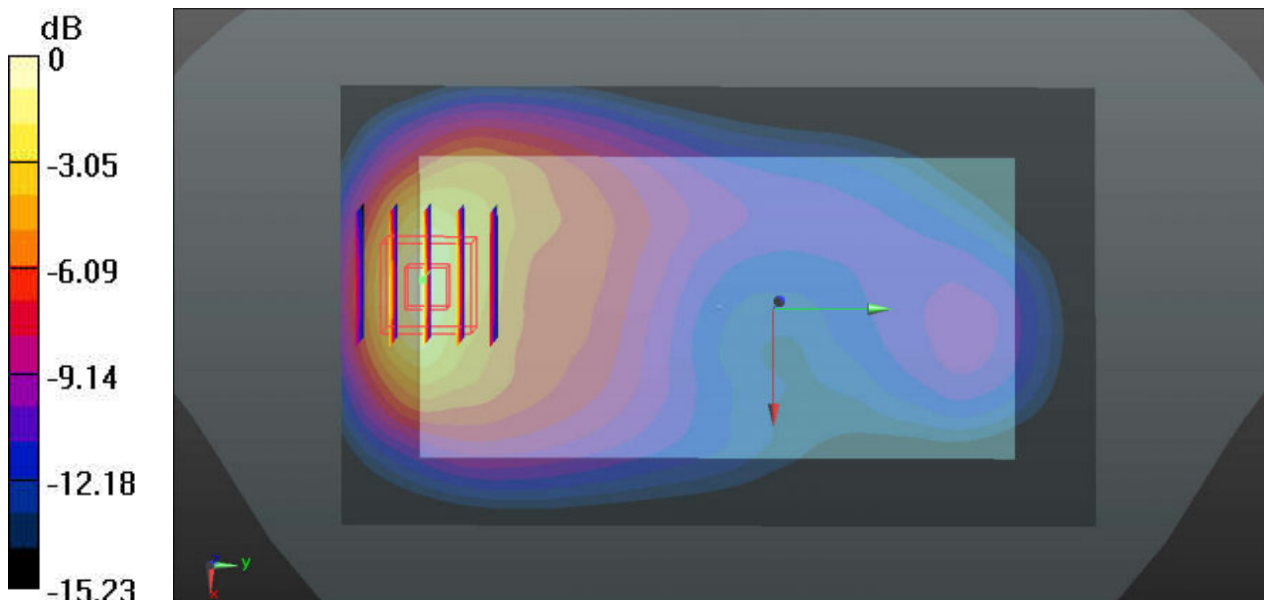

0 dB = 0.706 W/kg