

FCC Test Report

APPLICANT : Brightstar Corporation
EQUIPMENT : GSM Mobile Phone
BRAND NAME : Avvio
MODEL NAME : Avvio 938
FCC ID : WVBA938X
STANDARD : FCC 47 CFR FCC Part 15 Subpart B
CLASSIFICATION : Certification

The product was received on Jan. 07, 2014 and testing was completed on Feb. 18, 2014. We, SPORTON INTERNATIONAL (SHENZHEN) INC., would like to declare that the tested sample has been evaluated in accordance with the procedures given in ANSI C63.4-2003 and shown to be compliant with the applicable technical standards.

The test results in this report apply exclusively to the tested model / sample. Without written approval of SPORTON INTERNATIONAL (SHENZHEN) INC., the test report shall not be reproduced except in full.

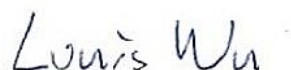

Reviewed by: Louis Wu / Manager

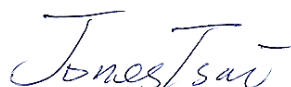

Approved by: Jones Tsai / Manager



SPORTON INTERNATIONAL (SHENZHEN) INC.

No. 3 Building, the third floor of south, Shahe River west, Fengzeyuan warehouse, Nanshan District, Shenzhen, Guangdong, P.R.C.



TABLE OF CONTENTS

REVISION HISTORY..... 3

SUMMARY OF TEST RESULT 4

1. GENERAL DESCRIPTION 5

 1.1. Applicant..... 5

 1.2. Manufacturer 5

 1.3. Feature of Equipment Under Test..... 5

 1.4. Product Specification of Equipment Under Test 5

 1.5. Modification of EUT 6

 1.6. Test Site 6

 1.7. Applied Standards 6

2. TEST CONFIGURATION OF EQUIPMENT UNDER TEST 7

 2.1. Test Mode 7

 2.2. Connection Diagram of Test System 9

 2.3. Support Unit used in test configuration and system..... 10

 2.4. EUT Operation Test Setup 10

3. TEST RESULT 11

 3.1. Test of AC Conducted Emission Measurement 11

 3.2. Test of Radiated Emission Measurement 19

4. LIST OF MEASURING EQUIPMENT 23

5. UNCERTAINTY OF EVALUATION 24

APPENDIX A. SETUP PHOTOGRAPHS



SUMMARY OF TEST RESULT

Report Section	FCC Rule	Description	Limit	Result	Remark
3.1	15.107	AC Conducted Emission	< 15.107 limits	PASS	Under limit 1.54 dB at 2.62 MHz
3.2	15.109	Radiated Emission	< 15.109 limits	PASS	Under limit 3.05 dB at 497.540 MHz for Quasi-Peak

1. General Description

1.1. Applicant

Brightstar Corporation

9725 NW 117th Ave., Miami, Florida, FL 33178, United States

1.2. Manufacturer

Lakia Networks Co., Ltd.

2F, Unit A, Technology Service Building, Software Garden 1, Xiamen, Fujian, China

1.3. Feature of Equipment Under Test

Product Feature	
Equipment	GSM Mobile Phone
Brand Name	Avvio
Model Name	Avvio 938
FCC ID	WVBA938X
EUT supports Radios application	GSM/Bluetooth v3.0+EDR
EUT Stage	Identical Prototype

Remark: The above EUT's information was declared by manufacturer. Please refer to the specifications or user's manual for more detailed description.

1.4. Product Specification of Equipment Under Test

Product Specification subjective to this standard	
Tx Frequency	GSM850 : 824.2 MHz ~ 848.8 MHz GSM1900 : 1850.2 MHz ~ 1909.8MHz Bluetooth: 2402 MHz ~ 2480 MHz
Rx Frequency	GSM850 : 869.2 MHz ~ 893.8 MHz GSM1900 : 1930.2 MHz ~ 1989.8 MHz Bluetooth: 2402 MHz ~ 2480 MHz
Antenna Type	WWAN : PIFA Antenna Bluetooth : FPC Antenna
Type of Modulation	GSM: GMSK Bluetooth v3.0+EDR : GFSK, $\pi/4$ -DQPSK, 8-DPSK

1.5. Modification of EUT

No modifications are made to the EUT during all test items.

1.6. Test Site

Test Site	SPORTON INTERNATIONAL (SHENZHEN) INC.		
Test Site Location	No. 3 Building, the third floor of south, Shahe River west, Fengzeyuan warehouse, Nanshan District, Shenzhen, Guangdong, P.R.C. TEL: +86-755- 3320-2398		
Test Site No.	Sporton Site No.		FCC Registration No.
	CO01-SZ	03CH01-SZ	831040

1.7. Applied Standards

According to the specifications of the manufacturer, the EUT must comply with the requirements of the following standards:

- ♦ FCC 47 CFR FCC Part 15 Subpart B
- ♦ ANSI C63.4-2003

Remark: All test items were verified and recorded according to the standards and without any deviation during the test.

2. Test Configuration of Equipment Under Test

2.1. Test Mode

The EUT has been associated with peripherals pursuant to ANSI C63.4-2003 and configuration operated in a manner tended to maximize its emission characteristics in a typical application.

Frequency range investigated: conduction (150 kHz to 30 MHz), radiation (30MHz to the 5th harmonic of the highest fundamental frequency or to 40 GHz, whichever is lower).

The following tables are showing the test modes as the worst cases and recorded in this report.

Item	EUT Configuration	Test Condition		
		EMI AC	EMI RE<1G	EMI RE≥1G
1.	Charging Mode (EUT with adapter)	☒	☒	Note 1
2.	Data application transferred mode (EUT connected with notebook)	☒	☒	☒

Abbreviations:

- EMI AC: AC conducted emissions
- EMI RE ≥ 1G: EUT radiated emissions ≥ 1GHz
- EMI RE < 1G: EUT radiated emissions < 1GHz

Note 1: Testing for this mode is not required or not the worst case.

Remark: For signal above 1GHz, the worst case was test item 2.

Test Items	EUT Configure Mode	Function Type
AC Conducted Emission	1/2	Mode 1: GSM850 Idle + Bluetooth Idle + USB Cable (Charging from Adapter) + Earphone + Camera + SIM1 <Fig. 1> Mode 2: GSM1900 Idle + Bluetooth Idle + USB Cable (Charging from Adapter) + Earphone + MPEG4 + SIM1 <Fig. 1> Mode 3: GSM850 Idle + Bluetooth Idle + USB Cable (Data Link with Notebook) + Earphone + SIM1 <Fig. 2>
Radiated Emissions < 1GHz	1/2	Mode 1: GSM850 Idle + Bluetooth Idle + USB Cable (Charging from Adapter) + Earphone + Camera + SIM1 <Fig. 1> Mode 2: GSM1900 Idle + Bluetooth Idle + USB Cable (Charging from Adapter) + Earphone + MPEG4 + SIM1 <Fig. 1> Mode 3: GSM850 Idle + Bluetooth Idle + USB Cable (Data Link with Notebook) + Earphone + SIM1 <Fig. 2>
Radiated Emissions ≥ 1GHz	2	Mode 1: GSM850 Idle + Bluetooth Idle + USB Cable (Data Link with Notebook) + Earphone + SIM1 <Fig. 2>
Remark: <ol style="list-style-type: none"> The worst case of AC is mode 1, and the USB Link mode of AC is mode 3, the test data of these modes are reported. The worst case of RE < 1G is mode 3; only the test data of this mode is reported. Link with Notebook means data application transferred mode between EUT and Notebook. 		

2.2. Connection Diagram of Test System

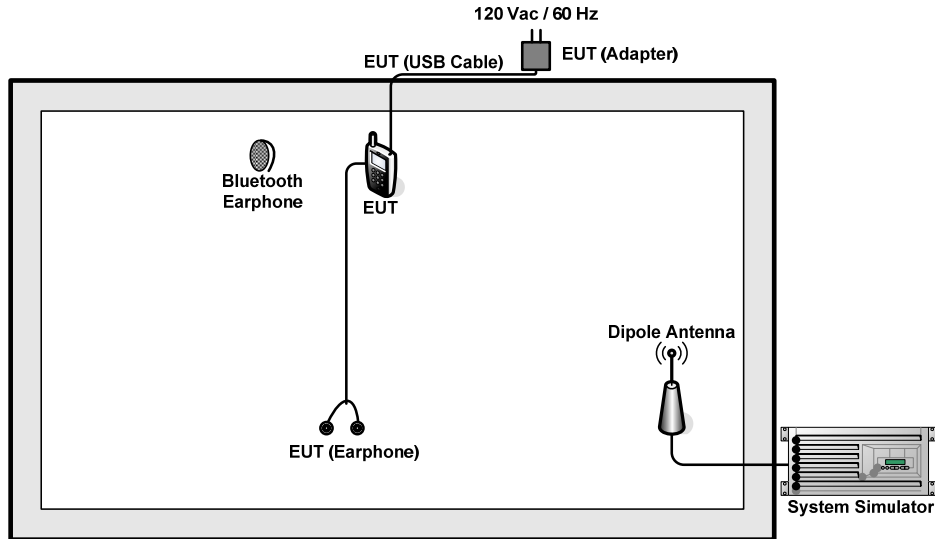

<Fig. 1>

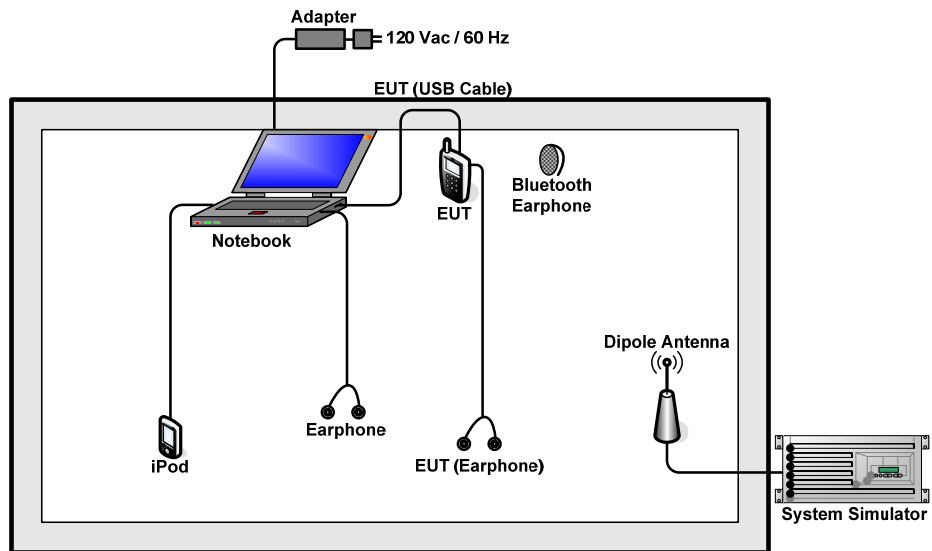

<Fig. 2>

2.3. Support Unit used in test configuration and system

Item	Equipment	Trade Name	Model Name	FCC ID	Data Cable	Power Cord
1.	System Simulator	R&S	CMW 500	N/A	N/A	Unshielded, 1.8 m
2.	WLAN AP	D-link	DIR-815	KA2IR815A1	N/A	Unshielded, 1.8m
3.	Bluetooth Earphone	Nokia	BH-108	PYAHS-107W	N/A	N/A
4.	Notebook	Lenovo	G480	FCC DoC	N/A	AC I/P: Unshielded, 1.2 m DC O/P: Shielded, 1.8 m
5.	iPod	Apple	MC525 ZP/A	FCC DoC	Shielded, 1.2 m	N/A
6.	SD Card	SanDisk	4G class 4	FCC DoC	N/A	N/A
7.	Earphone	Eimuse	E-500MV	FCC DoC	Shielded, 2.2 m	N/A

2.4. EUT Operation Test Setup

The EUT was in GSM idle mode during the testing. The EUT was synchronized to the BCCH, and was in continuous receiving mode by setting system simulator's paging reorganization.

At the same time, the EUT was attached to the Bluetooth earphone or WLAN AP, and the following programs installed in the EUT were programmed during the test.

1. Execute the program, "Winthrax" under WIN7 installed in notebook for files transfer with EUT via USB cable.
2. Execute "Video Player" to play MPEG4 files.
3. Turn on camera to capture images.

3. Test Result

3.1. Test of AC Conducted Emission Measurement

3.1.1 Limits of AC Conducted Emission

For equipment that is designed to be connected to the public utility (AC) power line, the radio frequency voltage that is conducted back onto the AC power line on any frequency or frequencies within the band 150 kHz to 30 MHz shall not exceed the limits in the following table.

Frequency of emission (MHz)	Conducted limit (dBuV)	
	Quasi-peak	Average
0.15-0.5	66 to 56*	56 to 46*
0.5-5	56	46
5-30	60	50

*Decreases with the logarithm of the frequency.

3.1.2 Measuring Instruments

The measuring equipment is listed in the section 4 of this test report.

3.1.3 Test Procedure

1. The EUT was placed 0.4 meter from the conducting wall of the shielding room was kept at least 80 centimeters from any other grounded conducting surface.
2. Connect EUT to the power mains through a line impedance stabilization network (LISN).
3. All the support units are connecting to the other LISN.
4. The LISN provides 50 ohm coupling impedance for the measuring instrument.
5. The FCC states that a 50 ohm, 50 microhenry LISN should be used.
6. Both sides of AC line were checked for maximum conducted interference.
7. The frequency range from 150 kHz to 30 MHz was searched.
8. Set the test-receiver system to Peak Detect Function and specified bandwidth with Maximum Hold Mode.

3.1.4 Test Setup

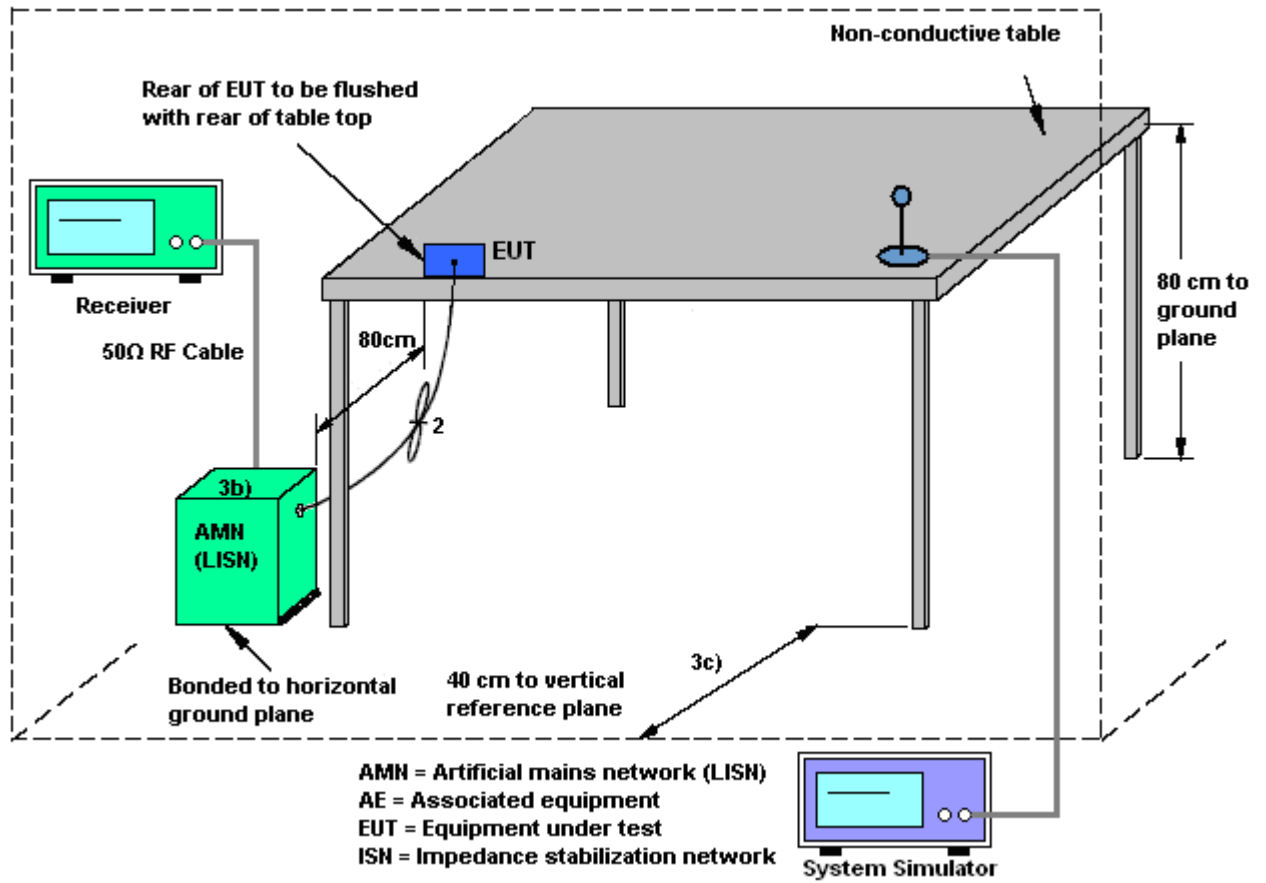



3.1.5 Test Result of AC Conducted Emission

Test Mode :	Mode 1	Temperature :	21~22°C
Test Engineer :	Henry Chen	Relative Humidity :	41~42%
Test Voltage :	120Vac / 60Hz	Phase :	Line
Function Type :	GSM850 Idle + Bluetooth Idle + USB Cable (Charging from Adapter) + Earphone + Camera + SIM1		

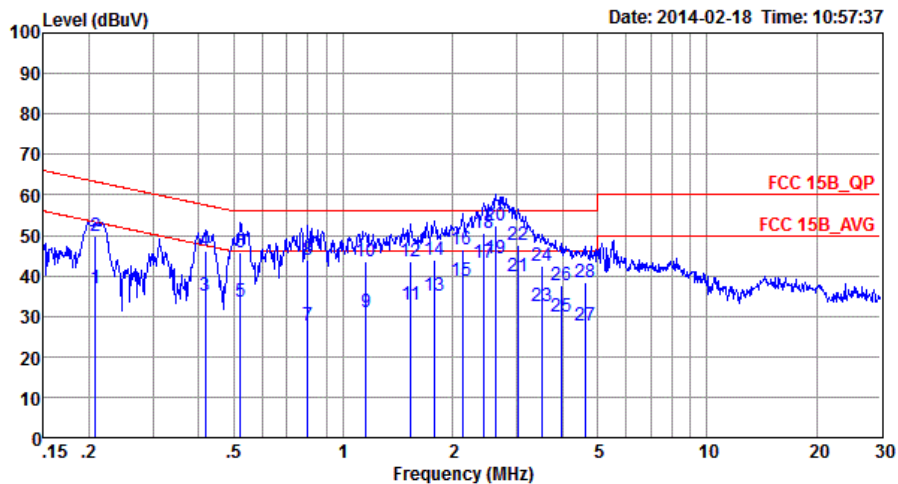

Site : CO01-SZ
 Condition: FCC 15B_QP LISN_L_20130328 LINE
 Project : (FC) 410704

	Freq	Level	Over Limit	Limit Line	Read Level	LISN Factor	Cable Loss	Remark
	MHz	dBuV	dB	dBuV	dBuV	dB	dB	
1	0.21	37.06	-16.21	53.27	26.71	0.07	10.28	Average
2	0.21	49.86	-13.41	63.27	39.51	0.07	10.28	QP
3	0.42	35.09	-12.42	47.51	24.79	0.13	10.17	Average
4	0.42	45.99	-11.52	57.51	35.69	0.13	10.17	QP
5	0.52	33.40	-12.60	46.00	23.11	0.14	10.15	Average
6	0.52	45.80	-10.20	56.00	35.51	0.14	10.15	QP
7	0.80	27.52	-18.48	46.00	17.20	0.17	10.15	Average
8	0.80	43.92	-12.08	56.00	33.60	0.17	10.15	QP
9	1.15	30.96	-15.04	46.00	20.59	0.21	10.16	Average
10	1.15	43.46	-12.54	56.00	33.09	0.21	10.16	QP
11	1.54	32.69	-13.31	46.00	22.30	0.22	10.17	Average
12	1.54	43.49	-12.51	56.00	33.10	0.22	10.17	QP
13	1.78	35.11	-10.89	46.00	24.70	0.23	10.18	Average
14	1.78	43.91	-12.09	56.00	33.50	0.23	10.18	QP
15	2.12	38.73	-7.27	46.00	28.31	0.23	10.19	Average
16	2.12	46.63	-9.37	56.00	36.21	0.23	10.19	QP
17	2.43	43.25	-2.75	46.00	32.80	0.25	10.20	Average
18	2.43	50.45	-5.55	56.00	40.00	0.25	10.20	QP
19 *	2.62	44.46	-1.54	46.00	34.01	0.25	10.20	Average
20	2.62	52.26	-3.74	56.00	41.81	0.25	10.20	QP



Test Mode :	Mode 1	Temperature :	21~22°C
Test Engineer :	Henry Chen	Relative Humidity :	41~42%
Test Voltage :	120Vac / 60Hz	Phase :	Line
Function Type :	GSM850 Idle + Bluetooth Idle + USB Cable (Charging from Adapter) + Earphone + Camera + SIM1		

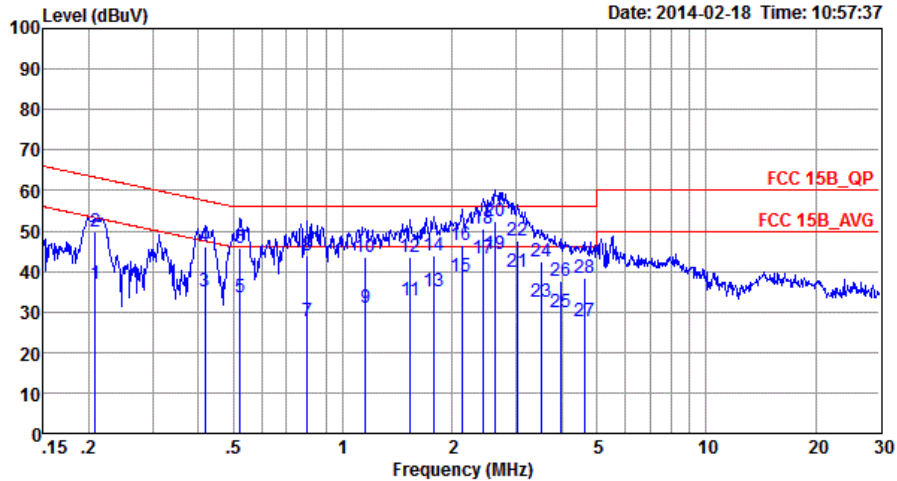

Site : CO01-SZ
 Condition: FCC 15B_QP LISN_L_20130328 LINE
 Project : (FC)410704

	Freq	Level	Over Limit	Limit Line	Read Level	LISN Factor	Cable Loss	Remark
	MHz	dBuV	dB	dBuV	dBuV	dB	dB	
21	3.03	39.68	-6.32	46.00	29.20	0.27	10.21	Average
22	3.03	47.78	-8.22	56.00	37.30	0.27	10.21	QP
23	3.53	32.60	-13.40	46.00	22.10	0.28	10.22	Average
24	3.53	42.50	-13.50	56.00	32.00	0.28	10.22	QP
25	3.96	29.72	-16.28	46.00	19.20	0.29	10.23	Average
26	3.96	37.72	-18.28	56.00	27.20	0.29	10.23	QP
27	4.65	27.54	-18.46	46.00	17.00	0.30	10.24	Average
28	4.65	38.24	-17.76	56.00	27.70	0.30	10.24	QP



Test Mode :	Mode 1	Temperature :	21~22°C
Test Engineer :	Henry Chen	Relative Humidity :	41~42%
Test Voltage :	120Vac / 60Hz	Phase :	Neutral
Function Type :	GSM850 Idle + Bluetooth Idle + USB Cable (Charging from Adapter) + Earphone + Camera + SIM1		

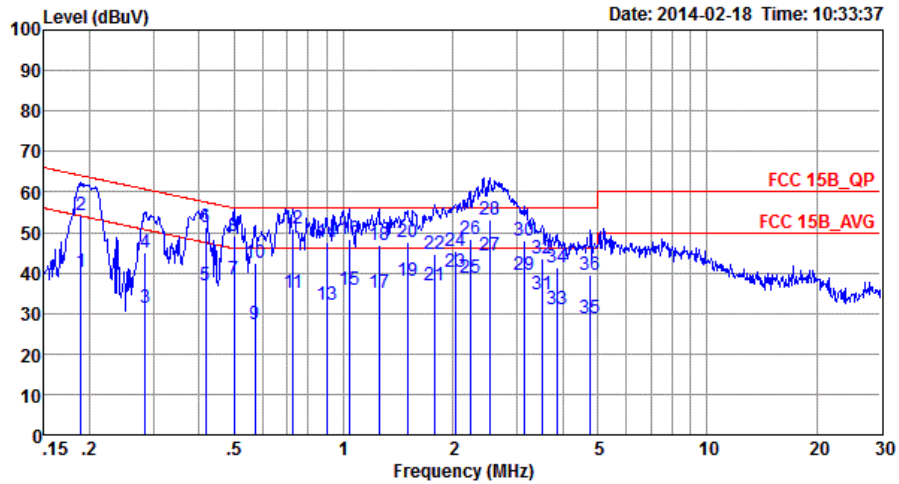

Site : CO01-SZ
 Condition: FCC 15B_QP LISN_N_20130328 NEUTRAL
 Project : (FC)410704

	Freq	Level	Over Limit	Limit Line	Read Level	LISN Factor	Cable Loss	Remark
	MHz	dBuV	dB	dBuV	dBuV	dB	dB	
1	0.19	40.05	-14.01	54.06	29.70	0.04	10.31	Average
2	0.19	54.35	-9.71	64.06	44.00	0.04	10.31	QP
3	0.28	31.25	-19.43	50.68	21.00	0.04	10.21	Average
4	0.28	45.05	-15.63	60.68	34.80	0.04	10.21	QP
5	0.42	36.81	-10.70	47.51	26.60	0.04	10.17	Average
6	0.42	51.31	-6.20	57.51	41.10	0.04	10.17	QP
7	0.50	38.50	-7.51	46.01	28.30	0.04	10.16	Average
8	0.50	49.20	-6.81	56.01	39.00	0.04	10.16	QP
9	0.57	27.19	-18.81	46.00	17.00	0.04	10.15	Average
10	0.57	42.59	-13.41	56.00	32.40	0.04	10.15	QP
11	0.73	35.19	-10.81	46.00	25.00	0.04	10.15	Average
12	0.73	50.99	-5.01	56.00	40.80	0.04	10.15	QP
13	0.90	32.19	-13.81	46.00	22.00	0.04	10.15	Average
14	0.90	47.59	-8.41	56.00	37.40	0.04	10.15	QP
15	1.04	35.79	-10.21	46.00	25.60	0.04	10.15	Average
16	1.04	48.49	-7.51	56.00	38.30	0.04	10.15	QP
17	1.25	35.01	-10.99	46.00	24.80	0.05	10.16	Average
18	1.25	46.71	-9.29	56.00	36.50	0.05	10.16	QP
19	1.50	37.82	-8.18	46.00	27.60	0.05	10.17	Average
20	1.50	47.42	-8.58	56.00	37.20	0.05	10.17	QP



Test Mode :	Mode 1	Temperature :	21~22°C
Test Engineer :	Henry Chen	Relative Humidity :	41~42%
Test Voltage :	120Vac / 60Hz	Phase :	Neutral
Function Type :	GSM850 Idle + Bluetooth Idle + USB Cable (Charging from Adapter) + Earphone + Camera + SIM1		

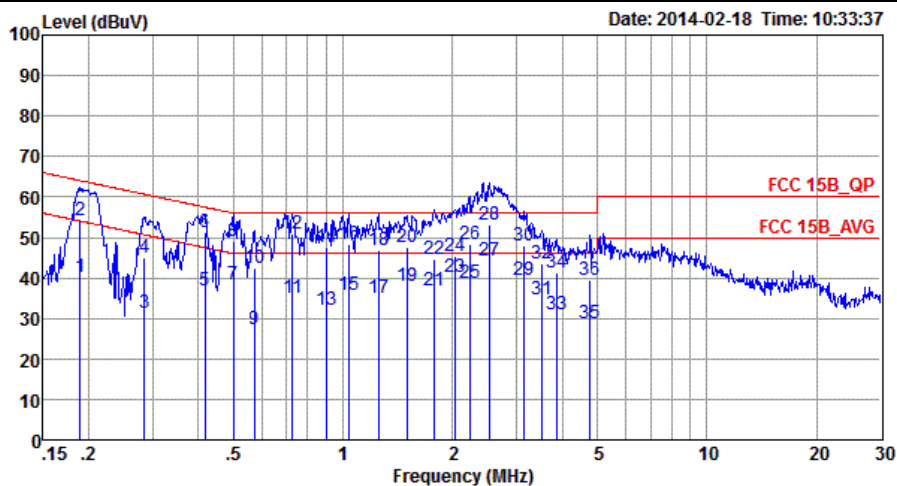

Site : C001-SZ
 Condition: FCC 15B_QP LISN_N_20130328 NEUTRAL
 Project : (FC)410704

	Freq	Level	Over Limit	Limit Line	Read Level	LISN Factor	Cable Loss	Remark
	MHz	dBuV	dB	dBuV	dBuV	dB	dB	
21	1.78	36.94	-9.06	46.00	26.70	0.06	10.18	Average
22	1.78	44.64	-11.36	56.00	34.40	0.06	10.18	QP
23	2.03	40.35	-5.65	46.00	30.10	0.06	10.19	Average
24	2.03	45.45	-10.55	56.00	35.20	0.06	10.19	QP
25	2.24	38.76	-7.24	46.00	28.50	0.07	10.19	Average
26	2.24	48.26	-7.74	56.00	38.00	0.07	10.19	QP
27 *	2.53	44.27	-1.73	46.00	34.00	0.07	10.20	Average
28	2.53	53.07	-2.93	56.00	42.80	0.07	10.20	QP
29	3.16	39.30	-6.70	46.00	29.01	0.08	10.21	Average
30	3.16	48.10	-7.90	56.00	37.81	0.08	10.21	QP
31	3.53	34.61	-11.39	46.00	24.30	0.09	10.22	Average
32	3.53	43.51	-12.49	56.00	33.20	0.09	10.22	QP
33	3.86	30.90	-15.10	46.00	20.57	0.10	10.23	Average
34	3.86	41.32	-14.68	56.00	30.99	0.10	10.23	QP
35	4.77	28.94	-17.06	46.00	18.59	0.11	10.24	Average
36	4.77	39.34	-16.66	56.00	28.99	0.11	10.24	QP



Test Mode :	Mode 3	Temperature :	21~22°C
Test Engineer :	Henry Chen	Relative Humidity :	41~42%
Test Voltage :	120Vac / 60Hz	Phase :	Line
Function Type :	GSM850 Idle + Bluetooth Idle + USB Cable (Data Link with Notebook) + Earphone + SIM1		

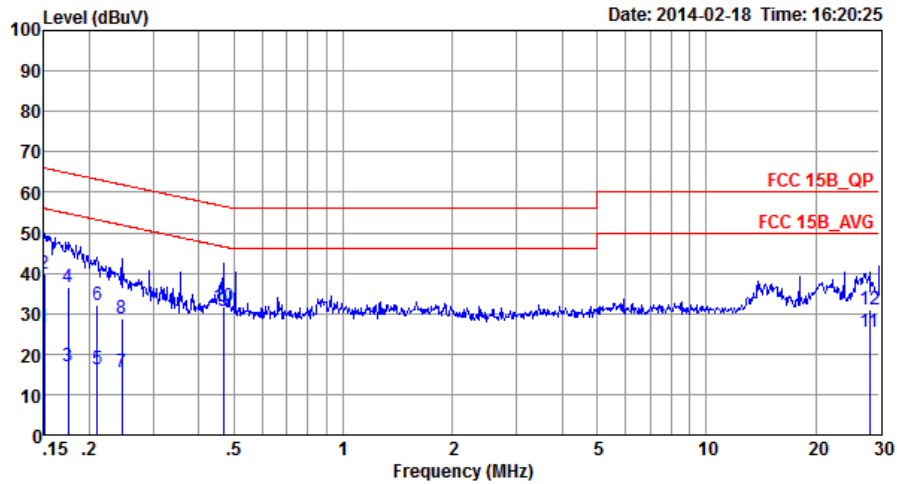

Site : CO01-SZ
 Condition: FCC 15B_QP LISN_L_20130328 LINE
 Project : (FC)410704

	Freq	Level	Over Limit	Limit Line	Read Level	LISN Factor	Cable Loss	Remark
	MHz	dBuV	dB	dBuV	dBuV	dB	dB	
1	0.15	26.52	-29.48	56.00	16.10	0.06	10.36	Average
2	0.15	39.72	-26.28	66.00	29.30	0.06	10.36	QP
3	0.17	16.89	-37.83	54.72	6.50	0.07	10.32	Average
4	0.17	36.69	-28.03	64.72	26.30	0.07	10.32	QP
5	0.21	16.16	-37.02	53.18	5.81	0.07	10.28	Average
6	0.21	31.99	-31.19	63.18	21.64	0.07	10.28	QP
7	0.25	15.53	-36.38	51.91	5.19	0.09	10.25	Average
8	0.25	28.63	-33.28	61.91	18.29	0.09	10.25	QP
9 *	0.47	30.59	-15.95	46.54	20.29	0.14	10.16	Average
10	0.47	31.59	-24.95	56.54	21.29	0.14	10.16	QP
11	28.15	25.37	-24.63	50.00	13.01	1.76	10.60	Average
12	28.15	30.87	-29.13	60.00	18.51	1.76	10.60	QP



Test Mode :	Mode 3	Temperature :	21~22°C
Test Engineer :	Henry Chen	Relative Humidity :	41~42%
Test Voltage :	120Vac / 60Hz	Phase :	Neutral
Function Type :	GSM850 Idle + Bluetooth Idle + USB Cable (Data Link with Notebook) + Earphone + SIM1		

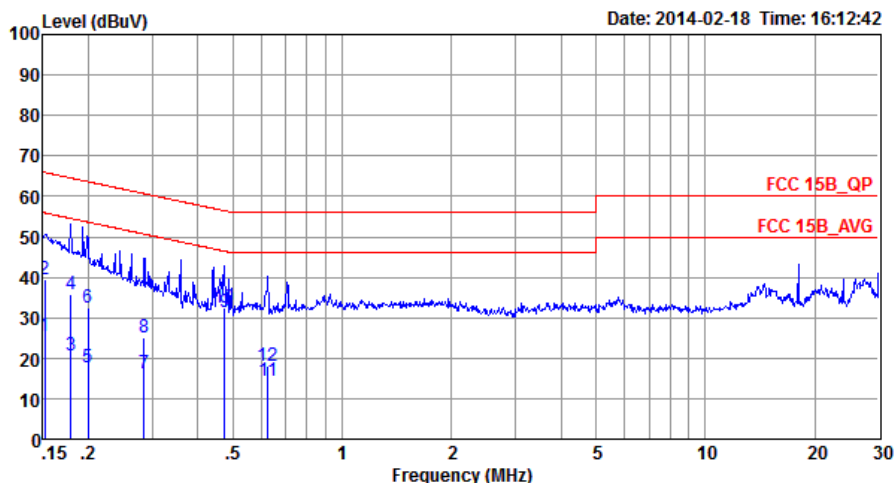

Site : CO01-SZ
 Condition: FCC 15B_QP LISN_N_20130328 NEUTRAL
 Project : (FC) 410704

	Freq	Level	Over	Limit	Read	LISN	Cable	
	MHz	dBuV	Limit	Line	Level	Factor	Loss	Remark
			dB	dBuV	dBuV	dB	dB	
1	0.15	25.40	-30.51	55.91	15.00	0.04	10.36	Average
2	0.15	39.40	-26.51	65.91	29.00	0.04	10.36	QP
3	0.18	20.56	-33.99	54.55	10.20	0.04	10.32	Average
4	0.18	35.96	-28.59	64.55	25.60	0.04	10.32	QP
5	0.20	17.83	-35.79	53.62	7.50	0.04	10.29	Average
6	0.20	32.43	-31.19	63.62	22.10	0.04	10.29	QP
7	0.28	16.25	-34.43	50.68	6.00	0.04	10.21	Average
8	0.28	25.25	-35.43	60.68	15.00	0.04	10.21	QP
9 *	0.47	31.40	-15.05	46.45	21.20	0.04	10.16	Average
10	0.47	32.60	-23.85	56.45	22.40	0.04	10.16	QP
11	0.62	14.29	-31.71	46.00	4.10	0.04	10.15	Average
12	0.62	18.19	-37.81	56.00	8.00	0.04	10.15	QP

3.2. Test of Radiated Emission Measurement

3.2.1. Limit of Radiated Emission

The emissions from an unintentional radiator shall not exceed the field strength levels specified in the following table:

Frequency (MHz)	Field Strength (microvolts/meter)	Measurement Distance (meters)
30 – 88	100	3
88 – 216	150	3
216 - 960	200	3
Above 960	500	3

3.2.2. Measuring Instruments

The measuring equipment is listed in the section 4 of this test report.

3.2.3. Test Procedures

1. The EUT was placed on a turntable with 0.8 meter above ground.
2. The EUT was set 3 meters from the interference receiving antenna, which was mounted on the top of a variable height antenna tower.
3. The table was rotated 360 degrees to determine the position of the highest radiation.
4. The antenna height is adjusted between one to four meters above ground to find the maximum value of the field strength for both horizontal polarization and vertical polarization of the antenna.
5. For each suspected emission, the EUT was arranged to its worst case and then tune the antenna tower (from 1 m to 4 m) and turntable (from 0 degree to 360 degrees) to find the maximum reading.
6. Set the test-receiver system to Peak Detect Function and specified bandwidth with Maximum Hold Mode.
7. If the emission level of the EUT in peak mode was 3 dB lower than the limit specified, peak values of EUT will be reported. Otherwise, the emission will be repeated by using the quasi-peak method and reported.
8. Emission level (dB μ V/m) = 20 log Emission level (μ V/m)
9. Corrected Reading: Antenna Factor + Cable Loss + Read Level - Preamp Factor = Level

3.2.4. Test Setup of Radiated Emission

For radiated emissions from 30MHz to 1GHz

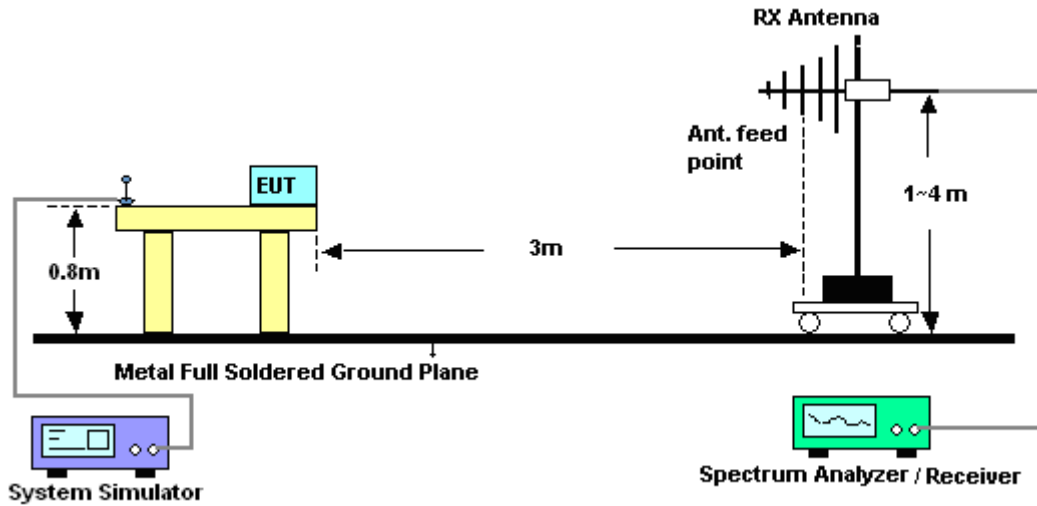

For radiated emissions above 1GHz

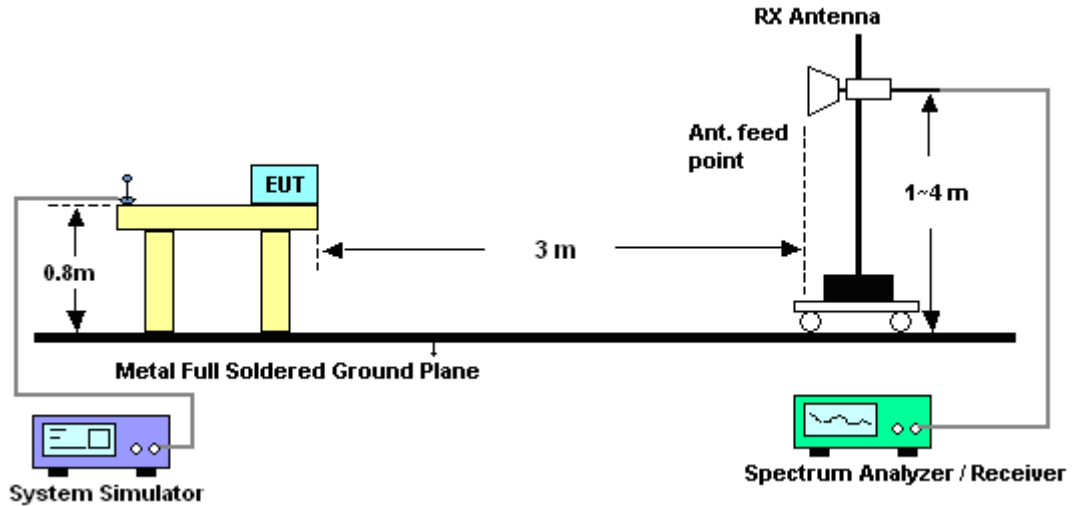



3.2.5. Test Result of Radiated Emission

Test Mode :	Mode 3	Temperature :	23~25°C
Test Engineer :	Gavin Zhang	Relative Humidity :	48~52%
Test Distance :	3m	Polarization :	Horizontal
Function Type :	GSM850 Idle + Bluetooth Idle + USB Cable (Data Link with Notebook) + Earphone + SIM1		

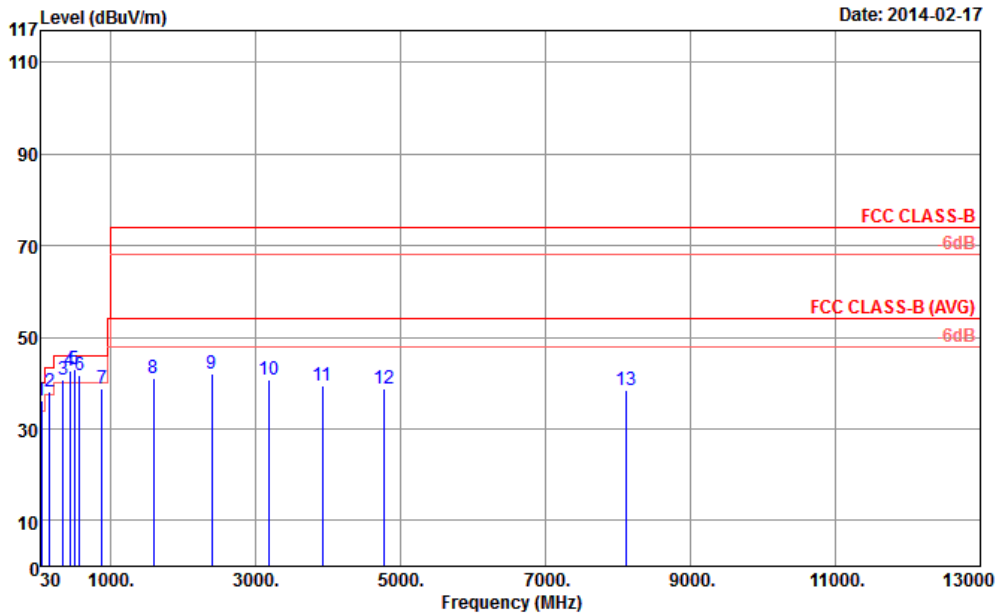

Site : 03CH01-SZ
 Condition : FCC CLASS-B 3m LF_ANT_140102 HORIZONTAL
 Project : (FC)410704

	Freq	Level	Over Limit	Limit Line	ReadAntenna Level	Antenna Factor	Cable Loss	Preamp Factor	A/Pos	T/Pos	Remark
	MHz	dBuV/m	dB	dBuV/m	dBuV	dB/m	dB	dB	cm	deg	
1 P	41.64	36.18	-3.82	40.00	55.03	11.60	0.87	31.32	---	---	Peak
2 !	156.10	38.00	-5.50	43.50	56.59	10.95	1.52	31.06	100	298	QP
3 !	348.16	40.89	-5.11	46.00	54.89	14.37	2.15	30.52	110	57	QP
4 !	438.37	42.70	-3.30	46.00	54.29	16.22	2.38	30.19	100	66	QP
5 Q	497.54	42.95	-3.05	46.00	53.26	17.15	2.52	29.98	100	187	QP
6 !	576.11	41.77	-4.23	46.00	50.20	18.55	2.71	29.69	152	263	QP
7	881.66	38.89	-7.11	46.00	43.39	20.76	3.29	28.55	---	---	Peak
8	1594.00	40.95	-33.05	74.00	65.84	27.76	4.49	57.14	---	---	Peak
9	2394.00	42.17	-31.83	74.00	61.32	31.98	5.62	56.75	100	0	Peak
10	3190.00	40.67	-33.33	74.00	58.35	33.04	6.57	57.29	---	---	Peak
11	3920.00	39.32	-34.68	74.00	57.30	33.10	7.54	58.62	---	---	Peak
12	4780.00	38.84	-35.16	74.00	54.17	33.71	8.31	57.35	---	---	Peak
13	8116.00	38.34	-35.66	74.00	48.58	35.12	10.79	56.15	---	---	Peak



Test Mode :	Mode 3	Temperature :	23~25°C
Test Engineer :	Gavin Zhang	Relative Humidity :	48~52%
Test Distance :	3m	Polarization :	Vertical
Function Type :	GSM850 Idle + Bluetooth Idle + USB Cable (Data Link with Notebook) + Earphone + SIM1		

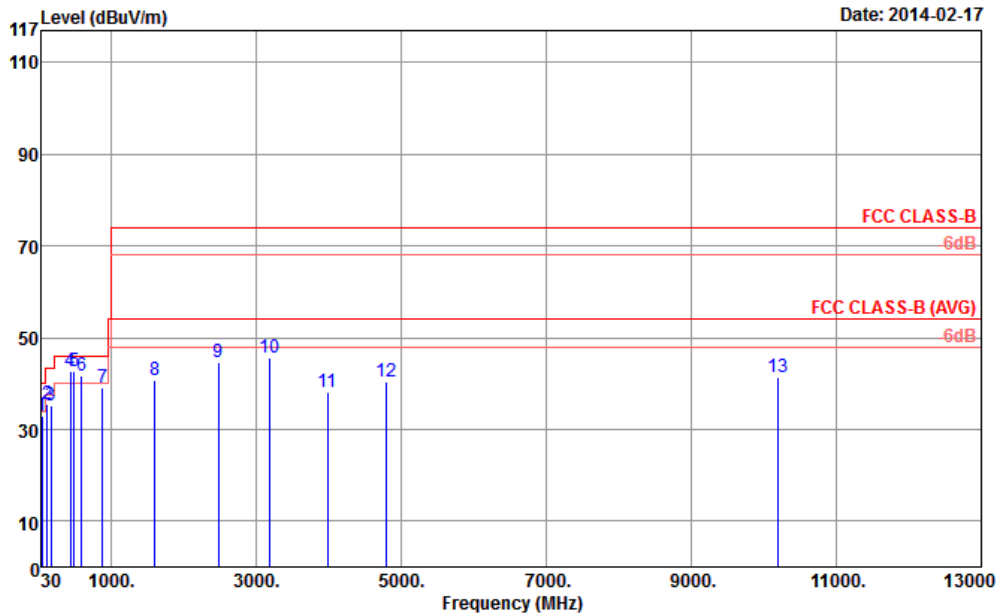

Site : 03CH01-SZ
 Condition : FCC CLASS-B 3m LF_ANT_140102 VERTICAL
 Project : (FC)410704

	Freq	Level	Over Limit	Limit Line	ReadAntenna Level	Cable Factor	Preamp Loss	A/Pos	T/Pos	Remark
	MHz	dBuV/m	dB	dBuV/m	dBuV	dB/m	dB	cm	deg	
1	40.67	33.02	-6.98	40.00	51.63	11.85	0.86	31.32	---	Peak
2	120.21	35.60	-7.90	43.50	53.90	11.50	1.35	31.15	---	Peak
3	167.74	35.33	-8.17	43.50	54.00	10.79	1.57	31.03	---	Peak
4 P	438.37	42.81	-3.19	46.00	54.40	16.22	2.38	30.19	---	Peak
5 Q	485.90	42.65	-3.35	46.00	53.26	16.92	2.49	30.02	100	360 QP
6 !	587.75	41.83	-4.17	46.00	50.15	18.58	2.74	29.64	130	290 QP
7	881.66	38.95	-7.05	46.00	43.45	20.76	3.29	28.55	---	Peak
8	1598.00	40.70	-33.30	74.00	65.59	27.76	4.49	57.14	---	Peak
9	2478.00	44.54	-29.46	74.00	63.20	32.41	5.71	56.78	---	Peak
10	3190.00	45.70	-28.30	74.00	63.38	33.04	6.57	57.29	100	360 Peak
11	3988.00	38.16	-35.84	74.00	56.18	33.10	7.62	58.74	---	Peak
12	4798.00	40.36	-33.64	74.00	55.61	33.74	8.33	57.32	---	Peak
13	10192.00	41.34	-32.66	74.00	48.65	36.88	12.76	56.95	---	Peak

4. List of Measuring Equipment

Instrument	Manufacturer	Model No.	Serial No.	Characteristics	Calibration Date	Test Date	Due Date	Remark
ESCIO Test Receiver	R&S	ESCI	100724	9kHz~3GHz	Mar. 29, 2013	Feb. 18, 2014	Mar. 28, 2014	Conduction (CO01-SZ)
AC LISN	EMCO	3816/2SH	00103912	9kHz~30MHz	Mar. 28, 2013	Feb. 18, 2014	Mar. 27, 2014	Conduction (CO01-SZ)
AC LISN (for auxiliary equipment)	EMCO	3816/2SH	00103892	9kHz~30MHz	Mar. 28, 2013	Feb. 18, 2014	Mar. 27, 2014	Conduction (CO01-SZ)
AC Power Source	Chroma	61602	616020000891	100Vac~250Vac	Nov. 20, 2013	Feb. 18, 2014	Nov. 19, 2014	Conduction (CO01-SZ)
Spectrum Analyzer	Agilent Technologies	N9038A	MY52260185	20Hz~26.5GHz	Apr. 04, 2013	Feb. 17, 2014	Apr. 03, 2014	Radiation (03CH01-SZ)
Double Ridge Horn Antenna	ETS Lindgren	3117	00119436	1GHz~18GHz	Oct. 26, 2013	Feb. 17, 2014	Oct. 25, 2014	Radiation (03CH01-SZ)
Bilog Antenna	SCHAFFNER	CBL6112B	2614	30MHz~2GHz	Dec. 26, 2013	Feb. 17, 2014	Dec. 25, 2014	Radiation (03CH01-SZ)
Amplifier	ADVANTEST	BB525C	E9007003	9kHz~3000MHz GAIN 30db	Mar. 28, 2013	Feb. 17, 2014	Mar. 27, 2014	Radiation (03CH01-SZ)
Amplifier	Yiai	AV3860B	04030	2GHz~26.5GHz	Mar. 28, 2013	Feb. 17, 2014	Mar. 27, 2014	Radiation (03CH01-SZ)
Turn Table	EM Electronics	EM 1000	N/A	0 ~ 360 degree	N/A	Feb. 17, 2014	N/A	Radiation (03CH01-SZ)
Antenna Mast	EM Electronics	EM 1000	N/A	1 m - 4 m	N/A	Feb. 17, 2014	N/A	Radiation (03CH01-SZ)

5. Uncertainty of Evaluation

Uncertainty of Conducted Emission Measurement (150 kHz ~ 30 MHz)

Measuring Uncertainty for a Level of Confidence of 95% ($U = 2Uc(y)$)	2.26
---	------

Uncertainty of Radiated Emission Measurement (30 MHz ~ 1000 MHz)

Measuring Uncertainty for a Level of Confidence of 95% ($U = 2Uc(y)$)	3.90
---	------