

FCC SAR Test Report

APPLICANT : Brightstar Corporation
EQUIPMENT : Smart Phone
BRAND NAME : Avvio, PULSARE
MODEL NAME : Avvio 786S, Avvio 786, Pulsare 786S, Pulsare 786
FCC ID : WVBA786X
STANDARD : FCC 47 CFR Part 2 (2.1093)
ANSI/IEEE C95.1-1992
IEEE 1528-2003

We, SPORTON INTERNATIONAL (XI'AN) INC., would like to declare that the tested sample has been evaluated in accordance with the procedures and had been in compliance with the applicable technical standards.

The test results in this report apply exclusively to the tested model / sample. Without written approval of SPORTON INTERNATIONAL (XI'AN) INC., the test report shall not be reproduced except in full.

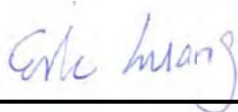

Reviewed by: Eric Huang / Deputy Manager



Approved by: Jones Tsai / Manager



SPORTON INTERNATIONAL (XI'AN) INC.

1F, Building A3, No. 39 Chuangye Rd., Xi'an Hi-tech Zone, Shanxi Province, P. R. C.



Table of Contents

1. Statement of Compliance4
2. Administration Data5
3. Guidance Standard5
4. Equipment Under Test (EUT)6
4.1 General Information6
4.2 Maximum Tune-up Limit.....7
5. RF Exposure Limits8
5.1 Uncontrolled Environment.....8
5.2 Controlled Environment.....8
6. Specific Absorption Rate (SAR).....9
6.1 Introduction9
6.2 SAR Definition.....9
7. System Description and Setup10
8. Measurement Procedures11
8.1 Spatial Peak SAR Evaluation.....11
8.2 Power Reference Measurement.....12
8.3 Area Scan12
8.4 Zoom Scan.....13
8.5 Volume Scan Procedures.....13
8.6 Power Drift Monitoring.....13
9. Test Equipment List14
10. System Verification15
10.1 Tissue Verification15
10.2 System Performance Check Results.....16
11. RF Exposure Positions17
11.1 Ear and handset reference point17
11.2 Definition of the cheek position.....18
11.3 Definition of the tilt position.....19
11.4 Body Worn Accessory20
11.5 Wireless Router.....20
12. Conducted RF Output Power (Unit: dBm).....21
13. Bluetooth Exclusions Applied27
14. Antenna Location28
15. SAR Test Results29
15.1 Head SAR30
15.2 Hotspot SAR31
15.3 Body Worn Accessory SAR.....33
15.4 Repeated SAR Measurement34
16. Simultaneous Transmission Analysis.....35
16.1 Head Exposure Conditions36
16.2 Hotspot Exposure Conditions.....37
16.3 Body-Worn Accessory Exposure Conditions39
17. Uncertainty Assessment40
18. References.....42
Appendix A. Plots of System Performance Check
Appendix B. Plots of High SAR Measurement
Appendix C. DASy Calibration Certificate
Appendix D. Test Setup Photos



Revision History

REPORT NO.	VERSION	DESCRIPTION	ISSUED DATE
FA492607	Rev. 01	Initial issue of report	Nov. 24, 2014

1. Statement of Compliance

The maximum results of Specific Absorption Rate (SAR) found during testing for **Brightstar Corporation, Smart Phone, Avvio 786S, Avvio 786, Pulsare 786S,Pulsare 786** are as follows.

Equipment Class	Frequency Band	Operating Mode	Highest SAR Summary			
			Head 1g SAR (W/kg) Gap(0 mm)	Body-worn 1g SAR (W/kg) Gap(10 mm)	Wireless Router 1g SAR (W/kg) Gap(10 mm)	Simultaneous Transmission SAR (W/kg)
PCE	GSM850	Voice/Data	0.60	1.39	1.39	1.50
	GSM1900	Voice/Data	0.41	0.77	0.77	
	WCDMA Band V	Voice/Data	0.33	0.64	0.64	
	WCDMA Band II	Voice/Data	0.37	0.68	0.68	
DTS	WLAN 2.4GHz Band	Data	0.16	0.12	0.11	1.50
DSS	Bluetooth	Data				1.45
Date of Testing:			Oct. 16, 2014 ~ Oct. 19, 2014			

This device is in compliance with Specific Absorption Rate (SAR) for general population/uncontrolled exposure limits (1.6 W/kg) specified in FCC 47 CFR part 2 (2.1093) and ANSI/IEEE C95.1-1992, and had been tested in accordance with the measurement methods and procedures specified in IEEE 1528-2003.



2. Administration Data

Testing Laboratory	
Test Site	SPORTON INTERNATIONAL (XI'AN) INC.
Test Site Location	1F, Building A3, No. 39 Chuangye Rd., Xi'an Hi-tech Zone, Shanxi Province, P. R. C. TEL: +86-029-8860-8767 FAX: +86-029-8860-8791

Applicant	
Company Name	Brightstar Corporation
Address	9725 NW 117th Ave., Miami, Florida, FL 33178, United States

Manufacturer	
Company Name	Lakia Networks Co., Ltd.
Address	2F, Unit A, Technology Service Building, Software Garden 1, Xiamen, Fujian, China

3. Guidance Standard

The Specific Absorption Rate (SAR) testing specification, method, and procedure for this device is in accordance with the following standards:

- FCC 47 CFR Part 2 (2.1093)
- ANSI/IEEE C95.1-1992
- IEEE 1528-2003
- FCC KDB 865664 D01 SAR Measurement 100 MHz to 6 GHz v01r03
- FCC KDB 865664 D02 SAR Reporting v01r01
- FCC KDB 447498 D01 General RF Exposure Guidance v05r02
- FCC KDB 648474 D04 SAR Evaluation Considerations for Wireless Handsets v01r02
- FCC KDB 248227 D01 SAR meas for 802 11abg v01r02
- FCC KDB 941225 D01 SAR test for 3G devices v03
- FCC KDB 941225 D02 HSPA and 1x Advanced v02r02
- FCC KDB 941225 D03 SAR Test Reduction GSM GPRS EDGE v01
- FCC KDB 941225 D06 Hotspot Mode SAR v01r01

4. Equipment Under Test (EUT)

4.1 General Information

Product Feature & Specification																					
Equipment Name	Smart Phone																				
Brand Name	Avvio, PULSARE																				
Model Name	Avvio 786S, Avvio 786, Pulsare 786S, Pulsare 786																				
FCC ID	WVBA786X																				
IMEI Code	SIM1: 351701039986060 SIM2: 351701039986078																				
Wireless Technology and Frequency Range	GSM850: 824.2 MHz ~ 848.8 MHz GSM1900: 1850.2 MHz ~ 1909.8 MHz WCDMA Band V: 826.4 MHz ~ 846.6 MHz WCDMA Band II: 1852.4 MHz ~ 1907.6 MHz WLAN 2.4GHz Band: 2412 MHz ~ 2462 MHz Bluetooth: 2402 MHz ~ 2480 MHz																				
Mode	<ul style="list-style-type: none"> • GSM/GPRS/EGPRS (downlink only). • RMC/AMR12.2Kbps • HSDPA • HSUPA • HSPA+(downlink only) • 802.11b/g/n HT20/HT40 • Bluetooth v3.0+EDR, Bluetooth v4.0 LE 																				
HW Version	F1Q_V1.3_W25_20140630																				
SW Version	Avvio786S.W25.V1.0																				
GSM / (E)GPRS Transfer mode	Class B – EUT cannot support Packet Switched and Circuit Switched Network simultaneously but can automatically switch between Packet and Circuit Switched Network.																				
EUT Stage	Identical Prototype																				
Remark: <ol style="list-style-type: none"> 1. This device 2.4GHz WLAN supports hotspot operation. 2. This device supported VoIP in GPRS, WCDMA (e.g. 3rd party VoIP). 3. This device supports GRPS / EGPRS mode up to multi-slot class 12 and EGPRS downlink only. 4. The EUT do not support DTM function. 5. There are four types of EUT for this project. The differences between them are summary below: <table border="1" style="width: 100%; border-collapse: collapse;"> <thead> <tr> <th>Sample List</th> <th>Model name</th> <th>Brand name</th> <th>SIM Slots</th> </tr> </thead> <tbody> <tr> <td>Sample 1</td> <td>Avvio 786</td> <td>Avvio</td> <td>1</td> </tr> <tr> <td>Sample 2</td> <td>Avvio 786S</td> <td>Avvio</td> <td>2</td> </tr> <tr> <td>Sample 3</td> <td>Pulsare 786</td> <td>PULSARE</td> <td>1</td> </tr> <tr> <td>Sample 4</td> <td>Pulsare 786S</td> <td>PULSARE</td> <td>2</td> </tr> </tbody> </table> <p>These models are identical on hardware except the SIM slots. The different model with different brand is for market purpose.</p> <ol style="list-style-type: none"> 6. For 2 SIM slots support dual SIM dual Standby. The WWAN radio transmission will be enabled by either one SIM at a time (Single active). 		Sample List	Model name	Brand name	SIM Slots	Sample 1	Avvio 786	Avvio	1	Sample 2	Avvio 786S	Avvio	2	Sample 3	Pulsare 786	PULSARE	1	Sample 4	Pulsare 786S	PULSARE	2
Sample List	Model name	Brand name	SIM Slots																		
Sample 1	Avvio 786	Avvio	1																		
Sample 2	Avvio 786S	Avvio	2																		
Sample 3	Pulsare 786	PULSARE	1																		
Sample 4	Pulsare 786S	PULSARE	2																		

4.2 Maximum Tune-up Limit

Mode	Burst average power(dBm)	
	GSM 850	GSM 1900
GSM (GMSK, 1 Tx slot)	31.5	29.0
GPRS (GMSK, 1 Tx slot)	31.5	29.0
GPRS (GMSK, 2 Tx slots)	31.0	28.5
GPRS (GMSK, 3 Tx slots)	30.0	27.0
GPRS (GMSK, 4 Tx slots)	29.5	27.0

Mode	Average power(dBm)	
	WCDMA Band V	WCDMA Band II
AMR 12.2Kbps	22.5	23.0
RMC 12.2Kbps	22.5	23.0
HSDPA Subtest-1	19.0	19.5
HSDPA Subtest-2	19.0	19.5
HSDPA Subtest-3	19.0	19.5
HSDPA Subtest-4	19.0	19.5
HSUPA Subtest-1	18.0	18.5
HSUPA Subtest-2	18.0	18.5
HSUPA Subtest-3	19.0	19.5
HSUPA Subtest-4	17.5	18.0
HSUPA Subtest-5	19.0	19.5

Mode		Maximum Average Power (dBm)	
2.4GHz	802.11b	15.0	
	802.11g	13.0	
	802.11n-HT20	13.0	
	802.11n-HT40	CH 03	10.5
		CH 06	12.5
CH 09		10.5	
Bluetooth v3.0+EDR		5.0	
Bluetooth v4.0 LE		-4.0	

5. RF Exposure Limits

5.1 Uncontrolled Environment

Uncontrolled Environments are defined as locations where there is the exposure of individuals who have no knowledge or control of their exposure. The general population/uncontrolled exposure limits are applicable to situations in which the general public may be exposed or in which persons who are exposed as a consequence of their employment may not be made fully aware of the potential for exposure or cannot exercise control over their exposure. Members of the general public would come under this category when exposure is not employment-related; for example, in the case of a wireless transmitter that exposes persons in its vicinity.

5.2 Controlled Environment

Controlled Environments are defined as locations where there is exposure that may be incurred by persons who are aware of the potential for exposure, (i.e. as a result of employment or occupation). In general, occupational/controlled exposure limits are applicable to situations in which persons are exposed as a consequence of their employment, who have been made fully aware of the potential for exposure and can exercise control over their exposure. The exposure category is also applicable when the exposure is of a transient nature due to incidental passage through a location where the exposure levels may be higher than the general population/uncontrolled limits, but the exposed person is fully aware of the potential for exposure and can exercise control over his or her exposure by leaving the area or by some other appropriate means.

Limits for Occupational/Controlled Exposure (W/kg)

Whole-Body	Partial-Body	Hands, Wrists, Feet and Ankles
0.4	8.0	20.0

Limits for General Population/Uncontrolled Exposure (W/kg)

Whole-Body	Partial-Body	Hands, Wrists, Feet and Ankles
0.08	1.6	4.0

1. Whole-Body SAR is averaged over the entire body, partial-body SAR is averaged over any 1gram of tissue defined as a tissue volume in the shape of a cube. SAR for hands, wrists, feet and ankles is averaged over any 10 grams of tissue defined as a tissue volume in the shape of a cube.

6. Specific Absorption Rate (SAR)

6.1 Introduction

SAR is related to the rate at which energy is absorbed per unit mass in an object exposed to a radio field. The SAR distribution in a biological body is complicated and is usually carried out by experimental techniques or numerical modeling. The standard recommends limits for two tiers of groups, occupational/controlled and general population/uncontrolled, based on a person's awareness and ability to exercise control over his or her exposure. In general, occupational/controlled exposure limits are higher than the limits for general population/uncontrolled.

6.2 SAR Definition

The SAR definition is the time derivative (rate) of the incremental energy (dW) absorbed by (dissipated in) an incremental mass (dm) contained in a volume element (dv) of a given density (ρ). The equation description is as below:

$$SAR = \frac{d}{dt} \left(\frac{dW}{dm} \right) = \frac{d}{dt} \left(\frac{dW}{\rho dv} \right)$$

SAR is expressed in units of Watts per kilogram (W/kg)

$$SAR = \frac{\sigma |E|^2}{\rho}$$

Where: σ is the conductivity of the tissue, ρ is the mass density of the tissue and E is the RMS electrical field strength.

7. System Description and Setup

The DASY system used for performing compliance tests consists of the following items:

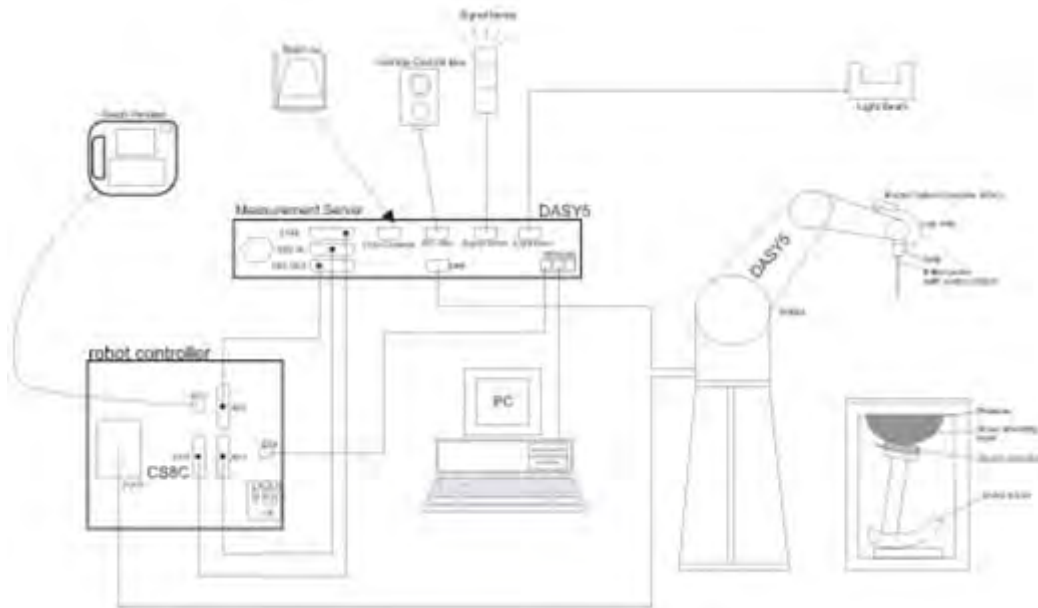

- A standard high precision 6-axis robot with controller, teach pendant and software. An arm extension for accommodating the data acquisition electronics (DAE).
- An isotropic Field probe optimized and calibrated for the targeted measurement.
- A data acquisition electronics (DAE) which performs the signal amplification, signal multiplexing, AD-conversion, offset measurements, mechanical surface detection, collision detection, etc. The unit is battery powered with standard or rechargeable batteries. The signal is optically transmitted to the EOC.
- The Electro-optical converter (EOC) performs the conversion from optical to electrical signals for the digital communication to the DAE. To use optical surface detection, a special version of the EOC is required. The EOC signal is transmitted to the measurement server.
- The function of the measurement server is to perform the time critical tasks such as signal filtering, control of the robot operation and fast movement interrupts.
- The Light Beam used is for probe alignment. This improves the (absolute) accuracy of the probe positioning.
- A computer running WinXP or Win7 and the DASY5 software.
- Remote control and teach pendant as well as additional circuitry for robot safety such as warning lamps, etc.
- The phantom, the device holder and other accessories according to the targeted measurement.

8. Measurement Procedures

The measurement procedures are as follows:

<Conducted power measurement>

- (a) For WWAN power measurement, use base station simulator to configure EUT WWAN transmission in conducted connection with RF cable, at maximum power in each supported wireless interface and frequency band.
- (b) Read the WWAN RF power level from the base station simulator.
- (c) For WLAN/BT power measurement, use engineering software to configure EUT WLAN/BT continuously transmission, at maximum RF power in each supported wireless interface and frequency band
- (d) Connect EUT RF port through RF cable to the power meter, and measure WLAN/BT output power

<SAR measurement>

- (a) Use base station simulator to configure EUT WWAN transmission in radiated connection, and engineering software to configure EUT WLAN/BT continuously transmission, at maximum RF power, in the highest power channel.
- (b) Place the EUT in the positions as Appendix D demonstrates.
- (c) Set scan area, grid size and other setting on the DASY software.
- (d) Measure SAR results for the highest power channel on each testing position.
- (e) Find out the largest SAR result on these testing positions of each band
- (f) Measure SAR results for other channels in worst SAR testing position if the reported SAR of highest power channel is larger than 0.8 W/kg

According to the test standard, the recommended procedure for assessing the peak spatial-average SAR value consists of the following steps:

- (a) Power reference measurement
- (b) Area scan
- (c) Zoom scan
- (d) Power drift measurement

8.1 Spatial Peak SAR Evaluation

The procedure for spatial peak SAR evaluation has been implemented according to the test standard. It can be conducted for 1g and 10g, as well as for user-specific masses. The DASY software includes all numerical procedures necessary to evaluate the spatial peak SAR value.

The base for the evaluation is a "cube" measurement. The measured volume must include the 1g and 10g cubes with the highest averaged SAR values. For that purpose, the center of the measured volume is aligned to the interpolated peak SAR value of a previously performed area scan.

The entire evaluation of the spatial peak values is performed within the post-processing engine (SEMCAD). The system always gives the maximum values for the 1g and 10g cubes. The algorithm to find the cube with highest averaged SAR is divided into the following stages:

- (a) Extraction of the measured data (grid and values) from the Zoom Scan
- (b) Calculation of the SAR value at every measurement point based on all stored data (A/D values and measurement parameters)
- (c) Generation of a high-resolution mesh within the measured volume
- (d) Interpolation of all measured values from the measurement grid to the high-resolution grid
- (e) Extrapolation of the entire 3-D field distribution to the phantom surface over the distance from sensor to surface
- (f) Calculation of the averaged SAR within masses of 1g and 10g

8.2 Power Reference Measurement

The Power Reference Measurement and Power Drift Measurements are for monitoring the power drift of the device under test in the batch process. The minimum distance of probe sensors to surface determines the closest measurement point to phantom surface. This distance cannot be smaller than the distance of sensor calibration points to probe tip as defined in the probe properties.

8.3 Area Scan

The area scan is used as a fast scan in two dimensions to find the area of high field values, before doing a fine measurement around the hot spot. The sophisticated interpolation routines implemented in DASY software can find the maximum found in the scanned area, within a range of the global maximum. The range (in dB0 is specified in the standards for compliance testing. For example, a 2 dB range is required in IEEE standard 1528 and IEC 62209 standards, whereby 3 dB is a requirement when compliance is assessed in accordance with the ARIB standard (Japan), if only one zoom scan follows the area scan, then only the absolute maximum will be taken as reference. For cases where multiple maximums are detected, the number of zoom scans has to be increased accordingly.

Area scan parameters extracted from FCC KDB 865664 D01v01r03 SAR measurement 100 MHz to 6 GHz.

	≤ 3 GHz	> 3 GHz
Maximum distance from closest measurement point (geometric center of probe sensors) to phantom surface	5 ± 1 mm	$\frac{1}{2} \cdot \delta \cdot \ln(2) \pm 0.5$ mm
Maximum probe angle from probe axis to phantom surface normal at the measurement location	30° ± 1°	20° ± 1°
Maximum area scan spatial resolution: Δx_{Area} , Δy_{Area}	≤ 2 GHz: ≤ 15 mm 2 – 3 GHz: ≤ 12 mm	3 – 4 GHz: ≤ 12 mm 4 – 6 GHz: ≤ 10 mm
	When the x or y dimension of the test device, in the measurement plane orientation, is smaller than the above, the measurement resolution must be ≤ the corresponding x or y dimension of the test device with at least one measurement point on the test device.	

8.4 Zoom Scan

Zoom scans are used assess the peak spatial SAR values within a cubic averaging volume containing 1 gram and 10 gram of simulated tissue. The zoom scan measures points (refer to table below) within a cube shoes base faces are centered on the maxima found in a preceding area scan job within the same procedure. When the measurement is done, the zoom scan evaluates the averaged SAR for 1 gram and 10 gram and displays these values next to the job's label.

Zoom scan parameters extracted from FCC KDB 865664 D01v01r03 SAR measurement 100 MHz to 6 GHz.

		≤ 3 GHz	> 3 GHz	
Maximum zoom scan spatial resolution: $\Delta x_{Zoom}, \Delta y_{Zoom}$		≤ 2 GHz: ≤ 8 mm 2 – 3 GHz: ≤ 5 mm*	3 – 4 GHz: ≤ 5 mm* 4 – 6 GHz: ≤ 4 mm*	
Maximum zoom scan spatial resolution, normal to phantom surface	uniform grid: $\Delta z_{Zoom}(n)$	≤ 5 mm	3 – 4 GHz: ≤ 4 mm 4 – 5 GHz: ≤ 3 mm 5 – 6 GHz: ≤ 2 mm	
	graded grid	$\Delta z_{Zoom}(1)$: between 1 st two points closest to phantom surface	≤ 4 mm	3 – 4 GHz: ≤ 3 mm 4 – 5 GHz: ≤ 2.5 mm 5 – 6 GHz: ≤ 2 mm
		$\Delta z_{Zoom}(n>1)$: between subsequent points	$\leq 1.5 \cdot \Delta z_{Zoom}(n-1)$	
Minimum zoom scan volume	x, y, z	≥ 30 mm	3 – 4 GHz: ≥ 28 mm 4 – 5 GHz: ≥ 25 mm 5 – 6 GHz: ≥ 22 mm	
Note: δ is the penetration depth of a plane-wave at normal incidence to the tissue medium; see draft standard IEEE P1528-2011 for details. * When zoom scan is required and the <i>reported</i> SAR from the <i>area scan based 1-g SAR estimation</i> procedures of KDB 447498 is ≤ 1.4 W/kg, ≤ 8 mm, ≤ 7 mm and ≤ 5 mm zoom scan resolution may be applied, respectively, for 2 GHz to 3 GHz, 3 GHz to 4 GHz and 4 GHz to 6 GHz.				

8.5 Volume Scan Procedures

The volume scan is used for assess overlapping SAR distributions for antennas transmitting in different frequency bands. It is equivalent to an oversized zoom scan used in standalone measurements. The measurement volume will be used to enclose all the simultaneous transmitting antennas. For antennas transmitting simultaneously in different frequency bands, the volume scan is measured separately in each frequency band. In order to sum correctly to compute the 1g aggregate SAR, the EUT remain in the same test position for all measurements and all volume scan use the same spatial resolution and grid spacing. When all volume scan were completed, the software, SEMCAD postprocessor can combine and subsequently superpose these measurement data to calculating the multiband SAR.

8.6 Power Drift Monitoring

All SAR testing is under the EUT install full charged battery and transmit maximum output power. In DASY measurement software, the power reference measurement and power drift measurement procedures are used for monitoring the power drift of EUT during SAR test. Both these procedures measure the field at a specified reference position before and after the SAR testing. The software will calculate the field difference in dB. If the power drifts more than 5%, the SAR will be retested.



9. Test Equipment List

Manufacturer	Name of Equipment	Type/Model	Serial Number	Calibration	
				Last Cal.	Due Date
SPEAG	835MHz System Validation Kit	D835V2	4d151	Mar. 25, 2013	Mar. 23, 2015
SPEAG	1900MHz System Validation Kit	D1900V2	5d170	Mar. 27, 2013	Mar. 25, 2015
SPEAG	2450MHz System Validation Kit	D2450V2	908	Mar. 26, 2013	Mar. 24, 2015
SPEAG	Data Acquisition Electronics	DAE4	1358	Apr. 30, 2014	Apr. 29, 2015
SPEAG	Dosimetric E-Field Probe	EX3DV4	3911	Oct. 02, 2014	Oct. 01, 2015
SPEAG	SAM Twin Phantom	QD 000 P40 CD	TP-1753	NCR	NCR
SPEAG	SAM Twin Phantom	QD 000 P40 CD	TP-1754	NCR	NCR
SPEAG	Phone Positioner	N/A	N/A	NCR	NCR
Agilent	Wireless Communication Test Set	E5515C	MY52102600	Dec. 30, 2013	Dec. 29, 2014
Agilent	ENA Series Network Analyzer	E5071C	MY46111157	Dec. 30, 2013	Dec. 29, 2014
Agilent	Dielectric Probe Kit	85070E	MY44300751	NCR	NCR
Anritsu	Power Meter	ML2495A	1005002	Feb. 27, 2014	Feb. 26, 2015
Anritsu	Power Sensor	MA2411B	917070	Feb. 27, 2014	Feb. 26, 2015
R&S	Spectrum Analyzer	FSP7	101045	Dec. 30, 2013	Dec. 29, 2014
Agilent	Dual Directional Coupler	778D	50422	Note1	
Woken	Attenuator 1	WK0602-XX	N/A	Note1	
PE	Attenuator 2	PE7005-10	N/A	Note1	
PE	Attenuator 3	PE7005- 3	N/A	Note1	
AR	Power Amplifier	5S1G4M2	0328767	Note1	
Mini-Circuits	Power Amplifier	ZVE-3W	162601250	Note1	
Mini-Circuits	Power Amplifier	ZHL-42W+	13440021344	Note1	

General Note:

1. Prior to system verification and validation, the path loss from the signal generator to the system check source and the power meter, which includes the amplifier, cable, attenuator and directional coupler, was measured by the network analyzer. The reading of the power meter was offset by the path loss difference between the path to the power meter and the path to the system check source to monitor the actual power level fed to the system check source.
2. Referring to KDB 865664 D01v01r03, the dipole calibration interval can be extended to 3 years with justification. The dipoles are also not physically damaged, or repaired during the interval.
3. The justification data of dipole D835V2, SN: 4d151, D1900V2, SN: 5d170 and D2450V2, SN: 908 can be found in appendix C. The return loss is < -20dB, within 20% of prior calibration, the impedance is within 5 ohm of prior calibration.

10. System Verification

10.1 Tissue Verification

The following tissue formulations are provided for reference only as some of the parameters have not been thoroughly verified. The composition of ingredients may be modified accordingly to achieve the desired target tissue parameters required for routine SAR evaluation.

Frequency (MHz)	Water (%)	Sugar (%)	Cellulose (%)	Salt (%)	Preventol (%)	DGBE (%)	Conductivity (σ)	Permittivity (ϵ_r)
For Head								
835	40.3	57.9	0.2	1.4	0.2	0	0.90	41.5
1800, 1900, 2000	55.2	0	0	0.3	0	44.5	1.40	40.0
2450	55.0	0	0	0	0	45.0	1.80	39.2
For Body								
835	50.8	48.2	0	0.9	0.1	0	0.97	55.2
1800, 1900, 2000	70.2	0	0	0.4	0	29.4	1.52	53.3
2450	68.6	0	0	0	0	31.4	1.95	52.7

<Tissue Dielectric Parameter Check Results>

Frequency (MHz)	Tissue Type	Liquid Temp. (°C)	Conductivity (σ)	Permittivity (ϵ_r)	Conductivity Target (σ)	Permittivity Target (ϵ_r)	Delta (σ) (%)	Delta (ϵ_r) (%)	Limit (%)	Date
835	Head	22.7	0.929	41.793	0.90	41.5	3.22	0.71	±5	Oct. 17, 2014
1900	Head	22.6	1.449	40.853	1.40	40.0	3.50	2.13	±5	Oct. 17, 2014
2450	Head	22.6	1.832	37.700	1.80	39.2	1.78	-3.83	±5	Oct. 18, 2014
835	Body	22.6	0.974	54.266	0.97	55.2	0.41	-1.69	±5	Oct. 16, 2014
1900	Body	22.7	1.554	53.078	1.52	53.3	2.24	-0.42	±5	Oct. 16, 2014
2450	Body	22.5	1.984	51.165	1.95	52.7	1.74	-2.91	±5	Oct. 19, 2014

10.2 System Performance Check Results

Comparing to the original SAR value provided by SPEAG, the verification data should be within its specification of 10 %. Below table shows the target SAR and measured SAR after normalized to 1W input power. The table below indicates the system performance check can meet the variation criterion and the plots can be referred to Appendix A of this report.

Date	Frequency (MHz)	Tissue Type	Input Power (mW)	Dipole S/N	Probe S/N	DAE S/N	Measured SAR (W/kg)	Targeted SAR (W/kg)	Normalized SAR (W/kg)	Deviation (%)
Oct. 17, 2014	835	Head	250	4d151	3911	1358	2.53	9.49	10.12	6.64
Oct. 17, 2014	1900	Head	250	5d170	3911	1358	9.93	40.20	39.72	-1.19
Oct. 18, 2014	2450	Head	250	908	3911	1358	14.00	54.00	56	3.70
Oct. 16, 2014	835	Body	250	4d151	3911	1358	2.40	9.43	9.6	1.80
Oct. 16, 2014	1900	Body	250	5d170	3911	1358	9.93	41.20	39.72	-3.59
Oct. 19, 2014	2450	Body	250	908	3911	1358	13.60	50.40	54.4	7.94

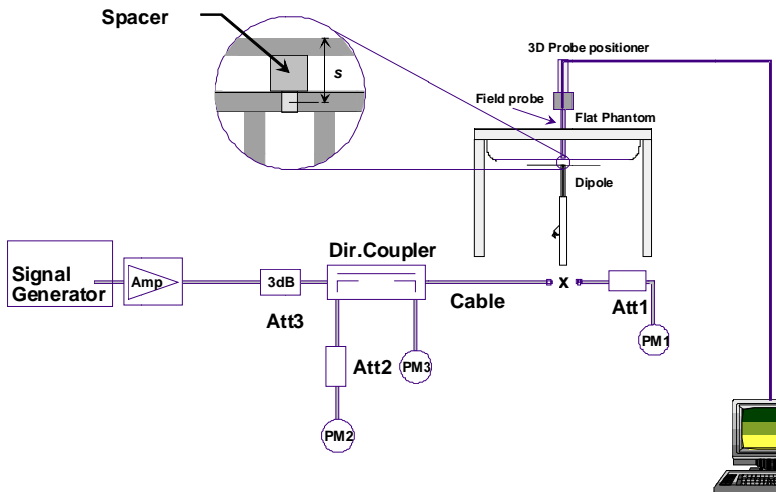

Fig 8.3.1 System Performance Check Setup



Fig 8.3.2 Setup Photo

11. RF Exposure Positions

11.1 Ear and handset reference point

Figure 9.1.1 shows the front, back, and side views of the SAM phantom. The center-of-mouth reference point is labeled "M," the left ear reference point (ERP) is marked "LE," and the right ERP is marked "RE." Each ERP is 15 mm along the B-M (back-mouth) line behind the entrance-to-ear-canal (EEC) point, as shown in Figure 9.1.2 The Reference Plane is defined as passing through the two ear reference points and point M. The line N-F (neck-front), also called the reference pivoting line, is normal to the Reference Plane and perpendicular to both a line passing through RE and LE and the B-M line (see Figure 9.1.3). Both N-F and B-M lines should be marked on the exterior of the phantom shell to facilitate handset positioning. Posterior to the N-F line the ear shape is a flat surface with 6 mm thickness at each ERP, and forward of the N-F line the ear is truncated, as illustrated in Figure 9.1.2. The ear truncation is introduced to preclude the ear lobe from interfering with handset tilt, which could lead to unstable positioning at the cheek.

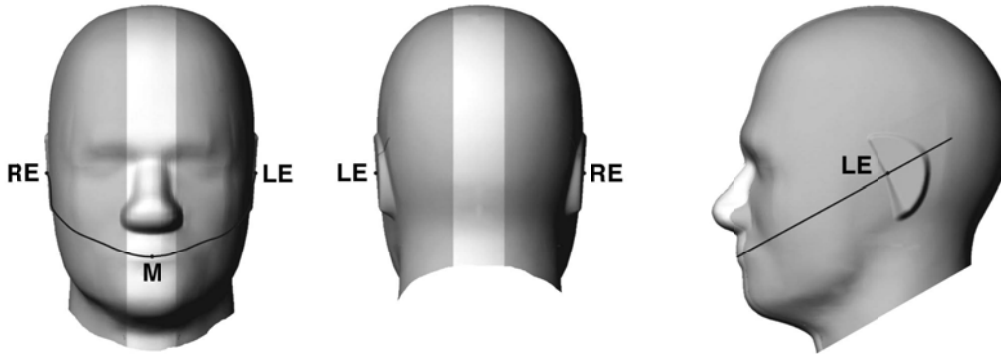

Fig 9.1.1 Front, back, and side views of SAM twin phantom

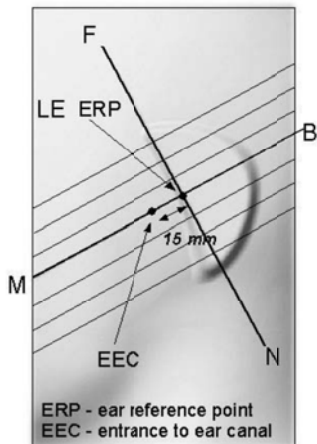

Fig 9.1.2 Close-up side view of phantom showing the ear region.

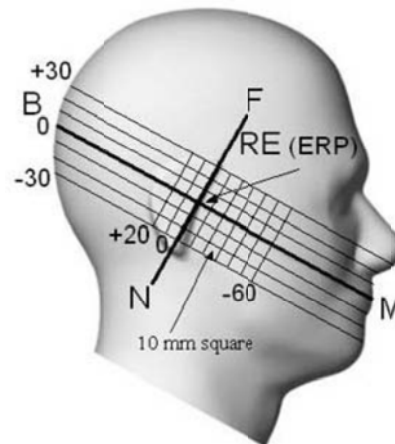

Fig 9.1.3 Side view of the phantom showing relevant markings and seven cross-sectional plane locations

11.2 Definition of the cheek position

1. Ready the handset for talk operation, if necessary. For example, for handsets with a cover piece (flip cover), open the cover. If the handset can transmit with the cover closed, both configurations must be tested.
2. Define two imaginary lines on the handset—the vertical centerline and the horizontal line. The vertical centerline passes through two points on the front side of the handset—the midpoint of the width w_t of the handset at the level of the acoustic output (point A in Figure 9.2.1 and Figure 9.2.2), and the midpoint of the width w_b of the bottom of the handset (point B). The horizontal line is perpendicular to the vertical centerline and passes through the center of the acoustic output (see Figure 9.2.1). The two lines intersect at point A. Note that for many handsets, point A coincides with the center of the acoustic output; however, the acoustic output may be located elsewhere on the horizontal line. Also note that the vertical centerline is not necessarily parallel to the front face of the handset (see Figure 9.2.2), especially for clamshell handsets, handsets with flip covers, and other irregularly-shaped handsets.
3. Position the handset close to the surface of the phantom such that point A is on the (virtual) extension of the line passing through points RE and LE on the phantom (see Figure 9.2.3), such that the plane defined by the vertical centerline and the horizontal line of the handset is approximately parallel to the sagittal plane of the phantom.
4. Translate the handset towards the phantom along the line passing through RE and LE until handset point A touches the pinna at the ERP.
5. While maintaining the handset in this plane, rotate it around the LE-RE line until the vertical centerline is in the plane normal to the plane containing B-M and N-F lines, i.e., the Reference Plane.
6. Rotate the handset around the vertical centerline until the handset (horizontal line) is parallel to the N-F line.
7. While maintaining the vertical centerline in the Reference Plane, keeping point A on the line passing through RE and LE, and maintaining the handset contact with the pinna, rotate the handset about the N-F line until any point on the handset is in contact with a phantom point below the pinna on the cheek. See Figure 9.2.3. The actual rotation angles should be documented in the test report.

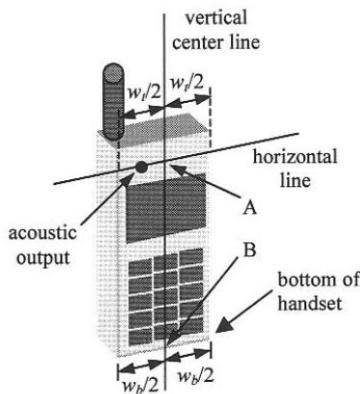

Fig 9.2.1 Handset vertical and horizontal reference lines—“fixed case”

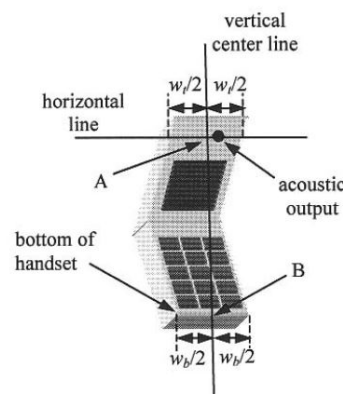

Fig 9.2.2 Handset vertical and horizontal reference lines—“clam-shell case”

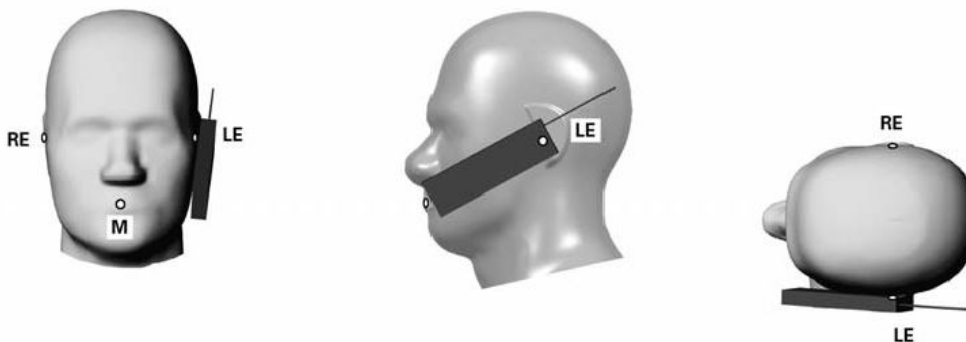

Fig 9.2.3 cheek or touch position. The reference points for the right ear (RE), left ear (LE), and mouth (M), which establish the Reference Plane for handset positioning, are indicated.

11.3 Definition of the tilt position

1. Ready the handset for talk operation, if necessary. For example, for handsets with a cover piece (flip cover), open the cover. If the handset can transmit with the cover closed, both configurations must be tested.
2. While maintaining the orientation of the handset, move the handset away from the pinna along the line passing through RE and LE far enough to allow a rotation of the handset away from the cheek by 15°.
3. Rotate the handset around the horizontal line by 15°.
4. While maintaining the orientation of the handset, move the handset towards the phantom on the line passing through RE and LE until any part of the handset touches the ear. The tilt position is obtained when the contact point is on the pinna. See Figure 9.3.1. If contact occurs at any location other than the pinna, e.g., the antenna at the back of the phantom head, the angle of the handset should be reduced. In this case, the tilt position is obtained if any point on the handset is in contact with the pinna and a second point

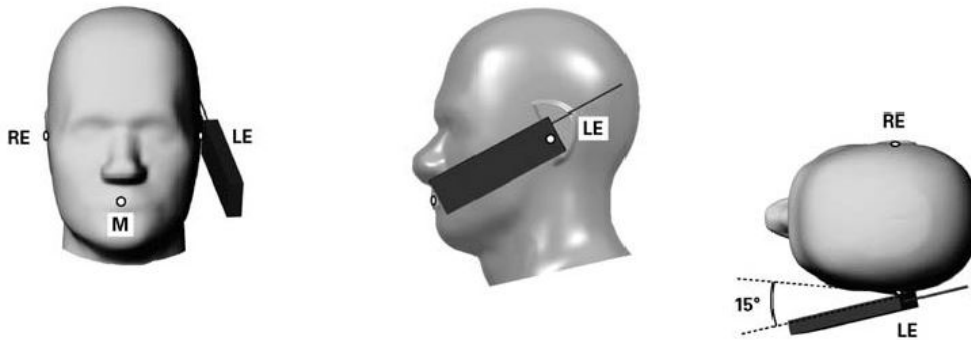

Fig 9.3.1 Tilt position. The reference points for the right ear (RE), left ear (LE), and mouth (M), which define the Reference Plane for handset positioning, are indicated.

11.4 Body Worn Accessory

Body-worn operating configurations are tested with the belt-clips and holsters attached to the device and positioned against a flat phantom in a normal use configuration (see Figure 9.4). Per KDB 648474 D04v01r02, body-worn accessory exposure is typically related to voice mode operations when handsets are carried in body-worn accessories. The body-worn accessory procedures in FCC KDB 447498 D01v05r02 should be used to test for body-worn accessory SAR compliance, without a headset connected to it. This enables the test results for such configuration to be compatible with that required for hotspot mode when the body-worn accessory test separation distance is greater than or equal to that required for hotspot mode, when applicable. When the reported SAR for body-worn accessory, measured without a headset connected to the handset is < 1.2 W/kg, the highest reported SAR configuration for that wireless mode and frequency band should be repeated for that body-worn accessory with a handset attached to the handset.

Accessories for body-worn operation configurations are divided into two categories: those that do not contain metallic components and those that do contain metallic components. When multiple accessories that do not contain metallic components are supplied with the device, the device is tested with only the accessory that dictates the closest spacing to the body. Then multiple accessories that contain metallic components are test with the device with each accessory. If multiple accessories share an identical metallic component (i.e. the same metallic belt-clip used with different holsters with no other metallic components) only the accessory that dictates the closest spacing to the body is tested.

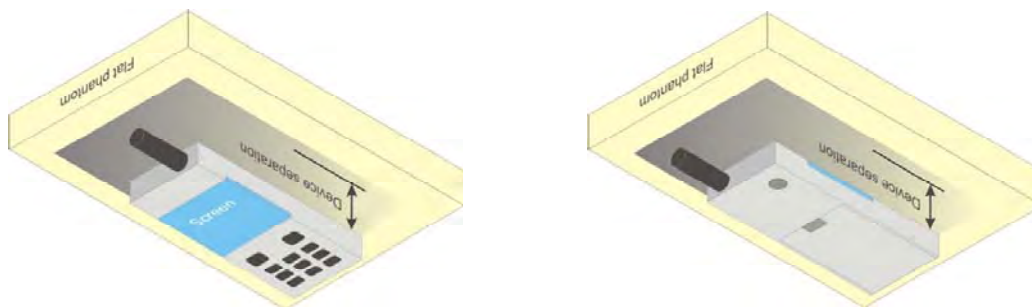

Fig 9.4 Body Worn Position

11.5 Wireless Router

Some battery-operated handsets have the capability to transmit and receive user through simultaneous transmission of WIFI simultaneously with a separate licensed transmitter. The FCC has provided guidance in FCC HDB Publication 941225 D06v01r01 where SAR test considerations for handsets (L x W ≥ 9 cm x 5 cm) are based on a composite test separation distance of 10mm from the front, back and edges of the device containing transmitting antennas within 2.5cm of their edges, determined from general mixed use conditions for this type of devices. Since the hotspot SAR results may overlap with the body-worn accessory SAR requirements, the more conservative configurations can be considered, thus excluding some body-worn accessory SAR tests.

When the user enables the personal wireless router functions for the handset, actual operations include simultaneous transmission of both the WIFI transmitter and another licensed transmitter. Both transmitters often do not transmit at the same transmitting frequency and thus cannot be evaluated for SAR under actual use conditions due to the limitations of the SAR assessment probes. Therefore, SAR must be evaluated for each frequency transmission and mode separately and spatially summed with the WIFI transmitter according to FCC KDB Publication 447498 D01v05r02 publication procedures. The "Portable Hotspot" feature on the handset was NOT activated during SAR assessments, to ensure the SAR measurements were evaluated for a single transmission frequency RF signal at a time.

12. Conducted RF Output Power (Unit: dBm)

<GSM Conducted Power>

1. Per KDB 447498 D01v05r02, the maximum output power channel is used for SAR testing and for further SAR test reduction.
2. According to October 2013TCB Workshop, For GSM / GPRS, the number of time slots to test for SAR should correspond to the highest source-based time-averaged maximum output power configuration, Considering the possibility of e.g. 3rd party VoIP operation for head and body-worn SAR testing, the EUT was set in GPRS (4Tx slots) for GSM850/GSM1900 band due to its highest frame-average power.
3. For hotspot mode SAR testing, GPRS should be evaluated, therefore the EUT was set in GPRS 4 Tx slots for GSM850/GSM1900 band due to its highest frame-average power.

SIM1:

Band GSM850	Burst Average Power (dBm)			Tune-up Limit (dBm)	Frame-Average Power (dBm)			Tune-up Limit (dBm)
	TX Channel	128	189		251	128	189	
Frequency (MHz)	824.2	836.4	848.8		824.2	836.4	848.8	
GSM (GMSK, 1 Tx slot)	31.15	31.06	31.03	31.5	22.15	22.06	22.03	22.5
GPRS (GMSK, 1 Tx slot) – CS1	31.13	31.05	31.04	31.5	22.13	22.05	22.04	22.5
GPRS (GMSK, 2 Tx slots) – CS1	30.81	30.72	30.71	31.0	24.81	24.72	24.71	25.0
GPRS (GMSK, 3 Tx slots) – CS1	29.78	29.68	29.66	30.0	25.52	25.42	25.40	25.74
GPRS (GMSK, 4 Tx slots) – CS1	28.92	28.87	28.83	29.5	25.92	25.87	25.83	26.5
Band GSM1900	Burst Average Power (dBm)			Tune-up Limit (dBm)	Frame-Average Power (dBm)			Tune-up Limit (dBm)
TX Channel	512	661	810		512	661	810	
Frequency (MHz)	1850.2	1880	1909.8		1850.2	1880	1909.8	
GSM (GMSK, 1 Tx slot)	28.46	28.51	28.44	29.0	19.46	19.51	19.44	20.0
GPRS (GMSK, 1 Tx slot) – CS1	28.43	28.45	28.42	29.0	19.43	19.45	19.42	20.0
GPRS (GMSK, 2 Tx slots) – CS1	28.03	28.05	27.98	28.5	22.03	22.05	21.98	22.5
GPRS (GMSK, 3 Tx slots) – CS1	26.87	26.89	26.84	27.0	22.61	22.63	22.58	22.74
GPRS (GMSK, 4 Tx slots) – CS1	26.02	26.04	26.01	27.0	23.02	23.04	23.01	24.0

Remark: The frame-averaged power is linearly scaled the maximum burst averaged power over 8 time slots.

The calculated method are shown as below:

Frame-averaged power = Maximum burst averaged power (1 Tx Slot) - 9 dB

Frame-averaged power = Maximum burst averaged power (2 Tx Slots) - 6 dB

Frame-averaged power = Maximum burst averaged power (3 Tx Slots) - 4.26 dB

Frame-averaged power = Maximum burst averaged power (4 Tx Slots) - 3 dB



SIM2:

Band GSM850	Burst Average Power (dBm)			Tune-up Limit (dBm)	Frame-Average Power (dBm)			Tune-up Limit (dBm)
	TX Channel	128	189		251	128	189	
Frequency (MHz)	824.2	836.4	848.8		824.2	836.4	848.8	
GSM (GMSK, 1 Tx slot)	31.14	31.03	31.02	31.5	22.14	22.03	22.02	22.5
GPRS (GMSK, 1 Tx slot) – CS1	31.11	31.03	31.01	31.5	22.11	22.03	22.01	22.5
GPRS (GMSK, 2 Tx slots) – CS1	30.78	30.66	30.66	31.0	24.78	24.66	24.66	25.0
GPRS (GMSK, 3 Tx slots) – CS1	29.68	29.59	29.55	30.0	25.42	25.33	25.29	25.74
GPRS (GMSK, 4 Tx slots) – CS1	28.81	28.75	28.80	29.5	25.81	25.75	25.80	26.5
Band GSM1900	Burst Average Power (dBm)			Tune-up Limit (dBm)	Frame-Average Power (dBm)			Tune-up Limit (dBm)
TX Channel	512	661	810		512	661	810	
Frequency (MHz)	1850.2	1880	1909.8		1850.2	1880	1909.8	
GSM (GMSK, 1 Tx slot)	28.45	28.48	28.43	29.0	19.45	19.48	19.43	20.0
GPRS (GMSK, 1 Tx slot) – CS1	28.42	28.44	28.40	29.0	19.42	19.44	19.40	20.0
GPRS (GMSK, 2 Tx slots) – CS1	27.98	27.99	27.97	28.5	21.98	21.99	21.97	22.5
GPRS (GMSK, 3 Tx slots) – CS1	26.76	26.85	26.74	27.0	22.50	22.59	22.48	22.74
GPRS (GMSK, 4 Tx slots) – CS1	26.01	26.03	25.90	27.0	23.01	23.03	22.90	24.0

Remark: The frame-averaged power is linearly scaled the maximum burst averaged power over 8 time slots.

The calculated method are shown as below:

- Frame-averaged power = Maximum burst averaged power (1 Tx Slot) - 9 dB
- Frame-averaged power = Maximum burst averaged power (2 Tx Slots) - 6 dB
- Frame-averaged power = Maximum burst averaged power (3 Tx Slots) - 4.26 dB
- Frame-averaged power = Maximum burst averaged power (4 Tx Slots) - 3 dB

<WCDMA Conducted Power>

1. The following tests were conducted according to the test requirements outlines in 3GPP TS 34.121 specification.
2. The procedures in KDB 941225 D01 are applied for 3GPP Rel. 6 HSPA to configure the device in the required sub-test mode(s) to determine SAR test exclusion.

A summary of these settings are illustrated below:

HSDPA Setup Configuration:

- a. The EUT was connected to Base Station Agilent E5515C referred to the Setup Configuration.
- b. The RF path losses were compensated into the measurements.
- c. A call was established between EUT and Base Station with following setting:
 - i. Set Gain Factors (β_c and β_d) and parameters were set according to each
 - ii. Specific sub-test in the following table, C10.1.4, quoted from the TS 34.121
 - iii. Set RMC 12.2Kbps + HSDPA mode.
 - iv. Set Cell Power = -86 dBm
 - v. Set HS-DSCH Configuration Type to FRC (H-set 1, QPSK)
 - vi. Select HSDPA Uplink Parameters
 - vii. Set Delta ACK, Delta NACK and Delta CQI = 8
 - viii. Set Ack-Nack Repetition Factor to 3
 - ix. Set CQI Feedback Cycle (k) to 4 ms
 - x. Set CQI Repetition Factor to 2
 - xi. Power Ctrl Mode = All Up bits
- d. The transmitted maximum output power was recorded.

Table C.10.1.4: β values for transmitter characteristics tests with HS-DPCCH

Sub-test	β_c	β_d	β_d (SF)	β_c/β_d	β_{HS} (Note 1, Note 2)	CM (dB) (Note 3)	MPR (dB) (Note 3)
1	2/15	15/15	64	2/15	4/15	0.0	0.0
2	12/15 (Note 4)	15/15 (Note 4)	64	12/15 (Note 4)	24/15	1.0	0.0
3	15/15	8/15	64	15/8	30/15	1.5	0.5
4	15/15	4/15	64	15/4	30/15	1.5	0.5

Note 1: $\Delta_{ACK}, \Delta_{NACK}$ and $\Delta_{CQI} = 30/15$ with $\beta_{HS} = 30/15 * \beta_c$.

Note 2: For the HS-DPCCH power mask requirement test in clause 5.2C, 5.7A, and the Error Vector Magnitude (EVM) with HS-DPCCH test in clause 5.13.1A, and HSDPA EVM with phase discontinuity in clause 5.13.1AA, Δ_{ACK} and $\Delta_{NACK} = 30/15$ with $\beta_{HS} = 30/15 * \beta_c$, and $\Delta_{CQI} = 24/15$ with $\beta_{HS} = 24/15 * \beta_c$.

Note 3: CM = 1 for $\beta_c/\beta_d = 12/15, \beta_{HS}/\beta_c = 24/15$. For all other combinations of DPDCCH, DPCCH and HS-DPCCH the MPR is based on the relative CM difference. This is applicable for only UEs that support HSDPA in release 6 and later releases.

Note 4: For subtest 2 the β_c/β_d ratio of 12/15 for the TFC during the measurement period (TF1, TF0) is achieved by setting the signalled gain factors for the reference TFC (TF1, TF1) to $\beta_c = 11/15$ and $\beta_d = 15/15$.

Setup Configuration

HSUPA Setup Configuration:

- a. The EUT was connected to Base Station Agilent E5515C referred to the Setup Configuration.
- b. The RF path losses were compensated into the measurements.
- c. A call was established between EUT and Base Station with following setting * :
 - i. Call Configs = 5.2B, 5.9B, 5.10B, and 5.13.2B with QPSK
 - ii. Set the Gain Factors (β_c and β_d) and parameters (AG Index) were set according to each specific sub-test in the following table, C11.1.3, quoted from the TS 34.121
 - iii. Set Cell Power = -86 dBm
 - iv. Set Channel Type = 12.2k + HSPA
 - v. Set UE Target Power
 - vi. Power Ctrl Mode= Alternating bits
 - vii. Set and observe the E-TFCl
 - viii. Confirm that E-TFCl is equal to the target E-TFCl of 75 for sub-test 1, and other subtest's E-TFCl
- d. The transmitted maximum output power was recorded.

Table C.11.1.3: β values for transmitter characteristics tests with HS-DPCCH and E-DCH

Sub-test	β_c	β_d	β_d (SF)	β_c/β_d	β_{HS} (Note 1)	β_{ec}	β_{ed} (Note 5) (Note 6)	β_{ed} (SF)	β_{ed} (Codes)	CM (dB) (Note 2)	MPR (dB) (Note 2)	AG Index (Note 6)	E-TFCl
1	11/15 (Note 3)	15/15 (Note 3)	64	11/15 (Note 3)	22/15	209/25	1309/225	4	1	1.0	0.0	20	75
2	6/15	15/15	64	6/15	12/15	12/15	94/75	4	1	3.0	2.0	12	67
3	15/15	9/15	64	15/9	30/15	30/15	$\beta_{ed1}: 47/15$ $\beta_{ed2}: 47/15$	4 4	2	2.0	1.0	15	92
4	2/15	15/15	64	2/15	4/15	2/15	56/75	4	1	3.0	2.0	17	71
5	15/15 (Note 4)	15/15 (Note 4)	64	15/15 (Note 4)	30/15	24/15	134/15	4	1	1.0	0.0	21	81

Note 1: $\Delta_{ACK}, \Delta_{NACK}$ and $\Delta_{CQI} = 30/15$ with $\beta_{hs} = 30/15 * \beta_c$.

Note 2: CM = 1 for $\beta_c/\beta_d = 12/15$, $\beta_{hs}/\beta_c = 24/15$. For all other combinations of DPDCH, DPCCH, HS- DPCCH, E-DPDCH and E-DPCCH the MPR is based on the relative CM difference.

Note 3: For subtest 1 the β_c/β_d ratio of 11/15 for the TFC during the measurement period (TF1, TF0) is achieved by setting the signalled gain factors for the reference TFC (TF1, TF1) to $\beta_c = 10/15$ and $\beta_d = 15/15$.

Note 4: For subtest 5 the β_c/β_d ratio of 15/15 for the TFC during the measurement period (TF1, TF0) is achieved by setting the signalled gain factors for the reference TFC (TF1, TF1) to $\beta_c = 14/15$ and $\beta_d = 15/15$.

Note 5: In case of testing by UE using E-DPDCH Physical Layer category 1, Sub-test 3 is omitted according to TS25.306 Table 5.1g.

Note 6: β_{ed} can not be set directly, it is set by Absolute Grant Value.

Setup Configuration



<WCDMA Conducted Power>

General Note:

1. SAR testing in AMR configuration is not required when the maximum average output of each RF channel for AMR 12.2Kbps is less than 0.25dB higher than that measured in RMC 12.2Kbps
2. Per KDB 941225 D02v02r02, RMC 12.2kbps setting is used to evaluate SAR. If HSDPA/HSUPA output power is < 0.25dB higher than RMC, or reported SAR with RMC 12.2kbps setting is ≤ 1.2W/kg, HSDPA/HSUPA SAR evaluation can be excluded..

SIM1:

Band			WCDMA Band V			Tune-up Limit (dBm)	WCDMA Band II			Tune-up Limit (dBm)
TX Channel			4132	4182	4233		9262	9400	9538	
Rx Channel			4357	4407	4458		9662	9800	9938	
Frequency (MHz)			826.4	836.4	846.6		1852.4	1880	1907.6	
MPR (dB)	3GPP Rel 99	AMR 12.2Kbps	21.03	21.04	21.11	22.5	21.36	21.38	21.25	23.0
	3GPP Rel 99	RMC 12.2Kbps	21.04	21.06	21.12	22.5	21.38	21.40	21.28	23.0
0	3GPP Rel 6	HSDPA Subtest-1	18.86	18.82	18.93	19.0	19.16	19.26	19.12	19.5
0	3GPP Rel 6	HSDPA Subtest-2	18.83	18.81	18.90	19.0	19.17	19.27	19.13	19.5
0.5	3GPP Rel 6	HSDPA Subtest-3	18.84	18.81	18.87	19.0	19.18	19.25	19.09	19.5
0.5	3GPP Rel 6	HSDPA Subtest-4	18.86	18.82	18.91	19.0	19.17	19.32	19.09	19.5
0	3GPP Rel 6	HSUPA Subtest-1	17.68	17.80	17.88	18.0	18.21	18.24	18.13	18.5
2	3GPP Rel 6	HSUPA Subtest-2	17.72	17.83	17.86	18.0	18.22	18.24	18.16	18.5
1	3GPP Rel 6	HSUPA Subtest-3	18.66	18.79	18.93	19.0	19.19	19.21	19.08	19.5
2	3GPP Rel 6	HSUPA Subtest-4	17.18	17.32	17.41	17.5	17.68	17.75	17.57	18.0
0	3GPP Rel 6	HSUPA Subtest-5	18.59	18.77	18.85	19.0	19.17	19.24	19.16	19.5

SIM2:

Band			WCDMA Band V			Tune-up Limit (dBm)	WCDMA Band II			Tune-up Limit (dBm)
TX Channel			4132	4182	4233		9262	9400	9538	
Rx Channel			4357	4407	4458		9662	9800	9938	
Frequency (MHz)			826.4	836.4	846.6		1852.4	1880	1907.6	
MPR (dB)	3GPP Rel 99	AMR 12.2Kbps	21.01	21.03	21.09	22.5	21.35	21.37	21.21	23.0
	3GPP Rel 99	RMC 12.2Kbps	21.03	21.05	21.10	22.5	21.37	21.38	21.27	23.0
0	3GPP Rel 6	HSDPA Subtest-1	18.83	18.81	18.92	19.0	19.14	19.25	19.13	19.5
0	3GPP Rel 6	HSDPA Subtest-2	18.80	18.80	18.89	19.0	19.13	19.23	19.17	19.5
0.5	3GPP Rel 6	HSDPA Subtest-3	18.82	18.78	18.85	19.0	19.16	19.20	19.11	19.5
0.5	3GPP Rel 6	HSDPA Subtest-4	18.85	18.76	18.96	19.0	19.15	19.28	19.06	19.5
0	3GPP Rel 6	HSUPA Subtest-1	17.66	17.77	17.82	18.0	18.20	18.22	18.11	18.5
2	3GPP Rel 6	HSUPA Subtest-2	17.76	17.79	17.81	18.0	18.18	18.20	18.14	18.5
1	3GPP Rel 6	HSUPA Subtest-3	18.69	18.70	18.92	19.0	19.22	19.19	19.12	19.5
2	3GPP Rel 6	HSUPA Subtest-4	17.14	17.30	17.45	17.5	17.73	17.73	17.55	18.0
0	3GPP Rel 6	HSUPA Subtest-5	18.60	18.74	18.83	19.0	19.24	19.20	19.13	19.5

<WLAN Conducted Power>

General Note:

For 2.4GHz WLAN SAR testing, highest average RF output power channel for the lowest data rate for 802.11b were selected for SAR evaluation. 802.11g/n HT20/HT40 were not investigated since the average output powers over all channels and data rates were not more than 0.25 dB higher than the tested channel in the lowest data rate of 802.11b mode.

<2.4GHz WLAN>

WLAN 2.4GHz 802.11b Average Power (dBm)							Tune up Limit (dBm)
Power vs. Channel			Power vs. Data Rate				
Channel	Frequency (MHz)	Data Rate 1Mbps	Channel	2Mbps	5.5Mbps	11Mbps	
CH 01	2412	14.37	CH 11	14.69	14.70	14.72	15.0
CH 06	2437	14.41					
CH 11	2462	14.78					

WLAN 2.4GHz 802.11g Average Power (dBm)											Tune up Limit (dBm)
Power vs. Channel			Power vs. Data Rate								
Channel	Frequency (MHz)	Data Rate 6Mbps	Channel	9Mbps	12Mbps	18Mbps	24Mbps	36Mbps	48Mbps	54Mbps	
CH 01	2412	12.39	CH 11	12.61	12.75	12.69	12.75	12.78	12.78	12.80	13.0
CH 06	2437	12.57									
CH 11	2462	12.81									

WLAN 2.4GHz 802.11n HT20 Average Power (dBm)											Tune up Limit (dBm)
Power vs. Channel			Power vs. MCS Index								
Channel	Frequency (MHz)	MCS Index MCS0	Channel	MCS1	MCS2	MCS3	MCS4	MCS5	MCS6	MCS7	
CH 01	2412	12.47	CH 11	12.73	12.79	12.84	12.85	12.80	12.67	12.73	13.0
CH 06	2437	12.50									
CH 11	2462	12.86									

WLAN 2.4GHz 802.11n-HT40 Average Power (dBm)											Tune up Limit (dBm)
Power vs. Channel			Power vs. MCS Index								
Channel	Frequency (MHz)	MCS Index MCS0	Channel	MCS1	MCS2	MCS3	MCS4	MCS5	MCS6	MCS7	
CH 3	2422	10.14	CH 06	12.27	12.35	12.27	12.12	12.33	12.30	12.22	10.5
CH 6	2437	12.36									12.5
CH 9	2452	10.27									10.5

13. Bluetooth Exclusions Applied

Mode Band	Average power(dBm)	
	Bluetooth v3.0+EDR	Bluetooth v4.0 LE
2.4GHz Bluetooth	5.0	-4.0

Note:

1. Per KDB 447498 D01v05r02, the 1-g and 10-g SAR test exclusion thresholds for 100 MHz to 6 GHz at *test separation distances* ≤ 50 mm are determined by:

$$[(\text{max. power of channel, including tune-up tolerance, mW}) / (\text{min. test separation distance, mm})] \cdot [\sqrt{f(\text{GHz})}] \leq 3.0 \text{ for 1-g SAR and } \leq 7.5 \text{ for 10-g extremity SAR}$$

- f(GHz) is the RF channel transmit frequency in GHz
- Power and distance are rounded to the nearest mW and mm before calculation
- The result is rounded to one decimal place for comparison

Bluetooth Max Power (dBm)	Separation Distance (mm)	Frequency (GHz)	exclusion thresholds
5.0	< 5	2.48	0.9

Note:

Per KDB 447498 D01v05r02, when the minimum test separation distance is < 5 mm, a distance of 5 mm is applied to determine SAR test exclusion. The test exclusion threshold is 0.9 which is ≤ 3, SAR testing is not required.

14. Antenna Location

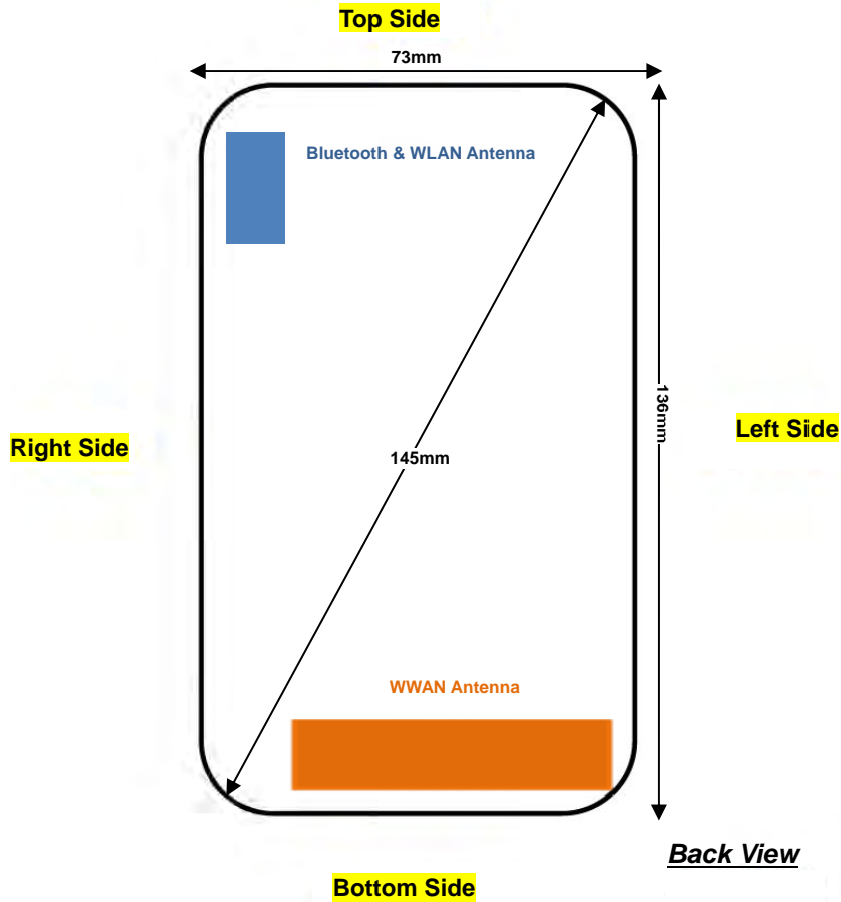

Distance of the Antenna to the EUT surface/edge						
Antennas	Back	Front	Top Side	Bottom Side	Right Side	Left Side
WWAN Main	≤ 25mm	≤ 25mm	103mm	≤ 25mm	≤25mm	≤25mm
BT&WLAN	≤ 25mm	≤ 25mm	≤ 25mm	100mm	≤25mm	51.5mm

Positions for SAR tests; Hotspot mode						
Antennas	Back	Front	Top Side	Bottom Side	Right Side	Left Side
WWAN Main	Yes	Yes	No	Yes	Yes	Yes
BT&WLAN	Yes	Yes	Yes	No	Yes	No

General Note:

Referring to KDB 941225 D06 v01r01, when the overall device length and width are ≥ 9cm*5cm, the test distance is 10 mm. SAR must be measured for all sides and surfaces with a transmitting antenna located within 25mm from that surface or edge

15. SAR Test Results

General Note:

1. Per KDB 447498 D01v05r02, the reported SAR is the measured SAR value adjusted for maximum tune-up tolerance.
 - a. Tune-up scaling Factor = tune-up limit power (mW) / EUT RF power (mW), where tune-up limit is the maximum rated power among all production units.
 - b. Reported SAR(W/kg)= Measured SAR(W/kg)*Tune-up Scaling Factor
2. Per KDB 447498 D01v05r02, for each exposure position, testing of other required channels within the operating mode of a frequency band is not required when the *reported* 1-g or 10-g SAR for the mid-band or highest output power channel is:
 - ≤ 0.8 W/kg or 2.0 W/kg, for 1-g or 10-g respectively, when the transmission band is ≤ 100 MHz
 - ≤ 0.6 W/kg or 1.5 W/kg, for 1-g or 10-g respectively, when the transmission band is between 100 MHz and 200 MHz
 - ≤ 0.4 W/kg or 1.0 W/kg, for 1-g or 10-g respectively, when the transmission band is ≥ 200 MHz
3. According to October 2013TCB Workshop, For GSM / GPRS, the number of time slots to test for SAR should correspond to the highest source-based time-averaged maximum output power configuration, Considering the possibility of e.g. 3rd party VoIP operation for head and body-worn SAR testing, the EUT was set in GPRS (4Tx slots) for GSM850 / GSM1900 band due to its highest frame-average power.
4. For hotspot mode SAR testing, GPRS and EDGE should be evaluated, therefore the EUT was set in GPRS 4 Tx slots for GSM850 / GSM1900 band due to its highest frame-average power.
5. Pre KDB648474 D04v01r02, when the reported SAR for a body-worn accessory, measured without a headset connected to the handset, is > 1.2 W/kg, the highest reported SAR configuration for that wireless mode and frequency band should be repeated for that body-worn accessory with a headset attached to the handset.
6. Per KDB 941225 D02v02r02, RMC 12.2kbps setting is used to evaluate SAR. If HSDPA/HSUPA output power is < 0.25 dB higher than RMC, or reported SAR with RMC 12.2kbps setting is ≤ 1.2 W/kg, HSDPA/HSUPA SAR evaluation can be excluded..
7. This device 2.4GHz WLAN supports Hotspot operation.
8. Additional WLAN SAR with headset testing was performed for simultaneous transmission analysis.

15.1 Head SAR

<GSM SAR>

Plot No.	Band	Mode	Test Position	Ch.	Freq. (MHz)	Average Power (dBm)	Tune-Up Limit (dBm)	Tune-up Scaling Factor	Power Drift (dB)	Measured 1g SAR (W/kg)	Reported 1g SAR (W/kg)
#01	GSM850	GPRS(GMSK 4 TX slots)	Right Cheek	128	824.2	28.92	29.50	1.143	0.08	0.523	0.598
	GSM850	GPRS(GMSK 4 TX slots)	Right Tilted	128	824.2	28.92	29.50	1.143	0.17	0.309	0.353
	GSM850	GPRS(GMSK 4 TX slots)	Left Cheek	128	824.2	28.92	29.50	1.143	0.19	0.443	0.506
	GSM850	GPRS(GMSK 4 TX slots)	Left Tilted	128	824.2	28.92	29.50	1.143	0.14	0.310	0.354
#02	GSM1900	GPRS(GMSK 4 TX slots)	Right Cheek	661	1880	26.04	27.00	1.247	-0.04	0.325	0.405
	GSM1900	GPRS(GMSK 4 TX slots)	Right Tilted	661	1880	26.04	27.00	1.247	0.1	0.087	0.109
	GSM1900	GPRS(GMSK 4 TX slots)	Left Cheek	661	1880	26.04	27.00	1.247	0.01	0.262	0.327
	GSM1900	GPRS(GMSK 4 TX slots)	Left Tilted	661	1880	26.04	27.00	1.247	0.07	0.063	0.079

<WCDMA SAR>

Plot No.	Band	Mode	Test Position	Ch.	Freq. (MHz)	Average Power (dBm)	Tune-Up Limit (dBm)	Tune-up Scaling Factor	Power Drift (dB)	Measured 1g SAR (W/kg)	Reported 1g SAR (W/kg)
	WCDMA Band V	RMC 12.2K	Right Cheek	4233	846.6	21.12	22.50	1.374	0.01	0.238	0.327
	WCDMA Band V	RMC 12.2K	Right Tilted	4233	846.6	21.12	22.50	1.374	0.02	0.175	0.240
#03	WCDMA Band V	RMC 12.2K	Left Cheek	4233	846.6	21.12	22.50	1.374	0.03	0.239	0.328
	WCDMA Band V	RMC 12.2K	Left Tilted	4233	846.6	21.12	22.50	1.374	0.01	0.155	0.213
#04	WCDMA Band II	RMC 12.2K	Right Cheek	9400	1880	21.40	23.00	1.445	0.04	0.254	0.367
	WCDMA Band II	RMC 12.2K	Right Tilted	9400	1880	21.40	23.00	1.445	0.16	0.069	0.100
	WCDMA Band II	RMC 12.2K	Left Cheek	9400	1880	21.40	23.00	1.445	0.07	0.213	0.308
	WCDMA Band II	RMC 12.2K	Left Tilted	9400	1880	21.40	23.00	1.445	0.01	0.048	0.069

<DTS WLAN SAR>

Plot No.	Band	Mode	Test Position	Ch.	Freq. (MHz)	Average Power (dBm)	Tune-Up Limit (dBm)	Tune-up Scaling Factor	Power Drift (dB)	Measured 1g SAR (W/kg)	Reported 1g SAR (W/kg)
	WLAN2.4GHz	802.11b 1Mbps	Right Cheek	11	2462	14.78	15.00	1.052	0.17	0.041	0.043
	WLAN2.4GHz	802.11b 1Mbps	Right Tilted	11	2462	14.78	15.00	1.052	0.06	0.025	0.026
#05	WLAN2.4GHz	802.11b 1Mbps	Left Cheek	11	2462	14.78	15.00	1.052	0.05	0.155	0.163
	WLAN2.4GHz	802.11b 1Mbps	Left Tilted	11	2462	14.78	15.00	1.052	0.07	0.071	0.075

15.2 Hotspot SAR

Distance of the Antenna to the EUT surface/edge						
Antennas	Back	Front	Top Side	Bottom Side	Right Side	Left Side
WWAN Main	≤ 25mm	≤ 25mm	103mm	≤ 25mm	≤25mm	≤25mm
BT&WLAN	≤ 25mm	≤ 25mm	≤ 25mm	100mm	≤25mm	51.5mm

Positions for SAR tests; Hotspot mode						
Antennas	Back	Front	Top Side	Bottom Side	Right Side	Left Side
WWAN Main	Yes	Yes	No	Yes	Yes	Yes
BT&WLAN	Yes	Yes	Yes	No	Yes	No

General Note:

Referring to KDB 941225 D06 v01r01, when the overall device length and width are ≥ 9cm*5cm, the test distance is 10 mm. SAR must be measured for all sides and surfaces with a transmitting antenna located within 25mm from that surface or edge

<GSM SAR>

Plot No.	Band	Mode	Test Position	Gap (cm)	Ch.	Freq. (MHz)	Average Power (dBm)	Tune-Up Limit (dBm)	Tune-up Scaling Factor	Power Drift (dB)	Measured 1g SAR (W/kg)	Reported 1g SAR (W/kg)
	GSM850	GPRS(GMSK 4 TX slots)	Front	1	128	824.2	28.92	29.50	1.143	0.03	0.594	0.679
	GSM850	GPRS(GMSK 4 TX slots)	Back	1	128	824.2	28.92	29.50	1.143	0.03	1.120	1.280
	GSM850	GPRS(GMSK 4 TX slots)	Left side	1	128	824.2	28.92	29.50	1.143	0.06	0.914	1.045
	GSM850	GPRS(GMSK 4 TX slots)	Right side	1	128	824.2	28.92	29.50	1.143	0.05	0.939	1.073
	GSM850	GPRS(GMSK 4 TX slots)	Bottom side	1	128	824.2	28.92	29.50	1.143	-0.02	0.066	0.075
#06	GSM850	GPRS(GMSK 4 TX slots)	Back	1	189	836.4	28.87	29.50	1.156	-0.01	1.200	1.387
	GSM850	GPRS(GMSK 4 TX slots)	Back	1	251	848.8	28.83	29.50	1.167	0.03	1.140	1.330
	GSM850	GPRS(GMSK 4 TX slots)	Left side	1	189	836.4	28.87	29.50	1.156	0.03	0.957	1.106
	GSM850	GPRS(GMSK 4 TX slots)	Left side	1	251	848.8	28.83	29.50	1.167	0.1	0.948	1.106
	GSM850	GPRS(GMSK 4 TX slots)	Right side	1	189	836.4	28.87	29.50	1.156	0.07	0.918	1.061
	GSM850	GPRS(GMSK 4 TX slots)	Right side	1	251	848.8	28.83	29.50	1.167	0.02	0.874	1.020
	GSM1900	GPRS(GMSK 4 TX slots)	Front	1	661	1880	26.04	27.00	1.247	0.02	0.394	0.491
#07	GSM1900	GPRS(GMSK 4 TX slots)	Back	1	661	1880	26.04	27.00	1.247	0.01	0.619	0.772
	GSM1900	GPRS(GMSK 4 TX slots)	Left side	1	661	1880	26.04	27.00	1.247	0.03	0.112	0.140
	GSM1900	GPRS(GMSK 4 TX slots)	Right side	1	661	1880	26.04	27.00	1.247	0.04	0.190	0.237
	GSM1900	GPRS(GMSK 4 TX slots)	Bottom side	1	661	1880	26.04	27.00	1.247	0.03	0.565	0.705



<WCDMA SAR>

Plot No.	Band	Mode	Test Position	Gap (cm)	Ch.	Freq. (MHz)	Average Power (dBm)	Tune-Up Limit (dBm)	Tune-up Scaling Factor	Power Drift (dB)	Measured 1g SAR (W/kg)	Reported 1g SAR (W/kg)
	WCDMA Band V	RMC 12.2K	Front	1	4233	846.6	21.12	22.50	1.374	0.01	0.295	0.405
#08	WCDMA Band V	RMC 12.2K	Back	1	4233	846.6	21.12	22.50	1.374	0.03	0.469	0.644
	WCDMA Band V	RMC 12.2K	Left side	1	4233	846.6	21.12	22.50	1.374	0.03	0.337	0.463
	WCDMA Band V	RMC 12.2K	Right side	1	4233	846.6	21.12	22.50	1.374	0.03	0.312	0.429
	WCDMA Band V	RMC 12.2K	Bottom side	1	4233	846.6	21.12	22.50	1.374	0.03	0.035	0.048
	WCDMA Band II	RMC 12.2K	Front	1	9400	1880	21.40	23.00	1.445	-0.07	0.305	0.441
#09	WCDMA Band II	RMC 12.2K	Back	1	9400	1880	21.40	23.00	1.445	0.05	0.473	0.684
	WCDMA Band II	RMC 12.2K	Left side	1	9400	1880	21.40	23.00	1.445	-0.07	0.086	0.124
	WCDMA Band II	RMC 12.2K	Right side	1	9400	1880	21.40	23.00	1.445	0.04	0.156	0.225
	WCDMA Band II	RMC 12.2K	Bottom side	1	9400	1880	21.40	23.00	1.445	-0.07	0.437	0.632

<DTS WLAN SAR>

Plot No.	Band	Mode	Test Position	Gap (cm)	Ch.	Freq. (MHz)	Average Power (dBm)	Tune-Up Limit (dBm)	Tune-up Scaling Factor	Power Drift (dB)	Measured 1g SAR (W/kg)	Reported 1g SAR (W/kg)
	WLAN2.4GHz	802.11b 1Mbps	Front	1	11	2462	14.78	15.00	1.052	-0.04	0.026	0.027
#10	WLAN2.4GHz	802.11b 1Mbps	Back	1	11	2462	14.78	15.00	1.052	-0.02	0.108	0.114
	WLAN2.4GHz	802.11b 1Mbps	Right side	1	11	2462	14.78	15.00	1.052	0.09	0.103	0.108
	WLAN2.4GHz	802.11b 1Mbps	Top side	1	11	2462	14.78	15.00	1.052	0.15	0.012	0.013

15.3 Body Worn Accessory SAR

<GSM SAR>

Plot No.	Band	Mode	Test Position	Gap (cm)	Ch.	Freq. (MHz)	Average Power (dBm)	Tune-Up Limit (dBm)	Tune-up Scaling Factor	Power Drift (dB)	Measured 1g SAR (W/kg)	Reported 1g SAR (W/kg)
	GSM850	GPRS(GMSK 4 TX slots)	Front	1	128	824.2	28.92	29.50	1.143	0.03	0.594	0.679
	GSM850	GPRS(GMSK 4 TX slots)	Back	1	128	824.2	28.92	29.50	1.143	0.03	1.120	1.280
#06	GSM850	GPRS(GMSK 4 TX slots)	Back	1	189	836.4	28.87	29.50	1.156	-0.01	1.200	1.387
	GSM850	GPRS(GMSK 4 TX slots)	Back	1	251	848.8	28.83	29.50	1.167	0.03	1.140	1.330
	GSM850	GPRS(GMSK 4 TX slots)	Back with headset	1	189	836.4	28.87	29.50	1.156	0.03	0.867	1.002
	GSM850	GPRS(GMSK 4 TX slots)	Back with headset	1	128	824.2	28.92	29.50	1.143	-0.03	0.868	0.992
	GSM850	GPRS(GMSK 4 TX slots)	Back with headset	1	251	848.8	28.83	29.50	1.167	0.01	0.876	1.022
	GSM1900	GPRS(GMSK 4 TX slots)	Front	1	661	1880	26.04	27.00	1.247	0.02	0.394	0.491
#07	GSM1900	GPRS(GMSK 4 TX slots)	Back	1	661	1880	26.04	27.00	1.247	0.01	0.619	0.772

<WCDMA SAR>

Plot No.	Band	Mode	Test Position	Gap (cm)	Ch.	Freq. (MHz)	Average Power (dBm)	Tune-Up Limit (dBm)	Tune-up Scaling Factor	Power Drift (dB)	Measured 1g SAR (W/kg)	Reported 1g SAR (W/kg)
	WCDMA Band V	RMC 12.2K	Front	1	4233	846.6	21.12	22.50	1.374	0.01	0.295	0.405
#08	WCDMA Band V	RMC 12.2K	Back	1	4233	846.6	21.12	22.50	1.374	0.03	0.469	0.644
	WCDMA Band II	RMC 12.2K	Front	1	9400	1880	21.40	23.00	1.445	-0.07	0.305	0.441
#09	WCDMA Band II	RMC 12.2K	Back	1	9400	1880	21.40	23.00	1.445	0.05	0.473	0.684

<DTS WLAN SAR>

Plot No.	Band	Mode	Test Position	Gap (cm)	Ch.	Freq. (MHz)	Average Power (dBm)	Tune-Up Limit (dBm)	Tune-up Scaling Factor	Power Drift (dB)	Measured 1g SAR (W/kg)	Reported 1g SAR (W/kg)
	WLAN2.4GHz	802.11b 1Mbps	Front	1	11	2462	14.78	15.00	1.052	-0.04	0.026	0.027
	WLAN2.4GHz	802.11b 1Mbps	Back	1	11	2462	14.78	15.00	1.052	-0.02	0.108	0.114
#11	WLAN2.4GHz	802.11b 1Mbps	Back with headset	1	11	2462	14.78	15.00	1.052	0.01	0.109	0.115

15.4 Repeated SAR Measurement

No.	Band	Mode	Test Position	Gap (cm)	Ch.	Freq. (MHz)	Average Power (dBm)	Tune-Up Limit (dBm)	Tune-up Scaling Factor	Power Drift (dB)	Measured 1g SAR (W/kg)	Ratio	Reported 1g SAR (W/kg)
1st	GSM850	GPRS(GMSK 4 TX slots)	Back	1	189	836.4	28.87	29.50	1.156	-0.01	1.200	1	1.387
2nd	GSM850	GPRS(GMSK 4 TX slots)	Back	1	189	836.4	28.87	29.50	1.156	-0.03	1.150	1.043	1.330

General Note:

1. Per KDB 865664 D01v01r03, for each frequency band, repeated SAR measurement is required only when the measured SAR is ≥ 0.8 W/kg
2. Per KDB 865664 D01v01r03, if the ratio among the repeated measurement is ≤ 1.2 and the measured SAR < 1.45 W/kg, only one repeated measurement is required.
3. The ratio is the difference in percentage between original and repeated *measured* SAR.
4. All measurement SAR result is scaled-up to account for tune-up tolerance and is compliant.

16. Simultaneous Transmission Analysis

NO.	Simultaneous Transmission Configurations	Portable Handset			Note
		Head	Body-worn	Hotspot	
1.	GSM(Voice) + WLAN2.4GHz(data)	Yes	Yes		
2.	WCDMA(Voice) + WLAN2.4GHz(data)	Yes	Yes		
3.	GSM(Voice) + Bluetooth(data)	Yes	Yes		
4.	WCDMA((Voice) + Bluetooth(data)	Yes	Yes		
5.	GPRS(Data) + WLAN2.4GHz(data)	Yes	Yes	Yes	2.4GHz Hotspot
6.	WCDMA(Data) + WLAN2.4GHz(data)	Yes	Yes	Yes	2.4GHz Hotspot
7.	GPRS (Data) + Bluetooth(data)	Yes	Yes	Yes	Bluetooth Tethering
8.	WCDMA(Data) + Bluetooth(data)	Yes	Yes	Yes	Bluetooth Tethering

General Note:

1. This device supported VoIP in GPRS WCDMA (e.g. 3rd party VoIP).
2. This device 2.4GHz WLAN supports Hotspot operation.
3. WLAN 2.4GHz and Bluetooth share the same antenna, and cannot transmit simultaneously.
4. The Scaled SAR summation is calculated based on the same configuration and test position.
5. Per KDB 447498 D01v05r02, simultaneous transmission SAR is compliant if,
 - i) Scalar SAR summation < 1.6W/kg.
 - ii) $SPLSR = (SAR_1 + SAR_2)^{1.5} / (min. \text{ separation distance, mm})$, and the peak separation distance is determined from the square root of $[(x_1-x_2)^2 + (y_1-y_2)^2 + (z_1-z_2)^2]$, where (x_1, y_1, z_1) and (x_2, y_2, z_2) are the coordinates of the extrapolated peak SAR locations in the zoom scan. If $SPLSR \leq 0.04$, simultaneously transmission SAR measurement is not necessary.
 - iii) Simultaneously transmission SAR measurement, and the reported multi-band SAR < 1.6W/kg.
6. For simultaneous transmission analysis, Bluetooth SAR is estimated per KDB 447498 D01v05r02 based on the formula below.
 - i) $(max. \text{ power of channel, including tune-up tolerance, mW}) / (min. \text{ test separation distance, mm}) \cdot [\sqrt{f(\text{GHz})} / x] \text{ W/kg}$ for test separation distances $\leq 50 \text{ mm}$; where $x = 7.5$ for 1-g SAR, and $x = 18.75$ for 10-g SAR.
 - ii) When the minimum separation distance is < 5mm, the distance is used 5mm to determine SAR test exclusion.
 - iii) 0.4 W/kg for 1-g SAR and 1.0 W/kg for 10-g SAR, when the test separation distances is > 50 mm.

Bluetooth Max Power	Exposure Position	Head	Hotspot	Body worn
	Test separation	0 mm	10 mm	10 mm
5.0 dBm	Estimated SAR (W/kg)	0.126 W/kg	0.063 W/kg	0.063 W/kg



16.1 Head Exposure Conditions

<WWAN PCE + WLAN DTS>

WWAN Band		Exposure Position	WWAN PCE	WLAN DTS	Summed SAR (W/kg)	SPLSR	Case No
			WWAN SAR (W/kg)	WLAN SAR (W/kg)			
GSM	GSM850	Right Cheek	0.598	0.043	0.64		
		Right Tilted	0.353	0.026	0.38		
		Left Cheek	0.506	0.163	0.67		
		Left Tilted	0.354	0.075	0.43		
	GSM1900	Right Cheek	0.405	0.043	0.45		
		Right Tilted	0.109	0.026	0.14		
		Left Cheek	0.327	0.163	0.49		
		Left Tilted	0.079	0.075	0.15		
WCDMA	Band V	Right Cheek	0.327	0.043	0.37		
		Right Tilted	0.240	0.026	0.27		
		Left Cheek	0.328	0.163	0.49		
		Left Tilted	0.213	0.075	0.29		
	Band II	Right Cheek	0.367	0.043	0.41		
		Right Tilted	0.100	0.026	0.13		
		Left Cheek	0.308	0.163	0.47		
		Left Tilted	0.069	0.075	0.14		

<WWAN PCE + Bluetooth DSS>

WWAN Band		Exposure Position	WWAN PCE	Bluetooth DSS	Summed SAR (W/kg)	SPLSR	Case No
			WWAN SAR (W/kg)	Estimated SAR (W/kg)			
GSM	GSM850	Right Cheek	0.598	0.126	0.72		
		Right Tilted	0.353	0.126	0.48		
		Left Cheek	0.506	0.126	0.63		
		Left Tilted	0.354	0.126	0.48		
	GSM1900	Right Cheek	0.405	0.126	0.53		
		Right Tilted	0.109	0.126	0.24		
		Left Cheek	0.327	0.126	0.45		
		Left Tilted	0.079	0.126	0.21		
WCDMA	Band V	Right Cheek	0.327	0.126	0.45		
		Right Tilted	0.240	0.126	0.37		
		Left Cheek	0.328	0.126	0.45		
		Left Tilted	0.213	0.126	0.34		
	Band II	Right Cheek	0.367	0.126	0.49		
		Right Tilted	0.100	0.126	0.23		
		Left Cheek	0.308	0.126	0.43		
		Left Tilted	0.069	0.126	0.20		

16.2 Hotspot Exposure Conditions

<WWAN PCE+ WLAN DTS>

WWAN Band		Exposure Position	WWAN PCE	WLAN DTS	Summed SAR (W/kg)	SPLSR	Case No
			WWAN SAR (W/kg)	WLAN SAR (W/kg)			
GSM	GSM850	Front	0.679	0.027	0.71		
		Back	1.387	0.114	1.50		
		Left side	1.106		1.11		
		Right side	1.073	0.108	1.18		
		Top side		0.013	0.01		
		Bottom side	0.075		0.08		
	GSM1900	Front	0.491	0.027	0.52		
		Back	0.772	0.114	0.89		
		Left side	0.140		0.14		
		Right side	0.237	0.108	0.35		
		Top side		0.013	0.01		
		Bottom side	0.705		0.71		
WCMDA	Band V	Front	0.405	0.027	0.43		
		Back	0.644	0.114	0.76		
		Left side	0.463		0.46		
		Right side	0.429	0.108	0.54		
		Top side		0.013	0.01		
		Bottom side	0.048		0.05		
	Band II	Front	0.441	0.027	0.47		
		Back	0.684	0.114	0.80		
		Left side	0.124		0.12		
		Right side	0.225	0.108	0.33		
		Top side		0.013	0.01		
		Bottom side	0.632		0.63		

<WWAN PCE+ Bluetooth DSS>

WWAN Band		Exposure Position	WWAN PCE	Bluetooth DSS	Summed SAR (W/kg)	SPLSR	Case No
			WWAN SAR (W/kg)	Estimated SAR (W/kg)			
GSM	GSM850	Front	0.679	0.063	0.74		
		Back	1.387	0.063	1.45		
		Left side	1.106		1.11		
		Right side	1.073	0.063	1.14		
		Top side		0.063	0.06		
		Bottom side	0.075		0.08		
	GSM1900	Front	0.491	0.063	0.55		
		Back	0.772	0.063	0.84		
		Left side	0.140		0.14		
		Right side	0.237	0.063	0.30		
		Top side		0.063	0.06		
		Bottom side	0.705		0.71		
WCMDA	Band V	Front	0.405	0.063	0.47		
		Back	0.644	0.063	0.71		
		Left side	0.463		0.46		
		Right side	0.429	0.063	0.49		
		Top side		0.063	0.06		
		Bottom side	0.048		0.05		
	Band II	Front	0.441	0.063	0.50		
		Back	0.684	0.063	0.75		
		Left side	0.124		0.12		
		Right side	0.225	0.063	0.29		
		Top side		0.063	0.06		
		Bottom side	0.632		0.63		

16.3 Body-Worn Accessory Exposure Conditions

< WWAN PCE+ WLAN DTS >

WWAN Band		Exposure Position	WWAN PCE	WLAN DTS	Summed SAR (W/kg)	SPLSR	Case No
			WWAN SAR (W/kg)	WLAN SAR (W/kg)			
GSM	GSM850	Front	0.679	0.027	0.71		
		Back	1.387	0.114	1.50		
		Back with Headset	1.022	0.115	1.14		
	GSM1900	Front	0.491	0.027	0.52		
		Back	0.772	0.114	0.89		
WCMDA	Band V	Front	0.405	0.027	0.43		
		Back	0.644	0.114	0.76		
	Band II	Front	0.441	0.027	0.47		
		Back	0.684	0.114	0.80		

<WWAN PCE+ Bluetooth DSS>

WWAN Band		Exposure Position	WWAN PCE	Bluetooth DSS	Summed SAR (W/kg)	SPLSR	Case No
			WWAN SAR (W/kg)	Estimated SAR (W/kg)			
GSM	GSM850	Front	0.679	0.063	0.74		
		Back	1.387	0.063	1.45		
		Back with Headset	1.022	0.063	1.09		
	GSM1900	Front	0.491	0.063	0.55		
		Back	0.772	0.063	0.84		
WCMDA	Band V	Front	0.405	0.063	0.47		
		Back	0.644	0.063	0.71		
	Band II	Front	0.441	0.063	0.50		
		Back	0.684	0.063	0.75		

Test Engineer : Kat Yin

17. Uncertainty Assessment

The component of uncertainty may generally be categorized according to the methods used to evaluate them. The evaluation of uncertainty by the statistical analysis of a series of observations is termed a Type A evaluation of uncertainty. The evaluation of uncertainty by means other than the statistical analysis of a series of observation is termed a Type B evaluation of uncertainty. Each component of uncertainty, however evaluated, is represented by an estimated standard deviation, termed standard uncertainty, which is determined by the positive square root of the estimated variance.

A Type A evaluation of standard uncertainty may be based on any valid statistical method for treating data. This includes calculating the standard deviation of the mean of a series of independent observations; using the method of least squares to fit a curve to the data in order to estimate the parameter of the curve and their standard deviations; or carrying out an analysis of variance in order to identify and quantify random effects in certain kinds of measurement.

A type B evaluation of standard uncertainty is typically based on scientific judgment using all of the relevant information available. These may include previous measurement data, experience, and knowledge of the behavior and properties of relevant materials and instruments, manufacture’s specification, data provided in calibration reports and uncertainties assigned to reference data taken from handbooks. Broadly speaking, the uncertainty is either obtained from an outdoor source or obtained from an assumed distribution, such as the normal distribution, rectangular or triangular distributions indicated in table below.

Uncertainty Distributions	Normal	Rectangular	Triangular	U-Shape
Multi-plying Factor ^(a)	1/k ^(b)	1/√3	1/√6	1/√2

(a) standard uncertainty is determined as the product of the multiplying factor and the estimated range of variations in the measured quantity

(b) κ is the coverage factor

Table 17.1. Standard Uncertainty for Assumed Distribution

The combined standard uncertainty of the measurement result represents the estimated standard deviation of the result. It is obtained by combining the individual standard uncertainties of both Type A and Type B evaluation using the usual “root-sum-squares” (RSS) methods of combining standard deviations by taking the positive square root of the estimated variances.

Expanded uncertainty is a measure of uncertainty that defines an interval about the measurement result within which the measured value is confidently believed to lie. It is obtained by multiplying the combined standard uncertainty by a coverage factor. Typically, the coverage factor ranges from 2 to 3. Using a coverage factor allows the true value of a measured quantity to be specified with a defined probability within the specified uncertainty range. For purpose of this document, a coverage factor two is used, which corresponds to confidence interval of about 95 %. The DASY uncertainty Budget is shown in the following tables.

Error Description	Uncertainty Value (±%)	Probability Distribution	Divisor	Ci (1g)	Ci (10g)	Standard Uncertainty (1g)	Standard Uncertainty (10g)
Measurement System							
Probe Calibration	6.0	Normal	1	1	1	± 6.0 %	± 6.0 %
Axial Isotropy	4.7	Rectangular	√3	0.7	0.7	± 1.9 %	± 1.9 %
Hemispherical Isotropy	9.6	Rectangular	√3	0.7	0.7	± 3.9 %	± 3.9 %
Boundary Effects	1.0	Rectangular	√3	1	1	± 0.6 %	± 0.6 %
Linearity	4.7	Rectangular	√3	1	1	± 2.7 %	± 2.7 %
System Detection Limits	1.0	Rectangular	√3	1	1	± 0.6 %	± 0.6 %
Readout Electronics	0.3	Normal	1	1	1	± 0.3 %	± 0.3 %
Response Time	0.8	Rectangular	√3	1	1	± 0.5 %	± 0.5 %
Integration Time	2.6	Rectangular	√3	1	1	± 1.5 %	± 1.5 %
RF Ambient Noise	3.0	Rectangular	√3	1	1	± 1.7 %	± 1.7 %
RF Ambient Reflections	3.0	Rectangular	√3	1	1	± 1.7 %	± 1.7 %
Probe Positioner	0.4	Rectangular	√3	1	1	± 0.2 %	± 0.2 %
Probe Positioning	2.9	Rectangular	√3	1	1	± 1.7 %	± 1.7 %
Max. SAR Eval.	1.0	Rectangular	√3	1	1	± 0.6 %	± 0.6 %
Test Sample Related							
Device Positioning	2.9	Normal	1	1	1	± 2.9 %	± 2.9 %
Device Holder	3.6	Normal	1	1	1	± 3.6 %	± 3.6 %
Power Drift	5.0	Rectangular	√3	1	1	± 2.9 %	± 2.9 %
Phantom and Setup							
Phantom Uncertainty	4.0	Rectangular	√3	1	1	± 2.3 %	± 2.3 %
Liquid Conductivity (Target)	5.0	Rectangular	√3	0.64	0.43	± 1.8 %	± 1.2 %
Liquid Conductivity (Meas.)	2.5	Normal	1	0.64	0.43	± 1.6 %	± 1.1 %
Liquid Permittivity (Target)	5.0	Rectangular	√3	0.6	0.49	± 1.7 %	± 1.4 %
Liquid Permittivity (Meas.)	2.5	Normal	1	0.6	0.49	± 1.5 %	± 1.2 %
Combined Standard Uncertainty						± 11.0 %	± 10.8 %
Coverage Factor for 95 %						K=2	
Expanded Uncertainty						± 22.0 %	± 21.5 %

Table 17.2. Uncertainty Budget for frequency range 300 MHz to 3 GHz

18. References

- [1] FCC 47 CFR Part 2 "Frequency Allocations and Radio Treaty Matters; General Rules and Regulations"
- [2] ANSI/IEEE Std. C95.1-1992, "IEEE Standard for Safety Levels with Respect to Human Exposure to Radio Frequency Electromagnetic Fields, 3 kHz to 300 GHz", September 1992
- [3] IEEE Std. 1528-2003, "Recommended Practice for Determining the Peak Spatial-Average Specific Absorption Rate (SAR) in the Human Head from Wireless Communications Devices: Measurement Techniques", December 2003
- [4] SPEAG DASY System Handbook
- [5] FCC KDB 248227 D01 v01r02, "SAR Measurement Procedures for 802.11 a/b/g Transmitters", May 2007
- [6] FCC KDB 447498 D01 v05r02, "Mobile and Portable Device RF Exposure Procedures and Equipment Authorization Policies", Feb 2014
- [7] FCC KDB 648474 D04 v01r02, "SAR Evaluation Considerations for Wireless Handsets", Dec 2013.
- [8] FCC KDB 941225 D01 3G SAR Procedures v03, "3G SAR measurement procedures", October 2014
- [9] FCC KDB 941225 D02 v02r02, "SAR Guidance for HSPA, HSPA+, DC-HSDPA and 1x-Advanced", May 2013.
- [10] FCC KDB 941225 D03 v01, "Recommended SAR Test Reduction Procedures for GSM / GPRS / EDGE", December 2008
- [11] FCC KDB 941225 D06 v01r01, "SAR Evaluation Procedures for Portable Devices with Wireless Router Capabilities", May 2013.
- [12] FCC KDB 865664 D01 v01r03, "SAR Measurement Requirements for 100 MHz to 6 GHz", Feb 2014.
- [13] FCC KDB 865664 D02 v01r01, "RF Exposure Compliance Reporting and Documentation Considerations" May 2013.



Appendix A. Plots of System Performance Check

The plots are shown as follows.

System Check_Head_835MHz_141017

DUT: D835V2-SN:4d151

Communication System: CW; Frequency: 835 MHz; Duty Cycle: 1:1

Medium: HSL_835_141017 Medium parameters used: $f = 835$ MHz; $\sigma = 0.929$ S/m; $\epsilon_r = 41.793$; $\rho = 1000$ kg/m³

Ambient Temperature : 23.6 °C ; Liquid Temperature : 22.7 °C

DASY5 Configuration:

- Probe: EX3DV4 - SN3911; ConvF(9.62, 9.62, 9.62); Calibrated: 2014/10/2;
- Sensor-Surface: 2mm (Mechanical Surface Detection)
- Electronics: DAE4 Sn1358; Calibrated: 2014/4/30
- Phantom: SAM2; Type: QD000P40CD; Serial: TP:1754
- Measurement SW: DASY52, Version 52.8 (5); SEMCAD X Version 14.6.8 (7028)

Pin=250mW/Area Scan (61x61x1): Interpolated grid: dx=15mm, dy=15mm
Maximum value of SAR (interpolated) = 2.96 W/kg

Pin=250mW/Zoom Scan (5x5x7)/Cube 0: Measurement grid: dx=8mm, dy=8mm, dz=5mm
Reference Value = 62.573 V/m; Power Drift = 0.03 dB
Peak SAR (extrapolated) = 3.87 W/kg
SAR(1 g) = 2.53 W/kg; SAR(10 g) = 1.64 W/kg
Maximum value of SAR (measured) = 2.98 W/kg

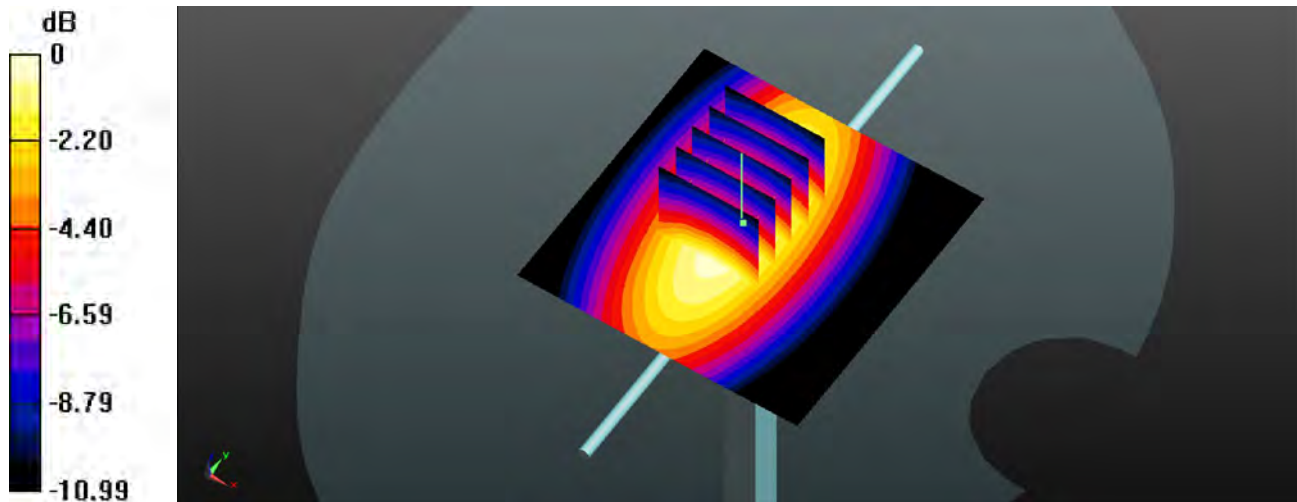

0 dB = 2.98 W/kg

System Check_Head_1900MHz_141017

DUT: D1900V2-5d170

Communication System: CW; Frequency: 1900 MHz; Duty Cycle: 1:1

Medium: HSL_1900_141017 Medium parameters used: $f = 1900$ MHz; $\sigma = 1.449$ S/m; $\epsilon_r = 40.853$; $\rho = 1000$ kg/m³

Ambient Temperature : 23.6 °C ; Liquid Temperature : 22.6 °C

DASY5 Configuration:

- Probe: EX3DV4 - SN3911; ConvF(7.95, 7.95, 7.95); Calibrated: 2014/10/2;
- Sensor-Surface: 2mm (Mechanical Surface Detection)
- Electronics: DAE4 Sn1358; Calibrated: 2014/4/30
- Phantom: SAM1; Type: QD000P40CD; Serial: TP:1753
- Measurement SW: DASY52, Version 52.8 (5); SEMCAD X Version 14.6.8 (7028)

Pin=250mW/Area Scan (61x61x1): Interpolated grid: dx=15mm, dy=15mm
Maximum value of SAR (interpolated) = 14.3 W/kg

Pin=250mW/Zoom Scan (5x5x7)/Cube 0: Measurement grid: dx=8mm, dy=8mm, dz=5mm
Reference Value = 100.8 V/m; Power Drift = -0.11 dB
Peak SAR (extrapolated) = 18.0 W/kg
SAR(1 g) = 9.93 W/kg; SAR(10 g) = 5.2 W/kg
Maximum value of SAR (measured) = 14.1 W/kg

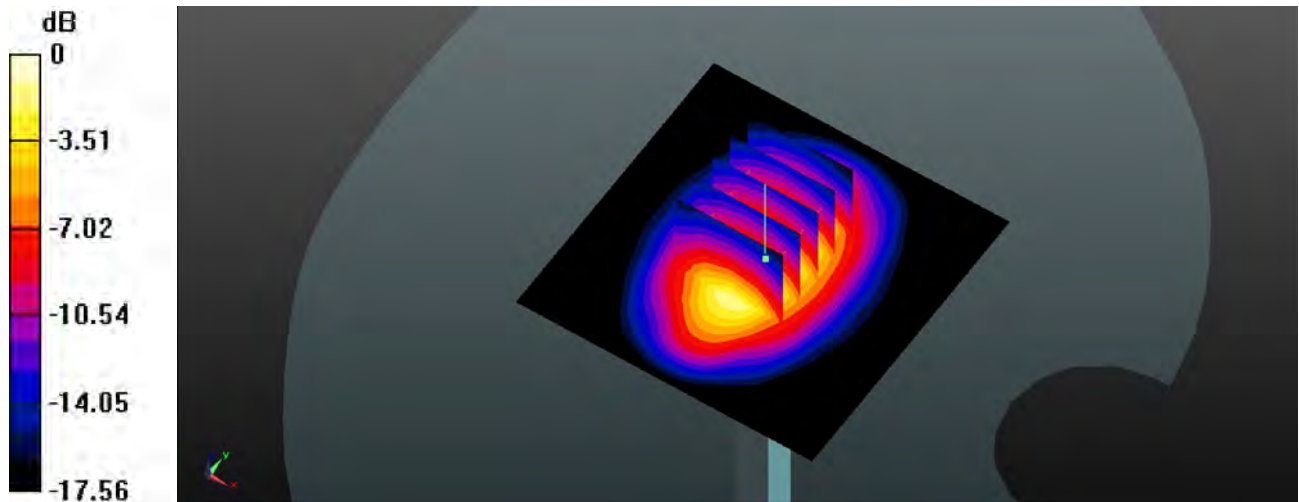

0 dB = 14.1 W/kg

System Check_Head_2450MHz_141018

DUT: D2450V2-SN:908

Communication System: CW; Frequency: 2450 MHz; Duty Cycle: 1:1

Medium: HSL_2450_141018 Medium parameters used: $f = 2450$ MHz; $\sigma = 1.832$ S/m; $\epsilon_r = 37.7$; $\rho = 1000$ kg/m³

Ambient Temperature : 23.5 °C ; Liquid Temperature : 22.6 °C

DASY5 Configuration:

- Probe: EX3DV4 - SN3911; ConvF(7.05, 7.05, 7.05); Calibrated: 2014/10/2;
- Sensor-Surface: 2mm (Mechanical Surface Detection)
- Electronics: DAE4 Sn1358; Calibrated: 2014/4/30
- Phantom: SAM1; Type: QD000P40CD; Serial: TP:1753
- Measurement SW: DASY52, Version 52.8 (5); SEMCAD X Version 14.6.8 (7028)

Pin=250mW/Area Scan (81x81x1): Interpolated grid: dx=12mm, dy=12mm
Maximum value of SAR (interpolated) = 21.3 W/kg

Pin=250mW/Zoom Scan (7x7x7)/Cube 0: Measurement grid: dx=5mm, dy=5mm, dz=5mm
Reference Value = 90.931 V/m; Power Drift = -0.03 dB
Peak SAR (extrapolated) = 29.3 W/kg
SAR(1 g) = 14 W/kg; SAR(10 g) = 6.49 W/kg
Maximum value of SAR (measured) = 21.5 W/kg

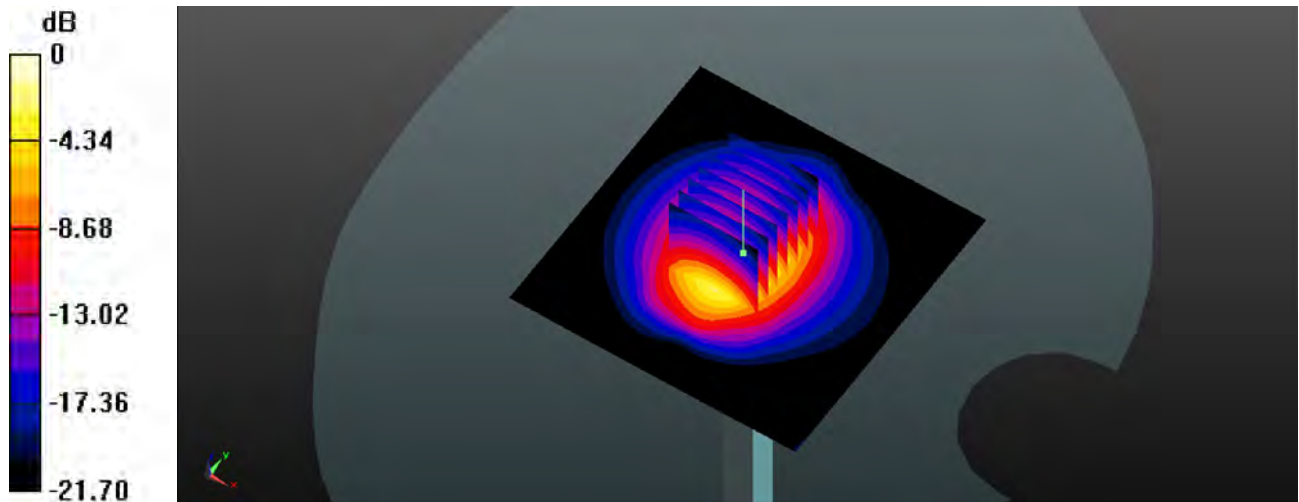

0 dB = 21.5 W/kg

System Check_Body_835MHz_141016

DUT: D835V2-SN:4d151

Communication System: CW; Frequency: 835 MHz; Duty Cycle: 1:1

Medium: MSL_835_141016 Medium parameters used: $f = 835$ MHz; $\sigma = 0.974$ S/m; $\epsilon_r = 54.266$; $\rho = 1000$ kg/m³

Ambient Temperature : 23.6 °C ; Liquid Temperature : 22.6 °C

DASY5 Configuration:

- Probe: EX3DV4 - SN3911; ConvF(9.66, 9.66, 9.66); Calibrated: 2014/10/2;
- Sensor-Surface: 2mm (Mechanical Surface Detection)
- Electronics: DAE4 Sn1358; Calibrated: 2014/4/30
- Phantom: SAM1; Type: QD000P40CD; Serial: TP:1753
- Measurement SW: DASY52, Version 52.8 (5); SEMCAD X Version 14.6.8 (7028)

Pin=250mW/Area Scan (61x61x1): Interpolated grid: dx=15mm, dy=15mm
Maximum value of SAR (interpolated) = 2.80 W/kg

Pin=250mW/Zoom Scan (5x5x7)/Cube 0: Measurement grid: dx=8mm, dy=8mm, dz=5mm
Reference Value = 51.971 V/m; Power Drift = -0.05 dB
Peak SAR (extrapolated) = 3.49 W/kg
SAR(1 g) = 2.4 W/kg; SAR(10 g) = 1.55 W/kg
Maximum value of SAR (measured) = 2.77 W/kg

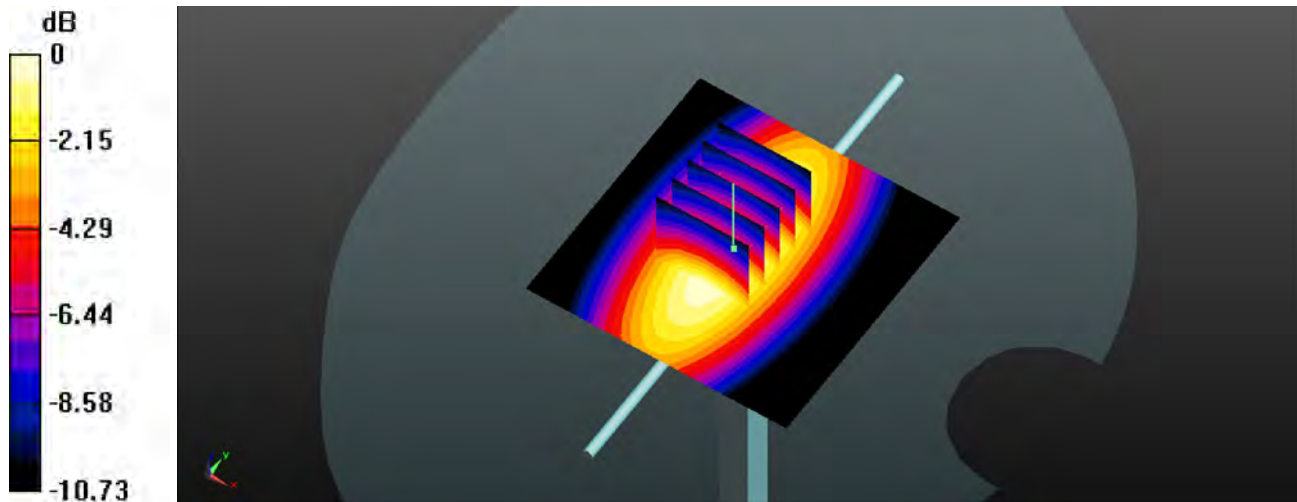

0 dB = 2.77 W/kg

System Check_Body_1900MHz_141016

DUT: D1900V2-SN:5d170

Communication System: CW; Frequency: 1900 MHz; Duty Cycle: 1:1

Medium: MSL_1900_141016 Medium parameters used: $f = 1900$ MHz; $\sigma = 1.554$ S/m; $\epsilon_r = 53.078$; $\rho = 1000$ kg/m³

Ambient Temperature : 23.6 °C ; Liquid Temperature : 22.7 °C

DASY5 Configuration:

- Probe: EX3DV4 - SN3911; ConvF(7.57, 7.57, 7.57); Calibrated: 2014/10/2;
- Sensor-Surface: 2mm (Mechanical Surface Detection)
- Electronics: DAE4 Sn1358; Calibrated: 2014/4/30
- Phantom: SAM2; Type: QD000P40CD; Serial: TP:1754
- Measurement SW: DASY52, Version 52.8 (5); SEMCAD X Version 14.6.8 (7028)

Pin=250mW/Area Scan (61x61x1): Interpolated grid: dx=15mm, dy=15mm
Maximum value of SAR (interpolated) = 14.1 W/kg

Pin=250mW/Zoom Scan (5x5x7)/Cube 0: Measurement grid: dx=8mm, dy=8mm, dz=5mm
Reference Value = 83.409 V/m; Power Drift = -0.13 dB
Peak SAR (extrapolated) = 17.6 W/kg
SAR(1 g) = 9.93 W/kg; SAR(10 g) = 5.23 W/kg
Maximum value of SAR (measured) = 14.0 W/kg

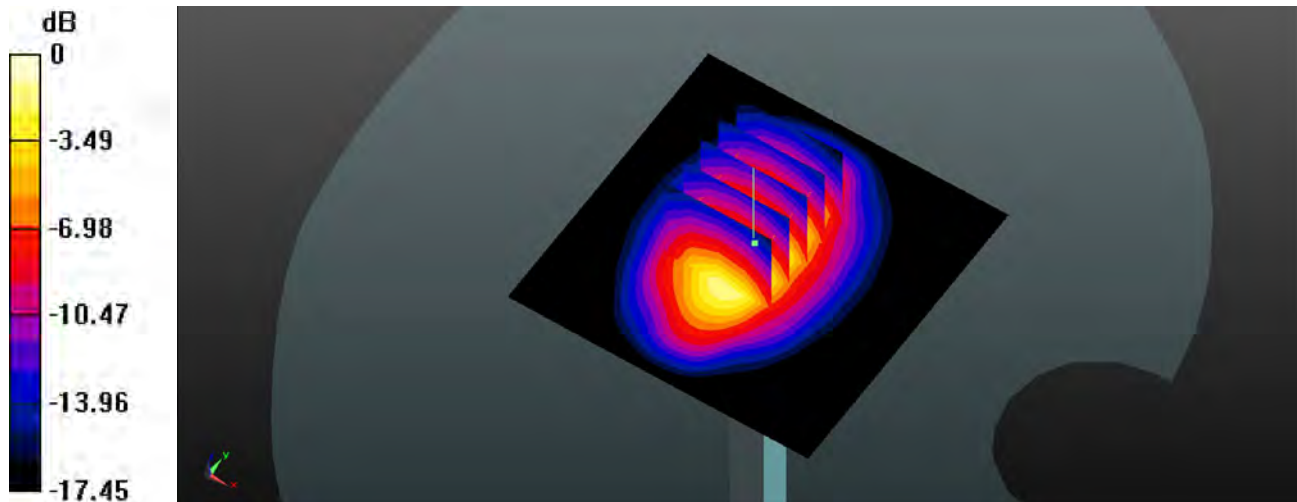

0 dB = 14.0 W/kg

System Check_Body_2450MHz_141019

DUT: D2450V2-SN:908

Communication System: CW; Frequency: 2450 MHz; Duty Cycle: 1:1

Medium: MSL_2450_141019 Medium parameters used: $f = 2450$ MHz; $\sigma = 1.984$ S/m; $\epsilon_r = 51.165$; $\rho = 1000$ kg/m³

Ambient Temperature : 23.5 °C ; Liquid Temperature : 22.5 °C

DASY5 Configuration:

- Probe: EX3DV4 - SN3911; ConvF(7.18, 7.18, 7.18); Calibrated: 2014/10/2;
- Sensor-Surface: 2mm (Mechanical Surface Detection)
- Electronics: DAE4 Sn1358; Calibrated: 2014/4/30
- Phantom: SAM2; Type: QD000P40CD; Serial: TP:1754
- Measurement SW: DASY52, Version 52.8 (5); SEMCAD X Version 14.6.8 (7028)

Pin=250mW/Area Scan (81x81x1): Interpolated grid: dx=12mm, dy=12mm
Maximum value of SAR (interpolated) = 20.4 W/kg

Pin=250mW/Zoom Scan (7x7x7)/Cube 0: Measurement grid: dx=5mm, dy=5mm, dz=5mm
Reference Value = 88.996 V/m; Power Drift = -0.15 dB
Peak SAR (extrapolated) = 27.4 W/kg
SAR(1 g) = 13.6 W/kg; SAR(10 g) = 6.41 W/kg
Maximum value of SAR (measured) = 20.6 W/kg

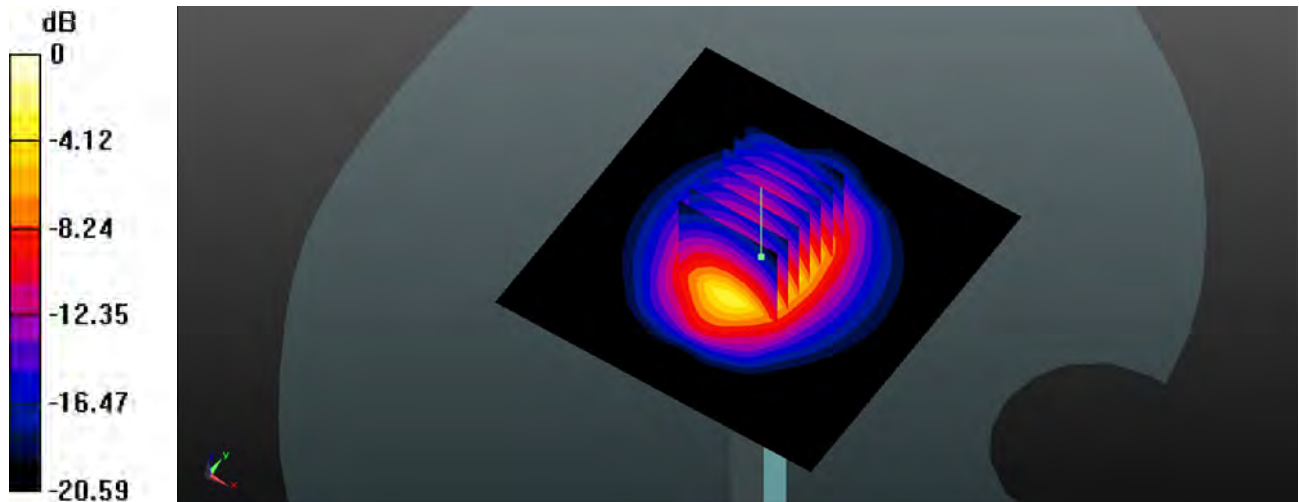

0 dB = 20.6 W/kg



Appendix B. Plots of High SAR Measurement

The plots are shown as follows.

#01 GSM850_GPRS(GMSK 4 TX slots) _Right Cheek_Ch128

Communication System: GPRS (GMSK 4 Tx slot); Frequency: 824.2 MHz; Duty Cycle: 1:2.08
Medium: HSL_835_141017 Medium parameters used: $f = 824.2$ MHz; $\sigma = 0.919$ S/m; $\epsilon_r = 41.913$; $\rho = 1000$ kg/m³
Ambient Temperature : 23.6 °C ; Liquid Temperature : 22.7 °C

DASY5 Configuration:

- Probe: EX3DV4 - SN3911; ConvF(9.62, 9.62, 9.62); Calibrated: 2014/10/2;
- Sensor-Surface: 2mm (Mechanical Surface Detection)
- Electronics: DAE4 Sn1358; Calibrated: 2014/4/30
- Phantom: SAM2; Type: QD000P40CD; Serial: TP:1754
- Measurement SW: DASY52, Version 52.8 (5); SEMCAD X Version 14.6.8 (7028)

Ch128/Area Scan (61x111x1): Interpolated grid: dx=15mm, dy=15mm
Maximum value of SAR (interpolated) = 0.590 W/kg

Ch128/Zoom Scan (5x5x7)/Cube 0: Measurement grid: dx=8mm, dy=8mm, dz=5mm
Reference Value = 7.425 V/m; Power Drift = 0.08 dB
Peak SAR (extrapolated) = 0.660 W/kg
SAR(1 g) = 0.523 W/kg; SAR(10 g) = 0.402 W/kg
Maximum value of SAR (measured) = 0.600 W/kg

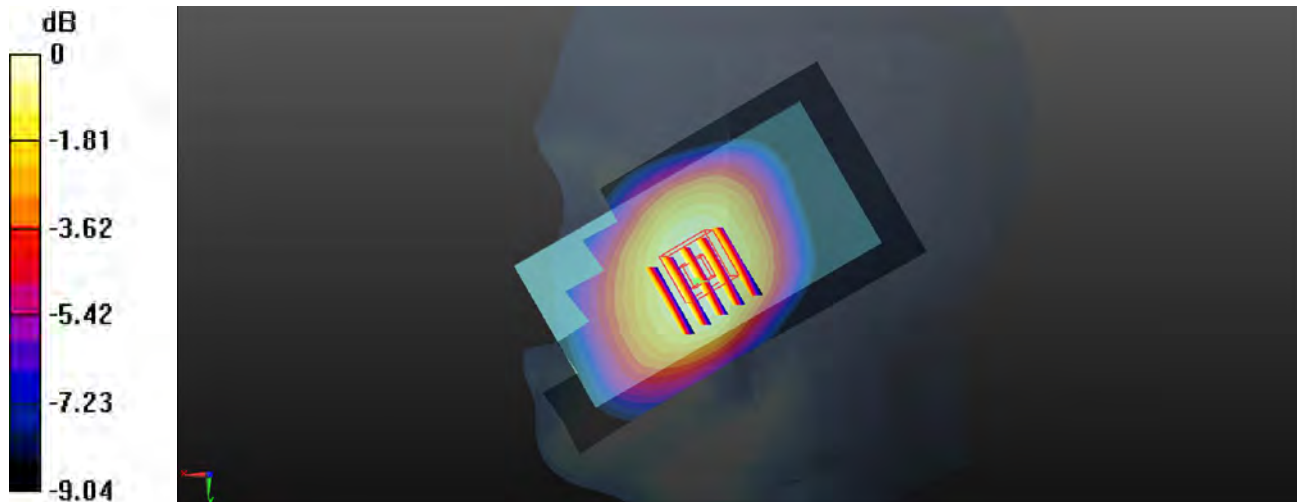

0 dB = 0.600 W/kg

#02 GSM1900_GPRS(GMSK 4 TX slots) _Right Cheek_Ch661

Communication System: GPRS (GMSK 4 Tx slot); Frequency: 1880 MHz; Duty Cycle: 1:2.08
Medium: HSL_1900_141017 Medium parameters used: $f = 1880$ MHz; $\sigma = 1.425$ S/m; $\epsilon_r = 40.915$; $\rho = 1000$ kg/m³
Ambient Temperature : 23.6 °C ; Liquid Temperature : 22.6 °C

DASY5 Configuration:

- Probe: EX3DV4 - SN3911; ConvF(7.95, 7.95, 7.95); Calibrated: 2014/10/2;
- Sensor-Surface: 2mm (Mechanical Surface Detection)
- Electronics: DAE4 Sn1358; Calibrated: 2014/4/30
- Phantom: SAM1; Type: QD000P40CD; Serial: TP:1753
- Measurement SW: DASY52, Version 52.8 (5); SEMCAD X Version 14.6.8 (7028)

Ch661/Area Scan (61x111x1): Interpolated grid: dx=15mm, dy=15mm
Maximum value of SAR (interpolated) = 0.441 W/kg

Ch661/Zoom Scan (5x5x7)/Cube 0: Measurement grid: dx=8mm, dy=8mm, dz=5mm
Reference Value = 4.603 V/m; Power Drift = -0.04 dB
Peak SAR (extrapolated) = 0.500 W/kg
SAR(1 g) = 0.325 W/kg; SAR(10 g) = 0.201 W/kg
Maximum value of SAR (measured) = 0.419 W/kg

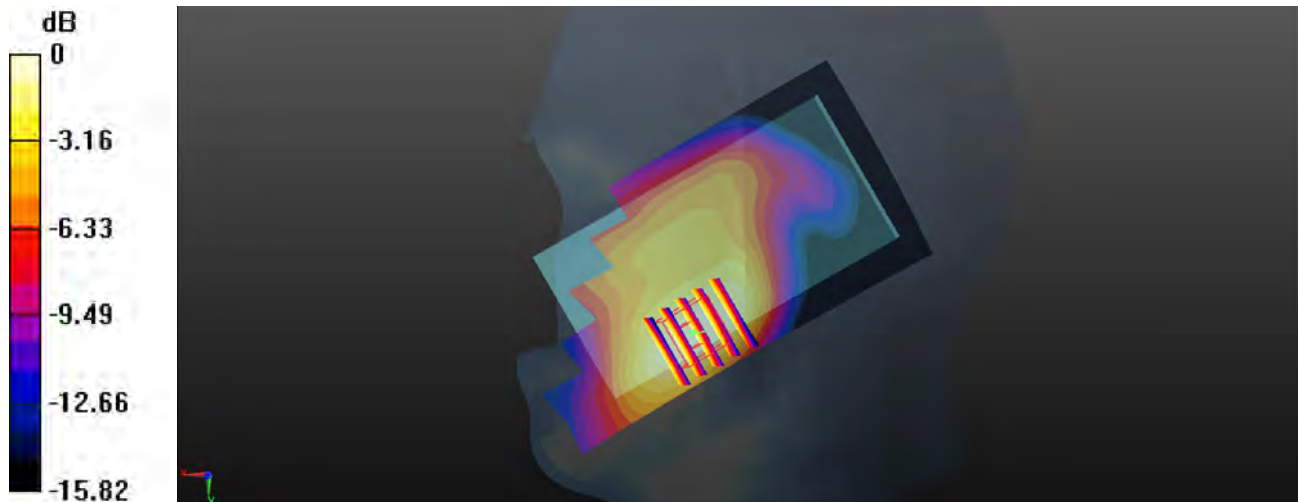

0 dB = 0.419 W/kg

#03 WCDMA Band V_RMC 12.2K_Left Cheek_Ch4233

Communication System: WCDMA ; Frequency: 846.6 MHz;Duty Cycle: 1:1

Medium: HSL_835_141017 Medium parameters used: $f = 846.6$ MHz; $\sigma = 0.939$ S/m; $\epsilon_r = 41.657$; $\rho = 1000$ kg/m³

Ambient Temperature : 23.6 °C ; Liquid Temperature : 22.7 °C

DASY5 Configuration:

- Probe: EX3DV4 - SN3911; ConvF(9.62, 9.62, 9.62); Calibrated: 2014/10/2;
- Sensor-Surface: 2mm (Mechanical Surface Detection)
- Electronics: DAE4 Sn1358; Calibrated: 2014/4/30
- Phantom: SAM2; Type: QD000P40CD; Serial: TP:1754
- Measurement SW: DASY52, Version 52.8 (5); SEMCAD X Version 14.6.8 (7028)

Ch4233/Area Scan (61x111x1): Interpolated grid: dx=15mm, dy=15mm

Maximum value of SAR (interpolated) = 0.277 W/kg

Ch4233/Zoom Scan (5x5x7)/Cube 0: Measurement grid: dx=8mm, dy=8mm, dz=5mm

Reference Value = 5.692 V/m; Power Drift = 0.03 dB

Peak SAR (extrapolated) = 0.301 W/kg

SAR(1 g) = 0.239 W/kg; SAR(10 g) = 0.181 W/kg

Maximum value of SAR (measured) = 0.273 W/kg

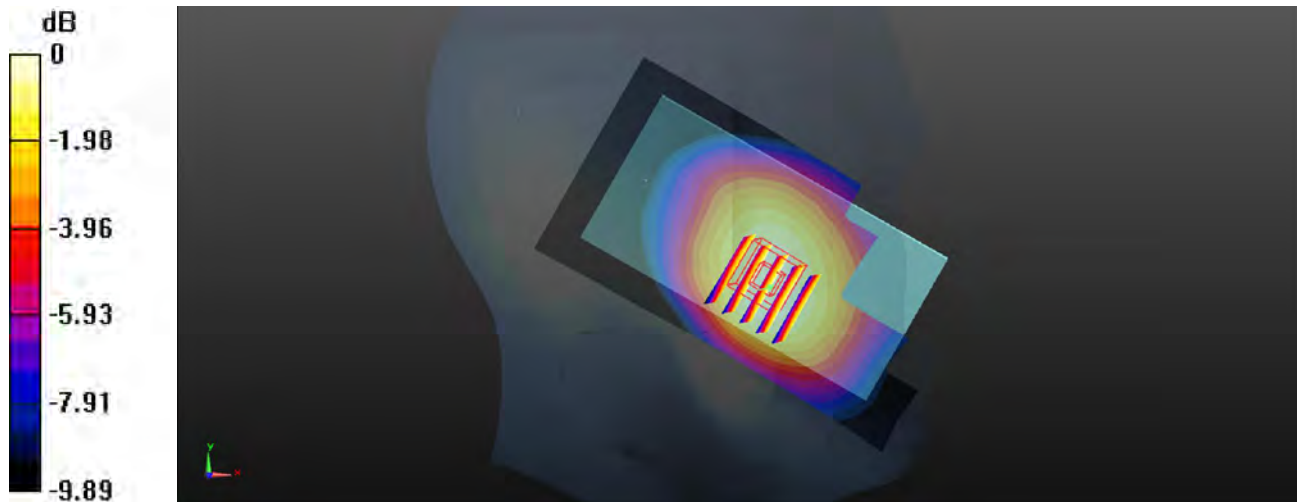

0 dB = 0.273 W/kg

#04 WCDMA Band II_RMC 12.2K_Right Cheek_Ch9400

Communication System: WCDMA ; Frequency: 1880 MHz;Duty Cycle: 1:1

Medium: HSL_1900_141017 Medium parameters used: $f = 1880$ MHz; $\sigma = 1.425$ S/m; $\epsilon_r = 40.915$; $\rho = 1000$ kg/m³

Ambient Temperature : 23.6 °C ; Liquid Temperature : 22.6 °C

DASY5 Configuration:

- Probe: EX3DV4 - SN3911; ConvF(7.95, 7.95, 7.95); Calibrated: 2014/10/2;
- Sensor-Surface: 2mm (Mechanical Surface Detection)
- Electronics: DAE4 Sn1358; Calibrated: 2014/4/30
- Phantom: SAM1; Type: QD000P40CD; Serial: TP:1753
- Measurement SW: DASY52, Version 52.8 (5); SEMCAD X Version 14.6.8 (7028)

Ch9400/Area Scan (61x111x1): Interpolated grid: dx=15mm, dy=15mm
Maximum value of SAR (interpolated) = 0.343 W/kg

Ch9400/Zoom Scan (5x5x7)/Cube 0: Measurement grid: dx=8mm, dy=8mm, dz=5mm
Reference Value = 3.934 V/m; Power Drift = 0.04 dB
Peak SAR (extrapolated) = 0.388 W/kg
SAR(1 g) = 0.254 W/kg; SAR(10 g) = 0.157 W/kg
Maximum value of SAR (measured) = 0.327 W/kg

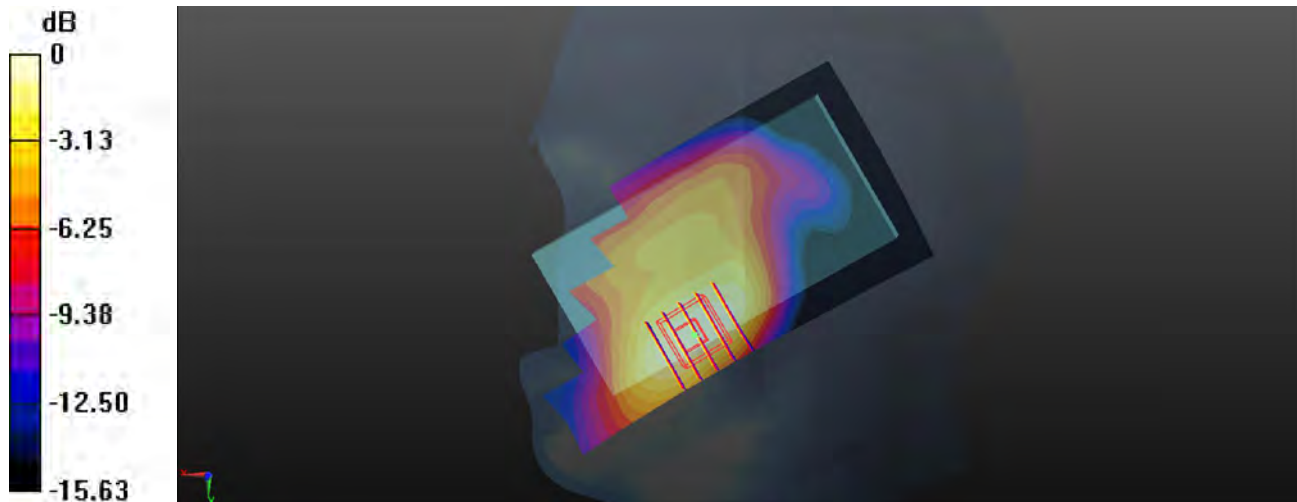

0 dB = 0.327 W/kg

#05 WLAN2.4GHz_802.11b 1Mbps_Left Cheek_Ch11

Communication System: 802.11b; Frequency: 2462 MHz; Duty Cycle: 1:1

Medium: HSL_2450_141018 Medium parameters used: $f = 2462$ MHz; $\sigma = 1.851$ S/m; $\epsilon_r = 37.602$; $\rho = 1000$ kg/m³

Ambient Temperature : 23.5 °C ; Liquid Temperature : 22.6 °C

DASY5 Configuration:

- Probe: EX3DV4 - SN3911; ConvF(7.05, 7.05, 7.05); Calibrated: 2014/10/2;
- Sensor-Surface: 2mm (Mechanical Surface Detection)
- Electronics: DAE4 Sn1358; Calibrated: 2014/4/30
- Phantom: SAM1; Type: QD000P40CD; Serial: TP:1753
- Measurement SW: DASY52, Version 52.8 (5); SEMCAD X Version 14.6.8 (7028)

Ch11/Area Scan (91x131x1): Interpolated grid: dx=12mm, dy=12mm

Maximum value of SAR (interpolated) = 0.249 W/kg

Ch11/Zoom Scan (7x7x7)/Cube 0: Measurement grid: dx=5mm, dy=5mm, dz=5mm

Reference Value = 2.219 V/m; Power Drift = 0.05 dB

Peak SAR (extrapolated) = 0.339 W/kg

SAR(1 g) = 0.155 W/kg; SAR(10 g) = 0.069 W/kg

Maximum value of SAR (measured) = 0.235 W/kg

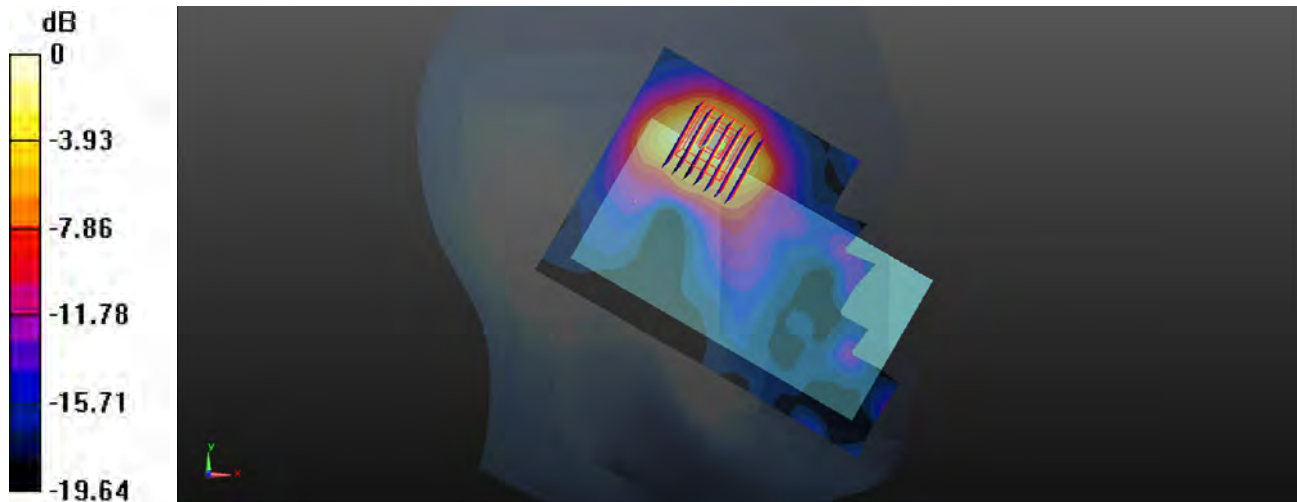

0 dB = 0.235 W/kg

#06 GSM850_GPRS(GMSK 4 TX slots)_Back_1.0cm_Ch189

Communication System: GPRS (GMSK 4 Tx slot); Frequency: 836.4 MHz; Duty Cycle: 1:2.08
Medium: MSL_835_141016 Medium parameters used: $f = 836.4$ MHz; $\sigma = 0.975$ S/m; $\epsilon_r = 54.256$; $\rho = 1000$ kg/m³
Ambient Temperature : 23.6 °C ; Liquid Temperature : 22.6 °C

DASY5 Configuration:

- Probe: EX3DV4 - SN3911; ConvF(9.66, 9.66, 9.66); Calibrated: 2014/10/2;
- Sensor-Surface: 2mm (Mechanical Surface Detection)
- Electronics: DAE4 Sn1358; Calibrated: 2014/4/30
- Phantom: SAM1; Type: QD000P40CD; Serial: TP:1753
- Measurement SW: DASY52, Version 52.8 (5); SEMCAD X Version 14.6.8 (7028)

Ch189/Area Scan (61x111x1): Interpolated grid: dx=15mm, dy=15mm
Maximum value of SAR (interpolated) = 1.51 W/kg

Ch189/Zoom Scan (5x5x7)/Cube 0: Measurement grid: dx=8mm, dy=8mm, dz=5mm
Reference Value = 36.370 V/m; Power Drift = -0.01 dB
Peak SAR (extrapolated) = 1.69 W/kg
SAR(1 g) = 1.2 W/kg; SAR(10 g) = 0.977 W/kg
Maximum value of SAR (measured) = 1.51 W/kg

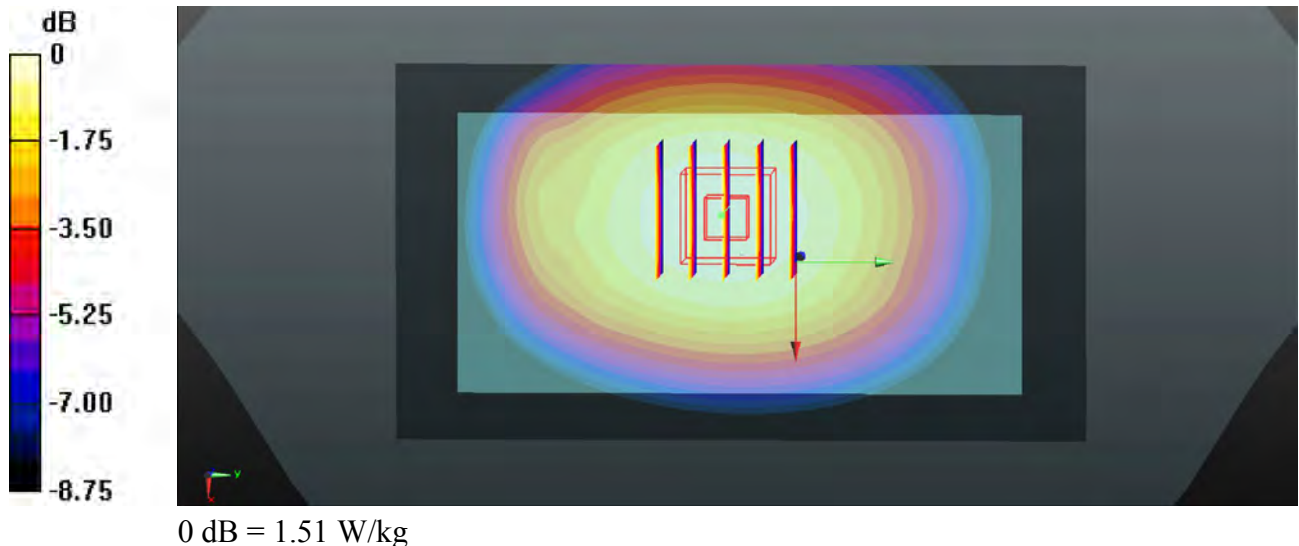

#07 GSM1900_GPRS(GMSK 4 TX slots)_Back_1.0cm_Ch661

Communication System: GPRS (GMSK 4 Tx slot); Frequency: 1880 MHz; Duty Cycle: 1:2.08

Medium: MSL_1900_141016 Medium parameters used: $f = 1880$ MHz; $\sigma = 1.531$ S/m; $\epsilon_r = 53.126$; $\rho = 1000$ kg/m³

Ambient Temperature : 23.6 °C ; Liquid Temperature : 22.7 °C

DASY5 Configuration:

- Probe: EX3DV4 - SN3911; ConvF(7.57, 7.57, 7.57); Calibrated: 2014/10/2;
- Sensor-Surface: 2mm (Mechanical Surface Detection)
- Electronics: DAE4 Sn1358; Calibrated: 2014/4/30
- Phantom: SAM2; Type: QD000P40CD; Serial: TP:1754
- Measurement SW: DASY52, Version 52.8 (5); SEMCAD X Version 14.6.8 (7028)

Ch661/Area Scan (61x111x1): Interpolated grid: dx=15mm, dy=15mm

Maximum value of SAR (interpolated) = 0.863 W/kg

Ch661/Zoom Scan (5x5x7)/Cube 0: Measurement grid: dx=8mm, dy=8mm, dz=5mm

Reference Value = 8.788 V/m; Power Drift = 0.01 dB

Peak SAR (extrapolated) = 1.01 W/kg

SAR(1 g) = 0.619 W/kg; SAR(10 g) = 0.374 W/kg

Maximum value of SAR (measured) = 0.819 W/kg

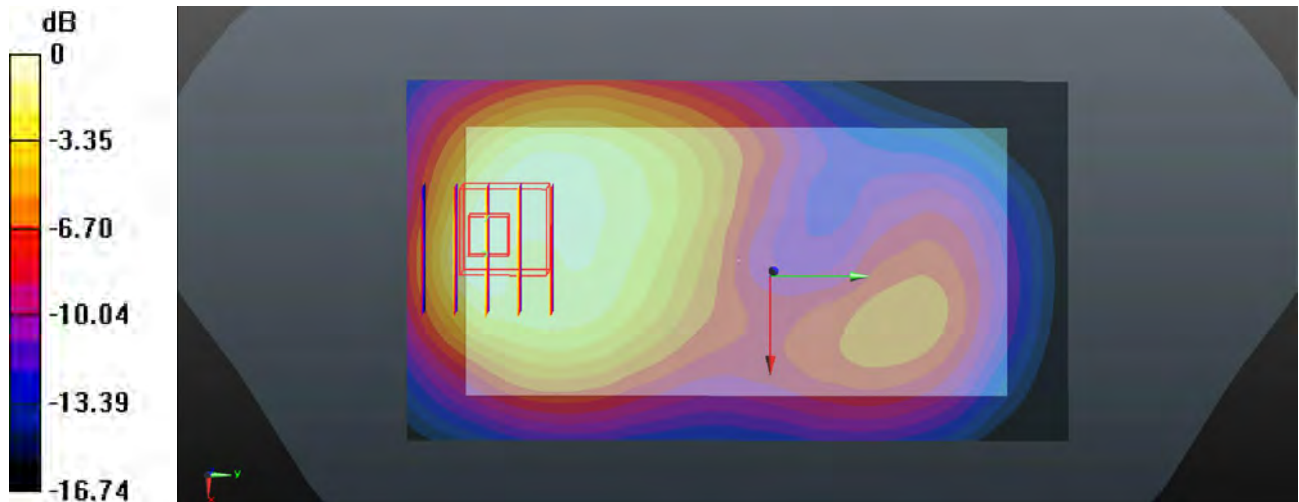

0 dB = 0.819 W/kg

#08 WCDMA Band V_RMC 12.2K_Back_1.0cm_Ch4233

Communication System: WCDMA ; Frequency: 846.6 MHz;Duty Cycle: 1:1

Medium: MSL_835_141016 Medium parameters used: $f = 846.6$ MHz; $\sigma = 0.985$ S/m; $\epsilon_r = 54.16$; $\rho = 1000$ kg/m³

Ambient Temperature : 23.6 °C ; Liquid Temperature : 22.6 °C

DASY5 Configuration:

- Probe: EX3DV4 - SN3911; ConvF(9.66, 9.66, 9.66); Calibrated: 2014/10/2;
- Sensor-Surface: 2mm (Mechanical Surface Detection)
- Electronics: DAE4 Sn1358; Calibrated: 2014/4/30
- Phantom: SAM1; Type: QD000P40CD; Serial: TP:1753
- Measurement SW: DASY52, Version 52.8 (5); SEMCAD X Version 14.6.8 (7028)

Ch4233/Area Scan (51x101x1): Interpolated grid: dx=15mm, dy=15mm

Maximum value of SAR (interpolated) = 0.543 W/kg

Ch4233/Zoom Scan (5x5x7)/Cube 0: Measurement grid: dx=8mm, dy=8mm, dz=5mm

Reference Value = 21.780 V/m; Power Drift = 0.03 dB

Peak SAR (extrapolated) = 0.606 W/kg

SAR(1 g) = 0.469 W/kg; SAR(10 g) = 0.352 W/kg

Maximum value of SAR (measured) = 0.545 W/kg

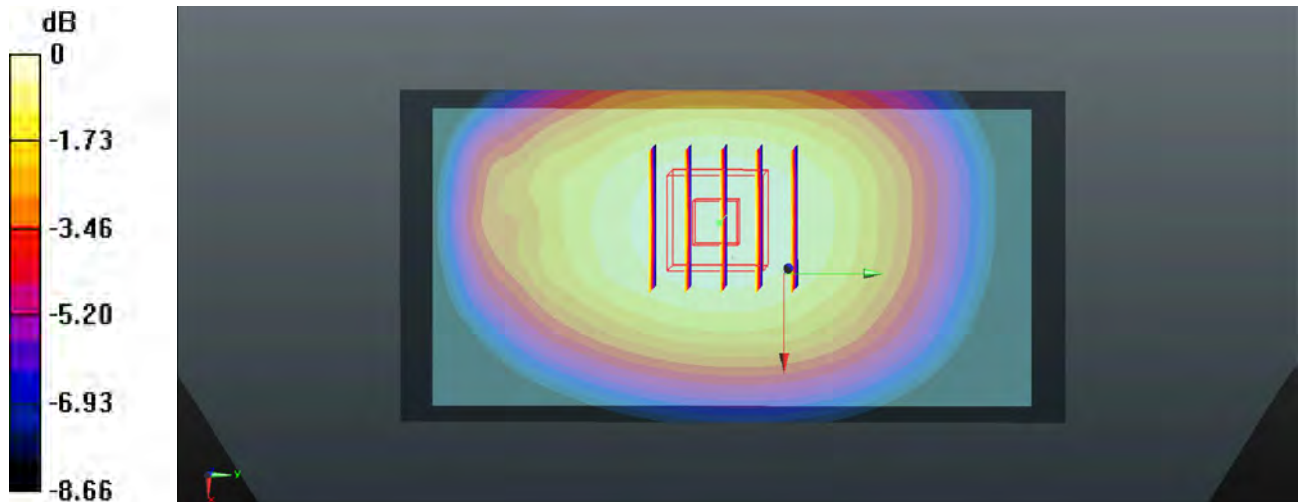

0 dB = 0.545 W/kg

#09 WCDMA Band II_RMC 12.2K _Back_1.0cm_Ch9400

Communication System: WCDMA ; Frequency: 1880 MHz;Duty Cycle: 1:1

Medium: MSL_1900_141016 Medium parameters used: $f = 1880$ MHz; $\sigma = 1.531$ S/m; $\epsilon_r = 53.126$; $\rho = 1000$ kg/m³

Ambient Temperature : 23.6 °C ; Liquid Temperature : 22.7 °C

DASY5 Configuration:

- Probe: EX3DV4 - SN3911; ConvF(7.57, 7.57, 7.57); Calibrated: 2014/10/2;
- Sensor-Surface: 2mm (Mechanical Surface Detection)
- Electronics: DAE4 Sn1358; Calibrated: 2014/4/30
- Phantom: SAM2; Type: QD000P40CD; Serial: TP:1754
- Measurement SW: DASY52, Version 52.8 (5); SEMCAD X Version 14.6.8 (7028)

Ch9400/Area Scan (61x111x1): Interpolated grid: dx=15mm, dy=15mm
Maximum value of SAR (interpolated) = 0.650 W/kg

Ch9400/Zoom Scan (5x5x7)/Cube 0: Measurement grid: dx=8mm, dy=8mm, dz=5mm
Reference Value = 7.713 V/m; Power Drift = 0.05 dB
Peak SAR (extrapolated) = 0.760 W/kg
SAR(1 g) = 0.473 W/kg; SAR(10 g) = 0.286 W/kg
Maximum value of SAR (measured) = 0.630 W/kg

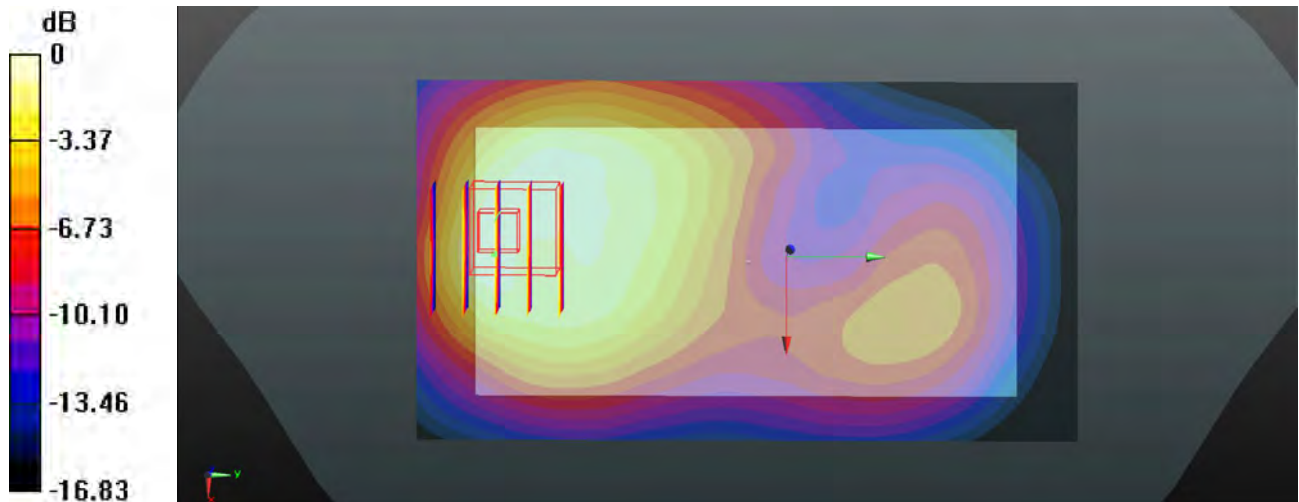

0 dB = 0.630 W/kg

#10 WLAN2.4GHz_802.11b 1Mbps_Back_1.0cm_Ch11

Communication System: 802.11b; Frequency: 2462 MHz; Duty Cycle: 1:1

Medium: MSL_2450_141019 Medium parameters used: $f = 2462$ MHz; $\sigma = 2.002$ S/m; $\epsilon_r = 51.118$; $\rho = 1000$ kg/m³

Ambient Temperature : 23.5 °C ; Liquid Temperature : 22.5 °C

DASY5 Configuration:

- Probe: EX3DV4 - SN3911; ConvF(7.18, 7.18, 7.18); Calibrated: 2014/10/2;
- Sensor-Surface: 2mm (Mechanical Surface Detection)
- Electronics: DAE4 Sn1358; Calibrated: 2014/4/30
- Phantom: SAM2; Type: QD000P40CD; Serial: TP:1754
- Measurement SW: DASY52, Version 52.8 (5); SEMCAD X Version 14.6.8 (7028)

Ch11/Area Scan (81x131x1): Interpolated grid: dx=12mm, dy=12mm

Maximum value of SAR (interpolated) = 0.153 W/kg

Ch11/Zoom Scan (7x7x7)/Cube 0: Measurement grid: dx=5mm, dy=5mm, dz=5mm

Reference Value = 2.336 V/m; Power Drift = -0.02 dB

Peak SAR (extrapolated) = 0.219 W/kg

SAR(1 g) = 0.108 W/kg; SAR(10 g) = 0.049 W/kg

Maximum value of SAR (measured) = 0.163 W/kg

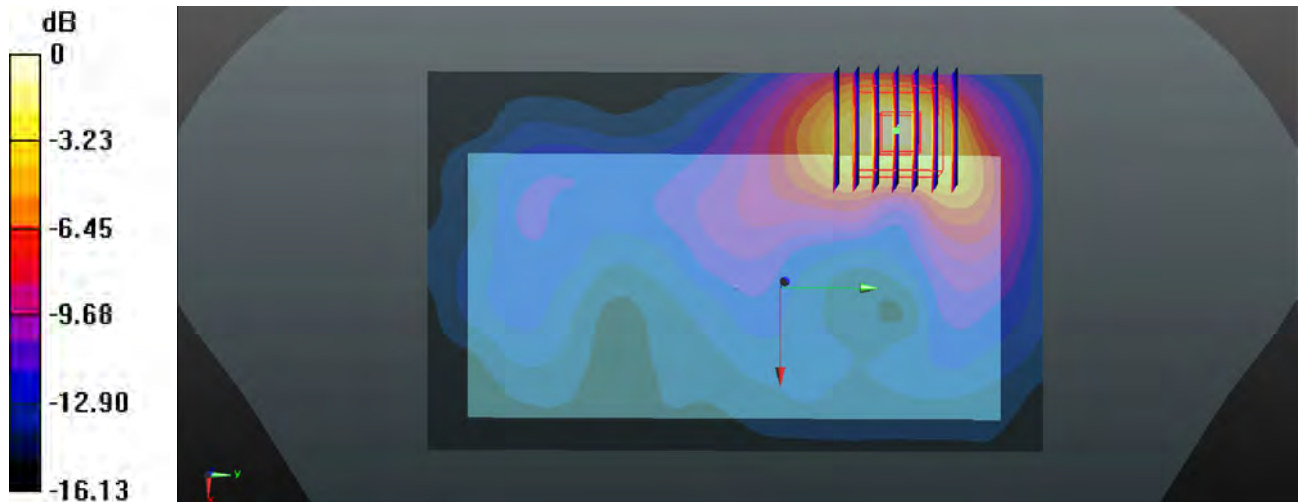

0 dB = 0.163 W/kg

#11 WLAN2.4GHz_802.11b 1Mbps_Back_1.0cm_Ch11_Headset

Communication System: 802.11b; Frequency: 2462 MHz; Duty Cycle: 1:1

Medium: MSL_2450_141019 Medium parameters used: $f = 2462$ MHz; $\sigma = 2.002$ S/m; $\epsilon_r = 51.118$; $\rho = 1000$ kg/m³

Ambient Temperature : 23.5 °C ; Liquid Temperature : 22.5 °C

DASY5 Configuration:

- Probe: EX3DV4 - SN3911; ConvF(7.18, 7.18, 7.18); Calibrated: 2014/10/2;
- Sensor-Surface: 2mm (Mechanical Surface Detection)
- Electronics: DAE4 Sn1358; Calibrated: 2014/4/30
- Phantom: SAM2; Type: QD000P40CD; Serial: TP:1754
- Measurement SW: DASY52, Version 52.8 (5); SEMCAD X Version 14.6.8 (7028)

Ch11/Area Scan (81x131x1): Interpolated grid: dx=12mm, dy=12mm

Maximum value of SAR (interpolated) = 0.159 W/kg

Ch11/Zoom Scan (7x7x7)/Cube 0: Measurement grid: dx=5mm, dy=5mm, dz=5mm

Reference Value = 2.296 V/m; Power Drift = 0.01 dB

Peak SAR (extrapolated) = 0.221 W/kg

SAR(1 g) = 0.109 W/kg; SAR(10 g) = 0.050 W/kg

Maximum value of SAR (measured) = 0.165 W/kg

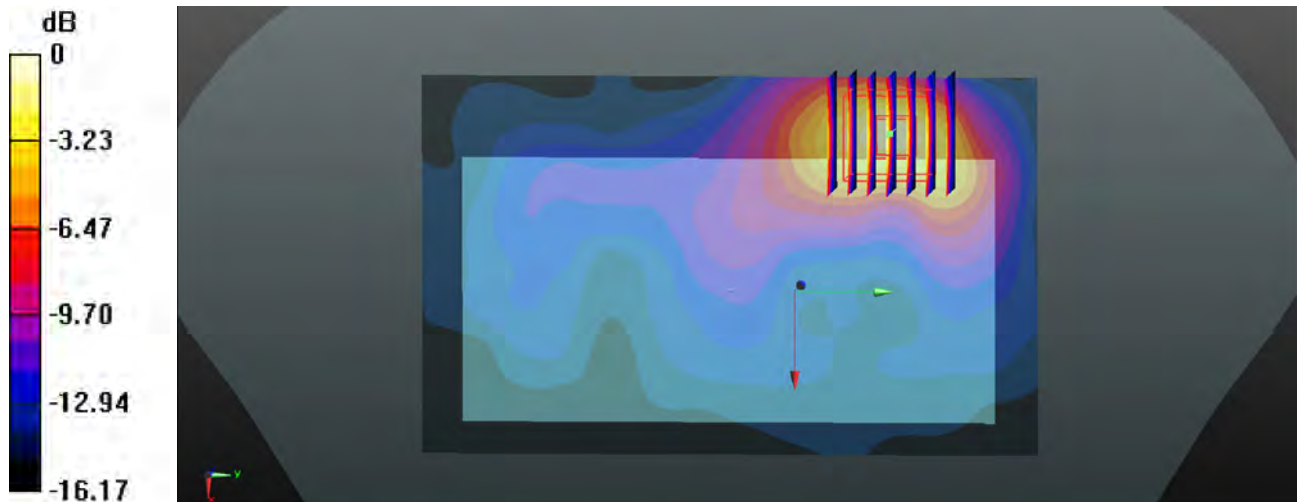

0 dB = 0.165 W/kg



Appendix C. DASYS Calibration Certificate

The DASYS calibration certificates are shown as follows.



Accredited by the Swiss Accreditation Service (SAS)
The Swiss Accreditation Service is one of the signatories to the EA
Multilateral Agreement for the recognition of calibration certificates

Accreditation No.: **SCS 108**

Client **Sporton-KS (Auden)**

Certificate No: **D835V2-4d151_Mar13**

CALIBRATION CERTIFICATE

Object **D835V2 - SN: 4d151**

Calibration procedure(s) **QA CAL-05.v9
Calibration procedure for dipole validation kits above 700 MHz**

Calibration date: **March 25, 2013**

This calibration certificate documents the traceability to national standards, which realize the physical units of measurements (SI).
The measurements and the uncertainties with confidence probability are given on the following pages and are part of the certificate.

All calibrations have been conducted in the closed laboratory facility; environment temperature $(22 \pm 3)^\circ\text{C}$ and humidity $< 70\%$.

Calibration Equipment used (M&TE critical for calibration)

Primary Standards	ID #	Cal Date (Certificate No.)	Scheduled Calibration
Power meter EPM-442A	GB37480704	01-Nov-12 (No. 217-01640)	Oct-13
Power sensor HP 8481A	US37292783	01-Nov-12 (No. 217-01640)	Oct-13
Reference 20 dB Attenuator	SN: 5058 (20k)	27-Mar-12 (No. 217-01530)	Apr-13
Type-N mismatch combination	SN: 5047.3 / 06327	27-Mar-12 (No. 217-01533)	Apr-13
Reference Probe ES3DV3	SN: 3205	28-Dec-12 (No. ES3-3205_Dec12)	Dec-13
DAE4	SN: 601	27-Jun-12 (No. DAE4-601_Jun12)	Jun-13
Secondary Standards	ID #	Check Date (in house)	Scheduled Check
Power sensor HP 8481A	MY41092317	18-Oct-02 (in house check Oct-11)	In house check: Oct-13
RF generator R&S SMT-06	100005	04-Aug-99 (in house check Oct-11)	In house check: Oct-13
Network Analyzer HP 8753E	US37390585 S4206	18-Oct-01 (in house check Oct-12)	In house check: Oct-13

	Name	Function	Signature
Calibrated by:	Jeton Kastrati	Laboratory Technician	
Approved by:	Katja Pokovic	Technical Manager	

Issued: March 26, 2013

This calibration certificate shall not be reproduced except in full without written approval of the laboratory.



Accredited by the Swiss Accreditation Service (SAS)

The Swiss Accreditation Service is one of the signatories to the EA
Multilateral Agreement for the recognition of calibration certificates

Accreditation No.: **SCS 108**

Glossary:

TSL	tissue simulating liquid
ConvF	sensitivity in TSL / NORM x,y,z
N/A	not applicable or not measured

Calibration is Performed According to the Following Standards:

- IEEE Std 1528-2003, "IEEE Recommended Practice for Determining the Peak Spatial-Averaged Specific Absorption Rate (SAR) in the Human Head from Wireless Communications Devices: Measurement Techniques", December 2003
- IEC 62209-1, "Procedure to measure the Specific Absorption Rate (SAR) for hand-held devices used in close proximity to the ear (frequency range of 300 MHz to 3 GHz)", February 2005
- Federal Communications Commission Office of Engineering & Technology (FCC OET), "Evaluating Compliance with FCC Guidelines for Human Exposure to Radiofrequency Electromagnetic Fields; Additional Information for Evaluating Compliance of Mobile and Portable Devices with FCC Limits for Human Exposure to Radiofrequency Emissions", Supplement C (Edition 01-01) to Bulletin 65

Additional Documentation:

- DASY4/5 System Handbook

Methods Applied and Interpretation of Parameters:

- Measurement Conditions:** Further details are available from the Validation Report at the end of the certificate. All figures stated in the certificate are valid at the frequency indicated.
- Antenna Parameters with TSL:** The dipole is mounted with the spacer to position its feed point exactly below the center marking of the flat phantom section, with the arms oriented parallel to the body axis.
- Feed Point Impedance and Return Loss:** These parameters are measured with the dipole positioned under the liquid filled phantom. The impedance stated is transformed from the measurement at the SMA connector to the feed point. The Return Loss ensures low reflected power. No uncertainty required.
- Electrical Delay:** One-way delay between the SMA connector and the antenna feed point. No uncertainty required.
- SAR measured:** SAR measured at the stated antenna input power.
- SAR normalized:** SAR as measured, normalized to an input power of 1 W at the antenna connector.
- SAR for nominal TSL parameters:** The measured TSL parameters are used to calculate the nominal SAR result.

The reported uncertainty of measurement is stated as the standard uncertainty of measurement multiplied by the coverage factor $k=2$, which for a normal distribution corresponds to a coverage probability of approximately 95%.

Measurement Conditions

DASY system configuration, as far as not given on page 1.

DASY Version	DASY5	V52.8.5
Extrapolation	Advanced Extrapolation	
Phantom	Modular Flat Phantom	
Distance Dipole Center - TSL	15 mm	with Spacer
Zoom Scan Resolution	dx, dy, dz = 5 mm	
Frequency	835 MHz \pm 1 MHz	

Head TSL parameters

The following parameters and calculations were applied.

	Temperature	Permittivity	Conductivity
Nominal Head TSL parameters	22.0 °C	41.5	0.90 mho/m
Measured Head TSL parameters	(22.0 \pm 0.2) °C	40.9 \pm 6 %	0.94 mho/m \pm 6 %
Head TSL temperature change during test	< 0.5 °C	---	---

SAR result with Head TSL

SAR averaged over 1 cm ³ (1 g) of Head TSL	Condition	
SAR measured	250 mW input power	2.46 W/kg
SAR for nominal Head TSL parameters	normalized to 1W	9.49 W/kg \pm 17.0 % (k=2)

SAR averaged over 10 cm ³ (10 g) of Head TSL	condition	
SAR measured	250 mW input power	1.59 W/kg
SAR for nominal Head TSL parameters	normalized to 1W	6.18 W/kg \pm 16.5 % (k=2)

Body TSL parameters

The following parameters and calculations were applied.

	Temperature	Permittivity	Conductivity
Nominal Body TSL parameters	22.0 °C	55.2	0.97 mho/m
Measured Body TSL parameters	(22.0 \pm 0.2) °C	54.1 \pm 6 %	1.02 mho/m \pm 6 %
Body TSL temperature change during test	< 0.5 °C	---	---

SAR result with Body TSL

SAR averaged over 1 cm ³ (1 g) of Body TSL	Condition	
SAR measured	250 mW input power	2.46 W/kg
SAR for nominal Body TSL parameters	normalized to 1W	9.43 W/kg \pm 17.0 % (k=2)

SAR averaged over 10 cm ³ (10 g) of Body TSL	condition	
SAR measured	250 mW input power	1.61 W/kg
SAR for nominal Body TSL parameters	normalized to 1W	6.23 W/kg \pm 16.5 % (k=2)

Appendix

Antenna Parameters with Head TSL

Impedance, transformed to feed point	51.7 Ω - 2.2 j Ω
Return Loss	- 31.2 dB

Antenna Parameters with Body TSL

Impedance, transformed to feed point	47.1 Ω - 4.3 j Ω
Return Loss	- 25.4 dB

General Antenna Parameters and Design

Electrical Delay (one direction)	1.391 ns
----------------------------------	----------

After long term use with 100W radiated power, only a slight warming of the dipole near the feedpoint can be measured.

The dipole is made of standard semirigid coaxial cable. The center conductor of the feeding line is directly connected to the second arm of the dipole. The antenna is therefore short-circuited for DC-signals. On some of the dipoles, small end caps are added to the dipole arms in order to improve matching when loaded according to the position as explained in the "Measurement Conditions" paragraph. The SAR data are not affected by this change. The overall dipole length is still according to the Standard.

No excessive force must be applied to the dipole arms, because they might bend or the soldered connections near the feedpoint may be damaged.

Additional EUT Data

Manufactured by	SPEAG
Manufactured on	March 27, 2012

DASY5 Validation Report for Head TSL

Date: 25.03.2013

Test Laboratory: SPEAG, Zurich, Switzerland

DUT: Dipole 835 MHz; Type: D835V2; Serial: D835V2 - SN: 4d151

Communication System: CW; Frequency: 835 MHz

Medium parameters used; $f = 835$ MHz; $\sigma = 0.94$ S/m; $\epsilon_r = 40.9$; $\rho = 1000$ kg/m³

Phantom section: Flat Section

Measurement Standard: DASY5 (IEEE/IEC/ANSI C63.19-2007)

DASY52 Configuration:

- Probe: ES3DV3 - SN3205; ConvF(6.05, 6.05, 6.05); Calibrated: 28.12.2012;
- Sensor-Surface: 3mm (Mechanical Surface Detection)
- Electronics: DAE4 Sn601; Calibrated: 27.06.2012
- Phantom: Flat Phantom 4.9L; Type: QD000P49AA; Serial: 1001
- DASY52 52.8.5(1059); SEMCAD X 14.6.8(7028)

Dipole Calibration for Head Tissue/Pin=250 mW, d=15mm/Zoom Scan (7x7x7)/Cube 0:

Measurement grid: dx=5mm, dy=5mm, dz=5mm

Reference Value = 56.742 V/m; Power Drift = 0.01 dB

Peak SAR (extrapolated) = 3.74 W/kg

SAR(1 g) = 2.46 W/kg; SAR(10 g) = 1.59 W/kg

Maximum value of SAR (measured) = 2.88 W/kg

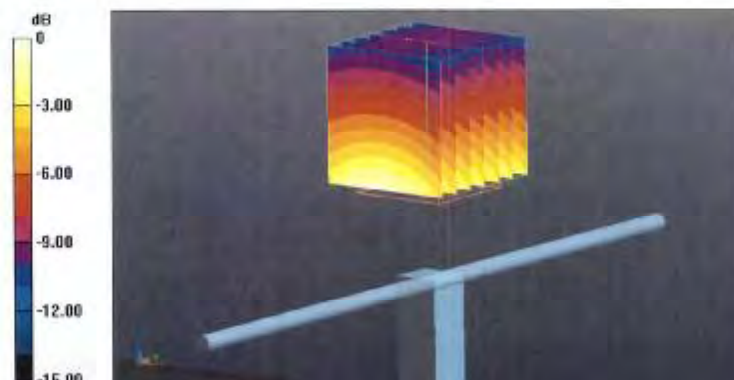

0 dB = 2.88 W/kg = 4.59 dBW/kg

Impedance Measurement Plot for Head TSL

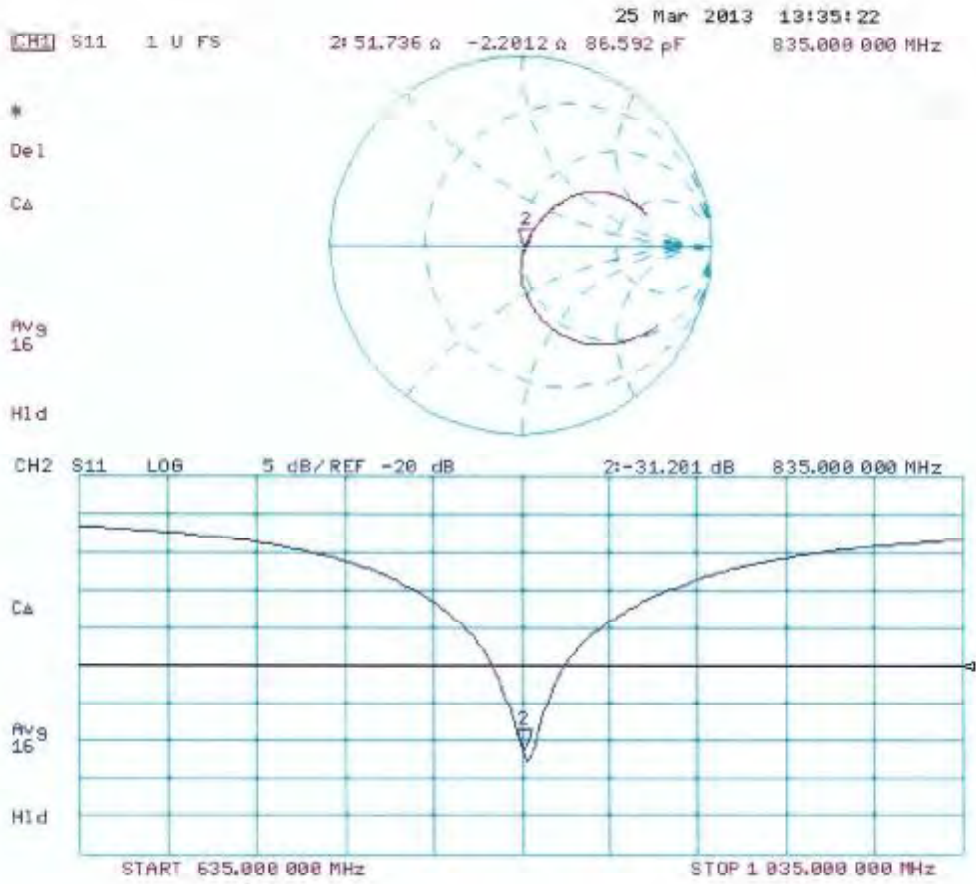

DASY5 Validation Report for Body TSL

Date: 25.03.2013

Test Laboratory: SPEAG, Zurich, Switzerland

DUT: Dipole 835 MHz; Type: D835V2; Serial: D835V2 - SN: 4d151

Communication System: CW; Frequency: 835 MHz

Medium parameters used: $f = 835$ MHz; $\sigma = 1.02$ S/m; $\epsilon_r = 54.1$; $\rho = 1000$ kg/m³

Phantom section: Flat Section

Measurement Standard: DASY5 (IEEE/IEC/ANSI C63.19-2007)

DASY52 Configuration:

- Probe: ES3DV3 - SN3205; ConvF(6.04, 6.04, 6.04); Calibrated: 28.12.2012;
- Sensor-Surface: 3mm (Mechanical Surface Detection)
- Electronics: DAE4 Sn601; Calibrated: 27.06.2012
- Phantom: Flat Phantom 4.9I.; Type: QD000P49AA; Serial: 1001
- DASY52 52.8.5(1059); SEMCAD X 14.6.8(7028)

Dipole Calibration for Body Tissue/Pin=250 mW, d=15mm/Zoom Scan (7x7x7)/Cube 0:

Measurement grid: dx=5mm, dy=5mm, dz=5mm

Reference Value = 54.816 V/m; Power Drift = 0.01 dB

Peak SAR (extrapolated) = 3.63 W/kg

SAR(1 g) = 2.46 W/kg; SAR(10 g) = 1.61 W/kg

Maximum value of SAR (measured) = 2.87 W/kg

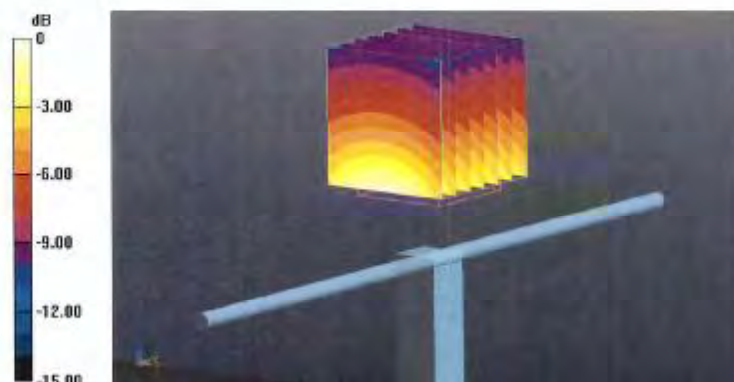

0 dB = 2.87 W/kg = 4.58 dBW/kg

Impedance Measurement Plot for Body TSL

25 Mar 2013 13:05:09
 CH1 S11 1 U FS 2x 47.059 Ω -4.2938 Ω 44.399 pF 835.000 000 MHz

 De1
 Ca
 Avg
 16
 H1d

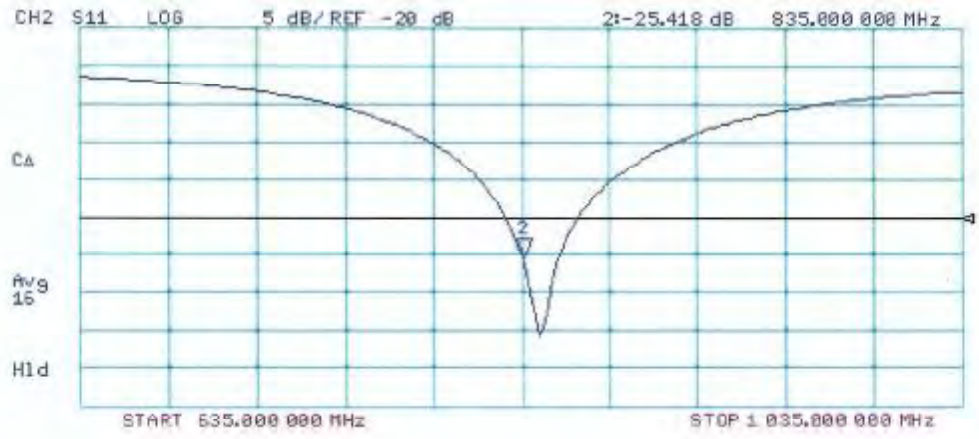
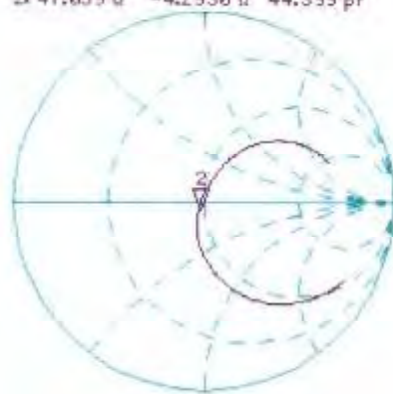

Extended Dipole Calibrations

Referring to KDB 865664 D01 v01r03, if dipoles are verified in return loss (< -20 dB, within 20% of prior calibration), and in impedance (within 5 ohm of prior calibration), the annual calibration is not necessary and the calibration interval can be extended.

<Dipole Verification Data> - D835V2, serial no. 4d151(Date of Measurement 03.24.2014)

835MHz - Head

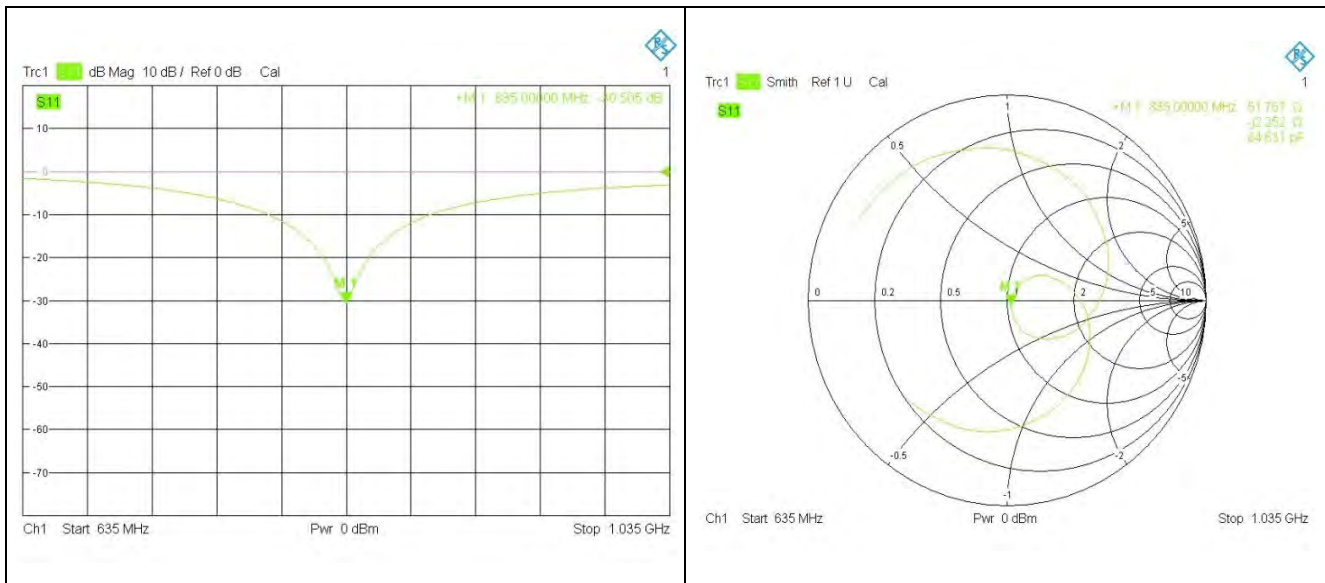

835MHz – Body

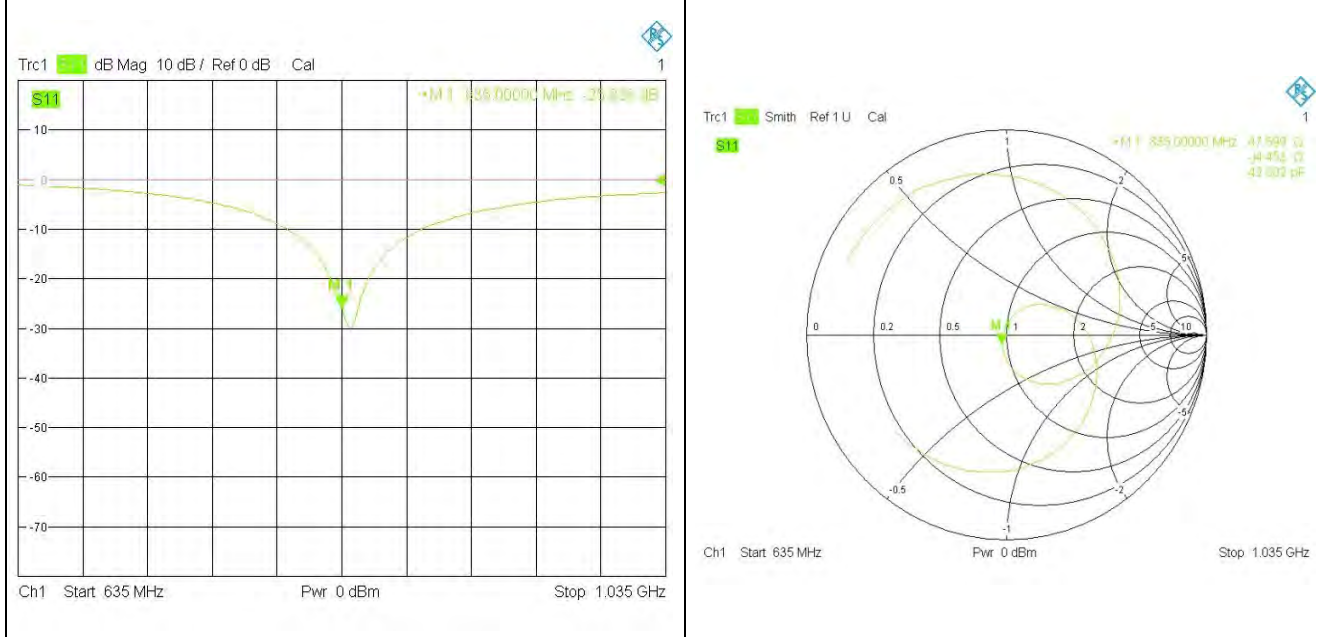



<Justification of the extended calibration>

D835V2 – serial no. 4d151												
TSL	Head						Body					
Date of Measurement	Return-Loss (dB)	Delta (%)	Real Impedance (ohm)	Delta (ohm)	Imaginary Impedance (ohm)	Delta (ohm)	Return-Loss (dB)	Delta (%)	Real Impedance (ohm)	Delta (ohm)	Imaginary Impedance (ohm)	Delta (ohm)
03.25.2013	-31.201		51.736		-2.201		-25.418		47.059		-4.2930	
03.24.2014	-30.505	2.23	51.767	0.031	-2.252	-0.051	-25.828	-1.613	47.599	0.54	-4.453	-0.16

The return loss is < -20dB, within 20% of prior calibration; the impedance is within 5 ohm of prior calibration.
Therefore the verification result should support extended calibration.



Accredited by the Swiss Accreditation Service (SAS)
The Swiss Accreditation Service is one of the signatories to the EA
Multilateral Agreement for the recognition of calibration certificates

Accreditation No.: **SCS 108**

Client **Sporton KS (Auden)**

Certificate No: **D1900V2-5d170_Mar13**

CALIBRATION CERTIFICATE

Object **D1900V2 - SN: 5d170**

Calibration procedure(s) **QA CAL-05.v9
Calibration procedure for dipole validation kits above 700 MHz**

Calibration date: **March 27, 2013**

This calibration certificate documents the traceability to national standards, which realize the physical units of measurements (SI).
The measurements and the uncertainties with confidence probability are given on the following pages and are part of the certificate.

All calibrations have been conducted in the closed laboratory facility; environment temperature (22 ± 3)°C and humidity < 70%.

Calibration Equipment used (M&TE critical for calibration)

Primary Standards	ID #	Cal Date (Certificate No.)	Scheduled Calibration
Power meter EPM-442A	GB37480704	01-Nov-12 (No. 217-01640)	Oct-13
Power sensor HP 8481A	US37292783	01-Nov-12 (No. 217-01640)	Oct-13
Reference 20 dB Attenuator	SN: 5058 (20k)	27-Mar-12 (No. 217-01530)	Apr-13
Type-N mismatch combination	SN: 5047.3 / D6327	27-Mar-12 (No. 217-01533)	Apr-13
Reference Probe ES3DV3	SN: 3205	28-Dec-12 (No. ES3-3205_Dec12)	Dec-13
DAE4	SN: 601	27-Jun-12 (No. DAE4-601_Jun12)	Jun-13
Secondary Standards	ID #	Check Date (in house)	Scheduled Check
Power sensor HP 8481A	MY41092317	18-Oct-02 (in house check Oct-11)	In house check: Oct-13
RF generator R&S SMT-06	100005	04-Aug-99 (in house check Oct-11)	In house check: Oct-13
Network Analyzer HP B753E	US37390585 S4206	18-Oct-01 (in house check Oct-12)	In house check: Oct-13

Calibrated by: **Leif Klysner** Name: **Leif Klysner** Function: **Laboratory Technician**

Signature

Approved by: **Katja Pokovic** Name: **Katja Pokovic** Function: **Technical Manager**

Issued: March 27, 2013

This calibration certificate shall not be reproduced except in full without written approval of the laboratory.



Accredited by the Swiss Accreditation Service (SAS)
The Swiss Accreditation Service is one of the signatories to the EA
Multilateral Agreement for the recognition of calibration certificates

Accreditation No.: **SCS 108**

Glossary:

TSL	tissue simulating liquid
ConvF	sensitivity in TSL / NORM x,y,z
N/A	not applicable or not measured

Calibration is Performed According to the Following Standards:

- IEEE Std 1528-2003, "IEEE Recommended Practice for Determining the Peak Spatial-Averaged Specific Absorption Rate (SAR) in the Human Head from Wireless Communications Devices: Measurement Techniques", December 2003
- IEC 62209-1, "Procedure to measure the Specific Absorption Rate (SAR) for hand-held devices used in close proximity to the ear (frequency range of 300 MHz to 3 GHz)", February 2005
- Federal Communications Commission Office of Engineering & Technology (FCC OET), "Evaluating Compliance with FCC Guidelines for Human Exposure to Radiofrequency Electromagnetic Fields; Additional Information for Evaluating Compliance of Mobile and Portable Devices with FCC Limits for Human Exposure to Radiofrequency Emissions", Supplement C (Edition 01-01) to Bulletin 65

Additional Documentation:

- DASY4/5 System Handbook

Methods Applied and Interpretation of Parameters:

- Measurement Conditions:* Further details are available from the Validation Report at the end of the certificate. All figures stated in the certificate are valid at the frequency indicated.
- Antenna Parameters with TSL:* The dipole is mounted with the spacer to position its feed point exactly below the center marking of the flat phantom section, with the arms oriented parallel to the body axis.
- Feed Point Impedance and Return Loss:* These parameters are measured with the dipole positioned under the liquid filled phantom. The impedance stated is transformed from the measurement at the SMA connector to the feed point. The Return Loss ensures low reflected power. No uncertainty required.
- Electrical Delay:* One-way delay between the SMA connector and the antenna feed point. No uncertainty required.
- SAR measured:* SAR measured at the stated antenna input power.
- SAR normalized:* SAR as measured, normalized to an input power of 1 W at the antenna connector.
- SAR for nominal TSL parameters:* The measured TSL parameters are used to calculate the nominal SAR result.

The reported uncertainty of measurement is stated as the standard uncertainty of measurement multiplied by the coverage factor $k=2$, which for a normal distribution corresponds to a coverage probability of approximately 95%.

Measurement Conditions

DASY system configuration, as far as not given on page 1.

DASY Version	DASY5	V52.8.5
Extrapolation	Advanced Extrapolation	
Phantom	Modular Flat Phantom	
Distance Dipole Center - TSL	10 mm	with Spacer
Zoom Scan Resolution	dx, dy, dz = 5 mm	
Frequency	1900 MHz \pm 1 MHz	

Head TSL parameters

The following parameters and calculations were applied.

	Temperature	Permittivity	Conductivity
Nominal Head TSL parameters	22.0 °C	40.0	1.40 mho/m
Measured Head TSL parameters	(22.0 \pm 0.2) °C	39.3 \pm 6 %	1.38 mho/m \pm 6 %
Head TSL temperature change during test	< 0.5 °C	---	---

SAR result with Head TSL

SAR averaged over 1 cm ³ (1 g) of Head TSL	Condition	
SAR measured	250 mW input power	10.0 W/kg
SAR for nominal Head TSL parameters	normalized to 1W	40.2 W/kg \pm 17.0 % (k=2)

SAR averaged over 10 cm ³ (10 g) of Head TSL	condition	
SAR measured	250 mW input power	5.25 W/kg
SAR for nominal Head TSL parameters	normalized to 1W	21.1 W/kg \pm 16.5 % (k=2)

Body TSL parameters

The following parameters and calculations were applied.

	Temperature	Permittivity	Conductivity
Nominal Body TSL parameters	22.0 °C	53.3	1.52 mho/m
Measured Body TSL parameters	(22.0 \pm 0.2) °C	51.8 \pm 6 %	1.53 mho/m \pm 6 %
Body TSL temperature change during test	< 0.5 °C	---	---

SAR result with Body TSL

SAR averaged over 1 cm ³ (1 g) of Body TSL	Condition	
SAR measured	250 mW input power	10.4 W/kg
SAR for nominal Body TSL parameters	normalized to 1W	41.2 W/kg \pm 17.0 % (k=2)

SAR averaged over 10 cm ³ (10 g) of Body TSL	condition	
SAR measured	250 mW input power	5.49 W/kg
SAR for nominal Body TSL parameters	normalized to 1W	21.8 W/kg \pm 16.5 % (k=2)

Appendix

Antenna Parameters with Head TSL

Impedance, transformed to feed point	$53,8 \Omega + 4,7 j\Omega$
Return Loss	- 24,7 dB

Antenna Parameters with Body TSL

Impedance, transformed to feed point	$49,6 \Omega + 5,0 j\Omega$
Return Loss	- 26,0 dB

General Antenna Parameters and Design

Electrical Delay (one direction)	1.202 ns
----------------------------------	----------

After long term use with 100W radiated power, only a slight warming of the dipole near the feedpoint can be measured.

The dipole is made of standard semirigid coaxial cable. The center conductor of the feeding line is directly connected to the second arm of the dipole. The antenna is therefore short-circuited for DC-signals. On some of the dipoles, small end caps are added to the dipole arms in order to improve matching when loaded according to the position as explained in the "Measurement Conditions" paragraph. The SAR data are not affected by this change. The overall dipole length is still according to the Standard.

No excessive force must be applied to the dipole arms, because they might bend or the soldered connections near the feedpoint may be damaged.

Additional EUT Data

Manufactured by	SPEAG
Manufactured on	June 08, 2012

DASY5 Validation Report for Head TSL

Date: 27.03.2013

Test Laboratory: SPEAG, Zurich, Switzerland

DUT: Dipole 1900 MHz; Type: D1900V2; Serial: D1900V2 - SN: 5d170

Communication System: CW; Frequency: 1900 MHz

Medium parameters used: $f = 1900$ MHz; $\sigma = 1.38$ S/m; $\epsilon_r = 39.3$; $\rho = 1000$ kg/m³

Phantom section: Flat Section

Measurement Standard: DASY5 (IEEE/IEC/ANSI C63.19-2007)

DASY52 Configuration:

- Probe: ES3DV3 - SN3205; ConvF(4.98, 4.98, 4.98); Calibrated: 28.12.2012;
- Sensor-Surface: 3mm (Mechanical Surface Detection)
- Electronics: DAE4 Sn601; Calibrated: 27.06.2012
- Phantom: Flat Phantom 5.0 (front); Type: QD000P50AA; Serial: 1001
- DASY52 52.8.5(1059); SEMCAD X 14.6.8(7028)

Dipole Calibration for Head Tissue/Pin=250 mW, d=10mm/Zoom Scan (7x7x7)/Cube 0:

Measurement grid: dx=5mm, dy=5mm, dz=5mm

Reference Value = 96.871 V/m; Power Drift = 0.05 dB

Peak SAR (extrapolated) = 18.2 W/kg

SAR(1 g) = 10 W/kg; SAR(10 g) = 5.25 W/kg

Maximum value of SAR (measured) = 12.4 W/kg

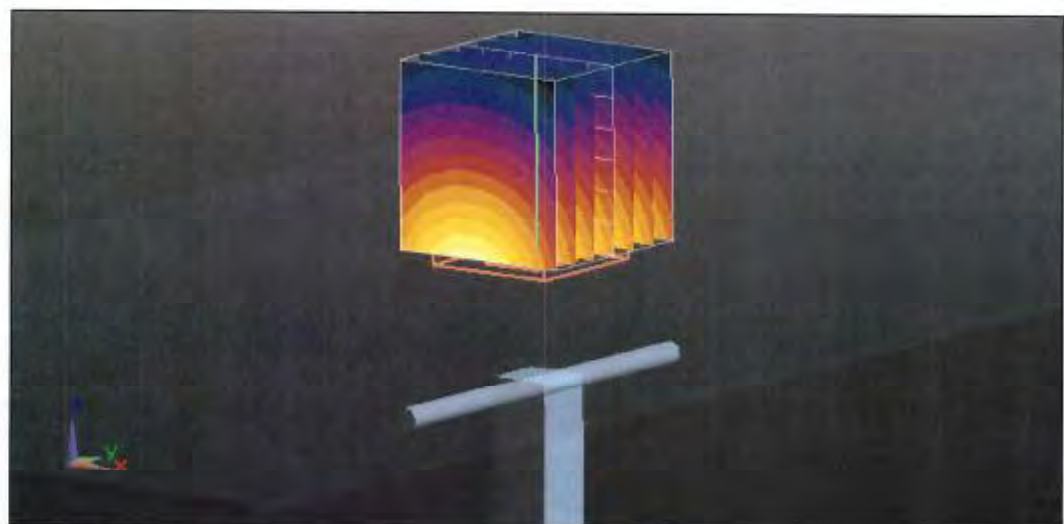
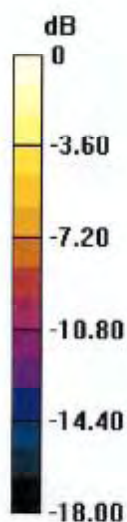

0 dB = 12,4 W/kg = 10,93 dBW/kg

Impedance Measurement Plot for Head TSL

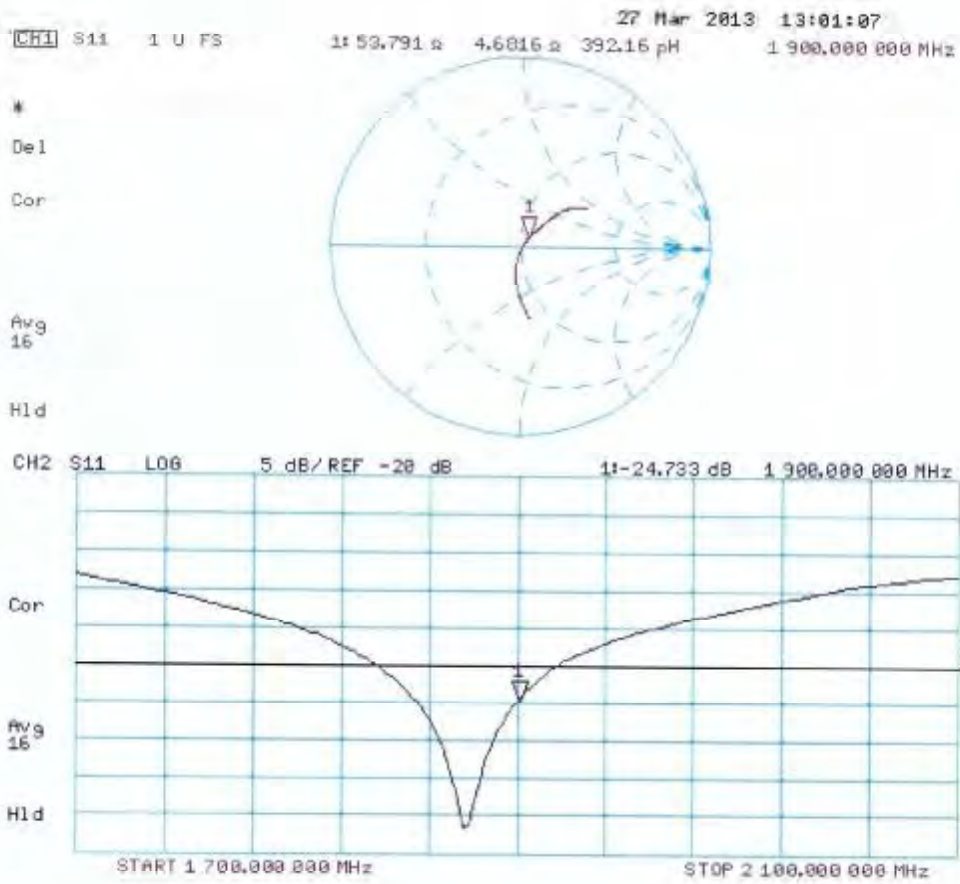

DASY5 Validation Report for Body TSL

Date: 27.03.2013

Test Laboratory: SPEAG, Zurich, Switzerland

DUT: Dipole 1900 MHz; Type: D1900V2; Serial: D1900V2 - SN: 5d170

Communication System: CW; Frequency: 1900 MHz

Medium parameters used: $f = 1900$ MHz; $\sigma = 1.53$ S/m; $\epsilon_r = 51.8$; $\rho = 1000$ kg/m³

Phantom section: Flat Section

Measurement Standard: DASY5 (IEEE/IEC/ANSI C63.19-2007)

DASY52 Configuration:

- Probe: ES3DV3 - SN3205; ConvF(4.6, 4.6, 4.6); Calibrated: 28.12.2012;
- Sensor-Surface; 3mm (Mechanical Surface Detection)
- Electronics: DAE4 Sn601; Calibrated: 27.06.2012
- Phantom: Flat Phantom 5.0 (back); Type: QD000P50AA; Serial: 1002
- DASY52 52.8.5(1059); SEMCAD X 14.6.8(7028)

Dipole Calibration for Body Tissue/Pin=250 mW, d=10mm/Zoom Scan (7x7x7)/Cube 0:

Measurement grid: dx=5mm, dy=5mm, dz=5mm

Reference Value = 96.871 V/m; Power Drift = 0.01 dB

Peak SAR (extrapolated) = 18.0 W/kg

SAR(1 g) = 10.4 W/kg; SAR(10 g) = 5.49 W/kg

Maximum value of SAR (measured) = 13.2 W/kg

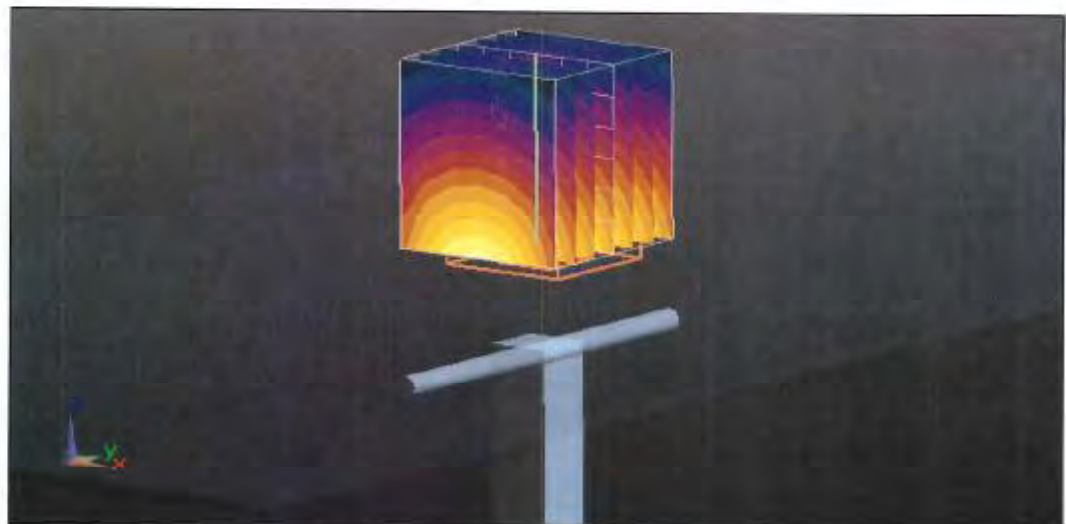
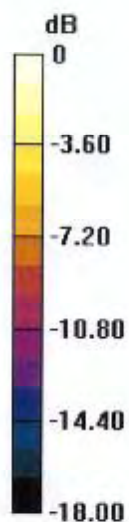

0 dB = 13.2 W/kg = 11.21 dBW/kg

Impedance Measurement Plot for Body TSL

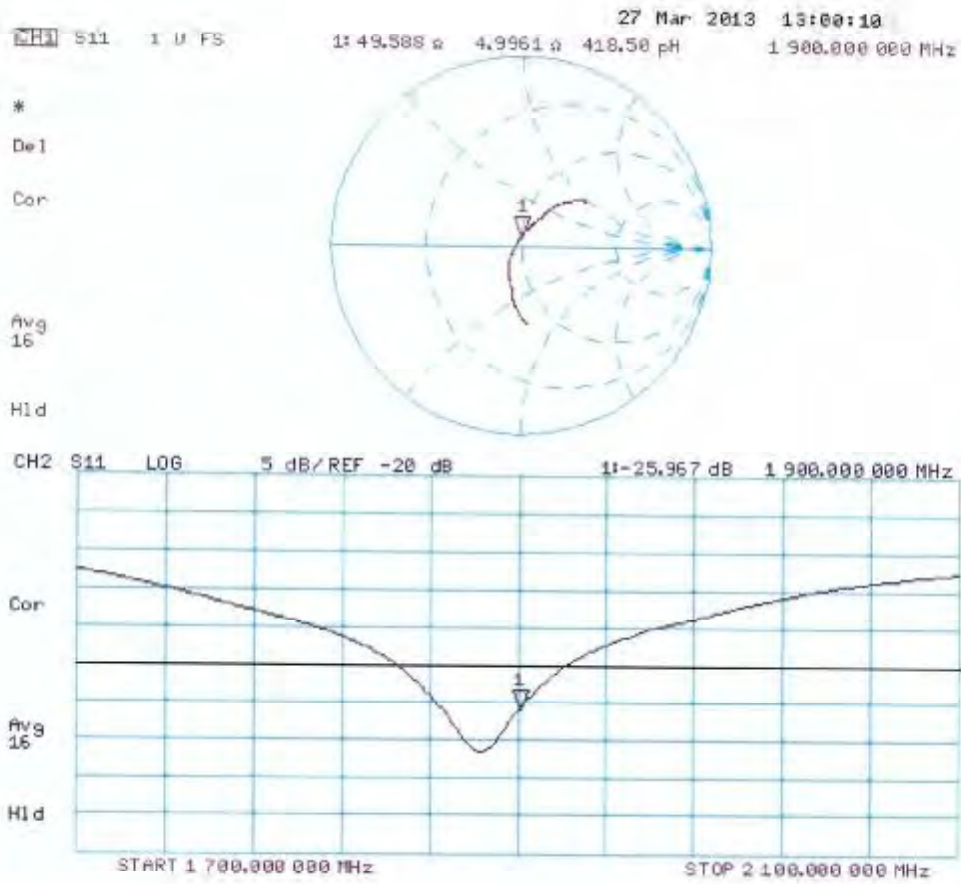

Extended Dipole Calibrations

Referring to KDB 865664 D01 v01r03, if dipoles are verified in return loss (<-20 dB, within 20% of prior calibration), and in impedance (within 5 ohm of prior calibration), the annual calibration is not necessary and the calibration interval can be extended.

<Dipole Verification Data> - D1900V2, serial no. 5d170(Date of Measurement 03.26.2014)

1900MHz - Head

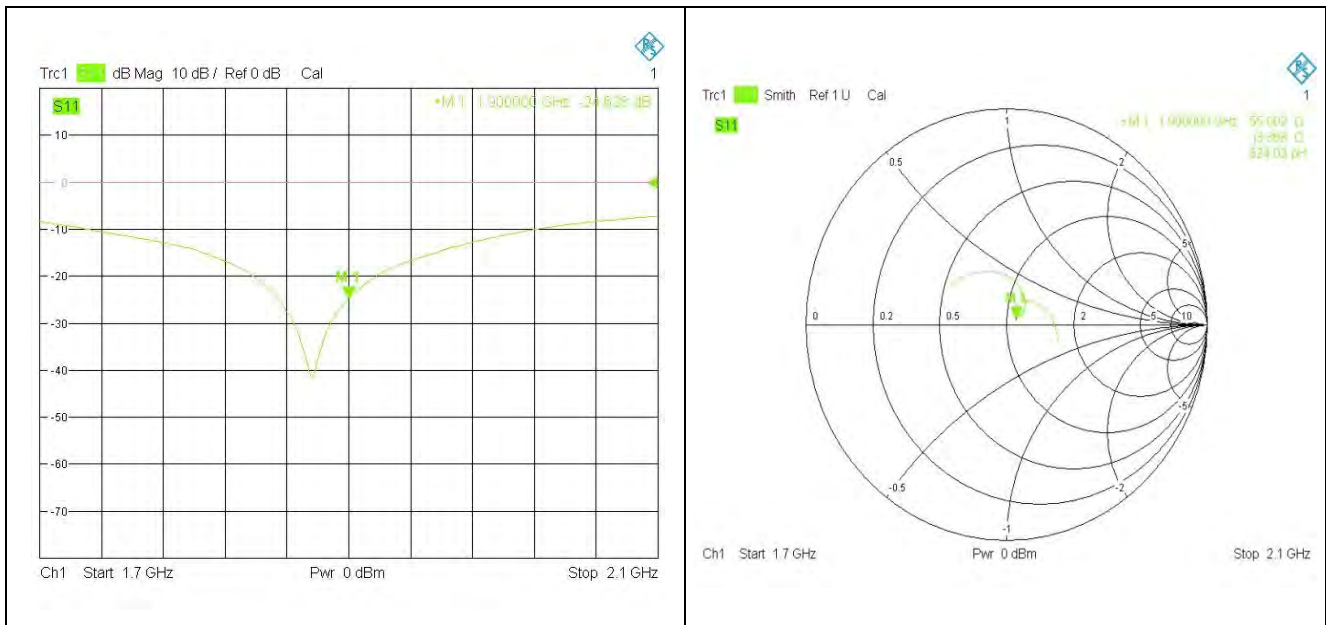

1900MHz – Body

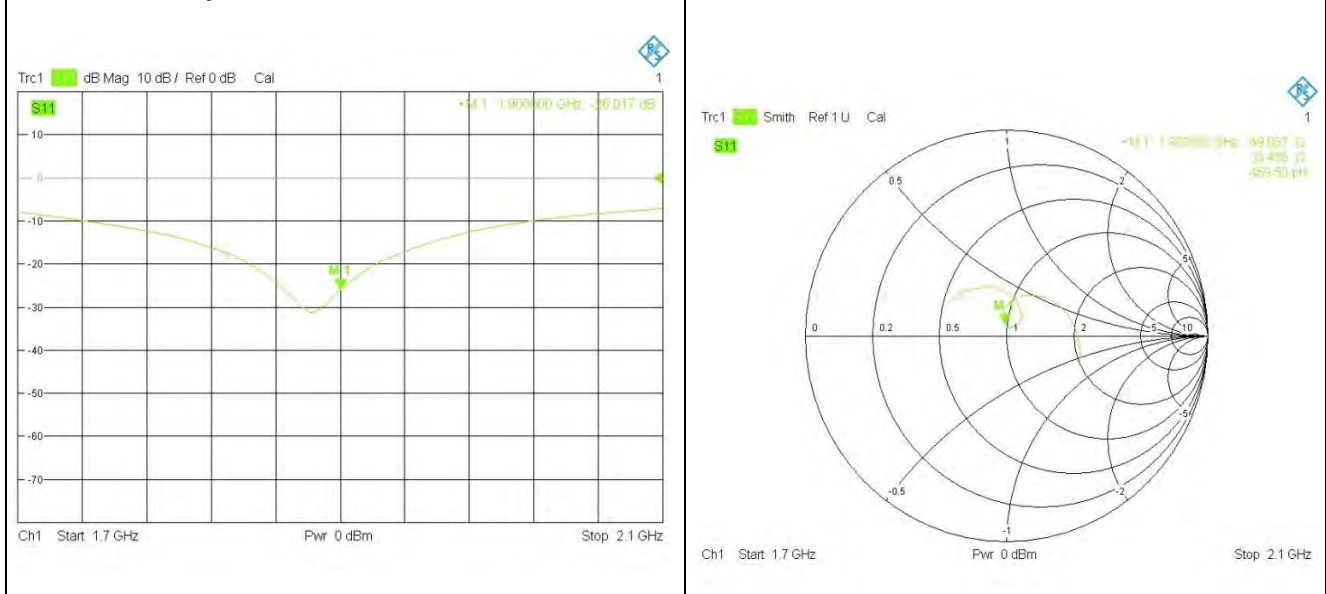



<Justification of the extended calibration>

D1900V2 – serial no. 5d170												
TSL	Head						Body					
Date of Measurement	Return-Loss (dB)	Delta (%)	Real Impedance (ohm)	Delta (ohm)	Imaginary Impedance (ohm)	Delta (ohm)	Return-Loss (dB)	Delta (%)	Real Impedance (ohm)	Delta (ohm)	Imaginary Impedance (ohm)	Delta (ohm)
03.27.2013	-24.733		53.791		4.682		-25.967		49.588		4.996	
03.26.2014	-24.628	0.425	55.002	1.211	3.868	-0.814	-26.017	-0.193	49.067	-0.521	5.486	0.490

The return loss is < -20dB, within 20% of prior calibration; the impedance is within 5 ohm of prior calibration.
Therefore the verification result should support extended calibration.



Accredited by the Swiss Accreditation Service (SAS)
The Swiss Accreditation Service is one of the signatories to the EA
Multilateral Agreement for the recognition of calibration certificates

Accreditation No.: **SCS 108**

Client **Sporton-KS (Auden)**

Certificate No: **D2450V2-908_Mar13**

CALIBRATION CERTIFICATE

Object **D2450V2 - SN: 908**

Calibration procedure(s) **QA CAL-05.v9
Calibration procedure for dipole validation kits above 700 MHz**

Calibration date: **March 26, 2013**

This calibration certificate documents the traceability to national standards, which realize the physical units of measurements (SI).
The measurements and the uncertainties with confidence probability are given on the following pages and are part of the certificate.

All calibrations have been conducted in the closed laboratory facility: environment temperature $(22 \pm 3)^\circ\text{C}$ and humidity $< 70\%$.

Calibration Equipment used (M&TE critical for calibration)

Primary Standards	ID #	Cal Date (Certificate No.)	Scheduled Calibration
Power meter EPM-442A	GB37480704	01-Nov-12 (No. 217-01640)	Oct-13
Power sensor HP 8481A	US37292783	01-Nov-12 (No. 217-01640)	Oct-13
Reference 20 dB Attenuator	SN: 5058 (20k)	27-Mar-12 (No. 217-01530)	Apr-13
Type-N mismatch combination	SN: 5047,3 / 06327	27-Mar-12 (No. 217-01533)	Apr-13
Reference Probe ES3DV3	SN: 3205	28-Dec-12 (No. ES3-3205_Dec12)	Dec-13
DAE4	SN: 601	27-Jun-12 (No. DAE4-601_Jun12)	Jun-13
Secondary Standards	ID #	Check Date (In house)	Scheduled Check
Power sensor HP 8481A	MY41092317	18-Oct-02 (In house check Oct-11)	In house check: Oct-13
RF generator R&S SMT-06	100005	04-Aug-99 (In house check Oct-11)	In house check: Oct-13
Network Analyzer HP 8753E	US37390585 54206	18-Oct-01 (In house check Oct-12)	In house check: Oct-13

Calibrated by: **Name** Claudio Leubler **Function** Laboratory Technician

Signature 

Approved by: **Name** Katja Pokovic **Function** Technical Manager

Issued: March 26, 2013

This calibration certificate shall not be reproduced except in full without written approval of the laboratory.



Accredited by the Swiss Accreditation Service (SAS)
The Swiss Accreditation Service is one of the signatories to the EA
Multilateral Agreement for the recognition of calibration certificates

Accreditation No.: **SCS 108**

Glossary:

TSL	tissue simulating liquid
ConvF	sensitivity in TSL / NORM x,y,z
N/A	not applicable or not measured

Calibration is Performed According to the Following Standards:

- a) IEEE Std 1528-2003, "IEEE Recommended Practice for Determining the Peak Spatial-Averaged Specific Absorption Rate (SAR) in the Human Head from Wireless Communications Devices: Measurement Techniques", December 2003
- b) IEC 62209-1, "Procedure to measure the Specific Absorption Rate (SAR) for hand-held devices used in close proximity to the ear (frequency range of 300 MHz to 3 GHz)", February 2005
- c) Federal Communications Commission Office of Engineering & Technology (FCC OET), "Evaluating Compliance with FCC Guidelines for Human Exposure to Radiofrequency Electromagnetic Fields; Additional Information for Evaluating Compliance of Mobile and Portable Devices with FCC Limits for Human Exposure to Radiofrequency Emissions", Supplement C (Edition 01-01) to Bulletin 65

Additional Documentation:

- d) DAS4/5 System Handbook

Methods Applied and Interpretation of Parameters:

- *Measurement Conditions:* Further details are available from the Validation Report at the end of the certificate. All figures stated in the certificate are valid at the frequency indicated.
- *Antenna Parameters with TSL:* The dipole is mounted with the spacer to position its feed point exactly below the center marking of the flat phantom section, with the arms oriented parallel to the body axis.
- *Feed Point Impedance and Return Loss:* These parameters are measured with the dipole positioned under the liquid filled phantom. The impedance stated is transformed from the measurement at the SMA connector to the feed point. The Return Loss ensures low reflected power. No uncertainty required.
- *Electrical Delay:* One-way delay between the SMA connector and the antenna feed point. No uncertainty required.
- *SAR measured:* SAR measured at the stated antenna input power.
- *SAR normalized:* SAR as measured, normalized to an input power of 1 W at the antenna connector.
- *SAR for nominal TSL parameters:* The measured TSL parameters are used to calculate the nominal SAR result.

The reported uncertainty of measurement is stated as the standard uncertainty of measurement multiplied by the coverage factor $k=2$, which for a normal distribution corresponds to a coverage probability of approximately 95%.

Measurement Conditions

DASY system configuration, as far as not given on page 1.

DASY Version	DASY5	V52.8.5
Extrapolation	Advanced Extrapolation	
Phantom	Modular Flat Phantom	
Distance Dipole Center - TSL	10 mm	with Spacer
Zoom Scan Resolution	dx, dy, dz = 5 mm	
Frequency	2450 MHz \pm 1 MHz	

Head TSL parameters

The following parameters and calculations were applied.

	Temperature	Permittivity	Conductivity
Nominal Head TSL parameters	22.0 °C	39.2	1.80 mho/m
Measured Head TSL parameters	(22.0 \pm 0.2) °C	37.8 \pm 6 %	1.85 mho/m \pm 6 %
Head TSL temperature change during test	< 0.5 °C	----	----

SAR result with Head TSL

SAR averaged over 1 cm ³ (1 g) of Head TSL	Condition	
SAR measured	250 mW input power	13.8 W/kg
SAR for nominal Head TSL parameters	normalized to 1W	54.0 W/kg \pm 17.0 % (k=2)

SAR averaged over 10 cm ³ (10 g) of Head TSL	condition	
SAR measured	250 mW input power	6.36 W/kg
SAR for nominal Head TSL parameters	normalized to 1W	25.1 W/kg \pm 16.5 % (k=2)

Body TSL parameters

The following parameters and calculations were applied.

	Temperature	Permittivity	Conductivity
Nominal Body TSL parameters	22.0 °C	52.7	1.95 mho/m
Measured Body TSL parameters	(22.0 \pm 0.2) °C	50.7 \pm 6 %	2.01 mho/m \pm 6 %
Body TSL temperature change during test	< 0.5 °C	---	---

SAR result with Body TSL

SAR averaged over 1 cm ³ (1 g) of Body TSL	Condition	
SAR measured	250 mW input power	12.9 W/kg
SAR for nominal Body TSL parameters	normalized to 1W	50.4 W/kg \pm 17.0 % (k=2)

SAR averaged over 10 cm ³ (10 g) of Body TSL	condition	
SAR measured	250 mW input power	5.94 W/kg
SAR for nominal Body TSL parameters	normalized to 1W	23.4 W/kg \pm 16.5 % (k=2)

Appendix

Antenna Parameters with Head TSL

Impedance, transformed to feed point	56.5 Ω - 0.1 j Ω
Return Loss	- 24.3 dB

Antenna Parameters with Body TSL

Impedance, transformed to feed point	52.6 Ω + 1.9 j Ω
Return Loss	- 30.0 dB

General Antenna Parameters and Design

Electrical Delay (one direction)	1.156 ns
----------------------------------	----------

After long term use with 100W radiated power, only a slight warming of the dipole near the feedpoint can be measured.

The dipole is made of standard semirigid coaxial cable. The center conductor of the feeding line is directly connected to the second arm of the dipole. The antenna is therefore short-circuited for DC-signals. On some of the dipoles, small end caps are added to the dipole arms in order to improve matching when loaded according to the position as explained in the "Measurement Conditions" paragraph. The SAR data are not affected by this change. The overall dipole length is still according to the Standard.

No excessive force must be applied to the dipole arms, because they might bend or the soldered connections near the feedpoint may be damaged.

Additional EUT Data

Manufactured by	SPEAG
Manufactured on	December 19, 2012

DASY5 Validation Report for Head TSL

Date: 26.03.2013

Test Laboratory: SPEAG, Zurich, Switzerland

DUT: Dipole 2450 MHz; Type: D2450V2; Serial: D2450V2 - SN: 908

Communication System: CW; Frequency: 2450 MHz

Medium parameters used: $f = 2450$ MHz; $\sigma = 1.85$ S/m; $\epsilon_r = 37.8$; $\rho = 1000$ kg/m³

Phantom section: Flat Section

Measurement Standard: DASY5 (IEEE/IEC/ANSI C63.19-2007)

DASY52 Configuration:

- Probe: ES3DV3 - SN3205; ConvF(4.52, 4.52, 4.52); Calibrated: 28.12.2012;
- Sensor-Surface: 3mm (Mechanical Surface Detection)
- Electronics: DAE4 Sn601; Calibrated: 27.06.2012
- Phantom: Flat Phantom 5.0 (front); Type: QD000P50AA; Serial: 1001
- DASY52 52.8.5(1059); SEMCAD X 14.6.8(7028)

Dipole Calibration for Head Tissue/Pin=250 mW, d=10mm/Zoom Scan (7x7x7)/Cube 0:

Measurement grid: dx=5mm, dy=5mm, dz=5mm

Reference Value = 94.957 V/m; Power Drift = 0.04 dB

Peak SAR (extrapolated) = 28.8 W/kg

SAR(1 g) = 13.8 W/kg; SAR(10 g) = 6.36 W/kg

Maximum value of SAR (measured) = 17.9 W/kg

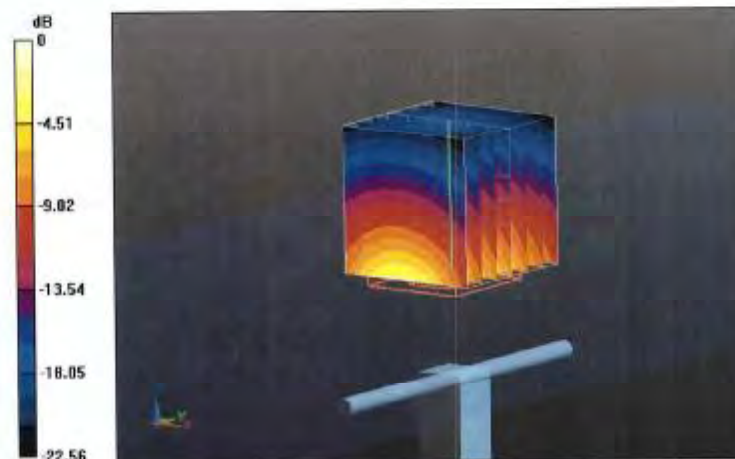

Impedance Measurement Plot for Head TSL

25 Mar 2013 18:42:12
CH1 S11 1 U FS Δ : 56.531 \angle -125.00 m Ω 519.69 pF 2 450.000 000 MHz

De1
Ca
Avg
16
H1d

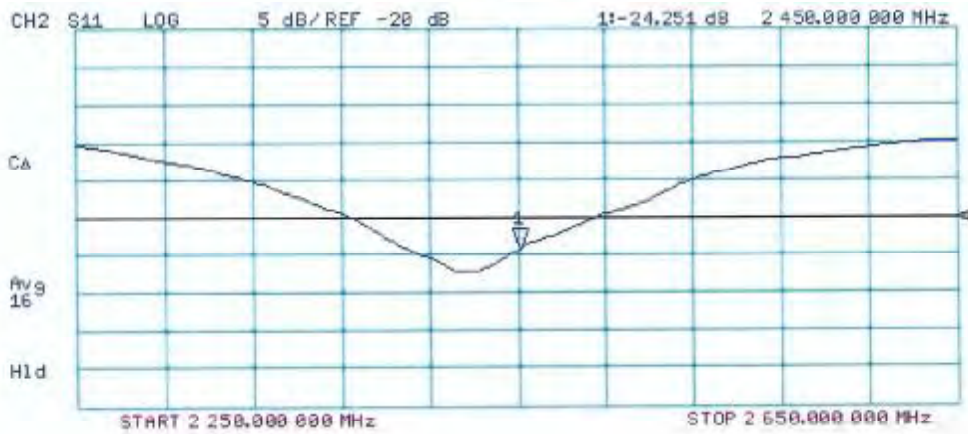
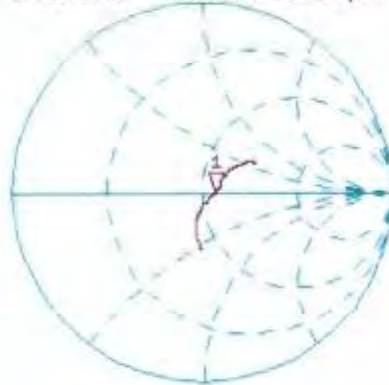

DASY5 Validation Report for Body TSL

Date: 26.03.2013

Test Laboratory: SPEAG, Zurich, Switzerland

DUT: Dipole 2450 MHz; Type: D2450V2; Serial: D2450V2 - SN: 908

Communication System: CW; Frequency: 2450 MHz

Medium parameters used: $f = 2450$ MHz; $\sigma = 2.01$ S/m; $\epsilon_r = 50.7$; $\rho = 1000$ kg/m³

Phantom section: Flat Section

Measurement Standard: DASY5 (IEEE/IEC/ANSI C63.19-2007)

DASY52 Configuration:

- Probe: ES3DV3 - SN3205; ConvF(4.42, 4.42, 4.42); Calibrated: 28.12.2012;
- Sensor-Surface: 3mm (Mechanical Surface Detection)
- Electronics: DAE4 Sn601; Calibrated: 27.06.2012
- Phantom: Flat Phantom 5.0 (back); Type: QD000P50AA; Serial: 1002
- DASY52 52.8.5(1059); SEMCAD X 14.6.8(7028)

Dipole Calibration for Body Tissue/ $P_{in}=250$ mW, $d=10$ mm/Zoom Scan (7x7x7)/Cube 0:

Measurement grid: $dx=5$ mm, $dy=5$ mm, $dz=5$ mm

Reference Value = 94.957 V/m; Power Drift = 0.00 dB

Peak SAR (extrapolated) = 27.0 W/kg

SAR(1 g) = 12.9 W/kg; SAR(10 g) = 5.94 W/kg

Maximum value of SAR (measured) = 17.1 W/kg

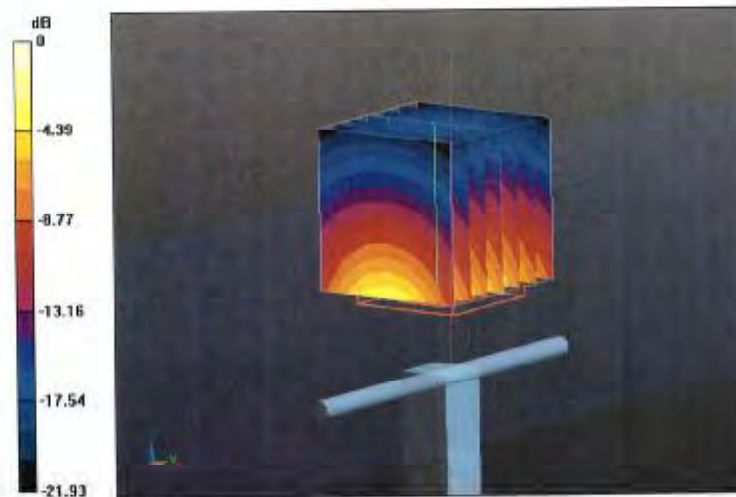

Impedance Measurement Plot for Body TSL

26 Mar 2013 10:42:53
 CH1 S11 1 U FS 1: 52.631 Ω 1.8809 Ω 122.18 μH 2 450.000 000 MHz

*
 Del
 CA

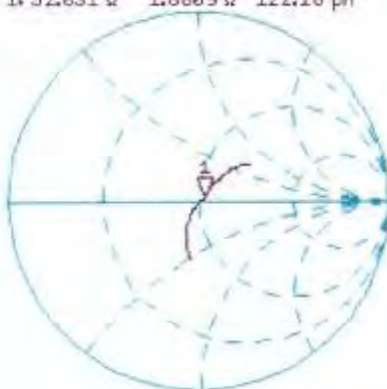

Avg
 15
 H1d

CH2 S11 LOG 5 dB/REF -20 dB 1: -38.033 dB 2 450.000 000 MHz

CA

Avg
 15

H1d

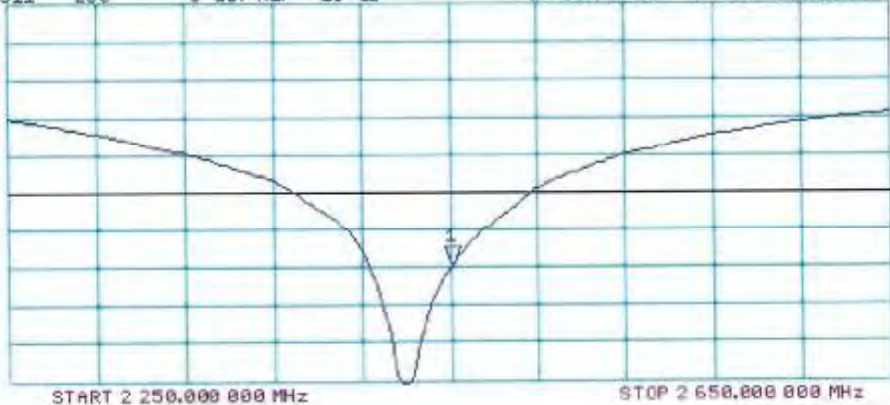

Extended Dipole Calibrations

Referring to KDB 865664 D01 v01r03, if dipoles are verified in return loss ($< -20\text{dB}$, within 20% of prior calibration), and in impedance (within 5 ohm of prior calibration), the annual calibration is not necessary and the calibration interval can be extended.

<Dipole Verification Data> - D2450V2, serial no. 908(Date of Measurement 03.25.2014)

2450MHz - Head

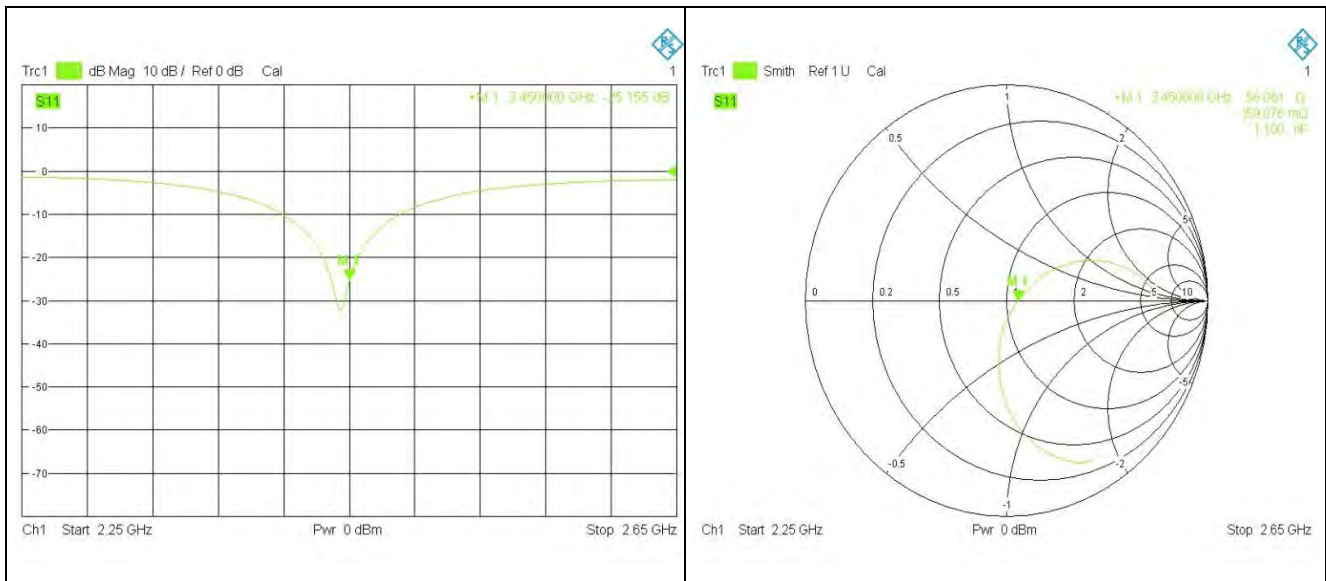

2450MHz – Body

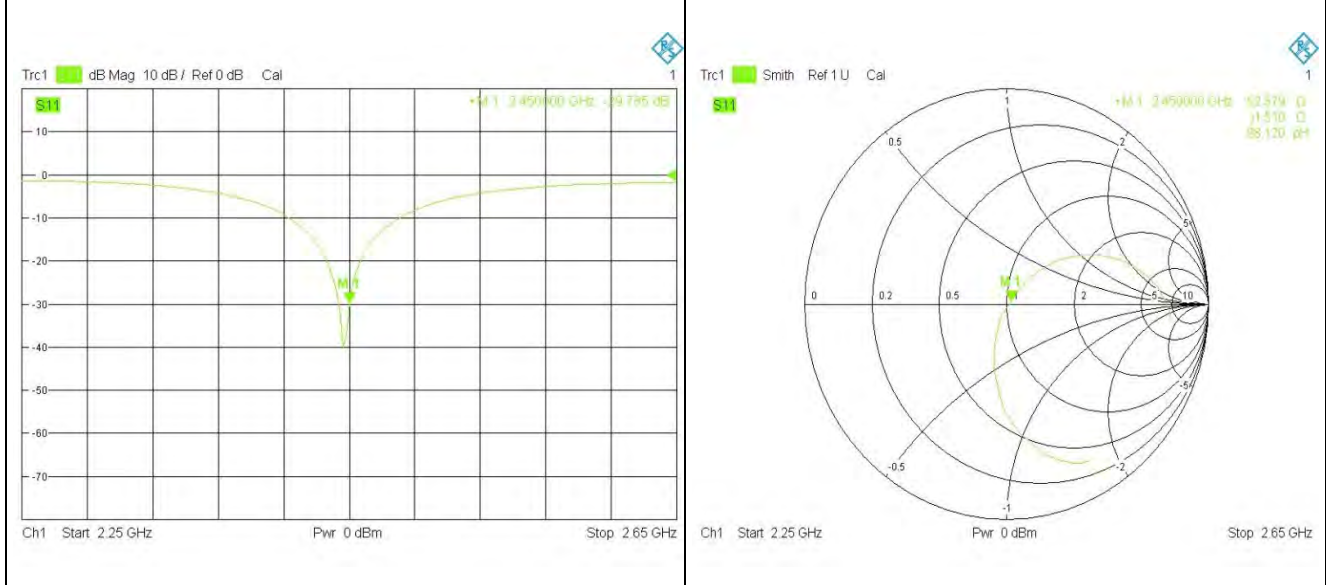



<Justification of the extended calibration>

D2450V2 – serial no. 908												
TSL	Head						Body					
Date of Measurement	Return-Loss (dB)	Delta (%)	Real Impedance (ohm)	Delta (ohm)	Imaginary Impedance (ohm)	Delta (ohm)	Return-Loss (dB)	Delta (%)	Real Impedance (ohm)	Delta (ohm)	Imaginary Impedance (ohm)	Delta (ohm)
03.26.2013	-24.251		56.531		-0.125		-30.033		52.631		1.881	
03.25.2014	-25.155	-0.373	56.061	-0.47	-0.059	0.066	-29.785	0.826	52.379	-0.252	1.510	-0.371

The return loss is < -20dB, within 20% of prior calibration; the impedance is within 5 ohm of prior calibration. Therefore the verification result should support extended calibration.

IMPORTANT NOTICE

USAGE OF THE DAE 4

The DAE unit is a delicate, high precision instrument and requires careful treatment by the user. There are no serviceable parts inside the DAE. Special attention shall be given to the following points:

Battery Exchange: The battery cover of the DAE4 unit is closed using a screw, over tightening the screw may cause the threads inside the DAE to wear out.

Shipping of the DAE: Before shipping the DAE to SPEAG for calibration, remove the batteries and pack the DAE in an antistatic bag. This antistatic bag shall then be packed into a larger box or container which protects the DAE from impacts during transportation. The package shall be marked to indicate that a fragile instrument is inside.

E-Stop Failures: Touch detection may be malfunctioning due to broken magnets in the E-stop. Rough handling of the E-stop may lead to damage of these magnets. Touch and collision errors are often caused by dust and dirt accumulated in the E-stop. To prevent E-stop failure, the customer shall always mount the probe to the DAE carefully and keep the DAE unit in a non-dusty environment if not used for measurements.

Repair: Minor repairs are performed at no extra cost during the annual calibration. However, SPEAG reserves the right to charge for any repair especially if rough unprofessional handling caused the defect.

DASY Configuration Files: Since the exact values of the DAE input resistances, as measured during the calibration procedure of a DAE unit, are not used by the DASY software, a nominal value of 200 MOhm is given in the corresponding configuration file.

Important Note:

Warranty and calibration is void if the DAE unit is disassembled partly or fully by the Customer.

Important Note:

Never attempt to grease or oil the E-stop assembly. Cleaning and readjusting of the E-stop assembly is allowed by certified SPEAG personnel only and is part of the annual calibration procedure.

Important Note:

To prevent damage of the DAE probe connector pins, use great care when installing the probe to the DAE. Carefully connect the probe with the connector notch oriented in the mating position. Avoid any rotational movement of the probe body versus the DAE while turning the locking nut of the connector. The same care shall be used when disconnecting the probe from the DAE.



Accredited by the Swiss Accreditation Service (SAS)
 The Swiss Accreditation Service is one of the signatories to the EA
 Multilateral Agreement for the recognition of calibration certificates

Accreditation No.: **SCS 108**

Client **Sporton CN (Auden)**

Certificate No: **DAE4-1358_Apr14**

CALIBRATION CERTIFICATE

Object **DAE4 - SD 000 D04 BJ - SN: 1358**

Calibration procedure(s) **QA CAL-06.v26**
Calibration procedure for the data acquisition electronics (DAE)

Calibration date: **April 30, 2014**

This calibration certificate documents the traceability to national standards, which realize the physical units of measurements (SI).
 The measurements and the uncertainties with confidence probability are given on the following pages and are part of the certificate.

All calibrations have been conducted in the closed laboratory facility: environment temperature (22 ± 3)°C and humidity < 70%.

Calibration Equipment used (M&TE critical for calibration)

Primary Standards	ID #	Cal Date (Certificate No.)	Scheduled Calibration
Keithley Multimeter Type 2001	SN: 0810278	01-Oct-13 (No:13976)	Oct-14
Secondary Standards	ID #	Check Date (in house)	Scheduled Check
Auto DAE Calibration Unit	SE UWS 053 AA 1001	07-Jan-14 (in house check)	In house check: Jan-15
Calibrator Box V2.1	SE UMS 006 AA 1002	07-Jan-14 (in house check)	In house check: Jan-15

	Name	Function	Signature
Calibrated by:	R.Mayoraz	Technician	<i>R. Mayoraz</i>

Approved by:	Fin Bomholt	Deputy Technical Manager	<i>F. Bomholt</i>
--------------	-------------	--------------------------	-------------------

Issued: April 30, 2014

This calibration certificate shall not be reproduced except in full without written approval of the laboratory.



Accredited by the Swiss Accreditation Service (SAS)

The Swiss Accreditation Service is one of the signatories to the EA
Multilateral Agreement for the recognition of calibration certificates

Accreditation No.: **SCS 108**

Glossary

DAE	data acquisition electronics
Connector angle	information used in DASY system to align probe sensor X to the robot coordinate system.

Methods Applied and Interpretation of Parameters

- *DC Voltage Measurement:* Calibration Factor assessed for use in DASY system by comparison with a calibrated instrument traceable to national standards. The figure given corresponds to the full scale range of the voltmeter in the respective range.
- *Connector angle:* The angle of the connector is assessed measuring the angle mechanically by a tool inserted. Uncertainty is not required.
- The following parameters as documented in the Appendix contain technical information as a result from the performance test and require no uncertainty.
 - *DC Voltage Measurement Linearity:* Verification of the Linearity at +10% and -10% of the nominal calibration voltage. Influence of offset voltage is included in this measurement.
 - *Common mode sensitivity:* Influence of a positive or negative common mode voltage on the differential measurement.
 - *Channel separation:* Influence of a voltage on the neighbor channels not subject to an input voltage.
 - *AD Converter Values with inputs shorted:* Values on the internal AD converter corresponding to zero input voltage
 - *Input Offset Measurement:* Output voltage and statistical results over a large number of zero voltage measurements.
 - *Input Offset Current:* Typical value for information; Maximum channel input offset current, not considering the input resistance.
 - *Input resistance:* Typical value for information: DAE input resistance at the connector, during internal auto-zeroing and during measurement.
 - *Low Battery Alarm Voltage:* Typical value for information. Below this voltage, a battery alarm signal is generated.
 - *Power consumption:* Typical value for information. Supply currents in various operating modes.

DC Voltage Measurement

A/D - Converter Resolution nominal

High Range: 1LSB = 6.1 μ V, full range = -100...+300 mV

Low Range: 1LSB = 61nV, full range = -1.....+3mV

DASY measurement parameters: Auto Zero Time: 3 sec; Measuring time: 3 sec

Calibration Factors	X	Y	Z
High Range	403.476 \pm 0.02% (k=2)	403.505 \pm 0.02% (k=2)	403.509 \pm 0.02% (k=2)
Low Range	3.96075 \pm 1.50% (k=2)	3.98590 \pm 1.50% (k=2)	3.99195 \pm 1.50% (k=2)

Connector Angle

Connector Angle to be used in DASY system	136.0 $^{\circ}$ \pm 1 $^{\circ}$
---	-------------------------------------

Appendix

1. DC Voltage Linearity

High Range	Reading (μV)	Difference (μV)	Error (%)
Channel X + Input	200038.03	1.76	0.00
Channel X + Input	20005.43	1.37	0.01
Channel X - Input	-20004.06	1.92	-0.01
Channel Y + Input	200034.40	-1.98	-0.00
Channel Y + Input	20002.81	-0.99	-0.00
Channel Y - Input	-20005.22	0.94	-0.00
Channel Z + Input	200037.68	1.44	0.00
Channel Z + Input	20002.59	-1.11	-0.01
Channel Z - Input	-20007.07	-0.94	0.00

Low Range	Reading (μV)	Difference (μV)	Error (%)
Channel X + Input	2000.15	-0.26	-0.01
Channel X + Input	201.04	0.44	0.22
Channel X - Input	-198.78	0.53	-0.27
Channel Y + Input	2000.38	0.18	0.01
Channel Y + Input	200.06	-0.29	-0.15
Channel Y - Input	-200.10	-0.50	0.25
Channel Z + Input	2000.16	-0.17	-0.01
Channel Z + Input	198.55	-1.98	-0.99
Channel Z - Input	-201.27	-1.72	0.86

2. Common mode sensitivity

DASY measurement parameters: Auto Zero Time: 3 sec; Measuring time: 3 sec

	Common mode Input Voltage (mV)	High Range Average Reading (μV)	Low Range Average Reading (μV)
Channel X	200	23.14	21.30
	- 200	-20.01	-21.49
Channel Y	200	-27.07	-27.39
	- 200	27.21	26.98
Channel Z	200	-11.40	-11.75
	- 200	9.24	9.23

3. Channel separation

DASY measurement parameters: Auto Zero Time: 3 sec; Measuring time: 3 sec

	Input Voltage (mV)	Channel X (μV)	Channel Y (μV)	Channel Z (μV)
Channel X	200	-	3.10	-3.59
Channel Y	200	9.08	-	3.89
Channel Z	200	9.17	6.05	-

4. AD-Converter Values with inputs shorted

DASY measurement parameters: Auto Zero Time: 3 sec; Measuring time: 3 sec

	High Range (LSB)	Low Range (LSB)
Channel X	15575	16462
Channel Y	16051	15758
Channel Z	16070	16201

5. Input Offset Measurement

DASY measurement parameters: Auto Zero Time: 3 sec; Measuring time: 3 sec

Input 10M Ω

	Average (μ V)	min. Offset (μ V)	max. Offset (μ V)	Std. Deviation (μ V)
Channel X	-1.05	-2.31	-0.30	0.37
Channel Y	-0.30	-1.37	0.51	0.40
Channel Z	-1.60	-2.40	-0.66	0.37

6. Input Offset Current

Nominal Input circuitry offset current on all channels: <25fA

7. Input Resistance (Typical values for information)

	Zeroing (kOhm)	Measuring (MOhm)
Channel X	200	200
Channel Y	200	200
Channel Z	200	200

8. Low Battery Alarm Voltage (Typical values for information)

Typical values	Alarm Level (VDC)
Supply (+ Vcc)	+7.9
Supply (- Vcc)	-7.6

9. Power Consumption (Typical values for information)

Typical values	Switched off (mA)	Stand by (mA)	Transmitting (mA)
Supply (+ Vcc)	+0.01	+6	+14
Supply (- Vcc)	-0.01	-8	-9



Accredited by the Swiss Accreditation Service (SAS)
The Swiss Accreditation Service is one of the signatories to the EA
Multilateral Agreement for the recognition of calibration certificates

Accreditation No.: **SCS 108**

Client **Sporton-CN (Auden)**

Certificate No: **EX3-3911_Oct14**

CALIBRATION CERTIFICATE

Object: **EX3DV4 - SN:3911**

Calibration procedure(s): **QA CAL-01.v9, QA CAL-23.v5, QA CAL-25.v6
Calibration procedure for dosimetric E-field probes**

Calibration date: **October 2, 2014**

This calibration certificate documents the traceability to national standards, which realize the physical units of measurements (SI).
The measurements and the uncertainties with confidence probability are given on the following pages and are part of the certificate.

All calibrations have been conducted in the closed laboratory facility: environment temperature (22 ± 3)°C and humidity < 70%.

Calibration Equipment used (M&TE critical for calibration)

Primary Standards	ID	Cal Date (Certificate No.)	Scheduled Calibration
Power meter E4419B	GB41293874	03-Apr-14 (No. 217-01911)	Apr-15
Power sensor E4412A	MY41498087	03-Apr-14 (No. 217-01911)	Apr-15
Reference 3 dB Attenuator	SN: S5054 (3c)	03-Apr-14 (No. 217-01915)	Apr-15
Reference 20 dB Attenuator	SN: S5277 (20x)	03-Apr-14 (No. 217-01919)	Apr-15
Reference 30 dB Attenuator	SN: S5129 (30b)	03-Apr-14 (No. 217-01920)	Apr-15
Reference Probe ES3DV2	SN: 3013	30-Dec-13 (No. ES3-3013_Dec13)	Dec-14
DAE4	SN: 660	13-Dec-13 (No. DAE4-660_Dec13)	Dec-14
Secondary Standards	ID	Check Date (in house)	Scheduled Check
RF generator HP 8648C	US3642U01700	4-Aug-99 (in house check Apr-13)	In house check: Apr-16
Network Analyzer HP 8753E	US37390585	18-Oct-01 (in house check Oct-13)	In house check: Oct-14

	Name	Function	Signature
Calibrated by:	Jeton Kastrati	Laboratory Technician	
Approved by:	Katja Pokovic	Technical Manager	

Issued: October 2, 2014

This calibration certificate shall not be reproduced except in full without written approval of the laboratory.



Accredited by the Swiss Accreditation Service (SAS)
The Swiss Accreditation Service is one of the signatories to the EA
Multilateral Agreement for the recognition of calibration certificates

Accreditation No.: **SCS 108**

Glossary:

TSL	tissue simulating liquid
NORM _{x,y,z}	sensitivity in free space
ConvF	sensitivity in TSL / NORM _{x,y,z}
DCP	diode compression point
CF	crest factor (1/duty_cycle) of the RF signal
A, B, C, D	modulation dependent linearization parameters
Polarization φ	φ rotation around probe axis
Polarization ϑ	ϑ rotation around an axis that is in the plane normal to probe axis (at measurement center), i.e., ϑ = 0 is normal to probe axis
Connector Angle	information used in DASY system to align probe sensor X to the robot coordinate system

Calibration is Performed According to the Following Standards:

- a) IEEE Std 1528-2013, "IEEE Recommended Practice for Determining the Peak Spatial-Averaged Specific Absorption Rate (SAR) in the Human Head from Wireless Communications Devices: Measurement Techniques", June 2013
- b) IEC 62209-1, "Procedure to measure the Specific Absorption Rate (SAR) for hand-held devices used in close proximity to the ear (frequency range of 300 MHz to 3 GHz)", February 2005

Methods Applied and Interpretation of Parameters:

- **NORM_{x,y,z}**: Assessed for E-field polarization ϑ = 0 (f ≤ 900 MHz in TEM-cell; f > 1800 MHz: R22 waveguide). NORM_{x,y,z} are only intermediate values, i.e., the uncertainties of NORM_{x,y,z} does not affect the E²-field uncertainty inside TSL (see below *ConvF*).
- **NORM(f)_{x,y,z} = NORM_{x,y,z} * frequency_response** (see Frequency Response Chart). This linearization is implemented in DASY4 software versions later than 4.2. The uncertainty of the frequency response is included in the stated uncertainty of *ConvF*.
- **DCP_{x,y,z}**: DCP are numerical linearization parameters assessed based on the data of power sweep with CW signal (no uncertainty required). DCP does not depend on frequency nor media.
- **PAR**: PAR is the Peak to Average Ratio that is not calibrated but determined based on the signal characteristics
- **A_{x,y,z}; B_{x,y,z}; C_{x,y,z}; D_{x,y,z}; VR_{x,y,z}**: A, B, C, D are numerical linearization parameters assessed based on the data of power sweep for specific modulation signal. The parameters do not depend on frequency nor media. VR is the maximum calibration range expressed in RMS voltage across the diode.
- **ConvF and Boundary Effect Parameters**: Assessed in flat phantom using E-field (or Temperature Transfer Standard for f ≤ 800 MHz) and inside waveguide using analytical field distributions based on power measurements for f > 800 MHz. The same setups are used for assessment of the parameters applied for boundary compensation (alpha, depth) of which typical uncertainty values are given. These parameters are used in DASY4 software to improve probe accuracy close to the boundary. The sensitivity in TSL corresponds to NORM_{x,y,z} * ConvF whereby the uncertainty corresponds to that given for ConvF. A frequency dependent ConvF is used in DASY version 4.4 and higher which allows extending the validity from ± 50 MHz to ± 100 MHz.
- **Spherical isotropy (3D deviation from isotropy)**: in a field of low gradients realized using a flat phantom exposed by a patch antenna.
- **Sensor Offset**: The sensor offset corresponds to the offset of virtual measurement center from the probe tip (on probe axis). No tolerance required.
- **Connector Angle**: The angle is assessed using the information gained by determining the NORM_x (no uncertainty required).

Probe EX3DV4

SN:3911

Manufactured:	September 4, 2012
Repaired:	September 26, 2014
Calibrated:	October 2, 2014

Calibrated for DASY/EASY Systems
(Note: non-compatible with DASY2 system!)

DASY/EASY - Parameters of Probe: EX3DV4 - SN:3911

Basic Calibration Parameters

	Sensor X	Sensor Y	Sensor Z	Unc (k=2)
Norm ($\mu\text{V}/(\text{V}/\text{m})^2$) ^A	0.32	0.42	0.49	$\pm 10.1\%$
DCP (mV) ^B	102.9	96.3	97.7	

Modulation Calibration Parameters

UID	Communication System Name		A dB	B dB $\sqrt{\mu\text{V}}$	C	D dB	VR mV	Unc ^E (k=2)
0	CW	X	0.0	0.0	1.0	0.00	145.4	$\pm 2.5\%$
		Y	0.0	0.0	1.0		141.8	
		Z	0.0	0.0	1.0		136.8	

The reported uncertainty of measurement is stated as the standard uncertainty of measurement multiplied by the coverage factor k=2, which for a normal distribution corresponds to a coverage probability of approximately 95%.

^A The uncertainties of NormX,Y,Z do not affect the E²-field uncertainty inside TSL (see Pages 5 and 6).

^B Numerical linearization parameter: uncertainty not required.

^E Uncertainty is determined using the max. deviation from linear response applying rectangular distribution and is expressed for the square of the field value.

DASY/EASY - Parameters of Probe: EX3DV4 - SN:3911

Calibration Parameter Determined in Head Tissue Simulating Media

f (MHz) ^C	Relative Permittivity ^F	Conductivity (S/m) ^F	ConvF X	ConvF Y	ConvF Z	Alpha ^G	Depth ^G (mm)	Unct. (k=2)
750	41.9	0.89	9.89	9.89	9.89	0.48	0.76	± 12.0 %
835	41.5	0.90	9.62	9.62	9.62	0.55	0.70	± 12.0 %
900	41.5	0.97	9.38	9.38	9.38	0.23	1.18	± 12.0 %
1750	40.1	1.37	8.18	8.18	8.18	0.26	1.01	± 12.0 %
1900	40.0	1.40	7.95	7.95	7.95	0.27	1.01	± 12.0 %
2000	40.0	1.40	7.92	7.92	7.92	0.34	0.88	± 12.0 %
2300	39.5	1.67	7.53	7.53	7.53	0.44	0.73	± 12.0 %
2450	39.2	1.80	7.05	7.05	7.05	0.31	0.92	± 12.0 %
2600	39.0	1.96	6.92	6.92	6.92	0.36	0.92	± 12.0 %

^C Frequency validity above 300 MHz of ± 100 MHz only applies for DASY v4.4 and higher (see Page 2), else it is restricted to ± 50 MHz. The uncertainty is the RSS of the ConvF uncertainty at calibration frequency and the uncertainty for the indicated frequency band. Frequency validity below 300 MHz is ± 10, 25, 40, 50 and 70 MHz for ConvF assessments at 30, 64, 128, 150 and 220 MHz respectively. Above 5 GHz frequency validity can be extended to ± 110 MHz.

^F At frequencies below 3 GHz, the validity of tissue parameters (ϵ and σ) can be relaxed to ± 10% if liquid compensation formula is applied to measured SAR values. At frequencies above 3 GHz, the validity of tissue parameters (ϵ and σ) is restricted to ± 5%. The uncertainty is the RSS of the ConvF uncertainty for indicated target tissue parameters.

^G Alpha/Depth are determined during calibration. SPEAG warrants that the remaining deviation due to the boundary effect after compensation is always less than ± 1% for frequencies below 3 GHz and below ± 2% for frequencies between 3-6 GHz at any distance larger than half the probe tip diameter from the boundary.

DASY/EASY - Parameters of Probe: EX3DV4 - SN:3911

Calibration Parameter Determined in Body Tissue Simulating Media

f (MHz) ^C	Relative Permittivity ^F	Conductivity (S/m) ^F	ConvF X	ConvF Y	ConvF Z	Alpha ^G	Depth ^G (mm)	Unct. (k=2)
750	55.5	0.96	9.61	9.61	9.61	0.20	1.44	± 12.0 %
835	55.2	0.97	9.66	9.66	9.66	0.61	0.65	± 12.0 %
900	55.0	1.05	9.36	9.36	9.36	0.32	1.07	± 12.0 %
1750	53.4	1.49	7.93	7.93	7.93	0.70	0.66	± 12.0 %
1900	53.3	1.52	7.57	7.57	7.57	0.31	0.98	± 12.0 %
2000	53.3	1.52	7.76	7.76	7.76	0.35	0.92	± 12.0 %
2300	52.9	1.81	7.39	7.39	7.39	0.41	0.88	± 12.0 %
2450	52.7	1.95	7.18	7.18	7.18	0.72	0.61	± 12.0 %
2600	52.5	2.16	7.03	7.03	7.03	0.80	0.50	± 12.0 %

^C Frequency validity above 300 MHz of ± 100 MHz only applies for DASY v4.4 and higher (see Page 2), else it is restricted to ± 50 MHz. The uncertainty is the RSS of the ConvF uncertainty at calibration frequency and the uncertainty for the indicated frequency band. Frequency validity below 300 MHz is ± 10, 25, 40, 50 and 70 MHz for ConvF assessments at 30, 64, 128, 150 and 220 MHz respectively. Above 5 GHz frequency validity can be extended to ± 110 MHz.

^F At frequencies below 3 GHz, the validity of tissue parameters (ϵ and σ) can be relaxed to ± 10% if liquid compensation formula is applied to measured SAR values. At frequencies above 3 GHz, the validity of tissue parameters (ϵ and σ) is restricted to ± 5%. The uncertainty is the RSS of the ConvF uncertainty for indicated target tissue parameters.

^G Alpha/Depth are determined during calibration. SPEAG warrants that the remaining deviation due to the boundary effect after compensation is always less than ± 1% for frequencies below 3 GHz and below ± 2% for frequencies between 3-6 GHz at any distance larger than half the probe tip diameter from the boundary.

Frequency Response of E-Field

(TEM-Cell:ifi110 EXX, Waveguide: R22)

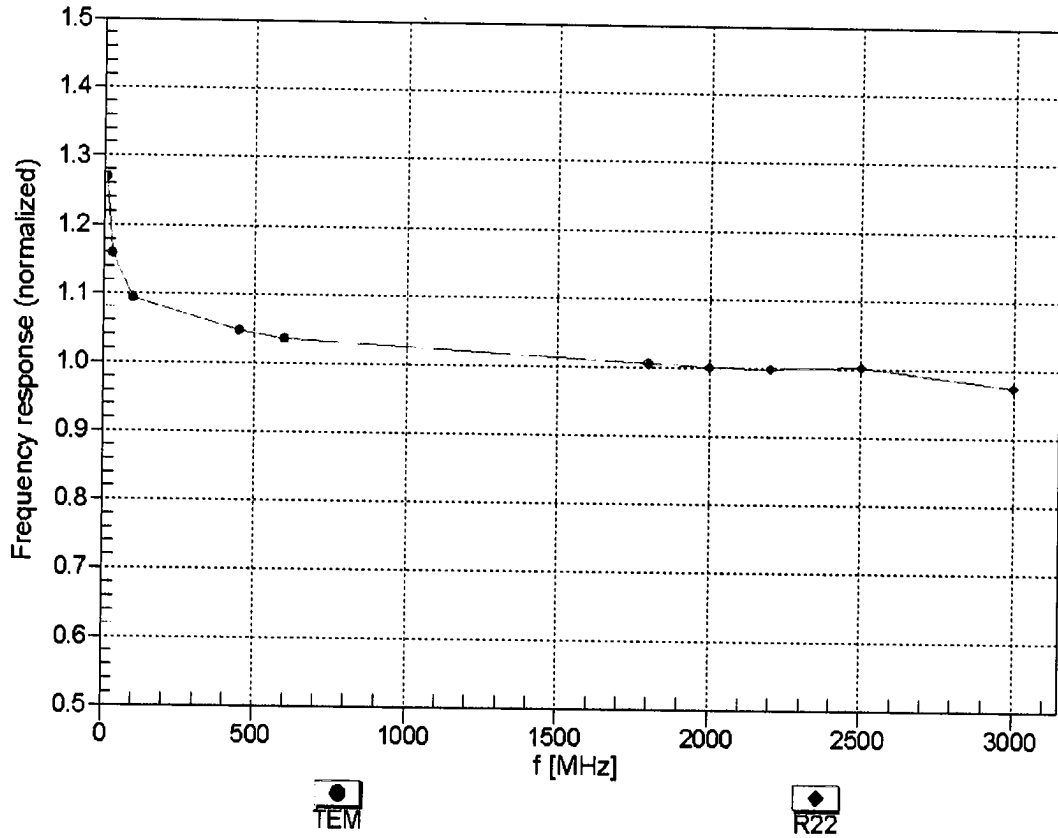

Uncertainty of Frequency Response of E-field: $\pm 6.3\%$ (k=2)

Receiving Pattern (ϕ), $\vartheta = 0^\circ$

f=600 MHz, TEM

f=1800 MHz, R22

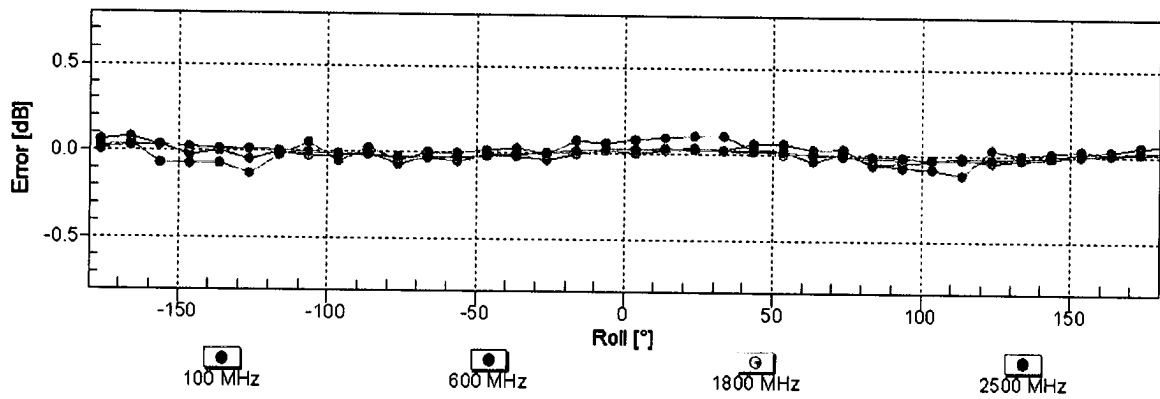
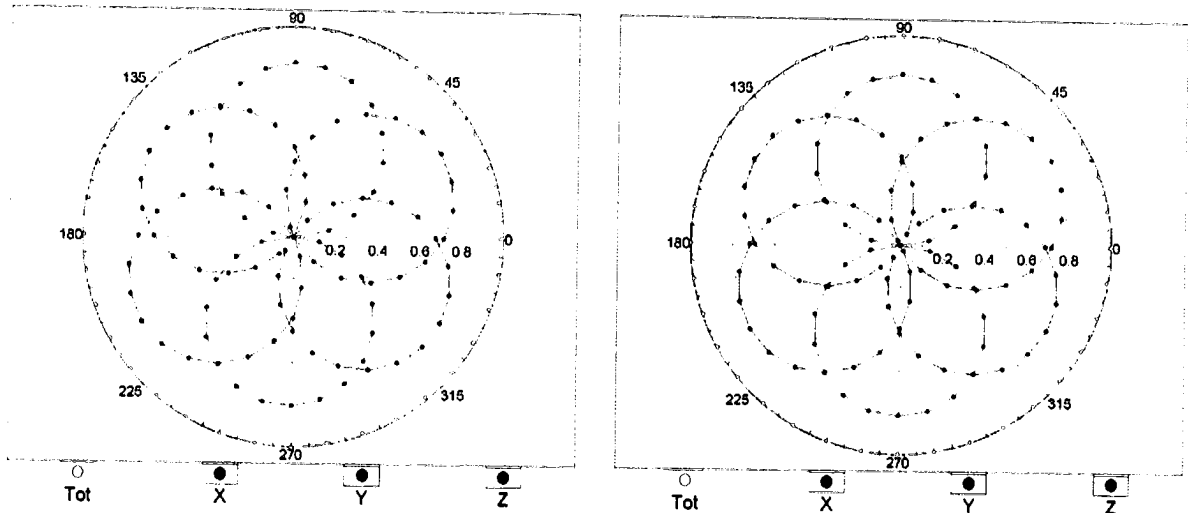

Uncertainty of Axial Isotropy Assessment: $\pm 0.5\%$ (k=2)

Dynamic Range $f(\text{SAR}_{\text{head}})$ (TEM cell , $f_{\text{eval}} = 1900 \text{ MHz}$)

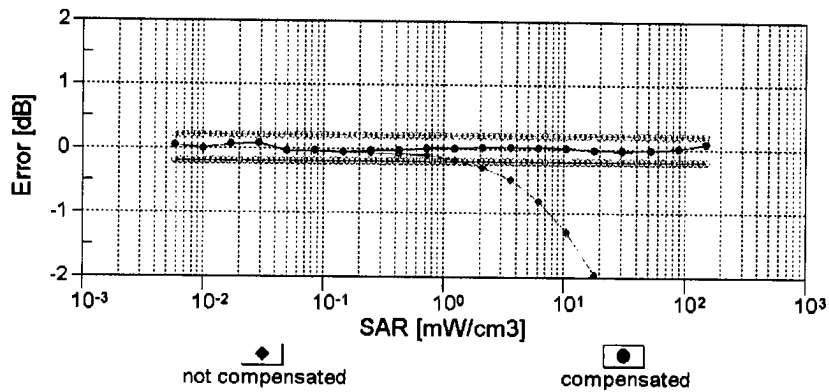
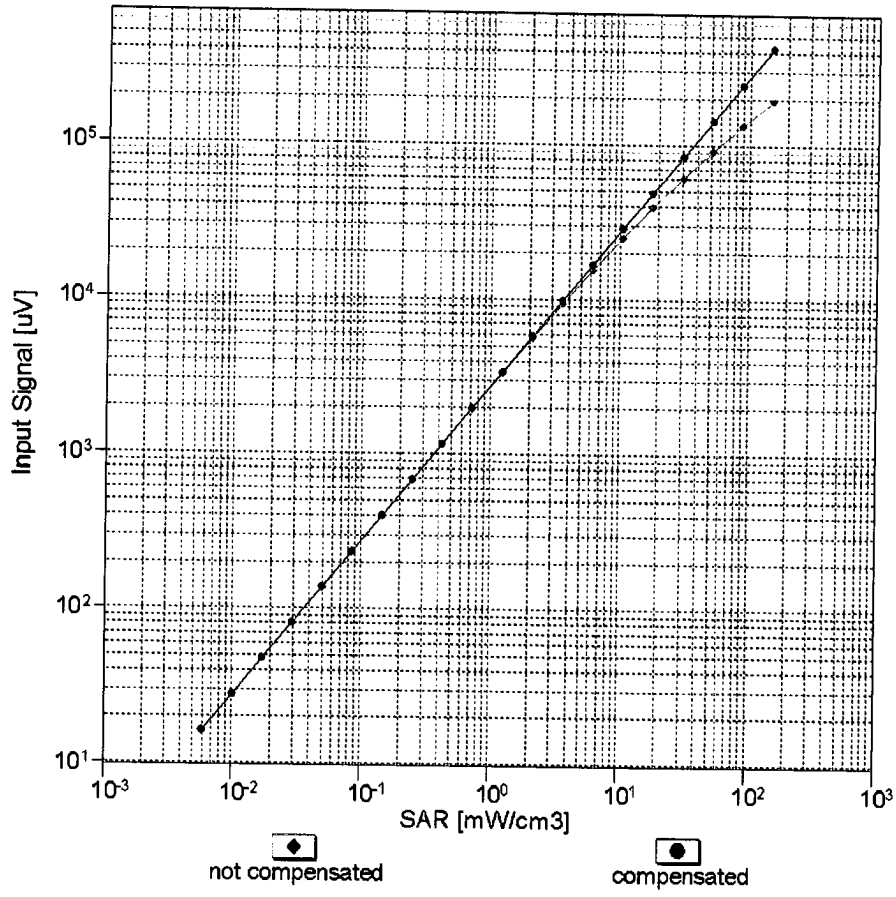

Uncertainty of Linearity Assessment: $\pm 0.6\%$ ($k=2$)

Conversion Factor Assessment

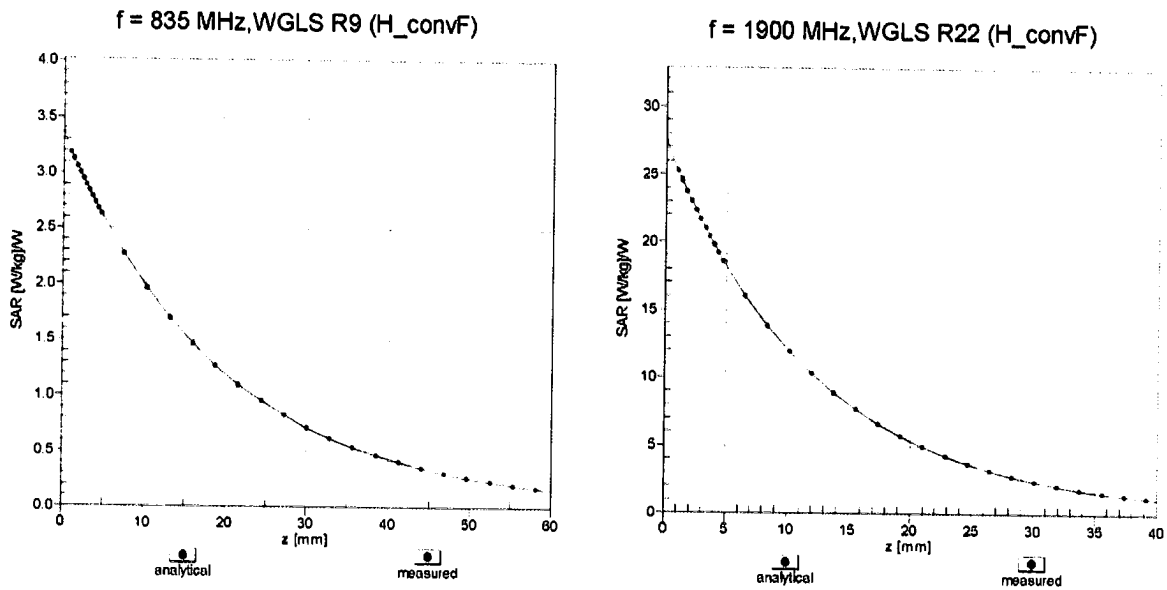

Deviation from Isotropy in Liquid Error (ϕ, θ), f = 900 MHz

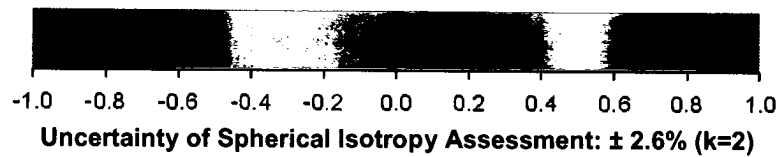
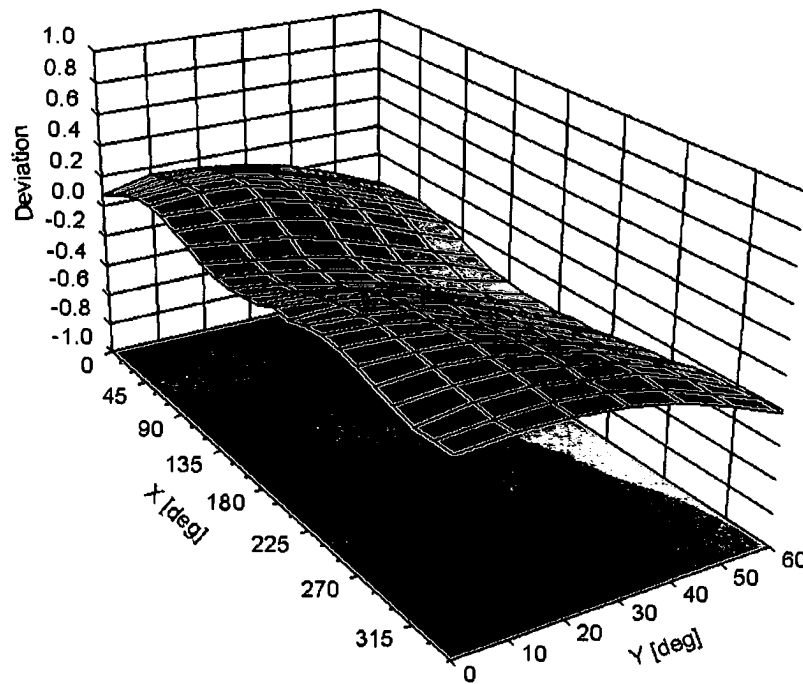



DASY/EASY - Parameters of Probe: EX3DV4 - SN:3911

Other Probe Parameters

Sensor Arrangement	Triangular
Connector Angle (°)	-76.3
Mechanical Surface Detection Mode	enabled
Optical Surface Detection Mode	disabled
Probe Overall Length	337 mm
Probe Body Diameter	10 mm
Tip Length	9 mm
Tip Diameter	2.5 mm
Probe Tip to Sensor X Calibration Point	1 mm
Probe Tip to Sensor Y Calibration Point	1 mm
Probe Tip to Sensor Z Calibration Point	1 mm
Recommended Measurement Distance from Surface	1.4 mm

CUSTOMER COPY

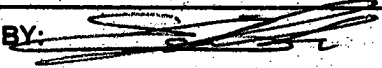
PROBE REPAIR REPORT – SPEAG Production Center

PRODUCT: EX3DV4	
SERIAL Nr.: 3911	IN DATE: 22-Sep-2014
CUSTOMER: Sporton CN (Auden)	
PROBE REPAIR	
MATERIAL	WORK DESCRIPTION
Proximity Sensor (PEEK)	fixed <input type="radio"/> exchanged <input type="radio"/> <input type="radio"/>
Core replacement:	fixed <input type="radio"/> exchanged <input type="radio"/> <input type="radio"/>
Dipole sensor:	fixed <input type="radio"/> exchanged <input type="radio"/> <input type="radio"/>
Substrate:	fixed <input type="radio"/> exchanged <input type="radio"/> <input type="radio"/>
Components (diodes)	fixed <input type="radio"/> exchanged <input type="radio"/> all Diodes <input checked="" type="checkbox"/>
Components (capacitors)	fixed <input type="radio"/> exchanged <input type="radio"/> <input type="radio"/>
Bonding R-lines - substrate	fixed <input type="radio"/> exchanged <input type="radio"/> <input type="radio"/>
Probe tip:	fixed <input type="radio"/> exchanged <input type="radio"/> <input type="radio"/>
Probe connector:	fixed <input type="radio"/> exchanged <input checked="" type="checkbox"/> <input type="radio"/>
Probe tube	fixed <input type="radio"/> exchanged <input type="radio"/> <input type="radio"/>
Modification DS installed:	fixed <input type="radio"/> installed <input type="radio"/> <input type="radio"/>
Analysis: <input type="radio"/>
Final Assembly: <input type="radio"/>
Total hours	4.50 hours
COMMENTS:	
The probe was returned for repair. Receiving inspection found low response on all channel. The probe was opened for further inspection. The channel diode was found to be defective. Bonding on all diodes is good. in order to re establish full probe functionality all 3 diodes and the probe connector were replaced. The probe will get newly calibrated after this repair.	
CONDUCTED BY: 	APPROVED BY: 
DATE: 26-Sep-2014	DATE: 26-Sep-2014
REPAIR COST:	
MATERIAL COST: free <input type="radio"/>	USD <input type="radio"/> Euro <input type="radio"/>
REPAIR: free <input type="radio"/>	USD <input type="radio"/> Euro <input type="radio"/>
TOTAL COST: S+M	QUOTATION #: -
APPROVED BY: 	
DATE: 26-Sep-2014	