



# FCC RF Test Report

**APPLICANT** : Brightstar Corporation  
**EQUIPMENT** : Smart Phone  
**BRAND NAME** : Avvio  
**MODEL NAME** : Avvio 774S, Avvio 774  
**FCC ID** : WVBA774X  
**STANDARD** : FCC Part 15 Subpart C §15.247  
**CLASSIFICATION** : (DTS) Digital Transmission System

The product was received on Jun. 26, 2015 and testing was completed on Jul. 28, 2015. We, SPORTON INTERNATIONAL (SHENZHEN) INC., would like to declare that the tested sample has been evaluated in accordance with the test procedures and has been in compliance with the applicable technical standards.

The test results in this report apply exclusively to the tested model / sample. Without written approval of SPORTON INTERNATIONAL (SHENZHEN) INC., the test report shall not be reproduced except in full.

Reviewed by: Joseph Lin / Supervisor

Approved by: Jones Tsai / Manager



**SPORTON INTERNATIONAL (SHENZHEN) INC.**

1F & 2F, Building A, Morning Business Center, No. 4003 ShiGu Rd., Xili Town,  
Nanshan District, Shenzhen, Guangdong, P. R. China



# TABLE OF CONTENTS

**REVISION HISTORY..... 3**

**SUMMARY OF TEST RESULT ..... 4**

**1 GENERAL DESCRIPTION ..... 5**

    1.1 Applicant ..... 5

    1.2 Manufacturer ..... 5

    1.3 Product Feature of Equipment Under Test ..... 5

    1.4 Product Specification subjective to this standard ..... 6

    1.5 Modification of EUT ..... 6

    1.6 Testing Location ..... 7

    1.7 Applicable Standards ..... 8

**2 TEST CONFIGURATION OF EQUIPMENT UNDER TEST ..... 9**

    2.1 Carrier Frequency Channel ..... 9

    2.2 Pre-Scanned RF Power ..... 10

    2.3 Test Mode ..... 11

    2.4 Connection Diagram of Test System ..... 12

    2.5 Support Unit used in test configuration and system ..... 13

    2.6 EUT Operation Test Setup ..... 13

    2.7 Measurement Results Explanation Example ..... 14

**3 TEST RESULT ..... 15**

    3.1 6dB Bandwidth Measurement ..... 15

    3.2 Output Power Measurement ..... 17

    3.3 Power Spectral Density Measurement ..... 19

    3.4 Conducted Band Edges and Spurious Emission Measurement ..... 21

    3.5 Radiated Band Edges and Spurious Emission Measurement ..... 34

    3.6 AC Conducted Emission Measurement ..... 38

    3.7 Antenna Requirements ..... 42

**4 LIST OF MEASURING EQUIPMENT ..... 43**

**5 UNCERTAINTY OF EVALUATION ..... 44**

**APPENDIX A. CONDUCTED TEST RESULTS**

**APPENDIX B. RADIATED TEST RESULTS**

**APPENDIX C. SETUP PHOTOGRAPHS**





### SUMMARY OF TEST RESULT

Report Section	FCC Rule	Description	Limit	Result	Remark
3.1	15.247(a)(2)	6dB Bandwidth	$\geq 0.5\text{MHz}$	Pass	-
3.2	15.247(b)	Power Output Measurement	$\leq 30\text{dBm}$	Pass	-
3.3	15.247(e)	Power Spectral Density	$\leq 8\text{dBm}/3\text{kHz}$	Pass	-
3.4	15.247(d)	Conducted Band Edges	$\leq 20\text{dBc}$	Pass	-
		Conducted Spurious Emission		Pass	-
3.5	15.247(d)	Radiated Band Edges and Radiated Spurious Emission	15.209(a) & 15.247(d)	Pass	Under limit 3.19 dB at 2388.930 MHz
3.6	15.207	AC Conducted Emission	15.207(a)	Pass	Under limit 22.48 dB at 0.510 MHz
3.7	15.203 & 15.247(b)	Antenna Requirement	N/A	Pass	-



# 1 General Description

## 1.1 Applicant

**Brightstar Corporation**

9725 NW 117th Ave., Miami, Florida, FL 33178, United States

## 1.2 Manufacturer

**Lakia Networks Co., Ltd.**

2F, Unit A, Technology Service Building, Software Garden 1, Xiamen, Fujian, China

## 1.3 Product Feature of Equipment Under Test

Product Feature	
<b>Equipment</b>	Smart Phone
<b>Brand Name</b>	Avvio
<b>Model Name</b>	Avvio 774S, Avvio 774
<b>FCC ID</b>	WVBA774X
<b>EUT supports Radios application</b>	GSM/GPRS/EGPRS(Downlink Only)/ WCDMA/HSPA/HSPA+(Downlink Only)/ WLAN2.4GHz 802.11b/g/n HT20/HT40/ Bluetooth v3.0+EDR/Bluetooth v4.0 LE
<b>IMEI Code</b>	Conducted:356597028994981/356597028994999 Conduction: 356597028994965/356597028994973 Radiation: 356597028994965/356597028994973
<b>HW Version</b>	V1.1
<b>SW Version</b>	Avvio774S.W25.V0.0.6 Avvio774.W25.V0.0.3
<b>EUT Stage</b>	Identical Prototype

**Remark:**

1. The above EUT's information was declared by manufacturer. Please refer to the specifications or user's manual for more detailed description.
2. The difference of the two samples (Model Name: Avvio 774S, Avvio 774): Avvio 774 is single SIM card, Avvio 774S is dual SIM card. We only choose dual SIM sample to perform full tests.



### 1.4 Product Specification subjective to this standard

Product Specification subjective to this standard	
<b>Tx/Rx Channel Frequency Range</b>	802.11b/g/n : 2412 MHz ~ 2462 MHz
<b>Maximum (Peak) Output Power to Antenna</b>	802.11b : 19.42 dBm (0.0875 W) 802.11g : 21.51 dBm (0.1416 W) 802.11n HT20 : 21.53 dBm (0.1422 W) 802.11n HT40 : 21.46 dBm (0.1400 W)
<b>Antenna Type</b>	802.11b/g/n : PCB Antenna with gain 1.1 dBi
<b>Type of Modulation</b>	802.11b : DSSS (DBPSK / DQPSK / CCK) 802.11g/n : OFDM (BPSK / QPSK / 16QAM / 64QAM)

### 1.5 Modification of EUT

No modifications are made to the EUT during all test items.



### 1.6 Testing Location

<b>Test Site</b>	SPORTON INTERNATIONAL (SHENZHEN) INC.	
<b>Test Site Location</b>	1F & 2F, Building A, Morning Business Center, No. 4003 ShiGu Rd., Xili Town, Nanshan District, Shenzhen, Guangdong, P. R. China TEL: +86-755-8637-9589 FAX: +86-755-8637-9595	
<b>Test Site No.</b>	<b>Sporton Site No.</b>	
	TH01-SZ	CO01-SZ

<b>Test Site</b>	SPORTON INTERNATIONAL (SHENZHEN) INC.	
<b>Test Site Location</b>	No. 3 Building, the third floor of south, Shahe River west, Fengzeyuan warehouse, Nanshan District, Shenzhen, Guangdong, P. R. China TEL: +86-755- 3320-2398	
<b>Test Site No.</b>	<b>Sporton Site No.</b>	<b>FCC Registration No.</b>
	03CH01-SZ	831040

**Note:** The test site complies with ANSI C63.4 2009 requirement.



## 1.7 Applicable Standards

According to the specifications of the manufacturer, the EUT must comply with the requirements of the following standards:

- ♦ FCC Part 15 Subpart C §15.247
- ♦ FCC KDB Publication No. 558074 D01 DTS Meas. Guidance v03r03
- ♦ ANSI C63.10-2013

**Remark:**

1. All test items were verified and recorded according to the standards and without any deviation during the test.
2. FCC permits the use of the 1.5 meter table as an alternative in C63.10-2013 through inquiry tracking number 961829.
3. This EUT has also been tested and complied with the requirements of FCC Part 15, Subpart B, recorded in a separate test report.





## 2 Test Configuration of Equipment Under Test

The EUT has been associated with peripherals and configuration operated in a manner tended to maximize its emission characteristics in a typical application. Frequency range investigated: conducted emission (150 kHz to 30 MHz) and radiated emission (9 kHz to the 10th harmonic of the highest fundamental frequency or to 40 GHz, whichever is lower). For radiated measurement, pre-scanned in three orthogonal panels, X, Y, Z. The worst cases (Z plane) were recorded in this report.

The final configuration from all the combinations and the worst-case data rates were investigated by measuring the maximum power across all the data rates and modulation modes under section 2.2.

Based on the worst configuration found above, the RF power setting is set individually to meet FCC compliance limit for the final conducted and radiated tests shown in section 2.3.

### 2.1 Carrier Frequency Channel

Frequency Band	Channel	Freq. (MHz)	Channel	Freq. (MHz)
2400-2483.5 MHz	1	2412	7	2442
	2	2417	8	2447
	3	2422	9	2452
	4	2427	10	2457
	5	2432	11	2462
	6	2437	-	-



## 2.2 Pre-Scanned RF Power

Preliminary tests were performed in different data rate and data rate associated with the highest power were chosen for full test shown in the following tables.

2.4GHz 802.11b RF Output Power (dBm)						
Power vs. Channel			Power vs. Data Rate			
Channel	Frequency (MHz)	Data Rate	Channel	2Mbps	5.5Mbps	11Mbps
		1Mbps				
CH 01	2412 MHz	19.16	CH 11	19.37	19.30	19.32
CH 06	2437 MHz	19.33				
CH 11	2462 MHz	19.42				

2.4GHz 802.11g RF Output Power (dBm)										
Power vs. Channel			Power vs. Data Rate							
Channel	Frequency (MHz)	Data Rate	Channel	9Mbps	12Mbps	18Mbps	24Mbps	36Mbps	48Mbps	54Mbps
		6Mbps								
CH 01	2412 MHz	21.35	CH 06	21.47	21.48	21.45	21.43	21.46	21.48	21.50
CH 06	2437 MHz	21.51								
CH 11	2462 MHz	21.45								

2.4GHz 802.11n HT20 RF Output Power (dBm)										
Power vs. Channel			Power vs. MCS Index							
Channel	Frequency (MHz)	MCS Index	Channel	MCS1	MCS2	MCS3	MCS4	MCS5	MCS6	MCS7
		MCS0								
CH 01	2412 MHz	21.32	CH 06	21.48	21.47	21.43	21.45	21.50	21.49	21.51
CH 06	2437 MHz	21.53								
CH 11	2462 MHz	21.37								

2.4GHz 802.11n HT40 RF Output Power (dBm)										
Power vs. Channel			Power vs. MCS Index							
Channel	Frequency (MHz)	MCS Index	Channel	MCS1	MCS2	MCS3	MCS4	MCS5	MCS6	MCS7
		MCS0								
CH 03	2422 MHz	21.00	CH 06	21.13	21.20	21.21	21.18	21.22	21.15	21.14
CH 06	2437 MHz	21.46								
CH 09	2452 MHz	21.09								



### 2.3 Test Mode

Final test mode of conducted test items and radiated spurious emissions are considering the modulation and worse data rates from the power table described in section 2.2.

<2.4GHz>

Modulation	Data Rate
802.11b	1 Mbps
802.11g	6 Mbps
802.11n HT20	MCS0
802.11n HT40	MCS0

Test Cases	
<b>AC Conducted Emission</b>	Mode 1: GSM850 Idle + Bluetooth Link + WLAN Link + Earphone + USB Cable (Charging from Adapter) + SIM1
<b>Remark:</b> For Radiated Test Cases, The tests were performance with Adapter, Earphone and USB Cable.	

## 2.4 Connection Diagram of Test System

### <WLAN Tx Mode>

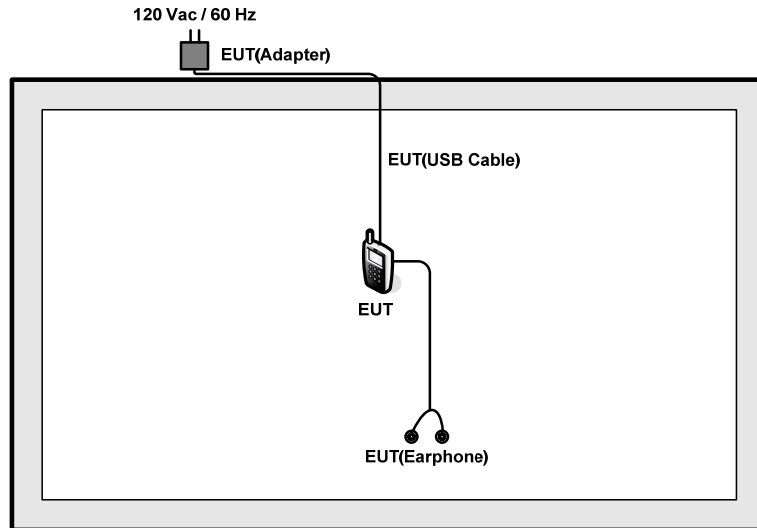

### <AC Conducted Emission Mode>

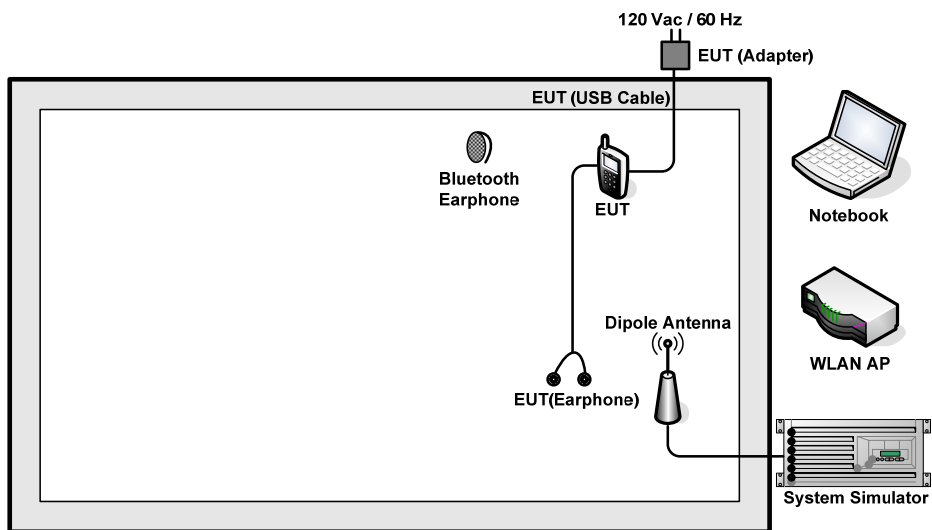



## 2.5 Support Unit used in test configuration and system

Item	Equipment	Trade Name	Model Name	FCC ID	Data Cable	Power Cord
1.	System Simulator	Anritsu	MT8820C	N/A	N/A	Unshielded, 1.8 m
2.	WLAN AP	D-link	DIR-628	KA2DIR628A2	N/A	Unshielded, 1.8 m
3.	Notebook	Lenovo	E540	FCC DoC	N/A	AC I/P: Unshielded, 1.2 m DC O/P: Shielded, 1.8 m
4.	Bluetooth Earphone	Nokia	BH-108	PYAHS-107W	N/A	N/A

## 2.6 EUT Operation Test Setup

For WLAN RF test items, an engineering test program was provided and enabled to make EUT continuously transmit/receive.

For AC power line conducted emissions, the EUT was set to connect with the WLAN AP under large package sizes transmission.



## 2.7 Measurement Results Explanation Example

For all conducted test items:

The offset level is set in the spectrum analyzer to compensate the RF cable loss and attenuator factor between EUT conducted output port and spectrum analyzer. With the offset compensation, the spectrum analyzer reading level is exactly the EUT RF output level.

Example :

The spectrum analyzer offset is derived from RF cable loss and attenuator factor.

*Offset = RF cable loss + attenuator factor.*

Following shows an offset computation example with cable loss 5.0 dB and 10dB attenuator.

$$\begin{aligned} \text{Offset(dB)} &= \text{RF cable loss(dB)} + \text{attenuator factor(dB)}. \\ &= 5.0 + 10 = 15.0 \text{ (dB)} \end{aligned}$$

### 3 Test Result

#### 3.1 6dB Bandwidth Measurement

##### 3.1.1 Limit of 6dB Bandwidth

The minimum 6 dB bandwidth shall be at least 500 kHz.

##### 3.1.2 Measuring Instruments

The measuring equipment is listed in the section 4 of this test report.

##### 3.1.3 Test Procedures

1. The testing follows FCC KDB Publication No. 558074 DTS D01 Meas. Guidance v03r03.
2. The RF output of EUT was connected to the spectrum analyzer by RF cable and attenuator. The path loss was compensated to the results for each measurement.
3. Set to the maximum power setting and enable the EUT transmit continuously.
4. Make the measurement with the spectrum analyzer's resolution bandwidth (RBW) = 100 kHz. Set the Video bandwidth (VBW) = 300 kHz. In order to make an accurate measurement. The 6 dB bandwidth must be greater than 500 kHz.
5. Measure and record the results in the test report.

##### 3.1.4 Test Setup

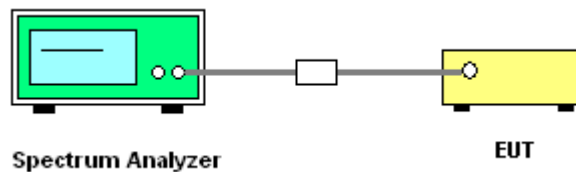



### 3.1.5 Test Result of 6dB Occupied Bandwidth

Please refer to Appendix A of this test report.

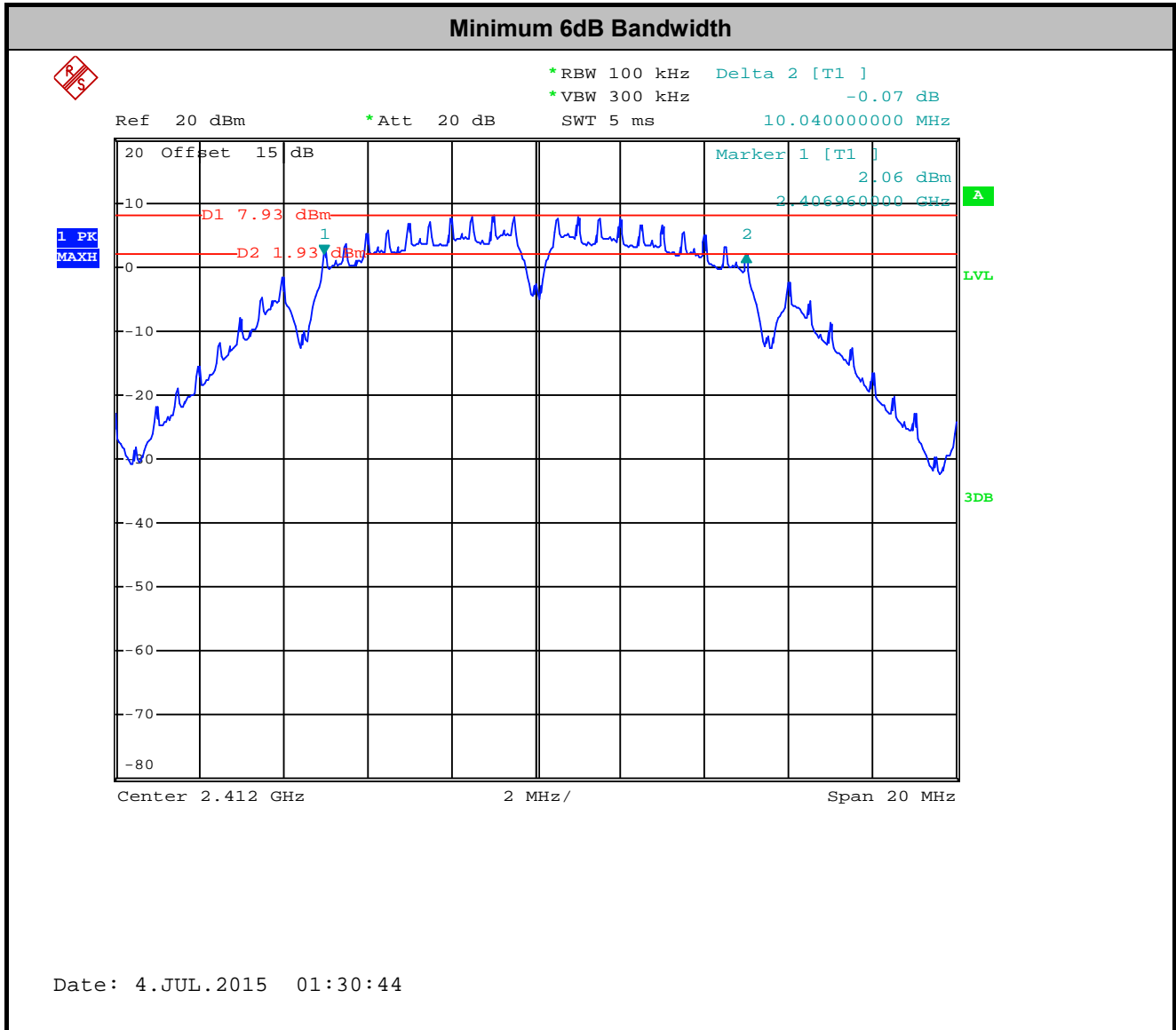

Note : The occupied channel bandwidth is maintained within the band of operation for all of the modulations.



## 3.2 Output Power Measurement

### 3.2.1 Limit of Output Power

For systems using digital modulation in the 2400-2483.5MHz, the limit for peak output power is 30dBm. If transmitting Antenna of directional gain greater than 6dBi are used the peak output power from the intentional radiator shall be reduced below the above stated value by the amount in dB that the directional gain of the Antenna exceeds 6 dBi. In case of point-to-point operation, the limit has to be reduced by 1dB for every 3dB that the directional gain of the Antenna exceeds 6dBi.

### 3.2.2 Measuring Instruments

The measuring equipment is listed in the section 4 of this test report.

### 3.2.3 Test Procedures

1. The testing follows the Measurement Procedure of FCC KDB No. 558074 DTS D01 Meas. Guidance v03r03 section 9.1.2 PKPM1 Peak power meter method.
2. The RF output of EUT was connected to the power meter by RF cable and attenuator. The path loss was compensated to the results for each measurement.
3. Set to the maximum power setting and enable the EUT transmit continuously.
4. Measure the conducted output power and record the results in the test report.

### 3.2.4 Test Setup

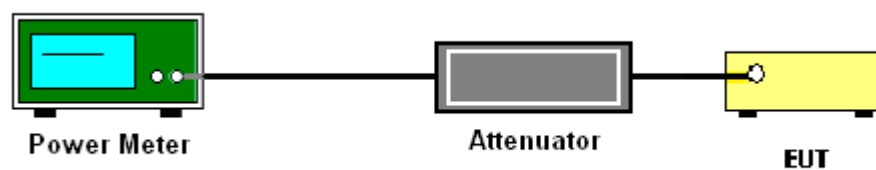



### **3.2.5 Test Result of Peak Output Power**

Please refer to Appendix A of this test report.

### **3.2.6 Test Result of Average output Power (Reporting Only)**

Please refer to Appendix A of this test report.

### 3.3 Power Spectral Density Measurement

#### 3.3.1 Limit of Power Spectral Density

The peak power spectral density shall not be greater than 8dBm in any 3kHz band at any time interval of continuous transmission.

#### 3.3.2 Measuring Instruments

The measuring equipment is listed in the section 4 of this test report.

#### 3.3.3 Test Procedures

1. The testing follows Measurement Procedure 10.2 Method PKPSD of FCC KDB Publication No. 558074 D01 DTS Meas. Guidance v03r03
2. The RF output of EUT was connected to the spectrum analyzer by RF cable and attenuator. The path loss was compensated to the results for each measurement.
3. Set to the maximum power setting and enable the EUT transmit continuously.
4. Make the measurement with the spectrum analyzer's resolution bandwidth (RBW) = 3 kHz. Video bandwidth VBW = 10 kHz In order to make an accurate measurement, set the span to 1.5 times DTS Channel Bandwidth. (6dB BW)
5. Detector = peak, Sweep time = auto couple, Trace mode = max hold, Allow trace to fully stabilize. Use the peak marker function to determine the maximum power level.
6. Measure and record the results in the test report.

#### 3.3.4 Test Setup

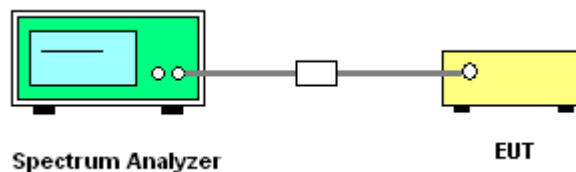



### 3.3.5 Test Result of Power Spectral Density

Please refer to Appendix A of this test report.

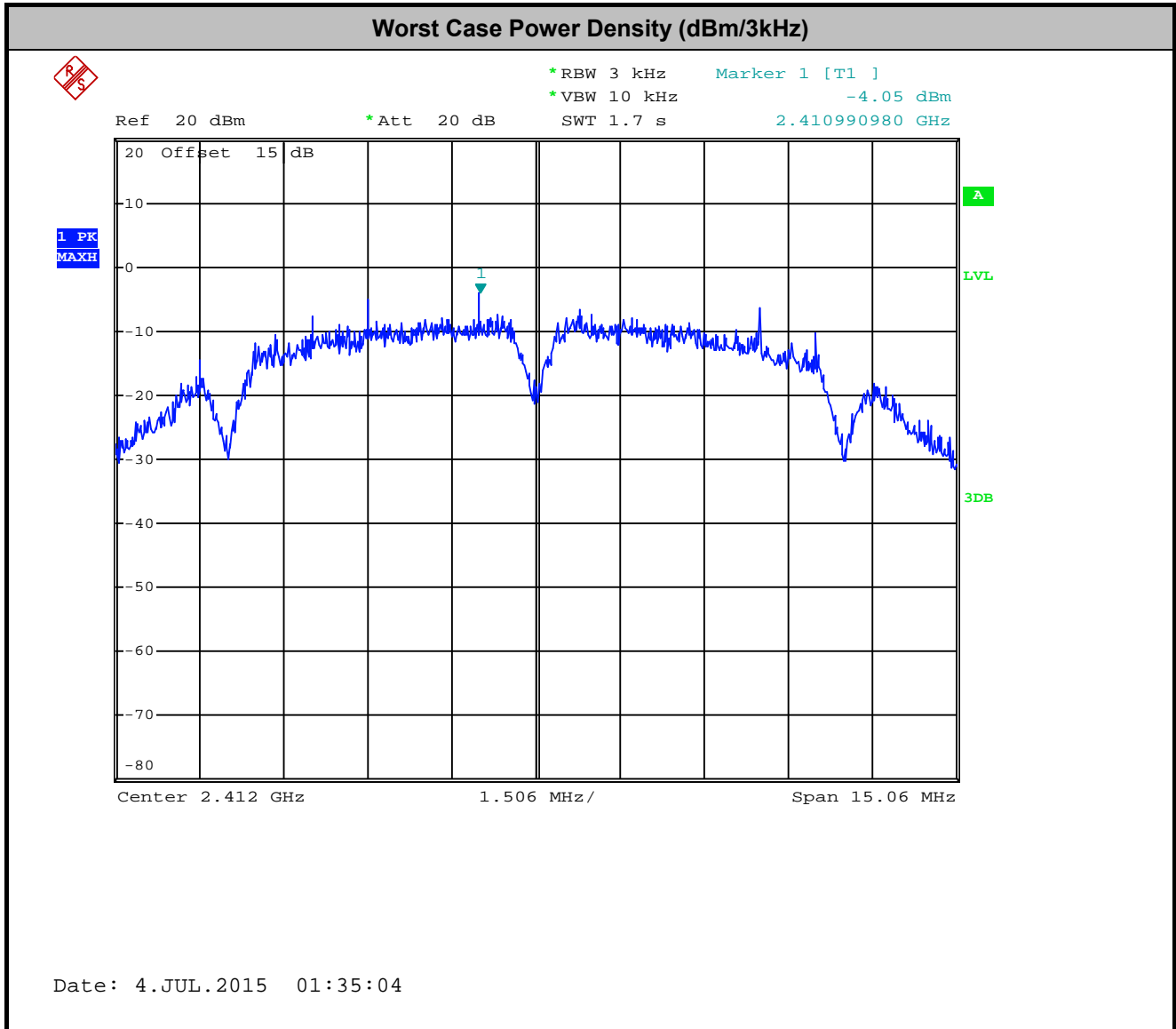

## 3.4 Conducted Band Edges and Spurious Emission Measurement

### 3.4.1 Limit of Conducted Band Edges and Spurious Emission Measurement

In any 100 kHz bandwidth outside of the authorized frequency band, the emissions which fall in the non-restricted bands shall be attenuated at least 20 dB / 30dB relative to the maximum PSD level in 100 kHz by RF conducted measurement and radiated emissions which fall in the restricted bands, as defined in Section 15.205(a), must also comply with the radiated emission limits specified in Section 15.209(a).

### 3.4.2 Measuring Instruments

The measuring equipment is listed in the section 4 of this test report.

### 3.4.3 Test Procedures

1. The testing follows FCC KDB Publication No. 558074 D01 DTS Meas. Guidance v03r03.
2. The RF output of EUT was connected to the spectrum analyzer by RF cable and attenuator. The path loss was compensated to the results for each measurement.
3. Set to the maximum power setting and enable the EUT transmit continuously.
4. Set RBW = 100 kHz, VBW=300 kHz, Peak Detector. Unwanted Emissions measured in any 100 kHz bandwidth outside of the authorized frequency band shall be attenuated by at least 20 dB relative to the maximum in-band peak PSD level in 100 kHz when maximum peak conducted output power procedure is used. If the transmitter complies with the conducted power limits based on the use of RMS averaging over a time interval, the attenuation required under this paragraph shall be 30 dB instead of 20 dB per 15.247(d).
5. Measure and record the results in the test report.
6. The RF fundamental frequency should be excluded against the limit line in the operating frequency band.

### 3.4.4 Test Setup

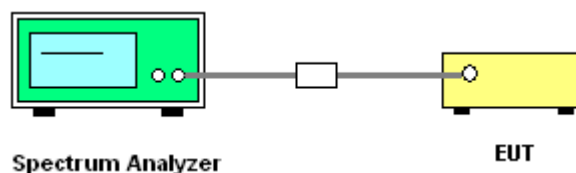



### 3.4.5 Test Result of Conducted Band Edges and Spurious Emission

Test Mode :	802.11b	Temperature :	21~25°C
Test Band :	2.4GHz Low	Relative Humidity :	51~54%
Test Channel :	01	Test Engineer :	Mygai Wang

#### WLAN 802.11b Channel 01

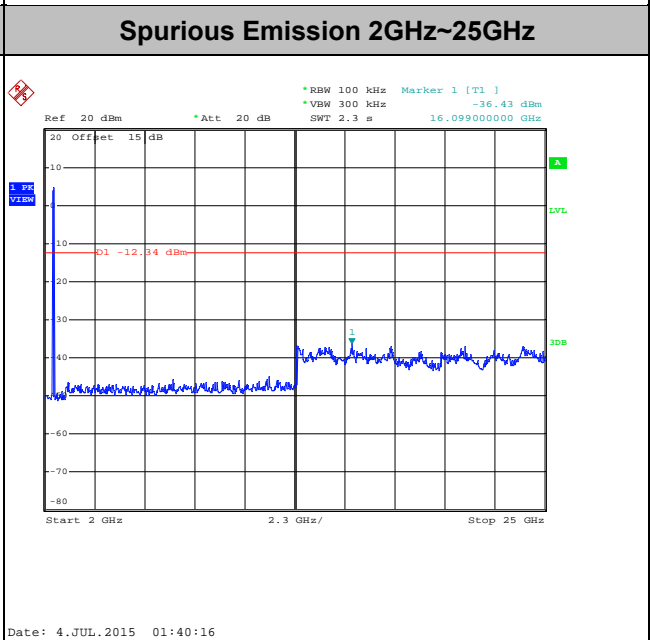
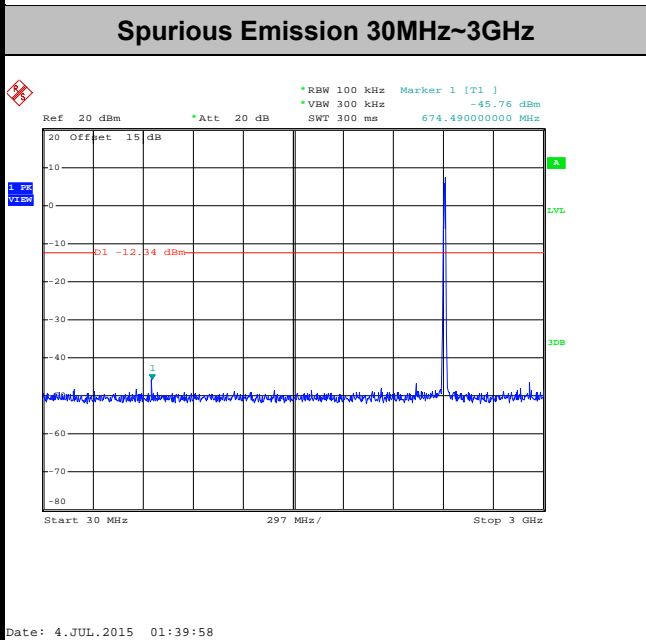
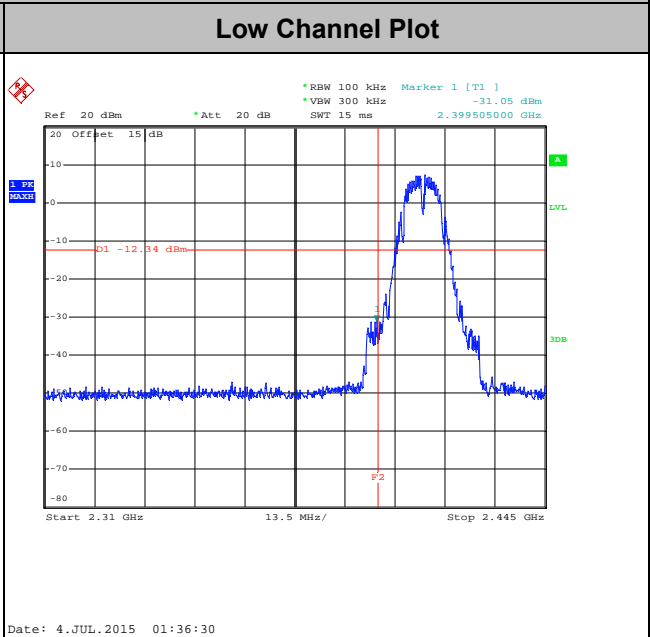
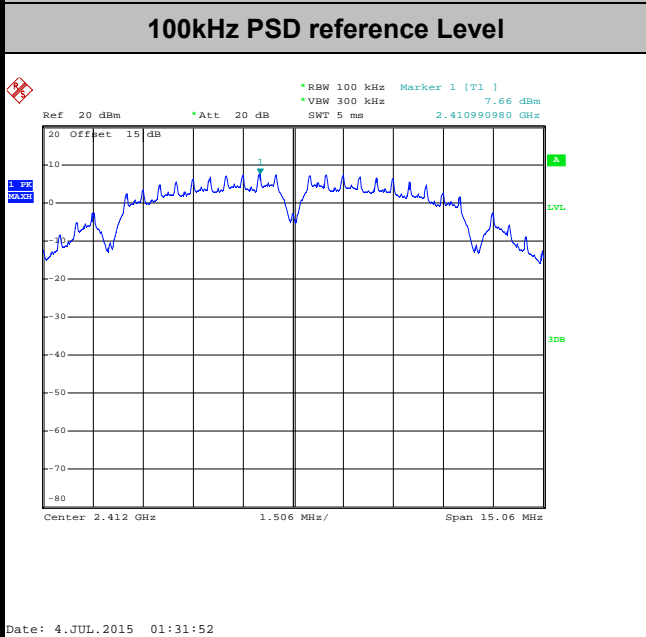



Test Mode :	802.11b	Temperature :	21~25°C
Test Band :	2.4GHz Mid	Relative Humidity :	51~54%
Test Channel :	06	Test Engineer :	Mygai Wang

WLAN 802.11b Channel 06

100kHz PSD reference Level

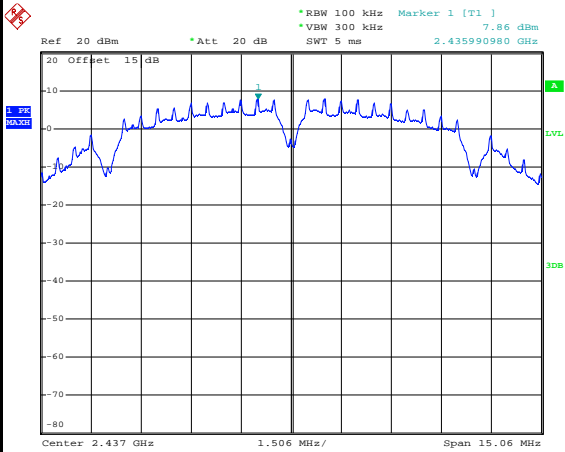

Date: 4.JUL.2015 01:44:11

Spurious Emission 30MHz~3GHz

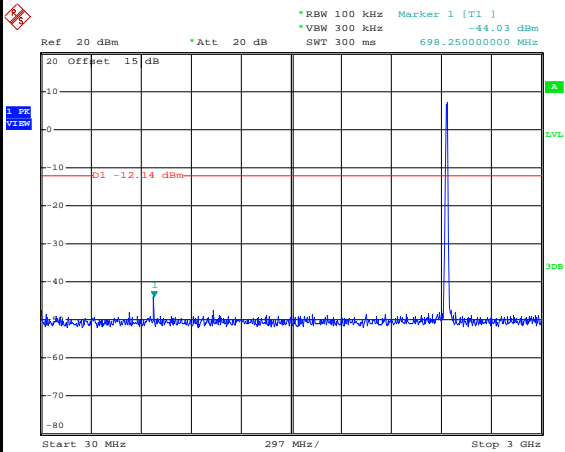

Date: 4.JUL.2015 01:46:36

Spurious Emission 2GHz~25GHz

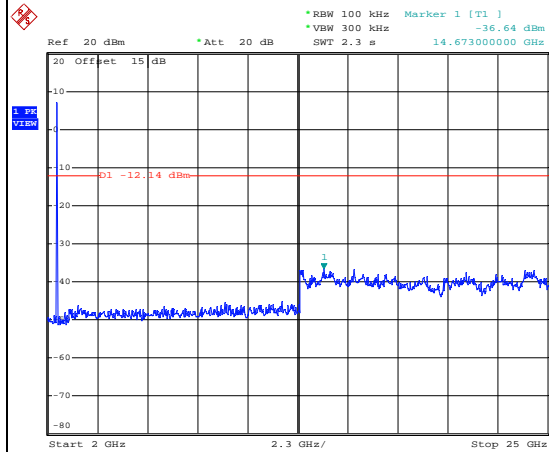

Date: 4.JUL.2015 01:46:53



Test Mode :	802.11b	Temperature :	21~25°C
Test Band :	2.4GHz High	Relative Humidity :	51~54%
Test Channel :	11	Test Engineer :	Mygai Wang

WLAN 802.11b Channel 11

100kHz PSD reference Level

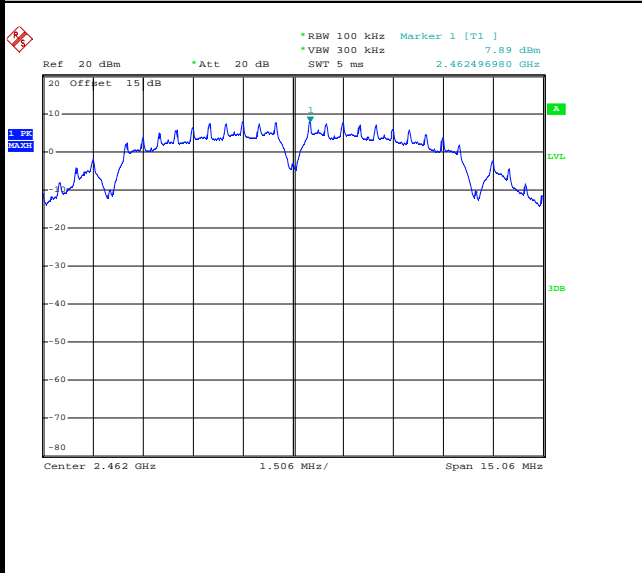

High Channel Plot

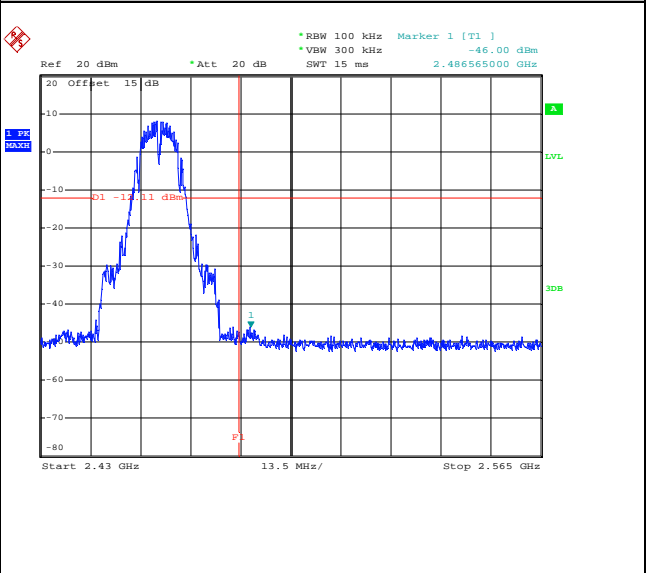

Spurious Emission 30MHz~3GHz

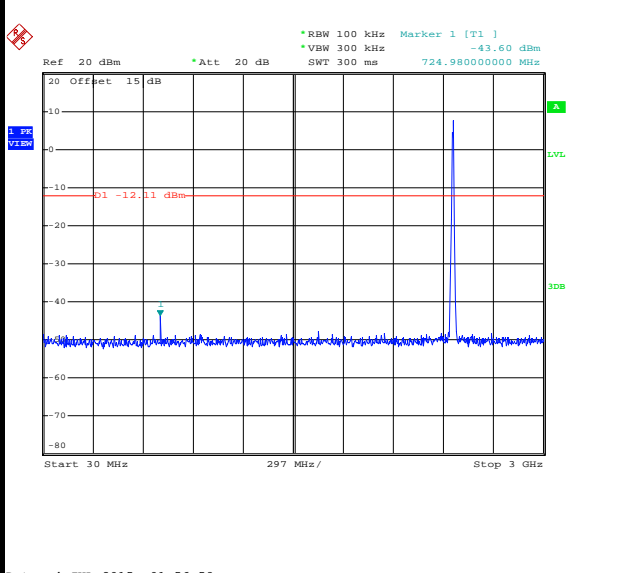

Spurious Emission 2GHz~25GHz

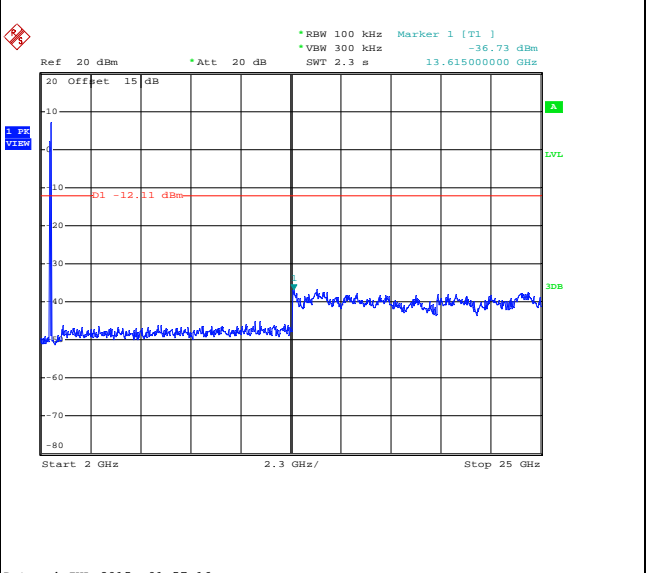





Test Mode :	802.11g	Temperature :	21~25°C
Test Band :	2.4GHz Low	Relative Humidity :	51~54%
Test Channel :	01	Test Engineer :	Mygai Wang

WLAN 802.11g Channel 01

100kHz PSD reference Level

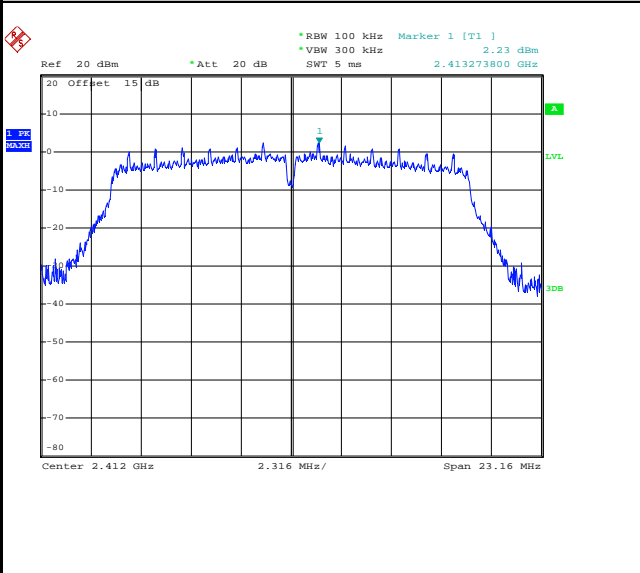

Low Channel Plot

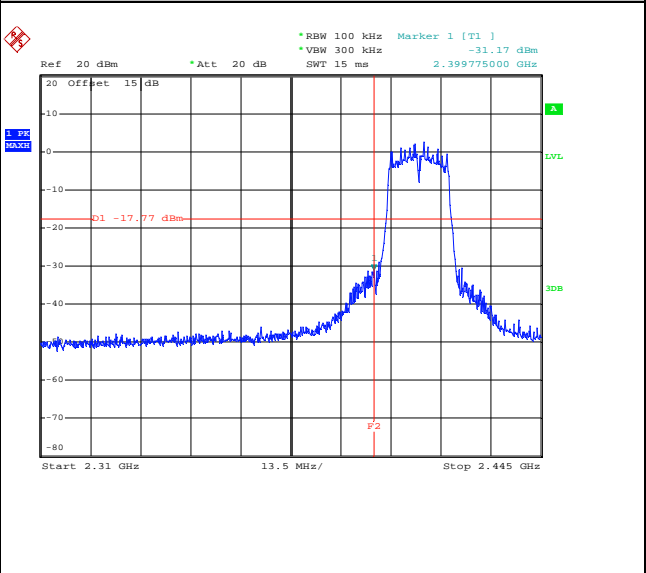

Spurious Emission 30MHz~3GHz

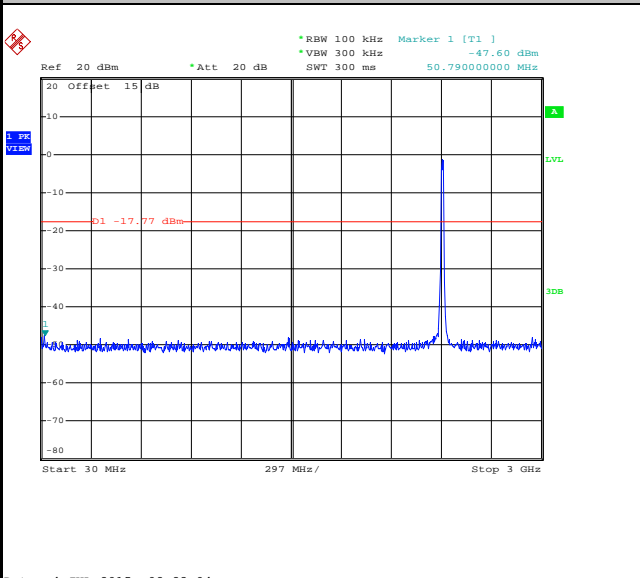

Spurious Emission 2GHz~25GHz

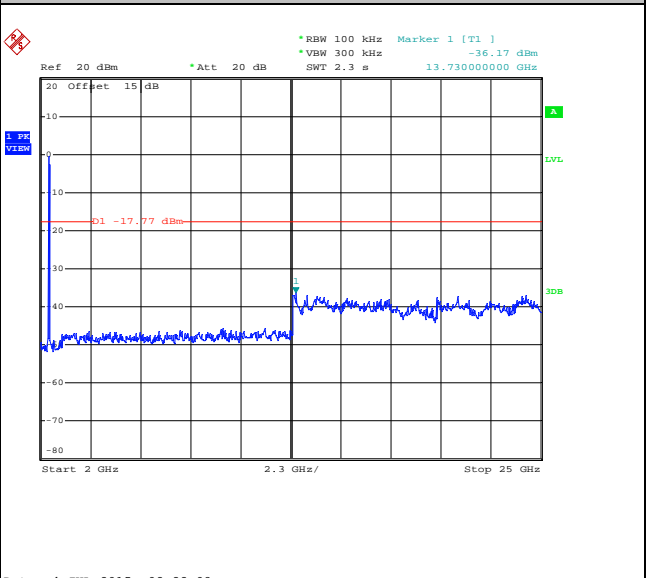



Test Mode :	802.11g	Temperature :	21~25°C
Test Band :	2.4GHz Mid	Relative Humidity :	51~54%
Test Channel :	06	Test Engineer :	Mygai Wang

WLAN 802.11g Channel 06

100kHz PSD reference Level

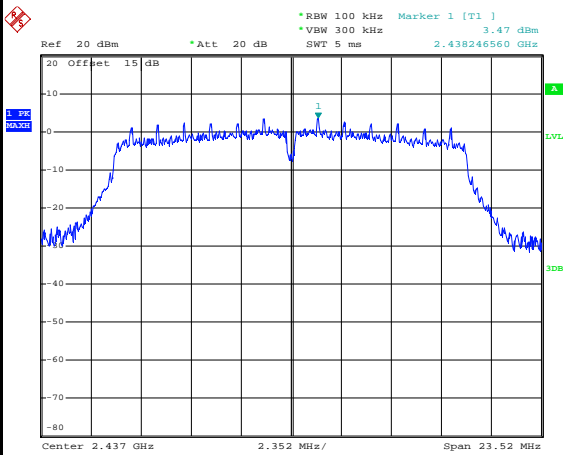

Date: 4.JUL.2015 02:11:01

Spurious Emission 30MHz~3GHz

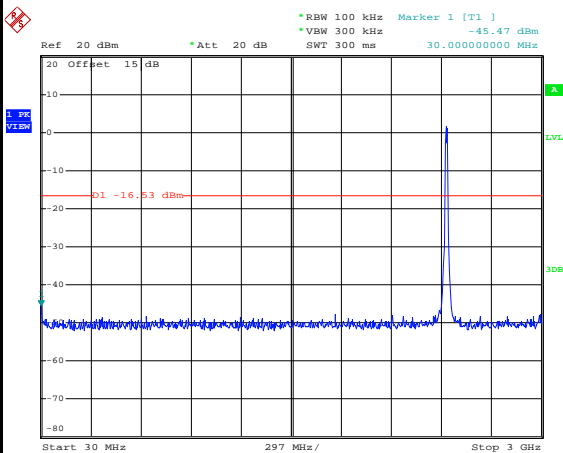

Date: 4.JUL.2015 02:14:33

Spurious Emission 2GHz~25GHz

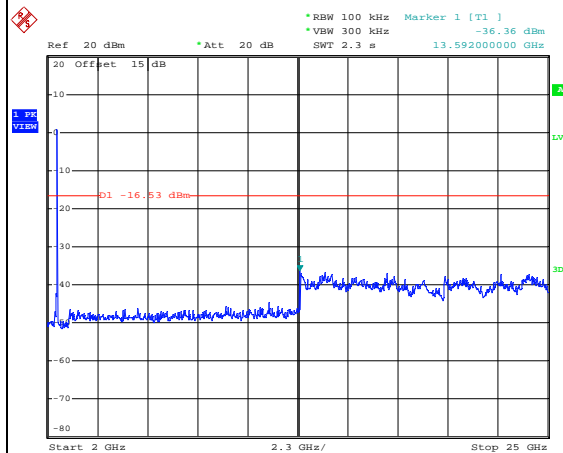

Date: 4.JUL.2015 02:14:51



Test Mode :	802.11g	Temperature :	21~25°C
Test Band :	2.4GHz High	Relative Humidity :	51~54%
Test Channel :	11	Test Engineer :	Mygai Wang

WLAN 802.11g Channel 11

100kHz PSD reference Level

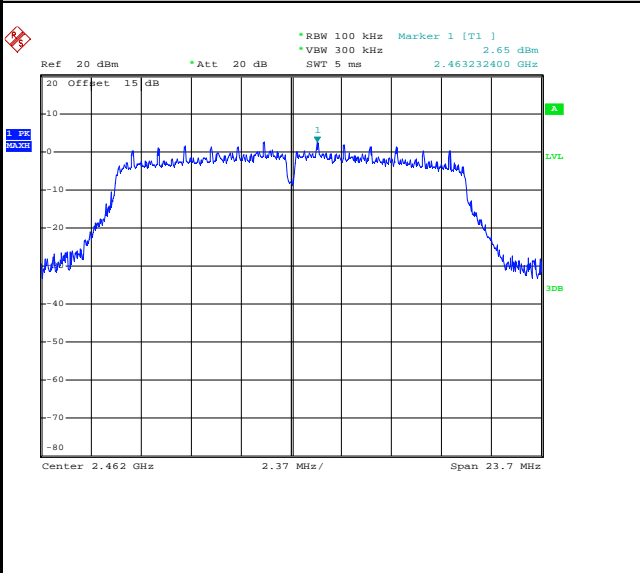

High Channel Plot

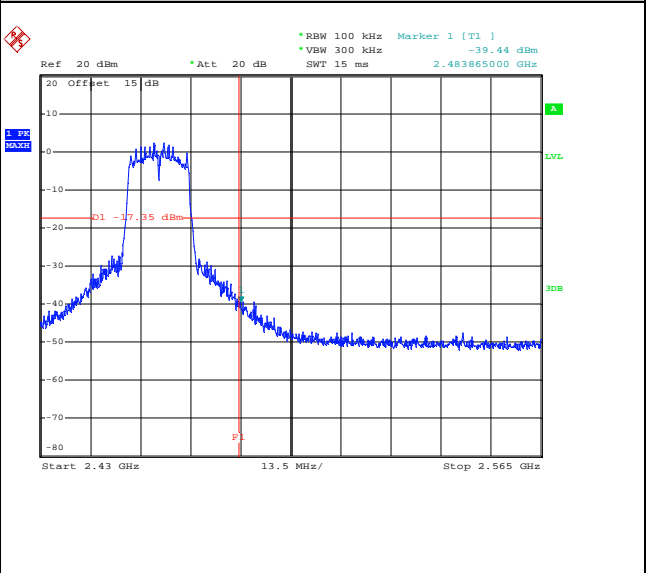

Spurious Emission 30MHz~3GHz

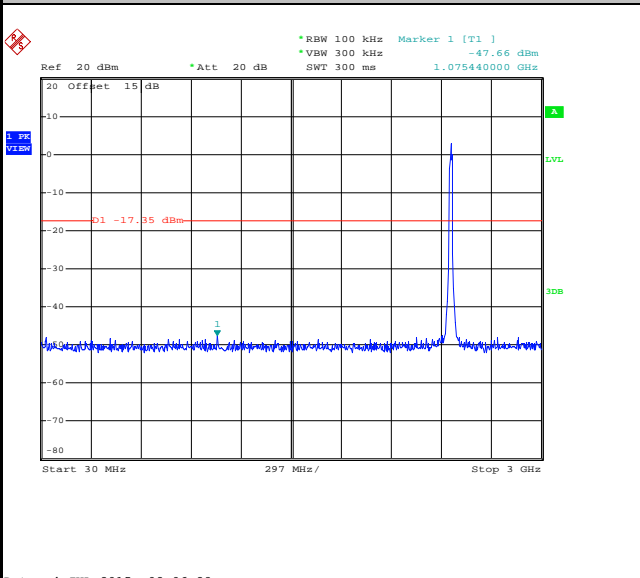

Spurious Emission 2GHz~25GHz

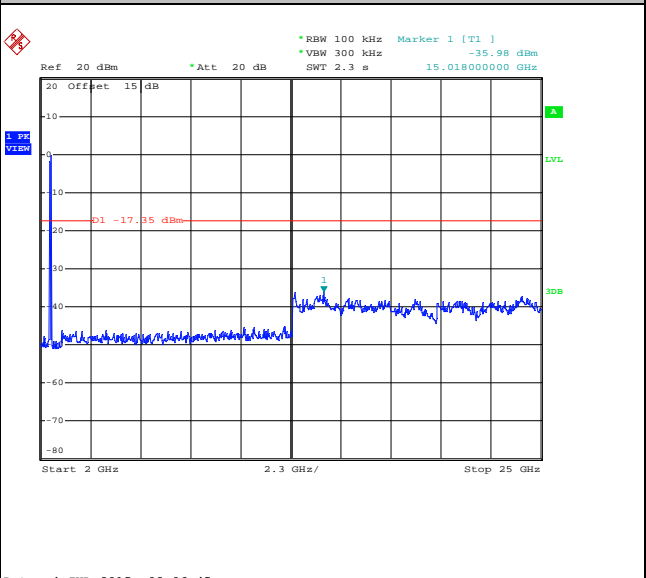



Test Mode :	802.11n HT20	Temperature :	21~25°C
Test Band :	2.4GHz Low	Relative Humidity :	51~54%
Test Channel :	01	Test Engineer :	Mygai Wang

WLAN 802.11n HT20 Channel 01

100kHz PSD reference Level

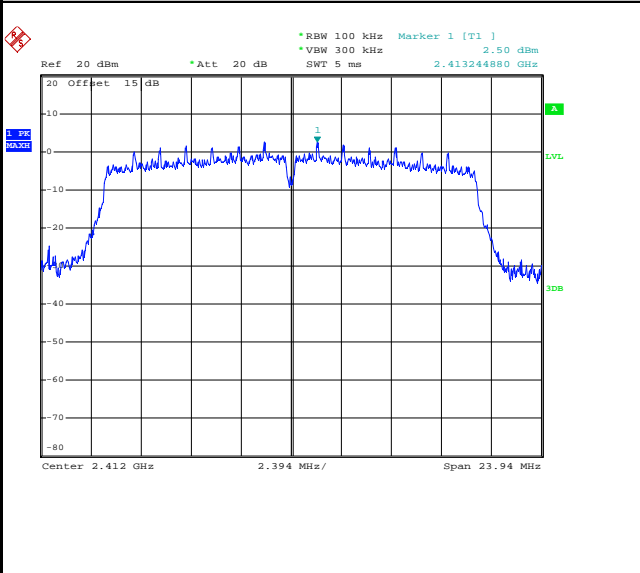

Low Channel Plot

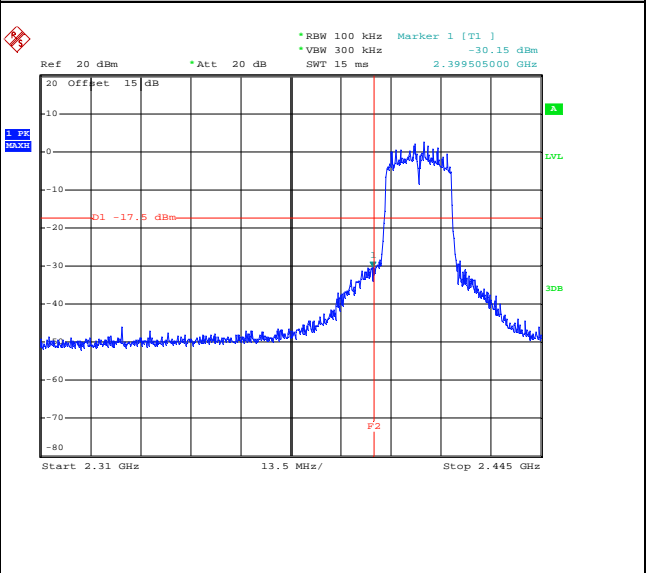

Spurious Emission 30MHz~3GHz

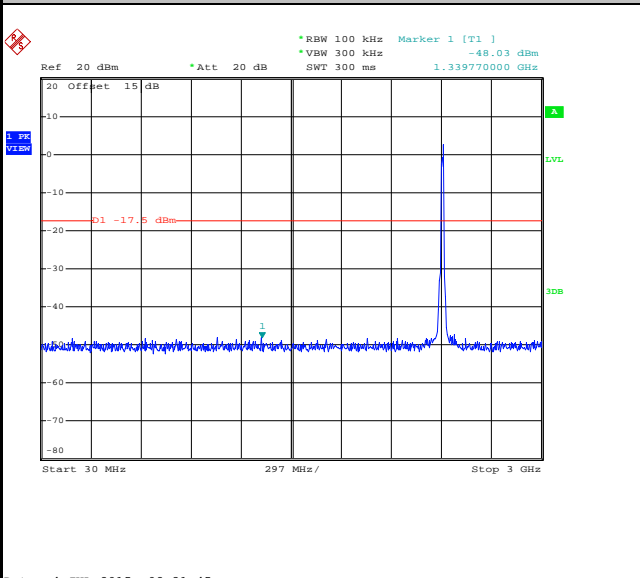

Spurious Emission 2GHz~25GHz

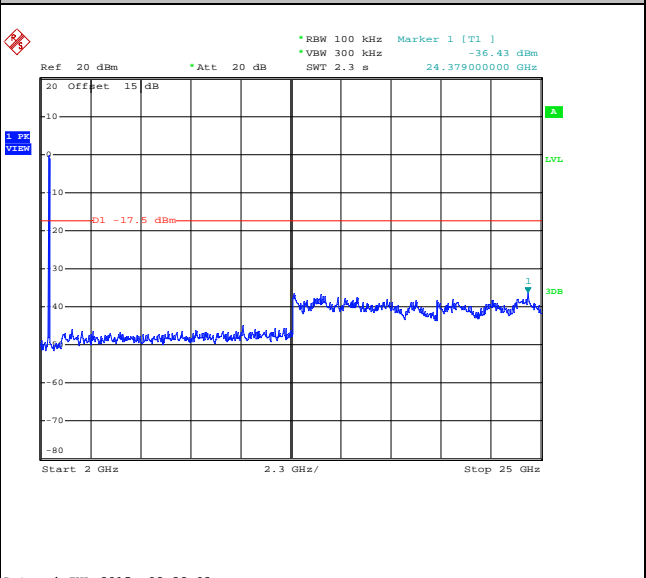



Test Mode :	802.11n HT20	Temperature :	21~25°C
Test Band :	2.4GHz Mid	Relative Humidity :	51~54%
Test Channel :	06	Test Engineer :	Mygai Wang

WLAN 802.11n HT20 Channel 06

100kHz PSD reference Level

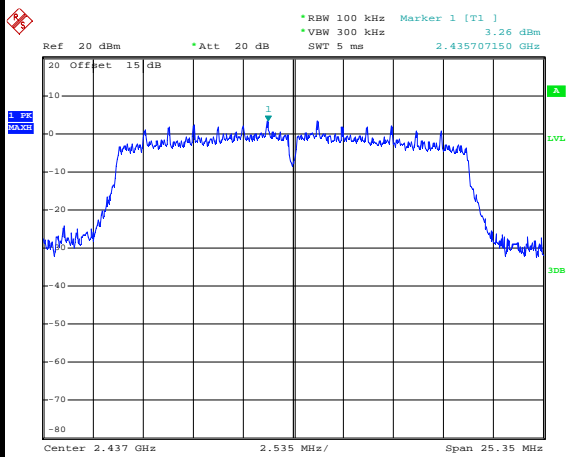

Date: 9.JUL.2015 01:45:48

Spurious Emission 30MHz~3GHz

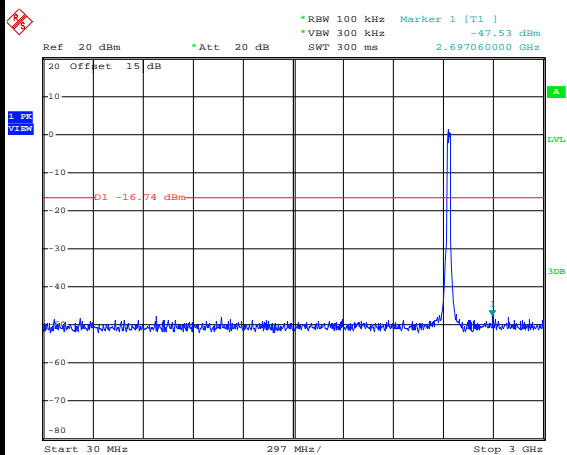

Date: 9.JUL.2015 01:48:19

Spurious Emission 2GHz~25GHz

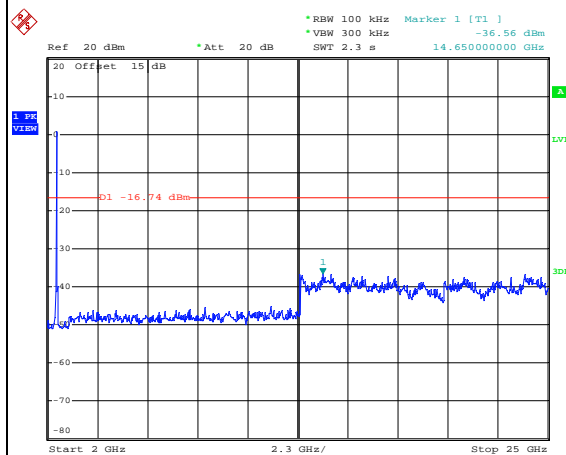

Date: 9.JUL.2015 01:48:36



Test Mode :	802.11n HT20	Temperature :	21~25°C
Test Band :	2.4GHz High	Relative Humidity :	51~54%
Test Channel :	11	Test Engineer :	Mygai Wang

WLAN 802.11n HT20 Channel 11

100kHz PSD reference Level

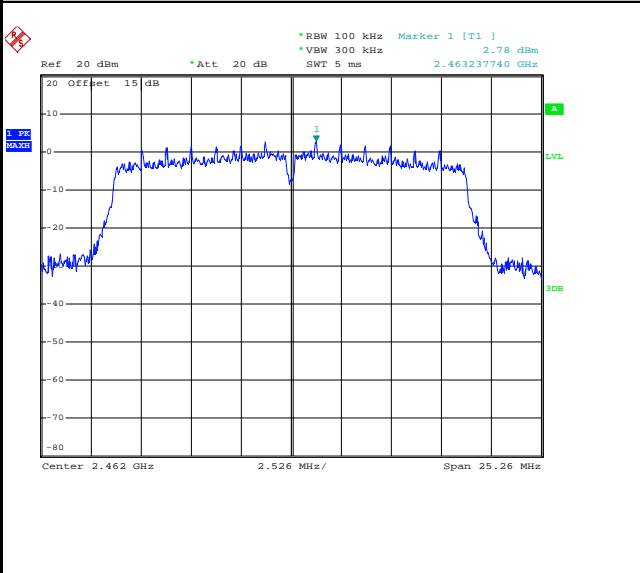

High Channel Plot

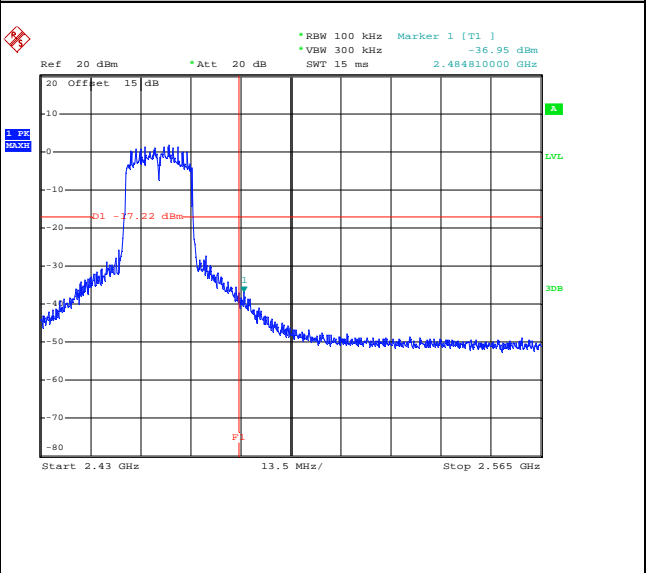

Spurious Emission 30MHz~3GHz

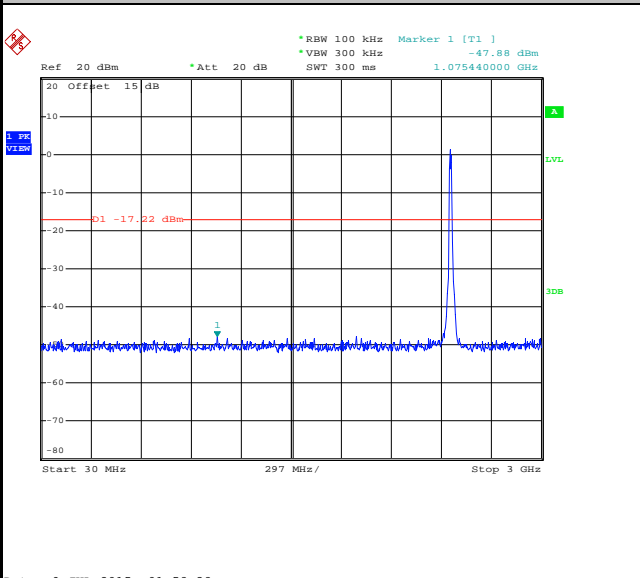

Spurious Emission 2GHz~25GHz

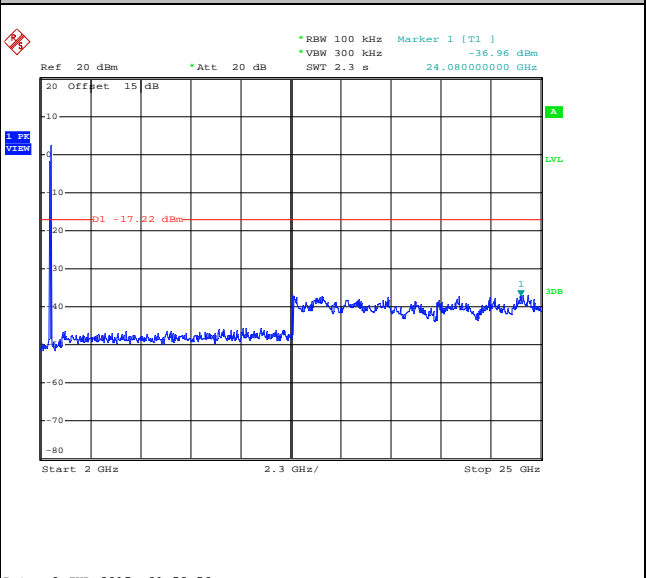



Test Mode :	802.11n HT40	Temperature :	21~25°C
Test Band :	2.4GHz Low	Relative Humidity :	51~54%
Test Channel :	03	Test Engineer :	Mygai Wang

WLAN 802.11n HT40 Channel 03

100kHz PSD reference Level

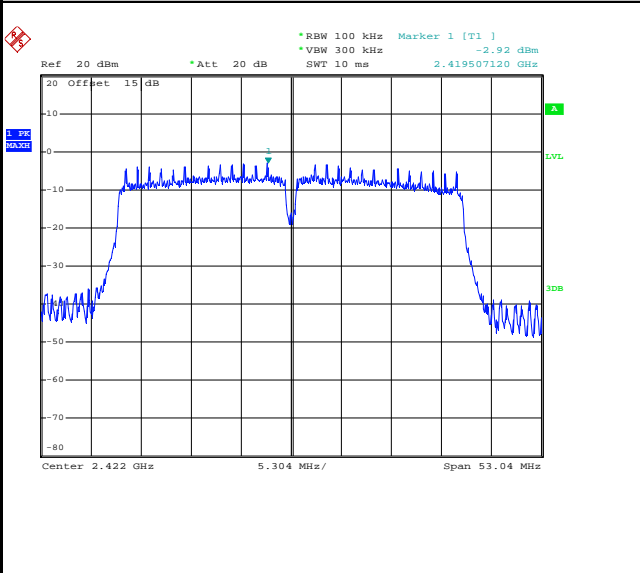

Low Channel Plot

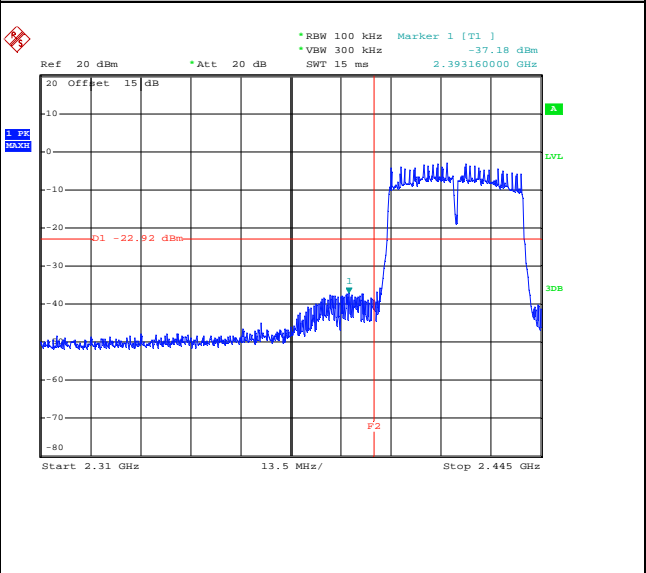

Spurious Emission 30MHz~3GHz

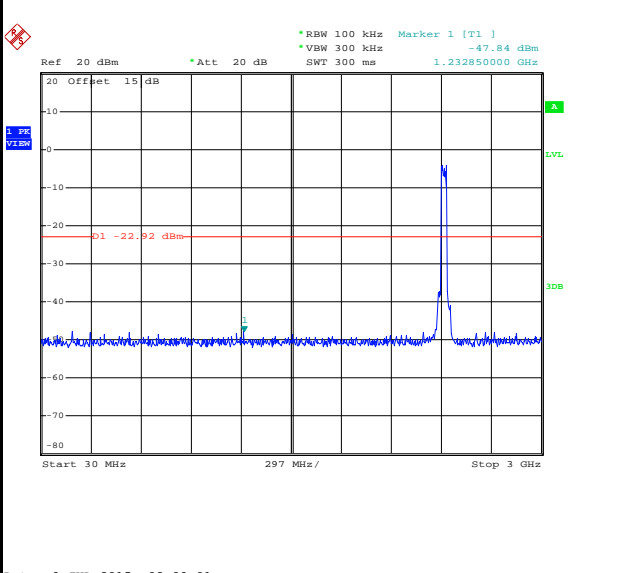

Spurious Emission 2GHz~25GHz

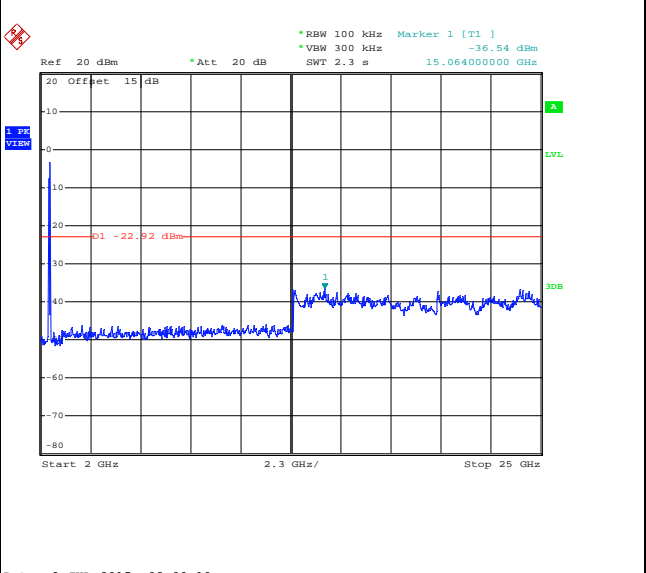



Test Mode :	802.11n HT40	Temperature :	21~25°C
Test Band :	2.4GHz Mid	Relative Humidity :	51~54%
Test Channel :	06	Test Engineer :	Mygai Wang

WLAN 802.11n HT40 Channel 06

100kHz PSD reference Level

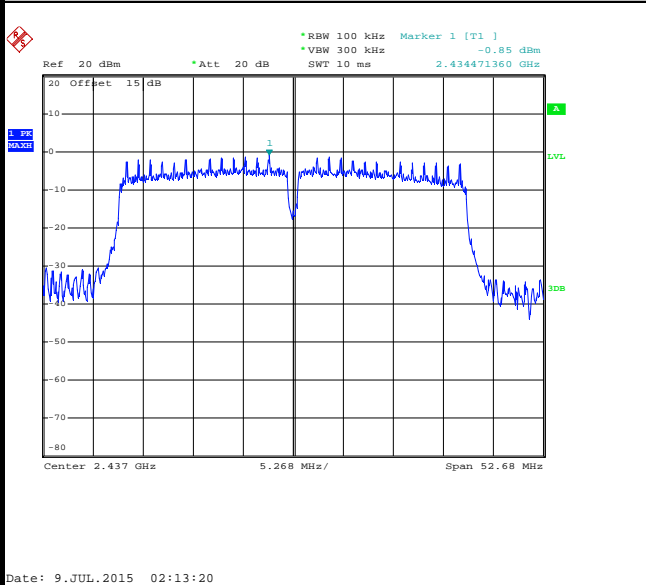

Spurious Emission 30MHz~3GHz

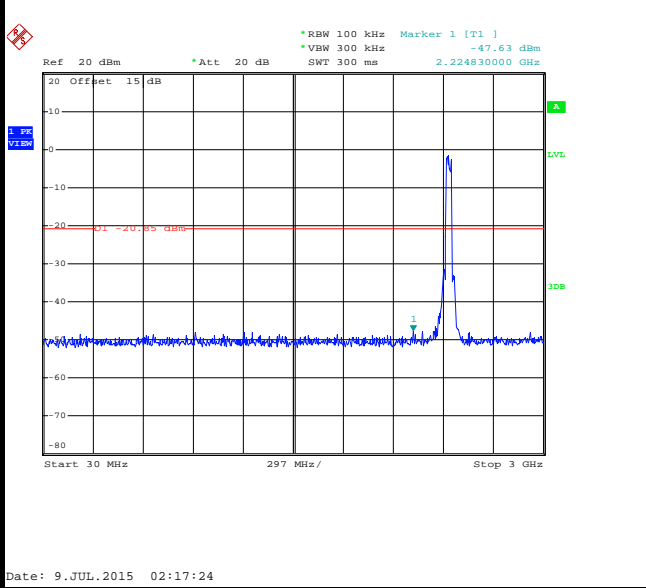

Spurious Emission 2GHz~25GHz

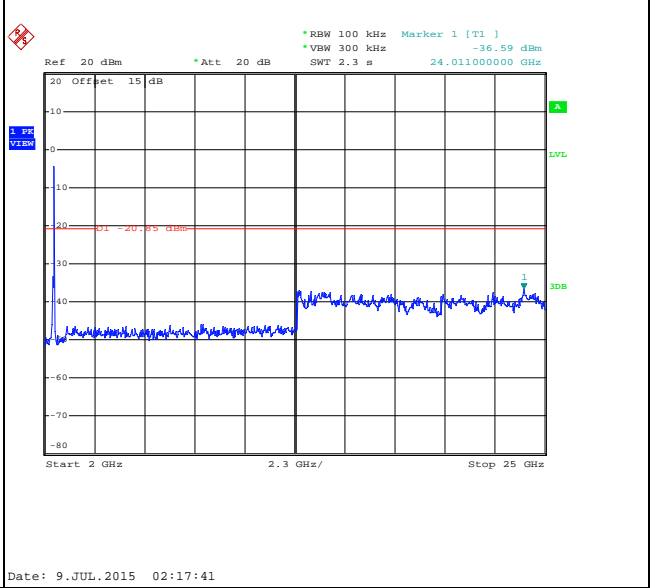





Test Mode :	802.11n HT40	Temperature :	21~25°C
Test Band :	2.4GHz High	Relative Humidity :	51~54%
Test Channel :	09	Test Engineer :	Mygai Wang

WLAN 802.11n HT40 Channel 09

100kHz PSD reference Level

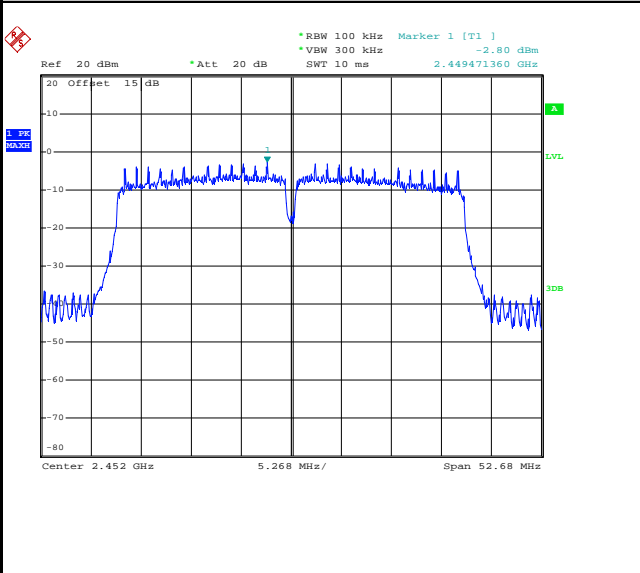

High Channel Plot

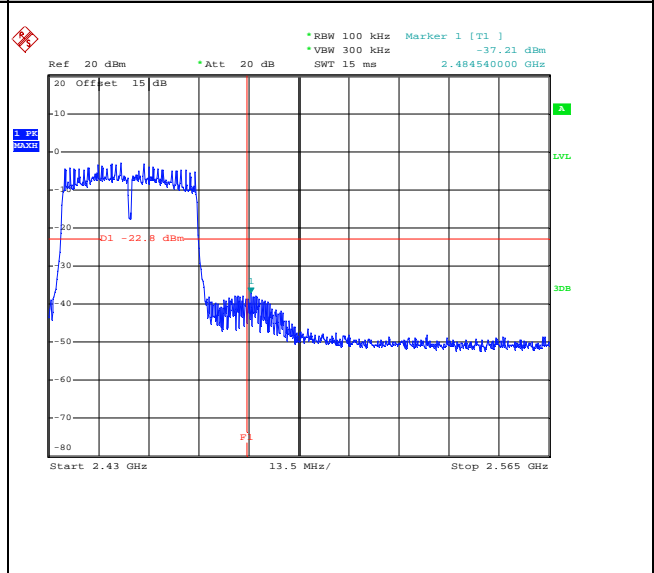

Spurious Emission 30MHz~3GHz

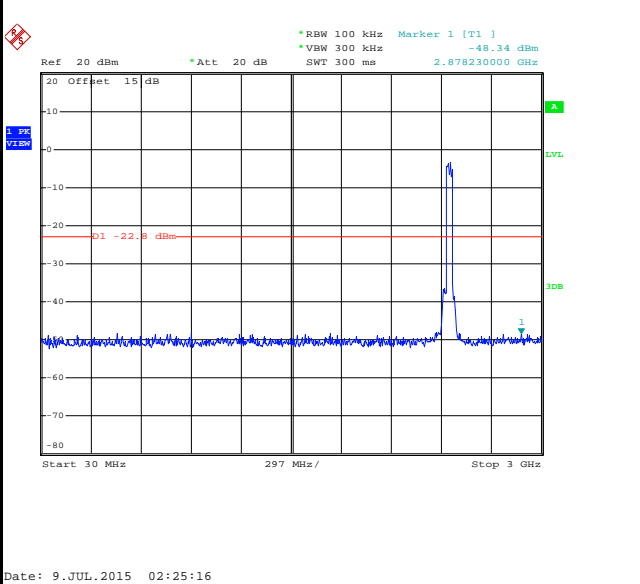

Spurious Emission 2GHz~25GHz

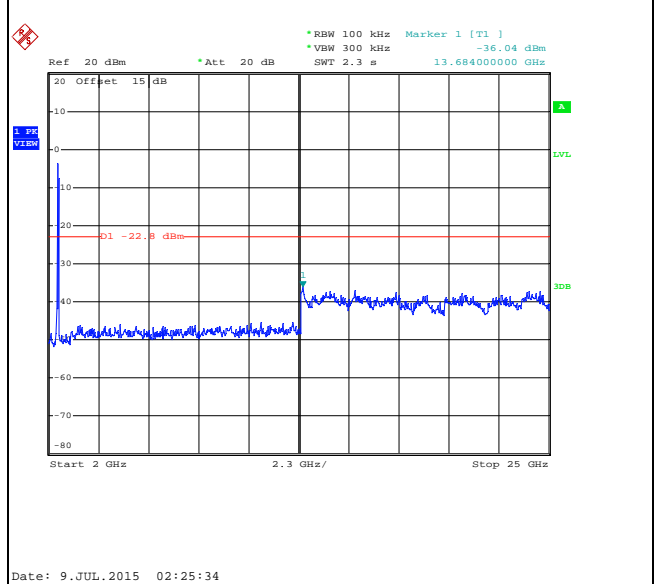



### 3.5 Radiated Band Edges and Spurious Emission Measurement

#### 3.5.1 Limit of Radiated band edge and Spurious Emission Measurement

In any 100 kHz bandwidth outside the intentional radiator frequency band, all harmonics/spurious must be at least 20 dB below the highest emission level within the authorized band. If the output power of this device was measured by spectrum analyzer, the attenuation under this paragraph shall be 30 dB instead of 20 dB. In addition, radiated emissions which fall in the restricted bands must also comply with the FCC section 15.209 limits as below.

Frequency (MHz)	Field Strength (microvolts/meter)	Measurement Distance (meters)
0.009 – 0.490	2400/F(kHz)	300
0.490 – 1.705	24000/F(kHz)	30
1.705 – 30.0	30	30
30 – 88	100	3
88 – 216	150	3
216 - 960	200	3
Above 960	500	3

#### 3.5.2 Measuring Instruments

The measuring equipment is listed in the section 4 of this test report.



3.5.3 Test Procedures

1. The testing follows FCC KDB Publication No. 558074 D01 DTS Meas. Guidance v03r03.
2. The EUT was arranged to its worst case and then tune the antenna tower (from 1 m to 4 m) and turntable (from 0 degree to 360 degrees) to find the maximum reading. A pre-amp and a high pass filter are used for the test in order to get better signal level.
3. The EUT was placed on a turntable with 0.8 meter for frequency below 1GHz and 1.5 meter for frequency above 1GHz respectively above ground.
4. The EUT was set 3 meters from the interference receiving antenna, which was mounted on the top of a variable height antenna tower.
5. Corrected Reading: Antenna Factor + Cable Loss + Read Level - Preamp Factor = Level
6. For measurement below 1GHz, If the emission level of the EUT measured by the peak detector is 3 dB lower than the applicable limit, the peak emission level will be reported. Otherwise, the emission measurement will be repeated using the quasi-peak detector and reported.
7. Use the following spectrum analyzer settings:
  - (1) Span shall wide enough to fully capture the emission being measured;
  - (2) Set RBW=100 kHz for  $f < 1$  GHz;  $VBW \geq RBW$ ; Sweep = auto; Detector function = peak; Trace = max hold;
  - (3) Set RBW = 1 MHz,  $VBW = 3$ MHz for  $f \geq 1$  GHz for peak measurement.
 

For average measurement:

    - $VBW = 10$  Hz, when duty cycle is no less than 98 percent.
    - $VBW \geq 1/T$ , when duty cycle is less than 98 percent where T is the minimum transmission duration over which the transmitter is on and is transmitting at its maximum power control level for the tested mode of operation.

Band	Duty Cycle(%)	T(ms)	1/T(kHz)	VBW Setting
802.11b	98.23	-	-	10Hz
802.11g	88.96	1.40	0.71	1kHz
2.4GHz 802.11n HT20	88.64	1.32	0.76	1kHz
2.4GHz 802.11n HT40	79.71	0.66	1.52	3kHz

### 3.5.4 Test Setup

For radiated emissions below 30MHz

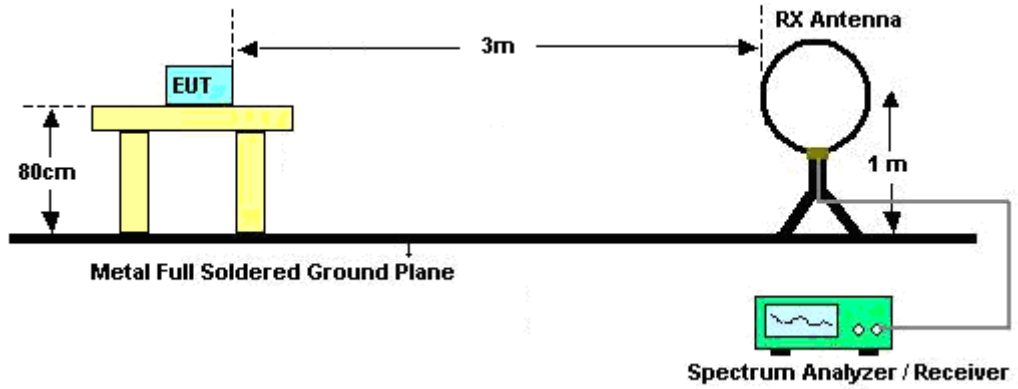

For radiated emissions from 30MHz to 1GHz

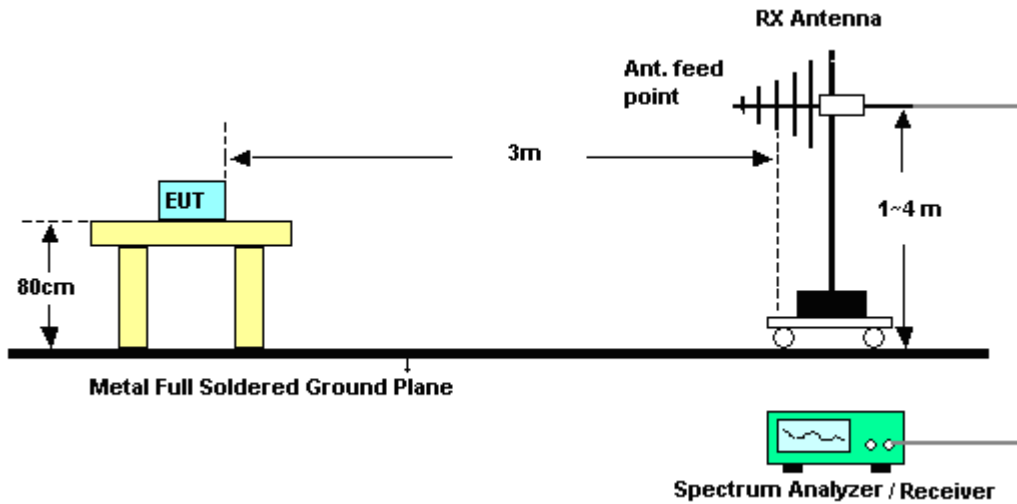

For radiated emissions above 1GHz

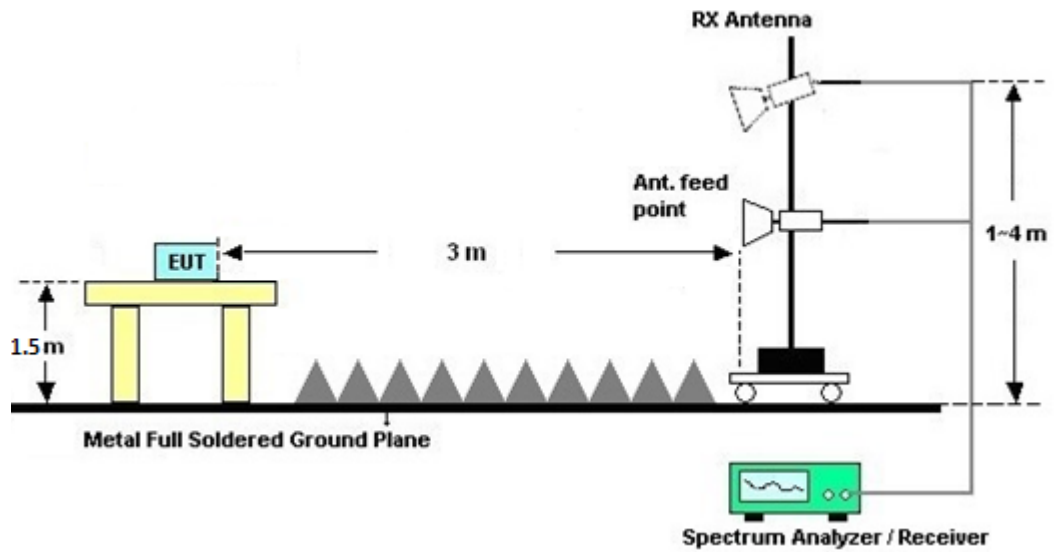

### 3.5.5 Test Results of Radiated Spurious Emissions (9kHz ~ 30MHz)

The low frequency, which started from 9 kHz to 30MHz, was pre-scanned and the result which was 20dB lower than the limit line per 15.31(o) was not reported.

### 3.5.6 Test Result of Radiated Spurious at Band Edges

Please refer to Appendix B.

### 3.5.7 Test Result of Radiated Spurious Emission (30MHz ~ 10<sup>th</sup> Harmonic)

Please refer to Appendix B.



### 3.6 AC Conducted Emission Measurement

#### 3.6.1 Limit of AC Conducted Emission

For equipment that is designed to be connected to the public utility (AC) power line, the radio frequency voltage that is conducted back onto the AC power line on any frequency or frequencies within the band 150 kHz to 30 MHz shall not exceed the limits in the following table.

Frequency of Emission (MHz)	Conducted Limit (dB $\mu$ V)	
	Quasi-Peak	Average
0.15-0.5	66 to 56*	56 to 46*
0.5-5	56	46
5-30	60	50

\*Decreases with the logarithm of the frequency.

#### 3.6.2 Measuring Instruments

The measuring equipment is listed in the section 4 of this test report.

#### 3.6.3 Test Procedures

1. The EUT was placed 0.4 meter from the conducting wall of the shielding room, and it was kept at least 80 centimeters from any other grounded conducting surface.
2. Connect EUT to the power mains through a line impedance stabilization network (LISN).
3. All the support units are connecting to the other LISN.
4. The LISN provides 50 ohm coupling impedance for the measuring instrument.
5. The FCC states that a 50 ohm, 50 microhenry LISN should be used.
6. Both sides of AC line were checked for maximum conducted interference.
7. The frequency range from 150 kHz to 30 MHz was searched.
8. Set the test-receiver system to Peak Detect Function and specified bandwidth (IF bandwidth = 9kHz) with Maximum Hold Mode.

### 3.6.4 Test Setup

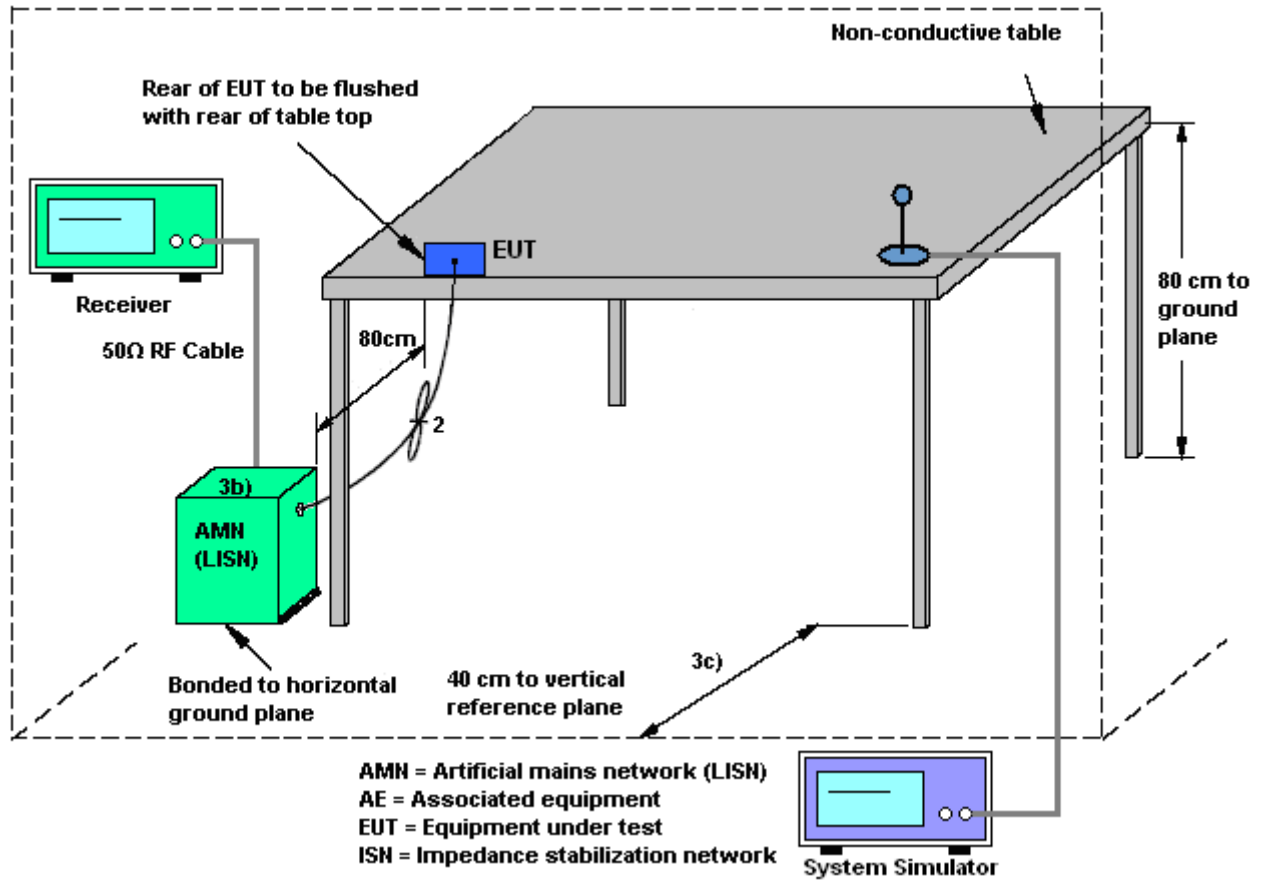



3.6.5 Test Result of AC Conducted Emission

Test Mode :	Mode 1	Temperature :	21~23°C
Test Engineer :	Jacky Yang	Relative Humidity :	41~43%
Test Voltage :	120Vac / 60Hz	Phase :	Line
Function Type :	GSM850 Idle + Bluetooth Link + WLAN Link + Earphone + USB Cable (Charging from Adapter) + SIM1		

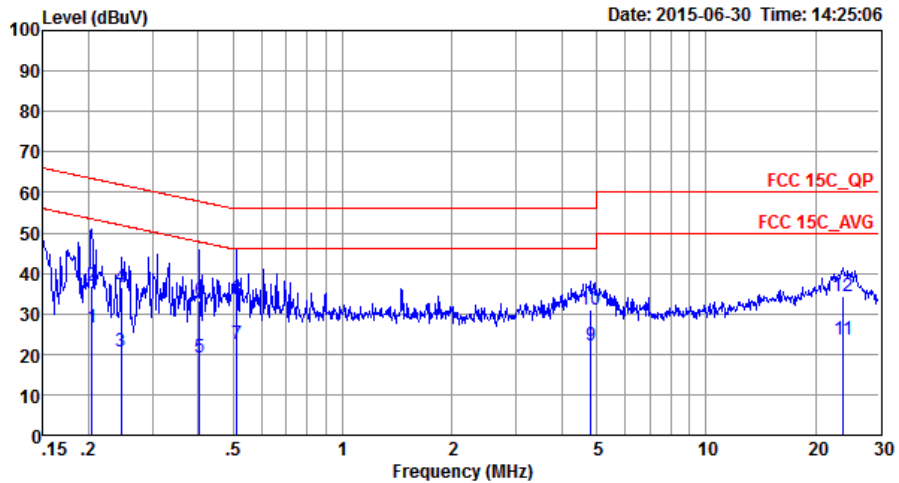

Site : CO01-SZ  
 Condition: FCC 15C QP LISN\_L\_20150304 LINE

Mode : Mode 1  
 IMEI : 356597028994965/356597028994973

	Freq	Level	Over Limit	Limit Line	Read Level	LISN Factor	Cable Loss	Remark
	MHz	dBuV	dB	dBuV	dBuV	dB	dB	
1	0.20	26.61	-26.84	53.45	15.80	0.52	10.29	Average
2	0.20	36.91	-26.54	63.45	26.10	0.52	10.29	QP
3	0.25	20.49	-31.42	51.91	9.69	0.55	10.25	Average
4	0.25	36.59	-25.32	61.91	25.79	0.55	10.25	QP
5	0.40	19.32	-28.45	47.77	8.61	0.54	10.17	Average
6	0.40	33.32	-24.45	57.77	22.61	0.54	10.17	QP
7	0.51	22.62	-23.38	46.00	11.80	0.66	10.16	Average
8 *	0.51	33.52	-22.48	56.00	22.70	0.66	10.16	QP
9	4.82	22.07	-23.93	46.00	11.20	0.63	10.24	Average
10	4.82	30.97	-25.03	56.00	20.10	0.63	10.24	QP
11	23.89	23.49	-26.51	50.00	12.10	0.82	10.57	Average
12	23.89	34.19	-25.81	60.00	22.80	0.82	10.57	QP





Test Mode :	Mode 1	Temperature :	21~23°C
Test Engineer :	Jacky Yang	Relative Humidity :	41~43%
Test Voltage :	120Vac / 60Hz	Phase :	Neutral
Function Type :	GSM850 Idle + Bluetooth Link + WLAN Link + Earphone + USB Cable (Charging from Adapter) + SIM1		

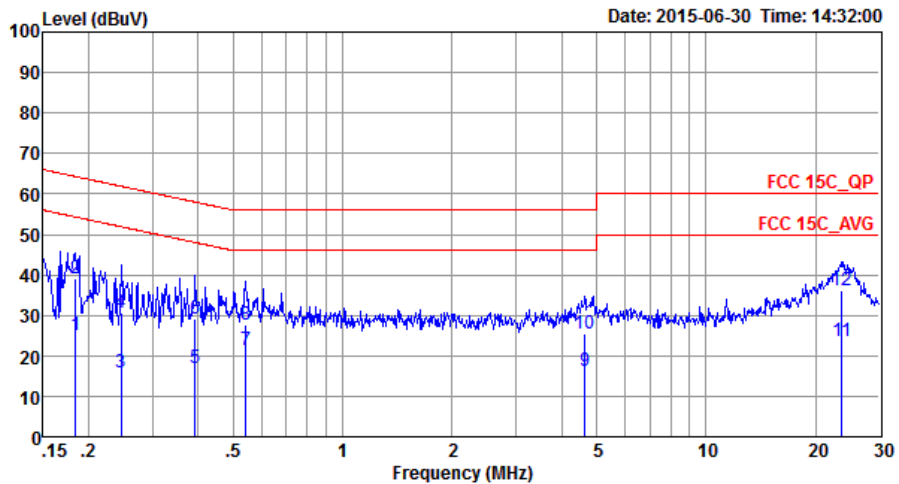

Site : CO01-SZ  
 Condition: FCC 15C QP LISN\_N\_20150304 NEUTRAL

Mode : Mode 1  
 IMEI : 356597028994965/356597028994973

	Freq	Level	Over Limit	Limit Line	Read Level	LISN Factor	Cable Loss	Remark
	MHz	dBuV	dB	dBuV	dBuV	dB	dB	
1	0.18	25.11	-29.17	54.28	14.31	0.49	10.31	Average
2	0.18	39.11	-25.17	64.28	28.31	0.49	10.31	QP
3	0.25	15.80	-36.11	51.91	5.00	0.55	10.25	Average
4	0.25	30.60	-31.31	61.91	19.80	0.55	10.25	QP
5	0.39	17.13	-30.86	47.99	6.41	0.55	10.17	Average
6	0.39	29.23	-28.76	57.99	18.51	0.55	10.17	QP
7	0.54	21.25	-24.75	46.00	10.50	0.60	10.15	Average
8	0.54	27.55	-28.45	56.00	16.80	0.60	10.15	QP
9	4.65	16.08	-29.92	46.00	5.19	0.65	10.24	Average
10	4.65	25.38	-30.62	56.00	14.49	0.65	10.24	QP
11	23.64	23.74	-26.26	50.00	12.40	0.77	10.57	Average
12 *	23.64	36.24	-23.76	60.00	24.90	0.77	10.57	QP



## **3.7 Antenna Requirements**

### **3.7.1 Standard Applicable**

If directional gain of transmitting antennas is greater than 6dBi, the power shall be reduced by the same level in dB comparing to gain minus 6dBi. For the fixed point-to-point operation, the power shall be reduced by one dB for every 3 dB that the directional gain of the antenna exceeds 6 dBi. The use of a permanently attached antenna or of an antenna that uses a unique coupling to the intentional radiator shall be considered sufficient to comply with the FCC rule.

### **3.7.2 Antenna Anti-Replacement Construction**

An embedded-in antenna design is used.

### **3.7.3 Antenna Gain**

The antenna peak gain of EUT is less than 6 dBi. Therefore, it is not necessary to reduce maximum peak output power limit.



## 4 List of Measuring Equipment

Instrument	Manufacturer	Model No.	Serial No.	Characteristics	Calibration Date	Test Date	Due Date	Remark
Spectrum Analyzer	R&S	FSP30	101400	9kHz~30GHz	Jan. 28, 2015	Jul. 04, 2015~ Jul. 09, 2015	Jan. 27, 2016	Conducted (TH01-SZ)
Pulse Power Sensor	Anritsu	MA2411B	1207253	30MHz~40GHz	Jan. 28, 2015	Jul. 04, 2015~ Jul. 09, 2015	Jan. 27, 2016	Conducted (TH01-SZ)
Power Meter	Anritsu	ML2495A	1218010	50MHz Bandwidth	Jan. 28, 2015	Jul. 04, 2015~ Jul. 09, 2015	Jan. 27, 2016	Conducted (TH01-SZ)
EMI Test Receiver&SA	Agilent Technologies	N9038A	MY52260185	20Hz~26.5GHz	May 26, 2015	Jul. 28, 2015	May 25, 2016	Radiation (03CH01-SZ)
Spectrum Analyzer	R&S	FSV40	101041	10kHz~40GHz; Max 30dBm	Sep. 25, 2014	Jul. 28, 2015	Sep. 24, 2015	Radiation (03CH01-SZ)
Loop Antenna	R&S	HFH2-Z2	100354	9kHz~30MHz	May 06, 2015	Jul. 28, 2015	May 05, 2016	Radiation (03CH01-SZ)
Bilog Antenna	TeseQ	CBL6112D	23188	30MHz~2GHz	Nov. 07, 2014	Jul. 28, 2015	Nov. 06, 2015	Radiation (03CH01-SZ)
Double Ridge Horn Antenna	ETS-Lindgren	3117	00119436	1GHz~18GHz	Oct. 15, 2014	Jul. 28, 2015	Oct. 14, 2015	Radiation (03CH01-SZ)
SHF-EHF Horn	com-power	AH-840	101071	18GHz~40GHz	Sep. 04, 2014	Jul. 28, 2015	Sep. 03, 2015	Radiation (03CH01-SZ)
Amplifier	ADVANTEST	BB525C	E9007003	9kHz~3000MHz / 30 dB	Jan. 28, 2015	Jul. 28, 2015	Jan. 27, 2016	Radiation (03CH01-SZ)
Amplifier	Yiai	AV3860B	04030	2GHz~26.5GHz	May 05, 2015	Jul. 28, 2015	May 04, 2016	Radiation (03CH01-SZ)
Amplifier	Agilent Technologies	83017A	MY39501302	500MHz~26.5G Hz	Jan. 28, 2015	Jul. 28, 2015	Jan. 27, 2016	Radiation (03CH01-SZ)
AC Power Source	Chroma	61601	6160100019 85	N/A	NCR	Jul. 28, 2015	NCR	Radiation (03CH01-SZ)
Turn Table	EM	EM1000	N/A	0~360 degree	NCR	Jul. 28, 2015	NCR	Radiation (03CH01-SZ)
Antenna Mast	EM	EM1000	N/A	1 m~4 m	NCR	Jul. 28, 2015	NCR	Radiation (03CH01-SZ)
EMI Receiver	R&S	ESC17	100724	9kHz~3GHz;	Jan. 28, 2015	Jun. 30, 2015	Jan. 27, 2016	Conduction (CO01-SZ)
AC LISN	EMCO	3816/2SH	103892	9kHz~30MHz	Feb. 02, 2015	Jun. 30, 2015	Feb. 01, 2016	Conduction (CO01-SZ)
AC LISN (for auxiliary equipment)	MessTec	AN3016	16850	9kHz~30MHz	Feb. 02, 2015	Jun. 30, 2015	Feb. 01, 2016	Conduction (CO01-SZ)
AC Power Source	Chroma	61602	6160200008 91	100Vac~250Vac	Sep. 29, 2014	Jun. 30, 2015	Sep. 28, 2015	Conduction (CO01-SZ)
Pulse Limiter	COM-POWER	LIT-153 Transient Limiter	53139	150kHz~30MHz	Oct. 24, 2014	Jun. 30, 2015	Oct. 23, 2015	Conduction (CO01-SZ)



## 5 Uncertainty of Evaluation

### Uncertainty of Conducted Emission Measurement (150kHz ~ 30MHz)

Measuring Uncertainty for a Level of Confidence of 95% ( $U = 2Uc(y)$ )	2.3dB
---	-------

### Uncertainty of Radiated Emission Measurement (30 MHz ~ 1000 MHz)

Measuring Uncertainty for a Level of Confidence of 95% ( $U = 2Uc(y)$ )	3.9 dB
---	--------



## **Appendix A. Conducted Test Results**

Test Engineer:	Mygai Wang	Temperature:	21~25	°C
Test Date:	2015/7/4~2015/7/9	Relative Humidity:	51~54	%

**TEST RESULTS DATA**  
**6dB and 99% Occupied Bandwidth**

2.4GHz Band								
Mod.	Data Rate	N <sub>TX</sub>	CH.	Freq. (MHz)	99% Occupied BW (MHz)	6dB BW (MHz)	6dB BW Limit (MHz)	Pass/Fail
11b	1Mbps	1	1	2412	12.85	10.04	0.50	Pass
11b	1Mbps	1	6	2437	13.05	10.04	0.50	Pass
11b	1Mbps	1	11	2462	13.05	10.04	0.50	Pass
11g	6Mbps	1	1	2412	16.35	15.44	0.50	Pass
11g	6Mbps	1	6	2437	16.45	15.68	0.50	Pass
11g	6Mbps	1	11	2462	16.40	15.80	0.50	Pass
HT20	MCS0	1	1	2412	17.55	15.96	0.50	Pass
HT20	MCS0	1	6	2437	17.55	16.90	0.50	Pass
HT20	MCS0	1	11	2462	17.55	16.84	0.50	Pass
HT40	MCS0	1	3	2422	35.80	35.36	0.50	Pass
HT40	MCS0	1	6	2437	35.80	35.12	0.50	Pass
HT40	MCS0	1	9	2452	35.80	35.12	0.50	Pass

**TEST RESULTS DATA**  
**Peak Power Table**

2.4GHz Band										
Mod.	Data Rate	N <sub>TX</sub>	CH.	Freq. (MHz)	Peak Conducted Power (dBm)	Conducted Power Limit (dBm)	DG (dBi)	EIRP Power (dBm)	EIRP Power Limit (dBm)	Pass /Fail
11b	1Mbps	1	1	2412	19.16	30.00	1.10	20.26	36.00	Pass
11b	1Mbps	1	6	2437	19.33	30.00	1.10	20.43	36.00	Pass
11b	1Mbps	1	11	2462	19.42	30.00	1.10	20.52	36.00	Pass
11g	6Mbps	1	1	2412	21.35	30.00	1.10	22.45	36.00	Pass
11g	6Mbps	1	6	2437	21.51	30.00	1.10	22.61	36.00	Pass
11g	6Mbps	1	11	2462	21.45	30.00	1.10	22.55	36.00	Pass
HT20	MCS0	1	1	2412	21.32	30.00	1.10	22.42	36.00	Pass
HT20	MCS0	1	6	2437	21.53	30.00	1.10	22.63	36.00	Pass
HT20	MCS0	1	11	2462	21.37	30.00	1.10	22.47	36.00	Pass
HT40	MCS0	1	3	2422	21.00	30.00	1.10	22.10	36.00	Pass
HT40	MCS0	1	6	2437	21.46	30.00	1.10	22.56	36.00	Pass
HT40	MCS0	1	9	2452	21.09	30.00	1.10	22.19	36.00	Pass



**TEST RESULTS DATA**  
**Average Power Table**  
**(Reporting Only)**

2.4GHz Band						
Mod.	Data Rate	N <sub>TX</sub>	CH.	Freq. (MHz)	Duty Factor (dB)	Average Conducted Power (dBm)
11b	1Mbps	1	1	2412	0.08	16.63
11b	1Mbps	1	6	2437	0.08	16.86
11b	1Mbps	1	11	2462	0.08	17.00
11g	6Mbps	1	1	2412	0.51	12.80
11g	6Mbps	1	6	2437	0.51	14.06
11g	6Mbps	1	11	2462	0.51	13.45
HT20	MCS0	1	1	2412	0.52	12.74
HT20	MCS0	1	6	2437	0.52	14.16
HT20	MCS0	1	11	2462	0.52	13.38
HT40	MCS0	1	3	2422	0.98	10.49
HT40	MCS0	1	6	2437	0.98	12.80
HT40	MCS0	1	9	2452	0.98	10.99

**TEST RESULTS DATA**  
**Peak Power Density**

2.4GHz Band								
Mod.	Data Rate	N <sub>TX</sub>	CH.	Freq. (MHz)	Peak PSD (dBm /3kHz)	DG (dBi)	Peak PSD Limit (dBm /3kHz)	Pass/Fail
11b	1Mbps	1	1	2412	-4.05	1.10	8.00	Pass
11b	1Mbps	1	6	2437	-6.91	1.10	8.00	Pass
11b	1Mbps	1	11	2462	-6.16	1.10	8.00	Pass
11g	6Mbps	1	1	2412	-10.87	1.10	8.00	Pass
11g	6Mbps	1	6	2437	-9.74	1.10	8.00	Pass
11g	6Mbps	1	11	2462	-10.77	1.10	8.00	Pass
HT20	MCS0	1	1	2412	-11.73	1.10	8.00	Pass
HT20	MCS0	1	6	2437	-10.88	1.10	8.00	Pass
HT20	MCS0	1	11	2462	-11.54	1.10	8.00	Pass
HT40	MCS0	1	3	2422	-17.25	1.10	8.00	Pass
HT40	MCS0	1	6	2437	-15.30	1.10	8.00	Pass
HT40	MCS0	1	9	2452	-17.38	1.10	8.00	Pass



## Appendix B. Radiated Spurious Emission

### 15C 2.4GHz 2400~2483.5MHz WIFI 802.11b (Band Edge @ 3m)

WIFI	Note	Frequency	Level	Over	Limit	Read	Antenna	Cable	Preamp	Ant	Table	Peak	Pol.
Ant.				Limit	Line	Level	Factor	Loss	Factor	Pos	Pos	Avg.	
1		( MHz )	( dBμV/m )	( dB )	( dBμV/m )	( dBμV )	( dB/m )	( dB )	( dB )	( cm )	( deg )	(P/A)	(H/V)
802.11b CH 01 2412MHz		2388.12	50.53	-23.47	74	53.51	27.25	4.79	35.02	150	37	P	H
		2389.83	36.04	-17.96	54	39	27.25	4.79	35	150	37	A	H
	*	2412	101.08	-	-	103.95	27.31	4.82	35	150	37	P	H
	*	2412	96.03	-	-	98.9	27.31	4.82	35	150	37	A	H
		2383.89	51.52	-22.48	74	54.56	27.19	4.79	35.02	194	92	P	V
		2389.74	37.73	-16.27	54	40.71	27.25	4.79	35.02	194	92	A	V
	*	2412	102.69	-	-	105.56	27.31	4.82	35	194	92	P	V
	*	2412	97.77	-	-	100.64	27.31	4.82	35	194	92	A	V
802.11b CH 06 2437MHz		2384.61	47.64	-26.36	74	50.68	27.19	4.79	35.02	150	51	P	H
		2381.37	32.92	-21.08	54	35.96	27.19	4.79	35.02	150	51	A	H
	*	2437	99.65	-	-	102.38	27.42	4.82	34.97	150	51	P	H
	*	2437	94.62	-	-	97.35	27.42	4.82	34.97	150	51	A	H
		2489.48	43.37	-30.63	74	45.8	27.6	4.89	34.92	150	51	P	H
		2486.12	28.6	-25.4	54	31.13	27.54	4.85	34.92	150	51	A	H
		2388.03	48.56	-25.44	74	51.54	27.25	4.79	35.02	164	58	P	V
		2381.55	34.41	-19.59	54	37.45	27.19	4.79	35.02	164	58	A	V
	*	2437	101.65	-	-	104.38	27.42	4.82	34.97	164	58	P	V
	*	2437	96.76	-	-	99.49	27.42	4.82	34.97	164	58	A	V
		2484.28	45.34	-28.66	74	47.87	27.54	4.85	34.92	164	58	P	V
	2492.56	30.22	-23.78	54	32.63	27.6	4.89	34.9	164	58	A	V	



<b>802.11b</b> <b>CH 11</b> <b>2462MHz</b>	*	2462	101.13	-	-	103.75	27.48	4.85	34.95	220	35	P	H
	*	2462	96.1	-	-	98.72	27.48	4.85	34.95	220	35	A	H
		2486.76	47.63	-26.37	74	50.16	27.54	4.85	34.92	220	35	P	H
		2486.48	37.92	-16.08	54	40.45	27.54	4.85	34.92	220	35	A	H
	*	2462	100.39	-	-	103.01	27.48	4.85	34.95	157	93	P	V
	*	2462	95.5	-	-	98.12	27.48	4.85	34.95	157	93	A	V
		2487.76	48.86	-25.14	74	51.33	27.6	4.85	34.92	157	93	P	V
		2487.48	38.61	-15.39	54	41.14	27.54	4.85	34.92	157	93	A	V
Remark	1. No other spurious found. 2. All results are PASS against Peak and Average limit line.												



15C 2.4GHz 2400~2483.5MHz

WIFI 802.11b (Harmonic @ 3m)

WIFI	Note	Frequency	Level	Over	Limit	Read	Antenna	Cable	Preamp	Ant	Table	Peak	Pol.
Ant.				Limit	Line	Level	Factor	Loss	Factor	Pos	Pos	Avg.	
1		( MHz )	( dBμV/m )	( dB )	( dBμV/m )	( dBμV )	( dB/m )	( dB )	( dB )	( cm )	( deg )	(P/A)	(H/V)
802.11b		4824	43.26	-30.74	74	63.63	31.05	6.97	58.39	150	360	P	H
CH 01		4824	44.68	-29.32	74	65.05	31.05	6.97	58.39	150	360	P	V
2412MHz													
802.11b		4874	43.54	-30.46	74	64.09	31.12	6.99	58.66	150	360	P	H
CH 06		7311	50.57	-23.43	74	65.01	35.96	8.22	58.62	174	100	P	H
2437MHz		4874	47.34	-26.66	74	67.89	31.12	6.99	58.66	150	360	P	V
		7311	50.53	-23.47	74	64.97	35.96	8.22	58.62	174	100	P	V
802.11b		4924	46.41	-27.59	74	66.74	31.19	7	58.52	150	360	P	H
CH 11		7386	50.91	-23.09	74	65.1	36.08	8.27	58.54	165	274	P	H
2462MHz		4924	49.44	-24.56	74	69.77	31.19	7	58.52	150	360	P	V
		7386	50	-24	74	64.19	36.08	8.27	58.54	165	274	P	V
Remark	<ol style="list-style-type: none"> <li>No other spurious found.</li> <li>All results are PASS against Peak and Average limit line.</li> </ol>												



**15C 2.4GHz 2400~2483.5MHz  
WIFI 802.11g (Band Edge @ 3m)**

WIFI	Note	Frequency	Level	Over	Limit	Read	Antenna	Cable	Preamp	Ant	Table	Peak	Pol.
Ant.				Limit	Line	Level	Factor	Loss	Factor	Pos	Pos	Avg.	
1		( MHz )	( dBμV/m )	( dB )	( dBμV/m )	( dBμV )	( dB/m )	( dB )	( dB )	( cm )	( deg )	(P/A)	(H/V)
802.11g CH 01 2412MHz		2389.47	61.73	-12.27	74	64.71	27.25	4.79	35.02	195	48	P	H
		2389.92	40.82	-13.18	54	43.78	27.25	4.79	35	195	48	A	H
	*	2412	101.72	-	-	104.59	27.31	4.82	35	195	48	P	H
	*	2412	91.13	-	-	94	27.31	4.82	35	195	48	A	H
		2388.39	60.86	-13.14	74	63.84	27.25	4.79	35.02	197	98	P	V
		2389.92	40.76	-13.24	54	43.72	27.25	4.79	35	197	98	A	V
	*	2412	100.66	-	-	103.53	27.31	4.82	35	197	98	P	V
	*	2412	90.31	-	-	93.18	27.31	4.82	35	197	98	A	V
802.11g CH 06 2437MHz		2389.74	53.09	-20.91	74	56.07	27.25	4.79	35.02	192	5	P	H
		2389.92	38.33	-15.67	54	41.29	27.25	4.79	35	192	5	A	H
	*	2437	102.61	-	-	105.34	27.42	4.82	34.97	192	5	P	H
	*	2437	92.19	-	-	94.92	27.42	4.82	34.97	192	5	A	H
		2484.44	49.68	-24.32	74	52.21	27.54	4.85	34.92	192	5	P	H
		2484.4	34.23	-19.77	54	36.76	27.54	4.85	34.92	192	5	A	H
		2388.48	54.32	-19.68	74	57.3	27.25	4.79	35.02	250	98	P	V
		2389.83	38.37	-15.63	54	41.33	27.25	4.79	35	250	98	A	V
	*	2437	103.8	-	-	106.53	27.42	4.82	34.97	250	98	P	V
	*	2437	92.63	-	-	95.36	27.42	4.82	34.97	250	98	A	V
		2486.44	51.37	-22.63	74	53.9	27.54	4.85	34.92	250	98	P	V
		2483.6	34.62	-19.38	54	37.15	27.54	4.85	34.92	250	98	A	V



802.11g CH 11 2462MHz	*	2462	100.92	-	-	103.54	27.48	4.85	34.95	250	37	P	H
	*	2462	90.6	-	-	93.22	27.48	4.85	34.95	250	37	A	H
		2484.04	66.95	-7.05	74	69.48	27.54	4.85	34.92	250	37	P	H
		2483.52	44.51	-9.49	54	47.04	27.54	4.85	34.92	250	37	A	H
	*	2462	100.53	-	-	103.15	27.48	4.85	34.95	211	82	P	V
	*	2462	89.52	-	-	92.14	27.48	4.85	34.95	211	82	A	V
		2484.08	64.99	-9.01	74	67.52	27.54	4.85	34.92	211	82	P	V
		2483.8	44.47	-9.53	54	47	27.54	4.85	34.92	211	82	A	V
Remark	<ol style="list-style-type: none"> <li>No other spurious found.</li> <li>All results are PASS against Peak and Average limit line.</li> </ol>												



15C 2.4GHz 2400~2483.5MHz

WIFI 802.11g (Harmonic @ 3m)

WIFI	Note	Frequency	Level	Over	Limit	Read	Antenna	Cable	Preamp	Ant	Table	Peak	Pol.
Ant.				Limit	Line	Level	Factor	Loss	Factor	Pos	Pos	Avg.	
1		( MHz )	( dBμV/m )	( dB )	( dBμV/m )	( dBμV )	( dB/m )	( dB )	( dB )	( cm )	( deg )	(P/A)	(H/V)
802.11g		4824	42.49	-31.51	74	62.86	31.05	6.97	58.39	150	360	P	H
CH 01		4824	43.34	-30.66	74	63.71	31.05	6.97	58.39	150	360	P	V
2412MHz													
802.11g		4874	42.91	-31.09	74	63.46	31.12	6.99	58.66	150	360	P	H
CH 06		7311	50.08	-23.92	74	64.52	35.96	8.22	58.62	174	100	P	H
2437MHz		4874	44.38	-29.62	74	64.93	31.12	6.99	58.66	150	360	P	V
		7311	49.05	-24.95	74	63.49	35.96	8.22	58.62	174	100	P	V
802.11g		4924	43.04	-30.96	74	63.37	31.19	7	58.52	150	360	P	H
CH 11		7386	48.68	-25.32	74	62.87	36.08	8.27	58.54	155	274	P	H
2462MHz		4924	44.23	-29.77	74	64.56	31.19	7	58.52	150	360	P	V
		7386	48.54	-25.46	74	62.73	36.08	8.27	58.54	155	274	P	V
Remark	1. No other spurious found. 2. All results are PASS against Peak and Average limit line.												





**15C 2.4GHz 2400~2483.5MHz  
WIFI 802.11n HT20 (Band Edge @ 3m)**

WIFI	Note	Frequency	Level	Over	Limit	Read	Antenna	Cable	Preamp	Ant	Table	Peak	Pol.
Ant.				Limit	Line	Level	Factor	Loss	Factor	Pos	Pos	Avg.	
1		( MHz )	( dBμV/m )	( dB )	( dBμV/m )	( dBμV )	( dB/m )	( dB )	( dB )	( cm )	( deg )	(P/A)	(H/V)
802.11n HT20 CH 01 2412MHz		2389.83	64.74	-9.26	74	67.7	27.25	4.79	35	236	24	P	H
		2389.92	41.6	-12.4	54	44.56	27.25	4.79	35	236	24	A	H
	*	2412	100.28	-	-	103.15	27.31	4.82	35	236	24	P	H
	*	2412	90	-	-	92.87	27.31	4.82	35	236	24	A	H
		2389.47	64.21	-9.79	74	67.19	27.25	4.79	35.02	227	99	P	V
		2389.92	42.7	-11.3	54	45.66	27.25	4.79	35	227	99	A	V
	*	2412	102.07	-	-	104.94	27.31	4.82	35	227	99	P	V
	*	2412	90.83	-	-	93.7	27.31	4.82	35	227	99	A	V
802.11n HT20 CH 06 2437MHz		2385.87	53.23	-20.77	74	56.21	27.25	4.79	35.02	250	50	P	H
		2389.47	37.61	-16.39	54	40.59	27.25	4.79	35.02	250	50	A	H
	*	2437	101.88	-	-	104.61	27.42	4.82	34.97	250	50	P	H
	*	2437	91.1	-	-	93.83	27.42	4.82	34.97	250	50	A	H
		2484.16	50.25	-23.75	74	52.78	27.54	4.85	34.92	250	50	P	H
		2484.04	33.37	-20.63	54	35.9	27.54	4.85	34.92	250	50	A	H
		2386.23	56.17	-17.83	74	59.15	27.25	4.79	35.02	221	95	P	V
		2389.92	39.14	-14.86	54	42.1	27.25	4.79	35	221	95	A	V
	*	2437	103.24	-	-	105.97	27.42	4.82	34.97	221	95	P	V
	*	2437	92.6	-	-	95.33	27.42	4.82	34.97	221	95	A	V
		2483.76	50.22	-23.78	74	52.75	27.54	4.85	34.92	221	95	P	V
	2483.56	34.91	-19.09	54	37.44	27.54	4.85	34.92	221	95	A	V	



802.11n HT20 CH 11 2462MHz	*	2462	100.58	-	-	103.2	27.48	4.85	34.95	250	26	P	H
	*	2462	89.78	-	-	92.4	27.48	4.85	34.95	250	26	A	H
		2484.2	67.33	-6.67	74	69.86	27.54	4.85	34.92	250	26	P	H
		2483.52	45.53	-8.47	54	48.06	27.54	4.85	34.92	250	26	A	H
	*	2462	101.51	-	-	104.13	27.48	4.85	34.95	242	95	P	V
	*	2462	89.95	-	-	92.57	27.48	4.85	34.95	242	95	A	V
		2483.56	69.11	-4.89	74	71.64	27.54	4.85	34.92	242	95	P	V
		2483.52	44.98	-9.02	54	47.51	27.54	4.85	34.92	242	95	A	V
Remark	1. No other spurious found. 2. All results are PASS against Peak and Average limit line.												



**15C 2.4GHz 2400~2483.5MHz**  
**WIFI 802.11n HT20 (Harmonic @ 3m)**

WIFI	Note	Frequency	Level	Over	Limit	Read	Antenna	Cable	Preamp	Ant	Table	Peak	Pol.
Ant.				Limit	Line	Level	Factor	Loss	Factor	Pos	Pos	Avg.	
1		( MHz )	( dBμV/m )	( dB )	( dBμV/m )	( dBμV )	( dB/m )	( dB )	( dB )	( cm )	( deg )	(P/A)	(H/V)
802.11n		4824	43.07	-30.93	74	63.44	31.05	6.97	58.39	150	360	P	H
HT20													
CH 01		4824	43.33	-30.67	74	63.7	31.05	6.97	58.39	150	360	P	V
2412MHz													
802.11n		4874	42.92	-31.08	74	63.47	31.12	6.99	58.66	150	360	P	H
HT20		7311	47.96	-26.04	74	62.4	35.96	8.22	58.62	174	100	P	H
CH 06		4874	43.74	-30.26	74	64.29	31.12	6.99	58.66	150	360	P	V
2437MHz		7311	46.49	-27.51	74	60.93	35.96	8.22	58.62	174	100	P	V
802.11n		4924	43.16	-30.84	74	63.49	31.19	7	58.52	150	360	P	H
HT20		7386	48.59	-25.41	74	62.78	36.08	8.27	58.54	145	274	P	H
CH 11		4924	43.16	-30.84	74	63.49	31.19	7	58.52	150	360	P	V
2462MHz		7386	48.57	-25.43	74	62.76	36.08	8.27	58.54	145	274	P	V
Remark	1. No other spurious found. 2. All results are PASS against Peak and Average limit line.												



**15C 2.4GHz 2400~2483.5MHz  
WIFI 802.11n HT40 (Band Edge @ 3m)**

WIFI	Note	Frequency	Level	Over	Limit	Read	Antenna	Cable	Preamp	Ant	Table	Peak	Pol.
Ant.				Limit	Line	Level	Factor	Loss	Factor	Pos	Pos	Avg.	
1		( MHz )	( dBμV/m )	( dB )	( dBμV/m )	( dBμV )	( dB/m )	( dB )	( dB )	( cm )	( deg )	(P/A)	(H/V)
802.11n HT40 CH 03 2422MHz		2388.84	69.43	-4.57	74	72.41	27.25	4.79	35.02	150	50	P	H
		2389.92	42.89	-11.11	54	45.85	27.25	4.79	35	150	50	A	H
	*	2422	96.34	-	-	99.12	27.37	4.82	34.97	150	50	P	H
	*	2422	85.51	-	-	88.29	27.37	4.82	34.97	150	50	A	H
		2484.04	49.27	-24.73	74	51.8	27.54	4.85	34.92	150	50	P	H
		2483.64	31.87	-22.13	54	34.4	27.54	4.85	34.92	150	50	A	H
		2388.93	70.81	-3.19	74	73.79	27.25	4.79	35.02	188	107	P	V
		2389.92	44.03	-9.97	54	46.99	27.25	4.79	35	188	107	A	V
	*	2422	96.84	-	-	99.62	27.37	4.82	34.97	188	107	P	V
	*	2422	86.71	-	-	89.49	27.37	4.82	34.97	188	107	A	V
	2488.76	49.77	-24.23	74	52.2	27.6	4.89	34.92	188	107	P	V	
	2483.8	32.83	-21.17	54	35.36	27.54	4.85	34.92	188	107	A	V	
802.11n HT40 CH 06 2437MHz		2389.83	63.72	-10.28	74	66.68	27.25	4.79	35	150	53	P	H
		2389.92	44.58	-9.42	54	47.54	27.25	4.79	35	150	53	A	H
	*	2437	97.62	-	-	100.35	27.42	4.82	34.97	150	53	P	H
	*	2437	87.07	-	-	89.8	27.42	4.82	34.97	150	53	A	H
		2483.68	58.8	-15.2	74	61.33	27.54	4.85	34.92	150	53	P	H
		2483.72	38.96	-15.04	54	41.49	27.54	4.85	34.92	150	53	A	H
		2387.67	62.74	-11.26	74	65.72	27.25	4.79	35.02	223	94	P	V
		2389.92	45.55	-8.45	54	48.51	27.25	4.79	35	223	94	A	V
	*	2437	99.12	-	-	101.85	27.42	4.82	34.97	223	94	P	V
	*	2437	88.8	-	-	91.53	27.42	4.82	34.97	223	94	A	V
	2483.92	58.21	-15.79	74	60.74	27.54	4.85	34.92	223	94	P	V	
	2483.6	40.13	-13.87	54	42.66	27.54	4.85	34.92	223	94	A	V	



<b>802.11n</b>  <b>HT40</b>  <b>CH 09</b>  <b>2452MHz</b>		2373.45	51.84	-22.16	74	54.88	27.19	4.79	35.02	173	308	P	H
		2389.56	33.85	-20.15	54	36.83	27.25	4.79	35.02	173	308	A	H
	*	2452	94.44	-	-	97.12	27.42	4.85	34.95	173	308	P	H
	*	2452	83.49	-	-	86.17	27.42	4.85	34.95	173	308	A	H
		2484.84	66.78	-7.22	74	69.31	27.54	4.85	34.92	173	308	P	H
		2483.56	37.86	-16.14	54	40.39	27.54	4.85	34.92	173	308	A	H
		2373.9	56.88	-17.12	74	59.92	27.19	4.79	35.02	163	108	P	V
		2386.32	36	-18	54	38.98	27.25	4.79	35.02	163	108	A	V
	*	2452	93.93	-	-	96.61	27.42	4.85	34.95	163	108	P	V
	*	2452	83.77	-	-	86.45	27.42	4.85	34.95	163	108	A	V
		2485.36	65.51	-8.49	74	68.04	27.54	4.85	34.92	163	108	P	V
		2484.6	36.91	-17.09	54	39.44	27.54	4.85	34.92	163	108	A	V
Remark	1. No other spurious found. 2. All results are PASS against Peak and Average limit line.												



**15C 2.4GHz 2400~2483.5MHz**  
**WIFI 802.11n HT40 (Harmonic @ 3m)**

WIFI	Note	Frequency	Level	Over	Limit	Read	Antenna	Cable	Preamp	Ant	Table	Peak	Pol.
Ant.				Limit	Line	Level	Factor	Loss	Factor	Pos	Pos	Avg.	
1		( MHz )	( dBμV/m )	( dB )	( dBμV/m )	( dBμV )	( dB/m )	( dB )	( dB )	( cm )	( deg )	(P/A)	(H/V)
802.11n		4844	43.66	-30.34	74	64.1	31.07	6.97	58.48	150	360	P	H
HT40		7266	47.05	-26.95	74	61.48	35.91	8.19	58.53	200	360	P	H
CH 03		4844	43.55	-30.45	74	63.99	31.07	6.97	58.48	150	360	P	V
2422MHz		7266	47.4	-26.6	74	61.83	35.91	8.19	58.53	200	360	P	V
802.11n		4874	43.17	-30.83	74	63.72	31.12	6.99	58.66	150	360	P	H
HT40		7311	47.83	-26.17	74	62.27	35.96	8.22	58.62	150	360	P	H
CH 06		4874	43.18	-30.82	74	63.73	31.12	6.99	58.66	150	360	P	V
2437MHz		7311	47.55	-26.45	74	61.99	35.96	8.22	58.62	150	360	P	V
802.11n		4904	43.72	-30.28	74	64.19	31.17	7	58.64	150	360	P	H
HT40		7356	47.48	-26.52	74	61.77	36.03	8.25	58.57	150	360	P	H
CH 09		4904	44.01	-29.99	74	64.48	31.17	7	58.64	150	360	P	V
2452MHz		7356	47.19	-26.81	74	61.48	36.03	8.25	58.57	150	360	P	V
Remark	1. No other spurious found. 2. All results are PASS against Peak and Average limit line.												



**15C Emission below 1GHz  
2.4GHz WIFI 802.11n HT40 (LF)**

WIFI	Note	Frequency	Level	Over	Limit	Read	Antenna	Cable	Preamp	Ant	Table	Peak	Pol.
Ant.				Limit	Line	Level	Factor	Loss	Factor	Pos	Pos	Avg.	
1		( MHz )	( dBμV/m )	( dB )	( dBμV/m )	(dBμV)	( dB/m )	( dB )	( dB )	( cm )	( deg )	(P/A)	(H/V)
2.4GHz 802.11n HT40 LF		47.46	15.17	-24.83	40	37.56	9.99	1	33.38			P	H
		149.31	29.33	-14.17	43.5	49.83	11.21	1.53	33.24	100	350	P	H
		214.3	20.21	-23.29	43.5	40.91	10.64	1.8	33.14			P	H
		328.76	15.82	-30.18	46	32.25	14.59	1.94	32.96			P	H
		498.51	19.63	-26.37	46	31.84	17.87	2.41	32.49			P	H
		658.56	21.8	-24.2	46	31.87	19.21	2.71	31.99			P	H
		34.85	30.68	-9.32	40	47.52	15.55	1	33.39	200	300	P	V
		46.49	28.1	-11.9	40	50.13	10.35	1	33.38			P	V
		76.56	27.37	-12.63	40	50.87	8.74	1.14	33.38			P	V
		99.84	20.14	-23.36	43.5	39.82	12.3	1.38	33.36			P	V
		150.28	20.42	-23.08	43.5	40.94	11.19	1.53	33.24			P	V
	211.39	16.06	-27.44	43.5	36.88	10.53	1.8	33.15			P	V	
Remark	1. No other spurious found. 2. All results are PASS against limit line.												



Note symbol

*	<b>Fundamental Frequency</b> which can be ignored. However, the level of any unwanted emissions shall not exceed the level of the fundamental frequency per 15.209(c).
!	Test result is <b>over limit</b> line.
P/A	<b>Peak</b> or <b>Average</b>
H/V	<b>Horizontal</b> or <b>Vertical</b>





A calculation example for radiated spurious emission is shown as below:

WIFI	Note	Frequency	Level	Over	Limit	Read	Antenna	Cable	Preamp	Ant	Table	Peak	Pol.
Ant.				Limit	Line	Level	Factor	Loss	Factor	Pos	Pos	Avg.	
1+2		( MHz )	( dBμV/m )	( dB )	( dBμV/m )	( dBμV )	( dB/m )	( dB )	( dB )	( cm )	( deg )	( P/A )	( H/V )
802.11b		2390	55.45	-18.55	74	54.51	32.22	4.58	35.86	103	308	P	H
CH 01		2390	43.54	-10.46	54	42.6	32.22	4.58	35.86	103	308	A	H
2412MHz													

- Level(dBμV/m) =  
Antenna Factor(dB/m) + Cable Loss(dB) + Read Level(dBμV) - Preamp Factor(dB)
- Over Limit(dB) = Level(dBμV/m) – Limit Line(dBμV/m)

**For Peak Limit @ 2390MHz:**

- Level(dBμV/m)  
= Antenna Factor(dB/m) + Cable Loss(dB) + Read Level(dBμV) - Preamp Factor(dB)  
= 32.22(dB/m) + 4.58(dB) + 54.51(dBμV) – 35.86 (dB)  
= 55.45 (dBμV/m)
- Over Limit(dB)  
= Level(dBμV/m) – Limit Line(dBμV/m)  
= 55.45(dBμV/m) – 74(dBμV/m)  
= -18.55(dB)

**For Average Limit @ 2390MHz:**

- Level(dBμV/m)  
= Antenna Factor(dB/m) + Cable Loss(dB) + Read Level(dBμV) - Preamp Factor(dB)  
= 32.22(dB/m) + 4.58(dB) + 42.6(dBμV) – 35.86 (dB)  
= 43.54 (dBμV/m)
- Over Limit(dB)  
= Level(dBμV/m) – Limit Line(dBμV/m)  
= 43.54(dBμV/m) – 54(dBμV/m)  
= -10.46(dB)

**Both peak and average measured complies with the limit line, so test result is “PASS”.**