



Test Report No.: RF130201N028



TEST REPORT

Applicant	Brightstar Corporation
Address:	9725 NW 117th Ave., Miami, Florida, United States

Manufacturer or Supplier	KCMOBILE
Address	#502 Ace Techno Tower 8th, 191-7 Guro 3 Dong, Guro-Gu, Seoul, KOREA (152-780)
Product	mobile phone
Brand Name	Avvio
Model	Avvio 701S/Avvio 701
Additional Model & Model Difference	N/A
Date of tests	Feb. 01, 2013 ~ Mar. 11, 2013

the tests have been carried out according to the requirements of the following standards:

FCC Part 15, Subpart C (Section 15.247)

CONCLUSION: The submitted sample was found to COMPLY with the test requirement

Tesed by Kent Liu
Project Engineer / EMC Department

Approved by Sam Tung
Manager / EMC Department

Date: Mar. 11, 2013

This report is for your exclusive use. Any copying or replication of this report to or for any other person or entity, or use of our name or trademark, is permitted only with our prior written permission. This report sets forth our findings solely with respect to the test samples identified herein. The results set forth in this report are not indicative or representative of the quality or characteristics of the lot from which a test sample was taken or any similar or identical product unless specifically and expressly noted. Our report includes all of the tests requested by you and the results thereof based upon the information that you provided to us. You have 60 days from date of issuance of this report to notify us of any material error or omission caused by our negligence, provided, however, that such notice shall be in writing and shall specifically address the issue you wish to raise. A failure to raise such issue within the prescribed time shall constitute your unqualified acceptance of the completeness of this report, the tests conducted and the correctness of the report contents. Unless specific mention, the uncertainty of measurement has been explicitly taken into account to declare the compliance or non-compliance to the specification



Test Report No.: RF130201N028

TABLE OF CONTENTS

RELEASE CONTROL RECORD	5
1 SUMMARY OF TEST RESULTS	6
2 MEASUREMENT UNCERTAINTY	6
3 GENERAL INFORMATION	7
3.1 GENERAL DESCRIPTION OF EUT.....	7
3.2 DESCRIPTION OF TEST MODES.....	8
3.2.1 CONFIGURATION OF SYSTEM UNDER TEST	9
3.2.2 TEST MODE APPLICABILITY AND TESTED CHANNEL DETAIL.....	9
3.3 GENERAL DESCRIPTION OF APPLIED STANDARDS.....	12
3.4 DESCRIPTION OF SUPPORT UNITS.....	12
4 TEST TYPES AND RESULTS	13
4.1 CONDUCTED EMISSION MEASUREMENT	13
4.1.1 LIMITS OF CONDUCTED EMISSION MEASUREMENT	13
4.1.2 TEST INSTRUMENTS	13
4.1.3 TEST PROCEDURES	14
4.1.4 DEVIATION FROM TEST STANDARD	14
4.1.5 TEST SETUP	15
4.1.6 EUT OPERATING CONDITIONS	15
4.1.7 TEST RESULTS.....	16
4.2 RADIATED EMISSION AND BANDEDGE MEASUREMENT	18
4.2.1 LIMITS OF RADIATED EMISSION AND BANDEDGE MEASUREMENT	18
4.2.2 TEST INSTRUMENTS	19
4.2.3 TEST PROCEDURES.....	20
4.2.4 DEVIATION FROM TEST STANDARD.....	20
4.2.5 TEST SETUP	21
4.2.6 EUT OPERATING CONDITIONS	21
4.2.7 TEST RESULTS.....	22
4.3 NUMBER OF HOPPING FREQUENCY USED.....	30
4.3.1 LIMIT OF HOPPING FREQUENCY USED	30
4.3.2 TEST SETUP.....	30
4.3.3 TEST INSTRUMENTS.....	30
4.3.4 TEST PROCEDURES	30
4.3.5 DEVIATION FROM TEST STANDARD	31
4.3.6 TEST RESULTS.....	31



Test Report No.: RF130201N028

4.4.	DWELL TIME ON EACH CHANNEL	34
4.4.1	LIMIT OF DWELL TIME USED	34
4.4.2	TEST SETUP	34
4.4.3	TEST INSTRUMENTS	34
4.4.4	TEST PROCEDURES	34
4.4.5	DEVIATION FROM TEST STANDARD	35
4.4.6	TEST RESULTS	35
4.5.	CHANNEL BANDWIDTH	43
4.5.1	LIMITS OF CHANNEL BANDWIDTH	43
4.5.2	TEST SETUP	43
4.5.3	TEST INSTRUMENTS	43
4.5.4	TEST PROCEDURE	43
4.5.5	DEVIATION FROM TEST STANDARD	44
4.5.6	EUT OPERATING CONDITION	44
4.5.7	TEST RESULTS	44
4.6.	HOPPING CHANNEL SEPARATION	48
4.6.1.	LIMIT OF HOPPING CHANNEL SEPARATION	48
4.6.2.	TEST SETUP	48
4.6.3.	TEST INSTRUMENTS	48
4.6.4.	TEST PROCEDURES	48
4.6.5.	DEVIATION FROM TEST STANDARD	48
4.6.6.	TEST RESULTS	49
4.7.	MAXIMUM OUTPUT POWER	51
4.7.1	LIMITS OF MAXIMUM OUTPUT POWER MEASUREMENT	51
4.7.2	TEST SETUP	51
4.7.3	TEST INSTRUMENTS	51
4.7.4	TEST PROCEDURES	51
4.7.5	DEVIATION FROM TEST STANDARD	52
4.7.6	EUT OPERATING CONDITION	52
4.7.7	TEST RESULTS	52
4.8.	BAND EDGES MEASUREMENT	54
4.8.1	LIMITS OF BAND EDGES MEASUREMENT	54
4.8.2	TEST INSTRUMENTS	54
4.8.3	TEST PROCEDURE	54
4.8.4	DEVIATION FROM TEST STANDARD	54
4.8.5	EUT OPERATING CONDITION	54
4.8.6	TEST RESULTS	54



Test Report No.: RF130201N028

5.	PHOTOGRAPHS OF THE TEST CONFIGURATION	58
6.	APPENDIX A - MODIFICATIONS RECORDERS FOR ENGINEERING CHANGES TO THE EUT BY THE LAB.....	59



Test Report No.: RF130201N028

RELEASE CONTROL RECORD

ISSUE NO.	REASON FOR CHANGE	DATE ISSUED
RF130201N028	Original release	Mar. 11, 2013

1 SUMMARY OF TEST RESULTS

The EUT has been tested according to the following specifications:

APPLIED STANDARD: FCC Part 15, Subpart C			
STANDARD SECTION	TEST TYPE AND LIMIT	RESULT	REMARK
15.207	AC Power Conducted Emission	PASS	Meet the requirement of limit. Minimum passing margin is -13.76dB at 0.41197MHz.
15.247(a)(1) (iii)	Number of Hopping Frequency Used	PASS	Meet the requirement of limit.
15.247(a)(1) (iii)	Dwell Time on Each Channel	PASS	Meet the requirement of limit.
15.247(a)(1)	1. Hopping Channel Separation 2. Spectrum Bandwidth of a Frequency Hopping Sequence Spread Spectrum System	PASS	Meet the requirement of limit.
15.247(b)	Maximum Peak Output Power	PASS	Meet the requirement of limit.
15.247(d)	Transmitter Radiated Emissions	PASS	Meet the requirement of limit. Minimum passing margin is -5.79dB at 36.47MHz
15.247(d)	Band Edge Measurement	PASS	Meet the requirement of limit.
15.203	Antenna Requirement	PASS	No antenna connector is used.

NOTE: If The Frequency Hopping System operating in 2400-2483.5MHz band and the output power less than 125mW. The hopping channel carrier frequencies separated by a minimum of 25kHz or two-thirds of the 20dB bandwidth of hopping channel whichever is greater.

2 MEASUREMENT UNCERTAINTY

Where relevant, the following measurement uncertainty levels have been estimated for tests performed on the EUT as specified in CISPR 16-4-2:

MEASUREMENT	FREQUENCY	UNCERTAINTY
Conducted emissions	9kHz~30MHz	2.94dB
Radiated emissions	30MHz ~ 1000MHz	3.6419dB
	1GHz ~ 18GHz	2.2dB
	18GHz ~ 40GHz	1.94dB

This uncertainty represents an expanded uncertainty expressed at approximately the 95% confidence level using a coverage factor of k=2.

3 GENERAL INFORMATION

3.1 GENERAL DESCRIPTION OF EUT

PRODUCT	mobile phone
MODEL NO.	Avvio 701S/Avvio 701
FCC ID	WVBA701X
POWER SUPPLY	5.0VDC (adapter or host equipment) ; 3.7VDC (battery)
MODULATION TYPE	FHSS
OPERATING FREQUENCY	2402MHz~2480MHz
NUMBER OF CHANNEL	79
MAX. OUTPUT POWER	6.34dBm
ANTENNA TYPE	PIFA antenna with -3dBi gain
I/O PORTS	USB Port, Earphone Port
DATA CABLE	USB Cable: Unshielded, Detachable, 1m Earphone Cable: Unshielded, Detachable, 0.9m

NOTE:

1. There are WLAN, Bluetooth, GSM technology used for the EUT.
2. The EUT was powered by the following adapter:

ADAPTER	
BRAND:	LEIDIBAO
MODEL:	LDB-0500500U
INPUT:	AC 100-240V, 50/60Hz, 0.15A
OUTPUT:	DC 5V, 500mA
DC LINE:	N/A

3. The above EUT information is declared by manufacturer and for more detailed features description, please refer to the manufacturer's specifications or user's manual.

3.2 DESCRIPTION OF TEST MODES

79 channels are provided to this EUT:

CHANNEL	FREQ. (MHz)	CHANNEL	FREQ. (MHz)	CHANNEL	FREQ. (MHz)	CHANNEL	FREQ. (MHz)
0	2402	20	2422	40	2442	60	2462
1	2403	21	2423	41	2443	61	2463
2	2404	22	2424	42	2444	62	2464
3	2405	23	2425	43	2445	63	2465
4	2406	24	2426	44	2446	64	2466
5	2407	25	2427	45	2447	65	2467
6	2408	26	2428	46	2448	66	2468
7	2409	27	2429	47	2449	67	2469
8	2410	28	2430	48	2450	68	2470
9	2411	29	2431	49	2451	69	2471
10	2412	30	2432	50	2452	70	2472
11	2413	31	2433	51	2453	71	2473
12	2414	32	2434	52	2454	72	2474
13	2415	33	2435	53	2455	73	2475
14	2416	34	2436	54	2456	74	2476
15	2417	35	2437	55	2457	75	2477
16	2418	36	2438	56	2458	76	2478
17	2419	37	2439	57	2459	77	2479
18	2420	38	2440	58	2460	78	2480
19	2421	39	2441	59	2461		

3.2.1. CONFIGURATION OF SYSTEM UNDER TEST

TEST MODE A

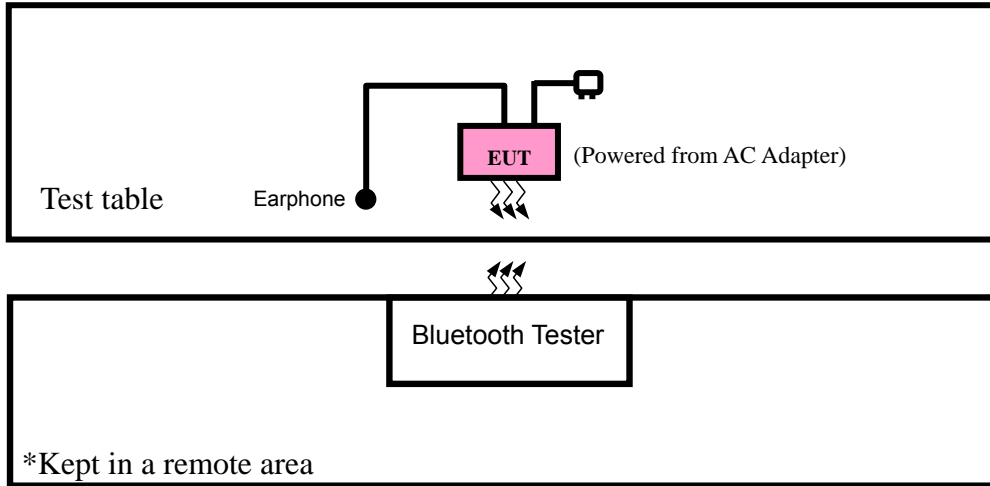

3.2.2. TEST MODE APPLICABILITY AND TESTED CHANNEL DETAIL

Pre-Scan has been conducted to determine the worst-case mode from all possible combinations between available modulations, data rates, XYZ axis and antenna ports

The worst case was found when positioned on X axis for radiated emission.

Following channel(s) was (were) selected for the final test as listed below:

EUT CONFIGURE MODE	APPLICABLE TO				DESCRIPTION
	RE \geq 1G	RE $<$ 1G	PLC	APCM	
A	√	√	√	√	EUT + Adapter + Earphone with Bluetooth link
B	-	√	NOTE	-	EUT + Battery + Earphone with Bluetooth link
C	-	√	√	-	EUT + USB Charger + Earphone with Bluetooth link

Where **RE \geq 1G**: Radiated Emission above 1GHz

RE $<$ 1G: Radiated Emission below 1GHz

PLC: Power Line Conducted Emission

APCM: Antenna Port Conducted Measurement

NOTE: No need to concern of Conducted Emission due to the EUT is powered by battery.

POWER LINE CONDUCTED EMISSION TEST:

- Pre-Scan has been conducted to determine the worst-case mode from all possible combinations between available modulations, antenna ports (if EUT with antenna diversity architecture), and packet types.
- Following channel(s) was (were) selected for the final test as listed below.

EUT CONFIGURE MODE	AVAILABLE CHANNEL	TESTED CHANNEL	MODULATION TECHNOLOGY	MODULATION TYPE	PACKET TYPE
A	0 to 78	0	FHSS	GFSK	DH5

RADIATED EMISSION TEST (BELOW 1 GHz):

- Pre-Scan has been conducted to determine the worst-case mode from all possible combinations between available modulations, XYZ axis, antenna ports (if EUT with antenna diversity architecture) and packet type.
- Following channel(s) was (were) selected for the final test as listed below.

EUT CONFIGURE MODE	AVAILABLE CHANNEL	TESTED CHANNEL	MODULATION TECHNOLOGY	MODULATION TYPE	PACKET TYPE	AXIS
A	0 to 78	0	FHSS	GFSK	DH5	X

RADIATED EMISSION TEST (ABOVE 1 GHz):

- Pre-Scan has been conducted to determine the worst-case mode from all possible combinations between available modulations, XYZ axis, antenna ports (if EUT with antenna diversity architecture) and packet type.
- Following channel(s) was (were) selected for the final test as listed below.

AVAILABLE CHANNEL	TESTED CHANNEL	MODULATION TECHNOLOGY	MODULATION TYPE	PACKET TYPE	Axis
0 to 78	0, 39, 78	FHSS	GFSK	DH5	X
0 to 78	0, 39, 78	FHSS	8DPSK	DH5	X

ANTENNA PORT CONDUCTED MEASUREMENT:

- This item includes all test value of each mode, but only includes spectrum plot of worst value of each mode.
- Pre-Scan has been conducted to determine the worst-case mode from all possible combinations between available modulations, antenna ports (if EUT with antenna diversity architecture), and packet types.
- Following channel(s) was (were) selected for the final test as listed below.

AVAILABLE CHANNEL	TESTED CHANNEL	MODULATION TECHNOLOGY	MODULATION TYPE	PACKET TYPE
0 to 78	0, 39, 78	FHSS	GFSK	DH5
0 to 78	0, 39, 78	FHSS	8DPSK	DH5

TEST CONDITION:

APPLICABLE TO	ENVIRONMENTAL CONDITIONS	INPUT POWER (SYSTEM)	TESTED BY
RE \geq 1G	23deg. C, 56%RH	120Vac, 60Hz	Yuqiang Yin
RE $<$ 1G	23deg. C, 56%RH	120Vac, 60Hz	Yuqiang Yin
PLC	23deg. C, 40%RH	120Vac, 60Hz	Bin Wei
APCM	25deg. C, 60%RH	120Vac, 60Hz	Venless Long



3.3 GENERAL DESCRIPTION OF APPLIED STANDARDS

The EUT is a RF Product. According to the specifications of the manufacturer, it must comply with the requirements of the following standards:

FCC Part 15, Subpart C. (15.247)

ANSI C63.10-2009

All test items have been performed and recorded as per the above standards.

3.4 DESCRIPTION OF SUPPORT UNITS

The EUT has been tested as an independent unit together with other necessary accessories or support units. The following support units or accessories were used to form a representative test configuration during the tests.

NO.	PRODUCT	BRAND	MODEL NO.	SERIAL NO.	FCC ID
1	BT earphone	FAP00	H6080	N/A	N/A

NO.	SIGNAL CABLE DESCRIPTION OF THE ABOVE SUPPORT UNITS
1.	N/A

4 TEST TYPES AND RESULTS

4.1. CONDUCTED EMISSION MEASUREMENT

4.1.1 LIMITS OF CONDUCTED EMISSION MEASUREMENT

FREQUENCY OF EMISSION (MHz)	CONDUCTED LIMIT (dB μ V)	
	Quasi-peak	Average
0.15 ~ 0.5	66 to 56	56 to 46
0.5 ~ 5	56	46
5 ~ 30	60	50

NOTE: 1. The lower limit shall apply at the transition frequencies.

- The limit decreases in line with the logarithm of the frequency in the range of 0.15 to 0.50MHz.
- All emanations from a class A/B digital device or system, including any network of conductors and apparatus connected thereto, shall not exceed the level of field strengths specified above.

4.1.2 TEST INSTRUMENTS

DESCRIPTION & MANUFACTURER	MODEL NO.	SERIAL NO.	DATE OF CALIBRATION	DUE DATE OF CALIBRATION
EMI Test Receiver Rohde&Schwarz	ESU26	100005	May 15,12	May 14,13
Artificial Mains Network Rohde&Schwarz	ENV216	101173	May 15,12	May 14,13
Artificial Mains Network Rohde&Schwarz	ESH2-Z5	100071	May 15,12	May 14,13
RF Cable FUJIKURA	3D-2W	553 Cable	May 15,12	May 14,13
Test software	ADT_Cond_V7.3.7	N/A	N/A	N/A

- NOTE:** 1. The calibration interval of the above test instruments is 12 months and the calibrations are traceable to CEPREI/CHINA and NIM/CHINA
- The test was performed in Dongguan Shielded Room 553.



Test Report No.: RF130201N028

4.1.3 TEST PROCEDURES

- a. The EUT was placed 0.4 meters from the conducting wall of the shielded room with EUT being connected to the power mains through a line impedance stabilization network (LISN). Other support units were connected to the power mains through another LISN. The two LISNs provide 50 ohm/ 50uH of coupling impedance for the measuring instrument.
- b. Both lines of the power mains connected to the EUT were checked for maximum conducted interference.
- c. The frequency range from 150kHz to 30MHz was searched. Emission levels under (Limit - 20dB) was not recorded.

NOTE: All modes of operation were investigated and the worst-case emissions are reported.

4.1.4 DEVIATION FROM TEST STANDARD

No deviation.

4.1.5 TEST SETUP

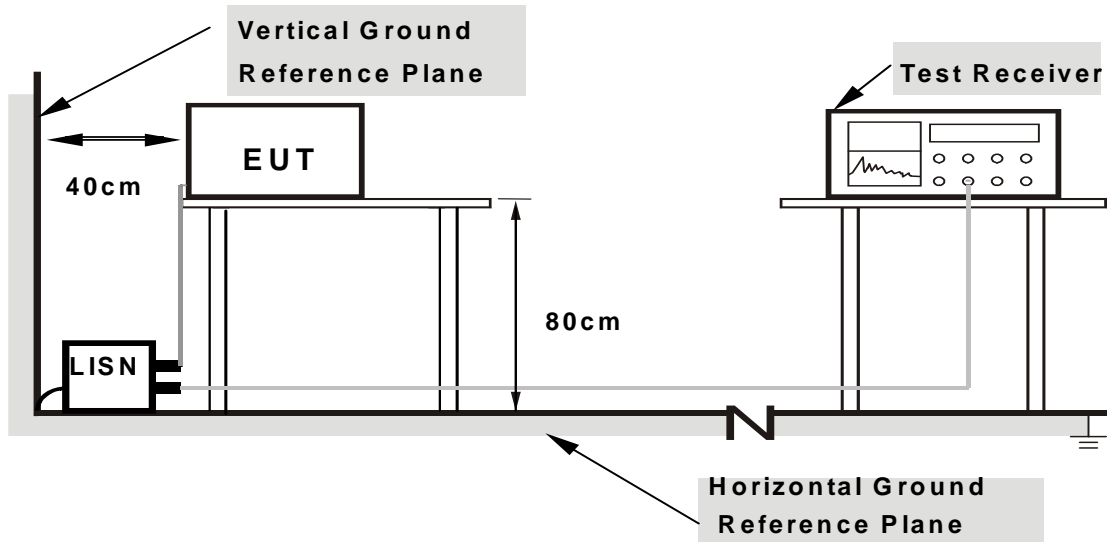

Note: 1.Support units were connected to second LISN.

2.Both of LISNs (AMN) are 80 cm from EUT and at least 80 from other units and other metal planes

For the actual test configuration, please refer to the attached file (Test Setup Photo).

4.1.6 EUT OPERATING CONDITIONS

- a. Turned on the power and connected of all equipment.
- b. EUT was operated according to the type used was description in manufacturer's specifications or the User's Manual.

4.1.7 TEST RESULTS

CONDUCTED WORST-CASE DATA:

PHASE	Line	6dB BANDWIDTH	9kHz
-------	------	---------------	------

No	Freq. [MHz]	Corr. Factor (dB)	Reading Value [dB (uV)]		Emission Level [dB (uV)]		Limit [dB (uV)]		Margin (dB)	
			Q.P.	AV.	Q.P.	AV.	Q.P.	AV.	Q.P.	AV.
1	0.16955	10.59	29.35	15.67	39.94	26.26	64.98	54.98	-25.04	-28.72
2	0.32986	10.4	32.15	21.73	42.55	32.13	59.45	49.45	-16.91	-17.33
3	0.41197	10.35	32.78	23.5	43.13	33.85	57.61	47.61	-14.48	-13.76
4	0.74041	10.16	31.92	19.98	42.08	30.14	56	46	-13.92	-15.86
5	2.22621	10.05	29.1	17.91	39.15	27.96	56	46	-16.85	-18.04
6	3.45395	10.04	23.82	12.1	33.86	22.14	56	46	-22.14	-23.86

- REMARKS:**
1. Q.P. and AV. are abbreviations of quasi-peak and average individually.
 2. "-": The Quasi-peak reading value also meets average limit and measurement with the average detector is unnecessary.
 3. The emission levels of other frequencies were very low against the limit.
 4. Margin value = Emission level - Limit value
 5. Correction factor = Insertion loss + Cable loss
 6. Emission Level = Correction Factor + Reading Value.

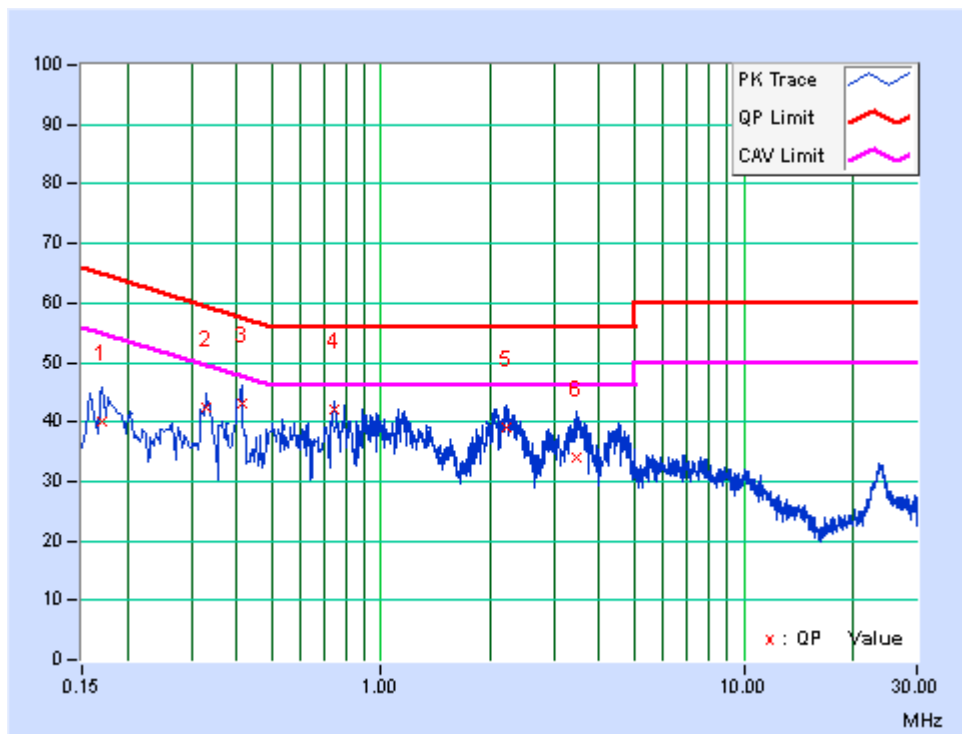

PHASE	Neutral	6dB BANDWIDTH	9kHz
--------------	---------	----------------------	------

No	Freq. [MHz]	Corr. Factor (dB)	Reading Value [dB (uV)]		Emission Level [dB (uV)]		Limit [dB (uV)]		Margin (dB)	
			Q.P.	AV.	Q.P.	AV.	Q.P.	AV.	Q.P.	AV.
1	0.18075	10.51	27.62	15.71	38.13	26.22	64.45	54.45	-26.32	-28.23
2	0.33768	10.41	32.29	20.14	42.7	30.55	59.26	49.26	-16.56	-18.71
3	0.408	10.44	30.9	20.24	41.34	30.68	57.69	47.69	-16.35	-17.01
4	0.71304	9.96	25.16	13.86	35.12	23.82	56	46	-20.88	-22.18
5	2.23403	9.59	22.73	10.86	32.32	20.45	56	46	-23.68	-25.55
6	23.87197	10.45	22.29	8.99	32.74	19.44	60	50	-27.26	-30.56

- REMARKS:**
1. Q.P. and AV. are abbreviations of quasi-peak and average individually.
 2. "-": The Quasi-peak reading value also meets average limit and measurement with the average detector is unnecessary.
 3. The emission levels of other frequencies were very low against the limit.
 4. Margin value = Emission level - Limit value
 5. Correction factor = Insertion loss + Cable loss
 6. Emission Level = Correction Factor + Reading Value.

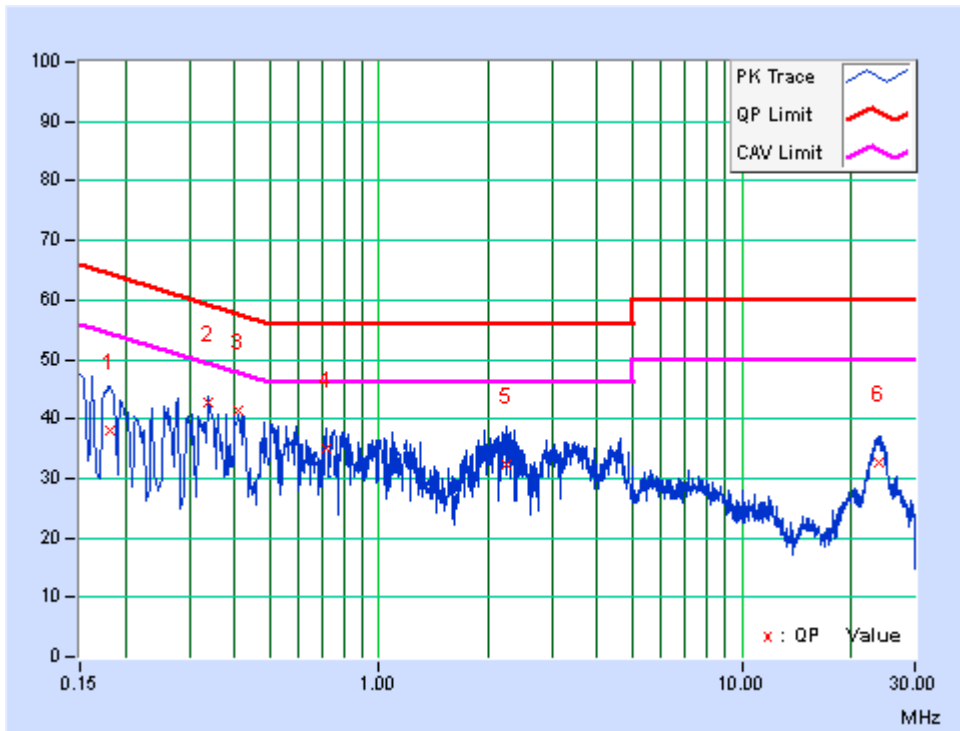

4.2. RADIATED EMISSION AND BANDEDGE MEASUREMENT

4.2.1 LIMITS OF RADIATED EMISSION AND BANDEDGE MEASUREMENT

Radiated emissions which fall in the restricted bands, as defined in Section 15.205(a), must also comply with the radiated emission limits specified in Section 15.209(a). Other emissions shall be at least 20dB below the highest level of the desired power.

FREQUENCIES (MHz)	FIELD STRENGTH (microvolts/meter)	MEASUREMENT DISTANCE (meters)
0.009 ~ 0.490	2400/F(kHz)	300
0.490 ~ 1.705	24000/F(kHz)	30
1.705 ~ 30.0	30	30
30 ~ 88	100	3
88 ~ 216	150	3
216 ~ 960	200	3
Above 960	500	3

NOTE:

1. The lower limit shall apply at the transition frequencies.
2. Emission level (dBuV/m) = 20 log Emission level (uV/m).
3. As shown in 15.35(b), for frequencies above 1000MHz, the field strength limits are based on average detector, however, the peak field strength of any emission shall not exceed the maximum permitted average limits, specified above by more than 20dB under any condition of modulation.

4.2.2 TEST INSTRUMENTS

Equipment	Manufacturer	Model No.	Serial No.	Last Cal.	Next Cal.
Spectrum Analyzer	Agilent	E4446A	MY46180622	May 02,12	May 01,13
EMI Test Receiver	Rohde&Schwarz	ESVD	847398/003	May 15,12	May 14,13
Bilog Antenna (25MHz-2GHz)	Teseq	CBL 6111D	27089	Jul. 16,12	Jul. 15,13
Horn Antenna (1GHz -18GHz)	EMCO	3117	00062558	Oct.18,12	Oct.17,13
Pre-Amplifier (20MHz-3GHz)	EMCI	EMC 330	980095	Nov. 02,12	Nov.01,13
Pre-Amplifier (100MHz-26.5GHz)	Agilent	8449B	3008A00409	May 31,12	May 30,13
10m Semi-anechoic Chamber	CHANGLING	21.4m*12.1m*8 .8m	NSEMC006	Mar. 24,12	Mar. 23,13
Digital Multimeter	FLUKE	15B	A1220010D G	Oct. 31,12	Oct. 30,13
Horn Antenna (15GHz-40GHz)	SCHWARZBECK	BBHA 9170	BBHA91702 42	Jan. 04,11	Jan. 03,14
Pre-Amplifier (18GHz-40GHz)	EMCI	EMC 184045	980102	Nov. 04,12	Nov. 03,13
Bluetooth Tester	Rohde&Schwarz	CBT32	N/A	N/A	N/A
Test Software	ADT	ADT_Radiated V7.6.15	N/A	N/A	N/A

- NOTE:**
1. The calibration interval of the above test instruments is 12 months and the calibrations are traceable to CEPREI/CHINA and NIM/CHINA.
 2. The test was performed in Dongguan Chamber 10m.
 3. The horn antenna are used only for the measurement of emission frequency above 1GHz if tested.

4.2.3 TEST PROCEDURES

- a. The EUT was placed on the top of a rotating table 0.8 meters above the ground at a 3 meter semi-anechoic chamber. The table was rotated 360 degrees to determine the position of the highest radiation.
- b. The EUT was set 3 meters away from the interference-receiving antenna, which was mounted on the top of a variable-height antenna tower.
- c. The antenna is a broadband antenna, and its height is varied from one meter to four meters above the ground to determine the maximum value of the field strength. Both horizontal and vertical polarizations of the antenna are set to make the measurement.
- d. For each suspected emission, the EUT was arranged to its worst case and then the antenna was tuned to heights from 1 meter to 4 meters and the rotatable table was turned from 0 degrees to 360 degrees to find the maximum reading.
- e. The test-receiver system was set to Peak Detect Function and Specified Bandwidth with Maximum Hold Mode.
- f. During the test, each emission was maximized by: having the EUT continuously working, investigated all operating modes, rotated about all 3 axis (X, Y & Z) and considered typical configuration to obtain worst position, manipulating interconnecting cables, For battery operated equipment, the equipment tests shall be perform using fresh batteries. The turntable was rotated to maximize the emission level.

NOTE:

1. The resolution bandwidth and video bandwidth of test receiver/spectrum analyzer is 120kHz for Quasi-peak detection at frequency below 1GHz.
2. The resolution bandwidth of test receiver/spectrum analyzer is 1 MHz and video bandwidth is 3MHz for Peak detection at frequency above 1GHz.
3. All modes of operation were investigated and the worst-case emissions are reported.

4.2.4 DEVIATION FROM TEST STANDARD

No deviation.

4.2.5 TEST SETUP

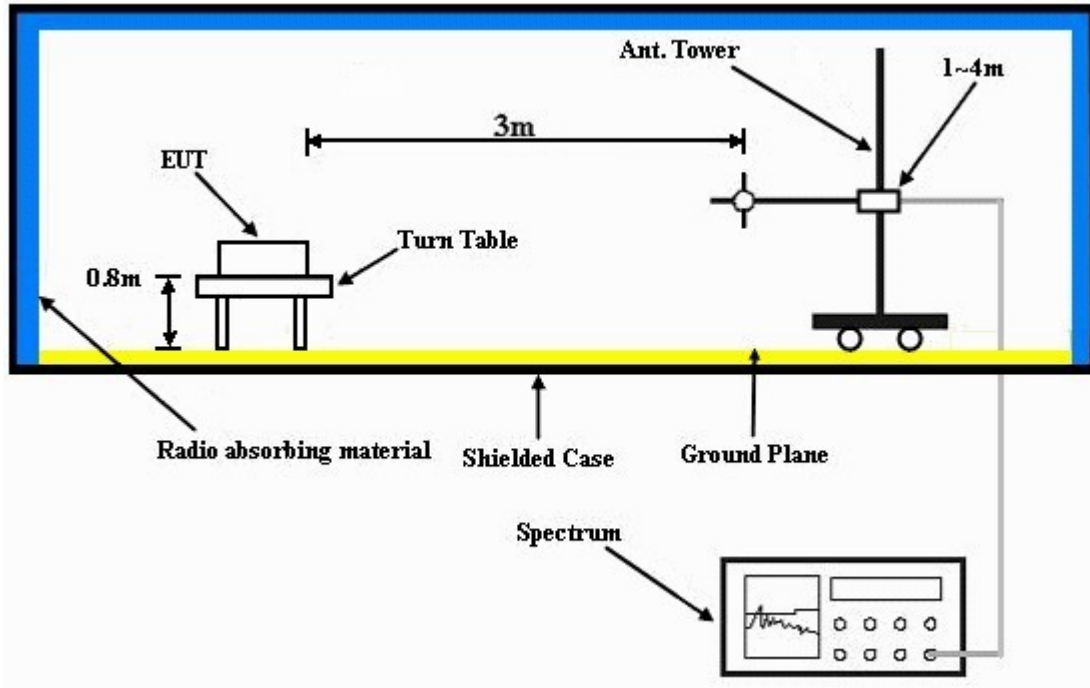

For the actual test configuration, please refer to the attached file (Test Setup Photo).

4.2.6 EUT OPERATING CONDITIONS

- Set the EUT under full load condition and placed them on a testing table.
- Set the transmitter part of EUT under transmission condition continuously at specific channel frequency.
- The necessary accessories enable the EUT in full functions.

4.2.7 TEST RESULTS

BELOW 1GHz WORST-CASE DATA : GFSK

EUT TEST CONDITION		MEASUREMENT DETAIL	
CHANNEL	Channel 0	FREQUENCY RANGE	Below 1000MHz
INPUT POWER (SYSTEM)	120Vac, 60 Hz	DETECTOR FUNCTION	Quasi-Peak
ENVIRONMENTAL CONDITIONS	23deg. C, 56%RH	TESTED BY	Yuqiang Yin

ANTENNA POLARITY & TEST DISTANCE: HORIZONTAL AT 3M								
No.	Freq. (MHz)	Correction Factor (dB/m)	Raw Value (dBuV)	Emission Level (dBuV/m)	Limit (dBuV/m)	Margin (dB)	Antenna Height (cm)	Table Angle (Degree)
1	109.22	12.03	18.1	30.13	43.5	-13.37	160	23
2	152.87	12.07	15.69	27.76	43.5	-15.74	126	62
3	188.43	10.2	19.36	29.56	43.5	-13.94	143	43
4	214.3	10.84	13.73	24.57	43.5	-18.93	107	84
5	249.87	13.87	3.4	17.27	46	-28.73	100	150
6	587.75	22.4	-1.48	20.92	46	-25.08	100	110

- REMARKS:**
1. Emission level (dBuV/m) = Reading (dBuV) + Factor (dB/m).
 2. Factor (dB/m) = Antenna Factor (dB/m) + Cable Factor (dB).
 3. The other emission levels were very low against the limit.
 4. Margin value = Emission level – Limit value.

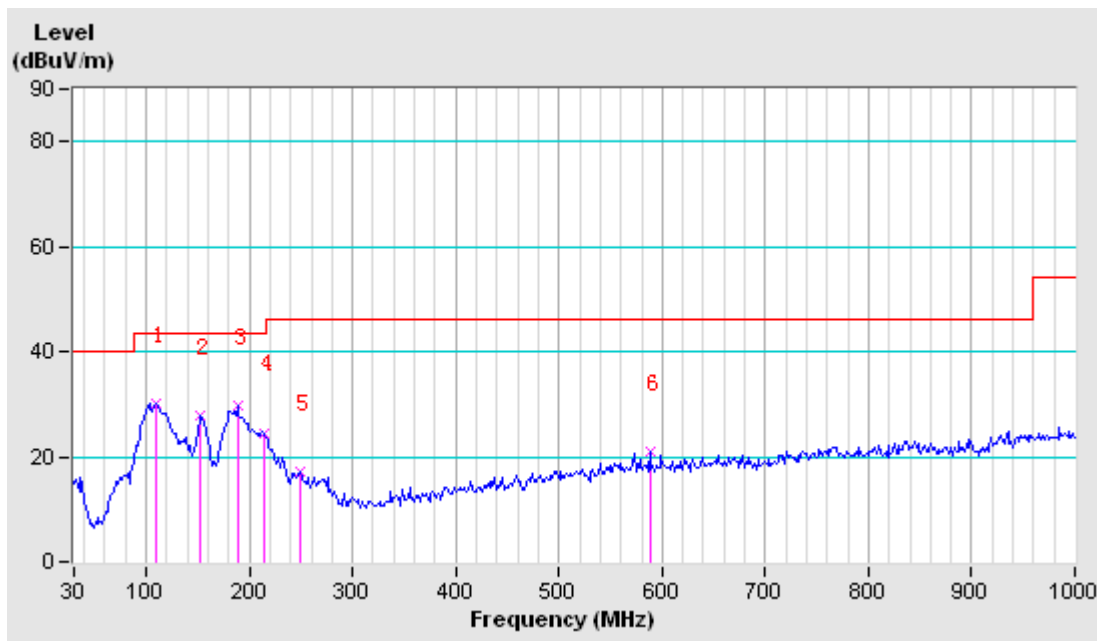

EUT TEST CONDITION		MEASUREMENT DETAIL	
CHANNEL	Channel 39	FREQUENCY RANGE	Below 1000MHz
INPUT POWER (SYSTEM)	120Vac, 60 Hz	DETECTOR FUNCTION	Quasi-Peak
ENVIRONMENTAL CONDITIONS	23deg. C, 56%RH	TESTED BY	Yuqiang Yin

ANTENNA POLARITY & TEST DISTANCE: VERTICAL AT 3M								
No.	Freq. (MHz)	Correction Factor (dB/m)	Raw Value (dBuV)	Emission Level (dBuV/m)	Limit (dBuV/m)	Margin (dB)	Antenna Height (cm)	Table Angle (Degree)
1	36.47	16.24	17.97	34.21	40	-5.79	100	226
2	54.25	9.41	15.67	25.08	40	-14.92	100	198
3	63.95	7.31	16.4	23.71	40	-16.29	164	86
4	101.13	11.28	8.52	19.8	43.5	-23.7	127	128
5	157.72	11.77	10.72	22.49	43.5	-21.01	103	158
6	309.68	15.22	2.58	17.8	46	-28.2	148	105

- REMARKS:**
1. Emission level (dBuV/m) = Reading (dBuV) + Factor (dB/m).
 2. Factor (dB/m) = Antenna Factor (dB/m) + Cable Factor (dB).
 3. The other emission levels were very low against the limit.
 4. Margin value = Emission level – Limit value.

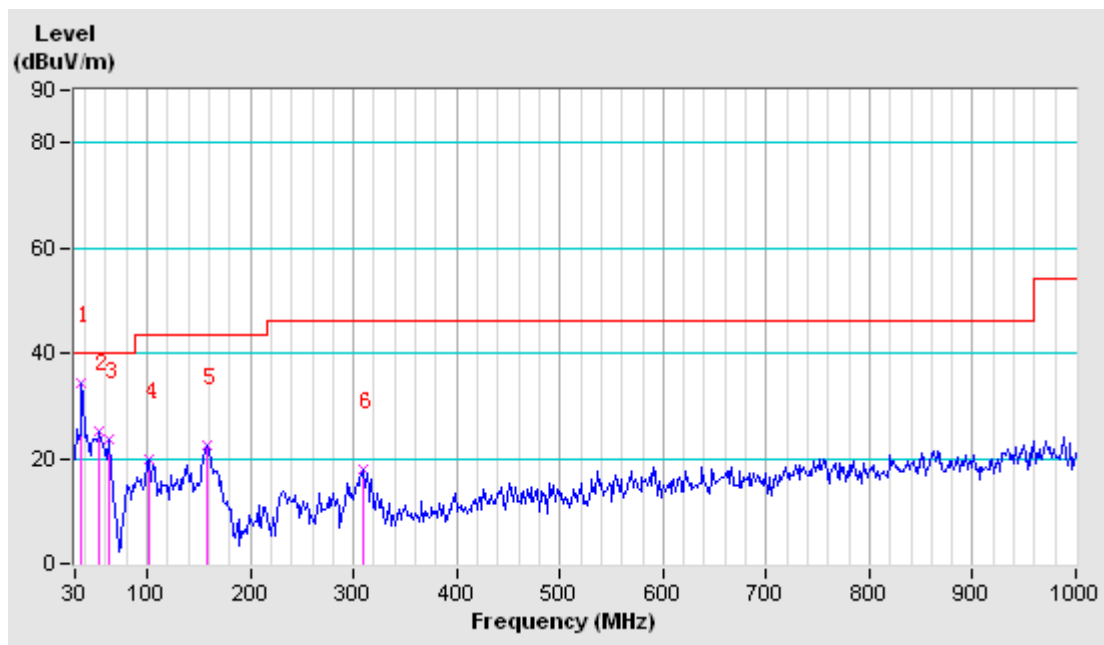

ABOVE 1GHz DATA

GFSK

EUT TEST CONDITION		MEASUREMENT DETAIL	
CHANNEL	Channel 0	FREQUENCY RANGE	1 ~ 25GHz
INPUT POWER (SYSTEM)	120Vac, 60 Hz	DETECTOR FUNCTION	Peak (PK) Average (AV)
ENVIRONMENTAL CONDITIONS	23deg. C, 56%RH	TESTED BY	Venless Long

ANTENNA POLARITY & TEST DISTANCE: HORIZONTAL AT 3 M								
NO.	FREQ. (MHz)	EMISSION LEVEL (dBuV/m)	LIMIT (dBuV/m)	MARGIN (dB)	ANTENNA HEIGHT (m)	TABLE ANGLE (Degree)	RAW VALUE (dBuV)	CORRECTION FACTOR (dB/m)
1	2390.00	48.5 PK	74.0	-25.5	1.19 H	225	12.09	36.41
2	2390.00	18.4 AV	54.0	-35.6	1.19 H	225	-18.01	36.41
3	*2402.00	102.5 PK			1.19 H	225	65.98	36.52
4	*2402.00	72.4 AV			1.19 H	225	35.88	36.52
5	4804.00	58.2 PK	74.0	-15.8	1.00 H	234	8.95	49.25
6	4804.00	28.1 AV	54.0	-25.9	1.00 H	234	-21.15	49.25
ANTENNA POLARITY & TEST DISTANCE: VERTICAL AT 3 M								
NO.	FREQ. (MHz)	EMISSION LEVEL (dBuV/m)	LIMIT (dBuV/m)	MARGIN (dB)	ANTENNA HEIGHT (m)	TABLE ANGLE (Degree)	RAW VALUE (dBuV)	CORRECTION FACTOR (dB/m)
1	2390.00	52.2 PK	74.0	-21.8	1.00 V	183	15.79	36.41
2	2390.00	22.1 AV	54.0	-31.9	1.00 V	183	-14.31	36.41
3	*2402.00	103.4 PK			1.00 V	183	66.88	36.52
4	*2402.00	73.3 AV			1.00 V	183	36.78	36.52
5	4804.00	57.7 PK	74.0	-16.3	1.04 V	317	8.45	49.25
6	4804.00	27.6 AV	54.0	-26.4	1.04 V	317	-21.65	49.25

REMARKS:

1. Emission level (dBuV/m) = Raw Value (dBuV) + Correction Factor (dB/m).
2. Correction Factor (dB/m) = Antenna Factor (dB/m) + Cable Factor (dB).
3. The other emission levels were very low against the limit.
4. Margin value = Emission level – Limit value.
5. " * ": Fundamental frequency.
6. The DH5 packet was the worse case duty cycle for a transmit dwell time on a channel, based upon bluetooth theory the transmitter is on 0.625 * 5 per 296.25 ms per channel. Therefore, the duty cycle correlation factor be equal to: $20\log(3.125 / 100) = -30.1$ dB.
7. Average value = peak reading + $20\log(\text{duty cycle})$.



Test Report No.: RF130201N028

EUT TEST CONDITION		MEASUREMENT DETAIL	
CHANNEL	Channel 39	FREQUENCY RANGE	1 ~ 25GHz
INPUT POWER (SYSTEM)	120Vac, 60 Hz	DETECTOR FUNCTION	Peak (PK) Average (AV)
ENVIRONMENTAL CONDITIONS	25deg. C, 60%RH	TESTED BY	Venless Long

ANTENNA POLARITY & TEST DISTANCE: HORIZONTAL AT 3 M								
NO.	FREQ. (MHz)	EMISSION LEVEL (dBuV/m)	LIMIT (dBuV/m)	MARGIN (dB)	ANTENNA HEIGHT (m)	TABLE ANGLE (Degree)	RAW VALUE (dBuV)	CORRECTION FACTOR (dB/m)
1	*2441.00	100.9 PK			1.18 H	226	64.03	36.87
2	*2441.00	70.8 AV			1.18 H	226	33.93	36.87
3	4882.00	58.3 PK	74.0	-15.7	1.13 H	141	9.07	49.23
4	4882.00	28.2 AV	54.0	-25.8	1.13 H	141	-21.03	49.23
5	7323.00	55.8 PK	74.0	-18.2	1.00 H	118	9.19	46.61
6	7323.00	25.7 AV	54.0	-28.3	1.00 H	118	-20.91	46.61
ANTENNA POLARITY & TEST DISTANCE: VERTICAL AT 3 M								
NO.	FREQ. (MHz)	EMISSION LEVEL (dBuV/m)	LIMIT (dBuV/m)	MARGIN (dB)	ANTENNA HEIGHT (m)	TABLE ANGLE (Degree)	RAW VALUE (dBuV)	CORRECTION FACTOR (dB/m)
1	*2441.00	102.9 PK			1.00 V	179	66.03	36.87
2	*2441.00	72.8 AV			1.00 V	179	35.93	36.87
3	4882.00	58.4 PK	74.0	-15.6	1.00 V	320	9.17	49.23
4	4882.00	28.3 AV	54.0	-25.7	1.00 V	320	-20.93	49.23
5	7323.00	55.6 PK	74.0	-18.4	1.02 V	274	8.99	46.61
6	7323.00	25.5 AV	54.0	-28.5	1.02 V	274	-21.11	46.61

REMARKS:

1. Emission level (dBuV/m) = Raw Value (dBuV) + Correction Factor (dB/m).
2. Correction Factor (dB/m) = Antenna Factor (dB/m) + Cable Factor (dB).
3. The other emission levels were very low against the limit.
4. Margin value = Emission level – Limit value.
5. " * ": Fundamental frequency.
6. The DH5 packet was the worse case duty cycle for a transmit dwell time on a channel, based upon bluetooth theory the transmitter is on 0.625 * 5 per 296.25 ms per channel. Therefore, the duty cycle correlation factor be equal to: $20\log(3.125 / 100) = -30.1$ dB.
7. Average value = peak reading + $20\log(\text{duty cycle})$.

EUT TEST CONDITION		MEASUREMENT DETAIL	
CHANNEL	Channel 78	FREQUENCY RANGE	1 ~ 25GHz
INPUT POWER (SYSTEM)	120Vac, 60 Hz	DETECTOR FUNCTION	Peak (PK) Average (AV)
ENVIRONMENTAL CONDITIONS	25deg. C, 60%RH	TESTED BY	Venless Long

ANTENNA POLARITY & TEST DISTANCE: HORIZONTAL AT 3 M								
NO.	FREQ. (MHz)	EMISSION LEVEL (dBuV/m)	LIMIT (dBuV/m)	MARGIN (dB)	ANTENNA HEIGHT (m)	TABLE ANGLE (Degree)	RAW VALUE (dBuV)	CORRECTION FACTOR (dB/m)
1	*2480.00	100.2 PK			1.20 H	223	62.99	37.21
2	*2480.00	70.1 AV			1.20 H	223	32.89	37.21
3	2483.50	54.9 PK	74.0	-19.1	1.20 H	223	17.66	37.24
4	2483.50	24.8 AV	54.0	-29.2	1.20 H	223	-12.44	37.24
5	4960.00	57.9 PK	74.0	-16.1	1.05 H	152	8.69	49.21
6	4960.00	27.8 AV	54.0	-26.2	1.05 H	152	-21.41	49.21
7	7440.00	55.4 PK	74.0	-18.6	1.00 H	120	8.70	46.70
8	7440.00	25.3 AV	54.0	-28.7	1.00 H	120	-21.40	46.70
ANTENNA POLARITY & TEST DISTANCE: VERTICAL AT 3 M								
NO.	FREQ. (MHz)	EMISSION LEVEL (dBuV/m)	LIMIT (dBuV/m)	MARGIN (dB)	ANTENNA HEIGHT (m)	TABLE ANGLE (Degree)	RAW VALUE (dBuV)	CORRECTION FACTOR (dB/m)
1	*2480.00	103.1 PK			1.00 V	183	65.89	37.21
2	*2480.00	73.0 AV			1.00 V	183	35.79	37.21
3	2483.50	57.2 PK	74.0	-16.8	1.00 V	183	19.96	37.24
4	2483.50	27.1 AV	54.0	-26.9	1.00 V	183	-10.14	37.24
5	4960.00	59.6 PK	74.0	-14.4	1.15 V	315	10.39	49.21
6	4960.00	29.5 AV	54.0	-24.5	1.15 V	315	-19.71	49.21
7	7440.00	54.3 PK	74.0	-19.7	1.00 V	283	7.60	46.70
8	7440.00	24.2 AV	54.0	-29.8	1.00 V	283	-22.50	46.70

REMARKS:

- Emission level (dBuV/m) = Raw Value (dBuV) + Correction Factor (dB/m).
- Correction Factor (dB/m) = Antenna Factor (dB/m) + Cable Factor (dB).
- The other emission levels were very low against the limit.
- Margin value = Emission level – Limit value.
- " * ": Fundamental frequency.
- The DH5 packet was the worse case duty cycle for a transmit dwell time on a channel, based upon bluetooth theory the transmitter is on 0.625 * 5 per 296.25 ms per channel. Therefore, the duty cycle correlation factor be equal to: $20\log(3.125 / 100) = -30.1$ dB.
- Average value = peak reading + $20\log(\text{duty cycle})$.

8DPSK

EUT TEST CONDITION		MEASUREMENT DETAIL	
CHANNEL	Channel 0	FREQUENCY RANGE	1 ~ 25GHz
INPUT POWER (SYSTEM)	120Vac, 60 Hz	DETECTOR FUNCTION	Peak (PK) Average (AV)
ENVIRONMENTAL CONDITIONS	25deg. C, 60%RH	TESTED BY	Venless Long

ANTENNA POLARITY & TEST DISTANCE: HORIZONTAL AT 3 M								
NO.	FREQ. (MHz)	EMISSION LEVEL (dBuV/m)	LIMIT (dBuV/m)	MARGIN (dB)	ANTENNA HEIGHT (m)	TABLE ANGLE (Degree)	RAW VALUE (dBuV)	CORRECTION FACTOR (dB/m)
1	2390.00	49.6 PK	74.0	-24.4	1.20 H	228	13.19	36.41
2	2390.00	19.5 AV	54.0	-34.5	1.20 H	228	-16.91	36.41
3	*2402.00	101.2 PK			1.20 H	228	64.68	36.52
4	*2402.00	71.1 AV			1.20 H	228	34.58	36.52
5	4804.00	58.8 PK	74.0	-15.2	1.08 H	146	9.55	49.25
6	4804.00	28.7 AV	54.0	-25.3	1.08 H	146	-20.55	49.25
ANTENNA POLARITY & TEST DISTANCE: VERTICAL AT 3 M								
NO.	FREQ. (MHz)	EMISSION LEVEL (dBuV/m)	LIMIT (dBuV/m)	MARGIN (dB)	ANTENNA HEIGHT (m)	TABLE ANGLE (Degree)	RAW VALUE (dBuV)	CORRECTION FACTOR (dB/m)
1	2390.00	48.7 PK	74.0	-25.3	1.00 V	184	12.29	36.41
2	2390.00	18.6 AV	54.0	-35.4	1.00 V	184	-17.81	36.41
3	*2402.00	101.9 PK			1.00 V	184	65.38	36.52
4	*2402.00	71.8 AV			1.00 V	184	35.28	36.52
5	4804.00	59.2 PK	74.0	-14.8	1.00 V	318	9.95	49.25
6	4804.00	29.1 AV	54.0	-24.9	1.00 V	318	-20.15	49.25

REMARKS:

1. Emission level (dBuV/m) = Raw Value (dBuV) + Correction Factor (dB/m).
2. Correction Factor (dB/m) = Antenna Factor (dB/m) + Cable Factor (dB).
3. The other emission levels were very low against the limit.
4. Margin value = Emission level – Limit value.
5. " * ": Fundamental frequency.
6. The DH5 packet was the worse case duty cycle for a transmit dwell time on a channel, based upon bluetooth theory the transmitter is on 0.625 * 5 per 296.25 ms per channel. Therefore, the duty cycle correlation factor be equal to: $20\log(3.125 / 100) = -30.1$ dB.
7. Average value = peak reading + $20\log(\text{duty cycle})$.

EUT TEST CONDITION		MEASUREMENT DETAIL	
CHANNEL	Channel 39	FREQUENCY RANGE	1 ~ 25GHz
INPUT POWER (SYSTEM)	120Vac, 60 Hz	DETECTOR FUNCTION	Peak (PK) Average (AV)
ENVIRONMENTAL CONDITIONS	25deg. C, 60%RH	TESTED BY	Venless Long

ANTENNA POLARITY & TEST DISTANCE: HORIZONTAL AT 3 M								
NO.	FREQ. (MHz)	EMISSION LEVEL (dBuV/m)	LIMIT (dBuV/m)	MARGIN (dB)	ANTENNA HEIGHT (m)	TABLE ANGLE (Degree)	RAW VALUE (dBuV)	CORRECTION FACTOR (dB/m)
1	*2441.00	99.5 PK			1.19 H	226	62.63	36.87
2	*2441.00	69.4 AV			1.19 H	226	32.53	36.87
3	4882.00	58.4 PK	74.0	-15.6	1.00 H	139	9.17	49.23
4	4882.00	28.3 AV	54.0	-25.7	1.00 H	139	-20.93	49.23
5	7323.00	57.3 PK	74.0	-16.7	1.13 H	123	10.69	46.61
6	7323.00	27.2 AV	54.0	-26.8	1.13 H	123	-19.41	46.61
ANTENNA POLARITY & TEST DISTANCE: VERTICAL AT 3 M								
NO.	FREQ. (MHz)	EMISSION LEVEL (dBuV/m)	LIMIT (dBuV/m)	MARGIN (dB)	ANTENNA HEIGHT (m)	TABLE ANGLE (Degree)	RAW VALUE (dBuV)	CORRECTION FACTOR (dB/m)
1	*2441.00	101.7 PK			1.00 V	180	64.83	36.87
2	*2441.00	71.6 AV			1.00 V	180	34.73	36.87
3	4882.00	58.7 PK	74.0	-15.3	1.03 V	314	9.47	49.23
4	4882.00	28.6 AV	54.0	-25.4	1.03 V	314	-20.63	49.23
5	7323.00	56.5 PK	74.0	-17.5	1.00 V	281	9.89	46.61
6	7323.00	26.4 AV	54.0	-27.6	1.00 V	281	-20.21	46.61

REMARKS:

1. Emission level (dBuV/m) = Raw Value (dBuV) + Correction Factor (dB/m).
2. Correction Factor (dB/m) = Antenna Factor (dB/m) + Cable Factor (dB).
3. The other emission levels were very low against the limit.
4. Margin value = Emission level – Limit value.
5. " * ": Fundamental frequency.
6. The DH5 packet was the worse case duty cycle for a transmit dwell time on a channel, based upon bluetooth theory the transmitter is on 0.625 * 5 per 296.25 ms per channel. Therefore, the duty cycle correlation factor be equal to: $20\log(3.125 / 100) = -30.1$ dB.
7. Average value = peak reading + $20\log(\text{duty cycle})$.

EUT TEST CONDITION		MEASUREMENT DETAIL	
CHANNEL	Channel 78	FREQUENCY RANGE	1 ~ 25GHz
INPUT POWER (SYSTEM)	120Vac, 60 Hz	DETECTOR FUNCTION	Peak (PK) Average (AV)
ENVIRONMENTAL CONDITIONS	25deg. C, 60%RH	TESTED BY	Venless Long

ANTENNA POLARITY & TEST DISTANCE: HORIZONTAL AT 3 M								
NO.	FREQ. (MHz)	EMISSION LEVEL (dBuV/m)	LIMIT (dBuV/m)	MARGIN (dB)	ANTENNA HEIGHT (m)	TABLE ANGLE (Degree)	RAW VALUE (dBuV)	CORRECTION FACTOR (dB/m)
1	*2480.00	100.2 PK			1.17 H	224	62.99	37.21
2	*2480.00	70.1 AV			1.17 H	224	32.89	37.21
3	2483.50	53.6 PK	74.0	-20.4	1.17 H	224	16.36	37.24
4	2483.50	23.5 AV	54.0	-30.5	1.17 H	224	-13.74	37.24
5	4960.00	58.4 PK	74.0	-15.6	1.12 H	145	9.19	49.21
6	4960.00	28.3 AV	54.0	-25.7	1.12 H	145	-20.91	49.21
7	7440.00	56.8 PK	74.0	-17.2	1.00 H	124	10.10	46.70
8	7440.00	26.7 AV	54.0	-27.3	1.00 H	124	-20.00	46.70
ANTENNA POLARITY & TEST DISTANCE: VERTICAL AT 3 M								
NO.	FREQ. (MHz)	EMISSION LEVEL (dBuV/m)	LIMIT (dBuV/m)	MARGIN (dB)	ANTENNA HEIGHT (m)	TABLE ANGLE (Degree)	RAW VALUE (dBuV)	CORRECTION FACTOR (dB/m)
1	*2480.00	102.4 PK			1.00 V	186	65.19	37.21
2	*2480.00	72.3 AV			1.00 V	186	35.09	37.21
3	2483.50	55.3 PK	74.0	-18.7	1.00 V	186	18.06	37.24
4	2483.50	25.2 AV	54.0	-28.8	1.00 V	186	-12.04	37.24
5	4960.00	58.7 PK	74.0	-15.3	1.04 V	315	9.49	49.21
6	4960.00	28.6 AV	54.0	-25.4	1.04 V	315	-20.61	49.21
7	7440.00	56.5 PK	74.0	-17.5	1.10 V	280	9.80	46.70
8	7440.00	26.4 AV	54.0	-27.6	1.10 V	280	-20.30	46.70

REMARKS:

1. Emission level (dBuV/m) = Raw Value (dBuV) + Correction Factor (dB/m).
2. Correction Factor (dB/m) = Antenna Factor (dB/m) + Cable Factor (dB).
3. The other emission levels were very low against the limit.
4. Margin value = Emission level – Limit value.
5. " * ": Fundamental frequency.
6. The DH5 packet was the worse case duty cycle for a transmit dwell time on a channel, based upon bluetooth theory the transmitter is on 0.625 * 5 per 296.25 ms per channel. Therefore, the duty cycle correlation factor be equal to: $20\log(3.125 / 100) = -30.1$ dB.
7. Average value = peak reading + $20\log(\text{duty cycle})$.

4.3. NUMBER OF HOPPING FREQUENCY USED

4.3.1. LIMIT OF HOPPING FREQUENCY USED

At least 15 channels frequencies, and should be equally spaced.

4.3.2. TEST SETUP

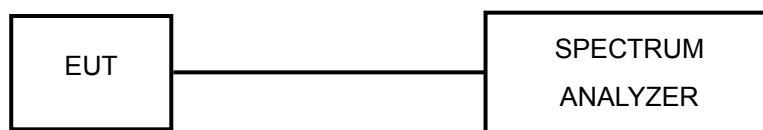

4.3.3. TEST INSTRUMENTS

Refer to section 4.1.2 to get information of above instrument.

4.3.4. TEST PROCEDURES

- a. Check the calibration of the measuring instrument (SA) using either an internal calibrator or a known signal from an external generator.
- b. Turn on the EUT and connect its antenna terminal to measurement via a low loss cable. Then set it to any one measured frequency within its operating range and make sure the instrument is operated in its linear range.
- c. Set the SA on MaxHold Mode, and then keep the EUT in hopping mode. Record all the signals from each channel until each one has been recorded.
- d. Set the SA on View mode and then plot the result on SA screen.
- e. Repeat above procedures until all frequencies measured were complete.



Test Report No.: RF130201N028

4.3.5. DEVIATION FROM TEST STANDARD

No deviation.

4.3.6. TEST RESULTS

There are 79 hopping frequencies in the hopping mode. Please refer to next two pages for the test result. On the plots, it shows that the hopping frequencies are equally spaced.



Test Report No.: RF130201N028

GFSK

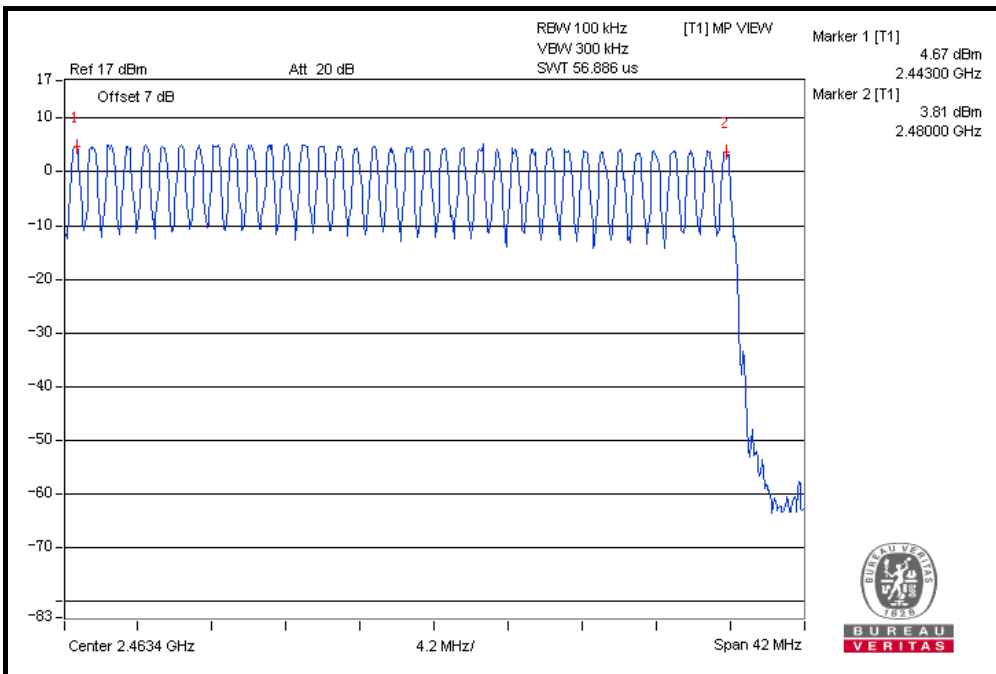
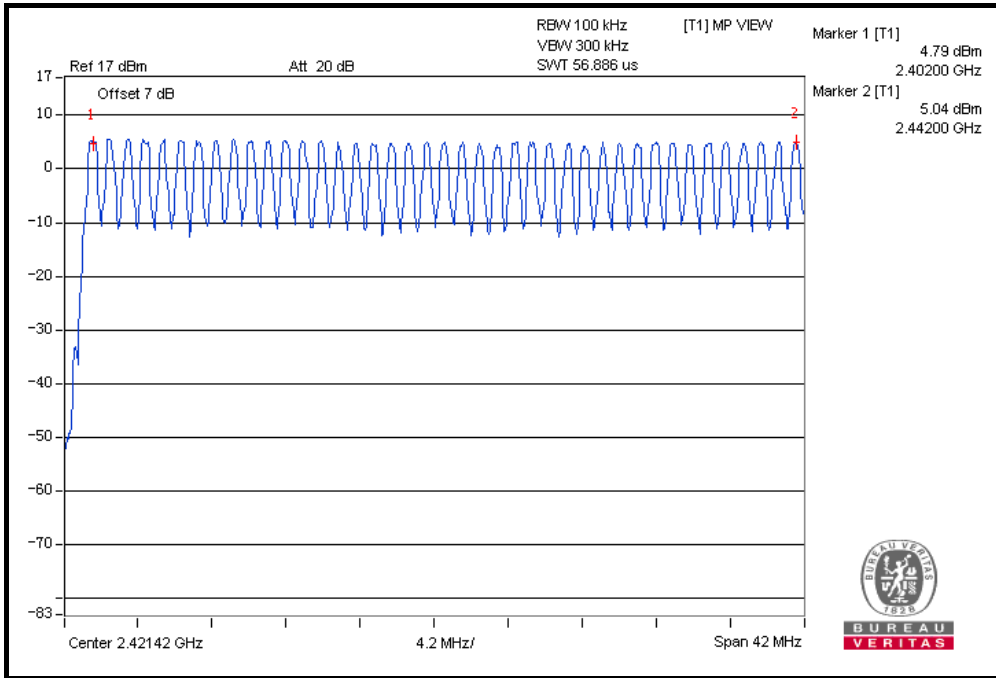



Test Report No.: RF130201N028

8DPSK

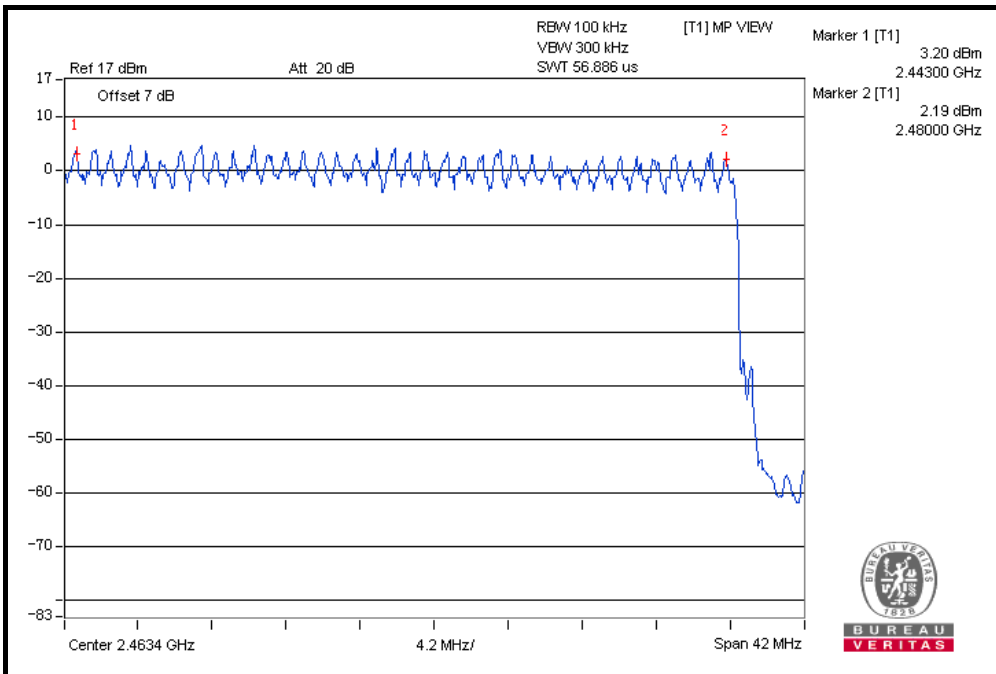
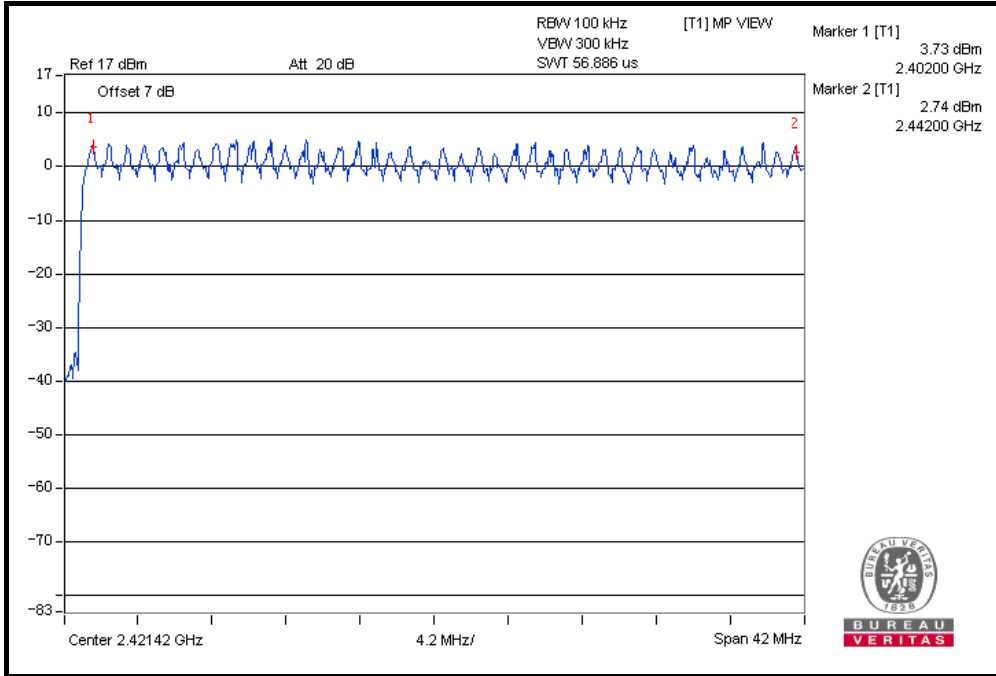

Bureau Veritas Shenzhen Co., Ltd.
Dongguan Branch

No. 34, Chenwulu Section, Guantai Rd., Houjie
Town, Dongguan City,
Guangdong 523942, China

Tel: +86 769 8593 5656
Fax: +86 769 8593 1080
Email: customerservice.de@cn.bureauveritas.com

4.4. DWELL TIME ON EACH CHANNEL

4.4.1 LIMIT OF DWELL TIME USED

The average time of occupancy on any channel shall not be greater than 0.4 seconds within a period of 0.4 seconds multiplied by the number of hopping channels employed.

4.4.2 TEST SETUP

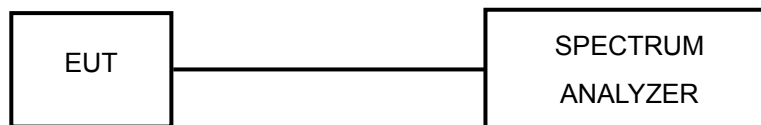

4.4.3 TEST INSTRUMENTS

Refer to section 4.1.2 to get information of above instrument.

4.4.4 TEST PROCEDURES

- a. Check the calibration of the measuring instrument (SA) using either an internal calibrator or a known signal from an external generator.
- b. Turn on the EUT and connect its antenna terminal to measurement via a low loss cable. Then set it to any one measured frequency within its operating range and make sure the instrument is operated in its linear range.
- c. Adjust the center frequency of SA on any frequency be measured and set SA to zero span mode. And then, set RBW and VBW of spectrum analyzer to proper value.
- d. Measure the time duration of one transmission on the measured frequency. And then plot the result with time difference of this time duration.
- e. Repeat above procedures until all different time-slot modes have been completed.



Test Report No.: RF130201N028

4.4.5 DEVIATION FROM TEST STANDARD

No deviation.

4.4.6 TEST RESULTS

GFSK

Mode	Number of Hopping Channel	Number of transmission in a period(channel number*0.4 sec)				Length of transmission time (msec)	Result (msec)	Limit (msec)	PASS / FAIL
		period (sec)	sweep time (sec)	times in a sweep	times in a period				
DH1	79	31.6	5	50	316	0.426	134.62	400	PASS
DH3	79	31.6	5	27	170.64	1.681	286.85	400	PASS
DH5	79	31.6	5	17	107.44	2.949	316.84	400	PASS

NOTE: Test plots of the transmitting time slot are shown on next 3 pages.

DH1

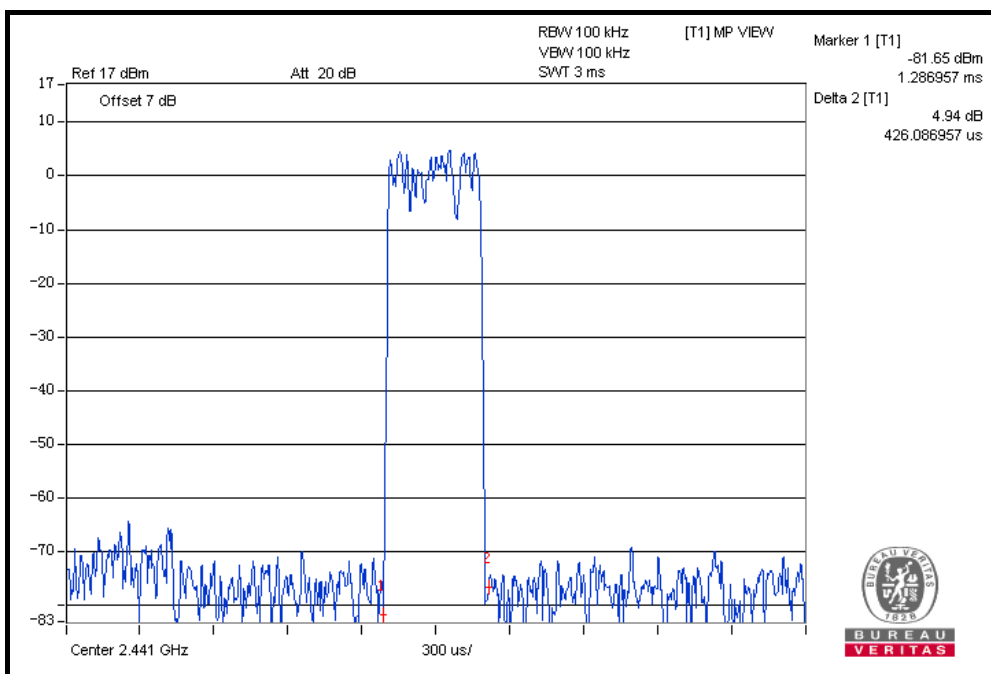
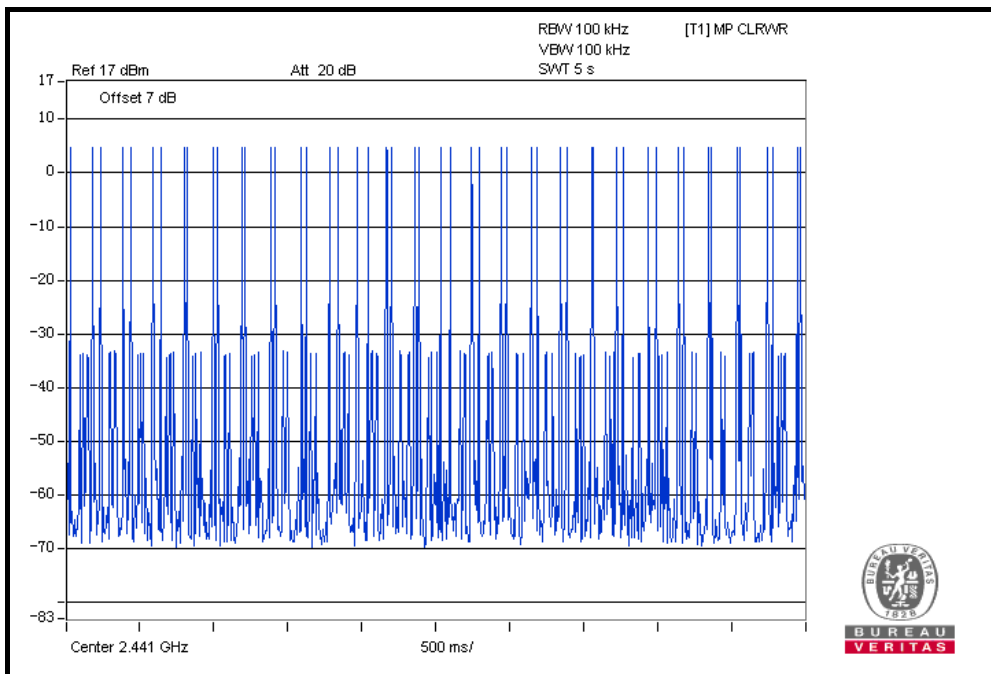

DH3

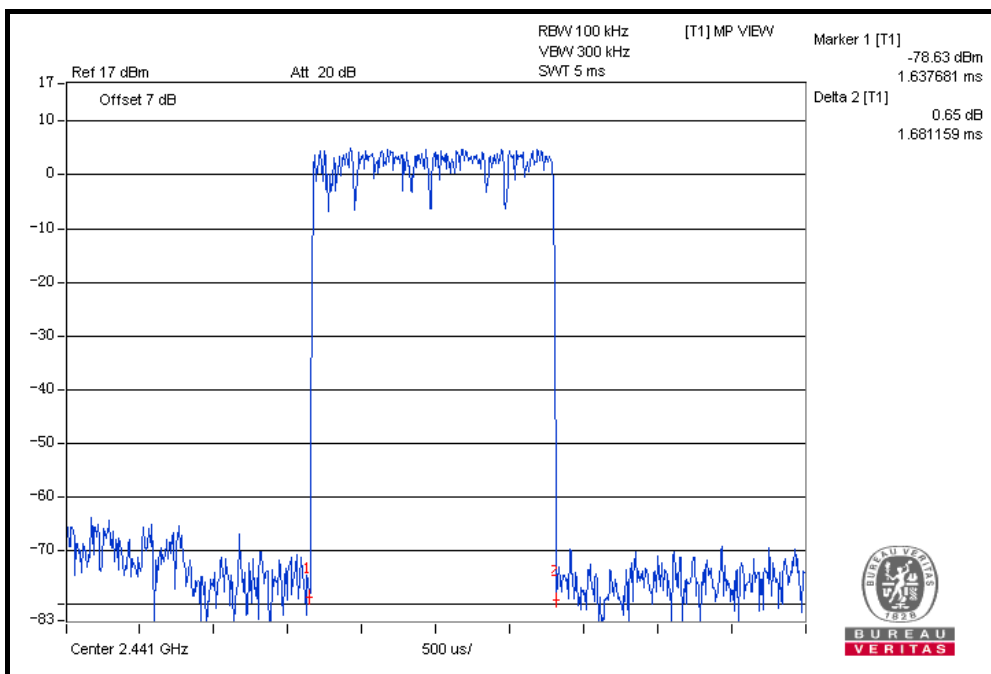
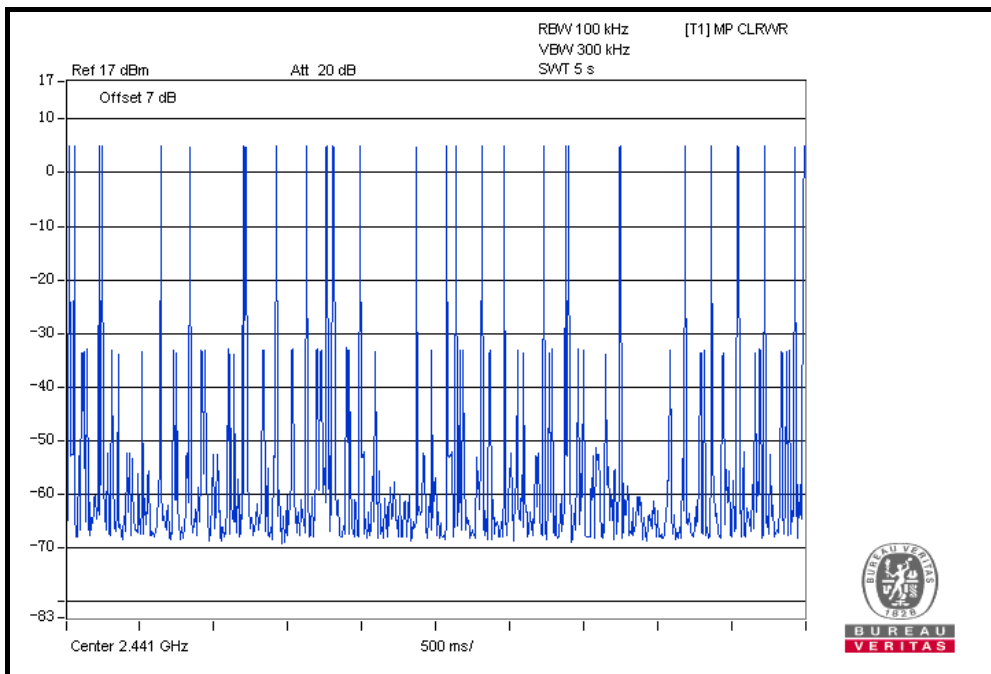

DH5

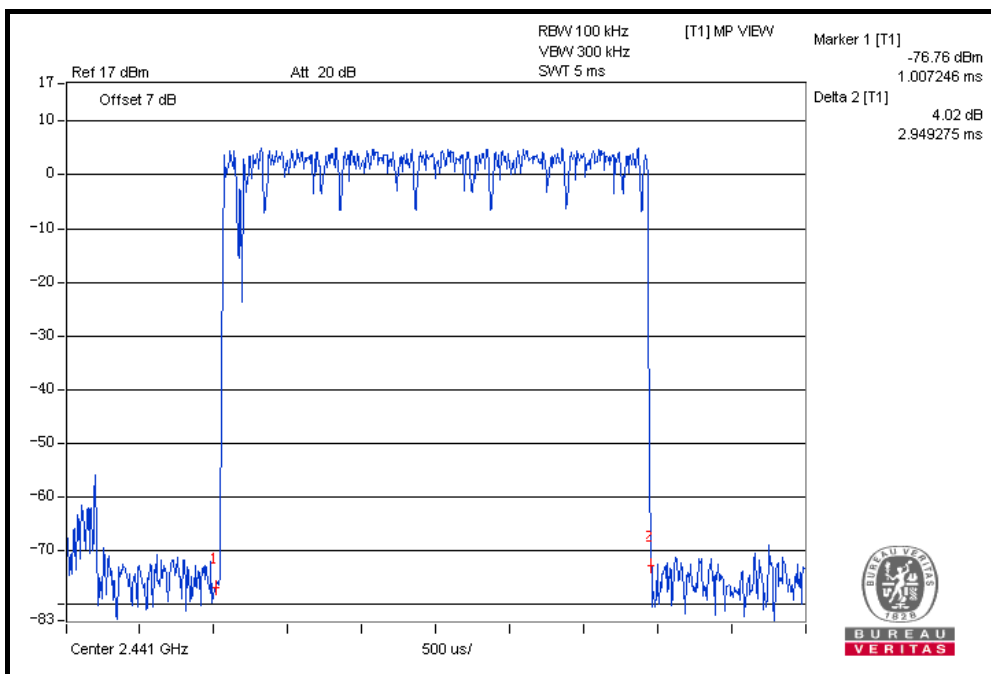
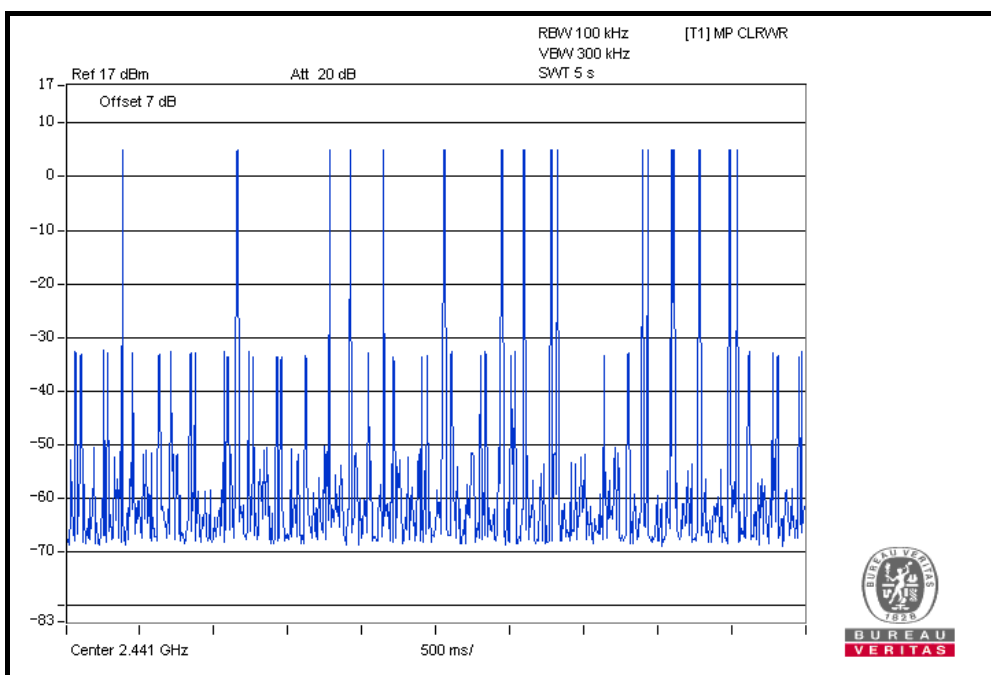

8DPSK

Mode	Number of Hopping Channel	Number of transmission in a period(channel number*0.4 sec)				Length of transmission time (msec)	Result (msec)	Limit (msec)	PASS / FAIL
		period (sec)	sweep time (sec)	times in a sweep	times in a period				
DH1	79	31.6	5	50	316	0.452	142.83	400	PASS
DH3	79	31.6	5	27	170.64	1.696	289.41	400	PASS
DH5	79	31.6	5	18	113.76	2.978	338.78	400	PASS

NOTE: Test plots of the transmitting time slot are shown on next 3 pages.



Test Report No.: RF130201N028

DH1

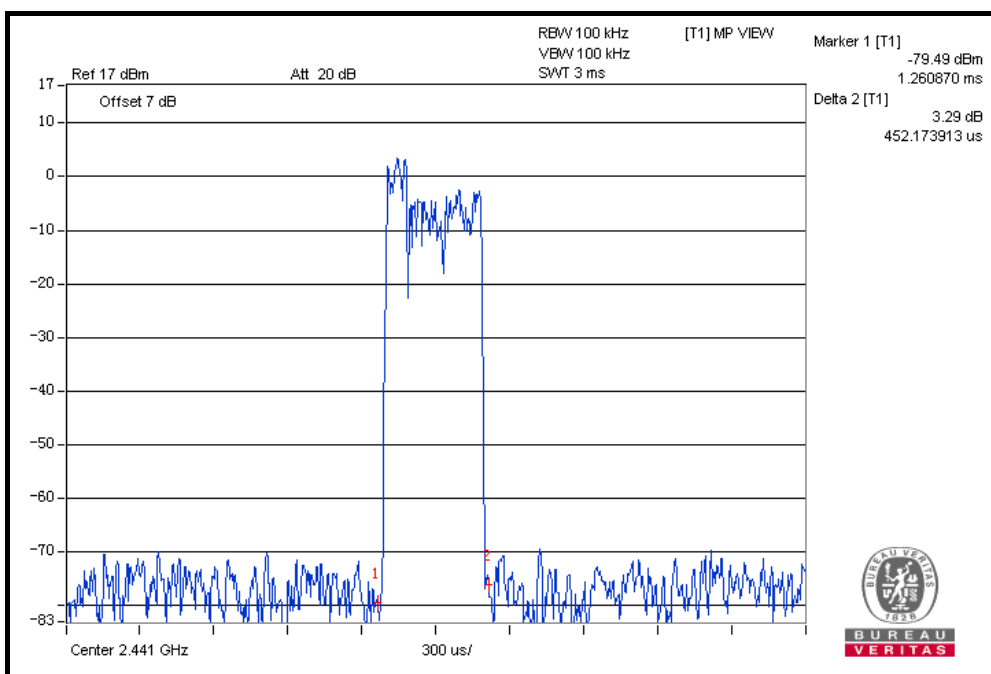
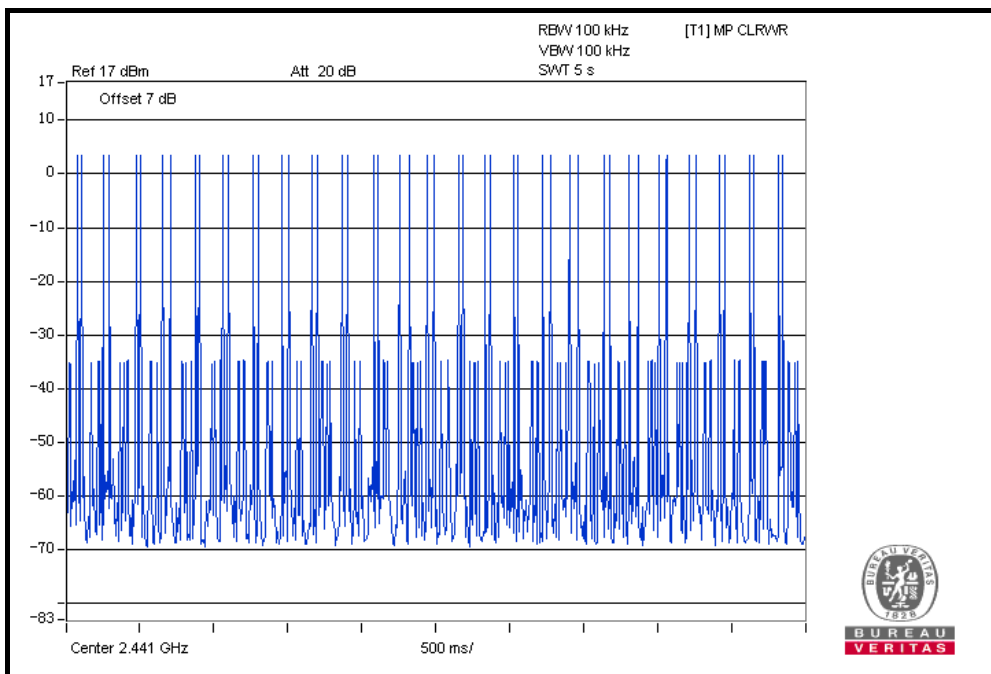

DH3

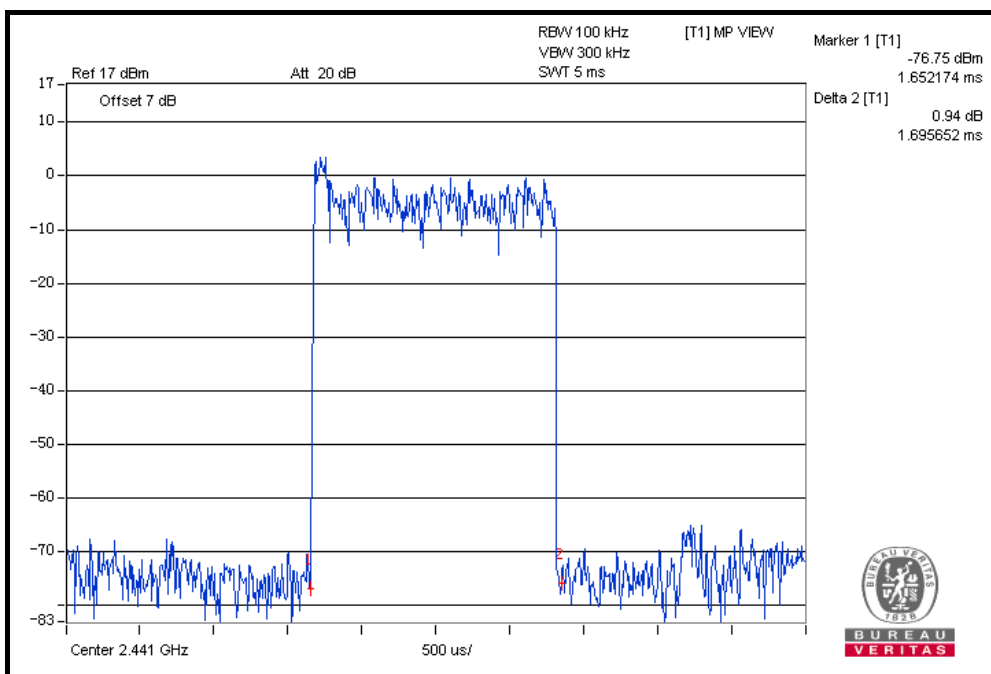
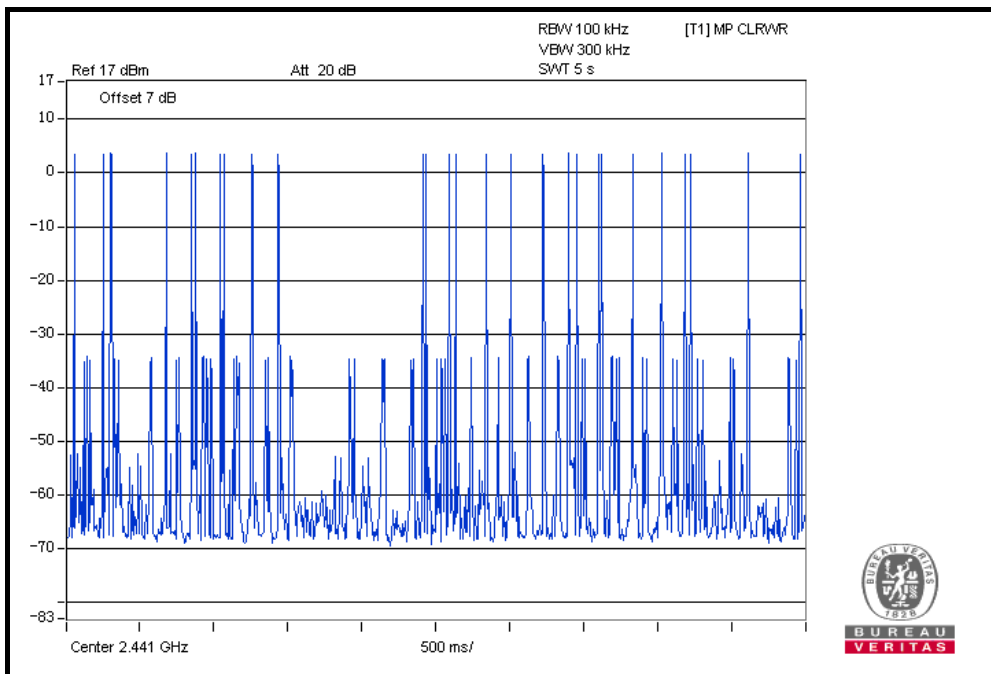



Test Report No.: RF130201N028

DH5

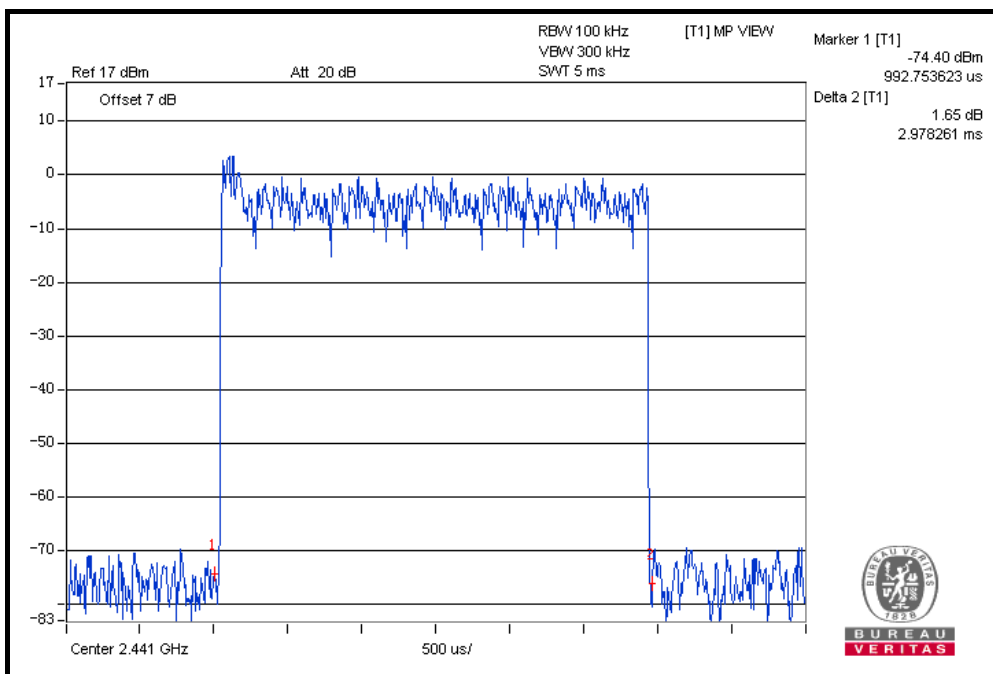
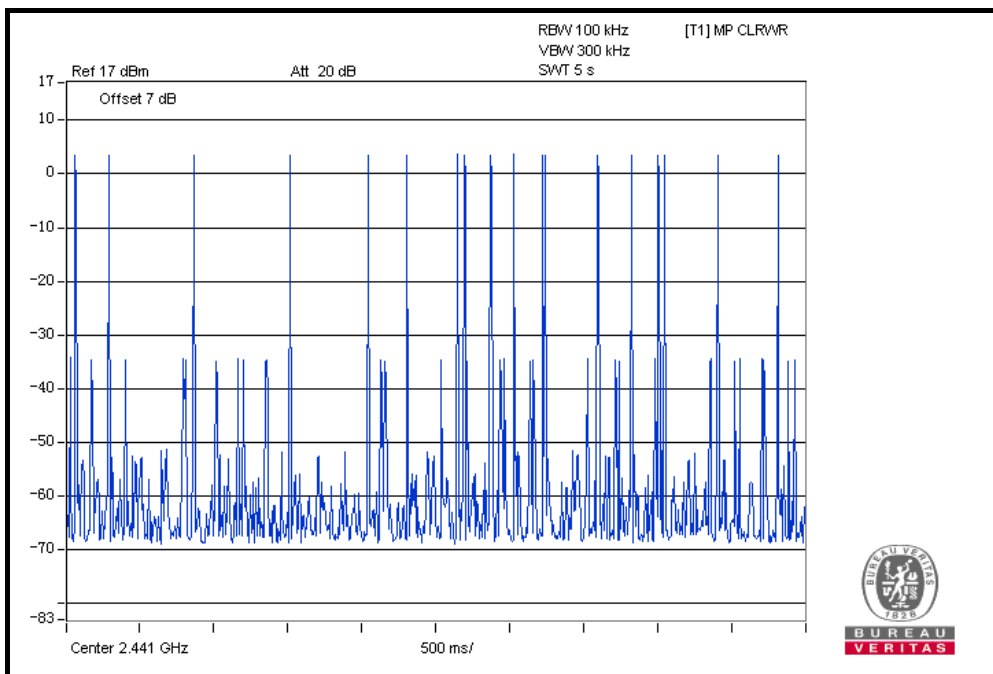

4.5. CHANNEL BANDWIDTH

4.5.1 LIMITS OF CHANNEL BANDWIDTH

For frequency hopping system operating in the 2400-2483.5MHz, If the 20dB bandwidth of hopping channel is greater than 25kHz, two-thirds 20dB bandwidth of hopping channel shall be a minimum limit for the hopping channel separation.

4.5.2 TEST SETUP

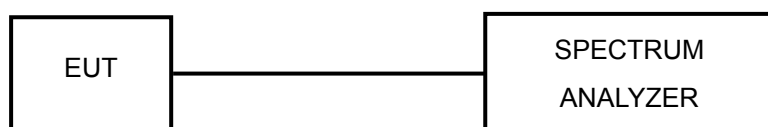

4.5.3 TEST INSTRUMENTS

Refer to section 4.1.2 to get information of above instrument.

4.5.4 TEST PROCEDURE

- a. Check the calibration of the measuring instrument using either an internal calibrator or a known signal from an external generator.
- b. Turn on the EUT and connect it to measurement instrument. Then set it to any one convenient frequency within its operating range. Set a reference level on the measuring instrument equal to the highest peak value.
- c. Measure the frequency difference of two frequencies that were attenuated 20dB from the reference level. Record the frequency difference as the emission bandwidth.
- d. Repeat above procedures until all frequencies measured were complete.

4.5.5 DEVIATION FROM TEST STANDARD

No deviation.

4.5.6 EUT OPERATING CONDITION

Same as item 4.2.6

4.5.7 TEST RESULTS

GFSK

CHANNEL	CHANNEL FREQUENCY (MHz)	20dB BANDWIDTH (MHz)
0	2402	0.96
39	2441	0.96
78	2480	0.96

CH 0

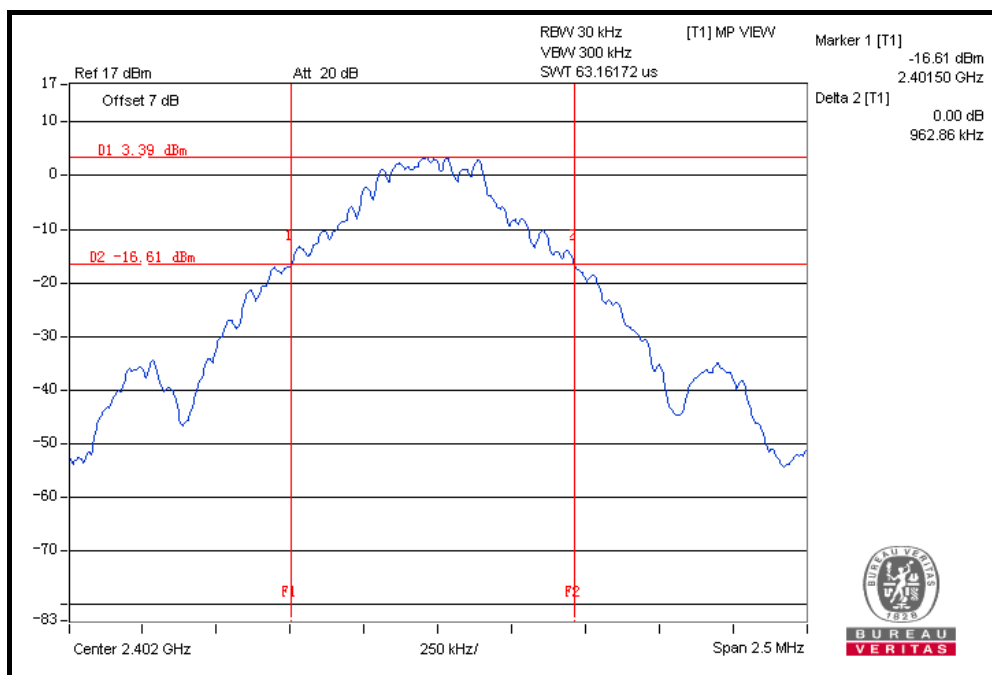

CH 39

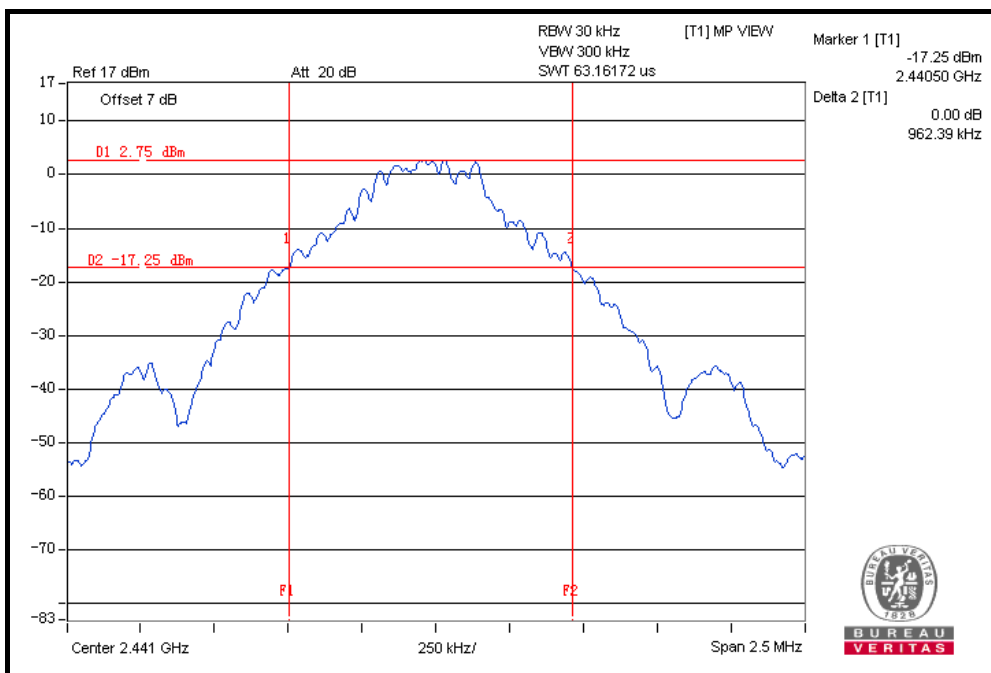

CH 78

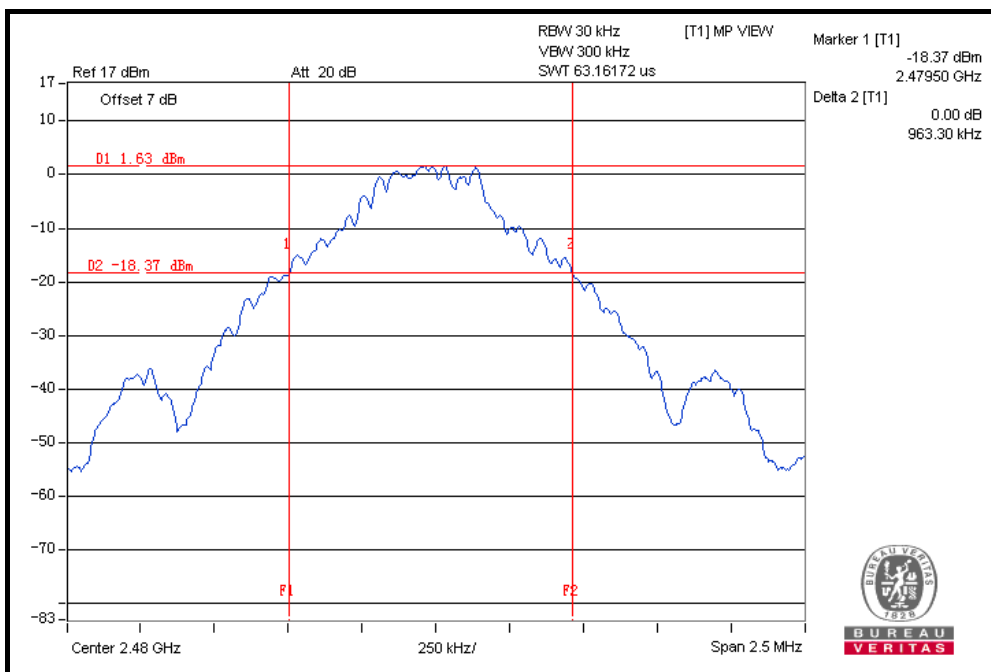

8DPSK

CHANNEL	CHANNEL FREQUENCY (MHz)	20dB BANDWIDTH (MHz)
0	2402	1.25
39	2441	1.28
78	2480	1.28

CH 00

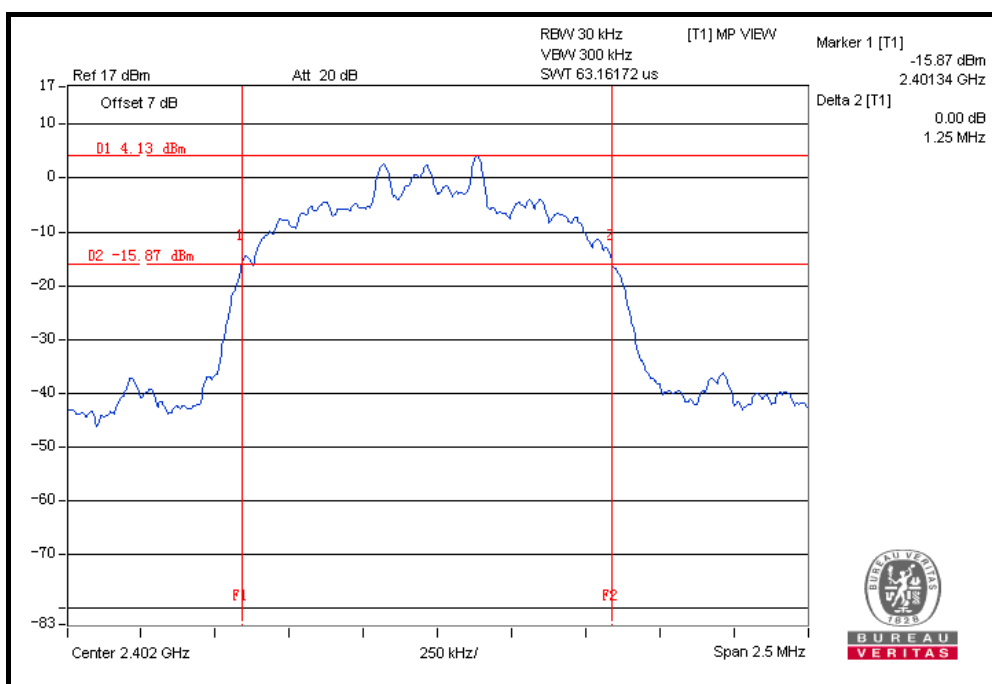



Test Report No.: RF130201N028

CH 39

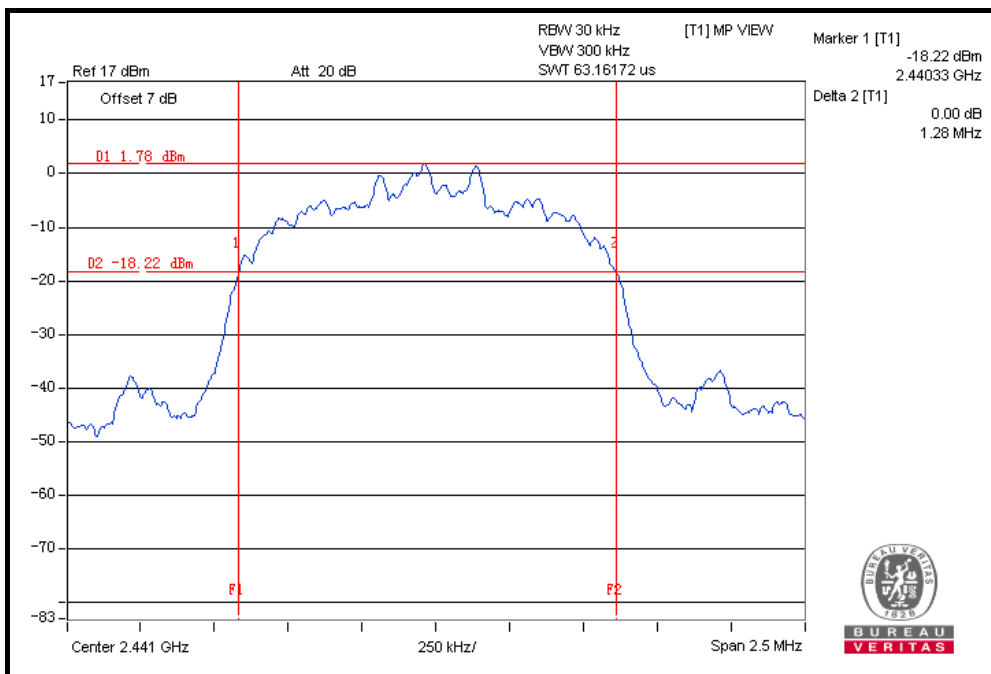

CH 78

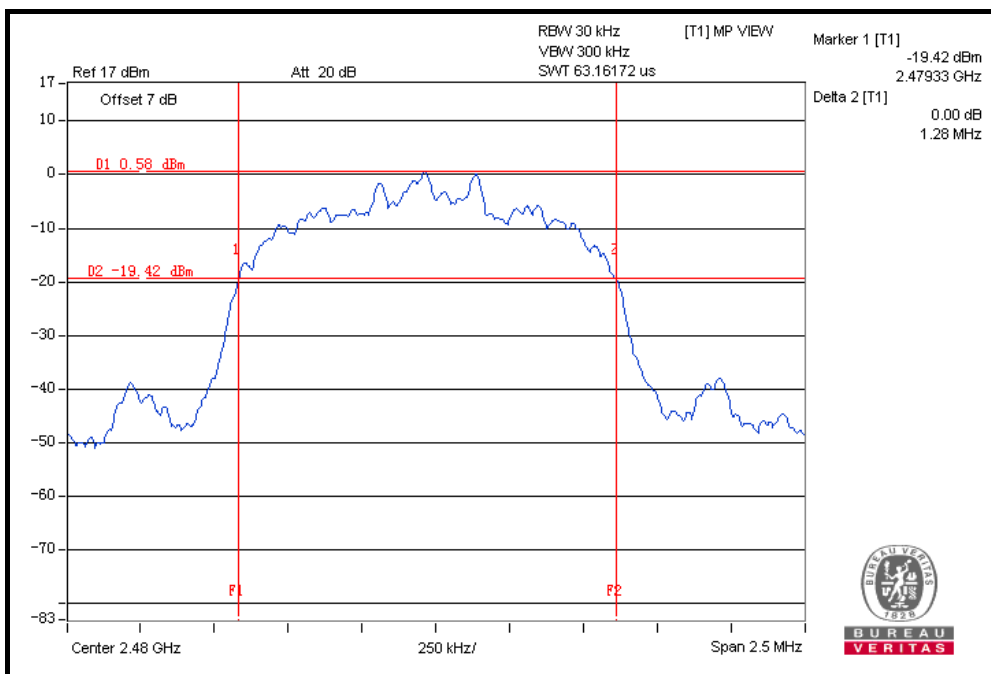

4.6. HOPPING CHANNEL SEPARATION

4.6.1. LIMIT OF HOPPING CHANNEL SEPARATION

At least 25kHz or two-third of 20dB hopping channel bandwidth (whichever is greater).

4.6.2. TEST SETUP

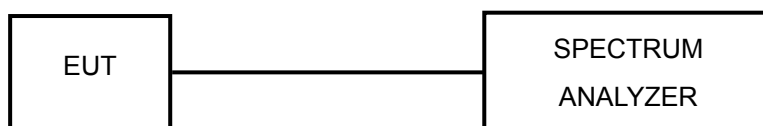

4.6.3. TEST INSTRUMENTS

Refer to section 4.1.2 to get information of above instrument.

4.6.4. TEST PROCEDURES

1. Check the calibration of the measuring instrument using either an internal calibrator or a known signal from an external generator.
2. Turn on the EUT and connect it to measurement instrument. Then set it to any one convenient frequency within its operating range.
3. By using the MaxHold function record the separation of two adjacent channels.
4. Measure the frequency difference of these two adjacent channels by SA MARK function. And then plot the result on SA screen.
5. Repeat above procedures until all frequencies measured were complete.

4.6.5. DEVIATION FROM TEST STANDARD

No deviation.

4.6.6. TEST RESULTS

GFSK

CHANNEL	FREQUENCY (MHz)	ADJACENT CHANNEL SEPARATION (MHz)	20dB BANDWIDTH (MHz)	MINIMUM LIMIT (MHz)	PASS / FAIL
0	2402	1.00	0.96	0.64	PASS
39	2441	1.00	0.96	0.65	PASS
78	2480	1.00	0.96	0.65	PASS

8DPSK

CHANNEL	FREQUENCY (MHz)	ADJACENT CHANNEL SEPARATION (MHz)	20dB BANDWIDTH (MHz)	MINIMUM LIMIT (MHz)	PASS / FAIL
0	2402	1.01	1.25	0.83	PASS
39	2441	1.00	1.28	0.85	PASS
78	2480	1.01	1.28	0.85	PASS

NOTE: The minimum limit is two-third 20dB bandwidth.

GFSK

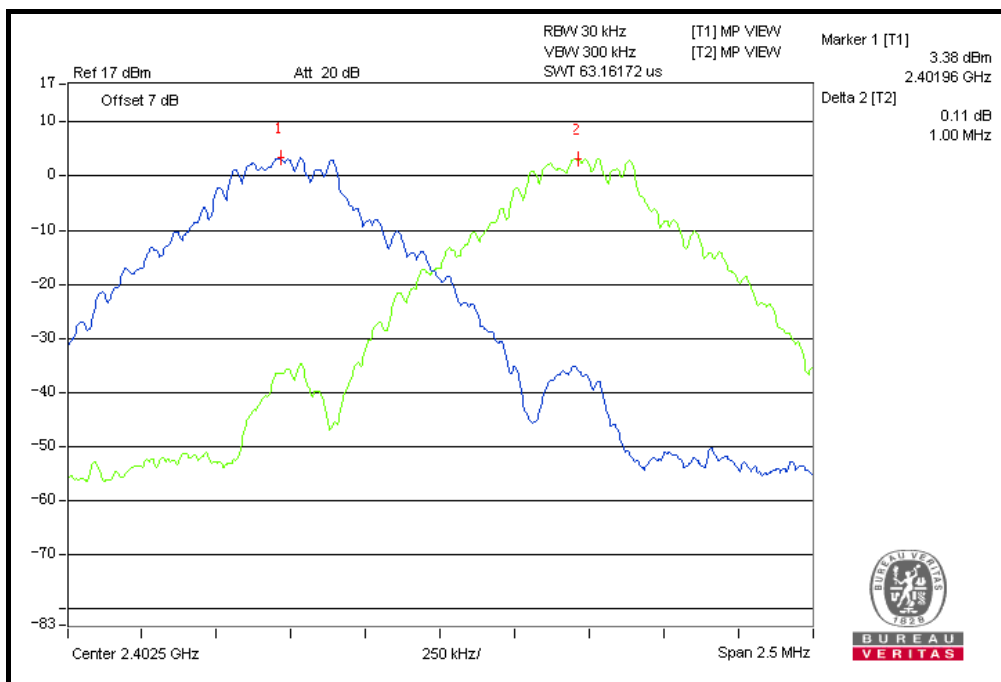

8DPSK

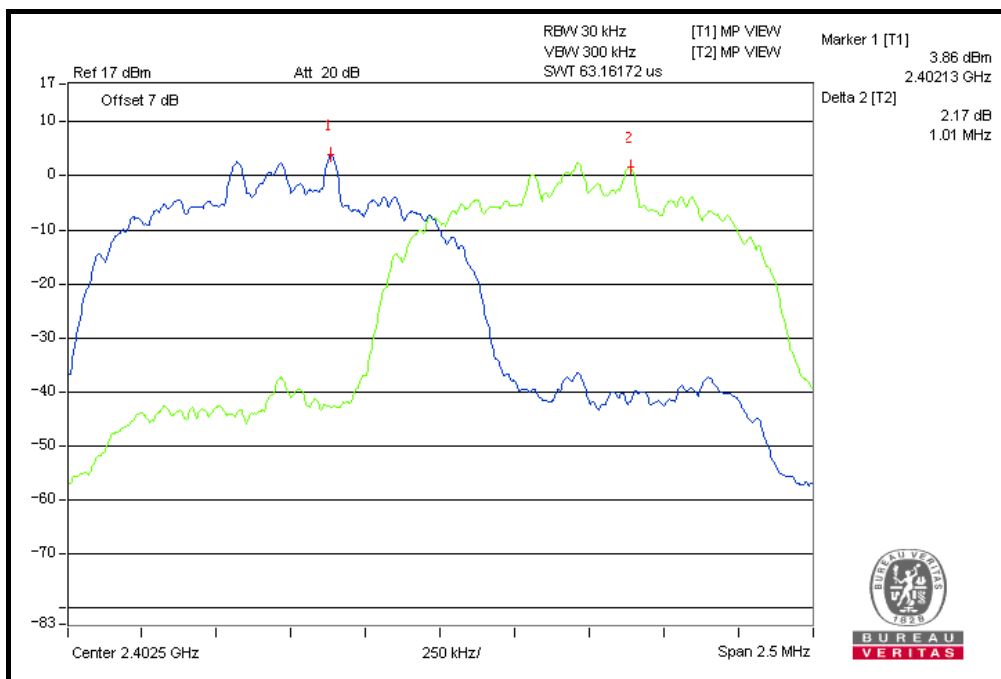

4.7. MAXIMUM OUTPUT POWER

4.7.1 LIMITS OF MAXIMUM OUTPUT POWER MEASUREMENT

The Maximum Output Power Measurement is 125mW.

4.7.2 TEST SETUP

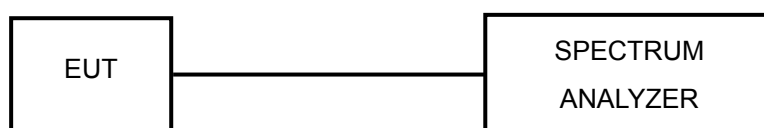

4.7.3 TEST INSTRUMENTS

Refer to section 4.1.2 to get information of above instrument.

4.7.4 TEST PROCEDURES

- a. Check the calibration of the measuring instrument using either an internal calibrator or a known signal from an external generator.
- b. Turn on the EUT and connect it to measurement instrument. Then set it to any one convenient frequency within its operating range. Set a reference level on the measuring instrument equal to the highest peak value.
- c. The center frequency of the spectrum analyzer is set to the fundamental frequency and using 3MHz RBW and 10 MHz VBW.
- d. Measure the captured power within the band and recording the plot.
- e. Repeat above procedures until all frequencies required were complete.

4.7.5 DEVIATION FROM TEST STANDARD

No deviation.

4.7.6 EUT OPERATING CONDITION

Same as item 4.1.6.

4.7.7 TEST RESULTS

GFSK

CHANNEL	CHANNEL FREQUENCY (MHz)	POWER OUTPUT (dBm)	POWER OUTPUT (mW)	POWER LIMIT (mW)	PASS/FAIL
0	2402	6.34	4.305	125	PASS
39	2441	5.75	3.758	125	PASS
78	2480	4.63	2.904	125	PASS

CH 0

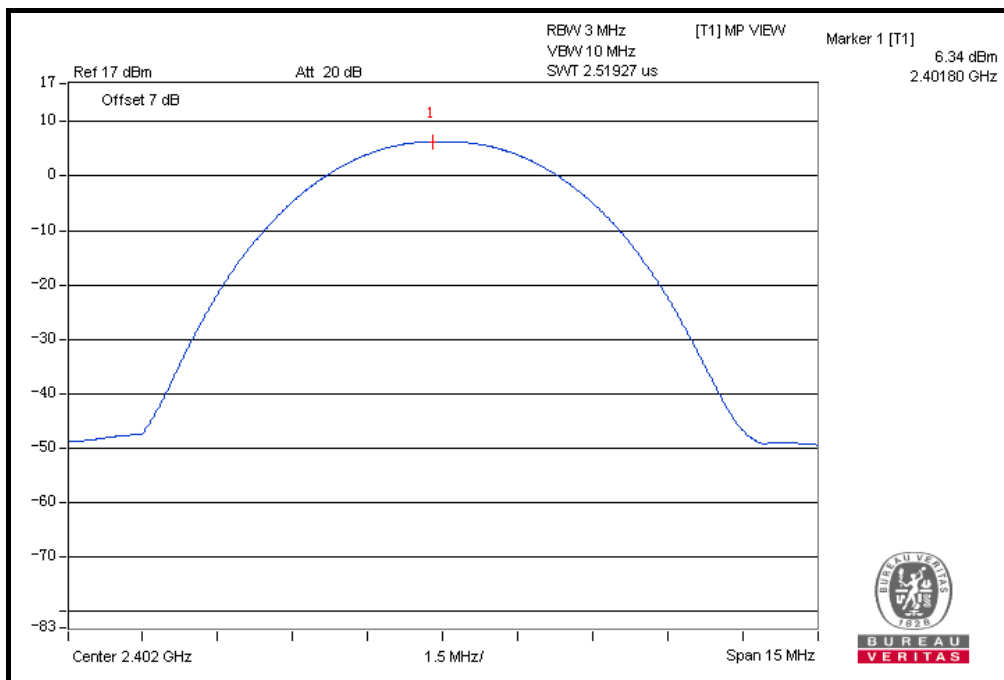

8DPSK

CHANNEL	CHANNEL FREQUENCY (MHz)	POWER OUTPUT (dBm)	POWER OUTPUT (mW)	POWER LIMIT (mW)	PASS/FAIL
0	2402	6.34	4.305	125	PASS
39	2441	5.79	3.793	125	PASS
78	2480	4.43	2.773	125	PASS

CH0

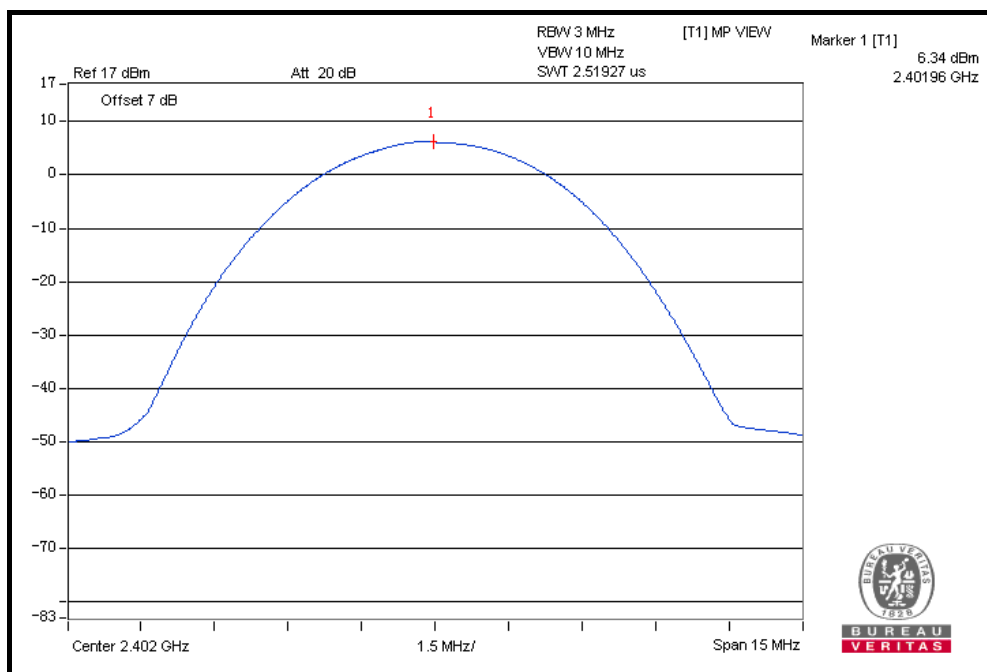

4.8. BAND EDGES MEASUREMENT

4.8.1 LIMITS OF BAND EDGES MEASUREMENT

Below -20dB of the highest emission level of operating band (in 100kHz RBW).

4.8.2 TEST INSTRUMENTS

Refer to section 4.1.2 to get information of above instrument.

4.8.3 TEST PROCEDURE

The transmitter output was connected to the spectrum analyzer via a low lose cable. Set both RBW and VBW of spectrum analyzer to 100 kHz with suitable frequency span including 100 MHz bandwidth from band edge. The band edges was measured and recorded.

4.8.4 DEVIATION FROM TEST STANDARD

No deviation.

4.8.5 EUT OPERATING CONDITION

Same as item 4.2.6

4.8.6 TEST RESULTS

The spectrum plots are attached on the following images., D1 line indicates the 20dB offset below D1.

GFSK CHO

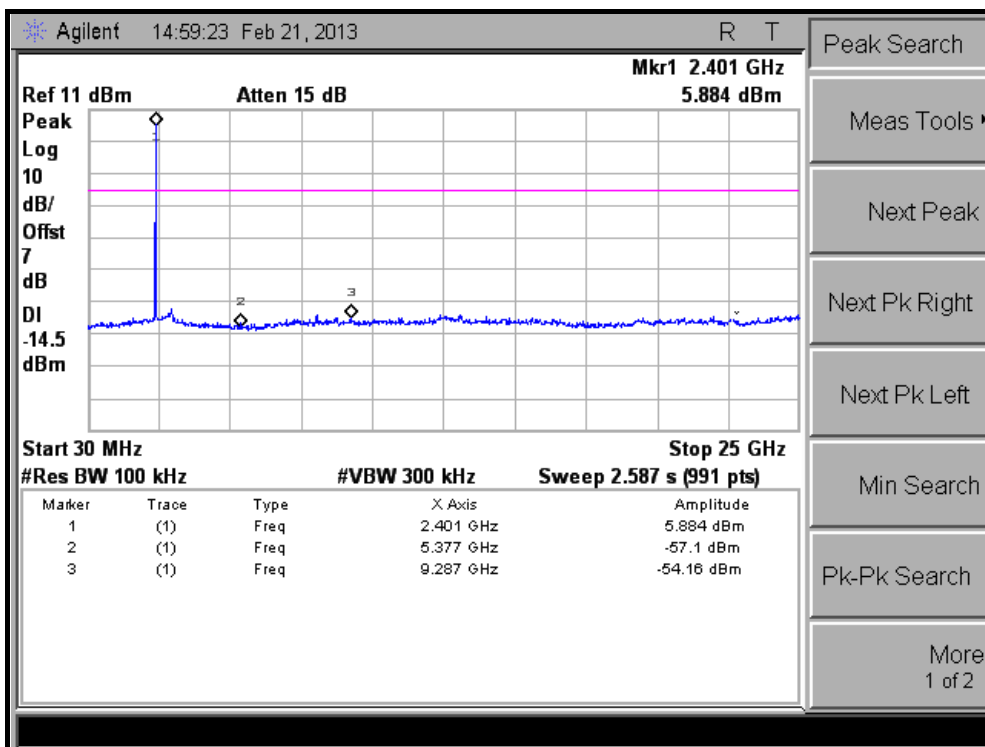

GFSK CH39

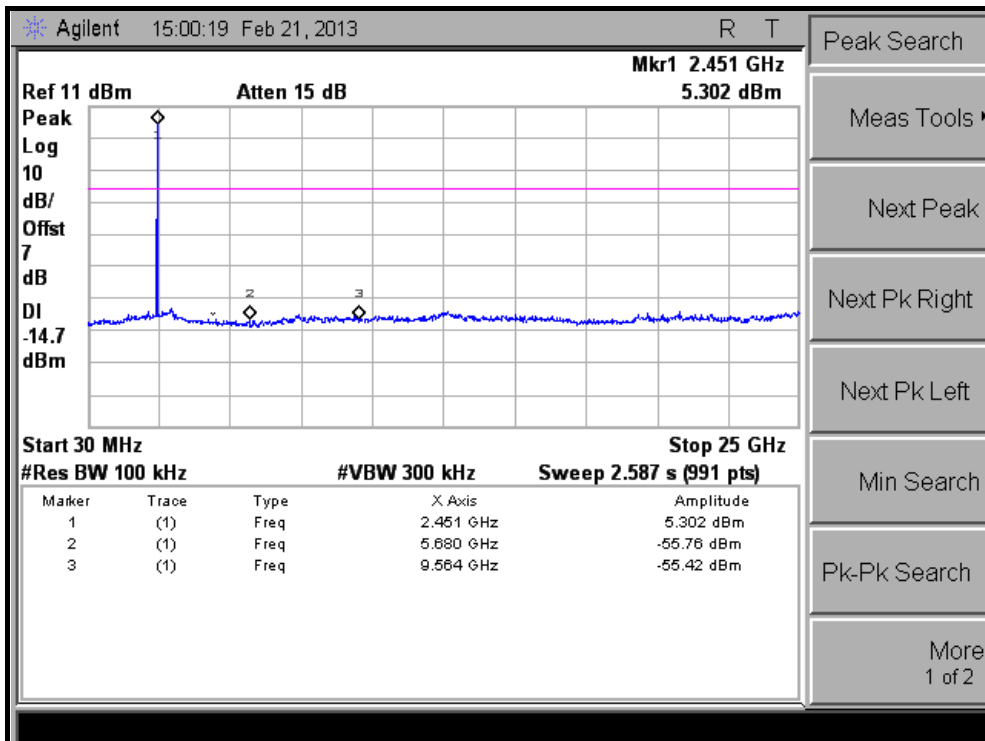



Test Report No.: RF130201N028

GFSK CH78

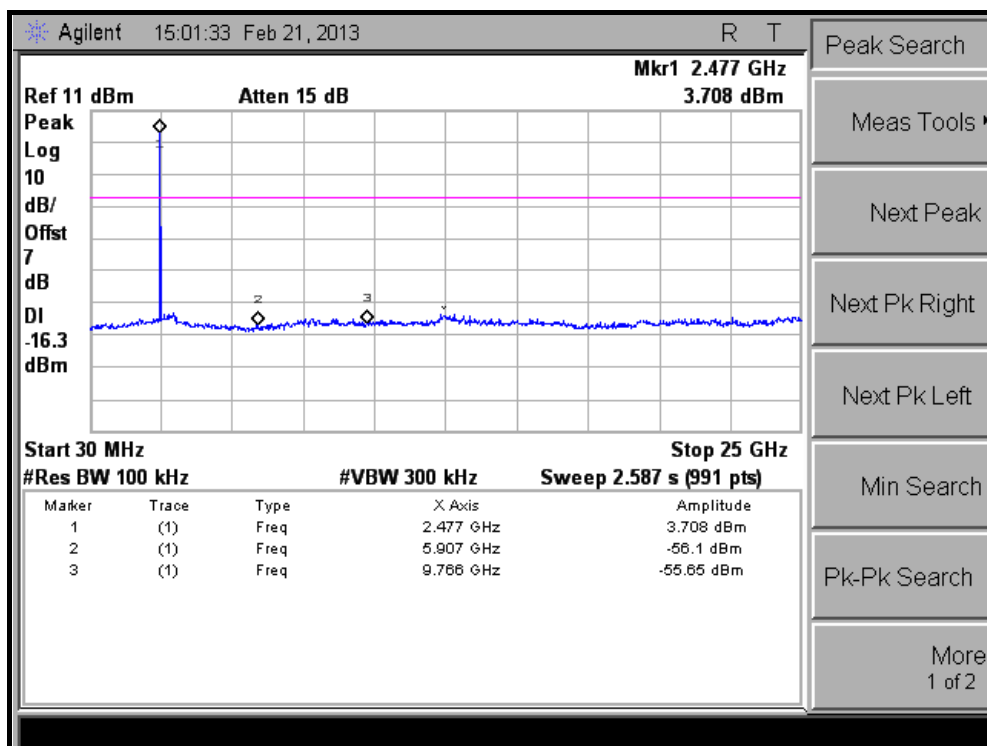

8DPSK CH0

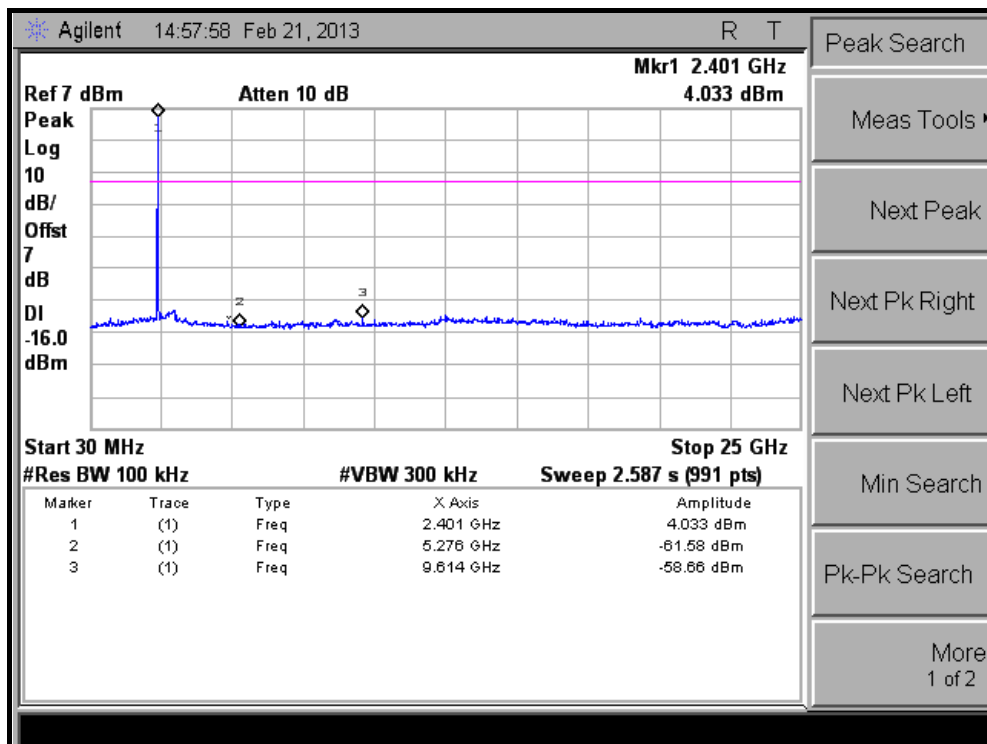

8DPSK CH39

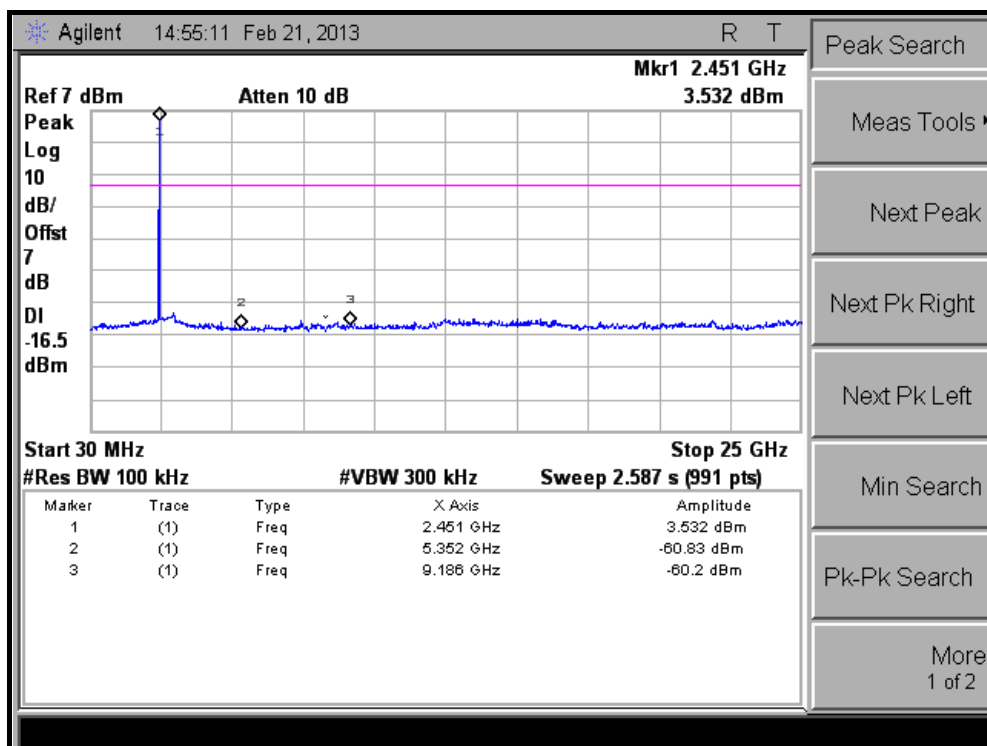

8DPSK CH78

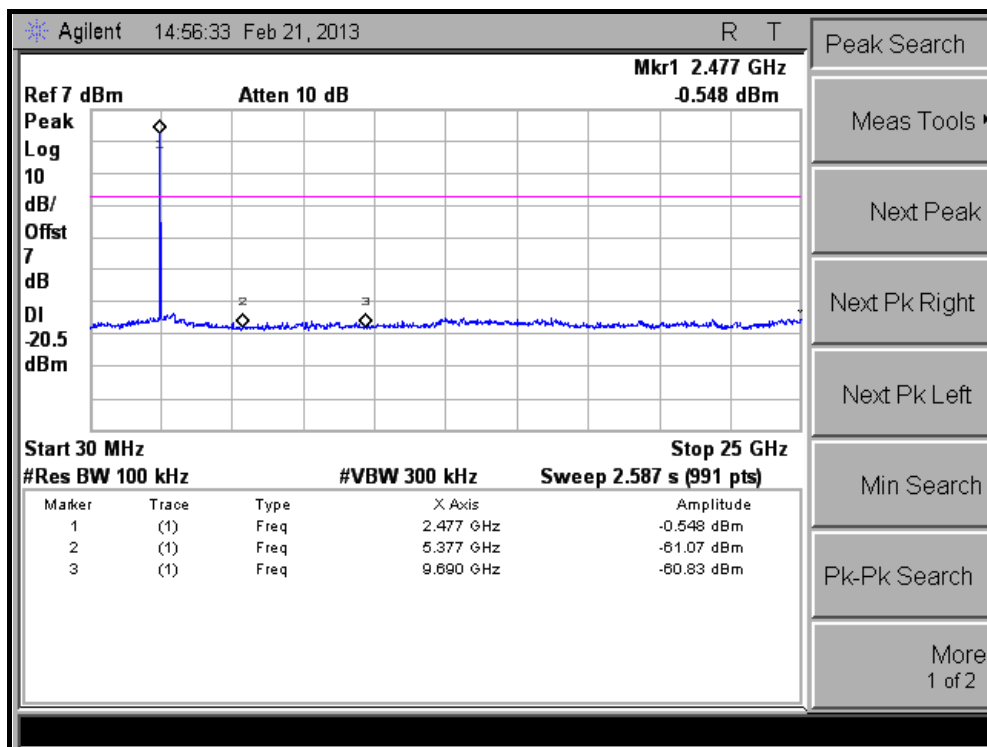



Test Report No.: RF130201N028

5. PHOTOGRAPHS OF THE TEST CONFIGURATION

Please refer to the attached file (Test Setup Photo).



Test Report No.: RF130201N028

6. APPENDIX A - MODIFICATIONS RECORDERS FOR ENGINEERING CHANGES TO THE EUT BY THE LAB

No any modifications are made to the EUT by the lab during the test.

---END---