



FCC RF Test Report

APPLICANT : Brightstar Corporation
EQUIPMENT : mobile phone
BRAND NAME : Avvio
MODEL NAME : Avvio 501S / Avvio 501 / Avvio 401TV / Avvio 501TV
MARKETING NAME : Avvio 501S / Avvio 501 / Avvio 401TV / Avvio 501TV
FCC ID : WVBA501X
STANDARD : FCC Part 15 Subpart C §15.247
CLASSIFICATION : (DSS) Spread Spectrum Transmitter

The product was received on Jan. 24, 2013 and completely tested on Mar. 25, 2013. We, SPORTON INTERNATIONAL (KUNSHAN) INC., would like to declare that the tested sample has been evaluated in accordance with the procedures and shown the compliance with the applicable technical standards.

The test results in this report apply exclusively to the tested model / sample. Without written approval of SPORTON INTERNATIONAL (KUNSHAN) INC., the test report shall not be reproduced except in full.

Reviewed by:

Jones Tsai / Manager



SPORTON INTERNATIONAL (KUNSHAN) INC.
No. 3-2, PingXiang Road, Kunshan, Jiangsu Province, P.R.C.



TABLE OF CONTENTS

REVISION HISTORY..... 3
SUMMARY OF TEST RESULT 4
1 GENERAL DESCRIPTION..... 5
1.1 Applicant..... 5
1.2 Manufacturer..... 5
1.3 Feature of Equipment Under Test..... 5
1.4 Product Specification of Equipment Under Test..... 6
1.5 Testing Site..... 6
1.6 Applied Standards 6
2 TEST CONFIGURATION OF EQUIPMENT UNDER TEST..... 7
2.1 Descriptions of Test Mode..... 7
2.2 Test Mode..... 8
2.3 Connection Diagram of Test System..... 9
2.4 Support Unit used in test configuration and system 10
2.5 Description of RF Function Operation Test Setup..... 10
2.6 Measurement Results Explanation Example..... 10
3 TEST RESULT 12
3.1 Number of Channel Measurement 12
3.2 Hopping Channel Separation Measurement 14
3.3 Dwell Time Measurement..... 21
3.4 20dB Bandwidth Measurement 23
3.5 Peak Output Power Measurement 30
3.6 Conducted Band Edges Measurement 33
3.7 Conducted Spurious Emission Measurement 40
3.8 Radiated Band Edges and Spurious Emission Measurement 44
3.9 AC Conducted Emission Measurement..... 56
3.10 Antenna Requirements..... 60
4 LIST OF MEASURING EQUIPMENT..... 61
5 UNCERTAINTY OF EVALUATION..... 62
APPENDIX A. PHOTOGRAPHS OF EUT
APPENDIX B. SETUP PHOTOGRAPHS



REVISION HISTORY

REPORT NO.	VERSION	DESCRIPTION	ISSUED DATE
FR312402	Rev. 01	Initial issue of report	Mar. 29, 2013



SUMMARY OF TEST RESULT

Report Section	FCC Rule	IC Rule	Description	Limit	Result	Remark
3.1	15.247(a)(1)	A8.4(2)	Number of Channels	≥ 15Chs	Pass	-
3.2	15.247(a)(1)	A8.1(b)	Hopping Channel Separation	≥ 2/3 of 20dB BW	Pass	-
3.3	15.247(a)(1)	A8.1(d)	Dwell Time of Each Channel	≤ 0.4sec in 31.6sec period	Pass	-
3.4	15.247(a)(1)	A8.1(a)	20dB Bandwidth	NA	Pass	-
3.5	15.247(b)(1)	A8.1(b)	Peak Output Power	≤ 1 w for 1Mbps ≤ 125 Mw for 2, 3Mbps	Pass	-
3.6	15.247(d)	A8.5	Conducted Band Edges	≤ 20dBc	Pass	-
3.7	15.247(d)	A8.5	Conducted Spurious Emission	≤ 20dBc	Pass	-
3.8	15.247(d)	A8.5	Radiated Band Edges and Radiated Spurious Emission	15.209(a) & 15.247(d)	Pass	Under limit 0.45 dB at 7323.000 MHz
3.9	15.207	Gen 7.2.4	AC Conducted Emission	15.207(a)	Pass	Under limit 10.57 dB at 0.310 MHz
3.10	15.203 & 15.247(b)	A8.4	Antenna Requirement	N/A	Pass	-

1 General Description

1.1 Applicant

Brightstar Corporation
 9725 NW 117th Ave., Miami, Florida, United States

1.2 Manufacturer

KCMobile Co., Ltd.
 #502, Ace techno tower 8th, 191-7 Guro-dong, Guro-Gu, Seoul, South Korea

1.3 Feature of Equipment Under Test

Product Feature	
Equipment	mobile phone
Brand Name	Avvio
Model Name	Avvio 501S / Avvio 501 / Avvio 401TV / Avvio 501TV
Marketing Name	Avvio 501S / Avvio 501 / Avvio 401TV / Avvio 501TV
FCC ID	WVBA501X
EUT supports Radios application	GSM/GPRS/Bluetooth
HW Version	D99_MB_V0.2
SW Version	V1.0.1
EUT Stage	Identical Prototype

Remark:

1. The above EUT's information was declared by manufacturer. Please refer to the specifications or user's manual for more detailed description.
2. There are four model names of this project. The differences between them are summary below:

Model Name List	Model Name	SIM Slot	TV function
Model 1	Avvio 501S	Dual SIM	No TV function
Model 2	Avvio 501	Single SIM	No TV function
Model 3	Avvio 501TV	Single SIM	With TV function
Model 4	Avvio 401TV	Single SIM	With TV function

Except list above, all the others are the same including circuit design, PCB board, structure and all components. It is special to declare. After pre-scan all types of EUT, we found test result of the sample that dual SIM was the worst, so we choose dual SIM card mobile to perform all test.

1.4 Product Specification of Equipment Under Test

Product Specification subjective to this standard	
Tx/Rx Frequency Range	2402 MHz ~ 2480 MHz
Number of Channels	79
Carrier Frequency of Each Channel	2402+n*1 MHz; n=0~78
Maximum Output Power to Antenna	Bluetooth BDR (1Mbps) : 8.79 dBm (0.0076 W) Bluetooth EDR (2Mbps) : 8.37 dBm (0.0069 W) Bluetooth EDR (3Mbps) : 8.64 dBm (0.0073 W)
Antenna Type	Monopole Antenna type with gain -2.50 dBi
Type of Modulation	Bluetooth BDR (1Mbps) : GFSK Bluetooth EDR (2Mbps) : $\pi/4$ -DQPSK Bluetooth EDR (3Mbps) : 8-DPSK

1.5 Testing Site

Test Site	SPORTON INTERNATIONAL (KUNSHAN) INC.		
Test Site Location	No. 3-2, PingXiang Road, Kunshan, Jiangsu Province, P.R.C. TEL: +86-0512-5790-0158 FAX: +86-0512-5790-0958		
Test Site No.	Sporton Site No.		FCC/IC Registration No.
	TH01-KS	CO01-KS	03CH01-KS
			149928/4086E-1

The test site complies with ANSI C63.4 2003 requirement.

1.6 Applied Standards

According to the specifications of the manufacturer, the EUT must comply with the requirements of the following standards:

- FCC Part 15 Subpart C §15.247
- FCC Public Notice DA 00-705
- ANSI C63.10-2009

Remark:

1. All test items were verified and recorded according to the standards and without any deviation during the test.
2. This EUT has also been tested and complied with the requirements of FCC Part 15, Subpart B, recorded in a separate test report.

2 Test Configuration of Equipment Under Test

2.1 Descriptions of Test Mode

Preliminary tests were performed in different data rate and recorded the RF output power in the following table:

Channel	Frequency	Bluetooth RF Output Power		
		Data Rate / Modulation		
		GFSK	$\pi/4$ -DQPSK	8-DPSK
		1Mbps	2Mbps	3Mbps
Ch00	2402MHz	7.60 dBm	7.17 dBm	7.44 dBm
Ch39	2441MHz	8.79 dBm	8.37 dBm	8.64 dBm
Ch78	2480MHz	8.78 dBm	8.36 dBm	8.63 dBm

Remark:

1. All the test data for each data rate were verified, but only the worst case was reported.
 2. The data rate was set in 1Mbps for all the test items due to the highest RF output power.
- a. The EUT has been associated with peripherals pursuant to ANSI C63.10-2009 and configuration operated in a manner tended to maximize its emission characteristics in a typical application. Frequency range investigated: conduction (150 KHz to 30 MHz), radiation (9 KHz to the 10th harmonic of the highest fundamental frequency or to 40 GHz, whichever is lower). Pre-scanned tests, X, Y, Z in three orthogonal panels, and different data rates were conducted to determine the final configuration (Y plane as worst plane) from all possible combinations, and the worst mode of radiated spurious emissions is Bluetooth 1Mbps mode, and recorded in this report.
 - b. AC power line Conducted Emission was tested under maximum output power.

2.2 Test Mode

The following summary table is showing all test modes to demonstrate in compliance with the standard.

Summary table of Test Cases			
Test Item	Data Rate / Modulation		
	Bluetooth BDR 1Mbps GFSK	Bluetooth EDR 2Mbps $\pi/4$ -DQPSK	Bluetooth EDR 3Mbps 8-DPSK
Conducted Test Cases	Mode 1: CH00_2402 MHz	Mode 4: CH00_2402 MHz	Mode 7: CH00_2402 MHz
	Mode 2: CH39_2441 MHz	Mode 5: CH39_2441 MHz	Mode 8: CH39_2441 MHz
	Mode 3: CH78_2480 MHz	Mode 6: CH78_2480 MHz	Mode 9: CH78_2480 MHz
Radiated Test Cases	Bluetooth EDR 1Mbps GFSK		
	Mode 1: CH00_2402 MHz		
	Mode 2: CH39_2441 MHz		
	Mode 3: CH78_2480 MHz		
AC Conducted Emission	Mode 1 :GSM850 Idle + Bluetooth Link + USB Cable (Charging from Adapter) + Earphone		
<p>Remark: For radiated test cases, the worst mode data rate 1Mbps was reported only, because this data rate has the highest RF output power at preliminary tests, and the conducted spurious emissions and conducted band edge measurement for each data rate are no worse than 1Mbps, and no other significantly frequencies found in conducted spurious emission.</p>			

2.3 Connection Diagram of Test System

<Bluetooth Tx Mode>

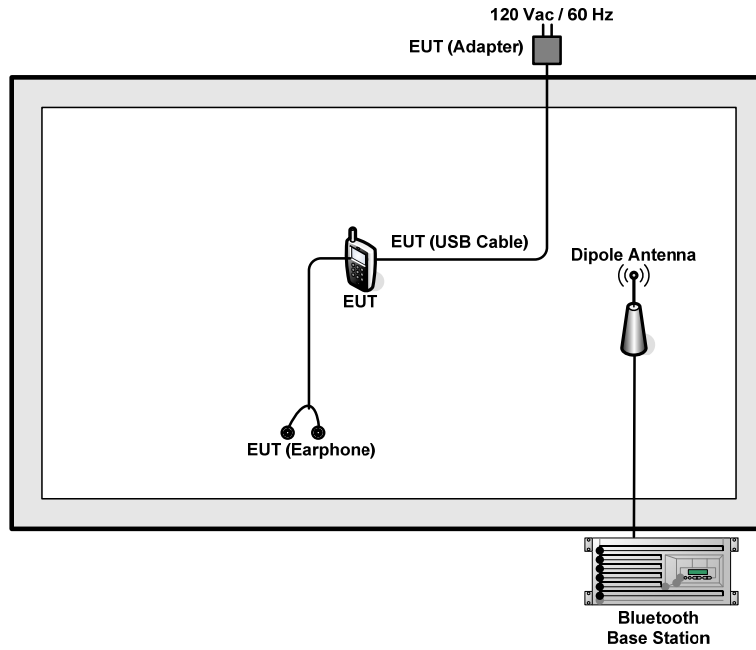

<AC Conducted Emission Mode>

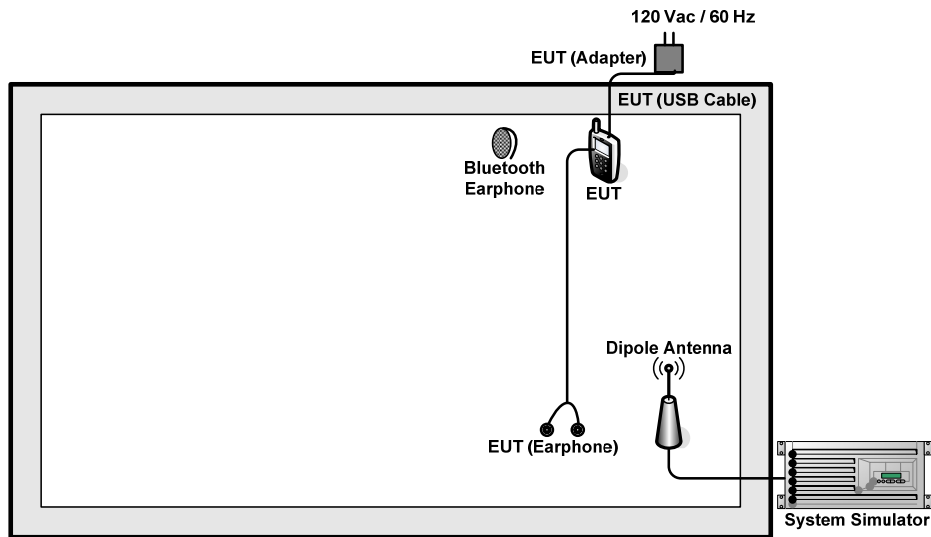

2.4 Support Unit used in test configuration and system

Item	Equipment	Trade Name	Model Name	FCC ID	Data Cable	Power Cord
1.	System Simulator	R&S	CMU 200	N/A	N/A	Unshielded, 1.8 m
2.	Bluetooth Base Station	R&S	CBT	FCC DoC	N/A	Unshielded, 1.8 m
3.	DC Power Supply	GWINSTEK	GPS-3030D	N/A	N/A	Unshielded, 1.8 m
4.	Bluetooth Earphone	Nokia	BH-106	QTLBH-106	N/A	N/A

2.5 Description of RF Function Operation Test Setup

For Bluetooth function, key in “* # 123258364 #” on the EUT directly. Then, the EUT will get into the engineering modes to contact with Bluetooth base station for continuous transmitting and receiving signals.

2.6 Measurement Results Explanation Example

For conducted test items:

The offset level is set in the spectrum analyzer to compensate the RF cable loss and 10dB attenuator between EUT conducted output port and spectrum analyzer. With the offset compensation, the spectrum analyzer reading level is exactly the EUT RF output level.

The spectrum analyzer offset is derived from RF cable loss and 10dB attenuator factor.

Offset = RF cable loss + attenuator factor.

Following table shows an offset computation example with cable loss 5.6 dB.

Example :

Offset(dB) = RF cable loss(dB) + attenuator factor(dB).

= 5.6 + 10 = 15.6 (dB)

For radiated band edges and spurious emission test :

Per part 15.35(c), the EUT Bluetooth average emission level could be determined by the peak emission level applying duty cycle correction factor, to represent averaging over the whole pulse train.

The average level is derived from the peak level corrected with "Duty cycle correction factor".

$$\text{Average Emission Level(dBuV/m)} = \text{Peak Emission Level(dBuV/m)} + \text{Duty cycle correction factor(dB)}$$

$$\text{Duty cycle correction factor(dB)} = 20 * \log(\text{Duty cycle}).$$

$$\text{Duty cycle} = \text{On time} / 100 \text{ milliseconds}$$

$$\text{On time} = \text{dwell time} * \text{hopping number in } 100 \text{ ms}$$

For example : bluetooth with dwell time 2.9ms and 2 hops in 100 ms, then

$$\text{Duty cycle correction factor(dB)} = 20 * \log((2.9 * 2) / 100) = -24.73 \text{ dB}$$

Following shows an average computation example with duty cycle correction factor = -24.73dB, and the peak emission level is 45.61 dBuV/m.

Example :

$$\begin{aligned} \text{Average Emission Level(dBuV/m)} &= \text{Peak Emission Level(dBuV/m)} + \text{duty cycle correction factor(dB)} \\ &= 45.61 + (-24.73) = 20.88 \text{ (dBuV/m)} \end{aligned}$$

3 Test Result

3.1 Number of Channel Measurement

3.1.1 Limits of Number of Hopping Frequency

Frequency hopping systems in the 2400-2483.5 MHz band shall use at least 15 channels.

3.1.2 Measuring Instruments

See list of measuring instruments of this test report.

3.1.3 Test Procedure

1. The testing follows FCC Public Notice DA 00-705 Measurement Guidelines.
2. The RF output of EUT was connected to the spectrum analyzer by RF cable and attenuator. The path loss was compensated to the results for each measurement.
3. Set to the maximum power setting and enable the EUT transmit continuously.
4. Enable the EUT hopping function.
5. Use the following spectrum analyzer settings: Span = the frequency band of operation; RBW \geq 1% of the span; VBW \geq RBW; Sweep = auto; Detector function = peak; Trace = max hold.
6. The number of hopping frequency used is defined as the number of total channel.
7. Record the measurement data derived from spectrum analyzer.

3.1.4 Test Setup

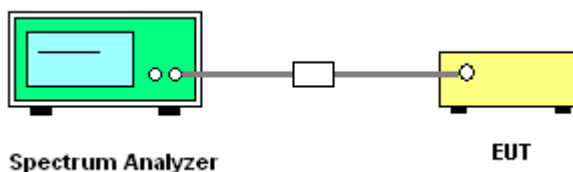

3.1.5 Test Result of Number of Hopping Frequency

Test Mode :	1Mbps	Temperature :	20~21°C
Test Engineer :	Zhi Lu	Relative Humidity :	40~41%
Number of Hopping (Channel)	Adaptive Frequency Hopping (Channel)	Limits (Channel)	Pass/Fail
79	≥ 20	> 15	Pass



Number of Hopping Channel Plot on Channel 00 - 78

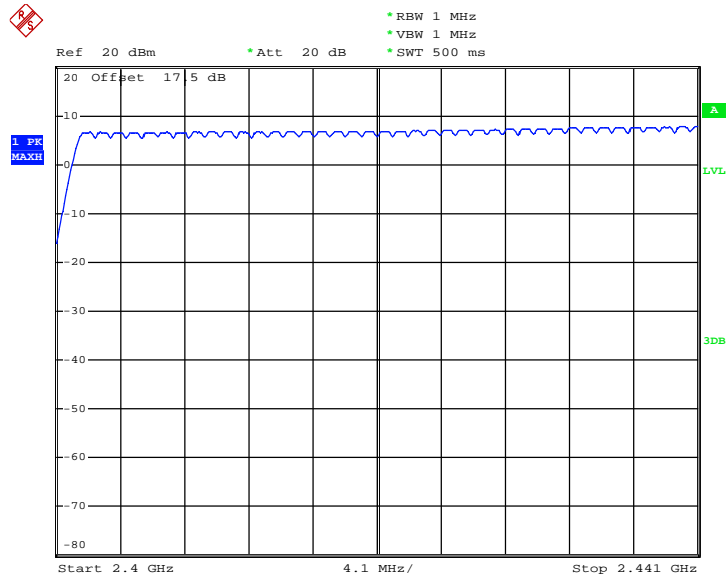

Date: 5.FEB.2013 10:35:59

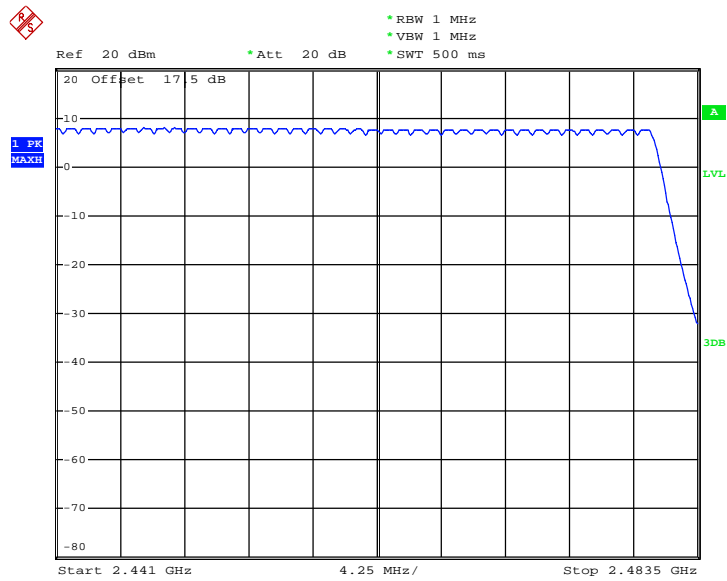

Date: 5.FEB.2013 10:40:29

3.2 Hopping Channel Separation Measurement

3.2.1 Limit of Hopping Channel Separation

Frequency hopping systems operating in the 2400-2483.5 MHz band may have hopping channel carrier frequencies that are separated by 25 KHz or two-thirds of the 20 dB bandwidth of the hopping channel, whichever is greater.

3.2.2 Measuring Instruments

See list of measuring instruments of this test report.

3.2.3 Test Procedures

1. The testing follows FCC Public Notice DA 00-705 Measurement Guidelines.
2. The RF output of EUT was connected to the spectrum analyzer by RF cable and attenuator. The path loss was compensated to the results for each measurement.
3. Set to the maximum power setting and enable the EUT transmit continuously.
4. Enable the EUT hopping function.
5. Use the following spectrum analyzer settings:
Span = wide enough to capture the peaks of two adjacent channels; RBW \geq 1% of the span;
VBW \geq RBW; Sweep = auto; Detector function = peak; Trace = max hold.
6. Measure and record the results in the test report.

3.2.4 Test Setup





3.2.5 Test Result of Hopping Channel Separation

Test Mode :	1Mbps	Temperature :	20~21°C
Test Engineer :	Zhi Lu	Relative Humidity :	40~41%

Channel	Frequency (MHz)	Frequency Separation (MHz)	(2/3 of 20dB BW) Limits (MHz)	Pass/Fail
00	2402	1.002	0.6427	Pass
39	2441	1.002	0.6373	Pass
78	2480	1.002	0.6427	Pass

Channel Separation Plot on Channel 00 - 01

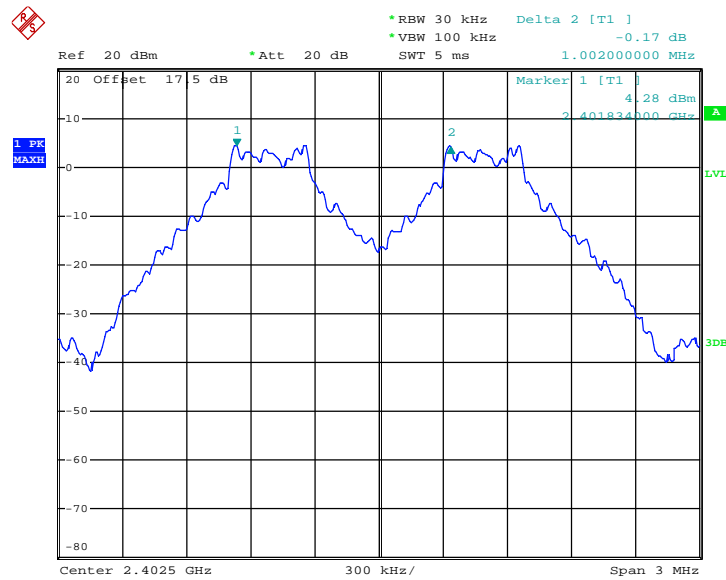

Date: 5.FEB.2013 11:14:01



Channel Separation Plot on Channel 39 - 40

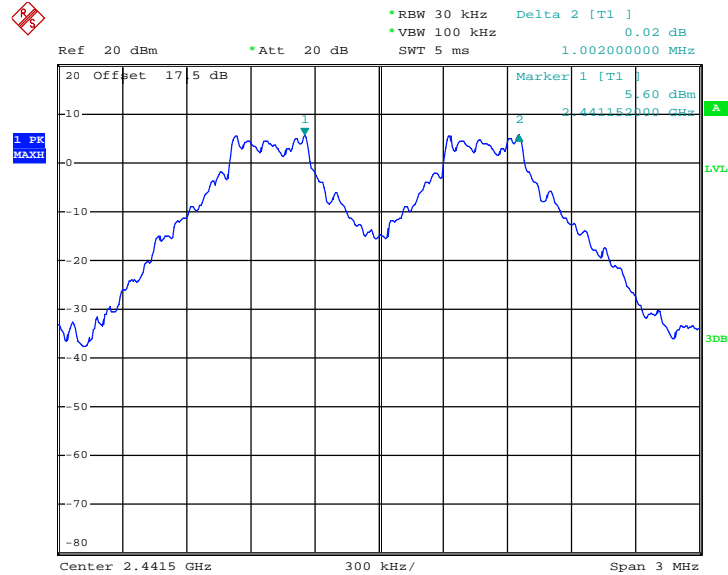

Date: 5.FEB.2013 11:15:38

Channel Separation Plot on Channel 77 - 78

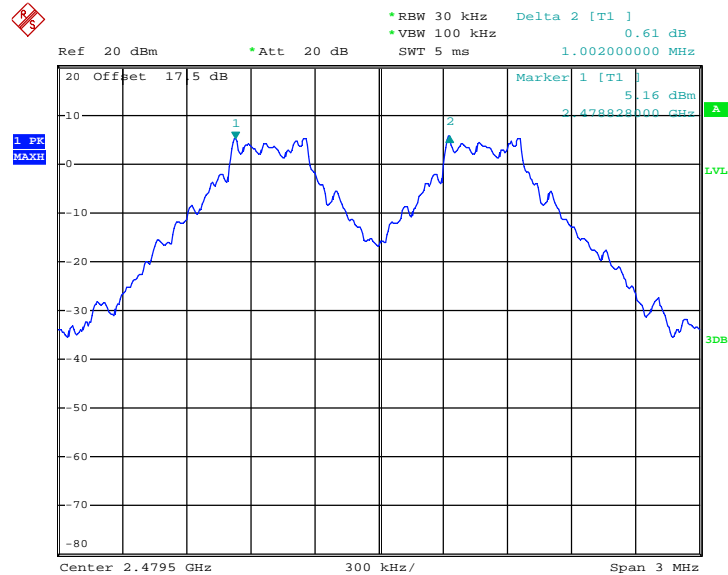

Date: 5.FEB.2013 11:17:17



Test Mode :	2Mbps	Temperature :	20~21°C
Test Engineer :	Zhi Lu	Relative Humidity :	40~41%

Channel	Frequency (MHz)	Frequency Separation (MHz)	(2/3 of 20dB BW) Limits (MHz)	Pass/Fail
00	2402	1.002	0.8347	Pass
39	2441	1.002	0.8373	Pass
78	2480	1.002	0.8373	Pass

Channel Separation Plot on Channel 00 - 01

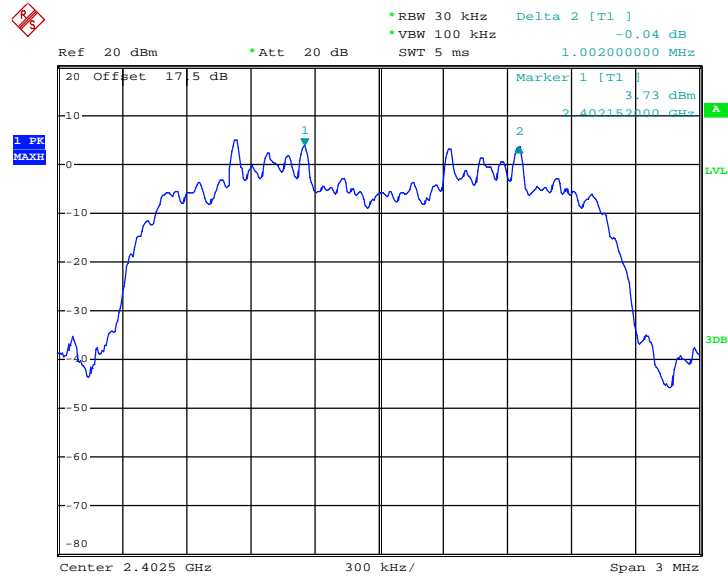

Date: 5.FEB.2013 11:18:48



Channel Separation Plot on Channel 39 - 40

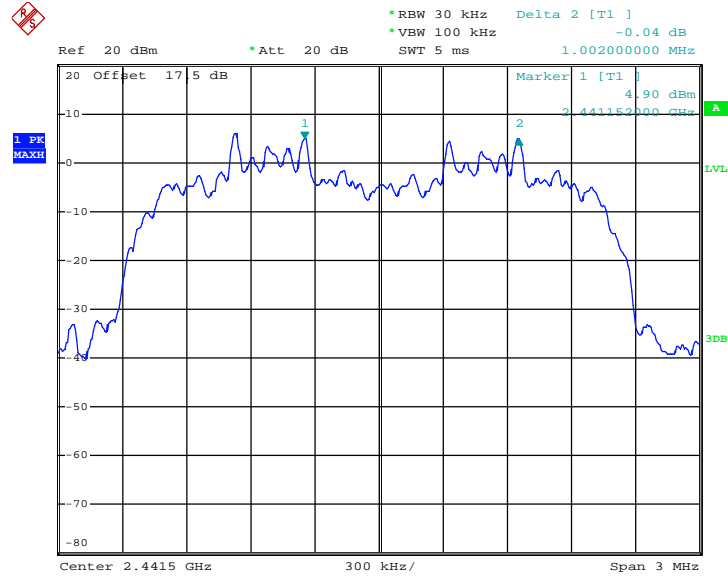

Date: 5.FEB.2013 11:19:55

Channel Separation Plot on Channel 77 - 78

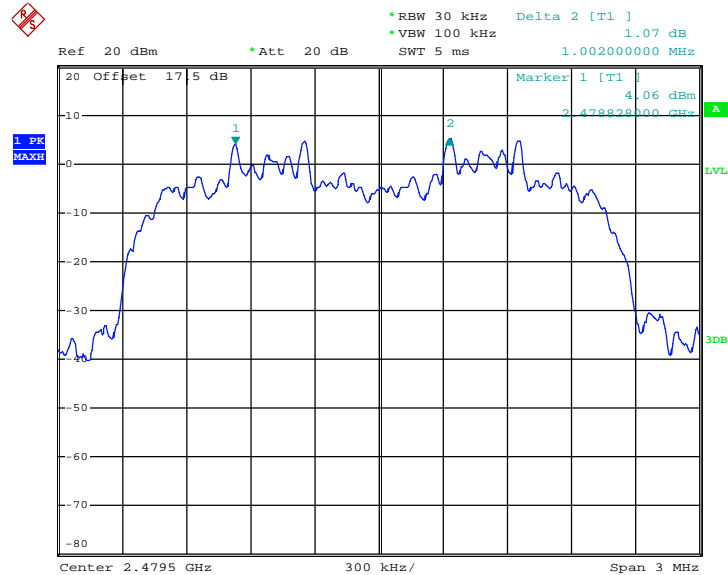

Date: 5.FEB.2013 11:21:13



Test Mode :	3Mbps	Temperature :	20~21°C
Test Engineer :	Zhi Lu	Relative Humidity :	40~41%

Channel	Frequency (MHz)	Frequency Separation (MHz)	(2/3 of 20dB BW) Limits (MHz)	Pass/Fail
00	2402	1.002	0.8160	Pass
39	2441	1.002	0.8133	Pass
78	2480	1.002	0.8347	Pass

Channel Separation Plot on Channel 00 - 01

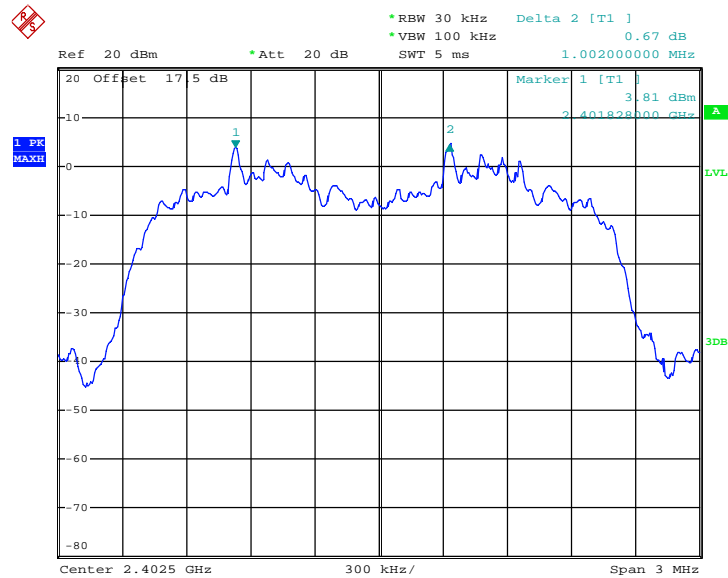

Date: 5.FEB.2013 11:24:36



Channel Separation Plot on Channel 39 - 40

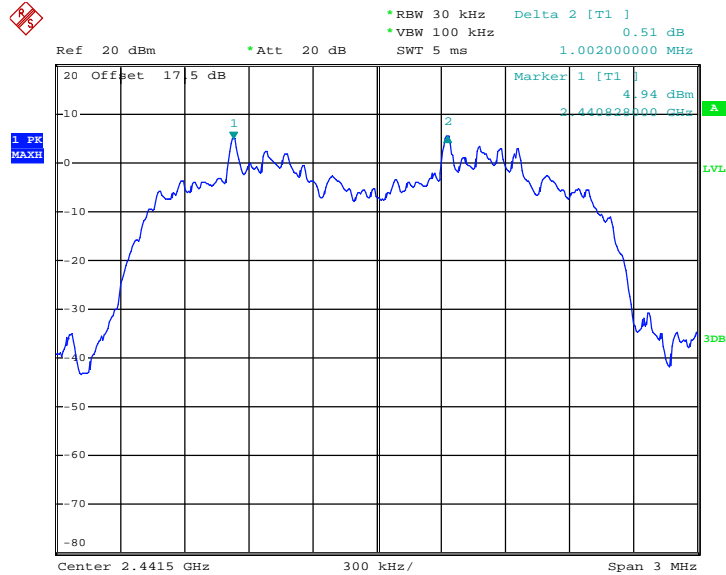

Date: 5.FEB.2013 11:23:29

Channel Separation Plot on Channel 77 - 78

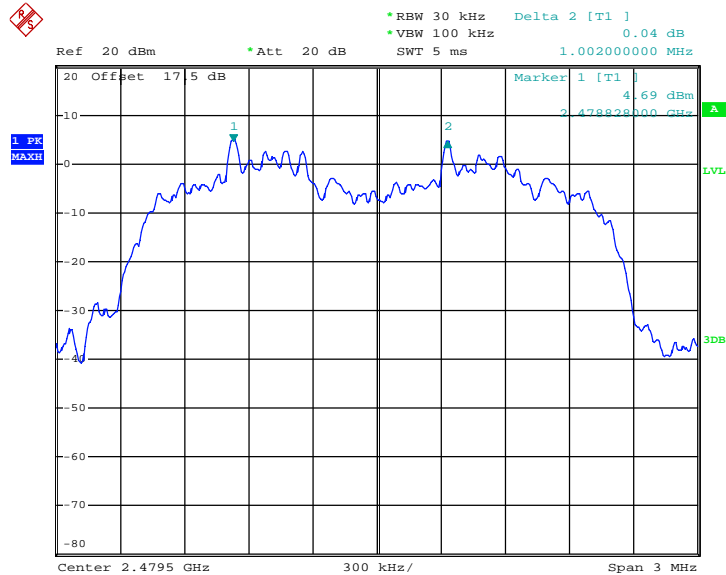

Date: 5.FEB.2013 11:22:23

3.3 Dwell Time Measurement

3.3.1 Limit of Dwell Time

The average time of occupancy on any channel shall not be greater than 0.4 seconds within a period of 0.4 seconds multiplied by the number of hopping channels employed.

3.3.2 Measuring Instruments

See list of measuring instruments of this test report.

3.3.3 Test Procedures

1. The testing follows FCC Public Notice DA 00-705 Measurement Guidelines.
2. The RF output of EUT was connected to the spectrum analyzer by RF cable and attenuator. The path loss was compensated to the results for each measurement.
3. Set to the maximum power setting and enable the EUT transmit continuously.
4. Enable the EUT hopping function.
5. Use the following spectrum analyzer settings: Span = zero span, centered on a hopping channel; RBW = 1 MHz; VBW \geq RBW; Sweep = as necessary to capture the entire dwell time per hopping channel; Detector function = peak; Trace = max hold.
6. Measure and record the results in the test report.

3.3.4 Test Setup

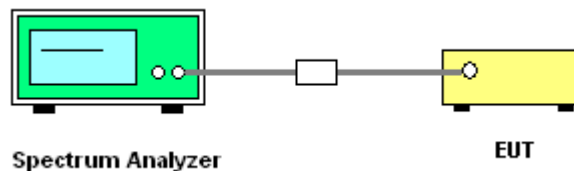

3.3.5 Test Result of Dwell Time

Test Mode :	DH5	Temperature :	20~21°C
Test Engineer :	Zhi Lu	Relative Humidity :	40~41%

Mode	Hopping Channel Number	Hops Over Occupancy Time(hops)	Package Transfer Time (ms)	Dwell Time (sec)	Limits (sec)	Pass/Fail
Normal	79	106.67	2.900	0.31	0.4	Pass
AFH	20	53.34	2.900	0.15	0.4	Pass

Remark:

1. In normal mode, hopping rate is 1600hops/s with 6 slots in 79 hopping channels.
 With channel hopping rate (1600 / 6 / 79) in Occupancy Time Limit (0.4 x 79) (s),
 Hops Over Occupancy Time comes to (1600 / 6 / 79) x (0.4 x 79) = 106.67 hops.

2. In AFH mode, hopping rate is 800hops/s with 6 slots in 20 hopping channels.
 With channel hopping rate (800 / 6 / 20) in Occupancy Time Limit (0.4 x 20) (s),
 Hops Over Occupancy Time comes to (800 / 6 / 20) x (0.4 x 20) = 53.34 hops.

3. Dwell Time(s) = Hops Over Occupancy Time (hops) x Package Transfer Time

Package Transfer Time Plot

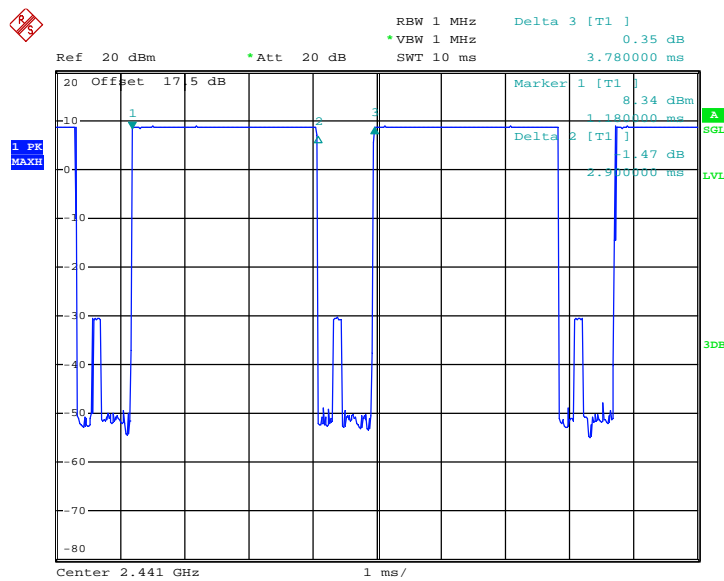

Date: 4.FEB.2013 09:25:30

3.4 20dB Bandwidth Measurement

3.4.1 Limit of 20dB Bandwidth

Reporting only

3.4.2 Measuring Instruments

See list of measuring instruments of this test report.

3.4.3 Test Procedures

1. The testing follows FCC Public Notice DA 00-705 Measurement Guidelines.
2. The RF output of EUT was connected to the spectrum analyzer by RF cable and attenuator. The path loss was compensated to the results for each measurement.
3. Set to the maximum power setting and enable the EUT transmit continuously.
4. Use the following spectrum analyzer settings for 20dB Bandwidth measurement.
Span = approximately 2 to 3 times the 20 dB bandwidth, centered on a hopping channel;
RBW \geq 1% of the 20 dB bandwidth; VBW \geq RBW; Sweep = auto; Detector function = peak;
Trace = max hold.
5. Measure and record the results in the test report.

3.4.4 Test Setup

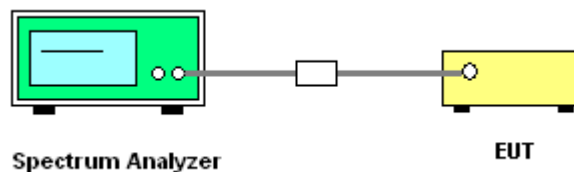

3.4.5 Test Result of 20dB Bandwidth

Test Mode :	1Mbps	Temperature :	20~21°C
Test Engineer :	Zhi Lu	Relative Humidity :	40~41%

Channel	Frequency (MHz)	20dB Bandwidth (MHz)
00	2402	0.964
39	2441	0.956
78	2480	0.964

20 dB Bandwidth Plot on Channel 00

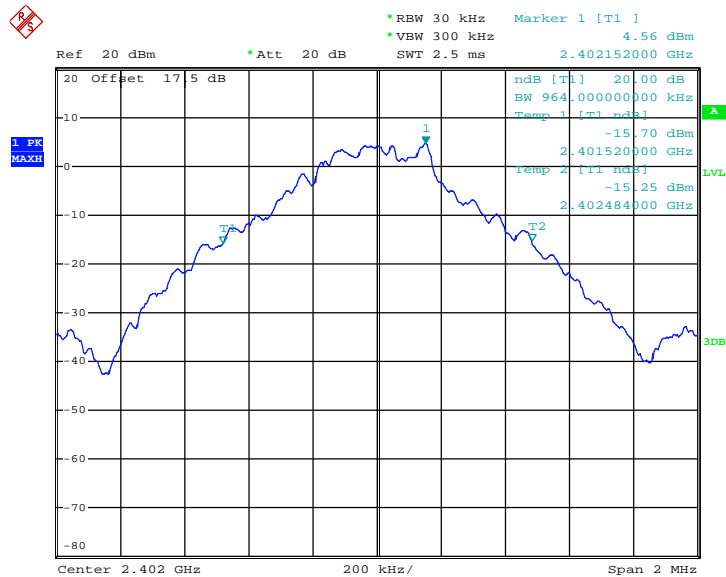

Date: 5.FEB.2013 10:07:19



20 dB Bandwidth Plot on Channel 39

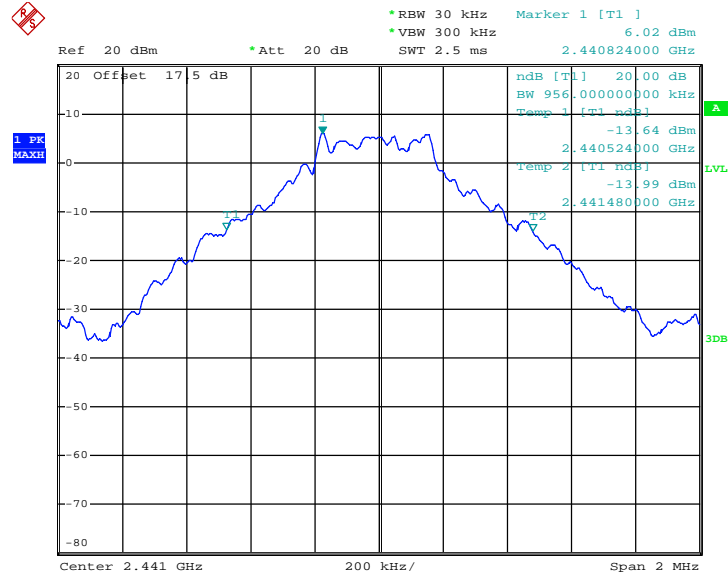

Date: 5.FEB.2013 10:05:37

20 dB Bandwidth Plot on Channel 78

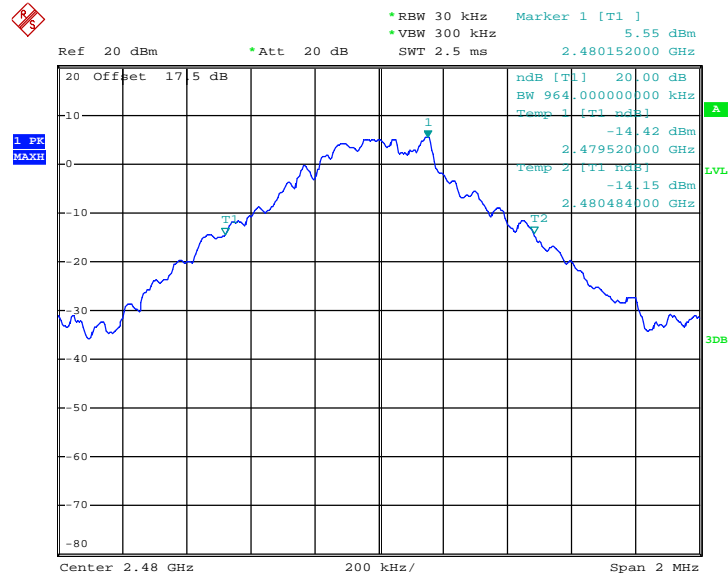

Date: 5.FEB.2013 10:06:20



Test Mode :	2Mbps	Temperature :	20~21°C
Test Engineer :	Zhi Lu	Relative Humidity :	40~41%

Channel	Frequency (MHz)	20dB Bandwidth (MHz)
00	2402	1.252
39	2441	1.256
78	2480	1.256

20 dB Bandwidth Plot on Channel 00

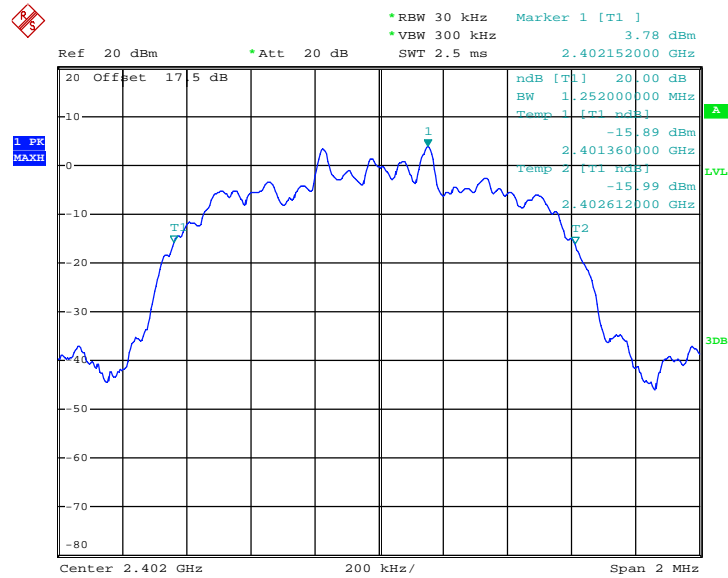

Date: 5.FEB.2013 10:09:49



20 dB Bandwidth Plot on Channel 39

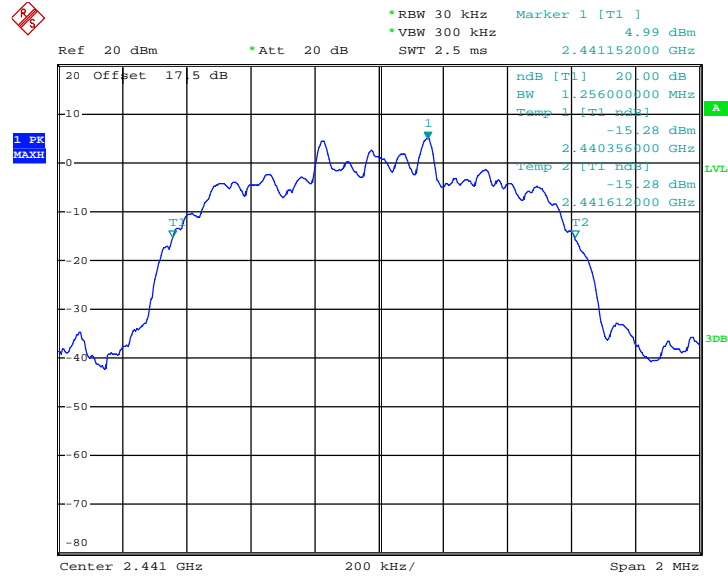

Date: 5.FEB.2013 10:10:25

20 dB Bandwidth Plot on Channel 78

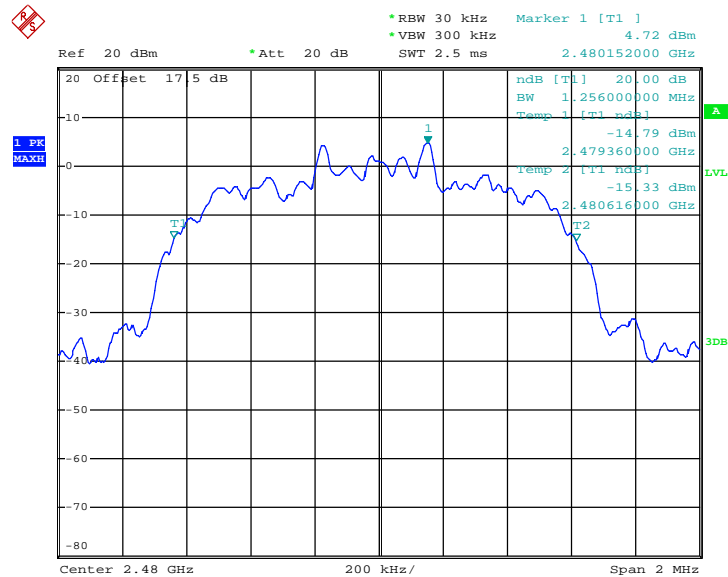

Date: 5.FEB.2013 10:11:01



Test Mode :	3Mbps	Temperature :	20~21°C
Test Engineer :	Zhi Lu	Relative Humidity :	40~41%

Channel	Frequency (MHz)	20dB Bandwidth (MHz)
00	2402	1.224
39	2441	1.220
78	2480	1.252

20 dB Bandwidth Plot on Channel 00

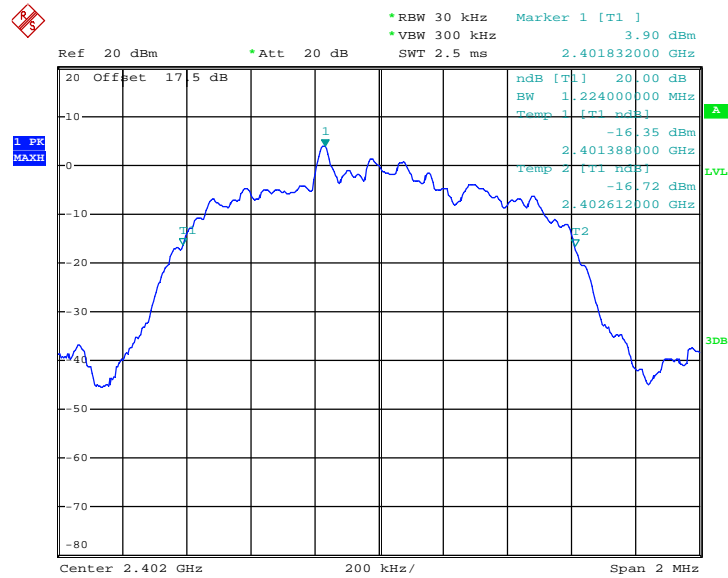

Date: 5.FEB.2013 10:12:35



20 dB Bandwidth Plot on Channel 39

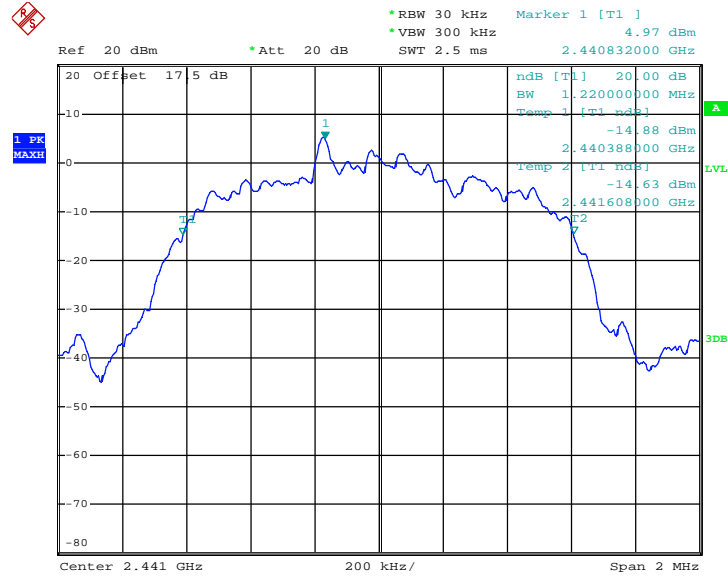

Date: 5.FEB.2013 10:12:01

20 dB Bandwidth Plot on Channel 78

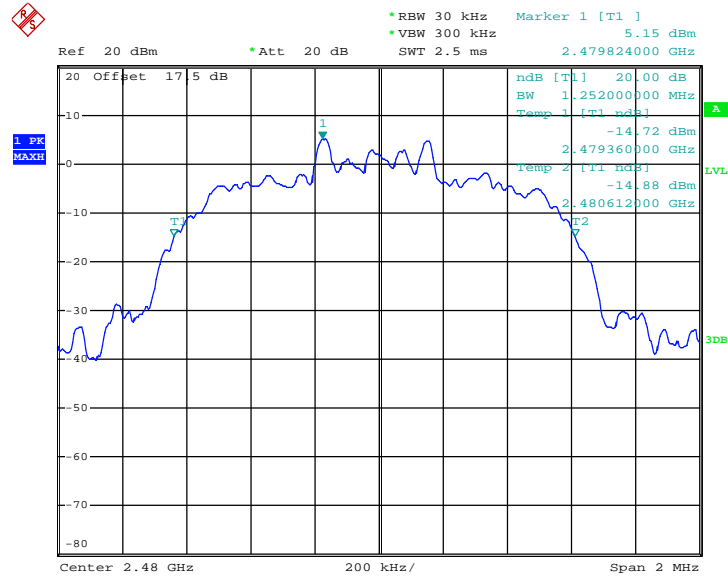

Date: 5.FEB.2013 10:11:29

3.5 Peak Output Power Measurement

3.5.1 Limit of Peak Output Power

Section 15.247 (b) The maximum peak conducted output power of the intentional radiator shall not exceed the following: (1) For frequency hopping systems operating in the 2400-2483.5 MHz band employing at least 75 non-overlapping hopping channels, and all frequency hopping systems in the 5725-5850 MHz band: 1 watt. For all other frequency hopping systems in the 2400-2483.5 MHz band 0.125 watts. The power limit for 1Mbps is 1watt, and for 2Mbps, and 3Mbps are 0.125 watts.

3.5.2 Measuring Instruments

See list of measuring instruments of this test report.

3.5.3 Test Procedures

1. The testing follows FCC Public Notice DA 00-705 Measurement Guidelines.
2. The RF output of EUT was connected to the spectrum analyzer by RF cable and attenuator. The path loss was compensated to the results for each measurement.
3. Set to the maximum power setting and enable the EUT transmit continuously.
4. Measure the conducted output power with cable loss and record the results in the test report.
5. Measure and record the results in the test report.

3.5.4 Test Setup

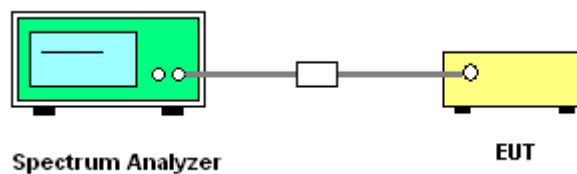



3.5.5 Test Result of Peak Output Power

Test Mode :	1Mbps	Temperature :	20~21°C
Test Engineer :	Zhi Lu	Relative Humidity :	40~41%

Channel	Frequency (MHz)	RF Power (dBm)		
		GFSK	Max. Limits (dBm)	Pass/Fail
		1 Mbps		
00	2402	7.60	30.00	Pass
39	2441	8.79	30.00	Pass
78	2480	8.78	30.00	Pass

Peak Output Power Plot on Channel 00

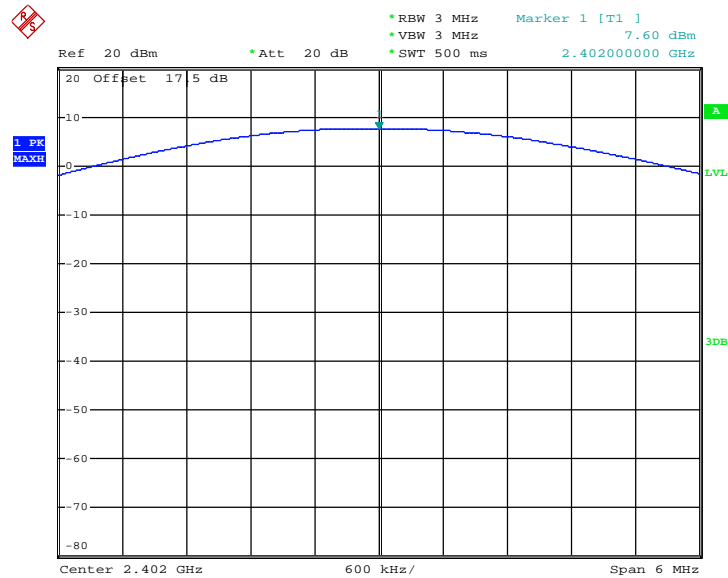

Date: 25.MAR.2013 14:16:18



Peak Output Power Plot on Channel 39

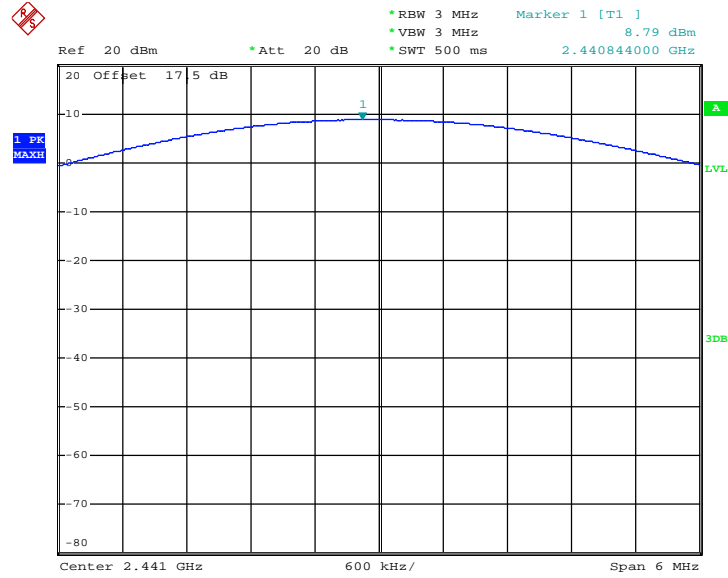

Date: 25.MAR.2013 14:16:43

Peak Output Power Plot on Channel 78

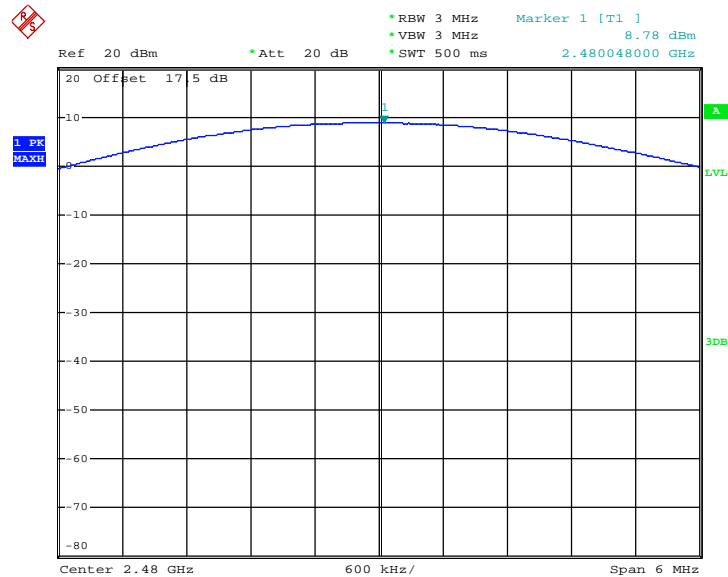

Date: 25.MAR.2013 14:17:05

3.6 Conducted Band Edges Measurement

3.6.1 Limit of Band Edges

In any 100 KHz bandwidth outside the intentional radiation frequency band, the radio frequency power shall be at least 20 dB below the highest level of the radiated power. In addition, radiated emissions which fall in the restricted bands must also comply with the radiated emission limits.

3.6.2 Measuring Instruments

See list of measuring instruments of this test report.

3.6.3 Test Procedures

1. The testing follows the guidelines in Band-edge Compliance of RF Conducted Emissions of FCC Public Notice DA 00-705 Measurement Guidelines.
2. Set to the maximum power setting and enable the EUT transmit continuously.
3. Set RBW = 300KHz ($\geq 1\%$ span=30MHz), VBW = 300KHz (\geq RBW). Band edge emissions must be at least 20 dB down from the highest emission level within the authorized band as measured with a 300KHz RBW. The attenuation shall be 30 dB instead of 20 dB when RMS conducted output power procedure is used.
4. Enable hopping function of the EUT and then repeat step 2. and 3.
5. Measure and record the results in the test report.

3.6.4 Test Setup

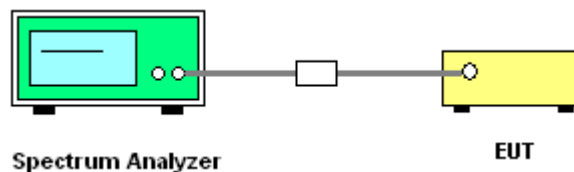



1.6.5 Test Result of Conducted Band Edges

Test Mode :	1Mbps	Temperature :	20~21°C
Test Channel :	00 and 78	Relative Humidity :	40~41%
		Test Engineer :	Zhi Lu

Low Band Edge Plot on Channel 00

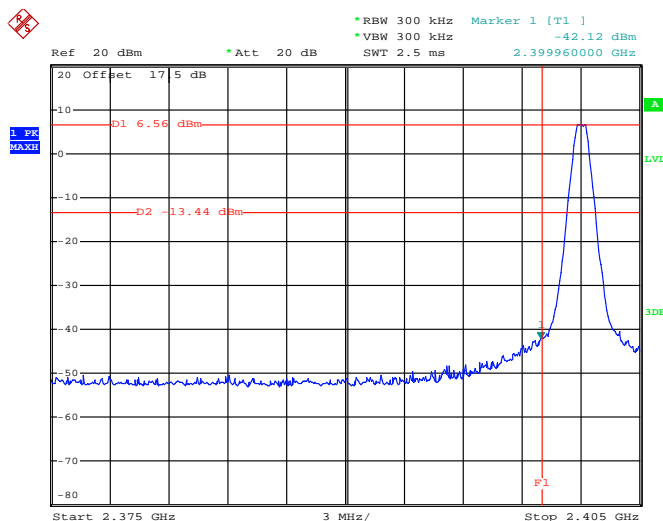

Date: 5.FEB.2013 09:15:59

High Band Edge Plot on Channel 78

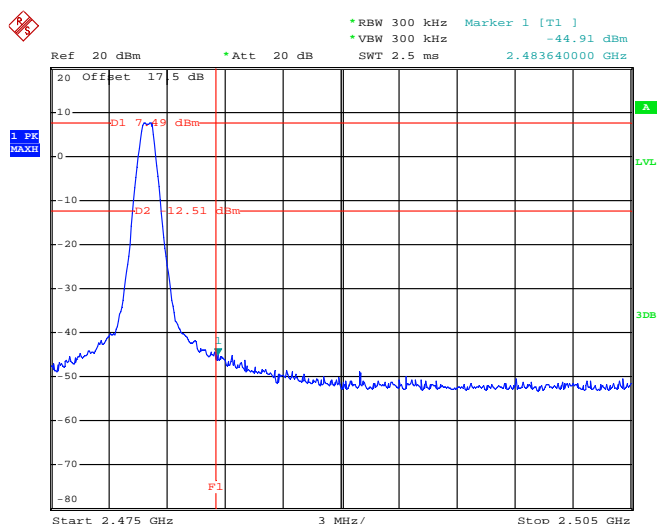

Date: 5.FEB.2013 09:22:19



Test Mode :	2Mbps	Temperature :	20~21°C
Test Channel :	00 and 78	Relative Humidity :	40~41%
		Test Engineer :	Zhi Lu

Low Band Edge Plot on Channel 00

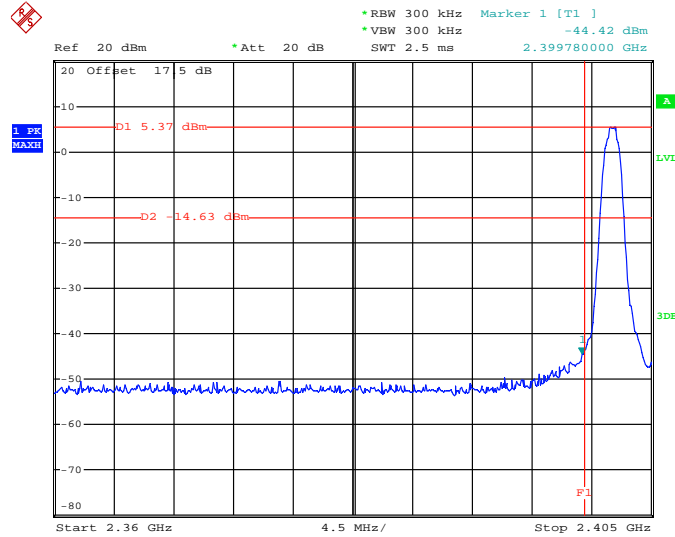

Date: 5.FEB.2013 09:26:51

High Band Edge Plot on Channel 78

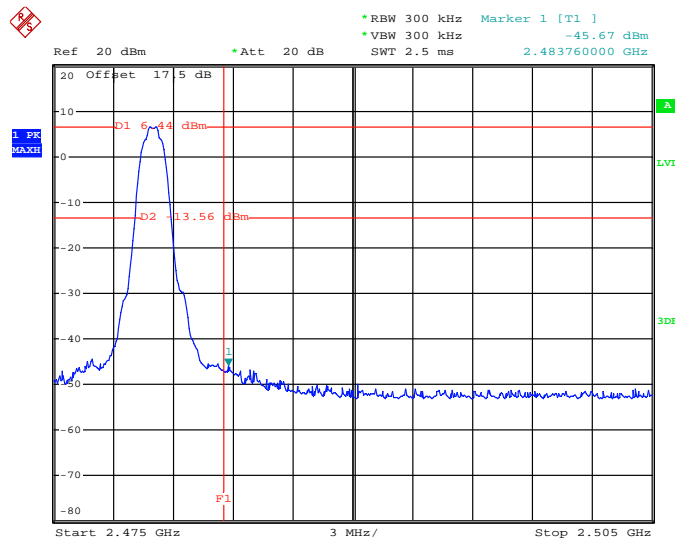

Date: 5.FEB.2013 09:23:56



Test Mode :	3Mbps	Temperature :	20~21°C
Test Channel :	00 and 78	Relative Humidity :	40~41%
		Test Engineer :	Zhi Lu

Low Band Edge Plot on Channel 00

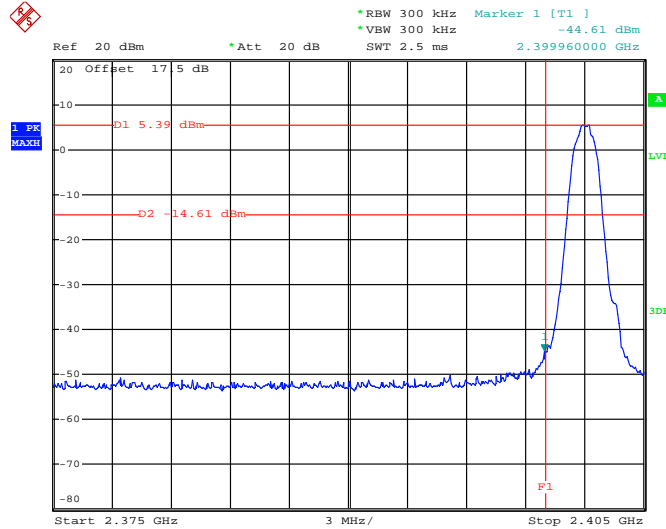

Date: 5.FEB.2013 09:29:26

High Band Edge Plot on Channel 78

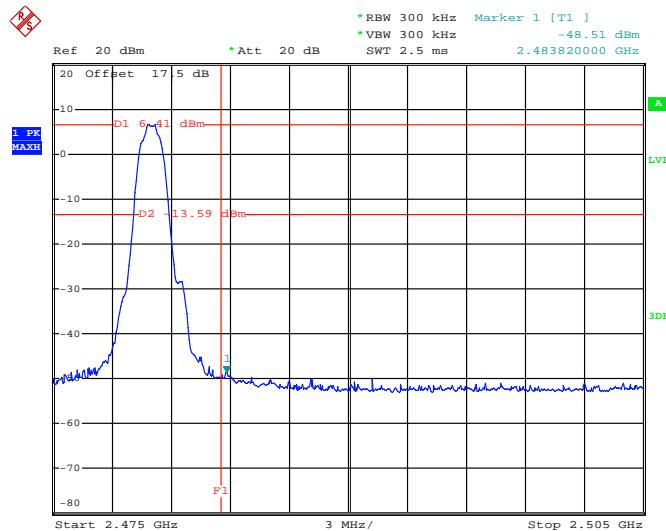

Date: 5.FEB.2013 09:32:50

1.6.6 Test Result of Conducted Hopping Mode Band Edges

Test Mode :	1Mbps	Temperature :	20~21°C
Test Engineer :	Zhi Lu	Relative Humidity :	40~41%

Hopping Mode Low Band Edge Plot on Channel 00

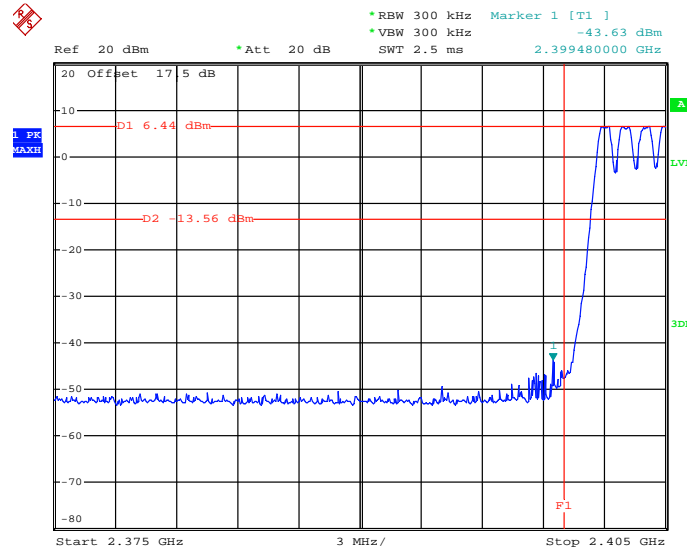

Date: 5.FEB.2013 09:50:17

Hopping Mode High Band Edge Plot on Channel 78

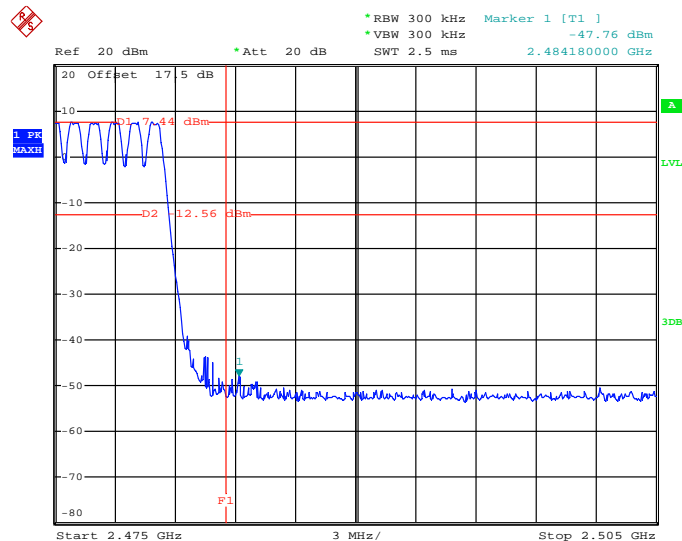

Date: 5.FEB.2013 09:47:27



Test Mode :	2Mbps	Temperature :	20~21°C
Test Engineer :	Zhi Lu	Relative Humidity :	40~41%

Hopping Mode Low Band Edge Plot on Channel 00

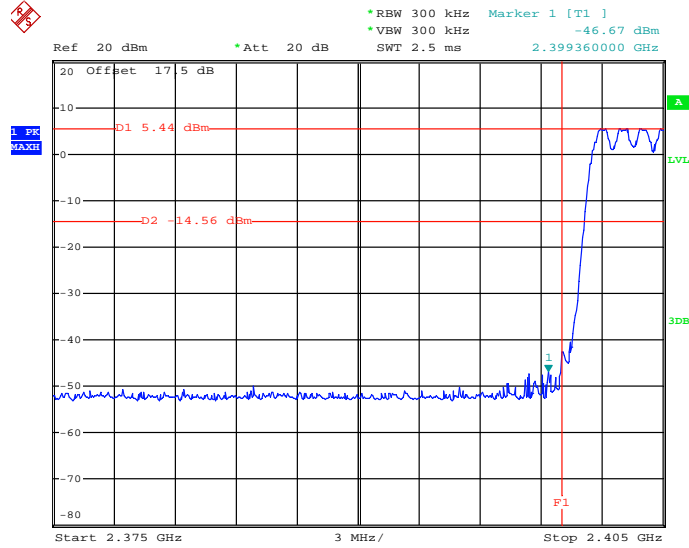

Date: 5.FEB.2013 09:41:36

Hopping Mode High Band Edge Plot on Channel 78

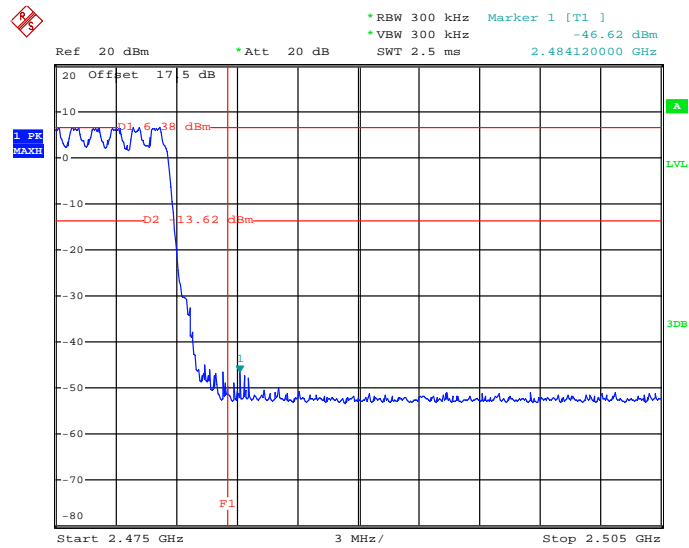

Date: 5.FEB.2013 09:45:31



Test Mode :	3Mbps	Temperature :	20~21°C
Test Engineer :	Zhi Lu	Relative Humidity :	40~41%

Hopping Mode Low Band Edge Plot on Channel 00

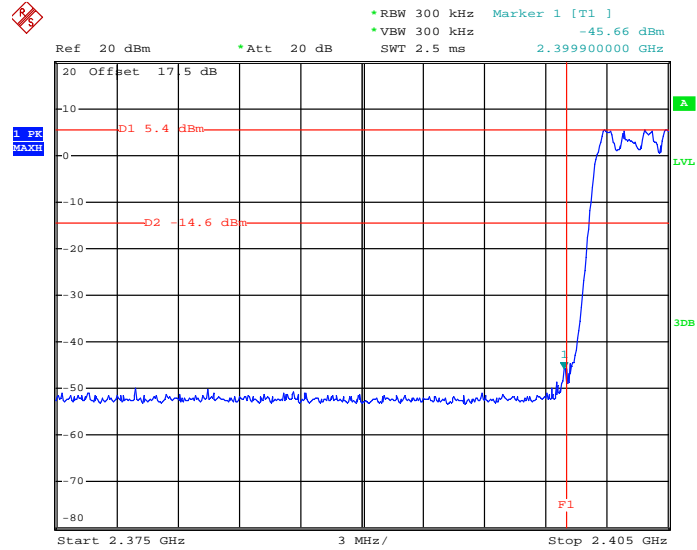

Date: 5.FEB.2013 09:38:02

Hopping Mode High Band Edge Plot on Channel 78

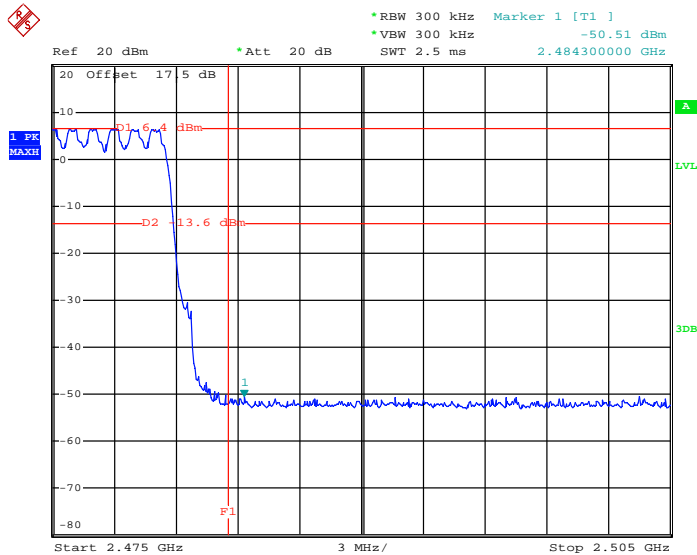

Date: 5.FEB.2013 09:35:36

3.7 Conducted Spurious Emission Measurement

3.7.1 Limit of Spurious Emission Measurement

In any 100 KHz bandwidth outside the intentional radiation frequency band, the radio frequency power shall be at least 20 dB below the highest level of the radiated power. In addition, radiated emissions which fall in the restricted bands must also comply with the radiated emission limits.

3.7.2 Measuring Instruments

See list of measuring instruments of this test report.

3.7.3 Test Procedure

1. The testing follows the guidelines in Spurious RF Conducted Emissions of FCC Public Notice DA 00-705 Measurement Guidelines
2. The RF output of EUT was connected to the spectrum analyzer by RF cable and attenuator. The path loss was compensated to the results for each measurement.
3. Set to the maximum power setting and enable the EUT transmit continuously.
4. Set RBW = 100 KHz, VBW = 300KHz, scan up through 10th harmonic. All harmonics / spurs must be at least 20 dB down from the highest emission level within the authorized band as measured with a 100 KHz RBW.
5. Measure and record the results in the test report.

3.7.4 Test Setup

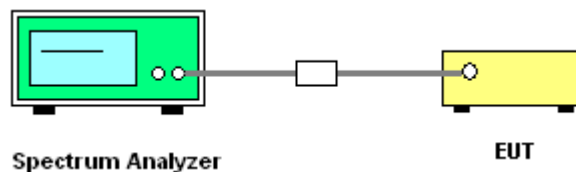



3.7.5 Test Results

Test Mode :	1Mbps	Temperature :	20~21°C
Test Channel :	00	Relative Humidity :	40~41%
		Test Engineer :	Zhi Lu

Conducted Spurious Emission Plot between 30MHz ~ 3 GHz

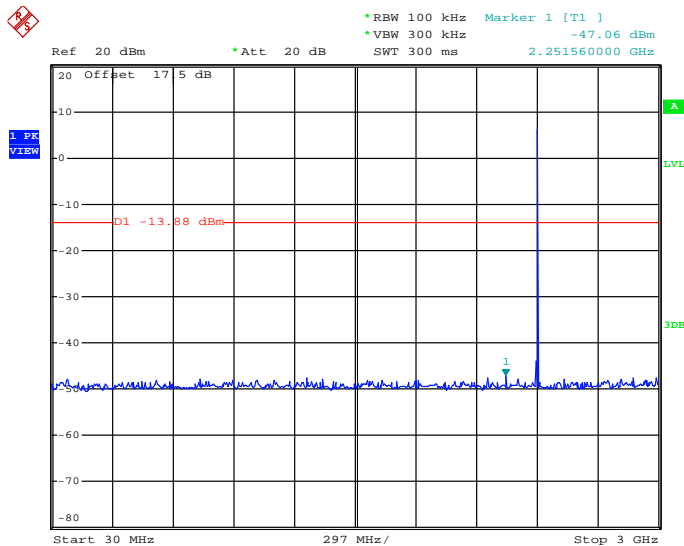

Date: 5.FEB.2013 11:29:20

Conducted Spurious Emission Plot between 2 GHz ~ 25 GHz

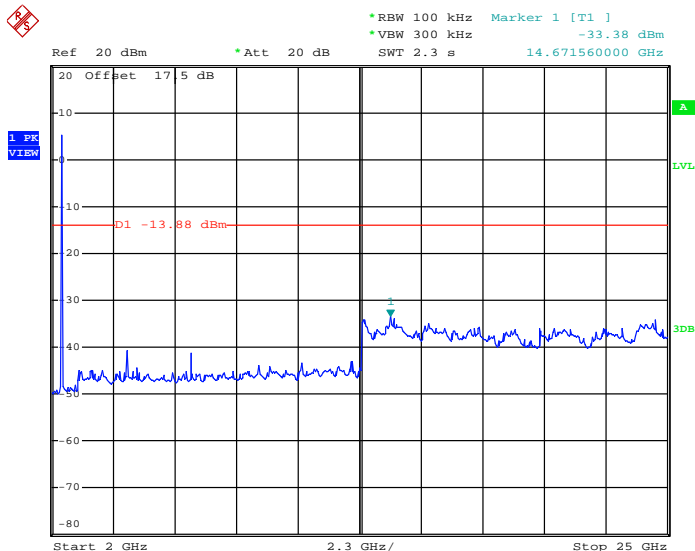

Date: 5.FEB.2013 11:31:02



Test Mode :	1Mbps	Temperature :	20~21°C
Test Channel :	39	Relative Humidity :	40~41%
		Test Engineer :	Zhi Lu

Conducted Spurious Emission Plot between 30MHz ~ 3 GHz

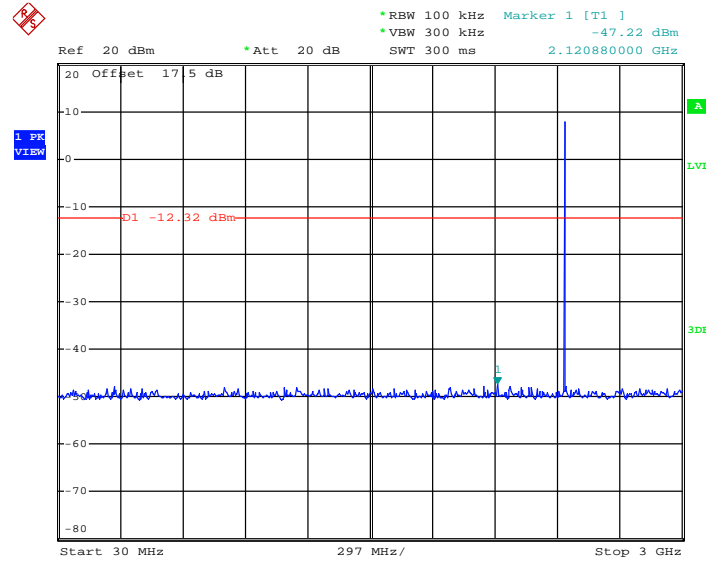

Date: 5.FEB.2013 11:40:16

Conducted Spurious Emission Plot between 2 GHz ~ 25 GHz

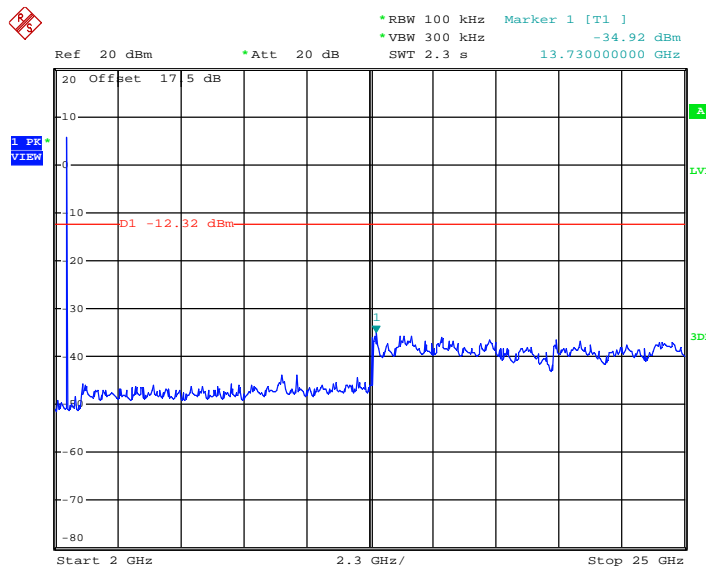

Date: 5.FEB.2013 11:43:46



Test Mode :	1Mbps	Temperature :	20~21°C
Test Channel :	78	Relative Humidity :	40~41%
		Test Engineer :	Zhi Lu

Conducted Spurious Emission Plot between 30MHz ~ 3 GHz

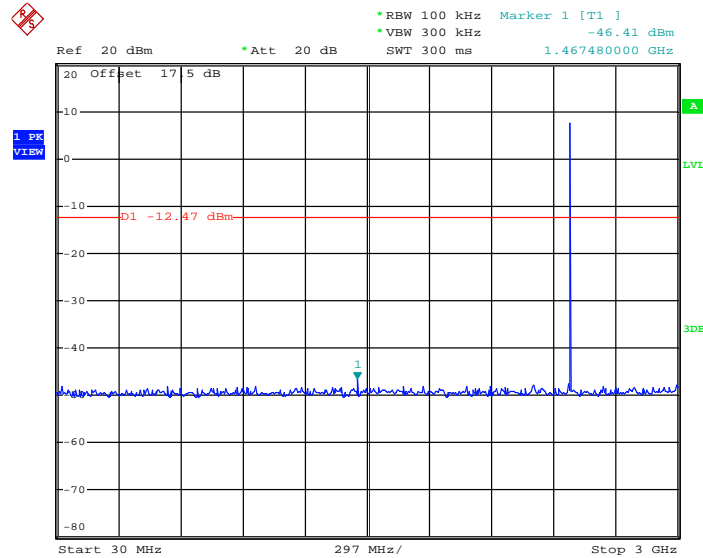

Date: 5.FEB.2013 11:37:59

Conducted Spurious Emission Plot between 2 GHz ~ 25 GHz

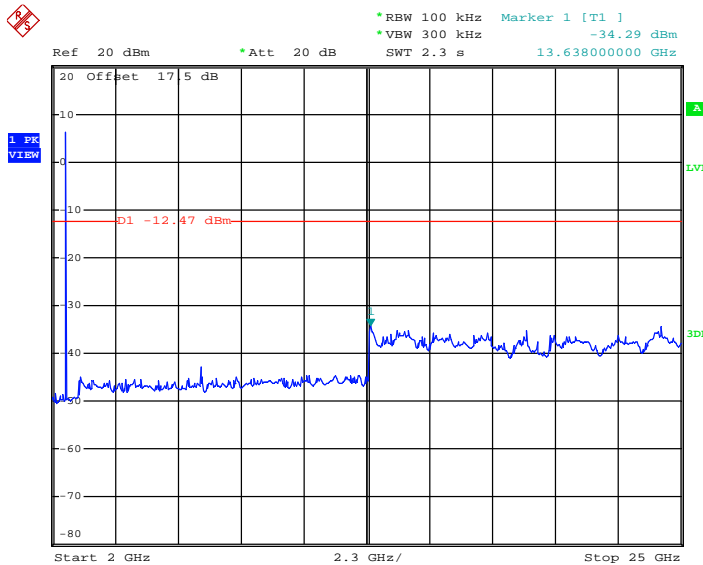

Date: 5.FEB.2013 11:38:56

3.8 Radiated Band Edges and Spurious Emission Measurement

3.8.1 Limit of Radiated Band Edges and Spurious Emission

In any 100 KHz bandwidth outside the intentional radiator frequency band, all harmonics/spurious must be at least 20 dB below the highest emission level within the authorized band. In addition, radiated emissions which fall in the restricted bands must also comply with the FCC section 15.209 limits as below.

Frequency (MHz)	Field Strength (microvolts/meter)	Measurement Distance (meters)
0.009 – 0.490	2400/F(KHz)	300
0.490 – 1.705	24000/F(KHz)	30
1.705 – 30.0	30	30
30 – 88	100	3
88 – 216	150	3
216 - 960	200	3
Above 960	500	3

3.8.2 Measuring Instruments

See list of measuring instruments of this test report.

3.8.3 Test Procedures

1. The testing follows the guidelines in Spurious Radiated Emissions of FCC Public Notice DA 00-705 Measurement Guidelines and fulfills ANSI C63.4-2003 and the guidelines in ANSI C63.10-2009 test site requirement.
2. The EUT was placed on a turntable with 0.8 meter above ground.
3. The EUT was set 3 meters from the interference receiving antenna, which was mounted on the top of a variable height antenna tower.
4. For each suspected emission, the EUT was arranged to its worst case and then tune the Antenna tower (from 1 m to 4 m) and turntable (from 0 degree to 360 degrees) to find the maximum reading. A pre-amp and a high pass filter are used for the test in order to get better signal level to comply with the guidelines.
5. Set to the maximum power setting and enable the EUT transmit continuously.
6. For measurement below 1GHz, If the emission level of the EUT measured by the peak detector is 3 dB lower than the applicable limit, the peak emission level will be reported. Otherwise, the emission measurement will be repeated using the quasi-peak detector and reported
7. Use the following spectrum analyzer settings:
 - (1) Span shall wide enough to fully capture the emission being measured;
 - (2) Set RBW=100 KHz for $f < 1$ GHz, RBW=1MHz for $f > 1$ GHz ; VBW \geq RBW; Sweep = auto; Detector function = peak; Trace = max hold for peak
 - (3) For average measurement: use duty cycle correction factor method per 15.35(c).
Duty cycle = On time/100 milliseconds
On time = $N_1 * L_1 + N_2 * L_2 + \dots + N_{n-1} * L_{n-1} + N_n * L_n$
Where N_1 is number of type 1 pulses, L_1 is length of type 1 pulses, etc.
Average Level = Peak Level + $20 * \log(\text{Duty cycle})$
8. Corrected Reading: Antenna Factor + Cable Loss + Read Level - Preamp Factor = Level

Note: The average levels were calculated from the peak level corrected with duty cycle correction factor (24.79dB) derived from $20 \log(\text{dwell time}/100\text{ms})$.

3.8.4 Test Setup

For radiated emissions below 30MHz

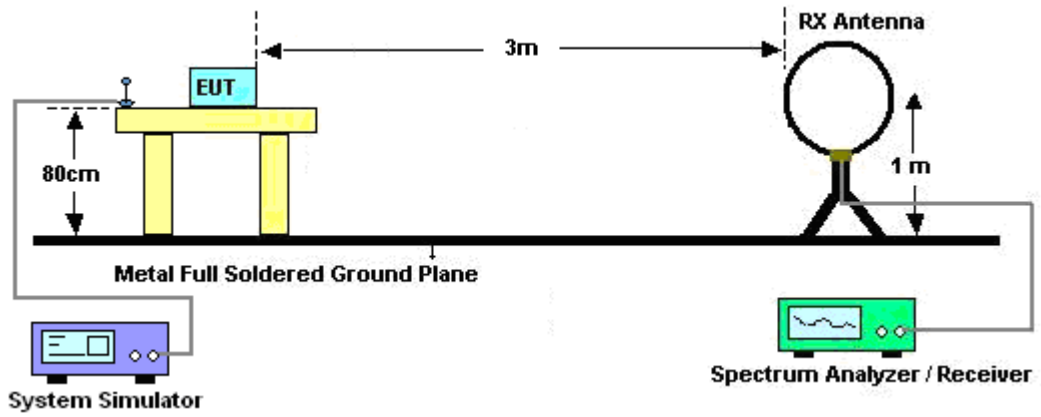

For radiated emissions from 30MHz to 1GHz

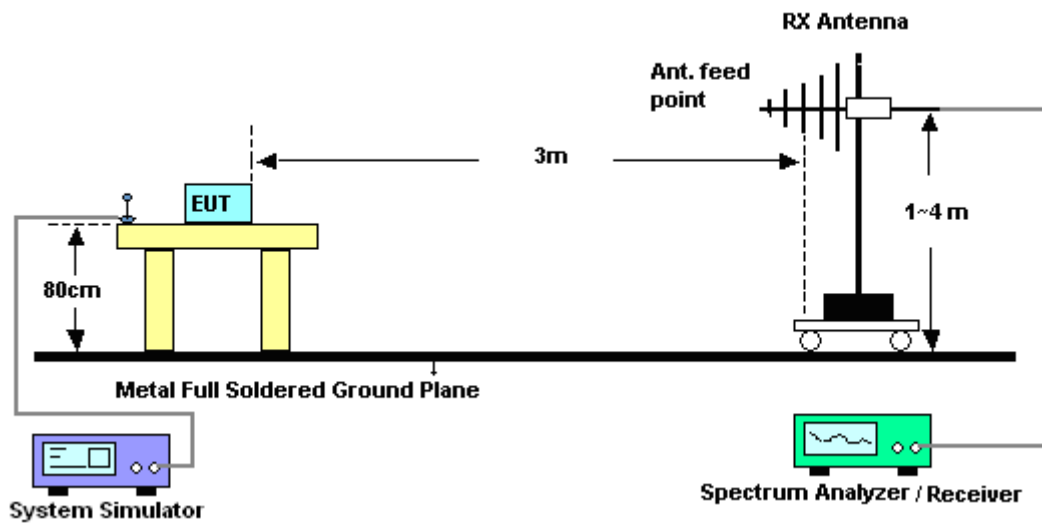

For radiated emissions above 1GHz

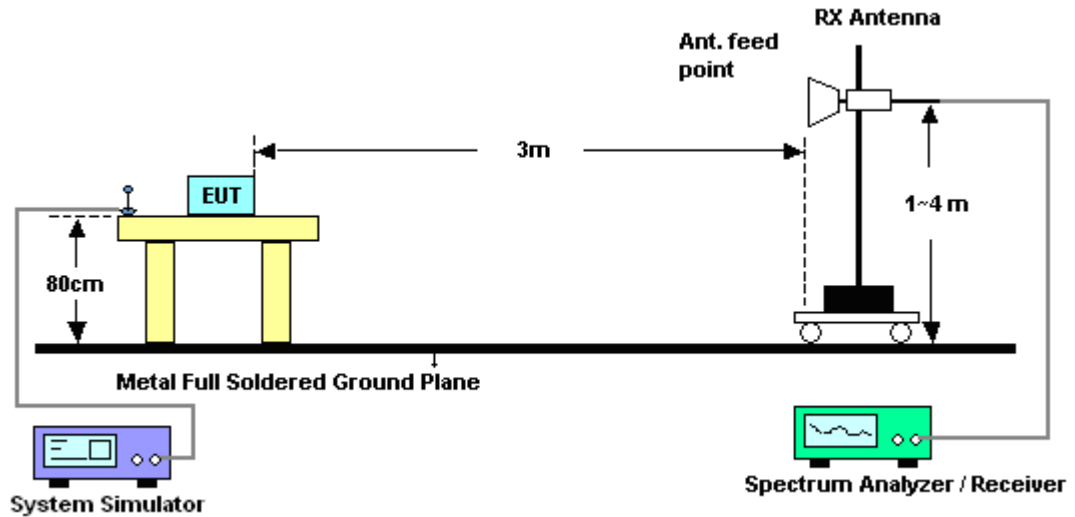

3.8.5 Test Results of Radiated Emissions (9 KHz ~ 30 MHz)

The low frequency, which started from 9 KHz to 30MHz, was pre-scanned and the result which was 20dB lower than the limit line per 15.31(o) was not reported.

3.8.6 Duty cycle correction factor for average measurement

DH5 on time/100ms (One Pulse) Plot on Channel 39

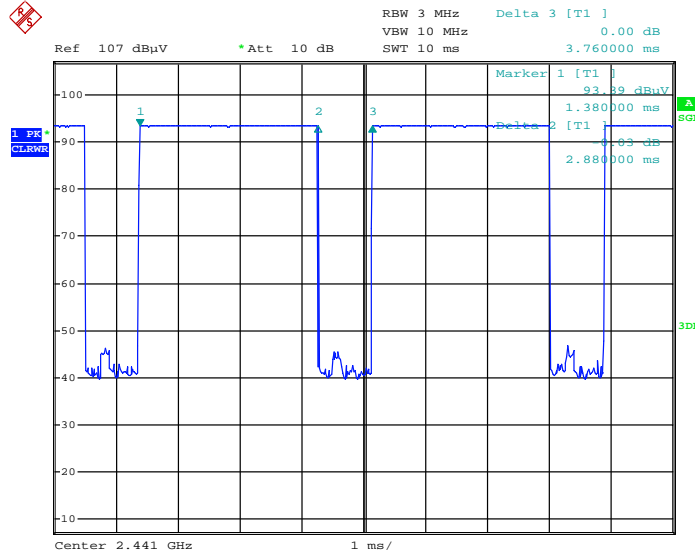

Date: 22.MAR.2013 19:11:45

DH5 on time/100ms (Count Pulses) Plot on Channel 39

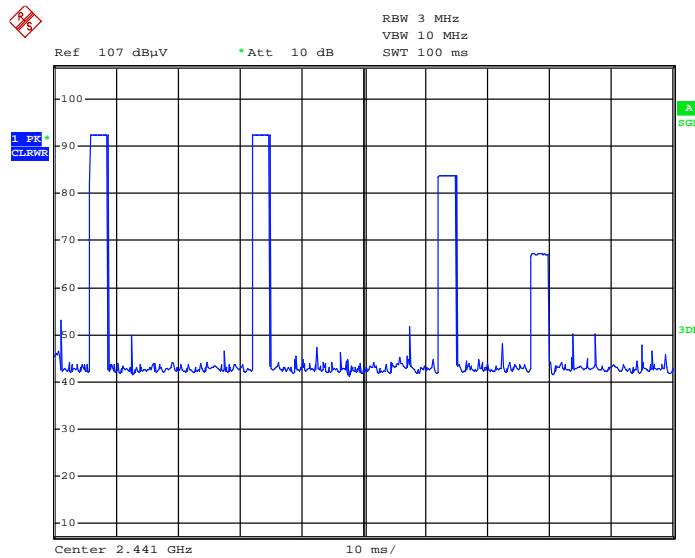

Date: 22.MAR.2013 19:12:24

Note:

1. Duty cycle = on time/100 milliseconds = $2 * 2.88 / 100 = 5.76 \%$
2. Duty cycle correction factor = $20 * \log(\text{Duty cycle}) = -24.79 \text{ dB}$
3. DH5 has the highest duty cycle and is reported.



3.8.7 Test Result of Radiated Band Edges

Test Mode :	1Mbps	Temperature :	20~22°C
Test Channel :	00	Relative Humidity :	41~43%
		Test Engineer :	Jun Liu

ANTENNA POLARITY : HORIZONTAL										
Frequency (MHz)	Level (dBμV/m)	Over Limit (dB)	Limit Line (dBμV/m)	Read Level (dBμV)	Antenna Factor (dB)	Cable Loss (dB)	Preamp Factor (dB)	Ant Pos (cm)	Table Pos (deg)	Remark
2376.42	52.42	-21.58	74	49.02	32.82	2.09	31.51	100	170	Peak
2376.42	27.63	-26.37	54	-	-	-	-	-	-	Average

ANTENNA POLARITY : VERTICAL										
Frequency (MHz)	Level (dBμV/m)	Over Limit (dB)	Limit Line (dBμV/m)	Read Level (dBμV)	Antenna Factor (dB)	Cable Loss (dB)	Preamp Factor (dB)	Ant Pos (cm)	Table Pos (deg)	Remark
2383.89	51.95	-22.05	74	48.55	32.82	2.09	31.51	114	85	Peak
2383.89	27.16	-26.84	54	-	-	-	-	-	-	Average

Note: The average levels were calculated from the peak level corrected with duty cycle correction factor (24.79dB) derived from 20log (dwell time/100ms).

For example: Average level = 52.42dBuV/m – 24.79 (dB) = 27.63dBuV/m.

Test Mode :	1Mbps	Temperature :	20~22°C
Test Channel :	78	Relative Humidity :	41~43%
		Test Engineer :	Jun Liu

ANTENNA POLARITY : HORIZONTAL										
Frequency (MHz)	Level (dBμV/m)	Over Limit (dB)	Limit Line (dBμV/m)	Read Level (dBμV)	Antenna Factor (dB)	Cable Loss (dB)	Preamp Factor (dB)	Ant Pos (cm)	Table Pos (deg)	Remark
2483.5	65.85	-8.15	74	62.2	33.01	2.15	31.51	160	150	Peak
2483.5	41.06	-12.94	54	-	-	-	-	-	-	Average

ANTENNA POLARITY : VERTICAL										
Frequency (MHz)	Level (dBμV/m)	Over Limit (dB)	Limit Line (dBμV/m)	Read Level (dBμV)	Antenna Factor (dB)	Cable Loss (dB)	Preamp Factor (dB)	Ant Pos (cm)	Table Pos (deg)	Remark
2483.5	62.87	-11.13	74	59.22	33.01	2.15	31.51	120	60	Peak
2483.5	38.08	-15.92	54	-	-	-	-	-	-	Average

3.8.8 Test Result of Radiated Emission (30 MHz ~ 10th Harmonic)

NOTE: Below 1GHz for radiated emission measurement, pre-scanned all test modes and only choose the worst case mode was recorded in the report.

Test Mode :	1Mbps	Temperature :	20~22°C
Test Channel :	00	Relative Humidity :	41~43%
Test Engineer :	Jun Liu	Polarization :	Horizontal
Remark :	1. 2402 MHz is fundamental signal which can be ignored. 2. 2399 MHz and 7206 MHz are not within a restricted bands, and its limit lines are 20dB below the highest emission level. For example, 104.67 dBuV/m - 20dB = 84.67 dBuV/m.		

Frequency (MHz)	Level (dBμV/m)	Over Limit (dB)	Limit Line (dBμV/m)	Read Level (dBμV)	Antenna Factor (dB)	Cable Loss (dB)	Preamp Factor (dB)	Ant Pos (cm)	Table Pos (deg)	Remark
2399	72.66	-12.01	84.67	69.22	32.85	2.1	31.51	100	171	Peak
2402	104.67	-	-	101.23	32.85	2.1	31.51	100	171	Peak
2402	79.88	-	-	-	-	-	-	100	171	Average
4804	54.7	-19.3	74	48.01	35.16	3.07	31.54	100	128	Peak
4804	29.91	-24.09	54	-	-	-	-	100	128	Average
7206	72.74	-11.93	84.67	64.32	36.15	3.23	30.96	100	227	Peak

Note: Other harmonics are lower than background noise.



Test Mode :	1Mbps	Temperature :	20~22°C
Test Channel :	00	Relative Humidity :	41~43%
Test Engineer :	Jun Liu	Polarization :	Vertical
Remark :	1. 2402 MHz is fundamental signal which can be ignored. 2. 2399 MHz and 7206 MHz are not within a restricted bands, and its limit lines are 20dB below the highest emission level.		

Frequency (MHz)	Level (dBμV/m)	Over Limit (dB)	Limit Line (dBμV/m)	Read Level (dBμV)	Antenna Factor (dB)	Cable Loss (dB)	Preamp Factor (dB)	Ant Pos (cm)	Table Pos (deg)	Remark
2399	69.86	-11.62	81.48	66.42	32.85	2.1	31.51	114	86	Peak
2402	101.48	-	-	98.04	32.85	2.1	31.51	114	86	Peak
2402	76.69	-	-	-	-	-	-	114	86	Average
4804	56.35	-17.65	74	49.66	35.16	3.07	31.54	102	35	Peak
4804	31.56	-22.44	54	-	-	-	-	102	35	Average
7206	65.33	-16.15	81.48	56.91	36.15	3.23	30.96	100	177	Peak

Note: Other harmonics are lower than background noise.



Test Mode :	1Mbps	Temperature :	20~22°C
Test Channel :	39	Relative Humidity :	41~43%
Test Engineer :	Jun Liu	Polarization :	Horizontal
Remark :	1. 2441 MHz is fundamental signal which can be ignored. 2. Average measurement was not performed if peak level went lower than the average limit.		

Frequency (MHz)	Level (dBμV/m)	Over Limit (dB)	Limit Line (dBμV/m)	Read Level (dBμV)	Antenna Factor (dB)	Cable Loss (dB)	Preamp Factor (dB)	Ant Pos (cm)	Table Pos (deg)	Remark
40.845	16.23	-23.77	40	37.85	11.63	0.38	33.63	-	-	Peak
59.859	20.01	-19.99	40	47.83	5.29	0.47	33.58	-	-	Peak
102.001	29.1	-14.4	43.5	51.39	10.75	0.57	33.61	100	124	Peak
244.232	29.16	-16.84	46	49.98	11.72	0.9	33.44	-	-	Peak
327.887	24.52	-21.48	46	42.98	13.86	1.04	33.36	-	-	Peak
414.722	23.82	-22.18	46	39.87	16.07	1.15	33.27	-	-	Peak
2441	106.04	-	-	102.48	32.94	2.13	31.51	100	143	Peak
2441	81.25	-	-	-	-	-	-	100	143	Average
4882	53.06	-20.94	74	46.29	35.18	3.11	31.52	100	199	Peak
7323	73.55	-0.45	74	65.09	36.2	3.2	30.94	107	199	Peak
7323	48.76	-5.24	54	-	-	-	-	107	199	Average

Note: Other harmonics are lower than background noise.



Test Mode :	1Mbps	Temperature :	20~22°C
Test Channel :	39	Relative Humidity :	41~43%
Test Engineer :	Jun Liu	Polarization :	Vertical
Remark :	1. 2441 MHz is fundamental signal which can be ignored. 2. Average measurement was not performed if peak level went lower than the average limit.		

Frequency (MHz)	Level (dBμV/m)	Over Limit (dB)	Limit Line (dBμV/m)	Read Level (dBμV)	Antenna Factor (dB)	Cable Loss (dB)	Preamp Factor (dB)	Ant Pos (cm)	Table Pos (deg)	Remark
59.859	19.69	-20.31	40	47.51	5.29	0.47	33.58	-	-	Peak
99.878	26.59	-16.91	43.5	49.14	10.49	0.57	33.61	-	-	Peak
103.442	27.61	-15.89	43.5	49.63	11.01	0.58	33.61	200	122	Peak
119.856	26.83	-16.67	43.5	48.01	11.79	0.62	33.59	-	-	Peak
298.268	26.34	-19.66	46	45.76	12.97	0.98	33.37	-	-	Peak
407.515	26.35	-19.65	46	42.46	16.03	1.15	33.29	-	-	Peak
2441	102.26	-	-	98.7	32.94	2.13	31.51	117	25	Peak
2441	77.47	-	-	-	-	-	-	117	25	Average
4882	53.92	-20.08	74	47.15	35.18	3.11	31.52	100	107	Peak
7323	66.12	-7.88	74	57.66	36.2	3.2	30.94	100	277	Peak
7323	41.33	-12.67	54	-	-	-	-	100	277	Average

Note: Other harmonics are lower than background noise.



Test Mode :	1Mbps	Temperature :	20~22°C
Test Channel :	78	Relative Humidity :	41~43%
Test Engineer :	Jun Liu	Polarization :	Horizontal
Remark :	1. 2480 MHz is fundamental signal which can be ignored. 2. Average measurement was not performed if peak level went lower than the average limit.		

Frequency (MHz)	Level (dBμV/m)	Over Limit (dB)	Limit Line (dBμV/m)	Read Level (dBμV)	Antenna Factor (dB)	Cable Loss (dB)	Preamp Factor (dB)	Ant Pos (cm)	Table Pos (deg)	Remark
2480	104.4	-	-	100.75	33.01	2.15	31.51	156	162	Peak
2480	79.61	-	-	-	-	-	-	100	353	Average
4960	53.44	-20.56	74	46.61	35.19	3.15	31.51	142	69	Peak
7440	70.35	-3.65	74	61.84	36.26	3.17	30.92	122	225	Peak
7440	45.56	-8.44	54	-	-	-	-	122	225	Average

Note: Other harmonics are lower than background noise.



Test Mode :	1Mbps	Temperature :	20~22°C
Test Channel :	78	Relative Humidity :	41~43%
Test Engineer :	Jun Liu	Polarization :	Vertical
Remark :	2480 MHz is fundamental signal which can be ignored.		

Frequency (MHz)	Level (dBμV/m)	Over Limit (dB)	Limit Line (dBμV/m)	Read Level (dBμV)	Antenna Factor (dB)	Cable Loss (dB)	Preamp Factor (dB)	Ant Pos (cm)	Table Pos (deg)	Remark
2480	102.44	-	-	98.79	33.01	2.15	31.51	127	65	Peak
2480	77.65	-	-	-	-	-	-	127	65	Average
4960	54.26	-19.74	74	47.43	35.19	3.15	31.51	148	81	Peak
4960	29.47	-24.53	54	-	-	-	-	148	81	Average
7440	63.95	-10.05	74	55.44	36.26	3.17	30.92	108	90	Peak
7440	39.16	-14.84	54	-	-	-	-	108	90	Average

Note: Other harmonics are lower than background noise.

3.9 AC Conducted Emission Measurement

3.9.1 Limit of AC Conducted Emission

For equipment that is designed to be connected to the public utility (AC) power line, the radio frequency voltage that is conducted back onto the AC power line on any frequency or frequencies within the band 150 KHz to 30 MHz shall not exceed the limits in the following table.

Frequency of emission (MHz)	Conducted limit (dBuV)	
	Quasi-peak	Average
0.15-0.5	66 to 56*	56 to 46*
0.5-5	56	46
5-30	60	50

*Decreases with the logarithm of the frequency.

3.9.2 Measuring Instruments

See list of measuring instruments of this test report.

3.9.3 Test Procedures

1. The test follows the guidelines in ANSI C63.10-2009 test site requirement.
2. The EUT was placed 0.4 meter from the conducting wall of the shielding room was kept at least 80 centimeters from any other grounded conducting surface.
3. Connect EUT to the power mains through a line impedance stabilization network (LISN).
4. All the support units are connecting to the other LISN.
5. The LISN provides 50 ohm coupling impedance for the measuring instrument.
6. The FCC states that a 50 ohm, 50 microhenry LISN should be used.
7. Both sides of AC line were checked for maximum conducted interference.
8. The frequency range from 150 KHz to 30 MHz was searched.
9. Set the test-receiver system to Peak Detect Function and specified bandwidth with Maximum Hold Mode.

3.9.4 Test Setup

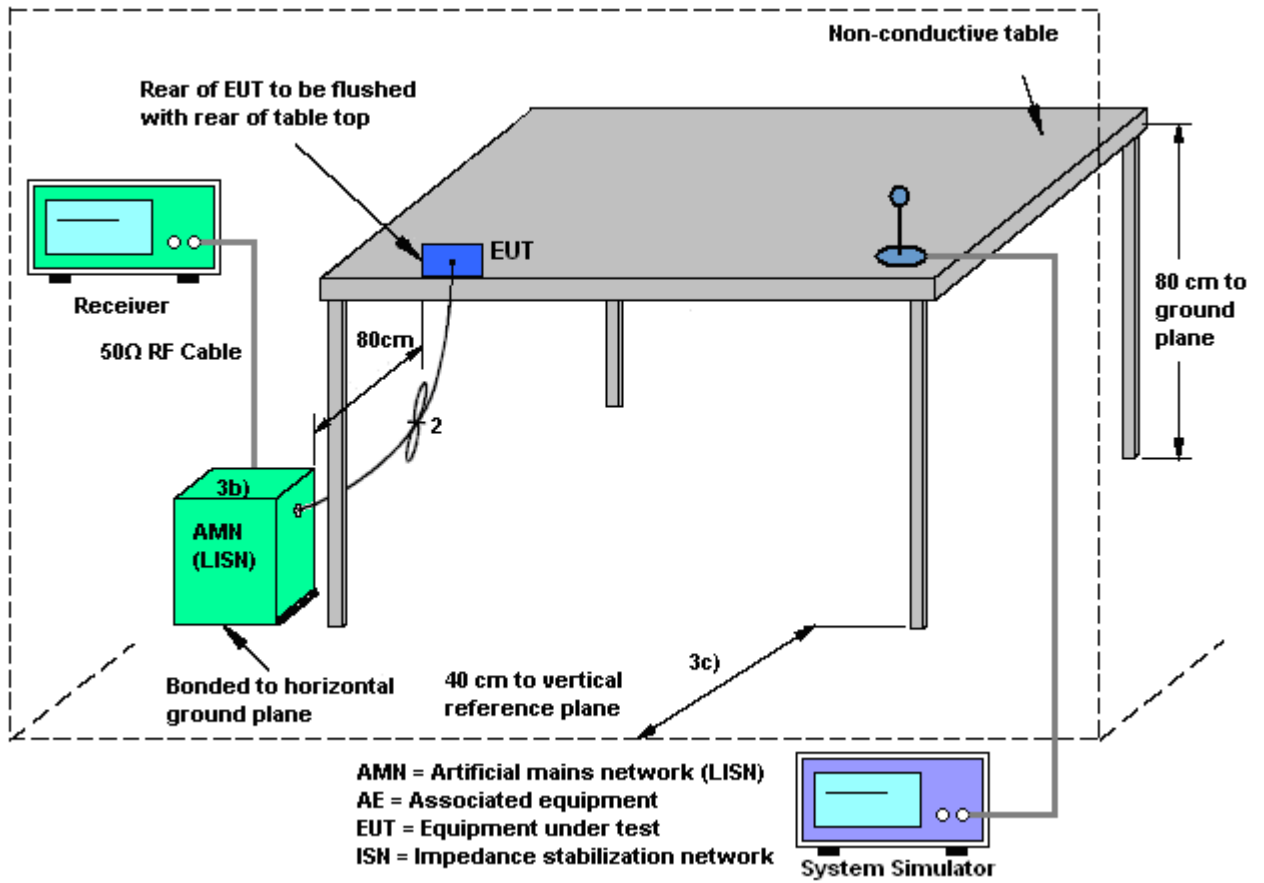



3.9.5 Test Result of AC Conducted Emission

Test Mode :	Mode 1	Temperature :	19~20°C
Test Engineer :	Tom Wang	Relative Humidity :	39~40%
Test Voltage :	120Vac / 60Hz	Phase :	Line
Function Type :	GSM850 Idle + Bluetooth Link + USB Cable (Charging from Adapter) + Earphone		
Remark :	All emissions not reported here are more than 10 dB below the prescribed limit.		

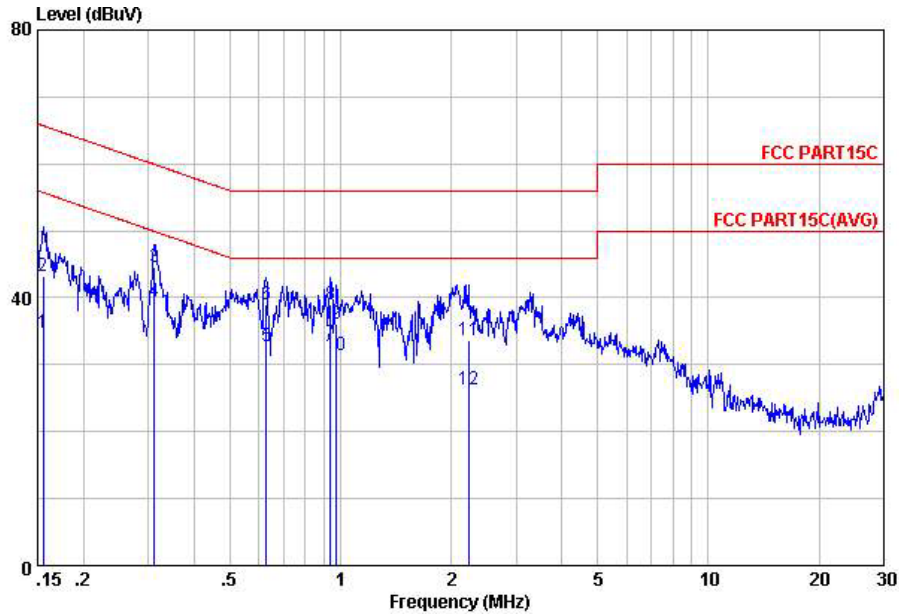

Site : C001-KS
 Condition: FCC PART15C LISN-L20130306 LINE
 Project : (FR) 312402
 mode : Mode 1

	Freq	Level	Over	Limit	Read	LISN	Cable	Remark
	MHz	dBuV	Limit	Line	Level	Factor	Loss	
			dB	dBuV	dBuV	dB	dB	
1	0.16	34.66	-21.03	55.69	22.60	1.86	10.20	Average
2	0.16	43.26	-22.43	65.69	31.20	1.86	10.20	QP
3	0.31	44.56	-15.37	59.93	33.70	0.62	10.24	QP
4	0.31	39.36	-10.57	49.93	28.50	0.62	10.24	Average
5	0.63	32.76	-13.24	46.00	22.30	0.20	10.26	Average
6	0.63	39.06	-16.94	56.00	28.60	0.20	10.26	QP
7	0.94	33.29	-12.71	46.00	22.90	0.11	10.28	Average
8	0.94	38.99	-17.01	56.00	28.60	0.11	10.28	QP
9	0.97	36.18	-19.82	56.00	25.80	0.10	10.28	QP
10	0.97	31.48	-14.52	46.00	21.10	0.10	10.28	Average
11	2.22	33.61	-22.39	56.00	23.20	0.11	10.30	QP
12	2.22	26.31	-19.69	46.00	15.90	0.11	10.30	Average



Test Mode :	Mode 1	Temperature :	19~20°C
Test Engineer :	Tom Wang	Relative Humidity :	39~40%
Test Voltage :	120Vac / 60Hz	Phase :	Neutral
Function Type :	GSM850 Idle + Bluetooth Link + USB Cable (Charging from Adapter) + Earphone		
Remark :	All emissions not reported here are more than 10 dB below the prescribed limit.		

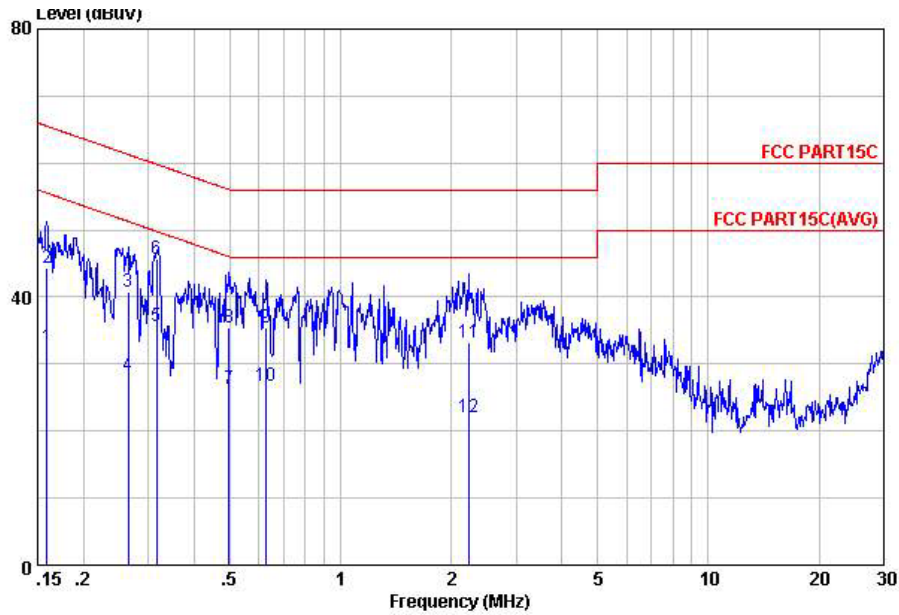

Site : C001-KS
 Condition: FCC PART15C LISN-N20130306 NEUTRAL
 Project : (FR) 312402
 mode : Mode 1

	Freq	Level	Over	Limit	Read	LISN	Cable	Remark
	MHz	dBuV	Limit	Line	Level	Factor	Loss	
			dB	dBuV	dBuV	dB	dB	
1	0.16	32.56	-22.96	55.52	20.60	1.76	10.20	Average
2	0.16	44.36	-21.16	65.52	32.40	1.76	10.20	QP
3	0.26	40.68	-20.61	61.29	29.60	0.85	10.23	QP
4	0.26	28.28	-23.01	51.29	17.20	0.85	10.23	Average
5	0.32	35.68	-14.12	49.80	24.80	0.64	10.24	Average
6	0.32	45.68	-14.12	59.80	34.80	0.64	10.24	QP
7	0.50	26.36	-19.69	46.05	15.81	0.30	10.25	Average
8	0.50	35.46	-20.59	56.05	24.91	0.30	10.25	QP
9	0.63	35.39	-20.61	56.00	24.90	0.23	10.26	QP
10	0.63	26.69	-19.31	46.00	16.20	0.23	10.26	Average
11	2.22	33.21	-22.79	56.00	22.80	0.11	10.30	QP
12	2.22	22.01	-23.99	46.00	11.60	0.11	10.30	Average



3.10 Antenna Requirements

3.10.1 Standard Applicable

If directional gain of transmitting antennas is greater than 6dBi, the power shall be reduced by the same level in dB comparing to gain minus 6dBi. The use of a permanently attached antenna or of an antenna that uses a unique coupling to the intentional radiator shall be considered sufficient to comply with the FCC rule.

3.10.2 Antenna Connected Construction

Non-standard connector used.

3.10.3 Antenna Gain

The antenna peak gain of EUT is less than 6 dBi. Therefore, it is not necessary to reduce maximum peak output power limit.



4 List of Measuring Equipment

Instrument	Manufacturer	Model No.	Serial No.	Characteristics	Calibration Date	Test Date	Due Date	Remark
Spectrum Analyzer	R&S	FSP40	100319	9kHz~40GHz	Dec. 29, 2012	Feb. 04, 2013~ Mar. 25, 2013	Dec. 28, 2013	Conducted (TH01-KS)
Power Meter	Agilent	E4416A	MY45101555	N/A	Aug. 22, 2012	Feb. 04, 2013~ Mar. 25, 2013	Aug. 21, 2013	Conducted (TH01-KS)
Power Sensor	Agilent	E9327A	MY44421198	N/A	Aug. 22, 2012	Feb. 04, 2013~ Mar. 25, 2013	Aug. 21, 2013	Conducted (TH01-KS)
DC Power Supply	GWINSTEK	GPS-3030D	E1884515	N/A	Aug. 22, 2012	Feb. 04, 2013~ Mar. 25, 2013	Aug. 21, 2013	Conducted (TH01-KS)
Thermal Chamber	Ten Billion	TTC-B3S	TBN-960502	N/A	Dec. 29, 2012	Feb. 04, 2013~ Mar. 25, 2013	Dec. 28, 2013	Conducted (TH01-KS)
Bluetooth Base Station	R&S	CBT	100783	N/A	Aug. 17, 2012	Feb. 04, 2013~ Mar. 25, 2013	Aug. 16, 2013	Conducted (TH01-KS)
EMI Test Receiver	R&S	ESCI	100534	9kHz~3GHz	Nov. 08, 2012	Mar. 22, 2013	Nov. 07, 2013	Radiation (03CH01-KS)
Spectrum Analyzer	R&S	FSP30	100400	9kHz~30GHz	Jun. 01, 2012	Mar. 22, 2013	May 31, 2013	Radiation (03CH01-KS)
Bilog Antenna	SCHAFFNER	CBL6112D	23182	25MHz~2GHz	Dec. 07, 2012	Mar. 22, 2013	Dec. 06, 2013	Radiation (03CH01-KS)
Loop Antenna	R&S	HFH2-Z2	860004/ 001	9 kHz~30 MHz	Jul. 03, 2012	Mar. 22, 2013	Jul. 02, 2014	Radiation (03CH01-KS)
Double Ridge Horn Antenna	ETS-Lindgren	1908/7/13	00075957	1GHz~18GHz	Dec. 07, 2012	Mar. 22, 2013	Dec. 06, 2013	Radiation (03CH01-KS)
Amplifier	com-power	PA-103A	161069	1MHz~1GHz	Jun. 01, 2012	Mar. 22, 2013	May 31, 2013	Radiation (03CH01-KS)
Amplifier	Agilent	8449B	3008A02370	1GHz~26.5GHz	Dec. 29, 2012	Mar. 22, 2013	Dec. 28, 2013	Radiation (03CH01-KS)
Active Horn Antenna	com-power	AHA-118	701023	1GHz~18GHz	Nov. 07, 2012	Mar. 22, 2013	Nov. 06, 2013	Radiation (03CH01-KS)
SHF-EHF Horn	Schwarzbeck	BBHA 9170	9170249	15GHz~40GHz	Nov. 23, 2012	Mar. 22, 2013	Nov. 22, 2013	Radiation (03CH01-KS)
Bluetooth Base Station	R&S	CBT	100783	N/A	Aug. 17, 2012	Mar. 22, 2013	Aug. 16, 2013	Radiation (03CH01-KS)
EMI Receiver	R&S	ESCI7	100768	9kHz~7GHz	Jun. 01, 2012	Mar. 15, 2013	May 31, 2013	Conduction (CO01-KS)
LISN	MessTec	AN3016	60103	9kHz~30MHz	Dec. 29, 2012	Mar. 15, 2013	Dec. 28, 2013	Conduction (CO01-KS)
LISN	MessTec	AN3016	60105	9kHz~30MHz	Dec. 29, 2012	Mar. 15, 2013	Dec. 28, 2013	Conduction (CO01-KS)
AC Power Source	Chroma	61602	ABP000000811	N/A	Nov. 15, 2012	Mar. 15, 2013	Nov. 14, 2013	Conduction (CO01-KS)
System Simulator	R&S	CMU200	837587/066	2G Full-Band	Dec. 29, 2012	Mar. 15, 2013	Dec. 28, 2013	Conduction (CO01-KS)



5 Uncertainty of Evaluation

Uncertainty of Conducted Emission Measurement (150 KHz ~ 30 MHz)

Measuring Uncertainty for a Level of Confidence of 95% ($U = 2Uc(y)$)	2.26
---	------

Uncertainty of Radiated Emission Measurement (30 MHz ~ 1000 MHz)

Measuring Uncertainty for a Level of Confidence of 95% ($U = 2Uc(y)$)	2.54
---	------

Uncertainty of Radiated Emission Measurement (1 GHz ~ 40 GHz)

Measuring Uncertainty for a Level of Confidence of 95% ($U = 2Uc(y)$)	4.72
---	------



Appendix A. Photographs of EUT

Please refer to Sporton report number EP312402 as below.