



FCC SAR Test Report

APPLICANT : Brightstar Corporation
EQUIPMENT : mobile phone
BRAND NAME : Avvio
MODEL NAME : Avvio 501S / Avvio 501 / Avvio 401TV / Avvio 501TV
MARKETING NAME : Avvio 501S / Avvio 501 / Avvio 401TV / Avvio 501TV
FCC ID : WVBA501X
STANDARD : FCC 47 CFR Part 2 (2.1093)
ANSI/IEEE C95.1-1992
IEEE 1528-2003
FCC OET Bulletin 65 Supplement C (Edition 01-01)

The product was completely tested on Feb. 04, 2013. We, SPORTON INTERNATIONAL INC., would like to declare that the tested sample has been evaluated in accordance with the procedures and shown the compliance with the applicable technical standards.

The test results in this report apply exclusively to the tested model / sample. Without written approval of SPORTON INTERNATIONAL INC., the test report shall not be reproduced except in full.

Reviewed by:

Jones Tsai / Manager



Testing Laboratory
2353

SPORTON INTERNATIONAL (SHENZHEN) INC.

No. 101, Complex Building C, Guanglong Village, Xili Town, Nanshan District, Shenzhen, Guangdong, P.R.C.



Table of Contents

1. Statement of Compliance	4
2. Administration Data	5
2.1 Testing Laboratory	5
2.2 Applicant	5
2.3 Manufacturer	5
2.4 Application Details	5
3. General Information	6
3.1 Description of Equipment Under Test (EUT)	6
3.2 Maximum RF output power among production units	7
3.3 Product Photos	8
3.4 Applied Standard	8
3.5 Device Category and SAR Limits	8
3.6 Test Conditions	8
4. Specific Absorption Rate (SAR)	9
4.1 Introduction	9
4.2 SAR Definition	9
5. SAR Measurement System	10
5.1 E-Field Probe	11
5.2 Data Acquisition Electronics (DAE)	12
5.3 Robot	12
5.4 Measurement Server	12
5.5 Phantom	13
5.6 Device Holder	13
5.7 Data Storage and Evaluation	14
5.8 Test Equipment List	16
6. Tissue Simulating Liquids	17
7. SAR System Verification	18
7.1 Purpose of System Performance check	18
7.2 System Setup	18
7.3 SAR System Verification Results	19
8. EUT Testing Position	20
8.1 Define two imaginary lines on the handset	20
8.2 Cheek Position	21
8.3 Tilted Position	21
8.4 Body Worn Position	22
9. Measurement Procedures	23
9.1 Spatial Peak SAR Evaluation	23
9.2 Power Reference Measurement	24
9.3 Area & Zoom Scan Procedures	24
9.4 Volume Scan Procedures	25
9.5 SAR Averaged Methods	25
9.6 Power Drift Monitoring	25
10. Exposure Positions Consideration	26
11. Conducted RF Output Power (Unit: dBm)	27
12. SAR Test Results	30
12.1 Test Records for Head SAR Test	30
12.2 Test Records for Body-worn SAR Test	30
12.3 Highest SAR Plot	30
12.4 Simultaneous Multi-band Transmission Analysis	33
13. Uncertainty Assessment	35
14. References	37
Appendix A. Plots of System Performance Check	
Appendix B. Plots of SAR Measurement	
Appendix C. DASY Calibration Certificate	
Appendix D. Product Photos	
Appendix E. Test Setup Photos	



Revision History

REPORT NO.	VERSION	DESCRIPTION	ISSUED DATE
FA312402	Rev. 01	Initial issue of report	Mar. 29, 2013



1. Statement of Compliance

The maximum results of Specific Absorption Rate (SAR) found during testing for **Brightstar Corporation**, **DUT: mobile phone**, **Brand Name: Avvio**, **Model Name: Avvio 501S / Avvio 501 / Avvio 401TV / Avvio 501TV**, **Marketing Name: Avvio 501S / Avvio 501 / Avvio 401TV / Avvio 501TV** are as follows.

<Highest Reported standalone SAR Summary>

Exposure Position	Frequency Band	Highest Reported 1g-SAR (W/kg)	Equipment Class	Highest Reported 1g-SAR (W/kg)
Head	GSM850	0.77	PCE	0.77
	GSM1900	0.65		
Body-worn (1.5cm Gap)	GSM850	0.65	PCE	0.65
	GSM1900	0.41		

<Highest Simultaneous transmission SAR>

Frequency Band	Equipment Class	Exposure Position	Highest Reported Simultaneous Transmission 1g-SAR (W/kg)
GSM850	PCE	Head	1.10
Bluetooth 2.4GHz	DSS		

Remark:

The highest simultaneous transmission is scalar summation of reported standalone SAR per FCC KDB 690783 D01 v01r02, and scalar SAR summation of all possible simultaneous transmission scenarios are < 1.6W/kg.

This device is in compliance with Specific Absorption Rate (SAR) for general population/uncontrolled exposure limits (1.6 W/kg) specified in FCC 47 CFR part 2 (2.1093) and ANSI/IEEE C95.1-1992, and had been tested in accordance with the measurement methods and procedures specified in IEEE 1528-2003 and FCC OET Bulletin 65 Supplement C (Edition 01-01).



2. Administration Data

2.1 Testing Laboratory

Test Site	SPORTON INTERNATIONAL (SHENZHEN) INC.
Test Site Location	No. 101, Complex Building C, Guanglong Village, Xili Town, Nanshan District, Shenzhen, Guangdong, P.R.C. TEL: +86-755-8637-9589 FAX: +86-755-8637-9595

2.2 Applicant

Company Name	Brightstar Corporation
Address	9725 NW 117th Ave., Miami, Florida, United States

2.3 Manufacturer

Company Name	KCMobile Co., Ltd.
Address	#502, Ace techno tower 8th, 191-7 Guro-dong, Guro-Gu, Seoul, South Korea

2.4 Application Details

Date of Start during the Test	Feb. 04, 2013
Date of End during the Test	Feb. 04, 2013



3. General Information

3.1 Description of Equipment Under Test (EUT)

Product Feature & Specification																					
EUT	mobile phone																				
Brand Name	Avvio																				
Model Name	Avvio 501S / Avvio 501 / Avvio 401TV / Avvio 501TV																				
Marketing Name	Avvio 501S / Avvio 501 / Avvio 401TV / Avvio 501TV																				
FCC ID	WVBA501X																				
IMEI Code	For single SIM card mobile: 357417039964502 For dual SIM cards mobile: #1: 357417039965046 #2: 357417039965053																				
TX Frequency	GSM850: 824.2 MHz ~ 848.8 MHz GSM1900: 1850.2 MHz ~ 1909.8 MHz Bluetooth: 2402 MHz ~ 2480 MHz																				
Antenna Type	WWAN: PIFA Antenna Bluetooth: Monopole Antenna																				
HW Version	D99_MB_V0.2																				
SW Version	V1.0.1																				
Uplink Modulations	GSM: GMSK GPRS: GMSK Bluetooth : GFSK Bluetooth EDR : $\pi/4$ -DQPSK, 8-DPSK																				
DUT Category	Class B – EUT cannot support Packet Switched and Circuit Switched Network simultaneously but can automatically switch between Packet and Circuit Switched Network.																				
EUT Stage	Identical Prototype																				
Remark:																					
1. The above EUT's information was declared by manufacturer. Please refer to the specifications or user's manual for more detailed description.																					
2. There are four model names of this project. The differences between them are summary below:																					
<table border="1"> <thead> <tr> <th>Model Name List</th> <th>Model Name</th> <th>SIM Slot</th> <th>TV function</th> </tr> </thead> <tbody> <tr> <td>Model 1</td> <td>Avvio 501S</td> <td>Dual SIM</td> <td>No TV function</td> </tr> <tr> <td>Model 2</td> <td>Avvio 501</td> <td>Single SIM</td> <td>No TV function</td> </tr> <tr> <td>Model 3</td> <td>Avvio 501TV</td> <td>Single SIM</td> <td>With TV function</td> </tr> <tr> <td>Model 4</td> <td>Avvio 401TV</td> <td>Single SIM</td> <td>With TV function</td> </tr> </tbody> </table>		Model Name List	Model Name	SIM Slot	TV function	Model 1	Avvio 501S	Dual SIM	No TV function	Model 2	Avvio 501	Single SIM	No TV function	Model 3	Avvio 501TV	Single SIM	With TV function	Model 4	Avvio 401TV	Single SIM	With TV function
Model Name List	Model Name	SIM Slot	TV function																		
Model 1	Avvio 501S	Dual SIM	No TV function																		
Model 2	Avvio 501	Single SIM	No TV function																		
Model 3	Avvio 501TV	Single SIM	With TV function																		
Model 4	Avvio 401TV	Single SIM	With TV function																		
Except list above, all the others are the same including circuit design, PCB board, structure and all components. It is special to declare.																					

3.2 Maximum RF output power among production units

Mode	GSM 850	GSM 1900
	Burst Average power(dBm)	
GSM (GMSK, 1 Tx slot)	33	30
GPRS (GMSK, 1 Tx slot)	32.5	30
GPRS (GMSK, 2 Tx slots)	31.5	29
GPRS (GMSK, 3 Tx slots)	30	27.5
GPRS (GMSK, 4 Tx slots)	29	27

Bluetooth Average power(dBm)			
Mode / Band	Bluetooth		
	1Mbps (GMSK)	2Mbps ($\pi/4$ -DQPSK)	3Mbps (8-DPSK)
2.4 GHz Bluetooth	9	7.5	7.5



3.3 Product Photos

Please refer to Appendix D.

3.4 Applied Standard

The Specific Absorption Rate (SAR) testing specification, method, and procedure for this device is in accordance with the following standards:

- FCC 47 CFR Part 2 (2.1093)
- ANSI/IEEE C95.1-1992
- IEEE 1528-2003
- FCC OET Bulletin 65 Supplement C (Edition 01-01)
- FCC KDB 447498 D01 v05
- FCC KDB 648474 D04v01
- FCC KDB 941225 D03 v01
- FCC KDB 865664 D01 v01

3.5 Device Category and SAR Limits

This device belongs to portable device category because its radiating structure is allowed to be used within 20 centimeters of the body of the user. Limit for General Population/Uncontrolled exposure should be applied for this device, it is 1.6 W/kg as averaged over any 1 gram of tissue.

3.6 Test Conditions

3.6.1 Ambient Condition

Ambient Temperature	20 to 24 °C
Humidity	< 60 %

3.6.2 Test Configuration

For WWAN SAR testing, the device was controlled by using a base station emulator. Communication between the device and the emulator was established by air link. The distance between the EUT and the antenna of the emulator is larger than 50 cm and the output power radiated from the emulator antenna is at least 30 dB smaller than the output power of EUT.

4. Specific Absorption Rate (SAR)

4.1 Introduction

SAR is related to the rate at which energy is absorbed per unit mass in an object exposed to a radio field. The SAR distribution in a biological body is complicated and is usually carried out by experimental techniques or numerical modeling. The standard recommends limits for two tiers of groups, occupational/controlled and general population/uncontrolled, based on a person's awareness and ability to exercise control over his or her exposure. In general, occupational/controlled exposure limits are higher than the limits for general population/uncontrolled.

4.2 SAR Definition

The SAR definition is the time derivative (rate) of the incremental energy (dW) absorbed by (dissipated in) an incremental mass (dm) contained in a volume element (dv) of a given density (ρ). The equation description is as below:

$$\text{SAR} = \frac{d}{dt} \left(\frac{dW}{dm} \right) = \frac{d}{dt} \left(\frac{dW}{\rho dv} \right)$$

SAR is expressed in units of Watts per kilogram (W/kg)

SAR measurement can be either related to the temperature elevation in tissue by

$$\text{SAR} = c \left(\frac{\delta T}{\delta t} \right)$$

Where: C is the specific heat capacity, δT is the temperature rise and δt is the exposure duration, or related to the electrical field in the tissue by

$$\text{SAR} = \frac{\sigma |E|^2}{\rho}$$

Where: σ is the conductivity of the tissue, ρ is the mass density of the tissue and E is the RMS electrical field strength.

However for evaluating SAR of low power transmitter, electrical field measurement is typically applied.

5. SAR Measurement System

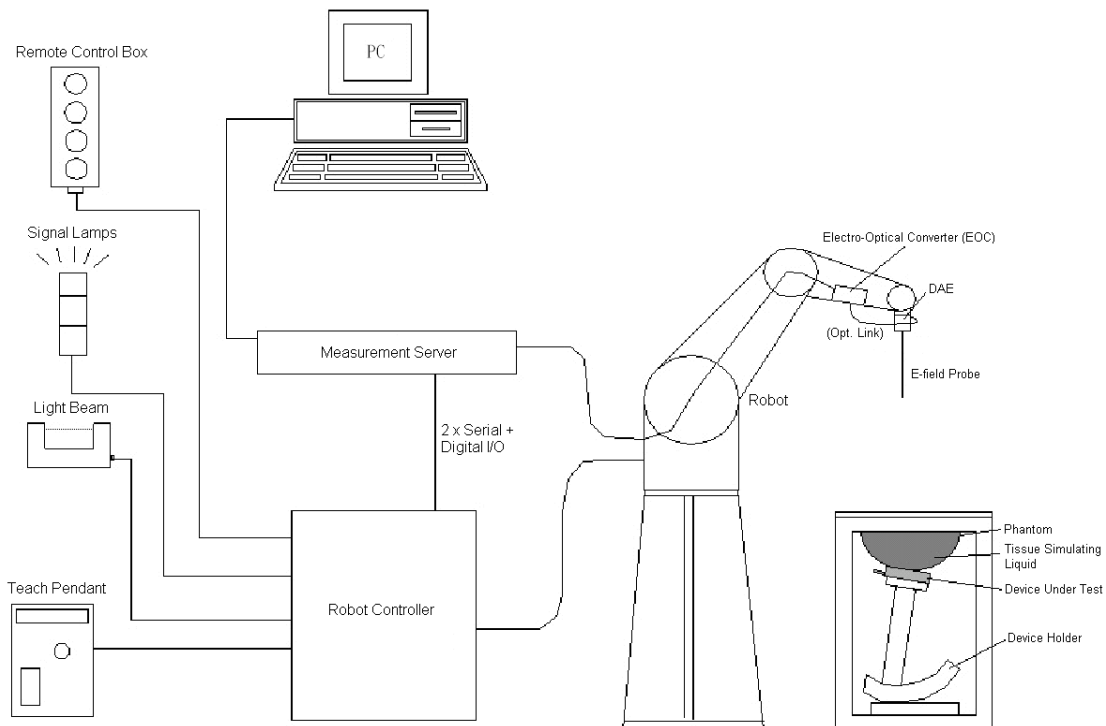

Fig 5.1 SPEAG DASY System Configurations

The DASY system for performance compliance tests is illustrated above graphically. This system consists of the following items:

- A standard high precision 6-axis robot with controller, a teach pendant and software
- A data acquisition electronic (DAE) attached to the robot arm extension
- A dosimetric probe equipped with an optical surface detector system
- The electro-optical converter (EOC) performs the conversion between optical and electrical signals
- A measurement server performs the time critical tasks such as signal filtering, control of the robot operation and fast movement interrupts.
- A probe alignment unit which improves the accuracy of the probe positioning
- A computer operating Windows XP
- DASY software
- Remote control with teach pendant and additional circuitry for robot safety such as warning lamps, etc.
- The SAM twin phantom
- A device holder
- Tissue simulating liquid
- Dipole for evaluating the proper functioning of the system

Component details are described in in the following sub-sections.

5.1 E-Field Probe

The SAR measurement is conducted with the dosimetric probe (manufactured by SPEAG). The probe is specially designed and calibrated for use in liquid with high permittivity. The dosimetric probe has special calibration in liquid at different frequency. This probe has a built in optical surface detection system to prevent from collision with phantom.

5.1.1 E-Field Probe Specification

<EX3DV4 Probe>

Construction	Symmetrical design with triangular core Built-in shielding against static charges PEEK enclosure material (resistant to organic solvents, e.g., DGBE)	
Frequency	10 MHz to 6 GHz; Linearity: ± 0.2 dB	
Directivity	± 0.3 dB in HSL (rotation around probe axis) ± 0.5 dB in tissue material (rotation normal to probe axis)	
Dynamic Range	10 μ W/g to 100 mW/g; Linearity: ± 0.2 dB (noise: typically < 1 μ W/g)	
Dimensions	Overall length: 330 mm (Tip: 20 mm) Tip diameter: 2.5 mm (Body: 12 mm) Typical distance from probe tip to dipole centers: 1 mm	

Fig 5.2 Photo of EX3DV4

5.1.2 E-Field Probe Calibration

Each probe needs to be calibrated according to a dosimetric assessment procedure with accuracy better than $\pm 10\%$. The spherical isotropy shall be evaluated and within ± 0.25 dB. The sensitivity parameters (NormX, NormY, and NormZ), the diode compression parameter (DCP) and the conversion factor (ConvF) of the probe are tested. The calibration data can be referred to appendix C of this report.

5.2 Data Acquisition Electronics (DAE)

The data acquisition electronics (DAE) consists of a highly sensitive electrometer-grade preamplifier with auto-zeroing, a channel and gain-switching multiplexer, a fast 16 bit AD-converter and a command decoder and control logic unit. Transmission to the measurement server is accomplished through an optical downlink for data and status information as well as an optical uplink for commands and the clock. The input impedance of the DAE is 200 MOhm; the inputs are symmetrical and floating. Common mode rejection is above 80 dB.



Fig 5.3 Photo of DAE

5.3 Robot

The SPEAG DASY system uses the high precision robots (DASY5: TX90XL) type from Stäubli SA (France). For the 6-axis controller system, the robot controller version (DASY5: CS8c) from Stäubli is used. The Stäubli robot series have many features that are important for our application:

- High precision (repeatability ± 0.035 mm)
- High reliability (industrial design)
- Jerk-free straight movements
- Low ELF interference (the closed metallic construction shields against motor control fields)



Fig 5.4 Photo of DASY5

5.4 Measurement Server

The measurement server is based on a PC/104 CPU board with CPU (DASY5: 400 MHz, Intel Celeron), chipdisk (DASY5: 128 MB), RAM (DASY5: 128 MB). The necessary circuits for communication with the DAE electronic box, as well as the 16 bit AD converter system for optical detection and digital I/O interface are contained on the DASY I/O board, which is directly connected to the PC/104 bus of the CPU board.

The measurement server performs all the real-time data evaluation for field measurements and surface detection, controls robot movements and handles safety operations.



Fig 5.5 Photo of Server for DASY5

5.5 Phantom

<SAM Twin Phantom>

Shell Thickness	2 ± 0.2 mm; Center ear point: 6 ± 0.2 mm
Filling Volume	Approx. 25 liters
Dimensions	Length: 1000 mm; Width: 500 mm; Height: adjustable feet
Measurement Areas	Left Hand, Right Hand, Flat Phantom



Fig 5.6 Photo of SAM Phantom

The bottom plate contains three pair of bolts for locking the device holder. The device holder positions are adjusted to the standard measurement positions in the three sections. A white cover is provided to tap the phantom during off-periods to prevent water evaporation and changes in the liquid parameters. On the phantom top, three reference markers are provided to identify the phantom position with respect to the robot.

5.6 Device Holder

<Device Holder for SAM Twin Phantom>

The SAR in the phantom is approximately inversely proportional to the square of the distance between the source and the liquid surface. For a source at 5 mm distance, a positioning uncertainty of ± 0.5 mm would produce a SAR uncertainty of ± 20 %. Accurate device positioning is therefore crucial for accurate and repeatable measurements. The positions in which the devices must be measured are defined by the standards.

The DASY device holder is designed to cope with different positions given in the standard. It has two scales for the device rotation (with respect to the body axis) and the device inclination (with respect to the line between the ear reference points). The rotation center for both scales is the ear reference point (ERP). Thus the device needs no repositioning when changing the angles.

The DASY device holder is constructed of low-loss POM material having the following dielectric parameters: relative permittivity $\epsilon = 3$ and loss tangent $\delta = 0.02$. The amount of dielectric material has been reduced in the closest vicinity of the device, since measurements have suggested that the influence of the clamp on the test results could thus be lowered.



Fig 5.7 Device Holder

5.7 Data Storage and Evaluation

5.7.1 Data Storage

The DASY software stores the assessed data from the data acquisition electronics as raw data (in microvolt readings from the probe sensors), together with all the necessary software parameters for the data evaluation (probe calibration data, liquid parameters and device frequency and modulation data) in measurement files. The post-processing software evaluates the desired unit and format for output each time the data is visualized or exported. This allows verification of the complete software setup even after the measurement and allows correction of erroneous parameter settings. For example, if a measurement has been performed with an incorrect crest factor parameter in the device setup, the parameter can be corrected afterwards and the data can be reevaluated.

The measured data can be visualized or exported in different units or formats, depending on the selected probe type (e.g., [V/m], [A/m], [mW/g]). Some of these units are not available in certain situations or give meaningless results, e.g., a SAR-output in a non-lose media, will always be zero. Raw data can also be exported to perform the evaluation with other software packages.

5.7.2 Data Evaluation

The DASY post-processing software (SEMCAD) automatically executes the following procedures to calculate the field units from the microvolt readings at the probe connector. The parameters used in the evaluation are stored in the configuration modules of the software :

Probe parameters :	- Sensitivity	Norm _i , a _{i0} , a _{i1} , a _{i2}
	- Conversion factor	ConvF _i
	- Diode compression point	dcp _i
Device parameters :	- Frequency	f
	- Crest factor	cf
Media parameters :	- Conductivity	σ
	- Density	ρ

These parameters must be set correctly in the software. They can be found in the component documents or they can be imported into the software from the configuration files issued for the DASY components. In the direct measuring mode of the multi-meter option, the parameters of the actual system setup are used. In the scan visualization and export modes, the parameters stored in the corresponding document files are used.

The first step of the evaluation is a linearization of the filtered input signal to account for the compression characteristics of the detector diode. The compensation depends on the input signal, the diode type and the DC-transmission factor from the diode to the evaluation electronics. If the exciting field is pulsed, the crest factor of the signal must be known to correctly compensate for peak power.

The formula for each channel can be given as :

$$V_i = U_i + U_i^2 \cdot \frac{cf}{dcp_i}$$

with V_i = compensated signal of channel i , ($i = x, y, z$)
 U_i = input signal of channel i , ($i = x, y, z$)
 cf = crest factor of exciting field (DASY parameter)
 dcp_i = diode compression point (DASY parameter)

From the compensated input signals, the primary field data for each channel can be evaluated :

$$\text{E-field Probes : } E_i = \sqrt{\frac{V_i}{\text{Norm}_i \cdot \text{ConvF}}}$$

$$\text{H-field Probes : } H_i = \sqrt{V_i \cdot \frac{a_{i0} + a_{i1}f + a_{i2}f^2}{f}}$$

with V_i = compensated signal of channel i , ($i = x, y, z$)
 Norm_i = sensor sensitivity of channel i , ($i = x, y, z$), $\mu\text{V}/(\text{V/m})^2$ for E-field Probes
 ConvF = sensitivity enhancement in solution
 a_{ij} = sensor sensitivity factors for H-field probes
 f = carrier frequency [GHz]
 E_i = electric field strength of channel i in V/m
 H_i = magnetic field strength of channel i in A/m

The RSS value of the field components gives the total field strength (Hermitian magnitude) :

$$E_{\text{tot}} = \sqrt{E_x^2 + E_y^2 + E_z^2}$$

The primary field data are used to calculate the derived field units.

$$\text{SAR} = E_{\text{tot}}^2 \cdot \frac{\sigma}{\rho \cdot 1000}$$

with SAR = local specific absorption rate in mW/g
 E_{tot} = total field strength in V/m
 σ = conductivity in [mho/m] or [Siemens/m]
 ρ = equivalent tissue density in g/cm^3

Note that the density is set to 1, to account for actual head tissue density rather than the density of the tissue simulating liquid.



5.8 Test Equipment List

Manufacturer	Name of Equipment	Type/Model	Serial Number	Calibration	
				Last Cal.	Due Date
SPEAG	835MHz System Validation Kit	D835V2	4d091	Nov. 18, 2011	Nov. 16, 2013
SPEAG	1900MHz System Validation Kit	D1900V2	5d118	Nov. 21, 2011	Nov. 16, 2013
SPEAG	Data Acquisition Electronics	DAE4	1303	Nov. 22, 2012	Nov. 21, 2013
SPEAG	Dosimetric E-Field Probe	EX3DV4	3819	Nov. 26, 2012	Nov. 25, 2013
SPEAG	SAM Twin Phantom	QD 000 P40 CD	TP-1670	NCR	NCR
SPEAG	SAM Twin Phantom	QD 000 P40 CD	TP-1671	NCR	NCR
Agilent	Base Station	E5515C	MY50267224	Dec. 29, 2012	Dec. 28, 2013
Agilent	ENA Series Network Analyzer	E5071C	MY46111157	Apr. 13, 2012	Apr. 12, 2013
Anritsu	Power Sensor	MA2411B	1207253	May 08, 2012	May 07, 2013
Agilent	Dual Directional Coupler	778D	50422	Note 4	
Woken	Attenuator 1	WK0602-XX	N/A	Note 4	
PE	Attenuator 2	PE7005-10	N/A	Note 4	
PE	Attenuator 3	PE7005-3	N/A	Note 4	
Agilent	Dielectric Probe Kit	85070D	US01440205	Note 5	
AR	Power Amplifier	5S1G4M2	0328767	Note 6	
R&S	Spectrum Analyzer	FSP30	101400	Jun. 01, 2012	May 31, 2013

Table 5.1 Test Equipment List

Note:

1. The calibration certificate of DASY can be referred to appendix C of this report.
2. Referring to KDB 865664 D01v01, the dipole calibration interval can be extended to 3 years with justification. The dipoles are also not physically damaged, or repaired during the interval.
3. The justification data of dipole D835V2, SN: 4d091, D1900V2, SN: 5d118, can be found in appendix C. The return loss is < -20dB, within 20% of prior calibration, the impedance is within 5 ohm of prior calibration.
4. The Insertion Loss calibration of Dual Directional Coupler and Attenuator were characterized via the network analyzer and compensated during system check.
5. The dielectric probe kit was calibrated via the network analyzer, with the specified procedure (calibrated in pure water) and calibration kit (standard) short circuit, before the dielectric measurement. The specific procedure and calibration kit are provided by Agilent.
6. In system check we need to monitor the level on the power meter, and adjust the power amplifier level to have precise power level to the dipole; the measured SAR will be normalized to 1W input power according to the ratio of 1W to the input power to the dipole. For system check, the calibration of the power amplifier is deemed not critically required for correct measurement; the power meter is critical and we do have calibration for it
7. Attenuator 1 insertion loss is calibrated by the network Analyzer, which the calibration is valid, before system check.

6. Tissue Simulating Liquids

For the measurement of the field distribution inside the SAM phantom with DASY, the phantom must be filled with around 25 liters of homogeneous body tissue simulating liquid. For head SAR testing, the liquid height from the ear reference point (ERP) of the phantom to the liquid top surface is larger than 15 cm, which is shown in Fig. 6.1. For body SAR testing, the liquid height from the center of the flat phantom to the liquid top surface is larger than 15 cm, which is shown in Fig. 6.2.

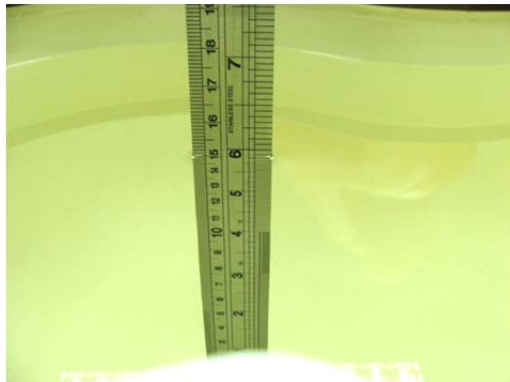

Fig 6.1 Photo of Liquid Height for Head SAR



Fig 6.2 Photo of Liquid Height for Body SAR

The following table gives the recipes for tissue simulating liquid.

Frequency (MHz)	Water (%)	Sugar (%)	Cellulose (%)	Salt (%)	Preventol (%)	DGBE (%)	Conductivity (σ)	Permittivity (ϵ_r)
For Head								
835	40.3	57.9	0.2	1.4	0.2	0	0.90	41.5
1800, 1900, 2000	55.2	0	0	0.3	0	44.5	1.40	40.0
For Body								
835	50.8	48.2	0	0.9	0.1	0	0.97	55.2
1800, 1900, 2000	70.2	0	0	0.4	0	29.4	1.52	53.3

Table 6.1 Recipes of Tissue Simulating Liquid

The dielectric parameters of the liquids were verified prior to the SAR evaluation using an Agilent 85070D Dielectric Probe Kit and an Agilent Network Analyzer.

The following table shows the measuring results for simulating liquid.

Freq. (MHz)	Liquid Type	Temp. (°C)	Conductivity (σ)	Permittivity (ϵ_r)	Conductivity Target (σ)	Permittivity Target (ϵ_r)	Delta (σ) (%)	Delta (ϵ_r) (%)	Limit (%)	Date
835	Head	21.6	0.919	41.524	0.90	41.5	2.11	0.06	±5	Feb. 04, 2013
1900	Head	21.3	1.412	39.311	1.40	40.0	0.86	-1.72	±5	Feb. 04, 2013
835	Body	21.5	0.971	56	0.97	55.2	0.10	1.45	±5	Feb. 04, 2013
1900	Body	21.4	1.519	53.569	1.52	53.3	-0.07	0.50	±5	Feb. 04, 2013

Table 6.2 Measuring Results for Simulating Liquid

7. SAR System Verification

Each DASY system is equipped with one or more system validation kits. These units, together with the predefined measurement procedures within the DASY software, enable the user to conduct the system performance check and system validation. System validation kit includes a dipole, tripod holder to fix it underneath the flat phantom and a corresponding distance holder.

7.1 Purpose of System Performance check

The system performance check verifies that the system operates within its specifications. System and operator errors can be detected and corrected. It is recommended that the system performance check be performed prior to any usage of the system in order to guarantee reproducible results. The system performance check uses normal SAR measurements in a simplified setup with a well characterized source. This setup was selected to give a high sensitivity to all parameters that might fail or vary over time. The system check does not intend to replace the calibration of the components, but indicates situations where the system uncertainty is exceeded due to drift or failure.

7.2 System Setup

In the simplified setup for system evaluation, the EUT is replaced by a calibrated dipole and the power source is replaced by a continuous wave that comes from a signal generator. The calibrated dipole must be placed beneath the flat phantom section of the SAM twin phantom with the correct distance holder. The distance holder should touch the phantom surface with a light pressure at the reference marking and be oriented parallel to the long side of the phantom. The equipment setup is shown below:

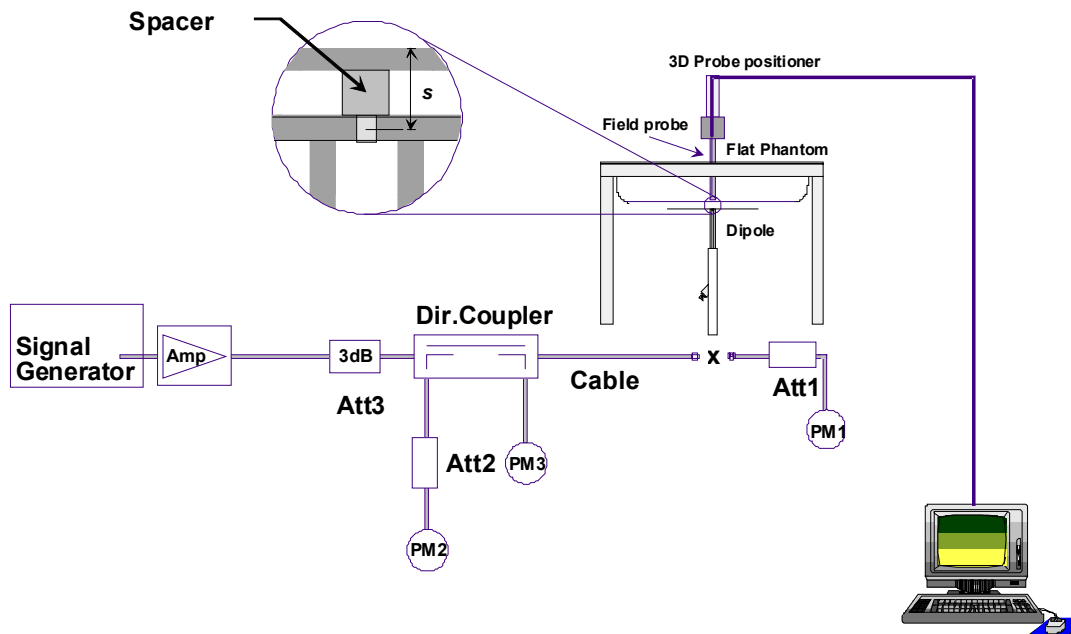

Fig 7.1 System Setup for System Evaluation

1. Signal Generator
2. Amplifier
3. Directional Coupler
4. Power Meter
5. Calibrated Dipole



Fig 7.2 Photo of Dipole Setup

7.3 SAR System Verification Results

Comparing to the original SAR value provided by SPEAG, the verification data should be within its specification of 10 %. Table 7.1 shows the target SAR and measured SAR after normalized to 1W input power. The table below indicates the system performance check can meet the variation criterion and the plots can be referred to Appendix A of this report.

Measurement Date	Frequency (MHz)	Liquid Type	Power fed onto reference dipole (mW)	Targeted SAR _{1g} (W/kg)	Measured SAR _{1g} (W/kg)	Normalized SAR _{1g} (W/kg)	Deviation (%)
Feb. 04, 2013	835	Head	250	9.4	2.52	10.08	7.23
Feb. 04, 2013	1900	Head	250	40.3	9.95	39.8	-1.24
Feb. 04, 2013	835	Body	250	9.42	2.42	9.68	2.76
Feb. 04, 2013	1900	Body	250	41.8	10.3	41.2	-1.44

Table 7.1 Target and Measurement SAR after Normalized

8. EUT Testing Position

This EUT was tested in six different positions. They are right cheek, right tilted, left cheek, left tilted, Front of the EUT with phantom 1.5 cm gap, and Back of the EUT with phantom 1.5 cm gap, as illustrated below.

8.1 Define two imaginary lines on the handset

- The vertical centerline passes through two points on the front side of the handset - the midpoint of the width w_t of the handset at the level of the acoustic output, and the midpoint of the width w_b of the bottom of the handset.
- The horizontal line is perpendicular to the vertical centerline and passes through the center of the acoustic output. The horizontal line is also tangential to the face of the handset at point A.
- The two lines intersect at point A. Note that for many handsets, point A coincides with the center of the acoustic output; however, the acoustic output may be located elsewhere on the horizontal line. Also note that the vertical centerline is not necessarily parallel to the front face of the handset, especially for clamshell handsets, handsets with flip covers, and other irregularly shaped handsets.

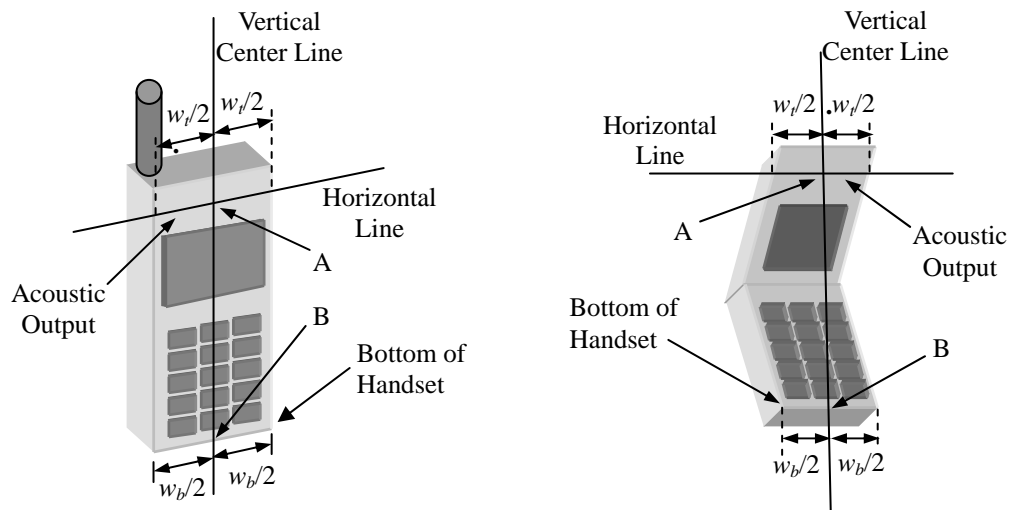

Fig 8.1 Illustration for Handset Vertical and Horizontal Reference Lines

8.2 Cheek Position

- (a) To position the device with the vertical center line of the body of the device and the horizontal line crossing the center piece in a plane parallel to the sagittal plane of the phantom. While maintaining the device in this plane, align the vertical center line with the reference plane containing the three ear and mouth reference point (M: Mouth, RE: Right Ear, and LE: Left Ear) and align the center of the ear piece with the line RE-LE.
- (b) To move the device towards the phantom with the ear piece aligned with the line LE-RE until the phone touched the ear. While maintaining the device in the reference plane and maintaining the phone contact with the ear, move the bottom of the phone until any point on the front side is in contact with the cheek of the phantom or until contact with the ear is lost (see Fig. 8.2).

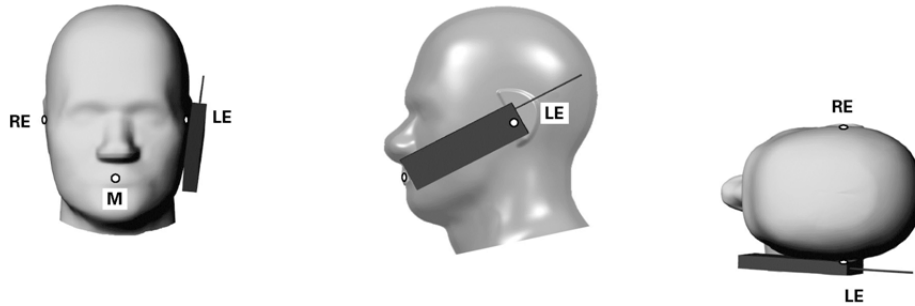

Fig 8.2 Illustration for Cheek Position

8.3 Tilted Position

- (a) To position the device in the “cheek” position described above.
- (b) While maintaining the device the reference plane described above and pivoting against the ear, moves it outward away from the mouth by an angle of 15 degrees or until contact with the ear is lost (see Fig. 8.3).

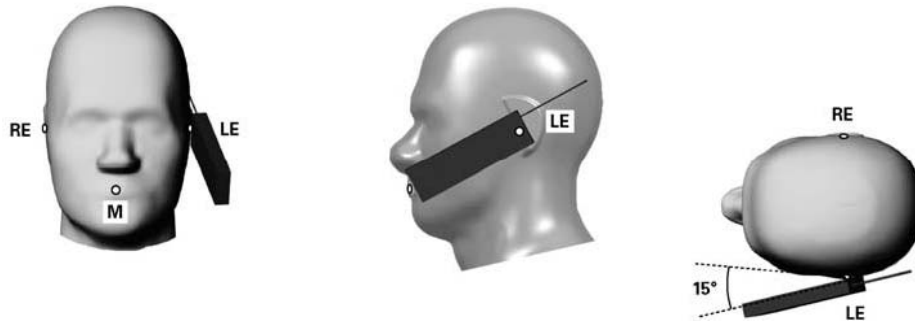

Fig 8.3 Illustration for Tilted Position

8.4 Body Worn Position

- (a) To position the device parallel to the phantom surface with either keypad up or down.
- (b) To adjust the device parallel to the flat phantom.
- (c) To adjust the distance between the device surface and the flat phantom to 1.5 cm.

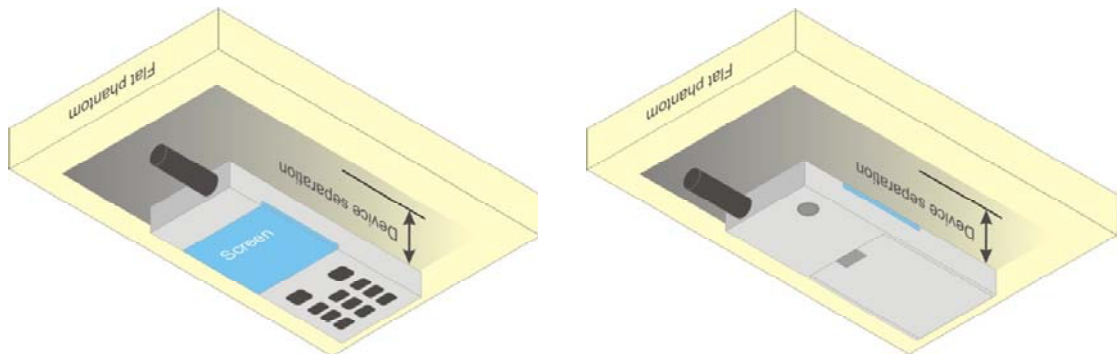

Fig 8.4 Illustration for Body Worn Position

<EUT Setup Photos>

Please refer to Appendix E for the test setup photos.

9. Measurement Procedures

The measurement procedures are as follows:

<Conducted power measurement>

- (a) For WWAN power measurement, use base station simulator to configure EUT WWAN transmission in conducted connection with RF cable, at maximum power in each supported wireless interface and frequency band.
- (b) Read the WWAN RF power level from the base station simulator.
- (c) For WLAN/BT power measurement, use engineering software to configure EUT WLAN/BT continuously transmission, at maximum RF power in each supported wireless interface and frequency band
- (d) Connect EUT RF port through RF cable to the power meter, and measure WLAN/BT output power

<SAR measurement>

- (a) Use base station simulator to configure EUT WWAN transmission in radiated connection, and engineering software to configure EUT WLAN/BT continuously transmission, at maximum RF power, in the highest power channel.
- (b) Place the EUT in the positions as Appendix E demonstrates.
- (c) Set scan area, grid size and other setting on the DASY software.
- (d) Measure SAR results for the highest power channel on each testing position.
- (e) Find out the largest SAR result on these testing positions of each band
- (f) Measure SAR results for other channels in worst SAR testing position if the reported SAR of highest power channel is larger than 0.8 W/kg

According to the test standard, the recommended procedure for assessing the peak spatial-average SAR value consists of the following steps:

- (a) Power reference measurement
- (b) Area scan
- (c) Zoom scan
- (d) Power drift measurement

9.1 Spatial Peak SAR Evaluation

The procedure for spatial peak SAR evaluation has been implemented according to the test standard. It can be conducted for 1g and 10g, as well as for user-specific masses. The DASY software includes all numerical procedures necessary to evaluate the spatial peak SAR value.

The base for the evaluation is a "cube" measurement. The measured volume must include the 1g and 10g cubes with the highest averaged SAR values. For that purpose, the center of the measured volume is aligned to the interpolated peak SAR value of a previously performed area scan.

The entire evaluation of the spatial peak values is performed within the post-processing engine (SEMCAD). The system always gives the maximum values for the 1g and 10g cubes. The algorithm to find the cube with highest averaged SAR is divided into the following stages:

- (a) Extraction of the measured data (grid and values) from the Zoom Scan
- (b) Calculation of the SAR value at every measurement point based on all stored data (A/D values and measurement parameters)
- (c) Generation of a high-resolution mesh within the measured volume
- (d) Interpolation of all measured values from the measurement grid to the high-resolution grid
- (e) Extrapolation of the entire 3-D field distribution to the phantom surface over the distance from sensor to surface
- (f) Calculation of the averaged SAR within masses of 1g and 10g

9.2 Power Reference Measurement

The Power Reference Measurement and Power Drift Measurements are for monitoring the power drift of the device under test in the batch process. The minimum distance of probe sensors to surface determines the closest measurement point to phantom surface. This distance cannot be smaller than the distance of sensor calibration points to probe tip as defined in the probe properties.

9.3 Area & Zoom Scan Procedures

First Area Scan is used to locate the approximate location(s) of the local peak SAR value(s). The measurement grid within an Area Scan is defined by the grid extent, grid step size and grid offset. Next, in order to determine the EM field distribution in a three-dimensional spatial extension, Zoom Scan is required. The Zoom Scan is performed around the highest E-field value to determine the averaged SAR-distribution over 10 g. Area scan and zoom scan resolution setting follows KDB 865664 D01v01 quoted below.

For any secondary peaks found in the area scan which are within 2 dB of the maximum peak and are not within this zoom scan, the zoom scan should be repeated

		≤ 3 GHz	> 3 GHz
Maximum distance from closest measurement point (geometric center of probe sensors) to phantom surface		5 ± 1 mm	½·δ·ln(2) ± 0.5 mm
Maximum probe angle from probe axis to phantom surface normal at the measurement location		30° ± 1°	20° ± 1°
Maximum area scan spatial resolution: Δx _{Area} , Δy _{Area}		≤ 2 GHz: ≤ 15 mm 2 – 3 GHz: ≤ 12 mm	3 – 4 GHz: ≤ 12 mm 4 – 6 GHz: ≤ 10 mm
		When the x or y dimension of the test device, in the measurement plane orientation, is smaller than the above, the measurement resolution must be ≤ the corresponding x or y dimension of the test device with at least one measurement point on the test device.	
Maximum zoom scan spatial resolution: Δx _{Zoom} , Δy _{Zoom}		≤ 2 GHz: ≤ 8 mm 2 – 3 GHz: ≤ 5 mm*	3 – 4 GHz: ≤ 5 mm* 4 – 6 GHz: ≤ 4 mm*
Maximum zoom scan spatial resolution, normal to phantom surface	uniform grid: Δz _{Zoom} (n)	≤ 5 mm	3 – 4 GHz: ≤ 4 mm 4 – 5 GHz: ≤ 3 mm 5 – 6 GHz: ≤ 2 mm
	graded grid Δz _{Zoom} (1): between 1 st two points closest to phantom surface	≤ 4 mm	3 – 4 GHz: ≤ 3 mm 4 – 5 GHz: ≤ 2.5 mm 5 – 6 GHz: ≤ 2 mm
	Δz _{Zoom} (n>1): between subsequent points	≤ 1.5·Δz _{Zoom} (n-1)	
Minimum zoom scan volume	x, y, z	≥ 30 mm	3 – 4 GHz: ≥ 28 mm 4 – 5 GHz: ≥ 25 mm 5 – 6 GHz: ≥ 22 mm
Note: δ is the penetration depth of a plane-wave at normal incidence to the tissue medium; see draft standard IEEE P1528-2011 for details. * When zoom scan is required and the <i>reported</i> SAR from the area scan based <i>I-g SAR estimation</i> procedures of KDB 447498 is ≤ 1.4 W/kg, ≤ 8 mm, ≤ 7 mm and ≤ 5 mm zoom scan resolution may be applied, respectively, for 2 GHz to 3 GHz, 3 GHz to 4 GHz and 4 GHz to 6 GHz.			



9.4 Volume Scan Procedures

The volume scan is used for assess overlapping SAR distributions for antennas transmitting in different frequency bands. It is equivalent to an oversized zoom scan used in standalone measurements. The measurement volume will be used to enclose all the simultaneous transmitting antennas. For antennas transmitting simultaneously in different frequency bands, the volume scan is measured separately in each frequency band. In order to sum correctly to compute the 1g aggregate SAR, the EUT remain in the same test position for all measurements and all volume scan use the same spatial resolution and grid spacing. When all volume scan were completed, the software, SEMCAD postprocessor can combine and subsequently superpose these measurement data to calculating the multiband SAR.

9.5 SAR Averaged Methods

In DASYS, the interpolation and extrapolation are both based on the modified Quadratic Shepard's method. The interpolation scheme combines a least-square fitted function method and a weighted average method which are the two basic types of computational interpolation and approximation.

Extrapolation routines are used to obtain SAR values between the lowest measurement points and the inner phantom surface. The extrapolation distance is determined by the surface detection distance and the probe sensor offset. The uncertainty increases with the extrapolation distance. To keep the uncertainty within 1% for the 1 g and 10 g cubes, the extrapolation distance should not be larger than 5 mm.

9.6 Power Drift Monitoring

All SAR testing is under the EUT install full charged battery and transmit maximum output power. In DASYS measurement software, the power reference measurement and power drift measurement procedures are used for monitoring the power drift of EUT during SAR test. Both these procedures measure the field at a specified reference position before and after the SAR testing. The software will calculate the field difference in dB. If the power drifts more than 5%, the SAR will be retested.

10. Exposure Positions Consideration

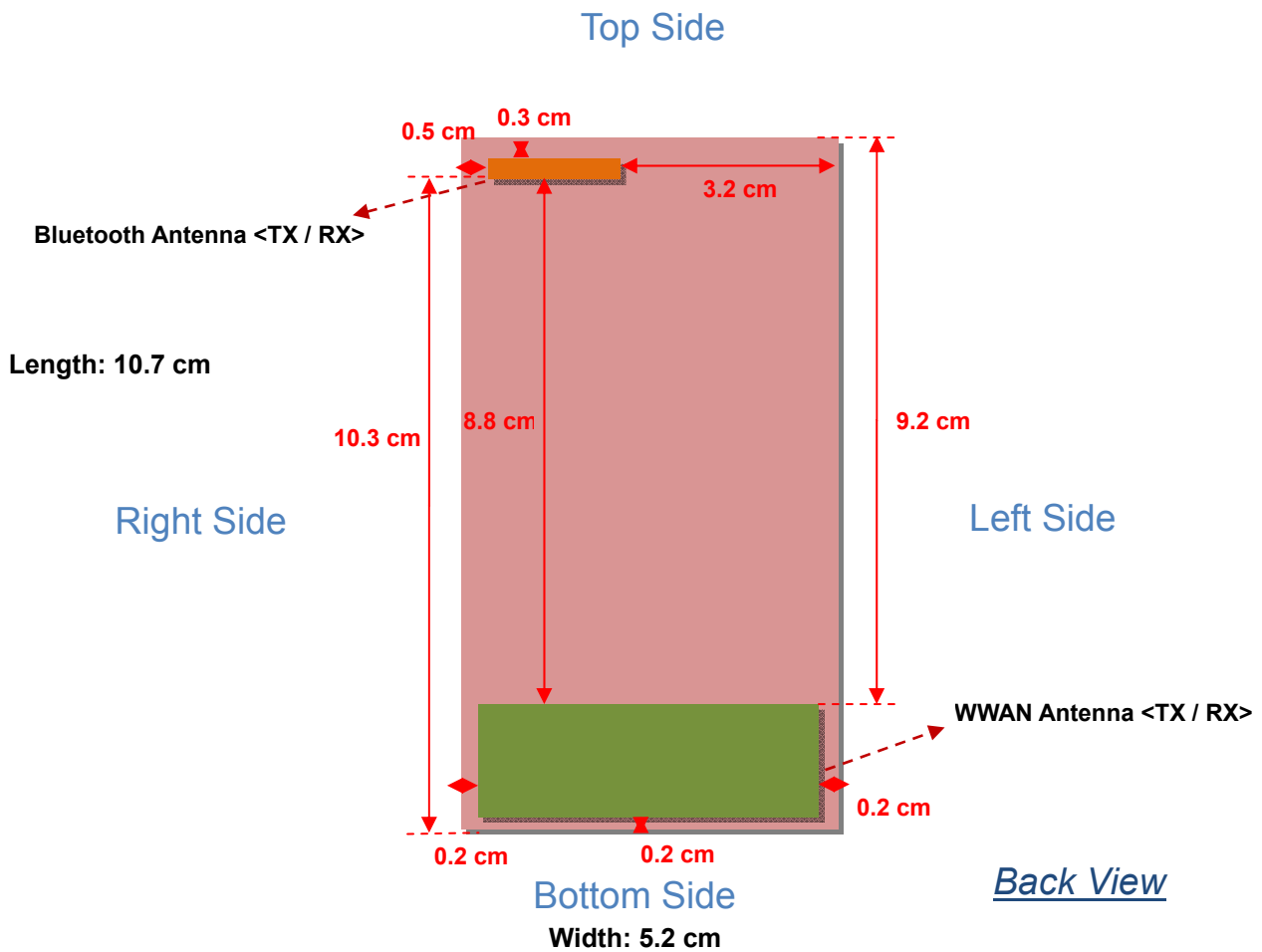

Antennas	Wireless Interface
WWAN Antenna (Tx / Rx)	GSM850 GSM1900
Bluetooth Antenna (Tx / Rx)	Bluetooth

11. Conducted RF Output Power (Unit: dBm)

<GSM Conducted Power>

Note:

1. Per KDB 447498 D01v05, the maximum output power channel is used for SAR testing and for further SAR test reduction.
2. The EUT do not support DTM function.

For single SIM card mobile

Band: GSM850	Burst Average Power (dBm)			Frame-Average Power (dBm)		
	128	189	251	128	189	251
Channel	824.2	836.4	848.8	824.2	836.4	848.8
Frequency (MHz)	824.2	836.4	848.8	824.2	836.4	848.8
GSM (GMSK, 1 Tx slot)	32.16	32.24	32.29	23.16	23.24	23.29
GPRS (GMSK, 1 Tx slot) – CS1	32.08	32.09	32.19	23.08	23.09	23.19
GPRS (GMSK, 2 Tx slots) – CS1	31.11	31.11	31.23	25.11	25.11	25.23
GPRS (GMSK, 3 Tx slots) – CS1	29.29	29.33	29.42	25.03	25.07	25.16
GPRS (GMSK, 4 Tx slots) – CS1	28.48	28.56	28.65	25.48	25.56	25.65

Remark: The frame-averaged power is linearly scaled the maximum burst averaged power over 8 time slots.
The calculated method are shown as below:
Frame-averaged power = Maximum burst averaged power (1 Tx Slot) - 9 dB
Frame-averaged power = Maximum burst averaged power (2 Tx Slots) - 6 dB
Frame-averaged power = Maximum burst averaged power (3 Tx Slots) - 4.26 dB
Frame-averaged power = Maximum burst averaged power (4 Tx Slots) - 3 dB

Band: GSM1900	Burst Average Power (dBm)			Frame-Average Power (dBm)		
	512	661	810	512	661	810
Channel	1850.2	1880.0	1909.8	1850.2	1880.0	1909.8
Frequency (MHz)	1850.2	1880.0	1909.8	1850.2	1880.0	1909.8
GSM (GMSK, 1 Tx slot)	29.72	29.74	29.37	20.72	20.74	20.37
GPRS (GMSK, 1 Tx slot) – CS1	29.60	29.61	29.29	20.60	20.61	20.29
GPRS (GMSK, 2 Tx slots) – CS1	28.81	28.78	28.43	22.81	22.78	22.43
GPRS (GMSK, 3 Tx slots) – CS1	27.23	27.26	26.92	22.97	23.00	22.66
GPRS (GMSK, 4 Tx slots) – CS1	26.41	26.49	26.09	23.41	23.49	23.09

Remark: The frame-averaged power is linearly scaled the maximum burst averaged power over 8 time slots.
The calculated method are shown as below:
Frame-averaged power = Maximum burst averaged power (1 Tx Slot) - 9 dB
Frame-averaged power = Maximum burst averaged power (2 Tx Slots) - 6 dB
Frame-averaged power = Maximum burst averaged power (3 Tx Slots) - 4.26 dB
Frame-averaged power = Maximum burst averaged power (4 Tx Slots) - 3 dB



For dual SIM cards mobile

SIM 1

Band: GSM850	Burst Average Power (dBm)			Frame-Average Power (dBm)		
	Channel	128	189	251	128	189
Frequency (MHz)	824.2	836.4	848.8	824.2	836.4	848.8
GSM (GMSK, 1 Tx slot)	32.17	32.26	32.35	23.17	23.26	23.35
GPRS (GMSK, 1 Tx slot) – CS1	32.17	32.18	32.28	23.17	23.18	23.28
GPRS (GMSK, 2 Tx slots) – CS1	31.22	31.24	31.35	25.22	25.24	25.35
GPRS (GMSK, 3 Tx slots) – CS1	29.37	29.44	29.57	25.11	25.18	25.31
GPRS (GMSK, 4 Tx slots) – CS1	28.57	28.62	28.74	25.57	25.62	25.74

Remark: The frame-averaged power is linearly scaled the maximum burst averaged power over 8 time slots.
The calculated method are shown as below:
Frame-averaged power = Maximum burst averaged power (1 Tx Slot) - 9 dB
Frame-averaged power = Maximum burst averaged power (2 Tx Slots) - 6 dB
Frame-averaged power = Maximum burst averaged power (3 Tx Slots) - 4.26 dB
Frame-averaged power = Maximum burst averaged power (4 Tx Slots) - 3 dB

Band: GSM1900	Burst Average Power (dBm)			Frame-Average Power (dBm)		
	Channel	512	661	810	512	661
Frequency (MHz)	1850.2	1880.0	1909.8	1850.2	1880.0	1909.8
GSM (GMSK, 1 Tx slot)	29.75	29.76	29.42	20.75	20.76	20.42
GPRS (GMSK, 1 Tx slot) – CS1	29.61	29.63	29.34	20.61	20.63	20.34
GPRS (GMSK, 2 Tx slots) – CS1	28.86	28.82	28.54	22.86	22.82	22.54
GPRS (GMSK, 3 Tx slots) – CS1	27.25	27.26	26.99	22.99	23.00	22.73
GPRS (GMSK, 4 Tx slots) – CS1	26.50	26.59	26.20	23.50	23.59	23.20

Remark: The frame-averaged power is linearly scaled the maximum burst averaged power over 8 time slots.
The calculated method are shown as below:
Frame-averaged power = Maximum burst averaged power (1 Tx Slot) - 9 dB
Frame-averaged power = Maximum burst averaged power (2 Tx Slots) - 6 dB
Frame-averaged power = Maximum burst averaged power (3 Tx Slots) - 4.26 dB
Frame-averaged power = Maximum burst averaged power (4 Tx Slots) - 3 dB



SIM 2

Band: GSM850	Burst Average Power (dBm)			Frame-Average Power (dBm)		
Channel	128	189	251	128	189	251
Frequency (MHz)	824.2	836.4	848.8	824.2	836.4	848.8
GSM (GMSK, 1 Tx slot)	32.22	32.32	32.40	23.22	23.32	23.40
GPRS (GMSK, 1 Tx slot) – CS1	32.21	32.29	32.30	23.21	23.29	23.30
GPRS (GMSK, 2 Tx slots) – CS1	31.26	31.23	31.37	25.26	25.23	25.37
GPRS (GMSK, 3 Tx slots) – CS1	29.41	29.45	29.56	25.15	25.19	25.30
GPRS (GMSK, 4 Tx slots) – CS1	28.54	28.66	28.74	25.54	25.66	25.74

Remark: The frame-averaged power is linearly scaled the maximum burst averaged power over 8 time slots.
The calculated method are shown as below:
Frame-averaged power = Maximum burst averaged power (1 Tx Slot) - 9 dB
Frame-averaged power = Maximum burst averaged power (2 Tx Slots) - 6 dB
Frame-averaged power = Maximum burst averaged power (3 Tx Slots) - 4.26 dB
Frame-averaged power = Maximum burst averaged power (4 Tx Slots) - 3 dB

Band: GSM1900	Burst Average Power (dBm)			Frame-Average Power (dBm)		
Channel	512	661	810	512	661	810
Frequency (MHz)	1850.2	1880.0	1909.8	1850.2	1880.0	1909.8
GSM (GMSK, 1 Tx slot)	29.79	29.80	29.46	20.79	20.80	20.46
GPRS (GMSK, 1 Tx slot) – CS1	29.62	29.66	29.37	20.62	20.66	20.37
GPRS (GMSK, 2 Tx slots) – CS1	28.88	28.84	28.57	22.88	22.84	22.57
GPRS (GMSK, 3 Tx slots) – CS1	27.30	27.26	27.00	23.04	23.00	22.74
GPRS (GMSK, 4 Tx slots) – CS1	26.51	26.52	26.23	23.51	23.52	23.23

Remark: The frame-averaged power is linearly scaled the maximum burst averaged power over 8 time slots.
The calculated method are shown as below:
Frame-averaged power = Maximum burst averaged power (1 Tx Slot) - 9 dB
Frame-averaged power = Maximum burst averaged power (2 Tx Slots) - 6 dB
Frame-averaged power = Maximum burst averaged power (3 Tx Slots) - 4.26 dB
Frame-averaged power = Maximum burst averaged power (4 Tx Slots) - 3 dB

Note:

- For Head SAR testing, GSM should be evaluated, therefore the EUT was set in GSM Voice for GSM850 and set in GSM Voice for GSM1900 due to its highest frame-average power.
- For Body worn SAR testing, GSM should be evaluated, therefore the EUT was set in GSM Voice for GSM850 and set in GSM Voice for GSM1900 due to its highest frame-average power.
- According to KDB447498D01V05, when DTM is not applicable, GPRS do not require body-worn accessory SAR testing.

<Bluetooth Conducted Power>

Mode	Channel	Frequency (MHz)	Average Power (dBm)								
			Data Rate								
			DH1	DH3	DH5	2DH1	2DH3	2DH5	3DH1	3DH3	3DH5
Bluetooth	CH 00	2402	6.95	6.98	6.83	5.67	5.29	5.06	5.84	4.87	5.04
	CH 39	2441	8.25	8.20	8.13	7.13	6.52	6.29	7.05	6.50	6.27
	CH 78	2480	8.22	8.19	8.02	7.14	6.58	6.37	7.16	6.54	6.31

12. SAR Test Results

Note:

- Per KDB 447498 D01v05, the reported SAR is the measured SAR value adjusted for maximum tune-up tolerance.
 $Scaling\ Factor = \frac{tune-up\ limit\ power\ (mW)}{EUT\ RF\ power\ (mW)}$, where tune-up limit is the maximum rated power among all production units.
 $Reported\ SAR(W/kg) = Measured\ SAR(W/kg) * Scaling\ Factor$
- Per KDB 447498 D01v05, for each exposure position, if the highest output channel reported SAR $\leq 0.8W/kg$, other channels SAR testing are not necessary

12.1 Test Records for Head SAR Test

<GSM SAR>

Plot No.	Band	Mode	Test Position	Ch.	Freq. (MHz)	Burst Average Power (dBm)	Tune-Up Limit (dBm)	Scaling Factor	Power Drift (dB)	Measured SAR _{1g} (W/kg)	Reported SAR _{1g} (W/kg)
3	GSM850	GSM Voice	Right Cheek	251	848.8	32.4	33	1.148	0.05	0.570	0.654
4	GSM850	GSM Voice	Right Tilted	251	848.8	32.4	33	1.148	0.02	0.363	0.417
5	GSM850	GSM Voice	Left Cheek	251	848.8	32.4	33	1.148	0.02	0.670	0.769
6	GSM850	GSM Voice	Left Tilted	251	848.8	32.4	33	1.148	0.01	0.388	0.445
9	GSM1900	GSM Voice	Right Cheek	661	1880	29.8	30	1.047	0.04	0.546	0.572
10	GSM1900	GSM Voice	Right Tilted	661	1880	29.8	30	1.047	-0.09	0.292	0.306
11	GSM1900	GSM Voice	Left Cheek	661	1880	29.8	30	1.047	-0.04	0.623	0.652
12	GSM1900	GSM Voice	Left Tilted	661	1880	29.8	30	1.047	-0.02	0.258	0.270

12.2 Test Records for Body-worn SAR Test

Note:

- Body-worn exposure conditions are intended to voice call operations, therefore GSM voice call mode is selected to be tested.
- Per KDB 648474 D04v01, when the reported SAR for a body-worn accessory measured without a headset connected to the handset is $\leq 1.2\ W/kg$, SAR testing with a headset connected to the handset is not required.

<GSM SAR>

Plot No.	Band	Mode	Test Position	Gap (cm)	Ch.	Freq. (MHz)	Average Power (dBm)	Tune-Up Limit (dBm)	Scaling Factor	Power Drift (dB)	SAR _{1g} (W/kg)	Scaled SAR _{1g} (W/kg)
1	GSM850	GSM Voice	Front	1.5	251	848.8	32.4	33	1.148	-0.01	0.384	0.441
2	GSM850	GSM Voice	Back	1.5	251	848.8	32.4	33	1.148	0.02	0.562	0.645
7	GSM1900	GSM Voice	Front	1.5	661	1880	29.8	30	1.047	-0.03	0.259	0.271
8	GSM1900	GSM Voice	Back	1.5	661	1880	29.8	30	1.047	-0.02	0.389	0.407

12.3 Highest SAR Plot

Plot No.	Band	Mode	Test Position	Ch.	Freq. (MHz)	Burst Average Power (dBm)	Tune-up Limit (dBm)	Scaling Factor	Power Drift (dB)	Measured SAR _{1g} (W/kg)	Reported SAR _{1g} (W/kg)
5	GSM850	GSM Voice	Left Cheek	251	848.8	32.4	33	1.148	0.02	0.670	0.769
11	GSM1900	GSM Voice	Left Cheek	661	1880	29.8	30	1.047	-0.04	0.623	0.652

Test Laboratory: Sporton International Inc. SAR/HAC Testing Lab

Date: 04.02.2013

05 GSM850_GSM Voice_Left Cheek_Ch251**DUT: 312402**

Communication System: Generic GSM; Frequency: 848.8 MHz; Duty Cycle: 1:8.3

Medium: HSL_835_130204 Medium parameters used: $f = 849$ MHz; $\sigma = 0.93$ mho/m; $\epsilon_r = 41.373$; ρ $= 1000$ kg/m³

Ambient Temperature : 23.5 °C; Liquid Temperature : 21.6 °C

DASY5 Configuration:

- Probe: EX3DV4 - SN3819; ConvF(9.56, 9.56, 9.56); Calibrated: 26.11.2012;

- Sensor-Surface: 2mm (Mechanical Surface Detection)

- Electronics: DAE4 Sn1303; Calibrated: 22.11.2012

- Phantom: SAM2; Type: QD000P40CD; Serial: TP:1671

- Measurement SW: DASY52, Version 52.8 (2); SEMCAD X Version 14.6.6 (6824)

Ch251/Area Scan (51x91x1): Interpolated grid: dx=15mm, dy=15mm

Maximum value of SAR (interpolated) = 0.779 W/kg

Ch251/Zoom Scan (5x5x7)/Cube 0: Measurement grid: dx=8mm, dy=8mm, dz=5mm

Reference Value = 30.400 V/m; Power Drift = 0.02 dB

Peak SAR (extrapolated) = 0.900 mW/g

SAR(1 g) = 0.670 mW/g; SAR(10 g) = 0.481 mW/g

Maximum value of SAR (measured) = 0.813 W/kg

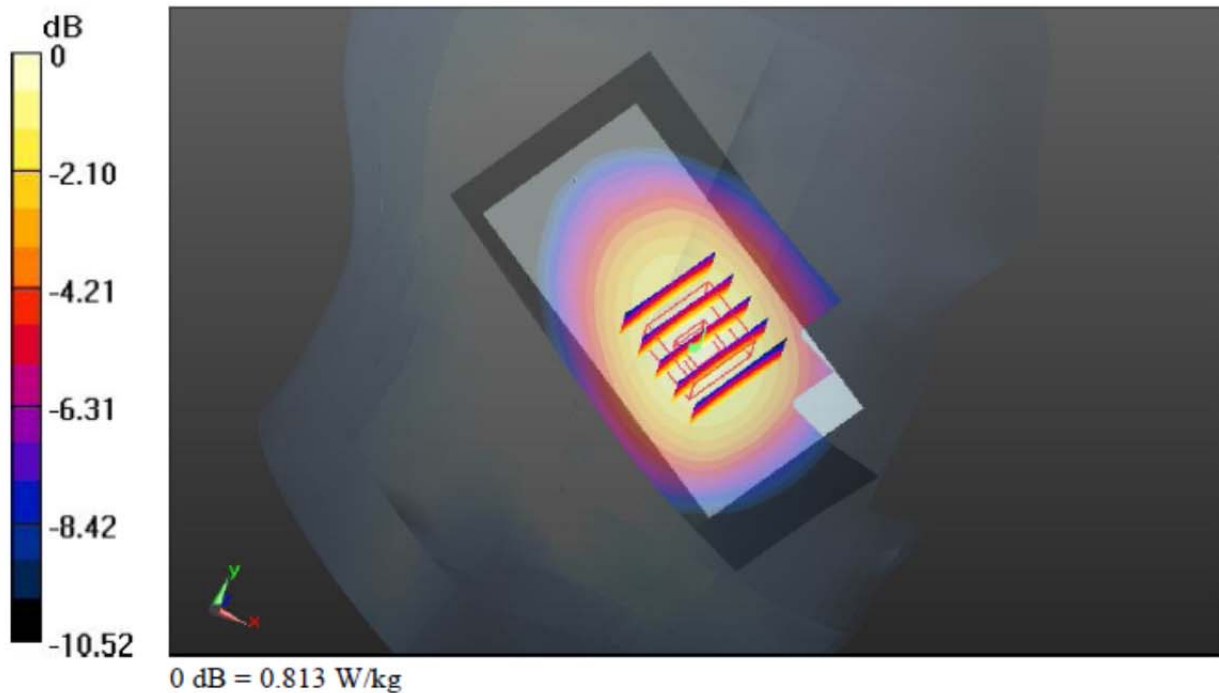

Test Laboratory: Sporton International Inc. SAR/HAC Testing Lab

Date: 04.02.2013

11 GSM1900_GSM Voice_Left Cheek_Ch661

DUT: 312402

Communication System: Generic GSM; Frequency: 1880 MHz; Duty Cycle: 1:8.3

Medium: HSL_1900_130204 Medium parameters used: $f = 1880$ MHz; $\sigma = 1.387$ mho/m; $\epsilon_r =$

39.308 ; $\rho = 1000$ kg/m³

Ambient Temperature : 23.5 °C; Liquid Temperature : 21.3 °C

DASY5 Configuration:

- Probe: EX3DV4 - SN3819; ConvF(7.84, 7.84, 7.84); Calibrated: 26.11.2012;

- Sensor-Surface: 2mm (Mechanical Surface Detection)

- Electronics: DAE4 Sn1303; Calibrated: 22.11.2012

- Phantom: SAM2; Type: QD000P40CD; Serial: TP:1671

- Measurement SW: DASY52, Version 52.8 (2); SEMCAD X Version 14.6.6 (6824)

Ch661/Area Scan (51x91x1): Interpolated grid: dx=15mm, dy=15mm

Maximum value of SAR (interpolated) = 0.799 W/kg

Ch661/Zoom Scan (5x5x7)/Cube 0: Measurement grid: dx=8mm, dy=8mm, dz=5mm

Reference Value = 24.070 V/m; Power Drift = -0.04 dB

Peak SAR (extrapolated) = 0.917 mW/g

SAR(1 g) = 0.623 mW/g; SAR(10 g) = 0.386 mW/g

Maximum value of SAR (measured) = 0.765 W/kg

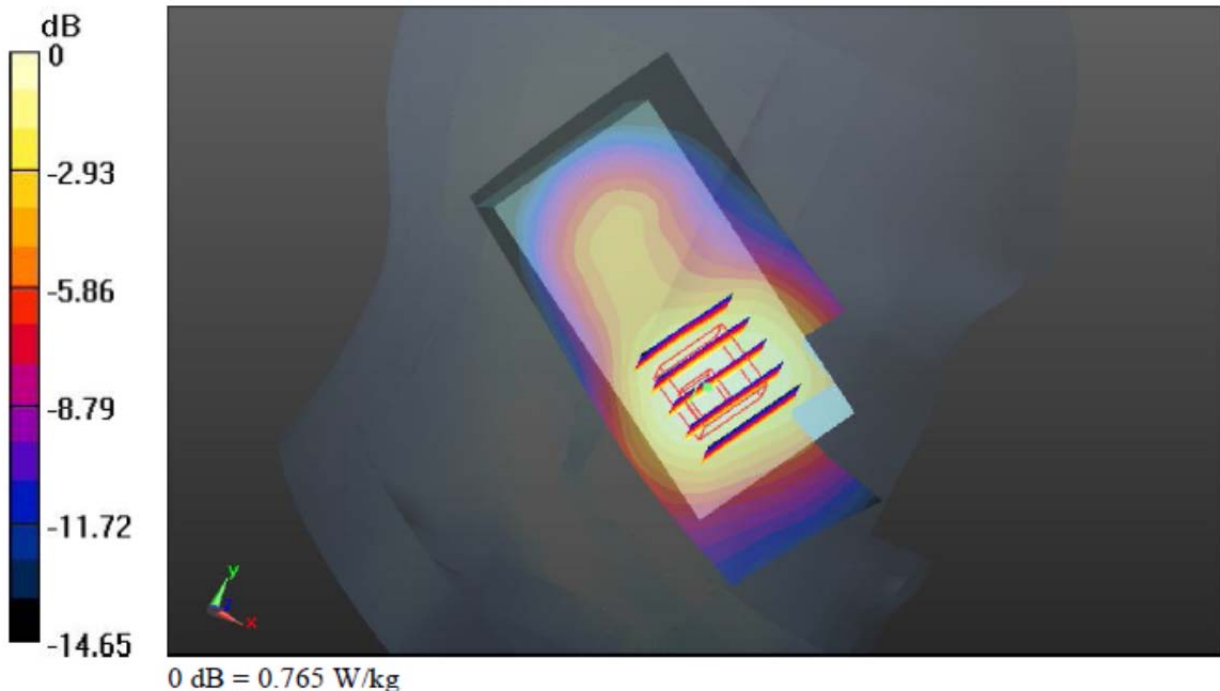

12.4 Simultaneous Multi-band Transmission Analysis

No.	Applicable Simultaneous Transmission Combination
1.	GSM (Voice) + Bluetooth

Note:

1. This device does not support hotspot mode.
2. The Scaled SAR summation is calculated based on the same configuration and test position.
3. For simultaneous transmission analysis, Bluetooth SAR is estimated per KDB 447498 D01v05 based on the formula below.
 - i) $(\text{max. power of channel, including tune-up tolerance, mW}) / (\text{min. test separation distance, mm}) \cdot [\sqrt{f(\text{GHz})/x}] \text{ W/kg}$ for test separation distances $\leq 50 \text{ mm}$; where $x = 7.5$ for 1-g SAR, and $x = 18.75$ for 10-g SAR.
 - ii) 0.4 W/kg for 1-g SAR and 1.0 W/kg for 10-g SAR, when the test separation distances is $> 50 \text{ mm}$.
4. Per KDB 447498 D01v05, simultaneous transmission SAR is compliant if,
 - (i) Scalar SAR summation $< 1.6 \text{ W/kg}$.
 - (ii) $\text{SPLSR} = (\text{SAR1} + \text{SAR2}) \cdot 1.5 / (\text{min. separation distance, mm})$, and the peak separation distance is determined from the square root of $[(x1-x2)^2 + (y1-y2)^2 + (z1-z2)^2]$, where $(x1, y1, z1)$ and $(x2, y2, z2)$ are the coordinates of the extrapolated peak SAR locations in the zoom scan
If $\text{SPLSR} \leq 0.04$, simultaneously transmission SAR measurement is not necessary
 - (iii) Simultaneously transmission SAR measurement, and the reported multi-band SAR $< 1.6 \text{ W/kg}$

Max Power	Exposure Position	Head	Body 1.5cm
	Test separation	0 mm	15 mm
9 dBm	Estimated SAR (W/kg)	0.331 W/kg	0.11 W/kg



<Head SAR>

Position	WWAN-PCE			Bluetooth-DSS	WWAN + Bluetooth SAR (W/kg)	SPLSR ≤ 0.04	Case No.
	WWAN Band	Plot No	Max. WWAN SAR (W/kg)	Estimated SAR (W/kg)			
Right Cheek	GSM850	3	0.654	0.331	0.99	-	-
	GSM1900	9	0.572	0.331	0.90	-	-
Right Tilted	GSM850	4	0.417	0.331	0.75	-	-
	GSM1900	10	0.306	0.331	0.64	-	-
Left Cheek	GSM850	5	0.769	0.331	1.10	-	-
	GSM1900	11	0.652	0.331	0.98	-	-
Left Tilted	GSM850	6	0.445	0.331	0.78	-	-
	GSM1900	12	0.270	0.331	0.60	-	-

<Body-worn SAR>

Position	WWAN-PCE			Bluetooth-DSS	WWAN + Bluetooth SAR (W/kg)	SPLSR ≤ 0.04	Case No.
	WWAN Band	Plot No	Max. WWAN SAR (W/kg)	Estimated SAR (W/kg)			
Front	GSM850	1	0.441	0.11	0.55	-	-
	GSM1900	7	0.271	0.11	0.38	-	-
Back	GSM850	2	0.645	0.11	0.76	-	-
	GSM1900	8	0.407	0.11	0.52	-	-

Test Engineer : Jeme Li

13. Uncertainty Assessment

The component of uncertainty may generally be categorized according to the methods used to evaluate them. The evaluation of uncertainty by the statistical analysis of a series of observations is termed a Type A evaluation of uncertainty. The evaluation of uncertainty by means other than the statistical analysis of a series of observations is termed a Type B evaluation of uncertainty. Each component of uncertainty, however evaluated, is represented by an estimated standard deviation, termed standard uncertainty, which is determined by the positive square root of the estimated variance.

A Type A evaluation of standard uncertainty may be based on any valid statistical method for treating data. This includes calculating the standard deviation of the mean of a series of independent observations; using the method of least squares to fit a curve to the data in order to estimate the parameter of the curve and their standard deviations; or carrying out an analysis of variance in order to identify and quantify random effects in certain kinds of measurement.

A type B evaluation of standard uncertainty is typically based on scientific judgment using all of the relevant information available. These may include previous measurement data, experience, and knowledge of the behavior and properties of relevant materials and instruments, manufacture’s specification, data provided in calibration reports and uncertainties assigned to reference data taken from handbooks. Broadly speaking, the uncertainty is either obtained from an outdoor source or obtained from an assumed distribution, such as the normal distribution, rectangular or triangular distributions indicated in Table 12.1

Uncertainty Distributions	Normal	Rectangular	Triangular	U-Shape
Multi-plying Factor ^(a)	1/k ^(b)	1/√3	1/√6	1/√2

(a) standard uncertainty is determined as the product of the multiplying factor and the estimated range of variations in the measured quantity

(b) κ is the coverage factor

Table 12.1 Standard Uncertainty for Assumed Distribution

The combined standard uncertainty of the measurement result represents the estimated standard deviation of the result. It is obtained by combining the individual standard uncertainties of both Type A and Type B evaluation using the usual “root-sum-squares” (RSS) methods of combining standard deviations by taking the positive square root of the estimated variances.

Expanded uncertainty is a measure of uncertainty that defines an interval about the measurement result within which the measured value is confidently believed to lie. It is obtained by multiplying the combined standard uncertainty by a coverage factor. Typically, the coverage factor ranges from 2 to 3. Using a coverage factor allows the true value of a measured quantity to be specified with a defined probability within the specified uncertainty range. For purpose of this document, a coverage factor two is used, which corresponds to confidence interval of about 95 %. The DASY uncertainty Budget is shown in the following tables.



Error Description	Uncertainty	Probability	Divisor	Ci	Ci	Standard	Standard
	Value (±%)	Distribution		(1g)	(10g)	Uncertainty (1g)	Uncertainty (10g)
Measurement System							
Probe Calibration	6.0	Normal	1	1	1	± 6.0 %	± 6.0 %
Axial Isotropy	4.7	Rectangular	√3	0.7	0.7	± 1.9 %	± 1.9 %
Hemispherical Isotropy	9.6	Rectangular	√3	0.7	0.7	± 3.9 %	± 3.9 %
Boundary Effects	1.0	Rectangular	√3	1	1	± 0.6 %	± 0.6 %
Linearity	4.7	Rectangular	√3	1	1	± 2.7 %	± 2.7 %
System Detection Limits	1.0	Rectangular	√3	1	1	± 0.6 %	± 0.6 %
Readout Electronics	0.3	Normal	1	1	1	± 0.3 %	± 0.3 %
Response Time	0.8	Rectangular	√3	1	1	± 0.5 %	± 0.5 %
Integration Time	2.6	Rectangular	√3	1	1	± 1.5 %	± 1.5 %
RF Ambient Noise	3.0	Rectangular	√3	1	1	± 1.7 %	± 1.7 %
RF Ambient Reflections	3.0	Rectangular	√3	1	1	± 1.7 %	± 1.7 %
Probe Positioner	0.4	Rectangular	√3	1	1	± 0.2 %	± 0.2 %
Probe Positioning	2.9	Rectangular	√3	1	1	± 1.7 %	± 1.7 %
Max. SAR Eval.	1.0	Rectangular	√3	1	1	± 0.6 %	± 0.6 %
Test Sample Related							
Device Positioning	2.9	Normal	1	1	1	± 2.9 %	± 2.9 %
Device Holder	3.6	Normal	1	1	1	± 3.6 %	± 3.6 %
Power Drift	5.0	Rectangular	√3	1	1	± 2.9 %	± 2.9 %
Phantom and Setup							
Phantom Uncertainty	4.0	Rectangular	√3	1	1	± 2.3 %	± 2.3 %
Liquid Conductivity (Target)	5.0	Rectangular	√3	0.64	0.43	± 1.8 %	± 1.2 %
Liquid Conductivity (Meas.)	2.5	Normal	1	0.64	0.43	± 1.6 %	± 1.1 %
Liquid Permittivity (Target)	5.0	Rectangular	√3	0.6	0.49	± 1.7 %	± 1.4 %
Liquid Permittivity (Meas.)	2.5	Normal	1	0.6	0.49	± 1.5 %	± 1.2 %
Combined Standard Uncertainty						± 11.0 %	± 10.8 %
Coverage Factor for 95 %						K=2	
Expanded Uncertainty						± 22.0 %	± 21.5 %

Table 12.2 Uncertainty Budget of DASYS for frequency range 300 MHz to 3 GHz according to IEEE 1528-2003



14. References

- [1] FCC 47 CFR Part 2 “Frequency Allocations and Radio Treaty Matters; General Rules and Regulations”
- [2] ANSI/IEEE Std. C95.1-1992, “IEEE Standard for Safety Levels with Respect to Human Exposure to Radio Frequency Electromagnetic Fields, 3 kHz to 300 GHz”, September 1992
- [3] IEEE Std. 1528-2003, “Recommended Practice for Determining the Peak Spatial-Average Specific Absorption Rate (SAR) in the Human Head from Wireless Communications Devices: Measurement Techniques”, December 2003
- [4] FCC OET Bulletin 65 (Edition 97-01) Supplement C (Edition 01-01), “Evaluating Compliance with FCC Guidelines for Human Exposure to Radiofrequency Electromagnetic Fields”, June 2001
- [5] SPEAG DASY System Handbook
- [6] FCC KDB 447498 D01 v05, “Mobile and Portable Device RF Exposure Procedures and Equipment Authorization Policies”, October 2012
- [7] FCC KDB 648474 D04 v01, “SAR Evaluation Considerations for Handsets with Multiple Transmitters and Antennas”, October 2012
- [8] FCC KDB 941225 D03 v01, “Recommended SAR Test Reduction Procedures for GSM / GPRS / EDGE”, December 2008
- [9] FCC KDB 865664 D01 v01” SAR Measurement Requirements for 100 MHz to 6 GHz” , October 2012



Appendix A. Plots of System Performance Check

The plots are shown as follows.

System Check_Head_835MHz_130204

DUT: D835V2 - SN:4d091

Communication System: CW; Frequency: 835 MHz; Duty Cycle: 1:1

Medium: HSL_835_130204 Medium parameters used: $f = 835 \text{ MHz}$; $\sigma = 0.919 \text{ mho/m}$; $\epsilon_r = 41.524$; $\rho = 1000 \text{ kg/m}^3$

Ambient Temperature : $23.5 \text{ }^\circ\text{C}$; Liquid Temperature : $21.6 \text{ }^\circ\text{C}$

DASY5 Configuration:

- Probe: EX3DV4 - SN3819; ConvF(9.56, 9.56, 9.56); Calibrated: 26.11.2012;
- Sensor-Surface: 2mm (Mechanical Surface Detection)
- Electronics: DAE4 Sn1303; Calibrated: 22.11.2012
- Phantom: SAM2; Type: QD000P40CD; Serial: TP:1671
- Measurement SW: DASY52, Version 52.8 (2); SEMCAD X Version 14.6.6 (6824)

Pin=250mW/Area Scan (61x61x1): Interpolated grid: $dx=15\text{mm}$, $dy=15\text{mm}$

Maximum value of SAR (interpolated) = 3.21 W/kg

Pin=250mW/Zoom Scan (5x5x7)/Cube 0: Measurement grid: $dx=8\text{mm}$, $dy=8\text{mm}$, $dz=5\text{mm}$

Reference Value = 60.019 V/m ; Power Drift = 0.01 dB

Peak SAR (extrapolated) = 3.790 mW/g

SAR(1 g) = 2.52 mW/g ; SAR(10 g) = 1.65 mW/g

Maximum value of SAR (measured) = 3.18 W/kg

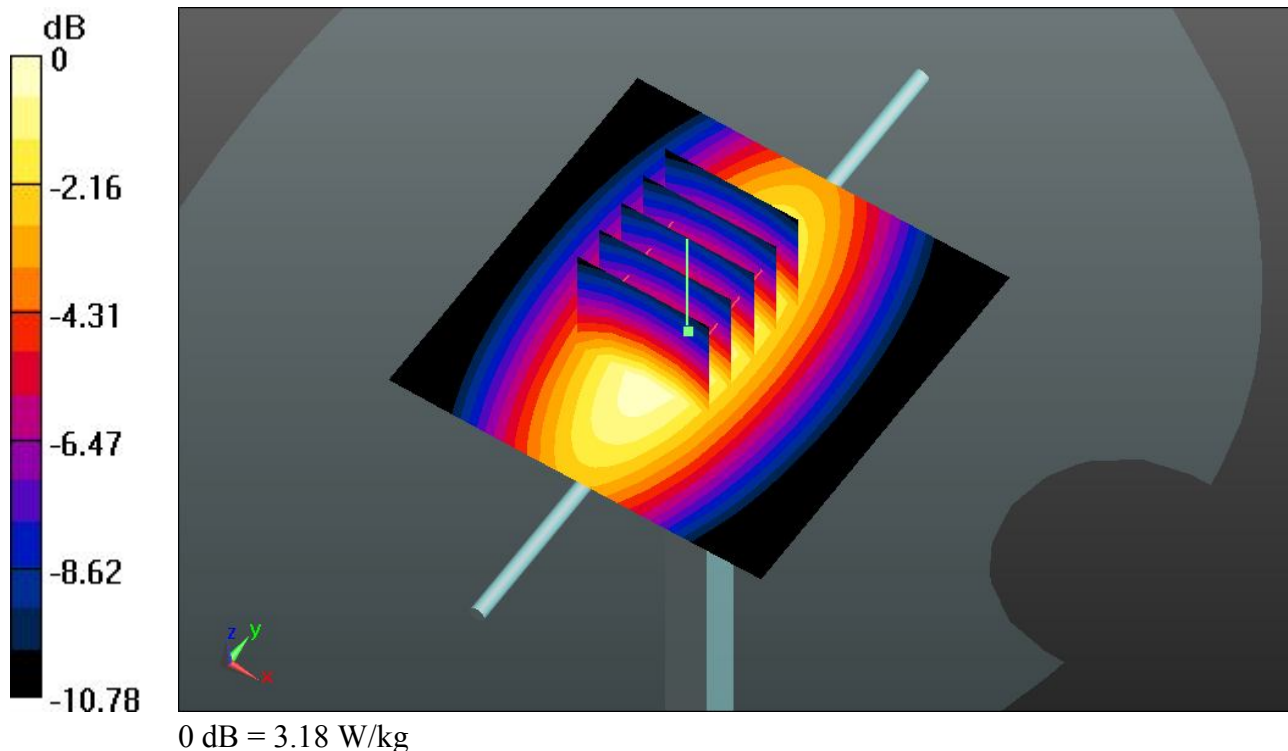

System Check_Head_1900MHz_130204

DUT: D1900V2 - SN:5d118

Communication System: CW; Frequency: 1900 MHz; Duty Cycle: 1:1

Medium: HSL_1900_130204 Medium parameters used: $f = 1900$ MHz; $\sigma = 1.412$ mho/m; $\epsilon_r =$

39.311 ; $\rho = 1000$ kg/m³

Ambient Temperature : 23.5 °C ; Liquid Temperature : 21.3 °C

DASY5 Configuration:

- Probe: EX3DV4 - SN3819; ConvF(7.84, 7.84, 7.84); Calibrated: 26.11.2012;
- Sensor-Surface: 2mm (Mechanical Surface Detection)
- Electronics: DAE4 Sn1303; Calibrated: 22.11.2012
- Phantom: SAM2; Type: QD000P40CD; Serial: TP:1671
- Measurement SW: DASY52, Version 52.8 (2); SEMCAD X Version 14.6.6 (6824)

Pin=250mW/Area Scan (61x61x1): Interpolated grid: dx=15mm, dy=15mm

Maximum value of SAR (interpolated) = 14.4 W/kg

Pin=250mW/Zoom Scan (5x5x7)/Cube 0: Measurement grid: dx=8mm, dy=8mm, dz=5mm

Reference Value = 101.6 V/m; Power Drift = 0.02 dB

Peak SAR (extrapolated) = 18.562 mW/g

SAR(1 g) = 9.95 mW/g; SAR(10 g) = 5.12 mW/g

Maximum value of SAR (measured) = 14.0 W/kg

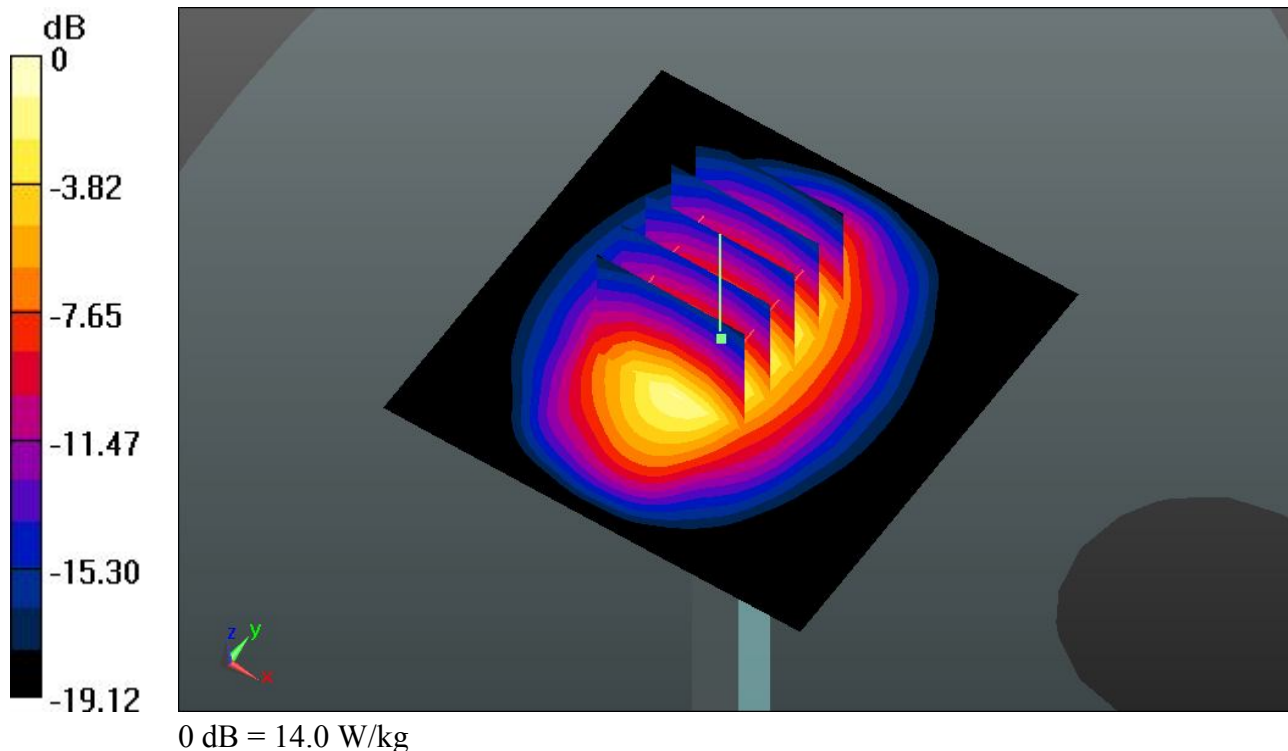

System Check_Body_835MHz_130204

DUT: D835V2 - SN:4d091

Communication System: CW; Frequency: 835 MHz; Duty Cycle: 1:1

Medium: MSL_835_130204 Medium parameters used: $f = 835$ MHz; $\sigma = 0.971$ mho/m; $\epsilon_r = 56$; $\rho = 1000$ kg/m³

Ambient Temperature : 23.5 °C ; Liquid Temperature : 21.5 °C

DASY5 Configuration:

- Probe: EX3DV4 - SN3819; ConvF(9.5, 9.5, 9.5); Calibrated: 26.11.2012;
- Sensor-Surface: 2mm (Mechanical Surface Detection)
- Electronics: DAE4 Sn1303; Calibrated: 22.11.2012
- Phantom: SAM1; Type: QD000P40CD; Serial: TP:1670
- Measurement SW: DASY52, Version 52.8 (2); SEMCAD X Version 14.6.6 (6824)

Pin=250mW/Area Scan (61x61x1): Interpolated grid: dx=15mm, dy=15mm

Maximum value of SAR (interpolated) = 2.60 W/kg

Pin=250mW/Zoom Scan (5x5x7)/Cube 0: Measurement grid: dx=8mm, dy=8mm, dz=5mm

Reference Value = 52.017 V/m; Power Drift = -0.01 dB

Peak SAR (extrapolated) = 3.542 mW/g

SAR(1 g) = 2.42 mW/g; SAR(10 g) = 1.6 mW/g

Maximum value of SAR (measured) = 2.59 W/kg

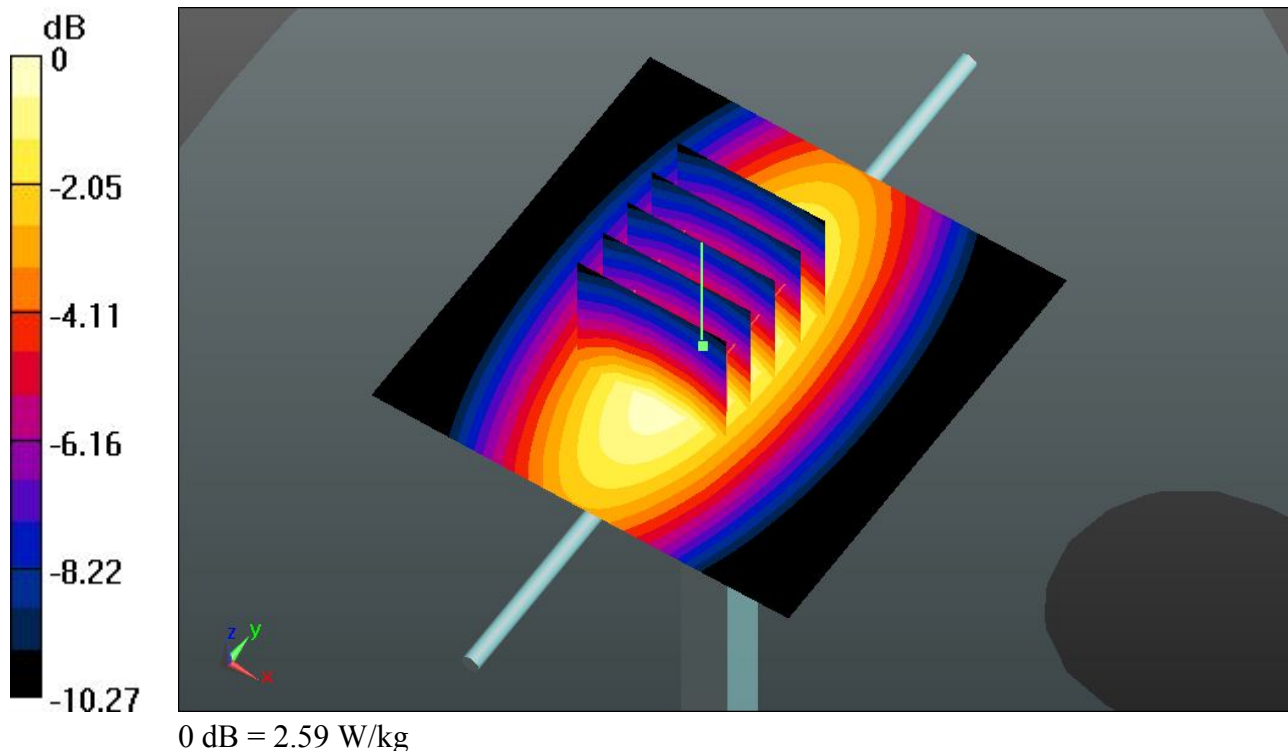

System Check_Body_1900MHz_130204

DUT: D1900V2 - SN:5d118

Communication System: CW; Frequency: 1900 MHz; Duty Cycle: 1:1

Medium: MSL_1900_130204 Medium parameters used: $f = 1900 \text{ MHz}$; $\sigma = 1.519 \text{ mho/m}$; $\epsilon_r =$

53.569 ; $\rho = 1000 \text{ kg/m}^3$

Ambient Temperature : $23.4 \text{ }^\circ\text{C}$; Liquid Temperature : $21.4 \text{ }^\circ\text{C}$

DASY5 Configuration:

- Probe: EX3DV4 - SN3819; ConvF(7.67, 7.67, 7.67); Calibrated: 26.11.2012;
- Sensor-Surface: 2mm (Mechanical Surface Detection)
- Electronics: DAE4 Sn1303; Calibrated: 22.11.2012
- Phantom: SAM1; Type: QD000P40CD; Serial: TP:1670
- Measurement SW: DASY52, Version 52.8 (2); SEMCAD X Version 14.6.6 (6824)

Pin=250mW/Area Scan (61x61x1): Interpolated grid: $dx=15\text{mm}$, $dy=15\text{mm}$

Maximum value of SAR (interpolated) = 14.7 W/kg

Pin=250mW/Zoom Scan (5x5x7)/Cube 0: Measurement grid: $dx=8\text{mm}$, $dy=8\text{mm}$, $dz=5\text{mm}$

Reference Value = 86.965 V/m ; Power Drift = 0.02 dB

Peak SAR (extrapolated) = 18.699 mW/g

SAR(1 g) = 10.3 mW/g ; SAR(10 g) = 5.35 mW/g

Maximum value of SAR (measured) = 14.8 W/kg

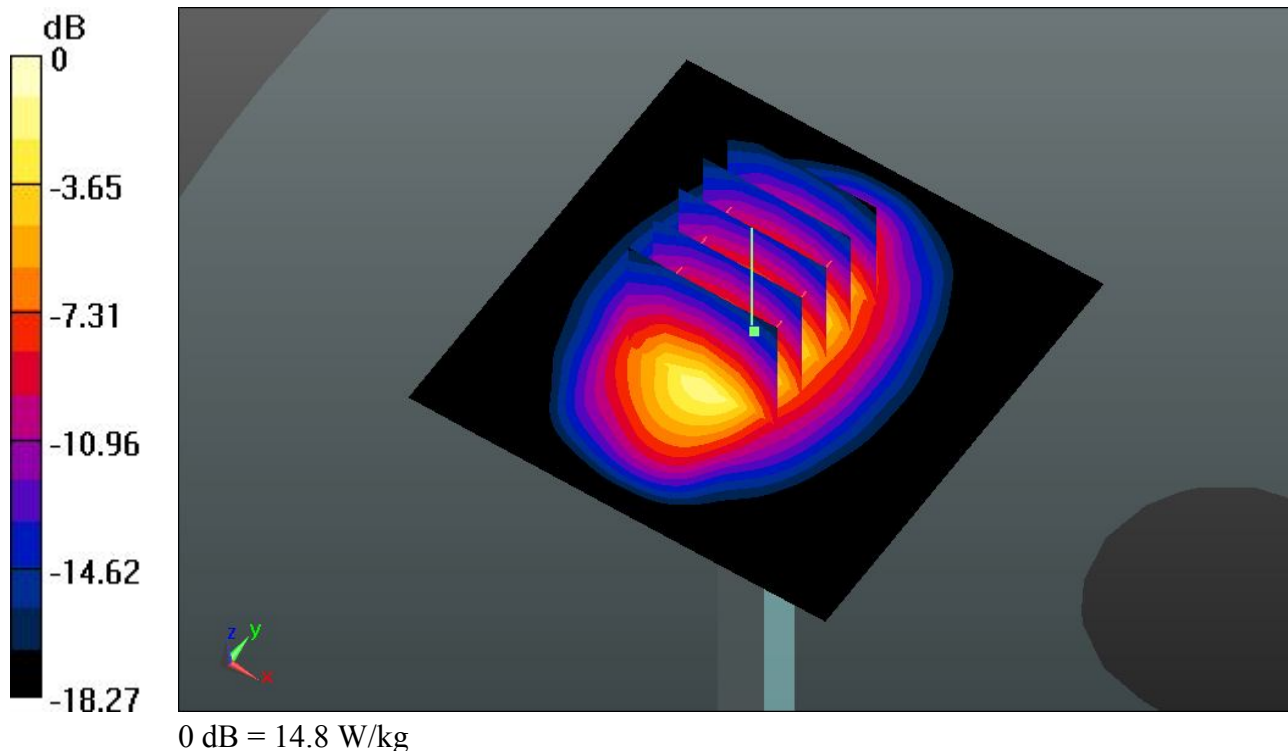



Appendix B. Plots of SAR Measurement

The plots are shown as follows.

03 GSM850_GSM Voice_Right Cheek_Ch251

DUT: 312402

Communication System: Generic GSM; Frequency: 848.8 MHz; Duty Cycle: 1:8.3

Medium: HSL_835_130204 Medium parameters used: $f = 849$ MHz; $\sigma = 0.93$ mho/m; $\epsilon_r = 41.373$; $\rho = 1000$ kg/m³

Ambient Temperature : 23.5 °C ; Liquid Temperature : 21.6 °C

DASY5 Configuration:

- Probe: EX3DV4 - SN3819; ConvF(9.56, 9.56, 9.56); Calibrated: 26.11.2012;
- Sensor-Surface: 2mm (Mechanical Surface Detection)
- Electronics: DAE4 Sn1303; Calibrated: 22.11.2012
- Phantom: SAM2; Type: QD000P40CD; Serial: TP:1671
- Measurement SW: DASY52, Version 52.8 (2); SEMCAD X Version 14.6.6 (6824)

Ch251/Area Scan (51x91x1): Interpolated grid: dx=15mm, dy=15mm

Maximum value of SAR (interpolated) = 0.659 W/kg

Ch251/Zoom Scan (5x5x7)/Cube 0: Measurement grid: dx=8mm, dy=8mm, dz=5mm

Reference Value = 27.253 V/m; Power Drift = 0.05 dB

Peak SAR (extrapolated) = 0.756 mW/g

SAR(1 g) = 0.570 mW/g; SAR(10 g) = 0.411 mW/g

Maximum value of SAR (measured) = 0.683 W/kg

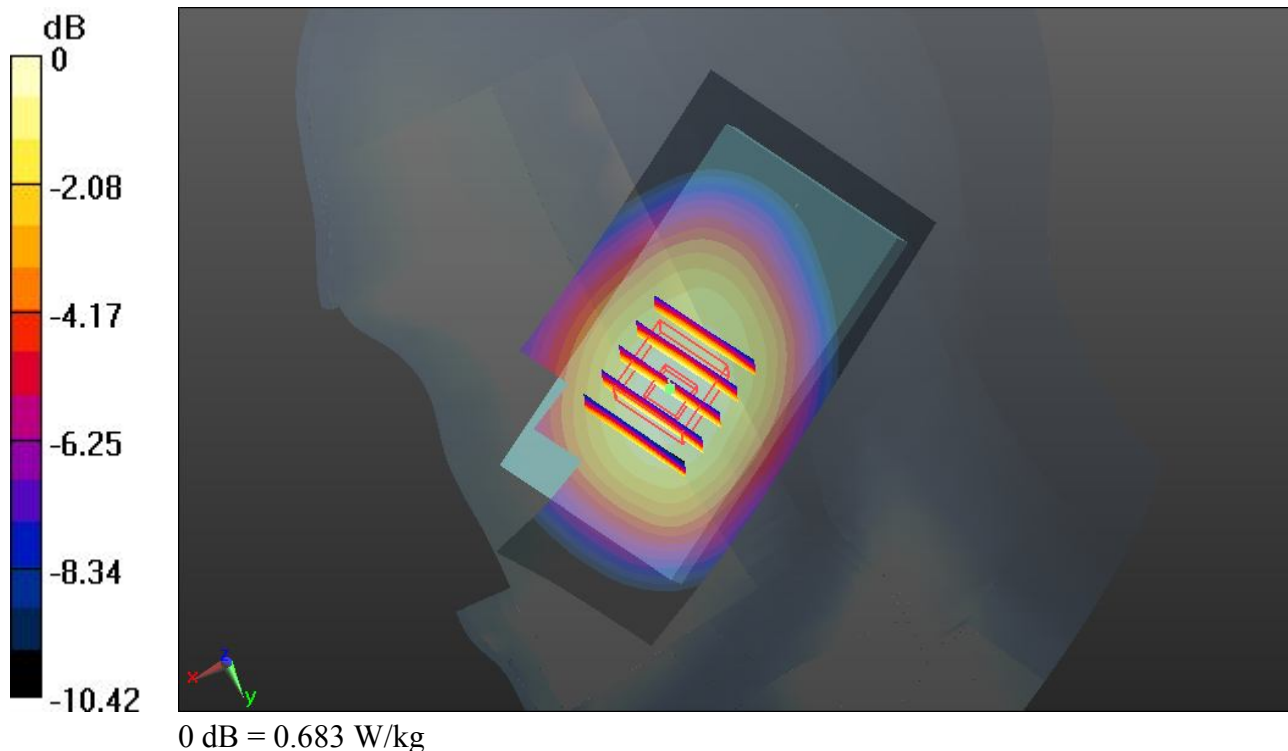

04 GSM850_GSM Voice_Right Tilted_Ch251

DUT: 312402

Communication System: Generic GSM; Frequency: 848.8 MHz; Duty Cycle: 1:8.3

Medium: HSL_835_130204 Medium parameters used: $f = 849$ MHz; $\sigma = 0.93$ mho/m; $\epsilon_r = 41.373$; $\rho = 1000$ kg/m³

Ambient Temperature : 23.5 °C ; Liquid Temperature : 21.6 °C

DASY5 Configuration:

- Probe: EX3DV4 - SN3819; ConvF(9.56, 9.56, 9.56); Calibrated: 26.11.2012;
- Sensor-Surface: 2mm (Mechanical Surface Detection)
- Electronics: DAE4 Sn1303; Calibrated: 22.11.2012
- Phantom: SAM2; Type: QD000P40CD; Serial: TP:1671
- Measurement SW: DASY52, Version 52.8 (2); SEMCAD X Version 14.6.6 (6824)

Ch251/Area Scan (51x91x1): Interpolated grid: dx=15mm, dy=15mm

Maximum value of SAR (interpolated) = 0.414 W/kg

Ch251/Zoom Scan (5x5x7)/Cube 0: Measurement grid: dx=8mm, dy=8mm, dz=5mm

Reference Value = 21.759 V/m; Power Drift = 0.02 dB

Peak SAR (extrapolated) = 0.470 mW/g

SAR(1 g) = 0.363 mW/g; SAR(10 g) = 0.268 mW/g

Maximum value of SAR (measured) = 0.425 W/kg

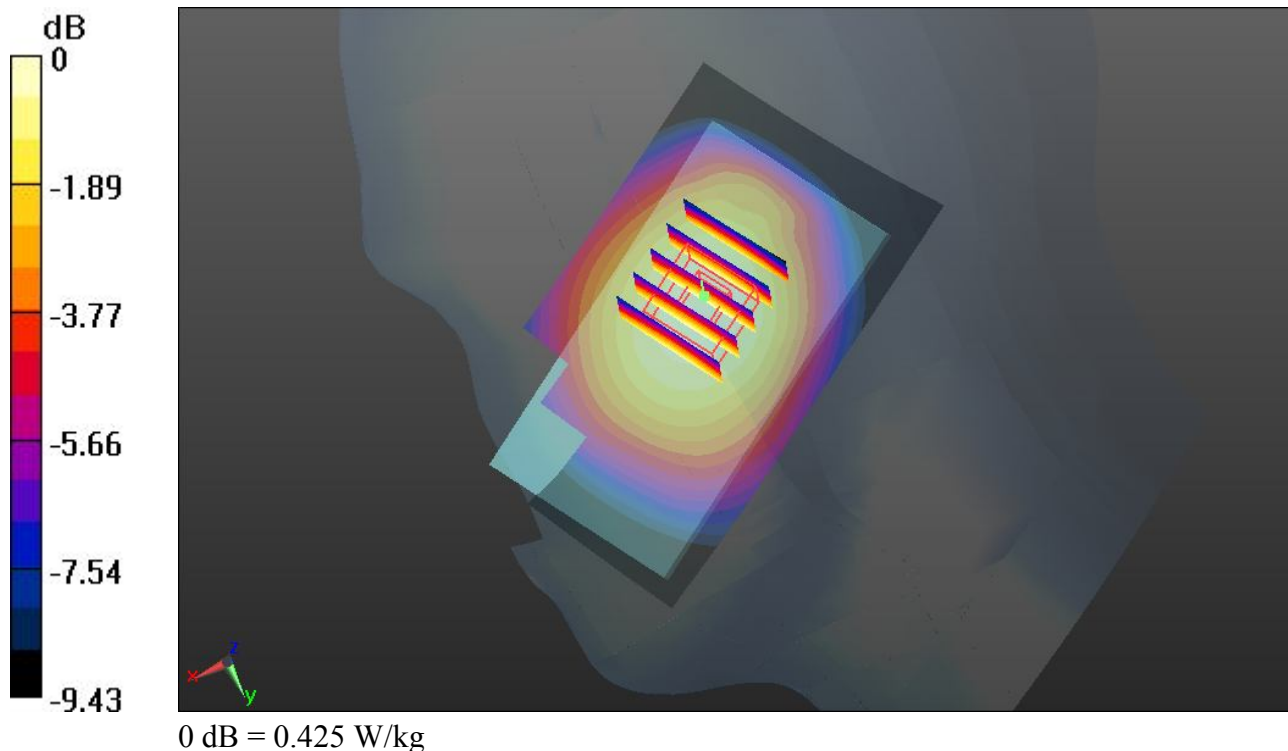

05 GSM850_GSM Voice_Left Cheek_Ch251

DUT: 312402

Communication System: Generic GSM; Frequency: 848.8 MHz; Duty Cycle: 1:8.3

Medium: HSL_835_130204 Medium parameters used: $f = 849$ MHz; $\sigma = 0.93$ mho/m; $\epsilon_r = 41.373$; $\rho = 1000$ kg/m³

Ambient Temperature : 23.5 °C ; Liquid Temperature : 21.6 °C

DASY5 Configuration:

- Probe: EX3DV4 - SN3819; ConvF(9.56, 9.56, 9.56); Calibrated: 26.11.2012;
- Sensor-Surface: 2mm (Mechanical Surface Detection)
- Electronics: DAE4 Sn1303; Calibrated: 22.11.2012
- Phantom: SAM2; Type: QD000P40CD; Serial: TP:1671
- Measurement SW: DASY52, Version 52.8 (2); SEMCAD X Version 14.6.6 (6824)

Ch251/Area Scan (51x91x1): Interpolated grid: dx=15mm, dy=15mm

Maximum value of SAR (interpolated) = 0.779 W/kg

Ch251/Zoom Scan (5x5x7)/Cube 0: Measurement grid: dx=8mm, dy=8mm, dz=5mm

Reference Value = 30.400 V/m; Power Drift = 0.02 dB

Peak SAR (extrapolated) = 0.900 mW/g

SAR(1 g) = 0.670 mW/g; SAR(10 g) = 0.481 mW/g

Maximum value of SAR (measured) = 0.813 W/kg

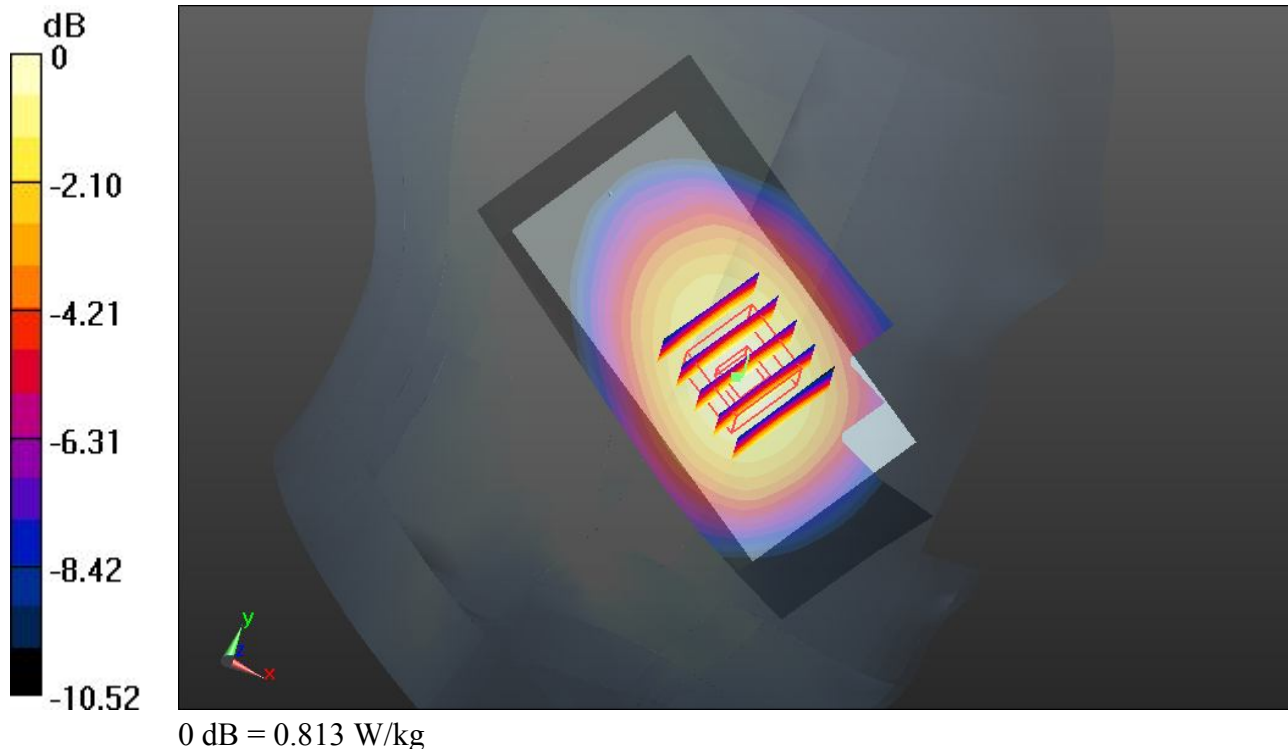

06 GSM850_GSM Voice_Left Tilted_Ch251

DUT: 312402

Communication System: Generic GSM; Frequency: 848.8 MHz; Duty Cycle: 1:8.3

Medium: HSL_835_130204 Medium parameters used: $f = 849$ MHz; $\sigma = 0.93$ mho/m; $\epsilon_r = 41.373$; $\rho = 1000$ kg/m³

Ambient Temperature : 23.5 °C ; Liquid Temperature : 21.6 °C

DASY5 Configuration:

- Probe: EX3DV4 - SN3819; ConvF(9.56, 9.56, 9.56); Calibrated: 26.11.2012;
- Sensor-Surface: 2mm (Mechanical Surface Detection)
- Electronics: DAE4 Sn1303; Calibrated: 22.11.2012
- Phantom: SAM2; Type: QD000P40CD; Serial: TP:1671
- Measurement SW: DASY52, Version 52.8 (2); SEMCAD X Version 14.6.6 (6824)

Ch251/Area Scan (51x91x1): Interpolated grid: dx=15mm, dy=15mm

Maximum value of SAR (interpolated) = 0.449 W/kg

Ch251/Zoom Scan (5x5x7)/Cube 0: Measurement grid: dx=8mm, dy=8mm, dz=5mm

Reference Value = 22.427 V/m; Power Drift = 0.01 dB

Peak SAR (extrapolated) = 0.503 mW/g

SAR(1 g) = 0.388 mW/g; SAR(10 g) = 0.287 mW/g

Maximum value of SAR (measured) = 0.452 W/kg

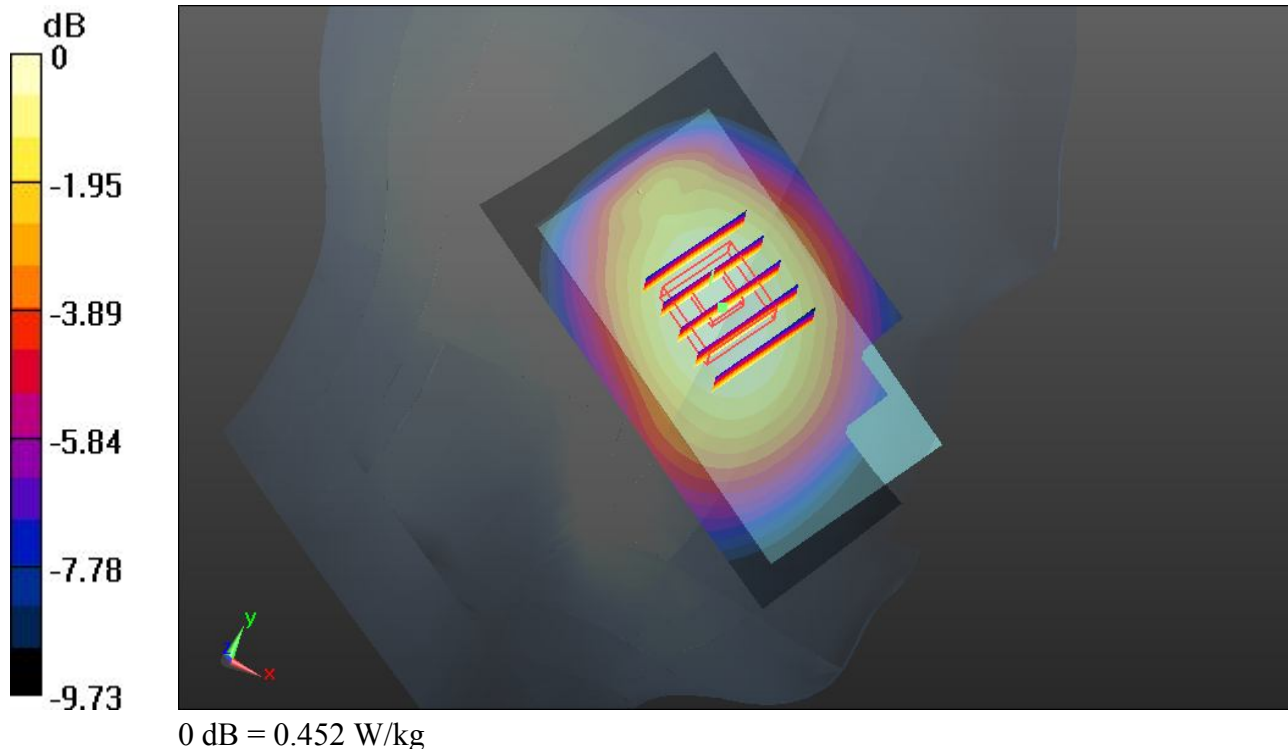

09 GSM1900_GSM Voice_Right Cheek_Ch661

DUT: 312402

Communication System: Generic GSM; Frequency: 1880 MHz; Duty Cycle: 1:8.3
Medium: HSL_1900_130204 Medium parameters used: $f = 1880$ MHz; $\sigma = 1.387$ mho/m; $\epsilon_r = 39.308$; $\rho = 1000$ kg/m³
Ambient Temperature : 23.5 °C ; Liquid Temperature : 21.3 °C

DASY5 Configuration:

- Probe: EX3DV4 - SN3819; ConvF(7.84, 7.84, 7.84); Calibrated: 26.11.2012;
- Sensor-Surface: 2mm (Mechanical Surface Detection)
- Electronics: DAE4 Sn1303; Calibrated: 22.11.2012
- Phantom: SAM2; Type: QD000P40CD; Serial: TP:1671
- Measurement SW: DASY52, Version 52.8 (2); SEMCAD X Version 14.6.6 (6824)

Ch661/Area Scan (51x91x1): Interpolated grid: dx=15mm, dy=15mm

Maximum value of SAR (interpolated) = 0.708 W/kg

Ch661/Zoom Scan (5x5x7)/Cube 0: Measurement grid: dx=8mm, dy=8mm, dz=5mm

Reference Value = 22.396 V/m; Power Drift = 0.04 dB

Peak SAR (extrapolated) = 0.843 mW/g

SAR(1 g) = 0.546 mW/g; SAR(10 g) = 0.333 mW/g

Maximum value of SAR (measured) = 0.684 W/kg

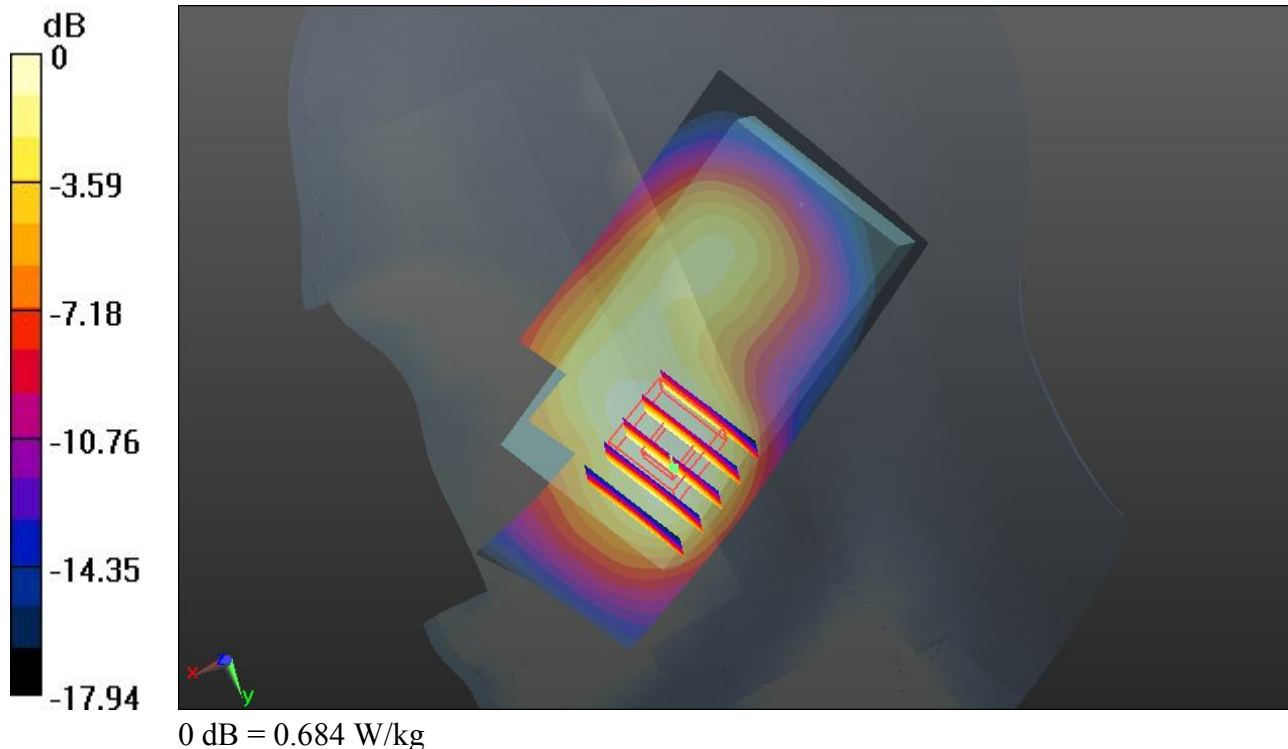

10 GSM1900_GSM Voice_Right Tilted_Ch661

DUT: 312402

Communication System: Generic GSM; Frequency: 1880 MHz; Duty Cycle: 1:8.3

Medium: HSL_1900_130204 Medium parameters used: $f = 1880$ MHz; $\sigma = 1.387$ mho/m; $\epsilon_r =$

39.308 ; $\rho = 1000$ kg/m³

Ambient Temperature : 23.5 °C ; Liquid Temperature : 21.3 °C

DASY5 Configuration:

- Probe: EX3DV4 - SN3819; ConvF(7.84, 7.84, 7.84); Calibrated: 26.11.2012;
- Sensor-Surface: 2mm (Mechanical Surface Detection)
- Electronics: DAE4 Sn1303; Calibrated: 22.11.2012
- Phantom: SAM2; Type: QD000P40CD; Serial: TP:1671
- Measurement SW: DASY52, Version 52.8 (2); SEMCAD X Version 14.6.6 (6824)

Ch661/Area Scan (51x91x1): Interpolated grid: dx=15mm, dy=15mm

Maximum value of SAR (interpolated) = 0.394 W/kg

Ch661/Zoom Scan (5x5x7)/Cube 0: Measurement grid: dx=8mm, dy=8mm, dz=5mm

Reference Value = 16.688 V/m; Power Drift = -0.09 dB

Peak SAR (extrapolated) = 0.445 mW/g

SAR(1 g) = 0.292 mW/g; SAR(10 g) = 0.176 mW/g

Maximum value of SAR (measured) = 0.367 W/kg

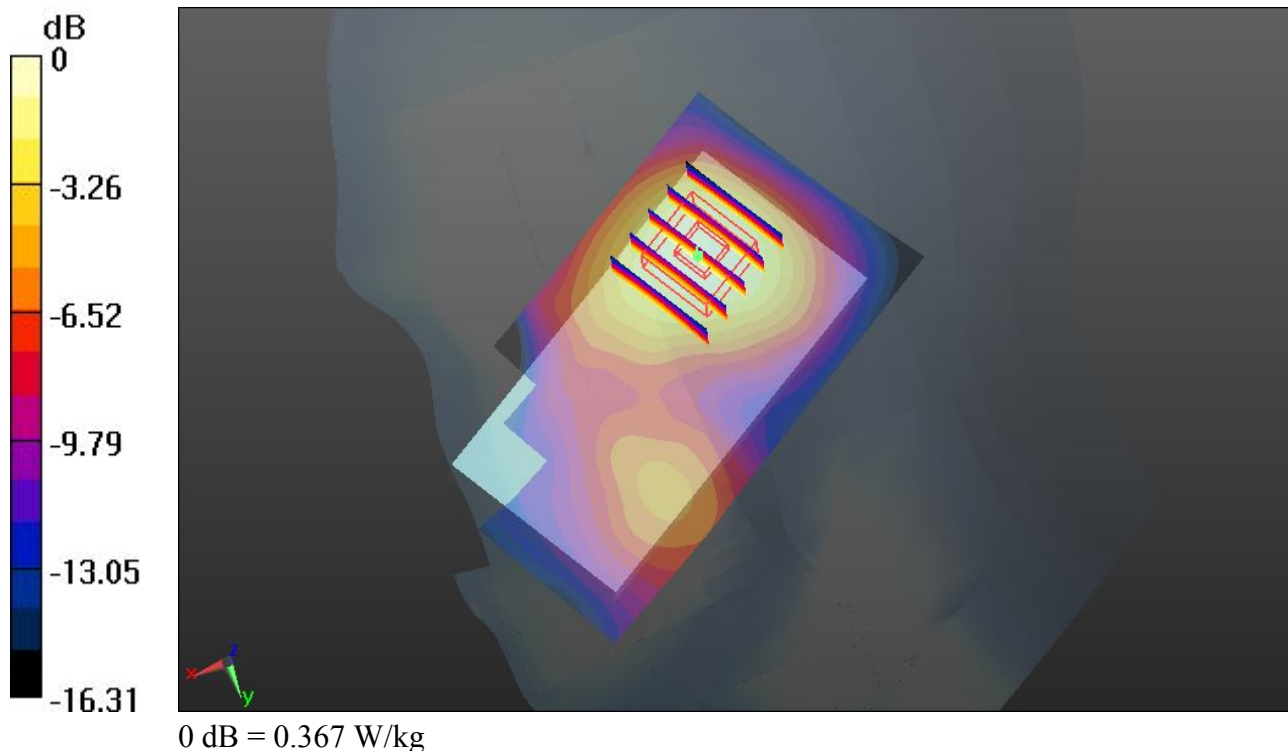

11 GSM1900_GSM Voice_Left Cheek_Ch661

DUT: 312402

Communication System: Generic GSM; Frequency: 1880 MHz; Duty Cycle: 1:8.3
 Medium: HSL_1900_130204 Medium parameters used: $f = 1880 \text{ MHz}$; $\sigma = 1.387 \text{ mho/m}$; $\epsilon_r = 39.308$; $\rho = 1000 \text{ kg/m}^3$
 Ambient Temperature : $23.5 \text{ }^\circ\text{C}$; Liquid Temperature : $21.3 \text{ }^\circ\text{C}$

DASY5 Configuration:

- Probe: EX3DV4 - SN3819; ConvF(7.84, 7.84, 7.84); Calibrated: 26.11.2012;
- Sensor-Surface: 2mm (Mechanical Surface Detection)
- Electronics: DAE4 Sn1303; Calibrated: 22.11.2012
- Phantom: SAM2; Type: QD000P40CD; Serial: TP:1671
- Measurement SW: DASY52, Version 52.8 (2); SEMCAD X Version 14.6.6 (6824)

Ch661/Area Scan (51x91x1): Interpolated grid: $dx=15\text{mm}$, $dy=15\text{mm}$

Maximum value of SAR (interpolated) = 0.799 W/kg

Ch661/Zoom Scan (5x5x7)/Cube 0: Measurement grid: $dx=8\text{mm}$, $dy=8\text{mm}$, $dz=5\text{mm}$

Reference Value = 24.070 V/m ; Power Drift = -0.04 dB

Peak SAR (extrapolated) = 0.917 mW/g

SAR(1 g) = 0.623 mW/g ; SAR(10 g) = 0.386 mW/g

Maximum value of SAR (measured) = 0.765 W/kg



12 GSM1900_GSM Voice_Left Tilted_Ch661

DUT: 312402

Communication System: Generic GSM; Frequency: 1880 MHz; Duty Cycle: 1:8.3

Medium: HSL_1900_130204 Medium parameters used: $f = 1880$ MHz; $\sigma = 1.387$ mho/m; $\epsilon_r =$

39.308 ; $\rho = 1000$ kg/m³

Ambient Temperature : 23.5 °C ; Liquid Temperature : 21.3 °C

DASY5 Configuration:

- Probe: EX3DV4 - SN3819; ConvF(7.84, 7.84, 7.84); Calibrated: 26.11.2012;
- Sensor-Surface: 2mm (Mechanical Surface Detection)
- Electronics: DAE4 Sn1303; Calibrated: 22.11.2012
- Phantom: SAM2; Type: QD000P40CD; Serial: TP:1671
- Measurement SW: DASY52, Version 52.8 (2); SEMCAD X Version 14.6.6 (6824)

Ch661/Area Scan (51x91x1): Interpolated grid: dx=15mm, dy=15mm

Maximum value of SAR (interpolated) = 0.339 W/kg

Ch661/Zoom Scan (5x5x7)/Cube 0: Measurement grid: dx=8mm, dy=8mm, dz=5mm

Reference Value = 15.611 V/m; Power Drift = -0.02 dB

Peak SAR (extrapolated) = 0.402 mW/g

SAR(1 g) = 0.258 mW/g; SAR(10 g) = 0.155 mW/g

Maximum value of SAR (measured) = 0.332 W/kg

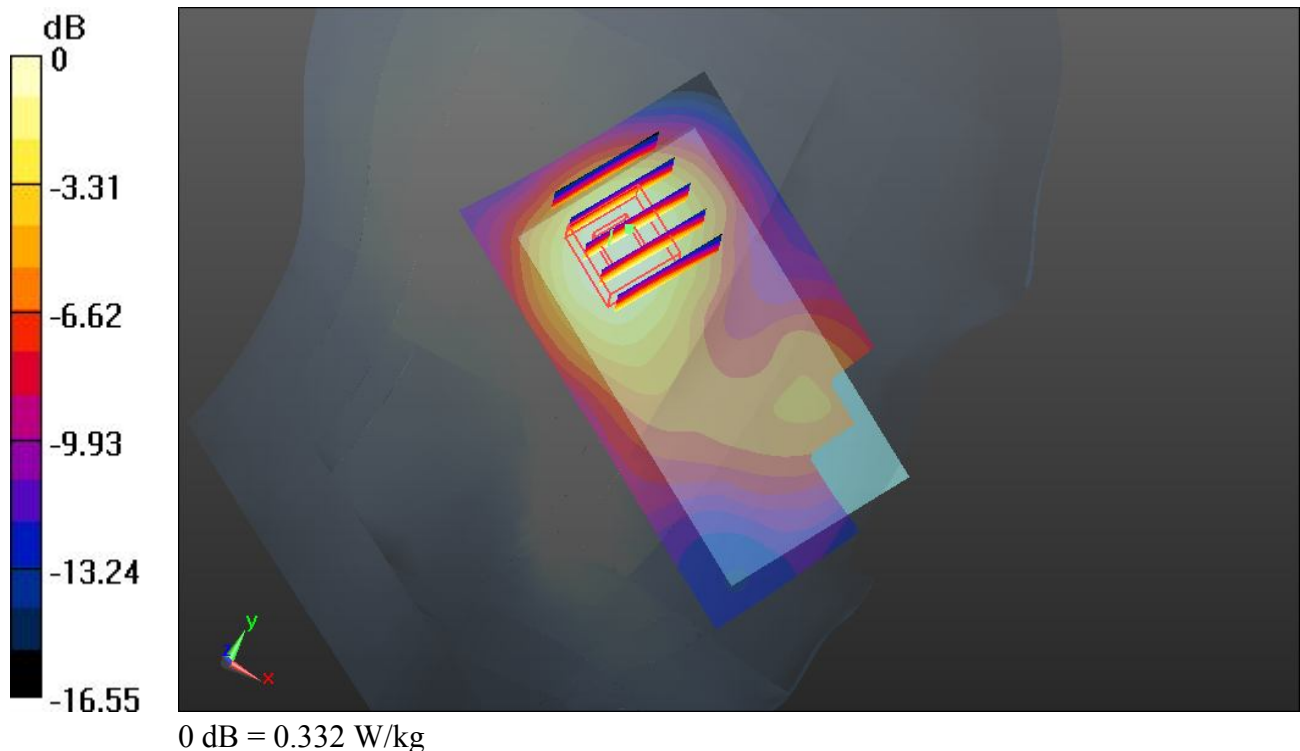

01 GSM850_GSM Voice_Front_1.5cm_Ch251

DUT: 312402

Communication System: Generic GSM; Frequency: 848.8 MHz; Duty Cycle: 1:8.3

Medium: MSL_835_130204 Medium parameters used: $f = 849$ MHz; $\sigma = 0.983$ mho/m; $\epsilon_r = 55.871$;

$\rho = 1000$ kg/m³

Ambient Temperature : 23.5 °C ; Liquid Temperature : 21.5 °C

DASY5 Configuration:

- Probe: EX3DV4 - SN3819; ConvF(9.5, 9.5, 9.5); Calibrated: 26.11.2012;
- Sensor-Surface: 2mm (Mechanical Surface Detection)
- Electronics: DAE4 Sn1303; Calibrated: 22.11.2012
- Phantom: SAM1; Type: QD000P40CD; Serial: TP:1670
- Measurement SW: DASY52, Version 52.8 (2); SEMCAD X Version 14.6.6 (6824)

Ch251/Area Scan (51x91x1): Interpolated grid: dx=15mm, dy=15mm

Maximum value of SAR (interpolated) = 0.449 W/kg

Ch251/Zoom Scan (5x5x7)/Cube 0: Measurement grid: dx=8mm, dy=8mm, dz=5mm

Reference Value = 21.920 V/m; Power Drift = -0.01 dB

Peak SAR (extrapolated) = 0.500 mW/g

SAR(1 g) = 0.384 mW/g; SAR(10 g) = 0.281 mW/g

Maximum value of SAR (measured) = 0.450 W/kg

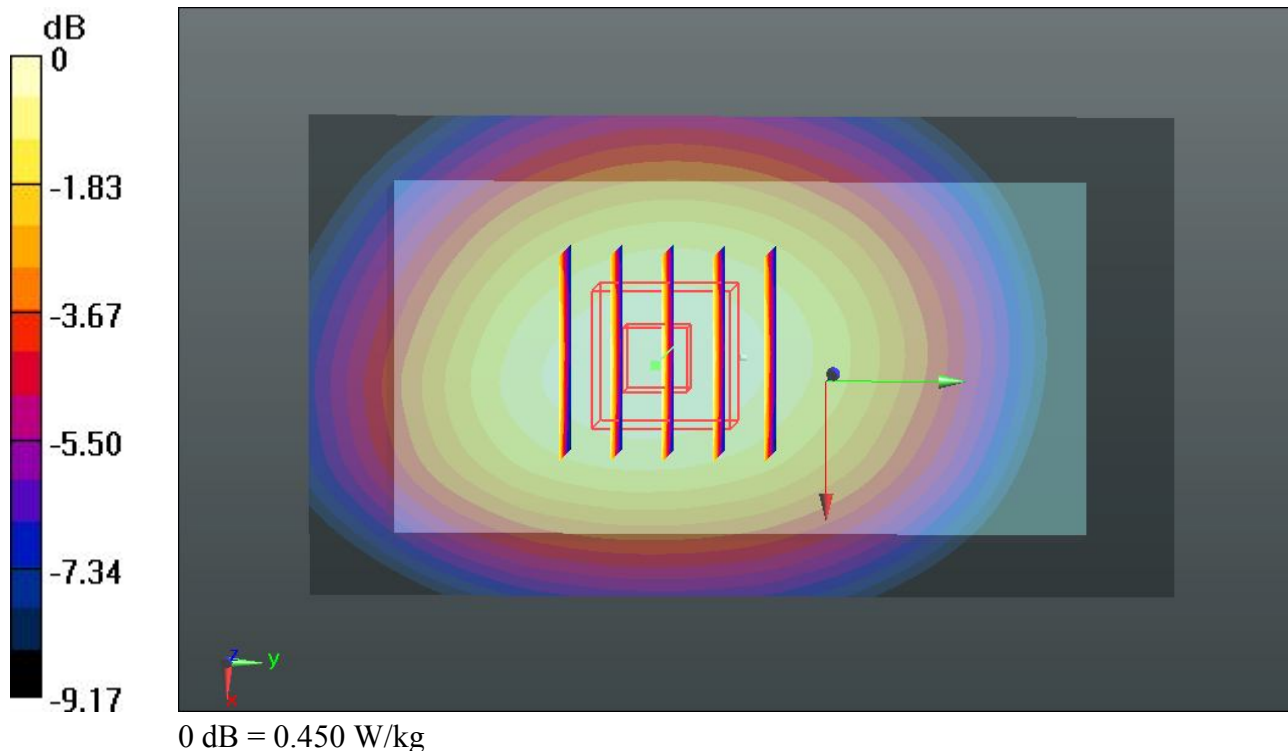

02 GSM850_GSM Voice_Back_1.5cm_Ch251

DUT: 312402

Communication System: Generic GSM; Frequency: 848.8 MHz; Duty Cycle: 1:8.3

Medium: MSL_835_130204 Medium parameters used: $f = 849$ MHz; $\sigma = 0.983$ mho/m; $\epsilon_r = 55.871$; $\rho = 1000$ kg/m³

Ambient Temperature : 23.5 °C ; Liquid Temperature : 21.5 °C

DASY5 Configuration:

- Probe: EX3DV4 - SN3819; ConvF(9.5, 9.5, 9.5); Calibrated: 26.11.2012;
- Sensor-Surface: 2mm (Mechanical Surface Detection)
- Electronics: DAE4 Sn1303; Calibrated: 22.11.2012
- Phantom: SAM1; Type: QD000P40CD; Serial: TP:1670
- Measurement SW: DASY52, Version 52.8 (2); SEMCAD X Version 14.6.6 (6824)

Ch251/Area Scan (51x91x1): Interpolated grid: dx=15mm, dy=15mm

Maximum value of SAR (interpolated) = 0.667 W/kg

Ch251/Zoom Scan (5x5x7)/Cube 0: Measurement grid: dx=8mm, dy=8mm, dz=5mm

Reference Value = 26.648 V/m; Power Drift = 0.02 dB

Peak SAR (extrapolated) = 0.742 mW/g

SAR(1 g) = 0.562 mW/g; SAR(10 g) = 0.411 mW/g

Maximum value of SAR (measured) = 0.663 W/kg

Ch251/Zoom Scan (5x5x7)/Cube 1: Measurement grid: dx=8mm, dy=8mm, dz=5mm

Reference Value = 26.648 V/m; Power Drift = 0.02 dB

Peak SAR (extrapolated) = 0.727 mW/g

SAR(1 g) = 0.540 mW/g; SAR(10 g) = 0.380 mW/g

Maximum value of SAR (measured) = 0.652 W/kg

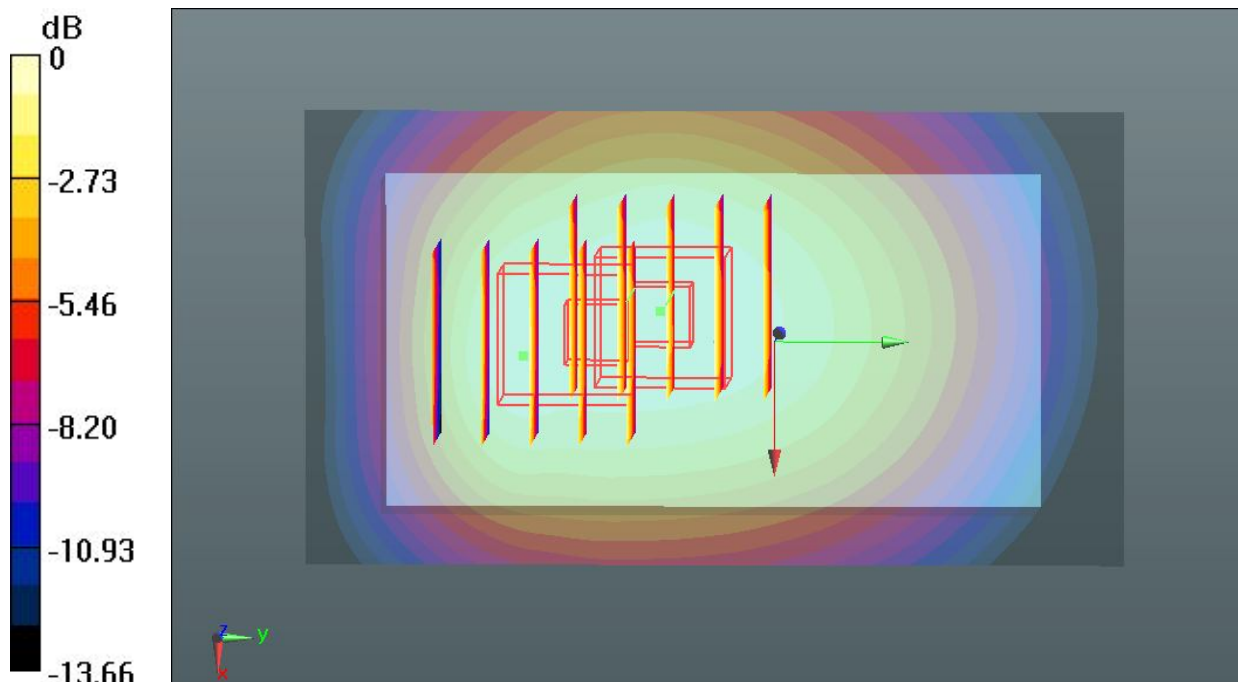

0 dB = 0.652 W/kg

07 GSM1900_GSM Voice_Front_1.5cm_Ch661

DUT: 312402

Communication System: Generic GSM; Frequency: 1880 MHz; Duty Cycle: 1:8.3
Medium: MSL_1900_130204 Medium parameters used: $f = 1880$ MHz; $\sigma = 1.498$ mho/m; $\epsilon_r = 53.575$; $\rho = 1000$ kg/m³
Ambient Temperature : 23.4 °C ; Liquid Temperature : 21.4 °C

DASY5 Configuration:

- Probe: EX3DV4 - SN3819; ConvF(7.67, 7.67, 7.67); Calibrated: 26.11.2012;
- Sensor-Surface: 2mm (Mechanical Surface Detection)
- Electronics: DAE4 Sn1303; Calibrated: 22.11.2012
- Phantom: SAM1; Type: QD000P40CD; Serial: TP:1670
- Measurement SW: DASY52, Version 52.8 (2); SEMCAD X Version 14.6.6 (6824)

Ch661/Area Scan (51x91x1): Interpolated grid: dx=15mm, dy=15mm

Maximum value of SAR (interpolated) = 0.343 W/kg

Ch661/Zoom Scan (5x5x7)/Cube 0: Measurement grid: dx=8mm, dy=8mm, dz=5mm

Reference Value = 15.345 V/m; Power Drift = -0.03 dB

Peak SAR (extrapolated) = 0.415 mW/g

SAR(1 g) = 0.259 mW/g; SAR(10 g) = 0.156 mW/g

Maximum value of SAR (measured) = 0.339 W/kg

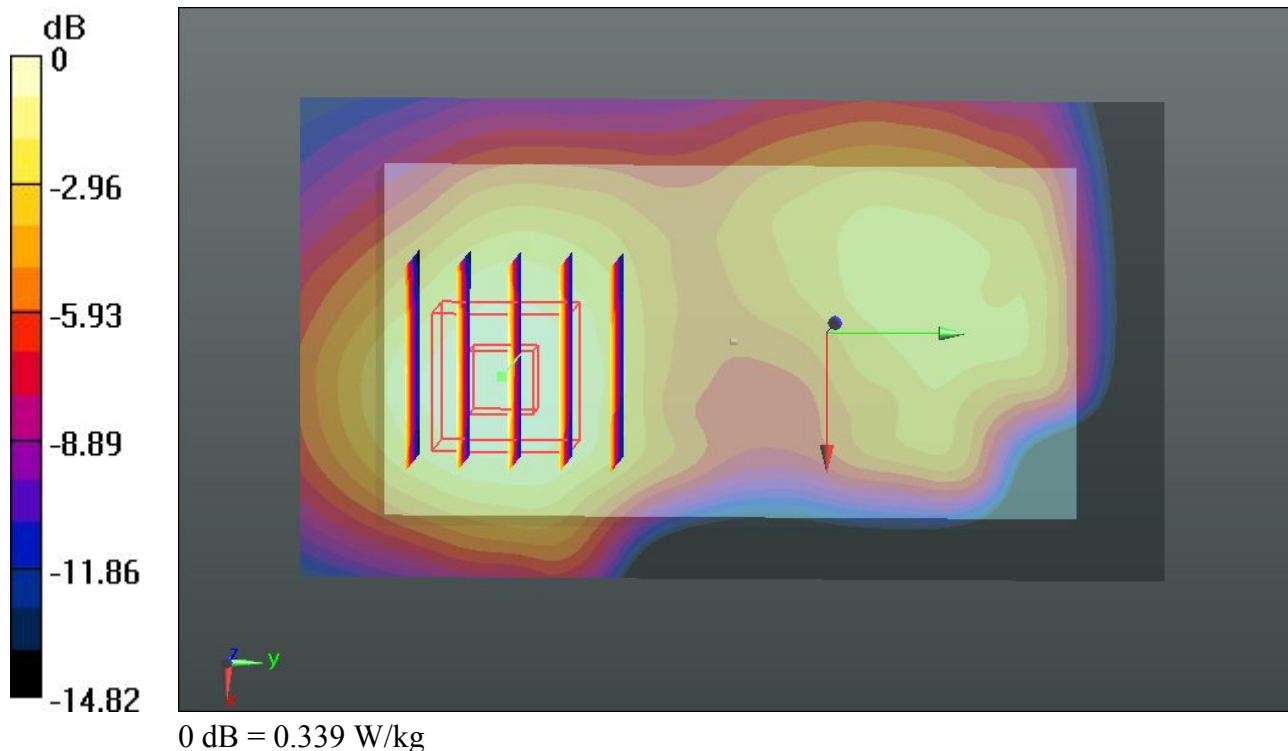

08 GSM1900_GSM Voice_Back_1.5cm_Ch661

DUT: 312402

Communication System: Generic GSM; Frequency: 1880 MHz; Duty Cycle: 1:8.3
Medium: MSL_1900_130204 Medium parameters used: $f = 1880$ MHz; $\sigma = 1.498$ mho/m; $\epsilon_r = 53.575$; $\rho = 1000$ kg/m³
Ambient Temperature : 23.4 °C ; Liquid Temperature : 21.4 °C

DASY5 Configuration:

- Probe: EX3DV4 - SN3819; ConvF(7.67, 7.67, 7.67); Calibrated: 26.11.2012;
- Sensor-Surface: 2mm (Mechanical Surface Detection)
- Electronics: DAE4 Sn1303; Calibrated: 22.11.2012
- Phantom: SAM1; Type: QD000P40CD; Serial: TP:1670
- Measurement SW: DASY52, Version 52.8 (2); SEMCAD X Version 14.6.6 (6824)

Ch661/Area Scan (51x91x1): Interpolated grid: dx=15mm, dy=15mm
Maximum value of SAR (interpolated) = 0.521 W/kg

Ch661/Zoom Scan (5x5x7)/Cube 0: Measurement grid: dx=8mm, dy=8mm, dz=5mm
Reference Value = 18.781 V/m; Power Drift = -0.02 dB
Peak SAR (extrapolated) = 0.629 mW/g
SAR(1 g) = 0.389 mW/g; SAR(10 g) = 0.231 mW/g
Maximum value of SAR (measured) = 0.512 W/kg

