



# FCC Test Report

**APPLICANT** : Brightstar Corporation  
**EQUIPMENT** : Smart phone  
**BRAND NAME** : Avvio 490, Avvio 490S  
**MODEL NAME** : Avvio 490, Avvio 490S  
**FCC ID** : WVBA490X  
**STANDARD** : FCC 47 CFR FCC Part 15 Subpart B  
**CLASSIFICATION** : Certification

The product was received on Aug. 04, 2015 and testing was completed on Aug. 28, 2015. We, SPORTON INTERNATIONAL (SHENZHEN) INC., would like to declare that the tested sample has been evaluated in accordance with the test procedures given in ANSI C63.4-2009 and has been in compliance with the applicable technical standards.

The test results in this report apply exclusively to the tested model / sample. Without written approval of SPORTON INTERNATIONAL (SHENZHEN) INC., the test report shall not be reproduced except in full.

*Louis Wu*

Reviewed by: Louis Wu / Manager

*Jones Tsai*

Approved by: Jones Tsai / Manager

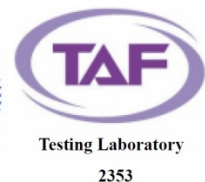

**SPORTON INTERNATIONAL (SHENZHEN) INC.**  
1F & 2F, Building A, Morning Business Center, No. 4003 ShiGu Rd., Xili Town,  
Nanshan District, Shenzhen, Guangdong, P. R. China



## TABLE OF CONTENTS

REVISION HISTORY.....	3
SUMMARY OF TEST RESULT .....	4
<b>1. GENERAL DESCRIPTION .....</b>	<b>5</b>
1.1. Applicant.....	5
1.2. Manufacturer .....	5
1.3. Product Feature of Equipment Under Test .....	5
1.4. Product Specification subjective to this standard.....	6
1.5. Modification of EUT.....	6
1.6. Test Location.....	7
1.7. Applicable Standards .....	7
<b>2. TEST CONFIGURATION OF EQUIPMENT UNDER TEST.....</b>	<b>8</b>
2.1. Test Mode .....	8
2.2. Connection Diagram of Test System .....	10
2.3. Support Unit used in test configuration and system.....	11
2.4. EUT Operation Test Setup.....	12
<b>3. TEST RESULT.....</b>	<b>13</b>
3.1. Test of AC Conducted Emission Measurement .....	13
3.2. Test of Radiated Emission Measurement .....	19
<b>4. LIST OF MEASURING EQUIPMENT .....</b>	<b>23</b>
<b>5. UNCERTAINTY OF EVALUATION .....</b>	<b>24</b>
<b>APPENDIX A. SETUP PHOTOGRAPHS</b>	



### REVISION HISTORY

REPORT NO.	VERSION	DESCRIPTION	ISSUED DATE
FC580402	Rev. 01	Initial issue of report	Sep. 06, 2015



### SUMMARY OF TEST RESULT

Report Section	FCC Rule	Description	Limit	Result	Remark
3.1	15.107	AC Conducted Emission	< 15.107 limits	PASS	Under limit 18.50 dB at 0.740 MHz
3.2	15.109	Radiated Emission	< 15.109 limits	PASS	Under limit 1.44 dB at 199.830 MHz for Quasi-Peak



# 1. General Description

## 1.1. Applicant

**Brightstar Corporation**

9725 NW 117th Ave., Miami, Florida, FL 33178, United States

## 1.2. Manufacturer

**KCMobile Co.,Ltd**

#1305-1, Kolon Digital Tower Villant II , 31, Digital-ro 30-gil, Guro-Gu, Seoul, KOREA ( 152-727)

## 1.3. Product Feature of Equipment Under Test

Product Feature	
<b>Equipment</b>	Smart phone
<b>Brand Name</b>	Avvio 490, Avvio 490S
<b>Model Name</b>	Avvio 490, Avvio 490S
<b>FCC ID</b>	WVBA490X
<b>EUT supports Radios application</b>	GSM/GPRS/EGPRS(Downlink Only)/WCDMA/HSPA/ WLAN 2.4GHz 802.11b/g/n HT20/HT40/ Bluetooth v2.1 + EDR/Bluetooth v4.0 LE
<b>IMEI Code</b>	Conduction: 353040070005029/353040070005037 Radiation: 53040070002570/536986022066542
<b>HW Version</b>	M7236_V1.1
<b>SW Version</b>	M7206.K1.AVVIO787S.CC.512P4.V01.03.20150722
<b>EUT Stage</b>	Production Unit

**Remark:**

1. The above EUT's information was declared by manufacturer. Please refer to the specifications or user's manual for more detailed description.
2. The difference of the two samples (Model Name: Avvio 490, Avvio 490S): Avvio 490 is single SIM card, Avvio 490S is dual SIM card. The others are the same including circuit design, PCB board, structure and all components. It is special to declare. After pre-scan two types of EUT, we found test result of the sample that dual SIM (Model Name: Avvio 490S) was the worst, so we choose dual SIM card mobile to perform all test.

### 1.4. Product Specification subjective to this standard

Product Specification subjective to this standard	
<b>Tx Frequency</b>	GSM850 : 824.2 MHz ~ 848.8 MHz GSM1900 : 1850.2 MHz ~ 1909.8MHz WCDMA Band V : 826.4 MHz ~ 846.6 MHz WCDMA Band II : 1852.4 MHz ~ 1907.6 MHz 802.11b/g/n: 2412 MHz ~ 2462 MHz Bluetooth: 2402 MHz ~ 2480 MHz
<b>Rx Frequency</b>	GSM850 : 869.2 MHz ~ 893.8 MHz GSM1900 : 1930.2 MHz ~ 1989.8 MHz WCDMA Band V : 871.4 MHz ~ 891.6 MHz WCDMA Band II : 1932.4 MHz ~ 1987.6 MHz 802.11b/g/n: 2412 MHz ~ 2462 MHz Bluetooth: 2402 MHz ~ 2480 MHz GPS : 1.57542 GHz
<b>Antenna Type</b>	WWAN : PIFA Antenna WLAN : PIFA Antenna Bluetooth : PIFA Antenna GPS: PIFA Antenna
<b>Type of Modulation</b>	GSM: GMSK GPRS: GMSK EDGE(MCS 0-4): GMSK/(MCS 5-9): 8PSK(Downlink Only) WCDMA: QPSK (Uplink) HSDPA: QPSK (Uplink) HSUPA: QPSK (Uplink) 802.11b : DSSS (DBPSK / DQPSK / CCK) 802.11g/n : OFDM (BPSK / QPSK / 16QAM / 64QAM) Bluetooth LE : GFSK Bluetooth (1Mbps) : GFSK Bluetooth (2Mbps) : $\pi/4$ -DQPSK Bluetooth (3Mbps) : 8-DPSK GPS : BPSK

### 1.5. Modification of EUT

No modifications are made to the EUT during all test items.



### 1.6. Test Location

<b>Test Site</b>	SPORTON INTERNATIONAL (SHENZHEN) INC.	
<b>Test Site Location</b>	1F & 2F, Building A, Morning Business Center, No. 4003 ShiGu Rd., Xili Town, Nanshan District, Shenzhen, Guangdong, P. R. China TEL: +86-755-8637-9589 FAX: +86-755-8637-9595	
<b>Test Site No.</b>	<b>Sporton Site No.</b>	
	CO01-SZ	

<b>Test Site</b>	SPORTON INTERNATIONAL (SHENZHEN) INC.	
<b>Test Site Location</b>	No. 3 Building, the third floor of south, Shahe River west, Fengzeyuan warehouse, Nanshan District, Shenzhen, Guangdong, P. R. China TEL: +86-755- 3320-2398	
<b>Test Site No.</b>	<b>Sporton Site No.</b>	<b>FCC Registration No.</b>
	03CH01-SZ	831040

### 1.7. Applicable Standards

According to the specifications of the manufacturer, the EUT must comply with the requirements of the following standards:

- ♦ FCC 47 CFR FCC Part 15 Subpart B
- ♦ ANSI C63.4-2009

**Remark:** All test items were verified and recorded according to the standards and without any deviation during the test.

## 2. Test Configuration of Equipment Under Test

### 2.1. Test Mode

The EUT has been associated with peripherals pursuant to ANSI C63.4-2009 and configuration operated in a manner tended to maximize its emission characteristics in a typical application.

Frequency range investigated: conduction (150 kHz to 30 MHz), radiation (30MHz to the 5th harmonic of the highest fundamental frequency or to 40 GHz, whichever is lower).

The following tables are showing the test modes as the worst cases and recorded in this report.

Item	EUT Configuration	Test Condition		
		EMI AC	EMI RE<1G	EMI RE≥1G
1.	Charging Mode (EUT with adapter)	☒	☒	Note 1
2.	Data application transferred mode (EUT connected with notebook)	☒	☒	☒

**Abbreviations:**

- EMI AC: AC conducted emissions
- EMI RE ≥ 1G: EUT radiated emissions ≥ 1GHz
- EMI RE < 1G: EUT radiated emissions < 1GHz
- **Note 1:** Testing for this mode is not required or not the worst case.
- **Remark:** For signal above 1GHz, the worst case was test item 2.



Test Items	EUT Configure Mode	Function Type
AC Conducted Emission	1/2	Mode 1: GSM850 Idle + Bluetooth Idle + WLAN Idle + USB Cable (Charging from Adapter) + Earphone + Camera + SIM1<Fig.1> Mode 2: WCDMA Band II Idle + Bluetooth Idle + WLAN Idle + USB Cable (Charging from Adapter) + Earphone + MPEG4 + SIM2<Fig.1> Mode 3: WCDMA Band V Idle + Bluetooth Idle + WLAN Idle + USB Cable (Data Link with Notebook) + Earphone + GPS Rx + SIM1<Fig.2>
Radiated Emissions < 1GHz	1/2	Mode 1: GSM850 Idle + Bluetooth Idle + WLAN Idle + USB Cable (Charging from Adapter) + Earphone + Camera + SIM1<Fig.1> Mode 2: WCDMA Band II Idle + Bluetooth Idle + WLAN Idle + USB Cable (Charging from Adapter) + Earphone + MPEG4 + SIM2<Fig.1> Mode 3: WCDMA Band V Idle + Bluetooth Idle + WLAN Idle + USB Cable (Data Link with Notebook) + Earphone + GPS Rx + SIM1<Fig.2>
Radiated Emissions ≥ 1GHz	2	Mode 1: WCDMA Band V Idle + Bluetooth Idle + WLAN Idle + USB Cable (Data Link with Notebook) + Earphone + GPS Rx + SIM1<Fig.2>
<p><b>Remark:</b></p> <ol style="list-style-type: none"> <li>The worst case of AC is mode 2, and the USB Link mode of AC is mode 3, the test data of these modes were reported.</li> <li>The worst case of RE &lt; 1G is mode 3; the test data of these modes were reported.</li> <li>Link with Notebook means data application transferred mode between EUT and Notebook.</li> </ol>		

## 2.2. Connection Diagram of Test System

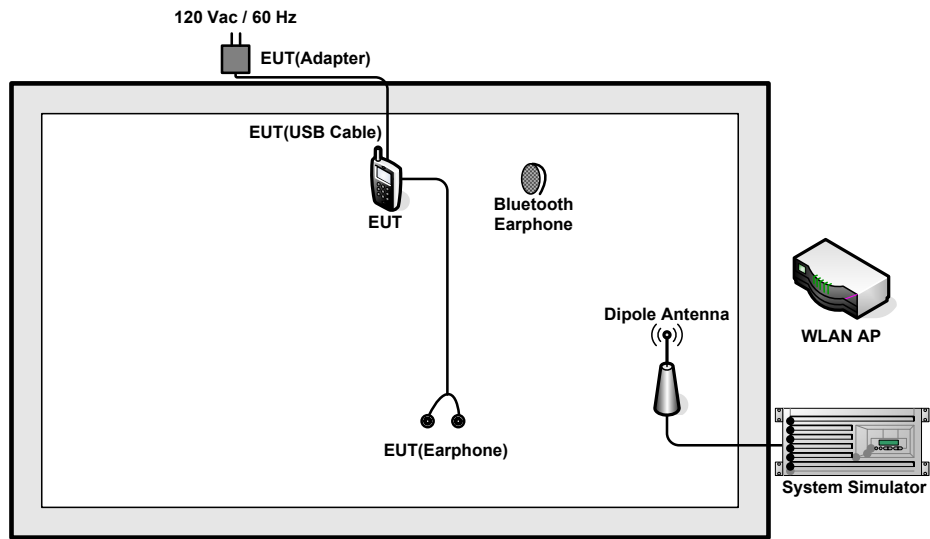

<Fig.1>

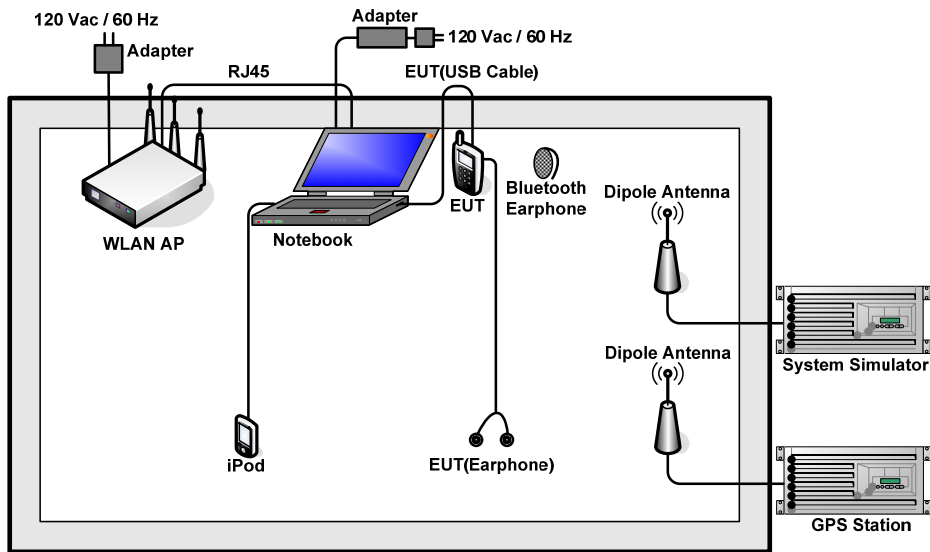

<Fig.2>

**2.3. Support Unit used in test configuration and system**

Item	Equipment	Trade Name	Model Name	FCC ID	Data Cable	Power Cord
1.	System Simulator	R&S	CMU200	N/A	N/A	Unshielded, 1.8 m
2.	GPS Station	ADIVIC	MP9000	N/A	N/A	Unshielded, 1.8 m
3.	Notebook	Lenovo	E540	PRC4	N/A	AC I/P: Unshielded, 1.2 m DC O/P: Shielded, 1.8 m
4.	Bluetooth Earphone	Lenovo	LBH301	N/A	N/A	N/A
5.	Bluetooth Earphone	Nokia	BH-108	PYAHS-107W	N/A	N/A
6.	WLAN AP	D-Link	DIR-628	KA2DIR628A2	N/A	Unshielded, 1.8 m
7.	WLAN AP	D-Link	DIR-615	N/A	N/A	Unshielded, 1.8 m with Core
8.	iPod	Apple	MC690ZP/A	FCC DoC	N/A	N/A
9.	SD Card	SanDisk	4G class 4	FCC DoC	Unshielded, 1.2 m	N/A
10.	iPod nano 8GB	Apple	MC690ZP/A	FCC DoC	Unshielded, 1.2 m	N/A



## **2.4. EUT Operation Test Setup**

The EUT was in GSM or WCDMA idle mode during the testing. The EUT was synchronized to the BCCH, and was in continuous receiving mode by setting system simulator's paging reorganization.

At the same time, the EUT was attached to the Bluetooth earphone or WLAN AP, and the following programs installed in the EUT were programmed during the test.

1. Data application is transferred between Notebook and EUT via USB cable.
2. Execute "Video Player" to play MPEG4 files.
3. Turn on camera to capture images.
4. Turn on GPS function to make the EUT receive continuous signals from GPS station.

### 3. Test Result

#### 3.1. Test of AC Conducted Emission Measurement

##### 3.1.1 Limits of AC Conducted Emission

For equipment that is designed to be connected to the public utility (AC) power line, the radio frequency voltage that is conducted back onto the AC power line on any frequency or frequencies within the band 150 kHz to 30 MHz shall not exceed the limits in the following table.

Frequency of emission (MHz)	Conducted limit (dBuV)	
	Quasi-peak	Average
0.15-0.5	66 to 56*	56 to 46*
0.5-5	56	46
5-30	60	50

\*Decreases with the logarithm of the frequency.

##### 3.1.2 Measuring Instruments

The measuring equipment is listed in the section 4 of this test report.

##### 3.1.3 Test Procedure

1. The EUT was placed 0.4 meter from the conducting wall of the shielding room was kept at least 80 centimeters from any other grounded conducting surface.
2. Connect EUT to the power mains through a line impedance stabilization network (LISN).
3. All the support units are connecting to the other LISN.
4. The LISN provides 50 ohm coupling impedance for the measuring instrument.
5. The FCC states that a 50 ohm, 50 microhenry LISN should be used.
6. Both sides of AC line were checked for maximum conducted interference.
7. The frequency range from 150 kHz to 30 MHz was searched.
8. Set the test-receiver system to Peak Detect Function and specified bandwidth (IF Bandwidth = 9kHz) with Maximum Hold Mode. Then measurement is also conducted by Average Detector and Quasi-Peak Detector Function respectively.

### 3.1.4 Test Setup

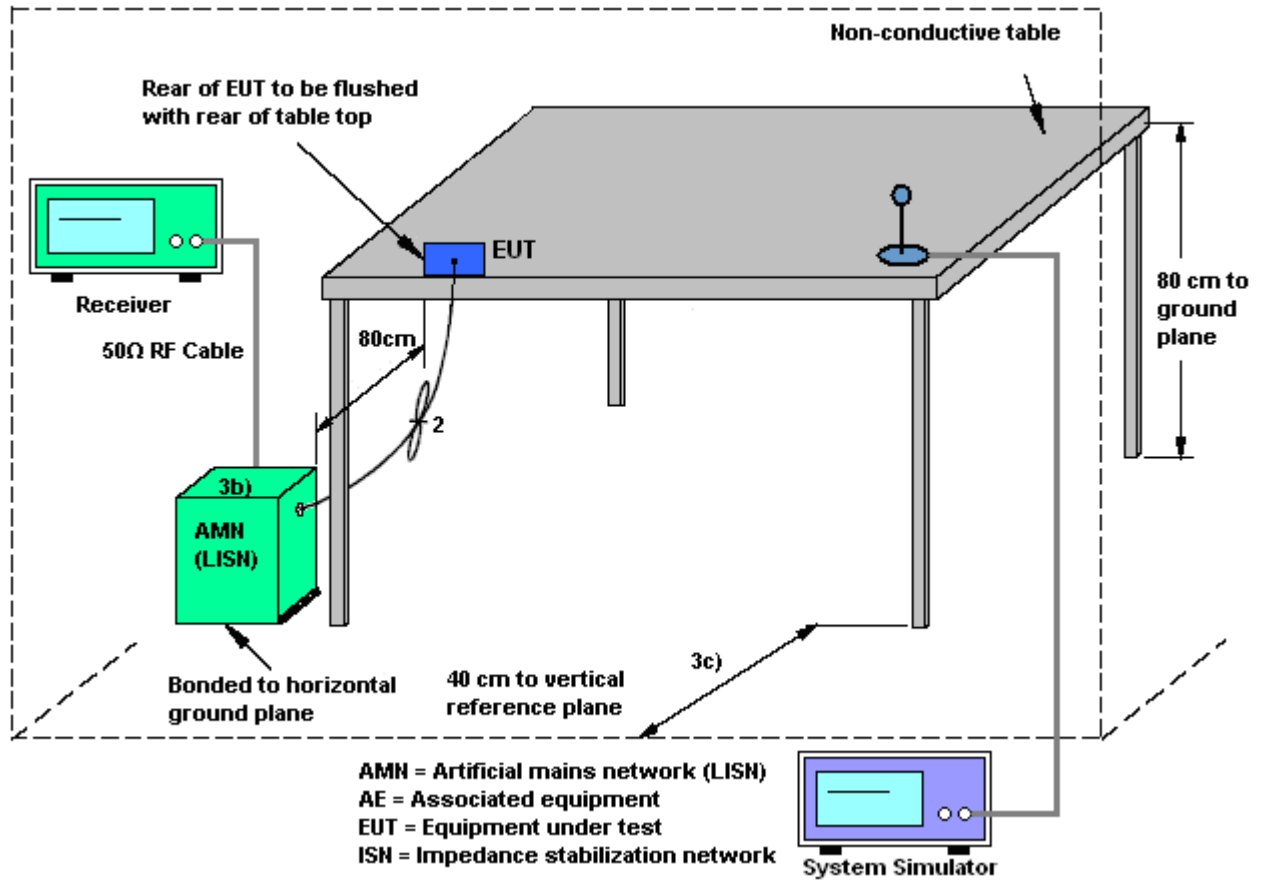



3.1.5 Test Result of AC Conducted Emission

Test Mode :	Mode 2	Temperature :	21~22°C
Test Engineer :	Jack Tian	Relative Humidity :	41~43%
Test Voltage :	120Vac / 60Hz	Phase :	Line
Function Type :	WCDMA Band II Idle + Bluetooth Idle + WLAN Idle + USB Cable (Charging from Adapter) + Earphone + MPEG4 + SIM2		

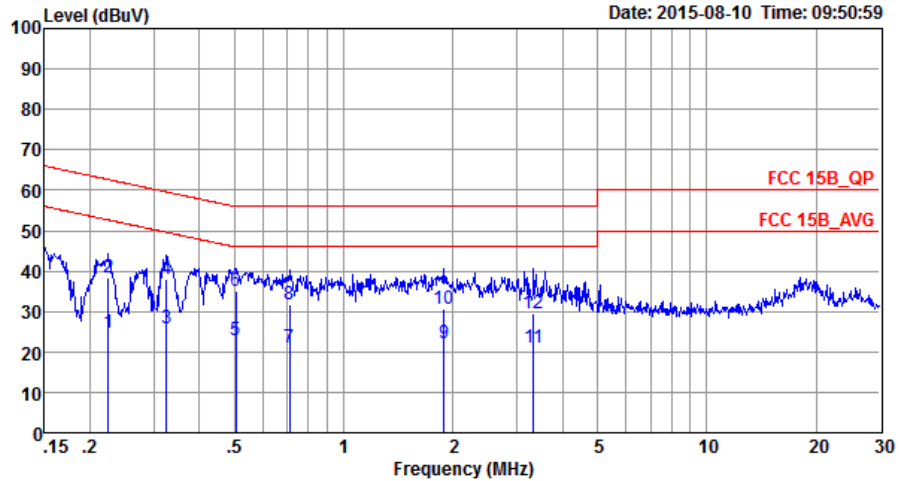

Site : CO01-SZ  
 Condition: FCC 15B\_QP LISN\_L\_20150304 LINE  
 Project : (FC)580402  
 Mode : Mode 2  
 IMEI : 353040070005029/353040070005037

	Freq	Level	Over Limit	Limit	Read	LISN	Cable	
	MHz	dBuV	dB	dBuV	dBuV	dB	dB	Remark
1	0.22	24.80	-27.86	52.66	14.00	0.53	10.27	Average
2	0.22	38.30	-24.36	62.66	27.50	0.53	10.27	QP
3	0.33	25.85	-23.72	49.57	15.10	0.56	10.19	Average
4	0.33	38.15	-21.42	59.57	27.40	0.56	10.19	QP
5	0.50	23.02	-22.98	46.00	12.19	0.67	10.16	Average
6 *	0.50	35.02	-20.98	56.00	24.19	0.67	10.16	QP
7	0.71	21.19	-24.81	46.00	10.50	0.54	10.15	Average
8	0.71	31.89	-24.11	56.00	21.20	0.54	10.15	QP
9	1.89	22.15	-23.85	46.00	11.50	0.46	10.19	Average
10	1.89	30.75	-25.25	56.00	20.10	0.46	10.19	QP
11	3.33	21.09	-24.91	46.00	10.30	0.57	10.22	Average
12	3.33	29.49	-26.51	56.00	18.70	0.57	10.22	QP



Test Mode :	Mode 2	Temperature :	21~22°C
Test Engineer :	Jack Tian	Relative Humidity :	41~43%
Test Voltage :	120Vac / 60Hz	Phase :	Neutral
Function Type :	WCDMA Band II Idle + Bluetooth Idle + WLAN Idle + USB Cable (Charging from Adapter) + Earphone + MPEG4 + SIM2		

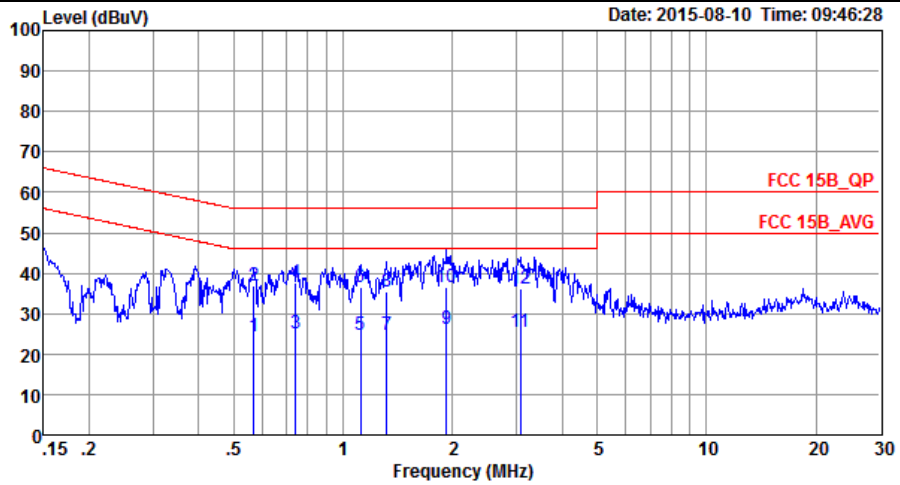

Site : C001-SZ  
 Condition: FCC 15B\_QP LISN\_N\_20150304 NEUTRAL  
 Project : (FC)580402  
 Mode : Mode 2  
 IMEI : 353040070005029/353040070005037

	Freq	Level	Over Limit	Limit Line	Read Level	LISN Factor	Cable Loss	Remark
	MHz	dBuV	dB	dBuV	dBuV	dB	dB	
1	0.57	24.24	-21.76	46.00	13.50	0.59	10.15	Average
2	0.57	36.74	-19.26	56.00	26.00	0.59	10.15	QP
3	0.74	25.10	-20.90	46.00	14.40	0.55	10.15	Average
4 *	0.74	37.50	-18.50	56.00	26.80	0.55	10.15	QP
5	1.12	24.82	-21.18	46.00	14.10	0.56	10.16	Average
6	1.12	36.42	-19.58	56.00	25.70	0.56	10.16	QP
7	1.32	24.83	-21.17	46.00	14.10	0.56	10.17	Average
8	1.32	35.43	-20.57	56.00	24.70	0.56	10.17	QP
9	1.93	26.16	-19.84	46.00	15.40	0.57	10.19	Average
10	1.93	36.56	-19.44	56.00	25.80	0.57	10.19	QP
11	3.07	25.32	-20.68	46.00	14.50	0.61	10.21	Average
12	3.07	36.02	-19.98	56.00	25.20	0.61	10.21	QP





Test Mode :	Mode 3	Temperature :	21~22°C
Test Engineer :	Jack Tian	Relative Humidity :	41~43%
Test Voltage :	120Vac / 60Hz	Phase :	Line
Function Type :	WCDMA Band V Idle + Bluetooth Idle + WLAN Idle + USB Cable (Data Link with Notebook) + Earphone + GPS Rx + SIM1		

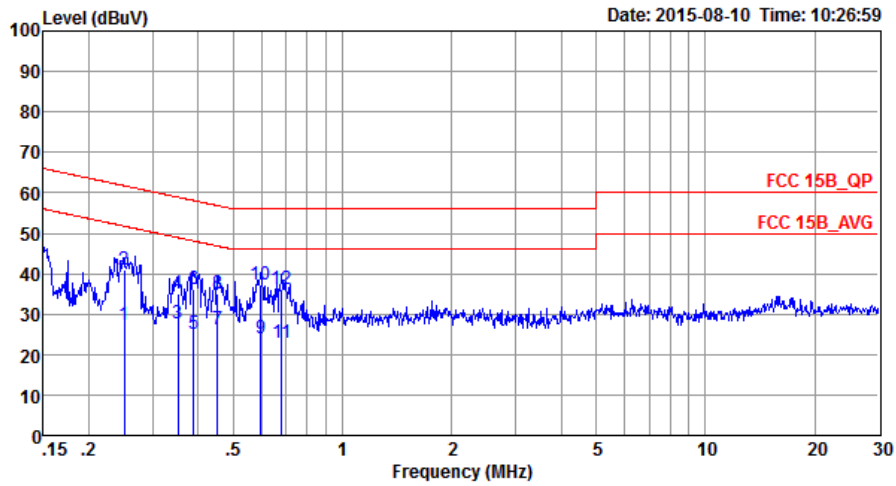

Site : CO01-SZ  
 Condition: FCC 15B\_QP LISN\_L\_20150304 LINE  
 Project : (FC)580402  
 Mode : Mode 3  
 IMEI : 353040070005029/353040070005037

	Freq	Level	Over Limit	Limit Line	Read Level	LISN Factor	Cable Loss	Remark
	MHz	dBuV	dB	dBuV	dBuV	dB	dB	
1	0.25	27.19	-24.54	51.73	16.40	0.55	10.24	Average
2	0.25	41.09	-20.64	61.73	30.30	0.55	10.24	QP
3	0.35	27.54	-21.37	48.91	16.81	0.55	10.18	Average
4	0.35	35.24	-23.67	58.91	24.51	0.55	10.18	QP
5	0.39	25.02	-23.06	48.08	14.31	0.54	10.17	Average
6	0.39	36.32	-21.76	58.08	25.61	0.54	10.17	QP
7	0.45	26.37	-20.48	46.85	15.60	0.61	10.16	Average
8	0.45	35.17	-21.68	56.85	24.40	0.61	10.16	QP
9	0.59	23.95	-22.05	46.00	13.20	0.60	10.15	Average
10 *	0.59	37.45	-18.55	56.00	26.70	0.60	10.15	QP
11	0.68	22.80	-23.20	46.00	12.10	0.55	10.15	Average
12	0.68	36.30	-19.70	56.00	25.60	0.55	10.15	QP



Test Mode :	Mode 3	Temperature :	21~22°C
Test Engineer :	Jack Tian	Relative Humidity :	41~43%
Test Voltage :	120Vac / 60Hz	Phase :	Neutral
Function Type :	WCDMA Band V Idle + Bluetooth Idle + WLAN Idle + USB Cable (Data Link with Notebook) + Earphone + GPS Rx + SIM1		

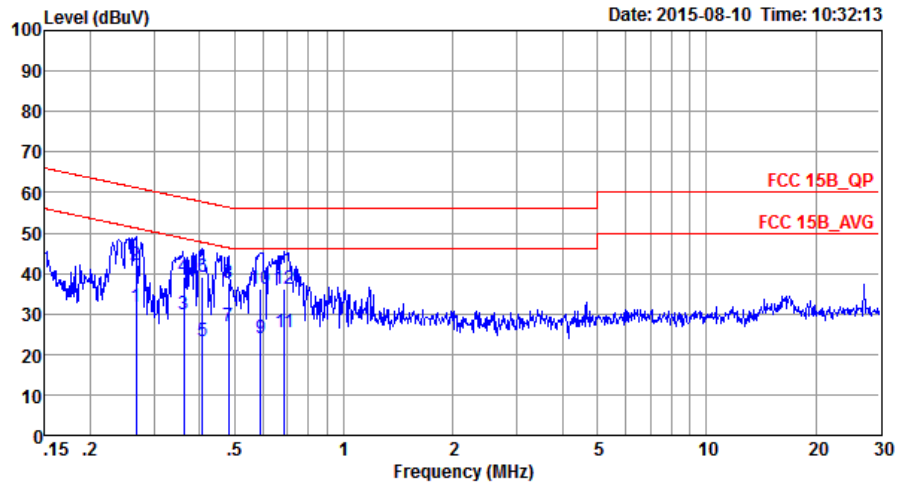

Site : CO01-SZ  
 Condition: FCC 15B\_QP LISN\_N\_20150304 NEUTRAL  
 Project : (FC)580402  
 Mode : Mode 3  
 IMEI : 353040070005029/353040070005037

	Freq	Level	Over Limit	Limit Line	Read Level	LISN Factor	Cable Loss	Remark
	MHz	dBuV	dB	dBuV	dBuV	dB	dB	
1	0.27	31.89	-19.31	51.20	21.09	0.57	10.23	Average
2	0.27	41.99	-19.21	61.20	31.19	0.57	10.23	QP
3	0.36	29.85	-18.84	48.69	19.11	0.56	10.18	Average
4	0.36	39.25	-19.44	58.69	28.51	0.56	10.18	QP
5	0.41	23.32	-24.36	47.68	12.60	0.55	10.17	Average
6 *	0.41	39.02	-18.66	57.68	28.30	0.55	10.17	QP
7	0.48	26.86	-19.46	46.32	16.10	0.60	10.16	Average
8	0.48	37.66	-18.66	56.32	26.90	0.60	10.16	QP
9	0.59	23.93	-22.07	46.00	13.20	0.58	10.15	Average
10	0.59	36.13	-19.87	56.00	25.40	0.58	10.15	QP
11	0.69	25.40	-20.60	46.00	14.70	0.55	10.15	Average
12	0.69	36.20	-19.80	56.00	25.50	0.55	10.15	QP

## 3.2. Test of Radiated Emission Measurement

### 3.2.1. Limit of Radiated Emission

The emissions from an unintentional radiator shall not exceed the field strength levels specified in the following table:

Frequency (MHz)	Field Strength (microvolts/meter)	Measurement Distance (meters)
30 – 88	100	3
88 – 216	150	3
216 - 960	200	3
Above 960	500	3

### 3.2.2. Measuring Instruments

The measuring equipment is listed in the section 4 of this test report.

### 3.2.3. Test Procedures

1. The EUT was placed on a turntable with 0.8 meter above ground.
2. The EUT was set 3 meters from the interference receiving antenna, which was mounted on the top of a variable height antenna tower.
3. The table was rotated 360 degrees to determine the position of the highest radiation.
4. The antenna is a Bi-Log antenna and its height is adjusted between one to four meters above ground to find the maximum value of the field strength for both horizontal polarization and vertical polarization of the antenna.
5. For each suspected emission, the EUT was arranged to its worst case and then tune the antenna tower (from 1 m to 4 m) and turntable (from 0 degree to 360 degrees) to find the maximum reading.
6. Set the test-receiver system to Peak Detect Function and specified bandwidth with Maximum Hold Mode (RBW=120kHz/VBW=300kHz for frequency below 1GHz; RBW=1MHz VBW=3MHz (Peak), RBW=1MHz/VBW=10Hz (Average) for frequency above 1GHz).
7. If the emission level of the EUT in peak mode was 3 dB lower than the limit specified, peak values of EUT will be reported. Otherwise, the emission will be repeated by using the quasi-peak method and reported.
8. Emission level (dB $\mu$ V/m) = 20 log Emission level ( $\mu$ V/m)
9. Corrected Reading: Antenna Factor + Cable Loss + Read Level - Preamp Factor = Level

### 3.2.4. Test Setup of Radiated Emission

For radiated emissions from 30MHz to 1GHz

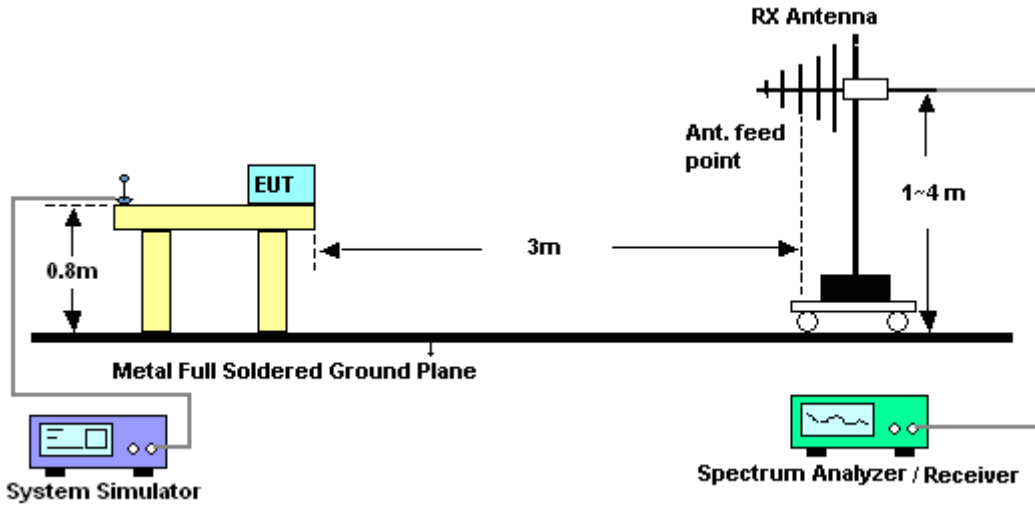

For radiated emissions above 1GHz

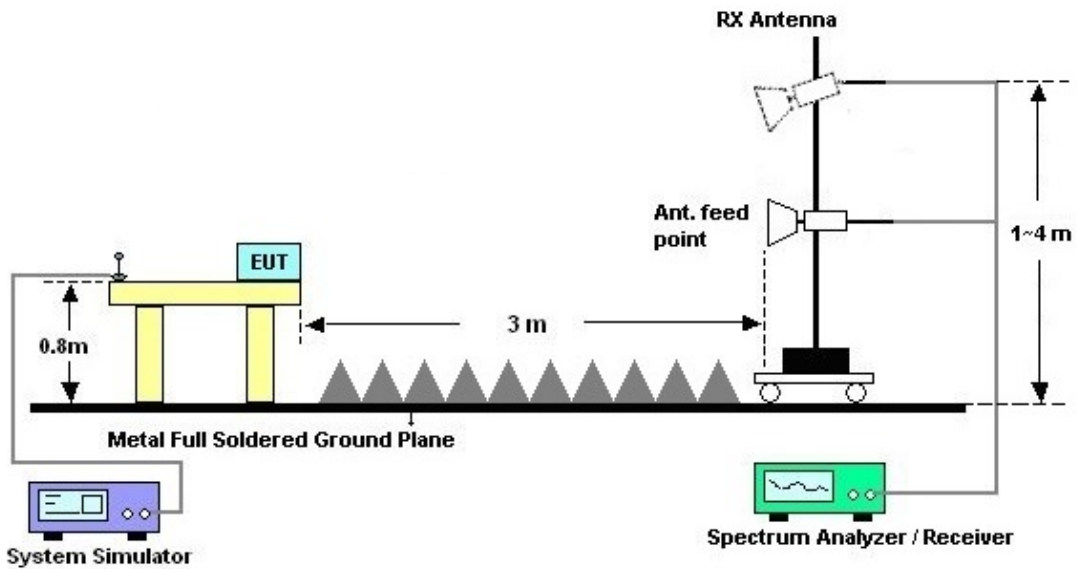



3.2.5. Test Result of Radiated Emission

Test Mode :	Mode 3	Temperature :	23~25°C
Test Engineer :	Gavin Zhang	Relative Humidity :	48~52%
Test Distance :	3m	Polarization :	Horizontal
Function Type :	WCDMA Band V Idle + Bluetooth Idle + WLAN Idle + USB Cable (Data Link with Notebook) + Earphone + GPS Rx + SIM1		
Remark :	#7 is system simulator signal which can be ignored.		

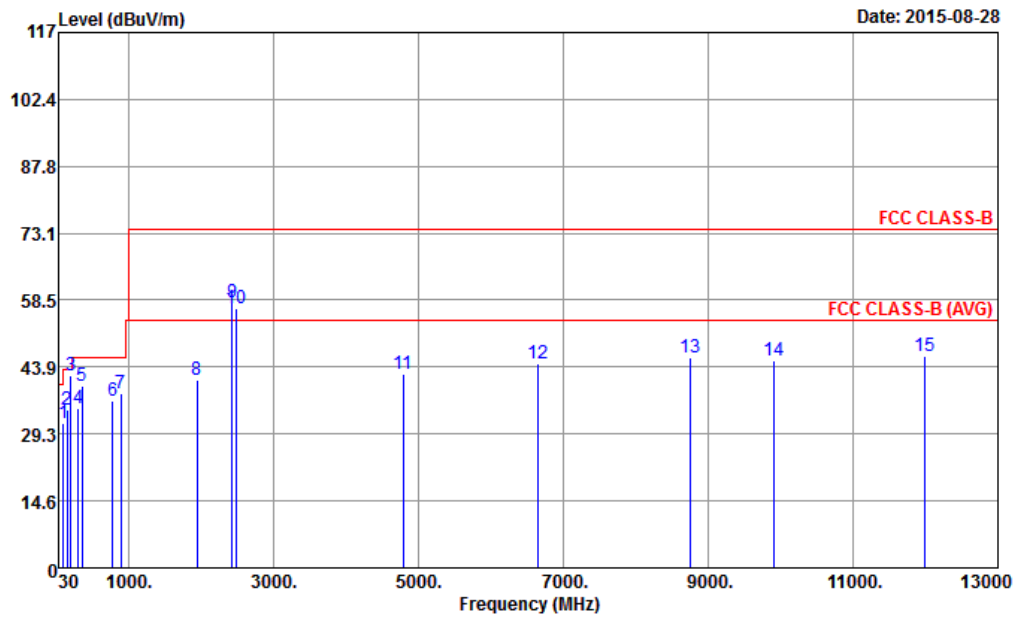

Site : 03CH01-SZ  
 Condition : FCC CLASS-B 3m LF\_ANT\_141107 HORIZONTAL  
 Project : (FC) 580402  
 Mode : Mode 3  
 IMEI : 353040070002570/356986022066542

	Freq	Level	Over Limit	Limit Line	ReadAntenna Level	Cable Factor	Preamp Loss	A/Pos	T/Pos	Remark
	MHz	dBuV/m	dB	dBuV/m	dBuV	dB/m	dB	cm	deg	
1	99.93	31.55	-11.95	43.50	44.18	11.70	1.45	25.78	---	Peak
2	149.88	34.51	-8.99	43.50	45.25	13.01	1.76	25.51	---	Peak
3	199.83	42.06	-1.44	43.50	53.65	11.60	2.06	25.25	125	80 QP
4	300.00	34.93	-11.07	46.00	43.35	14.10	2.52	25.04	---	Peak
5	349.70	39.66	-6.34	46.00	47.61	14.76	2.72	25.43	---	Peak
6	774.60	36.39	-9.61	46.00	36.39	21.94	4.28	26.22	---	Peak
7	888.00	38.12			37.69	21.70	4.63	25.90	---	Peak
8	1946.00	41.03	-32.97	74.00	52.53	31.74	7.77	51.01	---	Peak
9	2430.00	57.92	-16.08	74.00	67.10	32.63	8.69	50.50	---	Peak
10	2476.00	56.70	-17.30	74.00	65.67	32.68	8.78	50.43	---	Peak
11	4790.00	42.21	-31.79	74.00	45.88	34.38	12.80	50.85	---	Peak
12	6648.00	44.57	-29.43	74.00	44.30	36.24	14.50	50.47	---	Peak
13	8756.00	45.91	-28.09	74.00	42.22	36.50	16.78	49.59	---	Peak
14	9898.00	45.33	-28.67	74.00	39.30	37.98	17.97	49.92	---	Peak
15	11988.00	46.22	-27.78	74.00	38.49	39.49	18.19	49.95	100	0 Peak



Test Mode :	Mode 3	Temperature :	23~25°C
Test Engineer :	Gavin Zhang	Relative Humidity :	48~52%
Test Distance :	3m	Polarization :	Vertical
Function Type :	WCDMA Band V Idle + Bluetooth Idle + WLAN Idle + USB Cable (Data Link with Notebook) + Earphone + GPS Rx + SIM1		
Remark :	#7 is system simulator signal which can be ignored.		

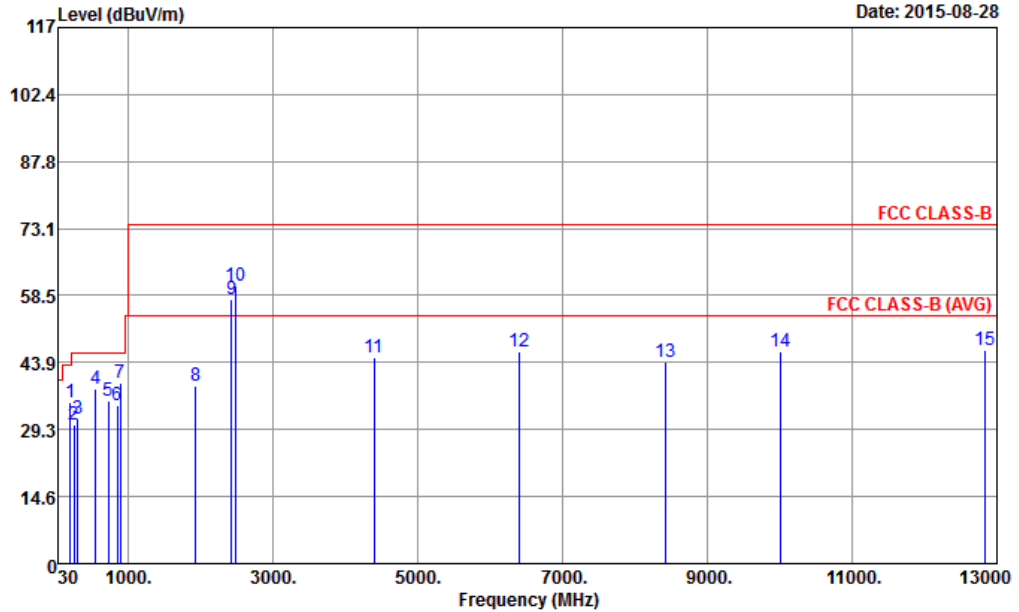

Site : 03CH01-SZ  
 Condition : FCC CLASS-B 3m LF\_ANT\_141107 VERTICAL  
 Project : (FC) 580402  
 Mode : Mode 3  
 IMEI : 353040070002570/356986022066542

	Freq	Level	Over Limit	Limit Line	ReadAntenna Level	Cable Factor	Preamp Loss	A/Pos	T/Pos	Remark
	MHz	dBUV/m	dB	dBUV/m	dBuV	dB/m	dB	cm	deg	
1	199.83	35.08	-8.42	43.50	46.67	11.60	2.06	25.25	---	Peak
2	249.78	30.19	-15.81	46.00	40.62	12.40	2.31	25.14	---	Peak
3	299.73	31.57	-14.43	46.00	39.99	14.10	2.52	25.04	---	Peak
4	549.90	38.28	-7.72	46.00	41.61	19.55	3.51	26.39	100	Peak
5	724.90	35.50	-10.50	46.00	36.90	20.83	4.09	26.32	---	Peak
6	849.50	34.66	-11.34	46.00	34.09	22.05	4.54	26.02	---	Peak
7	888.00	39.31			38.88	21.70	4.63	25.90	---	Peak
8	1934.00	38.93	-35.07	74.00	50.57	31.59	7.77	51.00	---	Peak
9	2428.00	57.59	-16.41	74.00	66.77	32.63	8.69	50.50	---	Peak
10	2476.00	60.61	-13.39	74.00	69.58	32.68	8.78	50.43	---	Peak
11	4398.00	44.93	-29.07	74.00	49.97	34.14	12.60	51.78	---	Peak
12	6392.00	46.31	-27.69	74.00	46.04	36.18	14.26	50.17	---	Peak
13	8414.00	44.04	-29.96	74.00	41.12	36.25	16.20	49.53	---	Peak
14	10016.00	46.37	-27.63	74.00	39.98	38.11	18.23	49.95	---	Peak
15	12828.00	46.71	-27.29	74.00	38.84	39.10	18.72	49.95	100	Peak



## 4. List of Measuring Equipment

Instrument	Manufacturer	Model No.	Serial No.	Characteristics	Calibration Date	Test Date	Due Date	Remark
EMI Test Receiver&SA	Agilent Technologies	N9038A	MY52260185	20Hz~26.5GHz	May 26, 2015	Aug. 28, 2015	May 25, 2016	Radiation (03CH01-SZ)
Spectrum Analyzer	R&S	FSV40	101041	10kHz~40GHz; Max 30dBm	Sep. 25, 2014	Aug. 28, 2015	Sep. 24, 2015	Radiation (03CH01-SZ)
Bilog Antenna	TeseQ	CBL6112D	23188	30MHz~2GHz	Nov. 07, 2014	Aug. 28, 2015	Nov. 06, 2015	Radiation (03CH01-SZ)
Double Ridge Horn Antenna	ETS-Lindgren	3117	00119436	1GHz~18GHz	Oct. 15, 2014	Aug. 28, 2015	Oct. 14, 2015	Radiation (03CH01-SZ)
Amplifier	ADVANTEST	BB525C	E9007003	9kHz~3000MHz / 30 dB	Jan. 28, 2015	Aug. 28, 2015	Jan. 27, 2016	Radiation (03CH01-SZ)
Amplifier	Agilent Technologies	83017A	MY39501302	500MHz~26.5GHz	Jan. 28, 2015	Aug. 28, 2015	Jan. 27, 2016	Radiation (03CH01-SZ)
AC Power Source	Chroma	61601	616010001985	N/A	NCR	Aug. 28, 2015	NCR	Radiation (03CH01-SZ)
Turn Table	EM	EM1000	N/A	0~360 degree	NCR	Aug. 28, 2015	NCR	Radiation (03CH01-SZ)
Antenna Mast	EM	EM1000	N/A	1 m~4 m	NCR	Aug. 28, 2015	NCR	Radiation (03CH01-SZ)
EMI Receiver	R&S	ESCI7	100724	9kHz~3GHz	Jan. 28, 2015	Aug. 10, 2015	Jan. 27, 2016	Conduction (CO01-SZ)
AC LISN	EMCO	3816/2SH	103892	9kHz~30MHz	Feb. 02, 2015	Aug. 10, 2015	Feb. 01, 2016	Conduction (CO01-SZ)
AC LISN (for auxiliary equipment)	MessTec	AN3016	16850	9kHz~30MHz	Feb. 02, 2015	Aug. 10, 2015	Feb. 01, 2016	Conduction (CO01-SZ)
AC Power Source	Chroma	61602	616020000891	100Vac~250Vac	Sep. 29, 2014	Aug. 10, 2015	Sep. 28, 2015	Conduction (CO01-SZ)
Pulse Limiter	COM-POWER	LIT-153 Transient Limiter	53139	150kHz~30MHz	Oct. 24, 2014	Aug. 10, 2015	Oct. 23, 2015	Conduction (CO01-SZ)



## 5. Uncertainty of Evaluation

### Uncertainty of Conducted Emission Measurement (150 kHz ~ 30 MHz)

Measuring Uncertainty for a Level of Confidence of 95% ( $U = 2Uc(y)$ )	2.3dB
---	-------

### Uncertainty of Radiated Emission Measurement (30 MHz ~ 1000 MHz)

Measuring Uncertainty for a Level of Confidence of 95% ( $U = 2Uc(y)$ )	3.9dB
---	-------