



FCC RF Test Report

APPLICANT : Brightstar Coporation
EQUIPMENT : GSM mobile phone
BRAND NAME : Avvio
MODEL NAME : Avvio 402S/Avvio 402
FCC ID : WVBA402
STANDARD : FCC 47 CFR Part 2, 22(H), 24(E)
CLASSIFICATION : PCS Licensed Transmitter Held to Ear (PCE)

The product was received on Aug. 16, 2012 and completely tested on Aug. 31, 2012. We, SPORTON INTERNATIONAL (KUNSHAN) INC., would like to declare that the tested sample has been evaluated in accordance with the procedures given in ANSI / TIA / EIA-603-C-2004 and shown compliance with the applicable technical standards.

The test results in this report apply exclusively to the tested model / sample. Without written approval of SPORTON INTERNATIONAL (KUNSHAN) INC., the test report shall not be reproduced except in full.

Reviewed by:

Jones Tsai / Manager



SPORTON INTERNATIONAL (KUNSHAN) INC.
No. 3-2, PingXiang Road, Kunshan, Jiangsu Province, P.R.C.



TABLE OF CONTENTS

REVISION HISTORY..... 3

SUMMARY OF TEST RESULT 4

1 GENERAL DESCRIPTION 5

 1.1 Applicant..... 5

 1.2 Manufacturer 5

 1.3 Feature of Equipment Under Test..... 5

 1.4 Maximum ERP/EIRP Power, Frequency Tolerance, and Emission Designator 6

 1.5 Testing Site 6

 1.6 Applied Standards 6

 1.7 Ancillary Equipment List..... 7

2 TEST CONFIGURATION OF EQUIPMENT UNDER TEST 8

 2.1 Test Mode..... 8

 2.2 Connection Diagram of Test System 9

3 TEST RESULT 10

 3.1 Conducted Output Power Measurement..... 10

 3.2 Peak-to-Average Ratio 12

 3.3 Effective Radiated Power and Effective Isotropic Radiated Power Measurement 18

 3.4 Occupied Bandwidth and 26dB Bandwidth Measurement..... 21

 3.5 Band Edge Measurement..... 29

 3.6 Conducted Spurious Emission Measurement..... 34

 3.7 Field Strength of Spurious Radiation Measurement 40

 3.8 Frequency Stability Measurement..... 47

4 LIST OF MEASURING EQUIPMENT 51

5 UNCERTAINTY OF EVALUATION 52

APPENDIX A. PHOTOGRAPHS OF EUT

APPENDIX B. SETUP PHOTOGRAPHS



SUMMARY OF TEST RESULT

Report Section	FCC Rule	IC Rule	Description	Limit	Result	Remark
3.1	§2.1046	N/A	Conducted Output Power	N/A	PASS	-
3.2	§24.232(d)	N/A	Peak-to-Average Ratio	< 13 dB	PASS	-
3.3	§22.913(a)(2)	RSS-132(4.4) SRSP-503(5.1.3)	Effective Radiated Power	< 7 Watts	PASS	-
3.3	§24.232(c)	RSS-133 (6.4) SRSP-510(5.1.2)	Equivalent Isotropic Radiated Power	< 2 Watts	PASS	-
3.4	§2.1049 §22.917(a) §24.238(a)	N/A	Occupied Bandwidth	N/A	PASS	-
3.5	§2.1051 §22.917(a) §24.238(a)	RSS-132 (4.5.1) RSS-133 (6.5.1)	Band Edge Measurement	< 43+10log ₁₀ (P[Watts])	PASS	-
3.6	§2.1051 §22.917(a) §24.238(a)	RSS-132 (4.5.1) RSS-133 (6.5.1)	Conducted Spurious Emission	< 43+10log ₁₀ (P[Watts])	PASS	-
3.7	§2.1053 §22.917(a) §24.238(a)	RSS-132 (4.5.1) RSS-133 (6.5.1)	Field Strength of Spurious Radiation	< 43+10log ₁₀ (P[Watts])	PASS	Under limit 19.45 dB at 5640.000 MHz
3.8	§2.1055 §22.355 §24.235	RSS-132(4.3) RSS-133(6.3)	Frequency Stability for Temperature & Voltage	< 2.5 ppm	PASS	-



1 General Description

1.1 Applicant

Brightstar Coporation
9725 NW 117th Ave., Miami, Florida, United States

1.2 Manufacturer

Shanghai Huaqin Telecom Technology Co., Ltd.
Building 12, 399 Keyuan Road, Pudong district, Shanghai, China

1.3 Feature of Equipment Under Test

Product Feature	
Equipment	GSM mobile phone
Brand Name	Avvio
Model Name	Avvio 402S/Avvio 402
FCC ID	WVBA402
EUT supports Radios application	GSM
HW Version	V186_MB_V2.0
SW Version	ZV186B_058A_V8_0_4
EUT Stage	Identical Prototype

Remark:

1. The above EUT's information was declared by manufacturer. Please refer to the specifications or user's manual for more detailed description.
2. There are two different types of EUT. They are single SIM card mobile (Model Name: Avvio 402) and dual SIM card mobile (Model Name: Avvio 402S). The others are the same including circuit design, PCB board, structure and all components. It is special to declare. After pre-scan two types of EUT, we found test result of the sample that dual SIM was the worst, so we choose dual SIM card mobile to perform all tests.

Product Specification subjective to this standard	
Tx Frequency	GSM850: 824.2 MHz ~ 848.8 MHz GSM1900: 1850.2 MHz ~ 1909.8MHz
Rx Frequency	GSM850: 869.2 MHz ~ 893.8 MHz GSM1900: 1930.2 MHz ~ 1989.8 MHz
Maximum Output Power to Antenna	GSM850 : 32.56 dBm GSM1900 : 30.13 dBm
Antenna Type	Dipole Antenna
Type of Modulation	GMSK

1.4 Maximum ERP/EIRP Power, Frequency Tolerance, and Emission Designator

FCC Rule	System	Type of Modulation	Maximum ERP/EIRP (W)	Frequency Tolerance (% , Hz, ppm)	Emission Designator
Part 22	GSM850 GSM	GMSK	0.5117	0.02 ppm	244KGXW
Part 24	GSM1900 GSM	GMSK	0.8831	0.03 ppm	246KGXW

1.5 Testing Site

Test Site	SPORTON INTERNATIONAL (KUNSHAN) INC.		
Test Site Location	No. 3-2, PingXiang Road, Kunshan, Jiangsu Province, P.R.C. TEL: +86-0512-5790-0158 FAX: +86-0512-5790-0958		
Test Site No.	Sporton Site No.		FCC/IC Registration No.
	TH01-KS	03CH01-KS	149928/4086E-1

1.6 Applied Standards

According to the specifications of the manufacturer, the EUT must comply with the requirements of the following standards:

- FCC 47 CFR Part 2, 22(H), 24(E)
- ANSI / TIA / EIA-603-C-2004
- FCC KDB 971168 D01 Power Meas. License Digital Systems v01
- IC RSS-132 Issue 2
- IC RSS-133 Issue 5

Remark:

1. All test items were verified and recorded according to the standards and without any deviation during the test.
2. This EUT has also been tested and complied with the requirements of FCC Part 15, Subpart B, recorded in a separate test report.



1.7 Ancillary Equipment List

Item	Equipment	Trade Name	Model No.	FCC ID	Data Cable	Power Cord
1.	System Simulator	R&S	CMU200	N/A	N/A	Unshielded, 1.8 m
2.	DC Power Supply	GWINSTEK	GPS-3030D	N/A	N/A	Unshielded, 1.8 m

2 Test Configuration of Equipment Under Test

2.1 Test Mode

During all testing, EUT is in link mode with base station emulator at maximum power level. The spurious emission measurements were carried out in semi-anechoic chamber with 3-meter test range, and EUT is rotated on three test planes to find out the worst emission.

Frequency range investigated for radiated emission is as follows:

1. 30 MHz to 9000 MHz for GSM850.
2. 30 MHz to 19000 MHz for GSM1900.

Test Modes		
Band	Radiated TCs	Conducted TCs
GSM 850	■ GSM Link	■ GSM Link
GSM 1900	■ GSM Link	■ GSM Link

Note: The maximum power levels are GSM mode for GMSK link, only these modes were used for all tests.

The conducted power tables are as follows:

Conducted Power (*Unit: dBm)						
Band	GSM850			GSM1900		
Channel	128	189	251	512	661	810
Frequency	824.2	836.4	848.8	1850.2	1880.0	1909.8
GSM	32.56	32.52	32.55	30.13	29.73	29.33

2.2 Connection Diagram of Test System

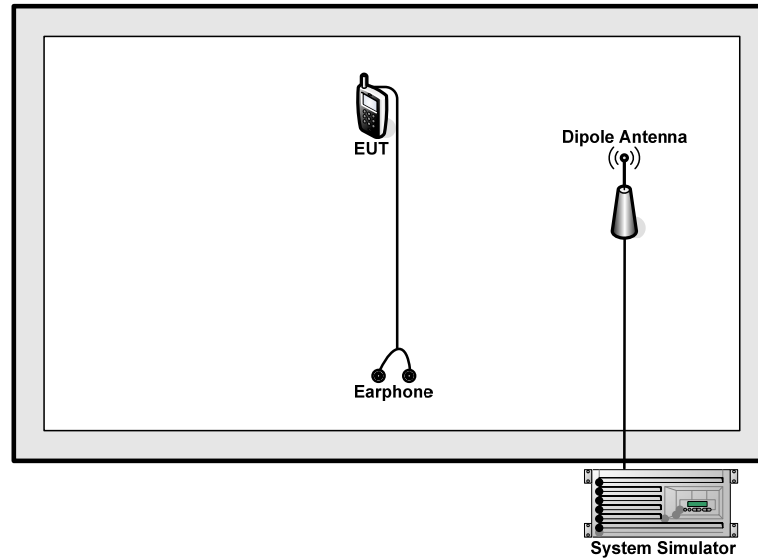

3 Test Result

3.1 Conducted Output Power Measurement

3.1.1 Description of the Conducted Output Power Measurement

A base station simulator was used to establish communication with the EUT. Its parameters were set to transmit the maximum power on the EUT. The measured power in the radio frequency on the transmitter output terminals shall be reported.

3.1.2 Measuring Instruments

See list of measuring instruments of this test report.

3.1.3 Test Procedures

1. The transmitter output port was connected to base station.
2. Set EUT at maximum power through base station.
3. Select lowest, middle, and highest channels for each band and different modulation.
4. Compare each band and different modulation combination to show the worst data rate.

3.1.4 Test Setup

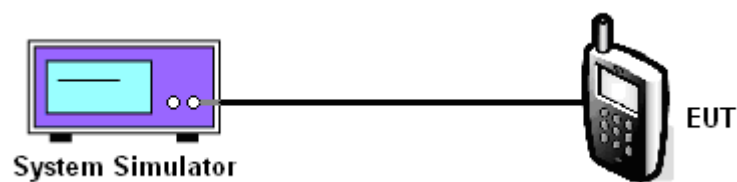

3.1.5 Test Result of Conducted Output Power

Cellular Band			
Mode	GSM850 (GSM)		
Channel	128 (Low)	189 (Mid)	251 (High)
Frequency (MHz)	824.2	836.4	848.8
Conducted Power (dBm)	32.56	32.52	32.55
Conducted Power (Watts)	1.80	1.79	1.80

PCS Band			
Mode	GSM1900 (GSM)		
Channel	512 (Low)	661 (Mid)	810 (High)
Frequency (MHz)	1850.2	1880	1909.8
Conducted Power (dBm)	30.13	29.73	29.33
Conducted Power (Watts)	1.03	0.94	0.86

Note: maximum burst average power for GSM.

3.2 Peak-to-Average Ratio

3.2.1 Description of the PAR Measurement

Power Complementary Cumulative Distribution Function (CCDF) curves provide a means for characterizing the power peaks of a digitally modulated signal on a statistical basis. A CCDF curve depicts the probability of the peak signal amplitude exceeding the average power level. Most contemporary measurement instrumentation include the capability to produce CCDF curves for an input signal provided that the instrument's resolution bandwidth can be set wide enough to accommodate the entire input signal bandwidth. The following guidelines are offered for performing a CCDF measurement.

3.2.2 Measuring Instruments

See list of measuring instruments of this test report.

3.2.3 Test Procedures

1. The EUT was connected to Spectrum Analyzer and Base Station via power divider.
2. The CCDF (Complementary Cumulative Distribution Function) of the middle channel for the highest RF powers were measured.

3.2.4 Test Setup

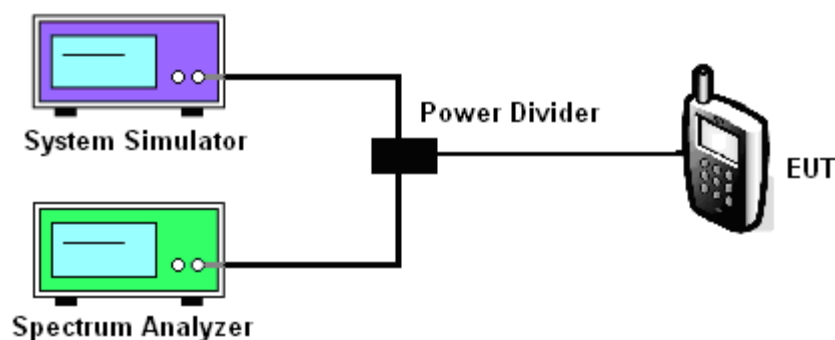



3.2.5 Test Result of Peak-to-Average Ratio

Cellular Band			
Mode	GSM850 (GSM)		
Channel	128 (Low)	189 (Mid)	251 (High)
Frequency (MHz)	824.2	836.4	848.8
Peak-to-Average Ratio (dB)	0.14	0.14	0.13

PCS Band			
Mode	GSM1900 (GSM)		
Channel	512 (Low)	661 (Mid)	810 (High)
Frequency (MHz)	1850.2	1880	1909.8
Peak-to-Average Ratio (dB)	0.07	0.04	0.02



3.2.6 Test Result (Plots) of Peak-to-Average Ratio

Band :	GSM 850	Test Mode :	GSM Link
--------	---------	-------------	----------

Peak-to-Average Ratio on Channel 128 (824.2 MHz)

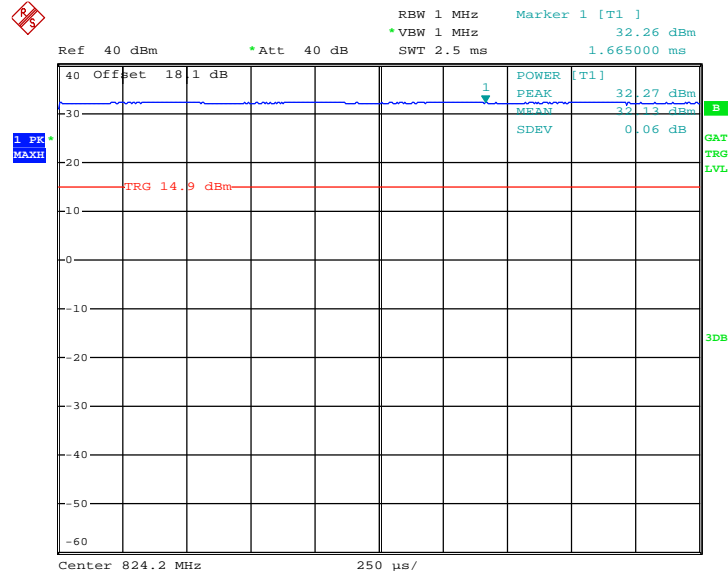

Date: 29.AUG.2012 22:41:11

Peak-to-Average Ratio on Channel 189 (836.4 MHz)

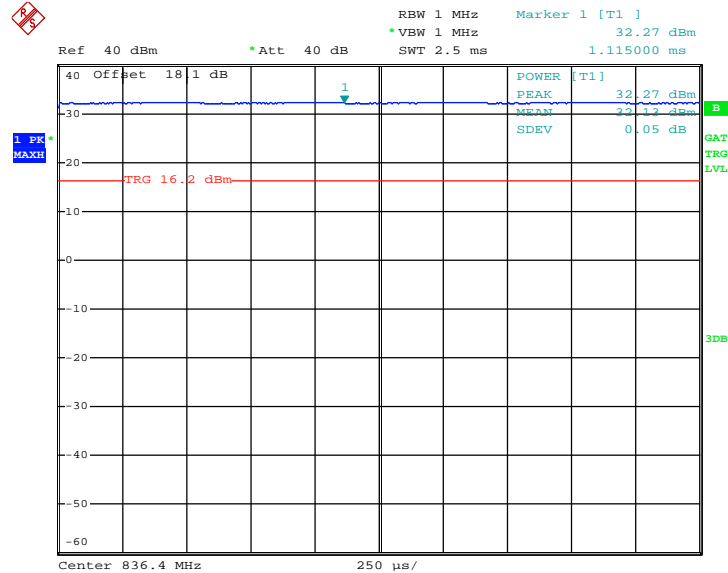

Date: 29.AUG.2012 22:40:30



Peak-to-Average Ratio on Channel 251 (848.8 MHz)

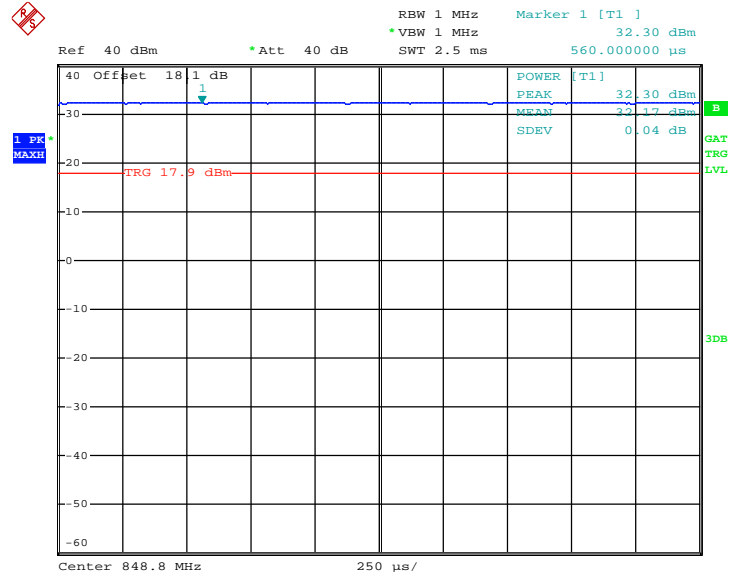

Date: 29.AUG.2012 22:39:40



Band :	GSM 1900	Test Mode :	GSM Link
--------	----------	-------------	----------

Peak-to-Average Ratio on Channel 512 (1850.2 MHz)

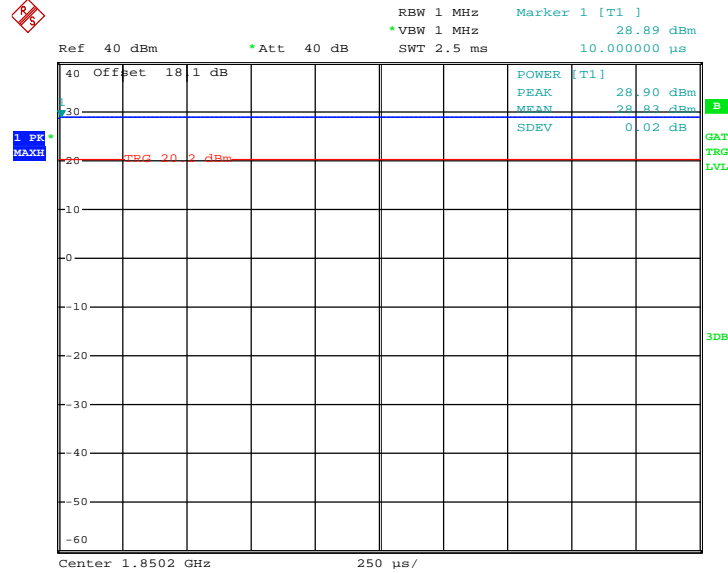

Date: 29.AUG.2012 22:43:29

Peak-to-Average Ratio on Channel 661 (1880.0 MHz)

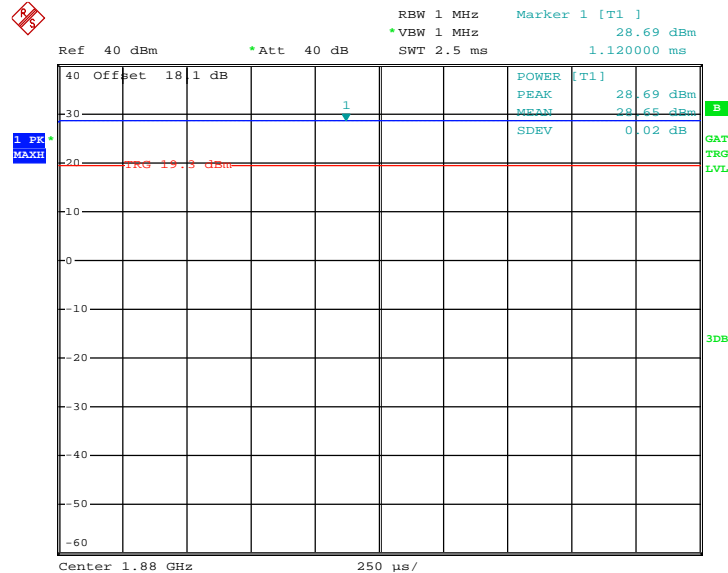

Date: 29.AUG.2012 22:42:43



Peak-to-Average Ratio on Channel 810 (1909.8 MHz)

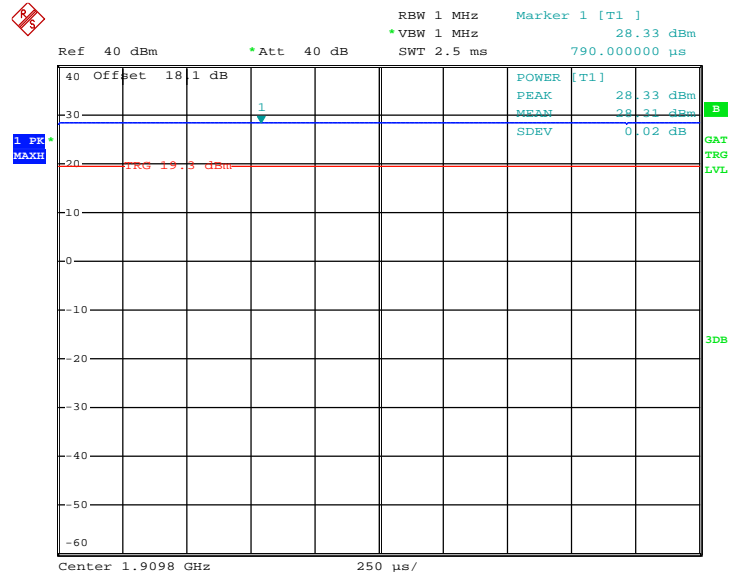

Date: 29.AUG.2012 22:44:11

3.3 Effective Radiated Power and Effective Isotropic Radiated Power Measurement

3.3.1 Description of the ERP/EIRP Measurement

The substitution method, in ANSI / TIA / EIA-603-C-2004, was used for ERP/EIRP measurement, and the spectrum analyzer configuration follows KDB 971168 D01 Power Meas. License Digital Systems v01. The ERP of mobile transmitters must not exceed 7 Watts and the EIRP of mobile transmitters are limited to 2 Watts.

3.3.2 Measuring Instruments

See list of measuring instruments of this test report.

3.3.3 Test Procedures

1. The EUT was placed on a turntable with 1.0 meter height in a fully anechoic chamber.
2. The EUT was set at 1.2 meters from the receiving antenna, which was mounted on the antenna tower.
3. The table was rotated 360 degrees to determine the position of the highest radiated power.
4. The height of the receiving antenna is adjusted to look for the maximum ERP/EIRP.
5. Taking the record of maximum ERP/EIRP.
6. A dipole antenna was substituted in place of the EUT and was driven by a signal generator.
7. The conducted power at the terminal of the dipole antenna is measured.
8. Repeat step 3 to step 5 to get the maximum ERP/EIRP of the substitution antenna.
9. $ERP/EIRP = P_s + E_t - E_s + G_s = P_s + R_t - R_s + G_s$

P_s (dBm) : Input power to substitution antenna.

G_s (dBi or dBd) : Substitution antenna Gain.

$E_t = R_t + AF$

$E_s = R_s + AF$

AF (dB/m) : Receive antenna factor

R_t : The highest received signal in spectrum analyzer for EUT.

R_s : The highest received signal in spectrum analyzer for substitution antenna.

3.3.4 Test Setup

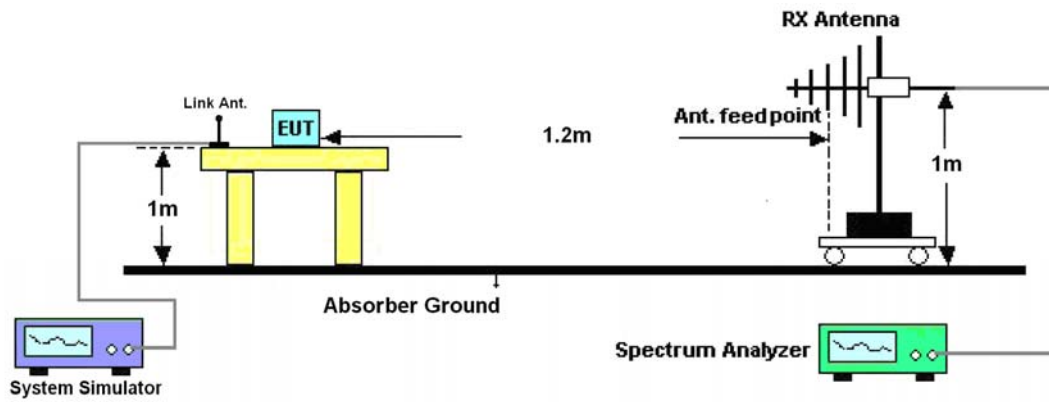

3.3.5 Test Result of ERP

GSM850 (GSM) Radiated Power ERP						
Horizontal Polarization						
Frequency (MHz)	Rt (dBm)	Rs (dBm)	Ps (dBm)	Gs (dBd)	ERP (dBm)	ERP (W)
824.20	-19.95	-48.12	0.00	-1.08	27.09	0.5117
836.40	-20.27	-48.28	0.00	-0.93	27.08	0.5105
848.80	-21.04	-48.35	0.00	-0.76	26.55	0.4519
Vertical Polarization						
Frequency (MHz)	Rt (dBm)	Rs (dBm)	Ps (dBm)	Gs (dBd)	ERP (dBm)	ERP (W)
824.20	-37.61	-47.97	0.00	-1.08	9.28	0.0085
836.40	-38.28	-48.01	0.00	-0.93	8.80	0.0076
848.80	-39.08	-48.05	0.00	-0.76	8.21	0.0066

3.3.6 Test Result of EIRP

GSM1900 (GSM) Radiated Power EIRP						
Horizontal Polarization						
Frequency (MHz)	Rt (dBm)	Rs (dBm)	Ps (dBm)	Gs (dBi)	EIRP (dBm)	EIRP (W)
1850.20	-24.47	-51.88	0.00	1.96	29.37	0.8650
1880.00	-26.14	-52.99	0.00	2.00	28.85	0.7674
1909.80	-27.91	-54.28	0.00	1.98	28.35	0.6839
Vertical Polarization						
Frequency (MHz)	Rt (dBm)	Rs (dBm)	Ps (dBm)	Gs (dBi)	EIRP (dBm)	EIRP (W)
1850.20	-24.63	-52.13	0.00	1.96	29.46	0.8831
1880.00	-26.23	-53.17	0.00	2.00	28.94	0.7834
1909.80	-28.00	-54.13	0.00	1.98	28.11	0.6471

3.4 Occupied Bandwidth and 26dB Bandwidth Measurement

3.4.1 Description of Occupied Bandwidth and 26dB Bandwidth Measurement

The occupied bandwidth is the width of a frequency band such that, below the lower and above the upper frequency limits, the mean powers emitted are each equal to a specified percentage 0.5% of the total mean transmitted power.

The emission bandwidth is defined as the width of the signal between two points, located at the 2 sides of the carrier frequency, outside of which all emissions are attenuated at least 26 dB below the transmitter power.

3.4.2 Measuring Instruments

See list of measuring instruments of this test report.

3.4.3 Test Procedures

1. The EUT was connected to Spectrum Analyzer and Base Station via power divider.
2. The 99% occupied bandwidth and 26 dB bandwidth of the middle channel for the highest RF powers were measured.

3.4.4 Test Setup

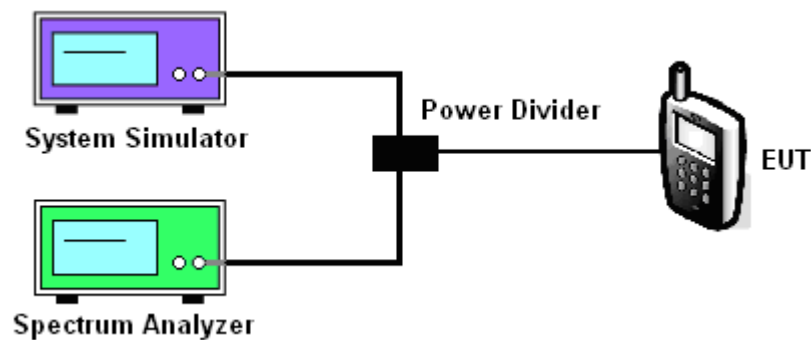

3.4.5 Test Result of Occupied Bandwidth and 26dB Bandwidth

Cellular Band			
Modes	GSM850 (GSM)		
Channel	128 (Low)	189 (Mid)	251 (High)
Frequency (MHz)	824.2	836.4	848.8
99% OBW (KHz)	244.00	244.00	244.00
26dB BW (KHz)	308.00	308.00	310.00

PCS Band			
Modes	GSM1900 (GSM)		
Channel	512 (Low)	661 (Mid)	810 (High)
Frequency (MHz)	1850.2	1880	1909.8
99% OBW (KHz)	242.00	246.00	246.00
26dB BW (KHz)	308.00	312.00	312.00



3.4.6 Test Result (Plots) of Occupied Bandwidth and 26dB Bandwidth

Band :	GSM 850	Test Mode :	GSM Link
--------	---------	-------------	----------

99% Occupied Bandwidth Plot on Channel 128 (824.2 MHz)

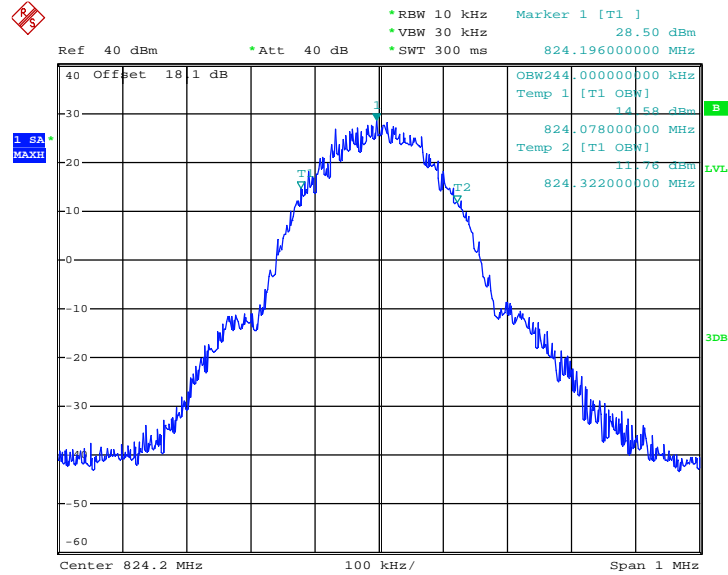

Date: 29.AUG.2012 22:33:47

26dB Bandwidth Plot on Channel 128 (824.2 MHz)

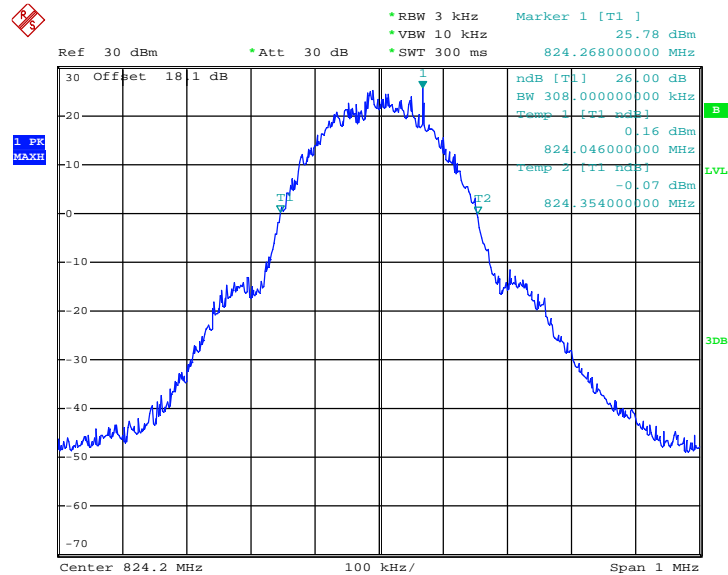

Date: 29.AUG.2012 22:24:30



99% Occupied Bandwidth Plot on Channel 189 (836.4 MHz)

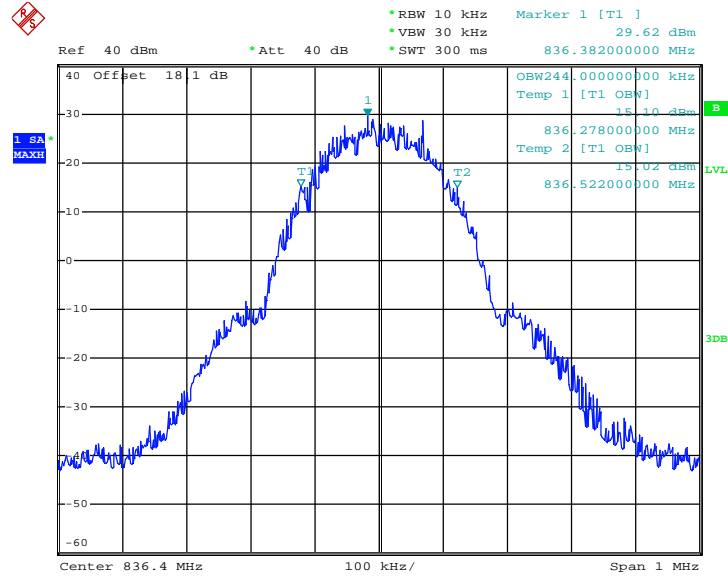

Date: 29.AUG.2012 22:32:43

26dB Bandwidth Plot on Channel 189 (836.4 MHz)

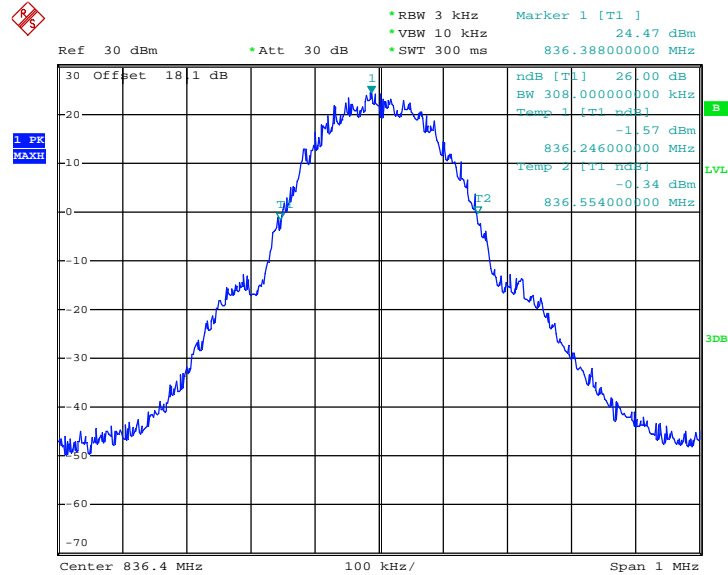

Date: 29.AUG.2012 22:23:39



99% Occupied Bandwidth Plot on Channel 251 (848.8 MHz)

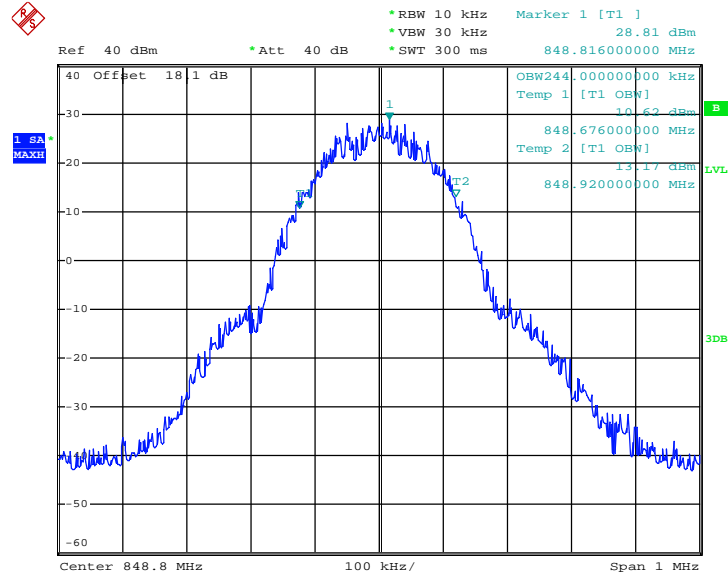

Date: 29.AUG.2012 22:31:30

26dB Bandwidth Plot on Channel 251 (848.8 MHz)

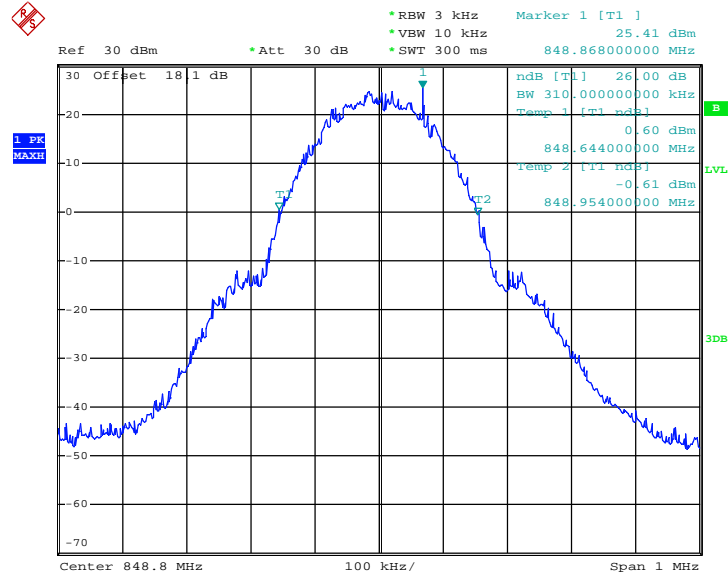

Date: 29.AUG.2012 22:28:17



Band :	GSM 1900	Test Mode :	GSM Link
--------	----------	-------------	----------

99% Occupied Bandwidth Plot on Channel 512 (1850.2 MHz)

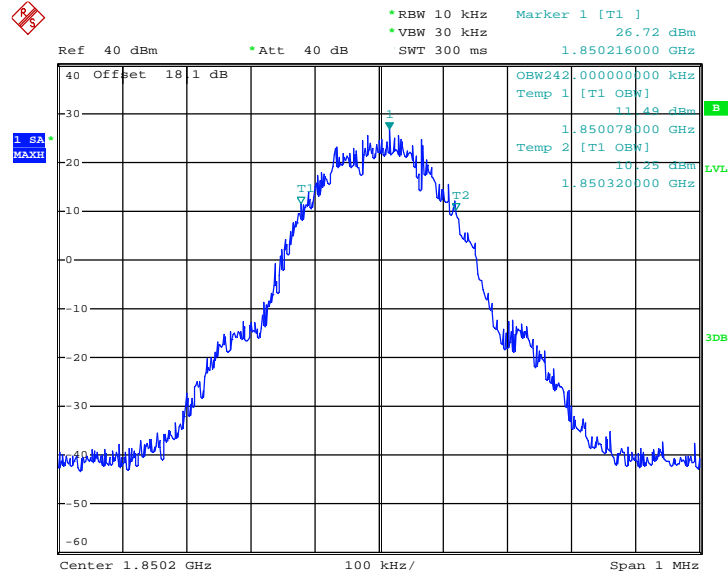

Date: 29.AUG.2012 22:50:02

26dB Bandwidth Plot on Channel 512 (1850.2 MHz)

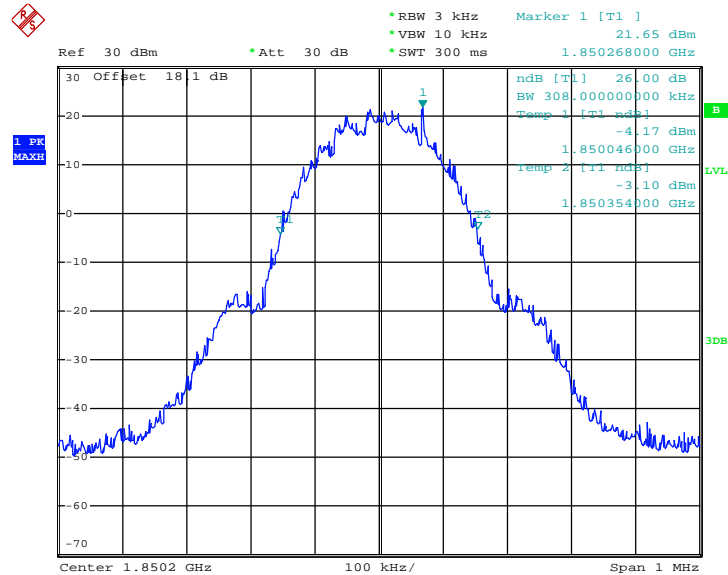

Date: 29.AUG.2012 22:48:03



99% Occupied Bandwidth Plot on Channel 661 (1880.0 MHz)

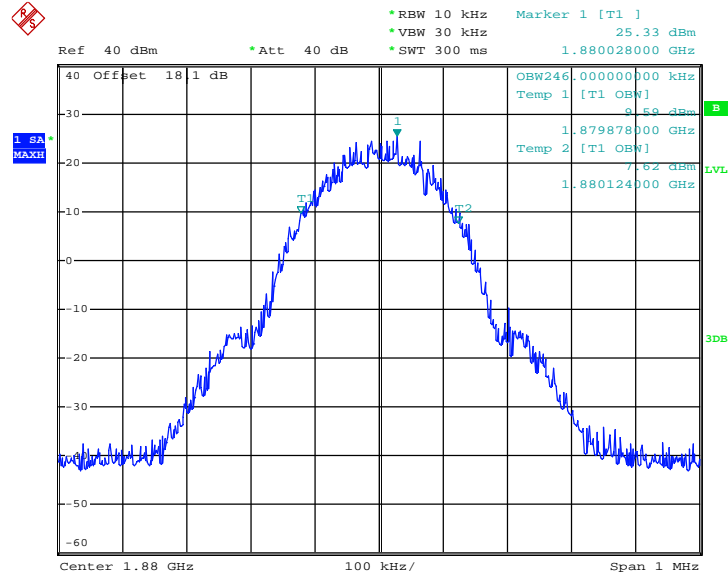

Date : 29.AUG.2012 22:50:53

26dB Bandwidth Plot on Channel 661 (1880.0 MHz)

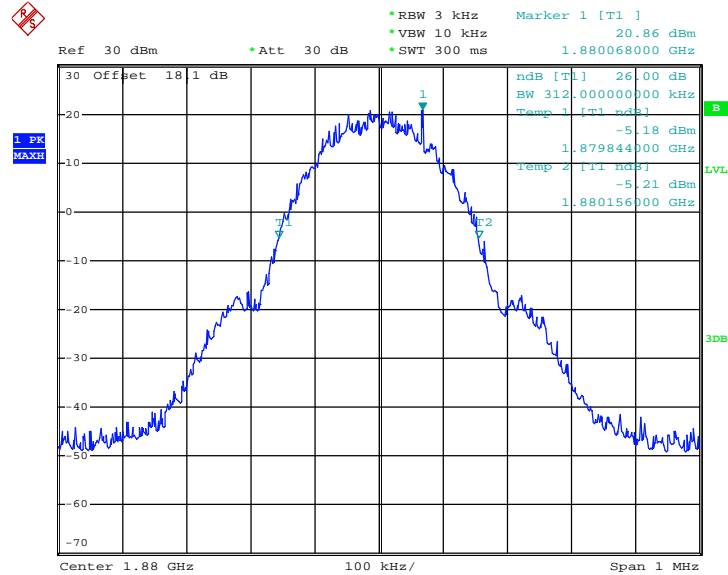

Date : 29.AUG.2012 22:47:03



99% Occupied Bandwidth Plot on Channel 810 (1909.8 MHz)

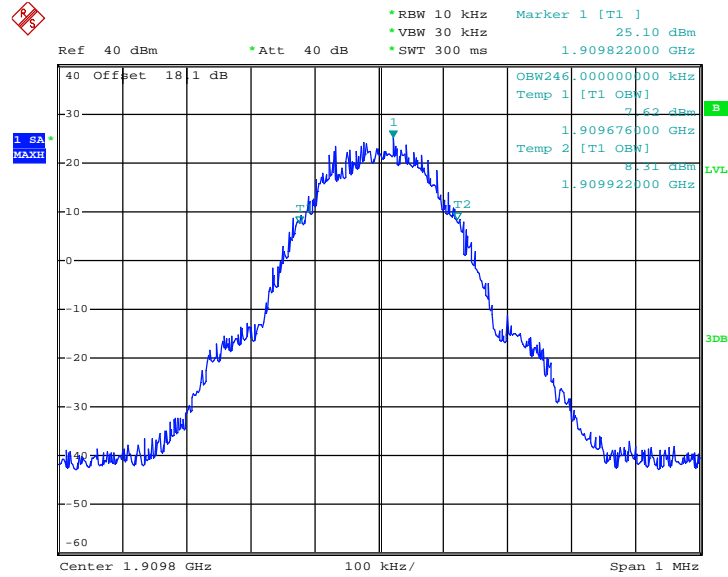

Date: 29.AUG.2012 22:51:52

26dB Bandwidth Plot on Channel 810 (1909.8 MHz)

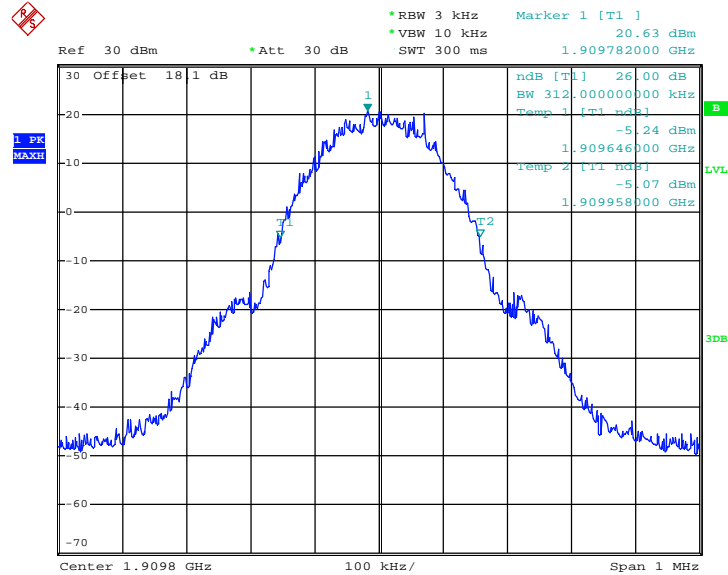

Date: 29.AUG.2012 22:46:07

3.5 Band Edge Measurement

3.5.1 Description of Band Edge Measurement

The power of any emission outside of the authorized operating frequency ranges must be lower than the transmitter power (P) by a factor of at least $43 + 10 \log (P)$ dB.

3.5.2 Measuring Instruments

See list of measuring instruments of this test report.

3.5.3 Test Procedures

1. The EUT was connected to Spectrum Analyzer and Base Station via power divider.
2. The band edges of low and high channels for the highest RF powers were measured. Setting RBW as roughly $BW/100$.

3.5.4 Test Setup

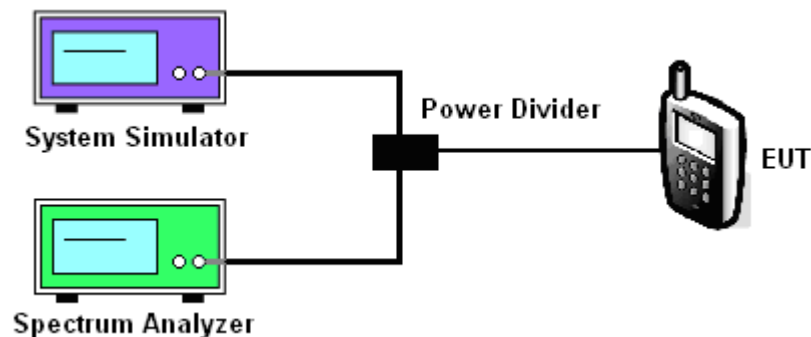

3.5.5 Test Result (Plots) of Conducted Band Edge

Band :	GSM850	Test Mode :	GSM Link
Correction Factor :	0.14dB	Maximum 26dB Bandwidth :	0.310MHz
Band Edge :	-18.62dBm	Measurement Value :	-18.76dBm

Lower Band Edge Plot on Channel 128 (824.2 MHz)

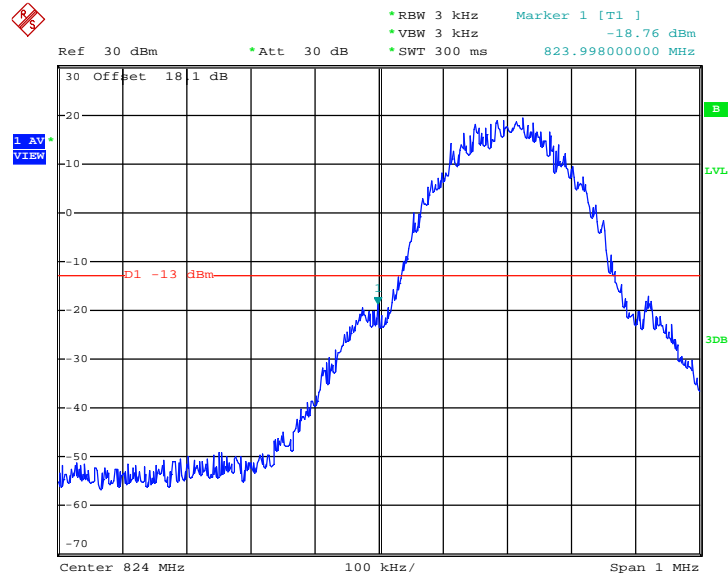

Date: 29.AUG.2012 22:35:45

1. Correction Factor(dB)= 10log(1% Emission BW/RBW)
 2. Band Edge= Measurement Value + Correction Factor(dB)
- For example, -18.76dBm + 0.14dB = -18.62dBm



Band :	GSM850	Test Mode :	GSM Link
Correction Factor :	0.14dB	Maximum 26dB Bandwidth :	0.310MHz
Band Edge :	-17.05dBm	Measurement Value :	-17.19dBm

Higher Band Edge Plot on Channel 251 (848.8 MHz)

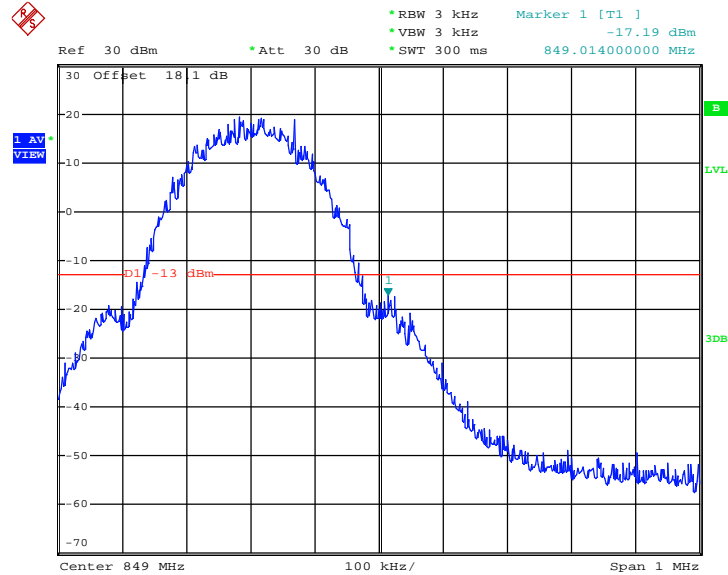

Date: 29.AUG.2012 22:37:09

1. Correction Factor(dB)= $10\log(1\% \text{ Emission BW/RBW})$
2. Band Edge= Measurement Value + Correction Factor(dB)



Band :	GSM1900	Test Mode :	GSM Link
Correction Factor :	0.17dB	Maximum 26dB Bandwidth :	0.312MHz
Band Edge :	-21.37dBm	Measurement Value :	-21.54dBm

Lower Band Edge Plot on Channel 512 (1850.2 MHz)

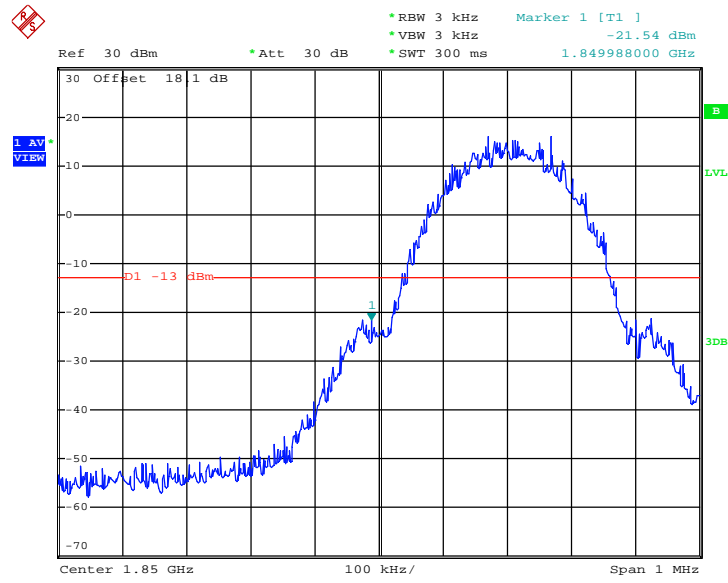

Date: 29.AUG.2012 22:55:33

1. Correction Factor(dB)= $10\log(1\% \text{ Emission BW/RBW})$
2. Band Edge= Measurement Value + Correction Factor(dB)

3.6 Conducted Spurious Emission Measurement

3.6.1 Description of Conducted Spurious Emission Measurement

The power of any emission outside of the authorized operating frequency ranges must be lower than the transmitter power (P) by a factor of at least $43 + 10 \log (P)$ dB.

It is measured by means of a calibrated spectrum analyzer and scanned from 30 MHz up to a frequency including its 10th harmonic.

3.6.2 Measuring Instruments

See list of measuring instruments of this test report.

3.6.3 Test Procedures

1. The EUT was connected to spectrum analyzer and base station via power divider.
2. The middle channel for the highest RF power within the transmitting frequency was measured.
3. The conducted spurious emission for the whole frequency range was taken.

3.6.4 Test Setup

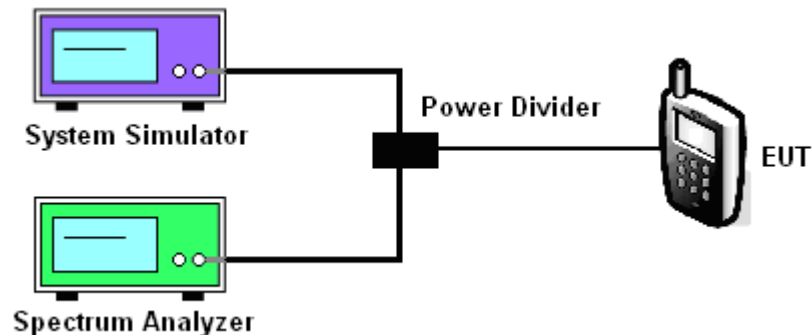



3.6.5 Test Result (Plots) of Conducted Spurious Emission

Band :	GSM850	Channel :	CH189
Test Mode :	GSM Link	Frequency :	836.4 MHz

Conducted Spurious Emission Plot between 30MHz ~ 1GHz

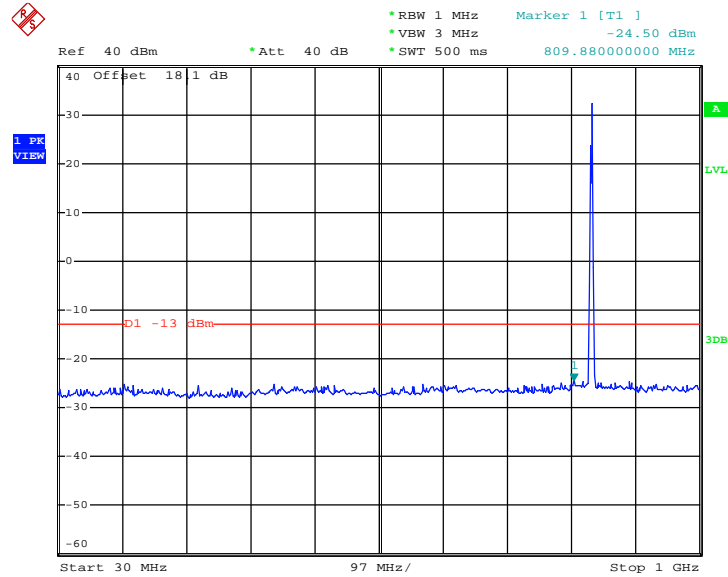

Date: 31.AUG.2012 05:51:24

Conducted Spurious Emission Plot between 1GHz ~ 3GHz

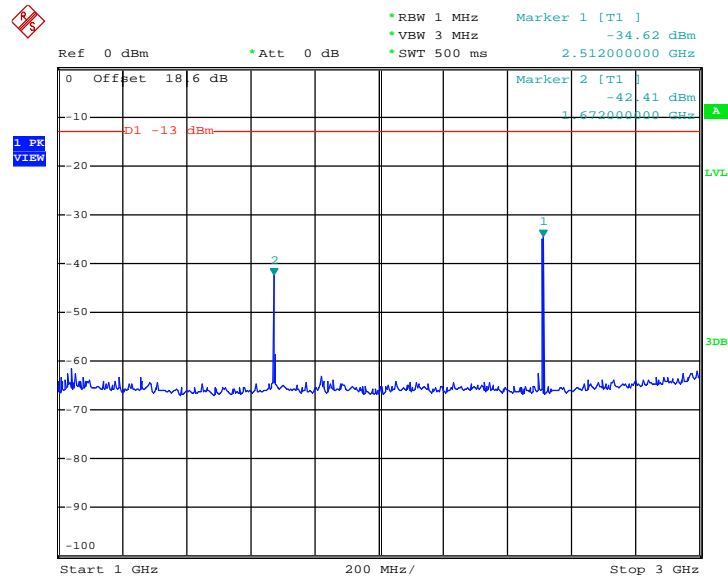

Date: 31.AUG.2012 05:42:20



Conducted Spurious Emission Plot between 3GHz ~ 7GHz

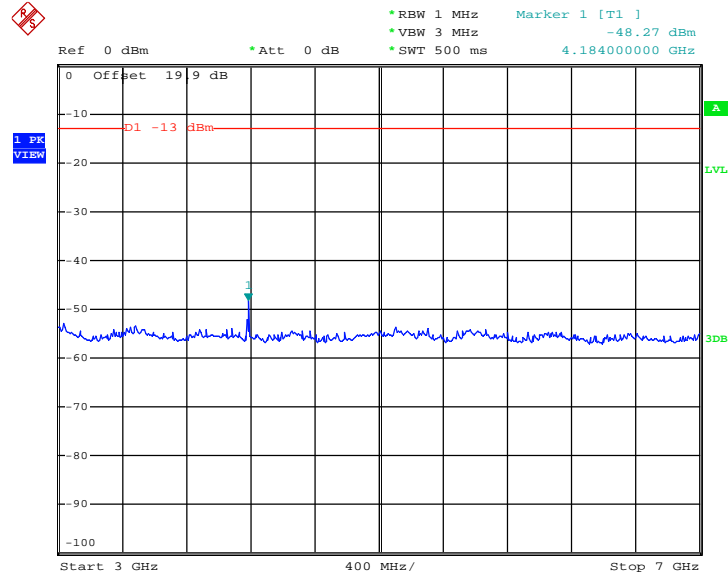

Date: 31.AUG.2012 05:43:51

Conducted Spurious Emission Plot between 7GHz ~ 9GHz

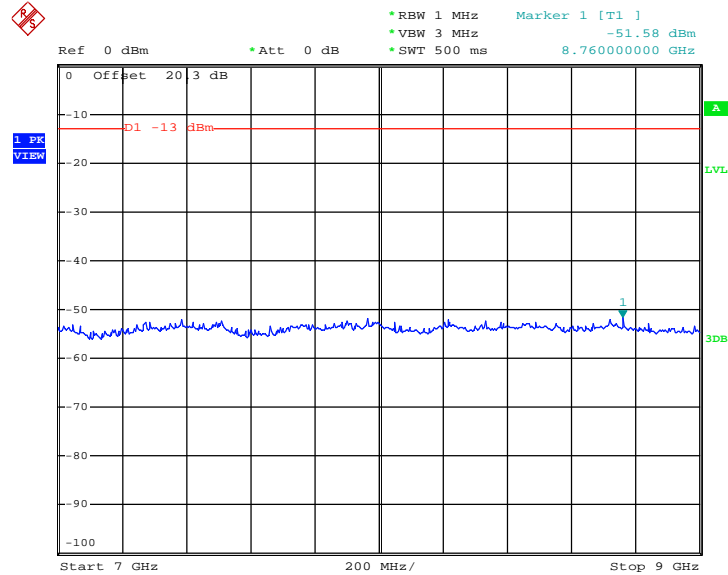

Date: 31.AUG.2012 05:45:15



Band :	GSM1900	Channel :	CH661
Test Mode :	GSM Link	Frequency :	1880.0 MHz

Conducted Spurious Emission Plot between 30MHz ~ 1GHz

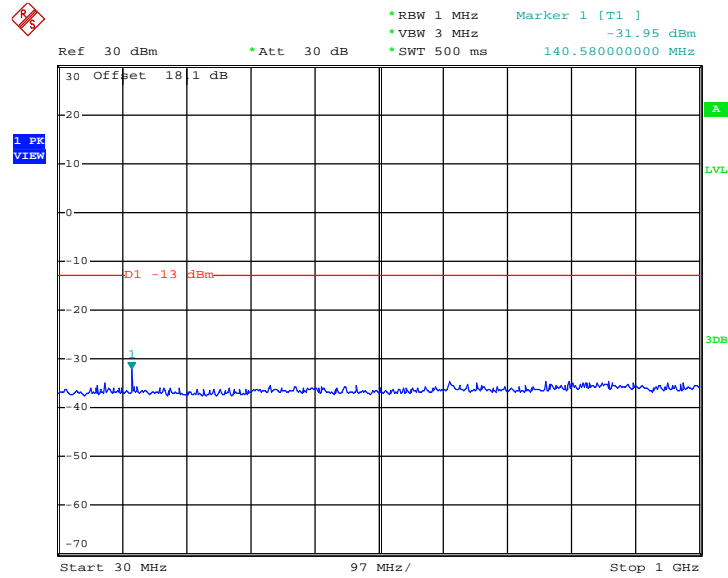

Date: 31.AUG.2012 05:29:04

Conducted Spurious Emission Plot between 1GHz ~ 3GHz

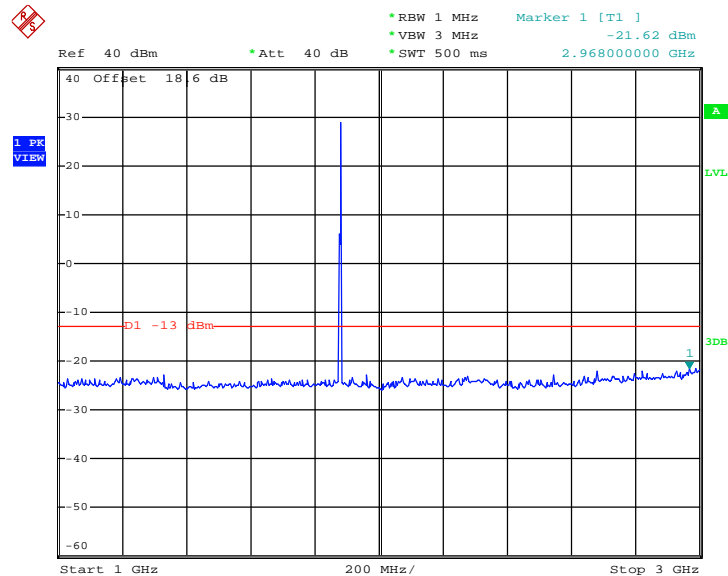

Date: 31.AUG.2012 05:30:25



Conducted Spurious Emission Plot between 3GHz ~ 7GHz

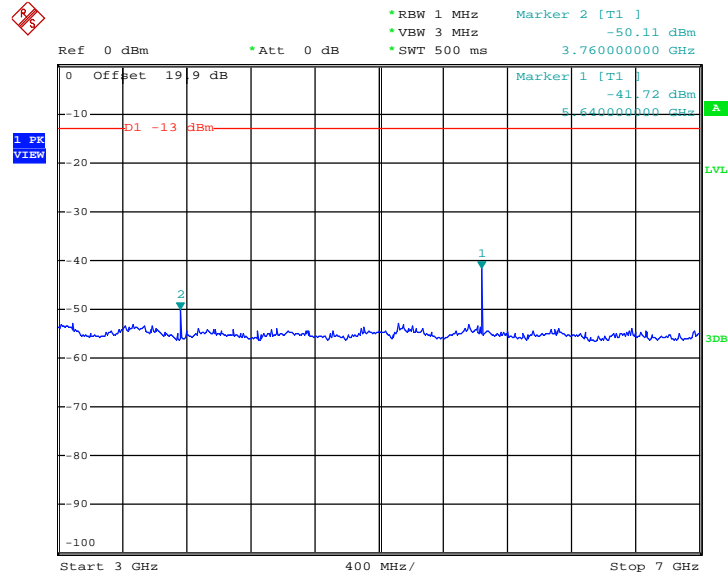

Date: 31.AUG.2012 05:32:30

Conducted Emission Plot between 7GHz ~ 13.6GHz

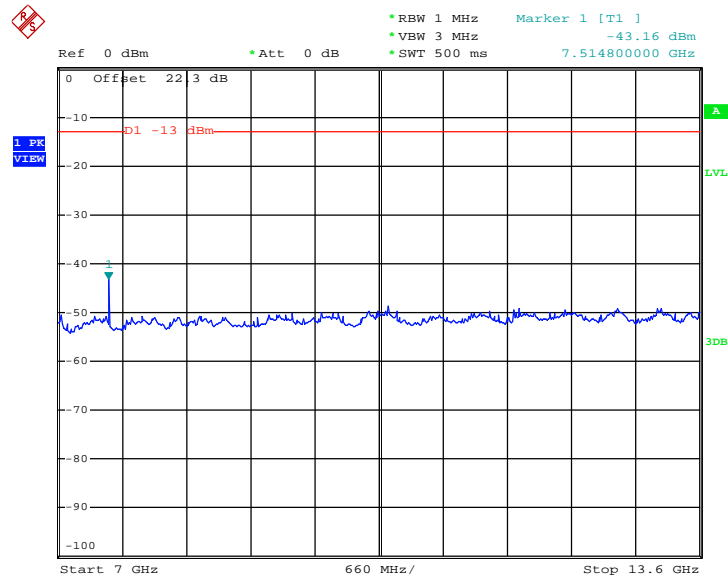

Date: 31.AUG.2012 05:33:48



Conducted Spurious Emission Plot between 13.6GHz ~ 19.1GHz

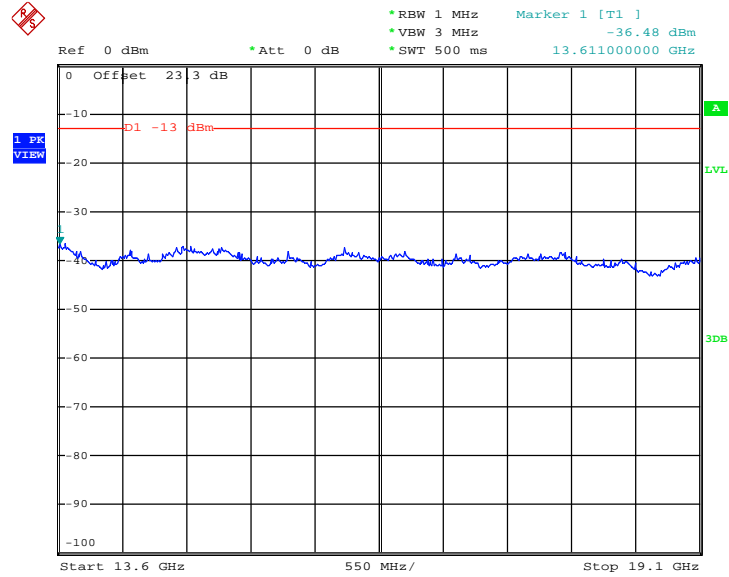

Date: 31.AUG.2012 05:34:59

3.7 Field Strength of Spurious Radiation Measurement

3.7.1 Description of Field Strength of Spurious Radiated Measurement

The radiated spurious emission was measured by substitution method according to ANSI / TIA / EIA-603-C-2004. The power of any emission outside of the authorized operating frequency ranges must be attenuated below the transmitter power (P) by a factor of at least $43 + 10 \log (P)$ dB. The spectrum is scanned from 30 MHz up to a frequency including its 10th harmonic.

3.7.2 Measuring Instruments

See list of measuring instruments of this test report.

3.7.3 Test Procedures

1. The EUT was placed on a rotatable wooden table with 0.8 meter above ground.
2. The EUT was set 3 meters from the receiving antenna, which was mounted on the antenna tower.
3. The table was rotated 360 degrees to determine the position of the highest spurious emission.
4. The height of the receiving antenna is varied between one meter and four meters to search the maximum spurious emission for both horizontal and vertical polarizations.
5. Make the measurement with the spectrum analyzer's RBW = 1MHz, VBW = 3MHz, taking the record of maximum spurious emission.
6. A horn antenna was substituted in place of the EUT and was driven by a signal generator.
7. Tune the output power of signal generator to the same emission level with EUT maximum spurious emission.
8. Taking the record of output power at antenna port.
9. Repeat step 7 to step 8 for another polarization.
10. $EIRP \text{ (dBm)} = S.G. \text{ Power} - Tx \text{ Cable Loss} + Tx \text{ Antenna Gain}$
11. $ERP \text{ (dBm)} = EIRP - 2.15$

3.7.4 Test Setup

For radiated emissions below 30MHz

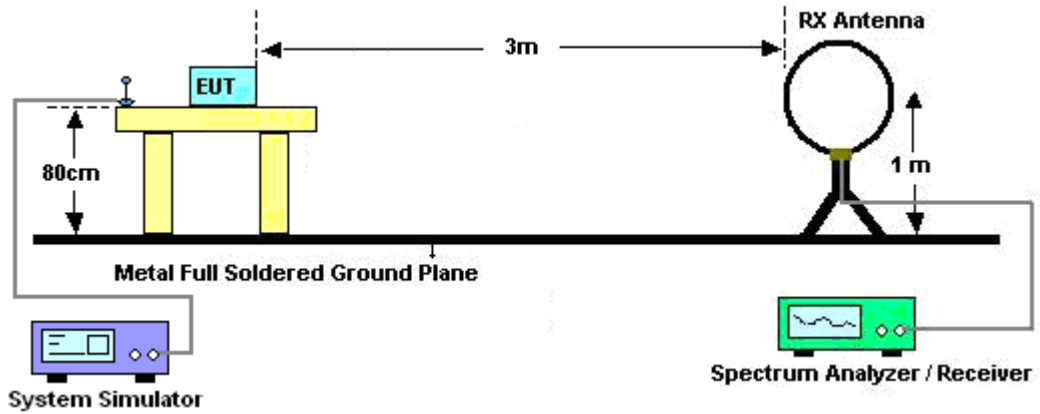

For radiated emissions from 30MHz to 1GHz

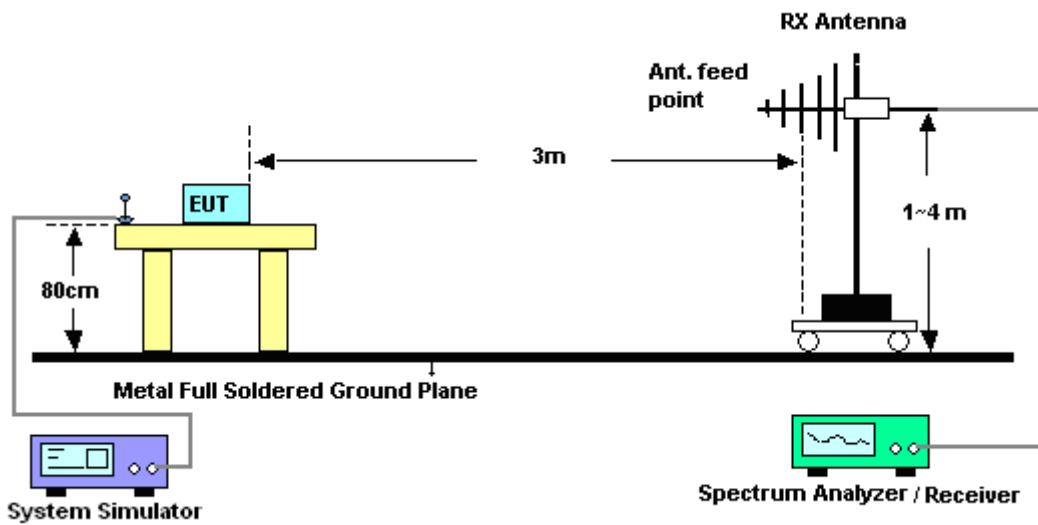

For radiated emissions above 1GHz

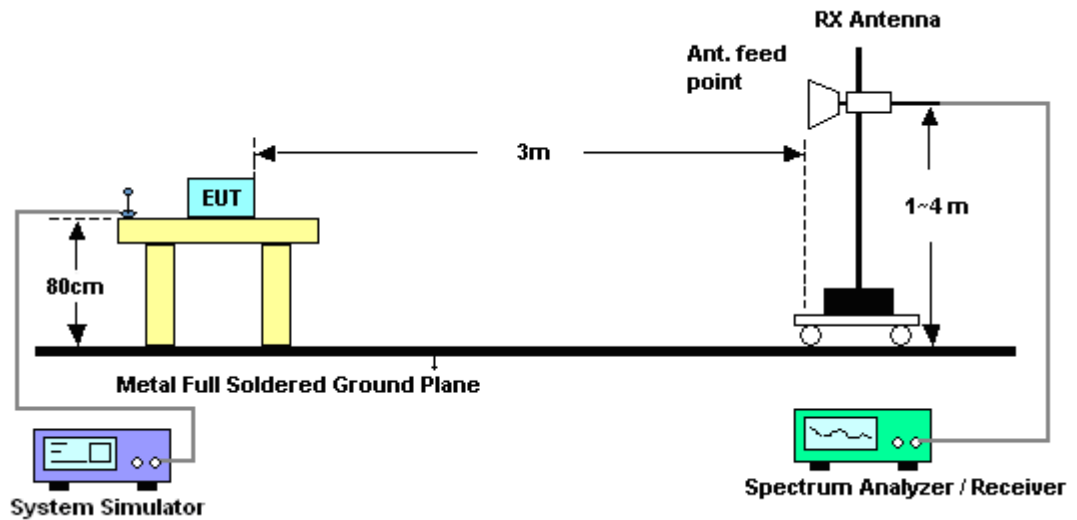

3.7.5 Test Results of Radiated Emissions (9 KHz ~ 30 MHz)

The low frequency, which started from 9 KHz to 30MHz, was pre-scanned and the result which was 20dB lower than the limit line per 15.31(o) was not reported.



3.7.6 Test Result of Field Strength of Spurious Radiated

Band :	GSM850	Temperature :	23~25°C
Test Mode :	GSM Link	Relative Humidity :	41~43%
Test Engineer :	Steven Hao	Polarization :	Horizontal
Remark :	Spurious emissions within 30-1000MHz were found more than 20dB below limit line.		

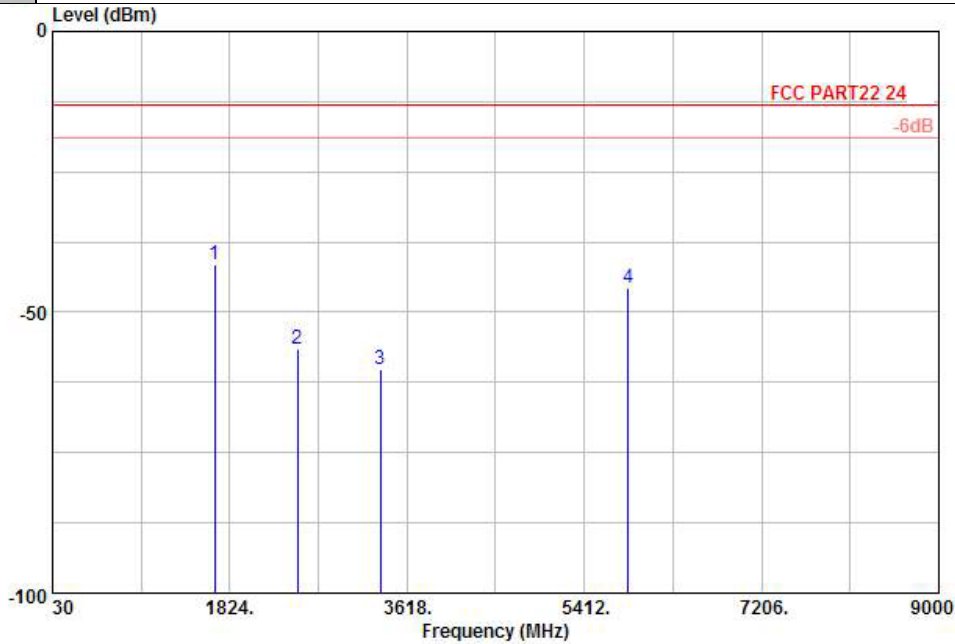

Site : 03CH01-KS
 Condition: FCC PART22 24 HF EIRP FACTOR-09020 HORIZONTAL
 Project : (FG) 281601
 Plan : E1

Frequency (MHz)	ERP (dBm)	Limit (dBm)	Over Limit (dB)	SPA Reading (dBm)	S.G. Power (dBm)	TX Cable loss (dB)	TX Antenna Gain (dBi)	Polarization (H/V)	Result
1672	-41.41	-13	-28.41	-41.63	-42.14	1.2	4.08	H	Pass
2509	-56.56	-13	-43.56	-61.68	-59.09	1.55	6.23	H	Pass
3345	-60.28	-13	-47.28	-65.46	-63.46	2.1	7.43	H	Pass
5854	-45.70	-13	-32.70	-60.41	-50.64	3.12	10.21	H	Pass



Band :	GSM850	Temperature :	23~25°C
Test Mode :	GSM Link	Relative Humidity :	41~43%
Test Engineer :	Steven Hao	Polarization :	Vertical
Remark :	Spurious emissions within 30-1000MHz were found more than 20dB below limit line.		

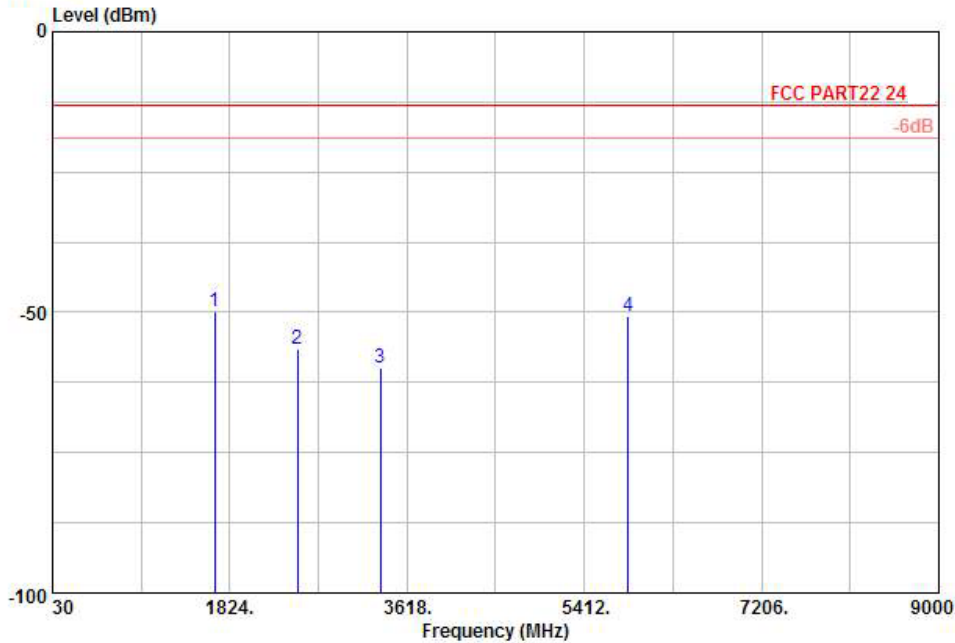

Site : 03CH01-KS
 Condition: FCC PART22 24 HF EIRP FACTOR-09020 VERTICAL
 Project : (FG) 281601
 Plan : E1

Frequency (MHz)	ERP (dBm)	Limit (dBm)	Over Limit (dB)	SPA Reading (dBm)	S.G. Power (dBm)	TX Cable loss (dB)	TX Antenna Gain (dBi)	Polarization (H/V)	Result
1672	-49.80	-13	-36.80	-50.53	-50.53	1.20	4.08	V	Pass
2509	-56.42	-13	-43.42	-61.01	-58.95	1.55	6.23	V	Pass
3345	-59.84	-13	-46.84	-64.74	-63.02	2.10	7.43	V	Pass
5854	-50.83	-13	-37.83	-65.29	-55.77	3.12	10.21	V	Pass



Band :	GSM1900	Temperature :	23~25°C
Test Mode :	GSM Link	Relative Humidity :	41~43%
Test Engineer :	Steven Hao	Polarization :	Horizontal
Remark :	Spurious emissions within 30-1000MHz were found more than 20dB below limit line.		

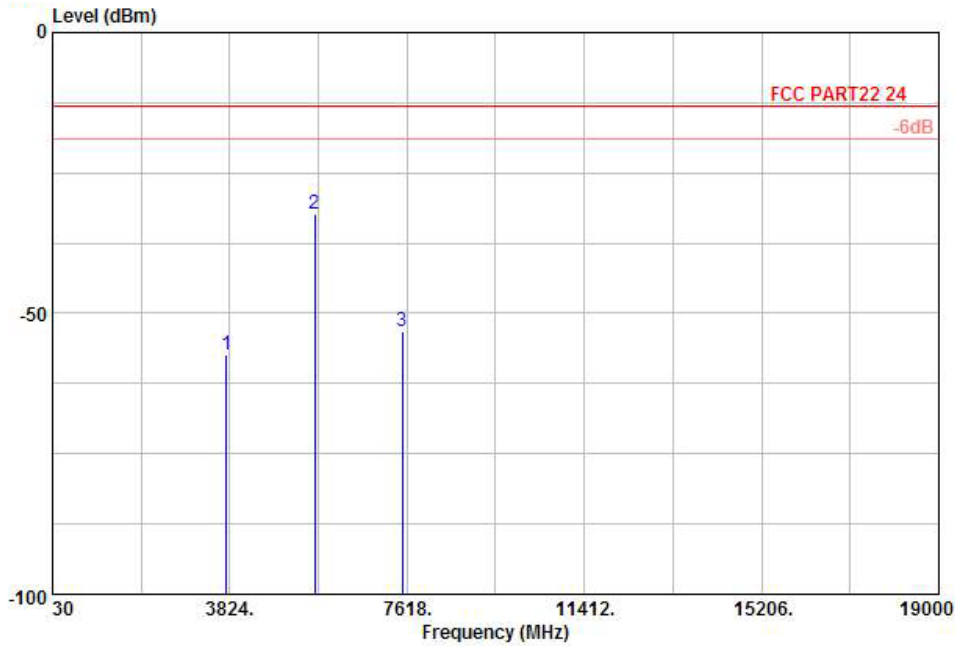

Site : 03CH01-KS
 Condition: FCC PART22 24 HF EIRP FACTOR-09020 HORIZONTAL
 Project : (FG) 281601
 Plan : E1

Frequency (MHz)	EIRP (dBm)	Limit (dBm)	Over Limit (dB)	SPA Reading (dBm)	S.G. Power (dBm)	TX Cable loss (dB)	TX Antenna Gain (dBi)	Polarization (H/V)	Result
3760	-57.45	-13	-44.45	-64.56	-62.85	2.51	7.91	H	Pass
5640	-32.45	-13	-19.45	-51.17	-39.49	3.09	10.13	H	Pass
7520	-53.25	-13	-40.25	-69.13	-61.72	3.11	11.58	H	Pass



Band :	GSM1900	Temperature :	23~25°C
Test Mode :	GSM Link	Relative Humidity :	41~43%
Test Engineer :	Steven Hao	Polarization :	Vertical
Remark :	Spurious emissions within 30-1000MHz were found more than 20dB below limit line.		

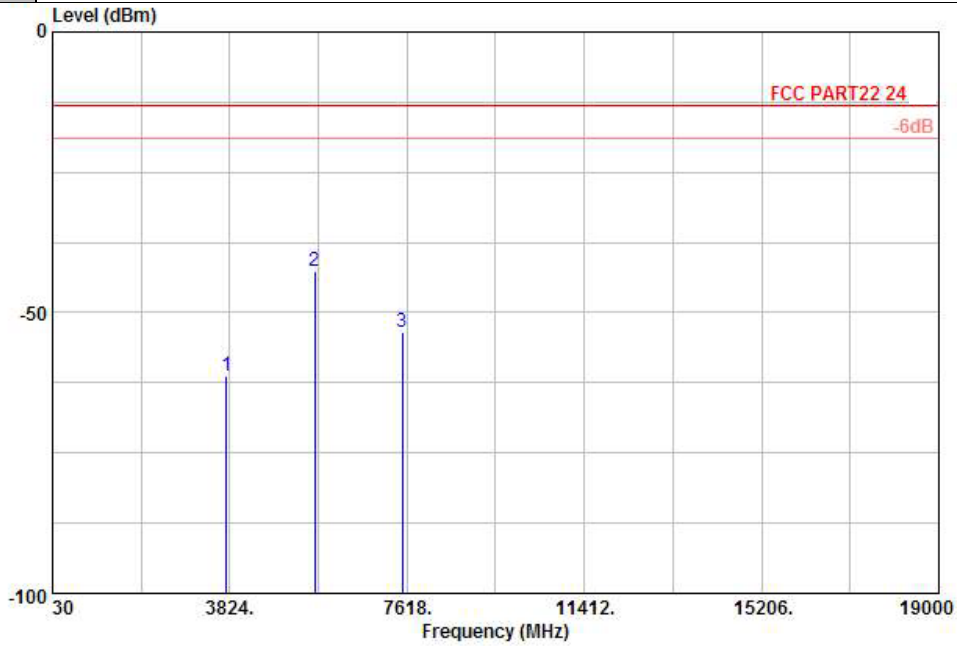

Site : 03CH01-KS
 Condition: FCC PART22 24 HF EIRP FACTOR-09020 VERTICAL
 Project : (FG) 281601
 Plan : E1

Frequency (MHz)	EIRP (dBm)	Limit (dBm)	Over Limit (dB)	SPA Reading (dBm)	S.G. Power (dBm)	TX Cable loss (dB)	TX Antenna Gain (dBi)	Polarization (H/V)	Result
3760	-61.26	-13	-48.26	-66.89	-66.66	2.51	7.91	V	Pass
5640	-42.71	-13	-29.71	-57.89	-49.75	3.09	10.13	V	Pass
7520	-53.48	-13	-40.48	-68.79	-61.95	3.11	11.58	V	Pass

3.8 Frequency Stability Measurement

3.8.1 Description of Frequency Stability Measurement

The frequency stability shall be measured by variation of ambient temperature and variation of primary supply voltage to ensure that the fundamental emission stays within the authorized frequency block. The frequency stability of the transmitter shall be maintained within $\pm 0.00025\%$ ($\pm 2.5\text{ppm}$) of the center frequency.

3.8.2 Measuring Instruments

See list of measuring instruments of this test report.

3.8.3 Test Procedures for Temperature Variation

1. The EUT was set up in the thermal chamber and connected with the base station.
2. With power OFF, the temperature was decreased to -30°C and the EUT was stabilized before testing. Power was applied and the maximum change in frequency was recorded within one minute.
3. With power OFF, the temperature was raised in 10°C step up to 50°C . The EUT was stabilized at each step for at least half an hour. Power was applied and the maximum frequency change was recorded within one minute.
4. If the EUT cannot be turned on at -30°C , the testing lowest temperature will be raised in 10°C step until the EUT can be turned on.

3.8.4 Test Procedures for Voltage Variation

1. The EUT was placed in a temperature chamber at $25\pm 5^{\circ}\text{C}$ and connected with the base station.
2. The power supply voltage to the EUT was varied from BEP to 115% of the nominal value measured at the input to the EUT.
3. The variation in frequency was measured for the worst case.

3.8.5 Test Setup

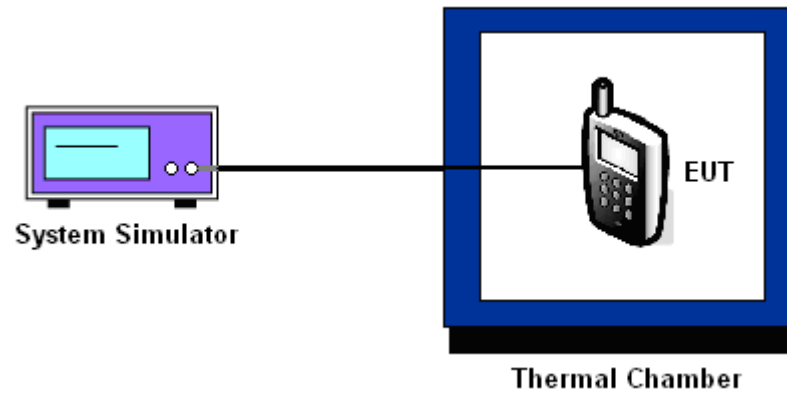

3.8.6 Test Result of Temperature Variation

Band :	GSM 850	Channel :	189
Limit (ppm) :	2.5	Frequency :	836.4 MHz

Temperature (°C)	GSM		Result
	Freq. Dev. (Hz)	Deviation (ppm)	
-30	-17	-0.02	PASS
-20	-16	-0.02	
-10	-15	-0.02	
0	-11	-0.01	
10	-11	-0.01	
20	11	0.01	
30	16	0.02	
40	11	0.01	
50	-10	-0.01	
55	11	0.01	

Note: The manufacturer declared that the EUT could work properly up to temperature 55°C.

Band :	GSM 1900	Channel :	661
Limit (ppm) :	2.5	Frequency :	1880.0 MHz

Temperature (°C)	GSM		Result
	Freq. Dev. (Hz)	Deviation (ppm)	
-30	-51	-0.03	PASS
-20	-48	-0.03	
-10	-47	-0.02	
0	-33	-0.02	
10	32	0.02	
20	30	0.02	
30	35	0.02	
40	-22	-0.01	
50	-33	-0.02	
55	-25	-0.01	

Note: The manufacturer declared that the EUT could work properly up to temperature 55°C.



3.8.7 Test Result of Voltage Variation

Band & Channel	Mode	Voltage (Volt)	Freq. Dev. (Hz)	Deviation (ppm)	Limit (ppm)	Result
GSM 850 CH189	GSM	3.7	11	0.01	2.5	PASS
		BEP	11	0.01		
		4.2	-13	-0.02		
GSM 1900 CH661	GSM	3.7	-38	-0.02		
		BEP	-34	-0.02		
		4.2	-38	-0.02		

Note:

- 1. Normal Voltage = 3.7V.
- 2. Battery End Point (BEP) = 3.5 V.



4 List of Measuring Equipment

Instrument	Manufacturer	Model No.	Serial No.	Characteristics	Calibration Date	Test Date	Due Date	Remark
Spectrum Analyzer	R&S	FSP40	100319	9kHz~40GHz	Dec. 30, 2011	Aug. 29, 2012~ Aug. 31, 2012	Dec. 29, 2012	Conducted (TH01-KS)
System Simulator	R&S	CMU200	837587/066	2G Full-Band	Dec. 30, 2011	Aug. 29, 2012~ Aug. 31, 2012	Dec. 29, 2012	Conducted (TH01-KS)
DC Power Supply	GWINSTEK	GPS-3030D	E1884515	N/A	Aug. 22, 2012	Aug. 29, 2012~ Aug. 31, 2012	Aug. 21, 2013	Conducted (TH01-KS)
Thermal Chamber	Ten Billion	TTC-B3S	TBN-960502	N/A	Dec. 30, 2011	Aug. 29, 2012~ Aug. 31, 2012	Dec. 29, 2012	Conducted (TH01-KS)
EMI Test Receiver	R&S	ESCI	100534	9kHz~3GHz	Nov. 09, 2011	Aug. 29, 2012	Nov. 08, 2012	Radiation (03CH01-KS)
Spectrum Analyzer	R&S	FSP40	100319	9kHz~40GHz	Dec. 30, 2011	Aug. 29, 2012	Dec. 29, 2012	Radiation (03CH01-KS)
Bilog Antenna	SCHAFFNER	CBL6112D	23182	25MHz~2GHz	Dec. 08, 2011	Aug. 29, 2012	Dec. 07, 2012	Radiation (03CH01-KS)
Double Ridge Horn	EMCO	3117	00075959	1GHz~18GHz	Jan. 06, 2012	Aug. 29, 2012	Jan. 05, 2013	Radiation (03CH01-KS)
Amplifier	Wireless	FPA-6592G	060007	30MHz~2GHz	Dec. 30, 2011	Aug. 29, 2012	Dec. 29, 2012	Radiation (03CH01-KS)
Amplifier	Agilent	8449B	3008A02370	1GHz~26.5GHz	Dec. 30, 2011	Aug. 29, 2012	Dec. 29, 2012	Radiation (03CH01-KS)
SHE-EHF Horn	Schwarzbeck	BBHA9170	BBHA170249	15GHz-40GHz	Oct. 11, 2011	Aug. 29, 2012	Oct. 10, 2012	Radiation (03CH01-KS)
Loop Antenna	R&S	HFH2-Z2	860004/001	9KHz ~ 30MHz	Jul. 03, 2012	Aug. 29, 2012	Jul. 02, 2014	Radiation (03CH01-KS)
System Simulator	R&S	CMU200	116456	Full-Band	Sep. 20, 2011	Aug. 29, 2012	Sep. 19, 2012	Radiation (03CH01-KS)

5 Uncertainty of Evaluation

Uncertainty of Radiated Emission Measurement (30 MHz ~ 1000 MHz)

Measuring Uncertainty for a Level of Confidence of 95% ($U = 2Uc(y)$)	2.54
---	------

Uncertainty of Radiated Emission Measurement (1 GHz ~ 40 GHz)

Measuring Uncertainty for a Level of Confidence of 95% ($U = 2Uc(y)$)	4.72
---	------



Appendix A. Photographs of EUT

Please refer to Sporton report number EP281601 as below.