

FCC SAR Test Report

APPLICANT : Brightstar Corporation
EQUIPMENT : Mobile phone
BRAND NAME : Avvio
MODEL NAME : AVVIO 399S
FCC ID : WVBA399S
STANDARD : FCC 47 CFR Part 2 (2.1093)
IEEE C95.1-1991
IEEE 1528-2003
FCC OET Bulletin 65 Supplement C (Edition 01-01)

The product was received on Feb. 17, 2012 and completely tested on Mar. 09, 2012. We, SPORTON INTERNATIONAL (KUNSHAN) INC., would like to declare that the tested sample has been evaluated in accordance with the procedures and shown the compliance with the applicable technical standards.

The test results in this report apply exclusively to the tested model / sample. Without written approval of SPORTON INTERNATIONAL (KUNSHAN) INC., the test report shall not be reproduced except in full.

Reviewed by:



Jones Tsai / Manager



SPORTON INTERNATIONAL (KUNSHAN) INC.
No. 3-2, PingXiang Road, Kunshan, Jiangsu Province, P.R.C.



Table of Contents

| | |
|------------------------------------------------------|-----------|
| 1. Statement of Compliance | 4 |
| 2. Administration Data | 5 |
| 2.1 Testing Laboratory | 5 |
| 2.2 Applicant | 5 |
| 2.3 Manufacturer | 5 |
| 2.4 Application Details | 5 |
| 3. General Information | 6 |
| 3.1 Description of Device Under Test (DUT) | 6 |
| 3.2 Product Photos | 7 |
| 3.3 Applied Standards | 7 |
| 3.4 Device Category and SAR Limits | 7 |
| 3.5 Test Conditions | 7 |
| 4. Specific Absorption Rate (SAR) | 8 |
| 4.1 Introduction | 8 |
| 4.2 SAR Definition | 8 |
| 5. SAR Measurement System | 9 |
| 5.1 E-Field Probe | 10 |
| 5.2 Data Acquisition Electronics (DAE) | 10 |
| 5.3 Robot | 11 |
| 5.4 Measurement Server | 11 |
| 5.5 Phantom | 12 |
| 5.6 Device Holder | 13 |
| 5.7 Data Storage and Evaluation | 14 |
| 5.8 Test Equipment List | 16 |
| 6. Tissue Simulating Liquids | 17 |
| 7. Uncertainty Assessment | 19 |
| 8. SAR Measurement Evaluation | 21 |
| 8.1 Purpose of System Performance check | 21 |
| 8.2 System Setup | 21 |
| 8.3 Validation Results | 22 |
| 9. DUT Testing Position | 23 |
| 10. Measurement Procedures | 26 |
| 10.1 Spatial Peak SAR Evaluation | 26 |
| 10.2 Area & Zoom Scan Procedures | 27 |
| 10.3 Volume Scan Procedures | 27 |
| 10.4 SAR Averaged Methods | 27 |
| 10.5 Power Drift Monitoring | 27 |
| 11. SAR Test Configurations | 28 |
| 12. SAR Test Results | 30 |
| 12.1 Conducted Power (Unit: dBm) | 30 |
| 12.2 Test Records for Head SAR Test | 31 |
| 12.3 Test Records for Body-worn SAR Test | 31 |
| 13. References | 32 |
| Appendix A. Plots of System Performance Check | |
| Appendix B. Plots of SAR Measurement | |
| Appendix C. DASY Calibration Certificate | |
| Appendix D. Product Photos | |
| Appendix E. Test Setup Photos | |



1. Statement of Compliance

The maximum results of Specific Absorption Rate (SAR) found during testing for **Brightstar Corporation Mobile phone Avvio AVVIO 399S** are as follows.

<Standalone SAR>

| Band | Position | SAR _{1g} (W/kg) |
|---------|------------------------|-----------------------------|
| GSM850 | Head | 1.11 |
| | Body-worn (1.5 cm Gap) | 0.861 |
| GSM1900 | Head | 0.613 |
| | Body-worn (1.5 cm Gap) | 0.496 |

This device is in compliance with Specific Absorption Rate (SAR) for general population/uncontrolled exposure limits (1.6 W/kg) specified in FCC 47 CFR part 2 (2.1093) and ANSI/IEEE C95.1-1991, and had been tested in accordance with the measurement methods and procedures specified in IEEE 1528-2003 and FCC OET Bulletin 65 Supplement C (Edition 01-01).



2. Administration Data

2.1 Testing Laboratory

| | |
|--------------------|------------------------------------------------------------------------------------------------------------------|
| Test Site | SPORTON INTERNATIONAL (KUNSHAN) INC. |
| Test Site Location | No. 3-2, PingXiang Road, Kunshan, Jiangsu Province, P.R.C. TEL: +86-0512-5790-0158 FAX: +86-0512-5790-0958 |

2.2 Applicant

| | |
|--------------|---------------------------------------------------|
| Company Name | Brightstar Corporation |
| Address | 9725 NW 117th Ave., Miami, Florida, United States |

2.3 Manufacturer

| | |
|--------------|-----------------------------------------------------------------------------------------------------------------------|
| Company Name | Lenovo Mobile Internet and Digital Home |
| Address | East 5/F, Lenovo Research & Development Centre, Gaoxinnanyi Road, Hi-Tech Industrial Park, Shenzhen, Guangdong, China |

2.4 Application Details

| | |
|--------------------------------|---------------|
| Date of Receipt of Application | Feb. 17, 2012 |
| Date of Start during the Test | Mar. 08, 2012 |
| Date of End during the Test | Mar. 09, 2012 |



3. General Information

3.1 Description of Device Under Test (DUT)

| Product Feature & Specification | |
|-------------------------------------------------------------------------------------------------------------------------------------------------------------|--------------------------------------------------------------------------------------------------------------------------------------------------------------------|
| DUT Type | Mobile phone |
| Brand Name | Avvio |
| Model Name | AVVIO 399S |
| IMEI Code | 358328042206337 |
| FCC ID | WVBA399S |
| Tx Frequency | GSM850: 824 MHz ~ 849 MHz GSM1900: 1850 MHz ~ 1910 MHz Bluetooth: 2402 MHz ~ 2480 MHz |
| Rx Frequency | GSM850: 869 MHz ~ 894 MHz GSM1900: 1930 MHz ~ 1990 MHz Bluetooth: 2402 MHz ~ 2480 MHz |
| Maximum Output Power to Antenna | GSM850 : 31.88 dBm GSM1900 : 28.89 dBm Bluetooth: 4.97 dBm |
| Antenna Type | WWAN : Fixed Internal Antenna Bluetooth : Dipole Antenna |
| HW Version | PCB version 1.2 |
| SW Version | T22A_LX_S12_BRAZIL_EP_V0_0_21(20120220). |
| Type of Modulation | GSM / GPRS : GMSK Bluetooth (1Mbps) : GFSK Bluetooth EDR (2Mbps) : $\pi/4$ -DQPSK Bluetooth EDR (3Mbps) : 8-DPSK |
| Dual Transfer Mode (DTM) Category | Class B – DUT cannot support Packet Switched and Circuit Switched Network simultaneously but can automatically switch between Packet and Circuit Switched Network. |
| DUT Stage | Production Unit |
| Remark: The above DUT's information was declared by manufacturer. Please refer to the specifications or user's manual for more detailed description. | |



3.2 Product Photos

Please refer to Appendix D.

3.3 Applied Standards

The Specific Absorption Rate (SAR) testing specification, method and procedure for this device is in accordance with the following standards:

- FCC 47 CFR Part 2 (2.1093)
- IEEE C95.1-1991
- IEEE 1528-2003
- FCC OET Bulletin 65 Supplement C (Edition 01-01)
- FCC KDB 447498 D01 v04
- FCC KDB 648474 D01 v01r05
- FCC KDB 941225 D03 v01

3.4 Device Category and SAR Limits

This device belongs to portable device category because its radiating structure is allowed to be used within 20 centimeters of the body of the user. Limit for General Population/Uncontrolled exposure should be applied for this device, it is 1.6 W/kg as averaged over any 1 gram of tissue.

3.5 Test Conditions

3.5.1 Ambient Condition

| | |
|---------------------|-------------|
| Ambient Temperature | 20 to 24 °C |
| Humidity | < 60 % |

3.5.2 Test Configuration

The device was controlled by using a base station emulator. Communication between the device and the emulator was established by air link. The distance between the DUT and the antenna of the emulator is larger than 50 cm and the output power radiated from the emulator antenna is at least 30 dB smaller than the output power of DUT. The DUT was set from the emulator to radiate maximum output power during all tests.

4. Specific Absorption Rate (SAR)

4.1 Introduction

SAR is related to the rate at which energy is absorbed per unit mass in an object exposed to a radio field. The SAR distribution in a biological body is complicated and is usually carried out by experimental techniques or numerical modeling. The standard recommends limits for two tiers of groups, occupational/controlled and general population/uncontrolled, based on a person's awareness and ability to exercise control over his or her exposure. In general, occupational/controlled exposure limits are higher than the limits for general population/uncontrolled.

4.2 SAR Definition

The SAR definition is the time derivative (rate) of the incremental energy (dW) absorbed by (dissipated in) an incremental mass (dm) contained in a volume element (dv) of a given density (ρ). The equation description is as below:

$$\text{SAR} = \frac{d}{dt} \left(\frac{dW}{dm} \right) = \frac{d}{dt} \left(\frac{dW}{\rho dv} \right)$$

SAR is expressed in units of Watts per kilogram (W/kg)

SAR measurement can be either related to the temperature elevation in tissue by

$$\text{SAR} = C \left(\frac{\delta T}{\delta t} \right)$$

Where: C is the specific heat capacity, δT is the temperature rise and δt is the exposure duration, or related to the electrical field in the tissue by

$$\text{SAR} = \frac{\sigma |E|^2}{\rho}$$

Where: σ is the conductivity of the tissue, ρ is the mass density of the tissue and E is the RMS electrical field strength.

However for evaluating SAR of low power transmitter, electrical field measurement is typically applied.

5. SAR Measurement System

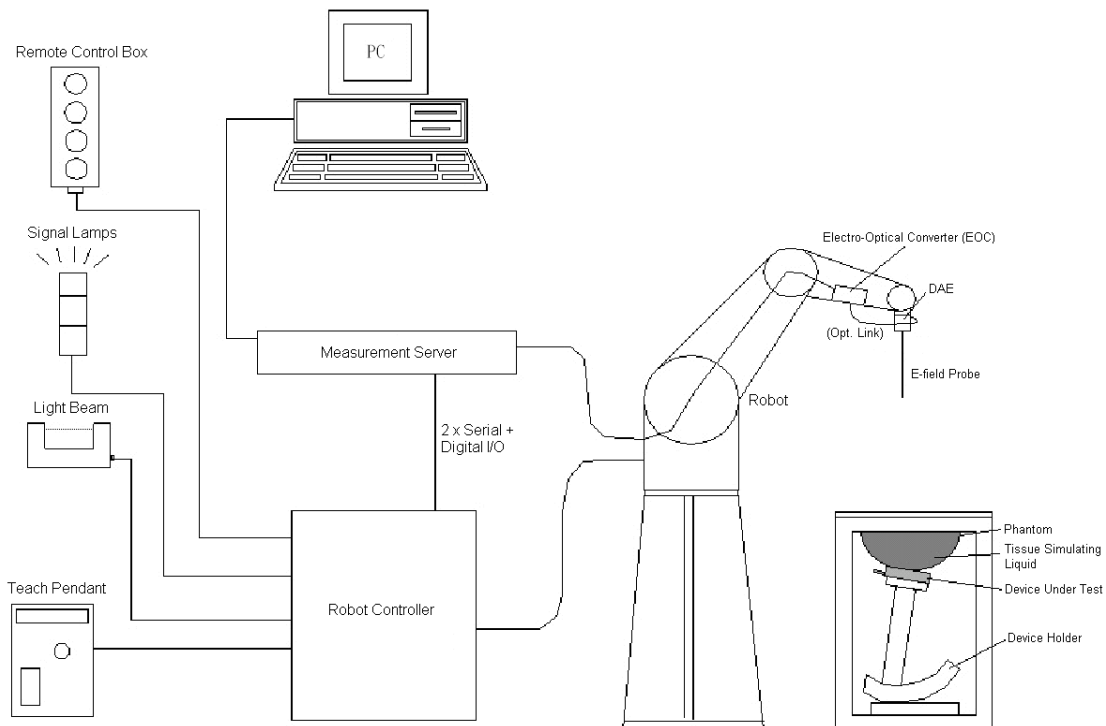

Fig 5.1 SPEAG DASY4 or DASY5 System Configurations

The DASY4 or DASY5 system for performance compliance tests is illustrated above graphically. This system consists of the following items:

- A standard high precision 6-axis robot with controller, a teach pendant and software
- A data acquisition electronic (DAE) attached to the robot arm extension
- A dosimetric probe equipped with an optical surface detector system
- The electro-optical converter (ECO) performs the conversion between optical and electrical signals
- A measurement server performs the time critical tasks such as signal filtering, control of the robot operation and fast movement interrupts.
- A probe alignment unit which improves the accuracy of the probe positioning
- A computer operating Windows XP
- DASY4 or DASY5 software
- Remote control with teach pendant and additional circuitry for robot safety such as warning lamps, etc.
- The SAM twin phantom
- A device holder
- Tissue simulating liquid
- Dipole for evaluating the proper functioning of the system

Some of the components are described in details in the following sub-sections.

5.1 E-Field Probe

The SAR measurement is conducted with the dosimetric probe (manufactured by SPEAG).The probe is specially designed and calibrated for use in liquid with high permittivity. The dosimetric probe has special calibration in liquid at different frequency. This probe has a built in optical surface detection system to prevent from collision with phantom.

5.1.1 E-Field Probe Specification

<EX3DV4 Probe>

| | |
|----------------------|-------------------------------------------------------------------------------------------------------------------------------------------------------------|
| Construction | Symmetrical design with triangular core Built-in shielding against static charges PEEK enclosure material (resistant to organic solvents, e.g., DGBE) |
| Frequency | 10 MHz to 6 GHz; Linearity: ± 0.2 dB |
| Directivity | ± 0.3 dB in HSL (rotation around probe axis) ± 0.5 dB in tissue material (rotation normal to probe axis) |
| Dynamic Range | 10 μ W/g to 100 mW/g; Linearity: ± 0.2 dB (noise: typically < 1 μ W/g) |
| Dimensions | Overall length: 330 mm (Tip: 20 mm) Tip diameter: 2.5 mm (Body: 12 mm) Typical distance from probe tip to dipole centers: 1 mm |

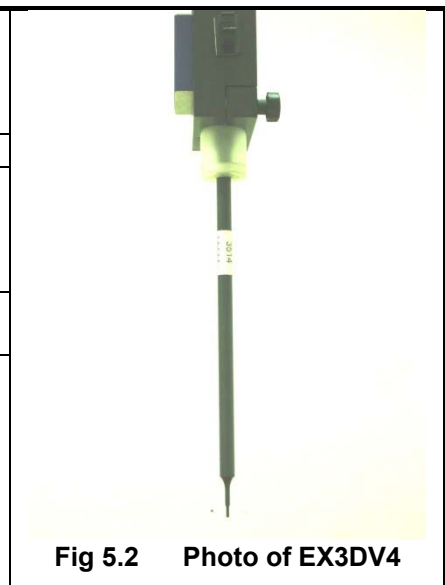

Fig 5.2 Photo of EX3DV4

5.1.2 E-Field Probe Calibration

Each probe needs to be calibrated according to a dosimetric assessment procedure with accuracy better than $\pm 10\%$. The spherical isotropy shall be evaluated and within ± 0.25 dB. The sensitivity parameters (NormX, NormY, and NormZ), the diode compression parameter (DCP) and the conversion factor (ConvF) of the probe are tested. The calibration data can be referred to appendix C of this report.

5.2 Data Acquisition Electronics (DAE)

The data acquisition electronics (DAE) consists of a highly sensitive electrometer-grade preamplifier with auto-zeroing, a channel and gain-switching multiplexer, a fast 16 bit AD-converter and a command decoder and control logic unit. Transmission to the measurement server is accomplished through an optical downlink for data and status information as well as an optical uplink for commands and the clock.

The input impedance of the DAE is 200 MOhm; the inputs are symmetrical and floating. Common mode rejection is above 80 dB.



Fig 5.3 Photo of DAE

5.3 Robot

The SPEAG DASY system uses the high precision robots (DASY5: TX90XL) type from Stäubli SA (France). For the 6-axis controller system, the robot controller version (DASY5: CS8c) from Stäubli is used. The Stäubli robot series have many features that are important for our application:

- High precision (repeatability ± 0.035 mm)
- High reliability (industrial design)
- Jerk-free straight movements
- Low ELF interference (the closed metallic construction shields against motor control fields)



Fig 5.4 Photo of DASY5

5.4 Measurement Server

The measurement server is based on a PC/104 CPU board with CPU (DASY5: 400 MHz, Intel Celeron), chipdisk (DASY5: 128 MB), RAM (DASY5: 128 MB). The necessary circuits for communication with the DAE electronic box, as well as the 16 bit AD converter system for optical detection and digital I/O interface are contained on the DASY I/O board, which is directly connected to the PC/104 bus of the CPU board.

The measurement server performs all the real-time data evaluation for field measurements and surface detection, controls robot movements and handles safety operations.



Fig 5.5 Photo of Server for DASY5

5.5 Phantom

<SAM Twin Phantom>

| | |
|--------------------------|------------------------------------------------------------|
| Shell Thickness | 2 ± 0.2 mm; Center ear point: 6 ± 0.2 mm |
| Filling Volume | Approx. 25 liters |
| Dimensions | Length: 1000 mm; Width: 500 mm; Height: adjustable feet |
| Measurement Areas | Left Hand, Right Hand, Flat Phantom |

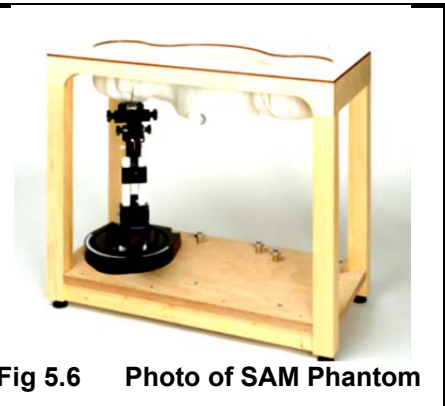

Fig 5.6 Photo of SAM Phantom

The bottom plate contains three pair of bolts for locking the device holder. The device holder positions are adjusted to the standard measurement positions in the three sections. A white cover is provided to tap the phantom during off-periods to prevent water evaporation and changes in the liquid parameters. On the phantom top, three reference markers are provided to identify the phantom position with respect to the robot.

<ELI4 Phantom>

| | |
|------------------------|--------------------------------------------------|
| Shell Thickness | 2 ± 0.2 mm (sagging: <1%) |
| Filling Volume | Approx. 30 liters |
| Dimensions | Major ellipse axis: 600 mm Minor axis: 400 mm |

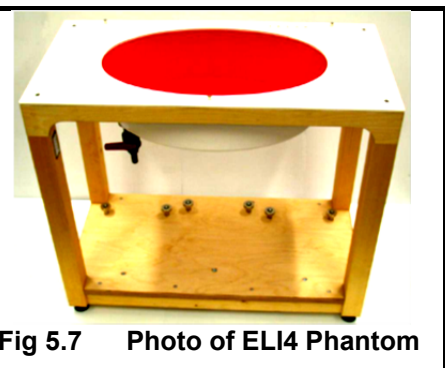

Fig 5.7 Photo of ELI4 Phantom

The ELI4 phantom is intended for compliance testing of handheld and body-mounted wireless devices in the frequency range of 30 MHz to 6 GHz. ELI4 is fully compatible with standard and all known tissue simulating liquids.

5.6 Device Holder

<Device Holder for SAM Twin Phantom>

The SAR in the phantom is approximately inversely proportional to the square of the distance between the source and the liquid surface. For a source at 5 mm distance, a positioning uncertainty of ± 0.5 mm would produce a SAR uncertainty of ± 20 %. Accurate device positioning is therefore crucial for accurate and repeatable measurements. The positions in which the devices must be measured are defined by the standards.

The DASY device holder is designed to cope with different positions given in the standard. It has two scales for the device rotation (with respect to the body axis) and the device inclination (with respect to the line between the ear reference points). The rotation center for both scales is the ear reference point (EPR). Thus the device needs no repositioning when changing the angles.

The DASY device holder is constructed of low-loss POM material having the following dielectric parameters: relative permittivity $\epsilon = 3$ and loss tangent $\delta = 0.02$. The amount of dielectric material has been reduced in the closest vicinity of the device, since measurements have suggested that the influence of the clamp on the test results could thus be lowered.



Fig 5.8 Device Holder

5.7 Data Storage and Evaluation

5.7.1 Data Storage

The DASY software stores the assessed data from the data acquisition electronics as raw data (in microvolt readings from the probe sensors), together with all the necessary software parameters for the data evaluation (probe calibration data, liquid parameters and device frequency and modulation data) in measurement files. The post-processing software evaluates the desired unit and format for output each time the data is visualized or exported. This allows verification of the complete software setup even after the measurement and allows correction of erroneous parameter settings. For example, if a measurement has been performed with an incorrect crest factor parameter in the device setup, the parameter can be corrected afterwards and the data can be reevaluated.

The measured data can be visualized or exported in different units or formats, depending on the selected probe type (e.g., [V/m], [A/m], [mW/g]). Some of these units are not available in certain situations or give meaningless results, e.g., a SAR-output in a non-lose media, will always be zero. Raw data can also be exported to perform the evaluation with other software packages.

5.7.2 Data Evaluation

The DASY post-processing software (SEMCAD) automatically executes the following procedures to calculate the field units from the microvolt readings at the probe connector. The parameters used in the evaluation are stored in the configuration modules of the software :

| | | |
|----------------------------|---------------------------|-------------------------------------------------------------------------|
| Probe parameters : | - Sensitivity | Norm _i , a _{i0} , a _{i1} , a _{i2} |
| | - Conversion factor | ConvF _i |
| | - Diode compression point | dcp _i |
| Device parameters : | - Frequency | f |
| | - Crest factor | cf |
| Media parameters : | - Conductivity | σ |
| | - Density | ρ |

These parameters must be set correctly in the software. They can be found in the component documents or they can be imported into the software from the configuration files issued for the DASY components. In the direct measuring mode of the multi-meter option, the parameters of the actual system setup are used. In the scan visualization and export modes, the parameters stored in the corresponding document files are used.

The first step of the evaluation is a linearization of the filtered input signal to account for the compression characteristics of the detector diode. The compensation depends on the input signal, the diode type and the DC-transmission factor from the diode to the evaluation electronics. If the exciting field is pulsed, the crest factor of the signal must be known to correctly compensate for peak power.

The formula for each channel can be given as :

$$V_i = U_i + U_i^2 \cdot \frac{cf}{dcp_i}$$

with V_i = compensated signal of channel i, (i = x, y, z)
 U_i = input signal of channel i, (i = x, y, z)
 cf = crest factor of exciting field (DASY parameter)
 dcp_i = diode compression point (DASY parameter)

From the compensated input signals, the primary field data for each channel can be evaluated :

$$\text{E-field Probes : } E_i = \sqrt{\frac{V_i}{\text{Norm}_i \cdot \text{ConvF}}}$$

$$\text{H-field Probes : } H_i = \sqrt{V_i} \cdot \frac{a_{i0} + a_{i1}f + a_{i2}f^2}{f}$$

with V_i = compensated signal of channel i, (i = x, y, z)
 Norm_i = sensor sensitivity of channel i, (i = x, y, z), $\mu\text{V}/(\text{V/m})^2$ for E-field Probes
 ConvF = sensitivity enhancement in solution
 a_{ij} = sensor sensitivity factors for H-field probes
 f = carrier frequency [GHz]
 E_i = electric field strength of channel i in V/m
 H_i = magnetic field strength of channel i in A/m

The RSS value of the field components gives the total field strength (Hermitian magnitude) :

$$E_{\text{tot}} = \sqrt{E_x^2 + E_y^2 + E_z^2}$$

The primary field data are used to calculate the derived field units.

$$\text{SAR} = E_{\text{tot}}^2 \cdot \frac{\sigma}{\rho \cdot 1000}$$

with SAR = local specific absorption rate in mW/g
 E_{tot} = total field strength in V/m
 σ = conductivity in [mho/m] or [Siemens/m]
 ρ = equivalent tissue density in g/cm^3

Note that the density is set to 1, to account for actual head tissue density rather than the density of the tissue simulating liquid.

5.8 Test Equipment List

| Manufacturer | Name of Equipment | Type/Model | Serial Number | Calibration | |
|--------------|---------------------------------|---------------|---------------|---------------|---------------|
| | | | | Last Cal. | Due Date |
| SPEAG | Dosimetric E-Field Probe | EX3DV4 | 3819 | Nov. 16, 2011 | Nov. 15, 2012 |
| SPEAG | Data Acquisition Electronics | DAE4 | 1303 | Nov. 10, 2011 | Nov. 09, 2012 |
| SPEAG | 835MHz System Validation Kit | D835V2 | 4d091 | Nov. 18, 2011 | Nov. 17, 2012 |
| SPEAG | 1900MHz System Validation Kit | D1900V2 | 5d118 | Nov. 21, 2011 | Nov. 20, 2012 |
| Agilent | ENA Series Network Analyzer | E5071C | MY46111157 | Apr. 07, 2011 | Apr. 06, 2012 |
| Agilent | Wireless Communication Test Set | E5515C | MY50264165 | Mar. 30, 2011 | Mar. 29, 2012 |
| Agilent | Dielectric Probe Kit | 85070E | MY44300475 | NCR | NCR |
| Agilent | Base Station | E5515C | GB47050646 | Aug. 18, 2011 | Aug. 17, 2012 |
| SPEAG | SAM Twin Phantom | QD 000 P40 CD | TP-1670 | NCR | NCR |
| SPEAG | SAM Twin Phantom | QD 000 P40 CD | TP-1671 | NCR | NCR |
| SPEAG | ELI5 Phantom | QD OVA 002 AA | TP-1149 | NCR | NCR |
| AR | Amplifier | 551G4 | 333096 | NCR | NCR |
| R&S | Spectrum Analyzer | FSP30 | 101400 | Jun. 02, 2011 | Jun. 01, 2012 |
| R&S | Signal Generator | SMR40 | 100455 | Dec. 30, 2011 | Dec. 29, 2012 |

Table 5.1 Test Equipment List

Note:

1. The calibration certificate of DASY can be referred to appendix C of this report.
2. Referring to KDB450824 D02, the dipole calibration interval can be extended to 3 years with justification. The dipoles are also not physically damaged, or repaired during the interval.

6. Tissue Simulating Liquids

For the measurement of the field distribution inside the SAM phantom with DASY, the phantom must be filled with around 25 liters of homogeneous body tissue simulating liquid. For head SAR testing, the liquid height from the ear reference point (ERP) of the phantom to the liquid top surface is larger than 15 cm, which is shown in Fig. 6.1. For body SAR testing, the liquid height from the center of the flat phantom to the liquid top surface is larger than 15 cm, which is shown in Fig. 6.2.

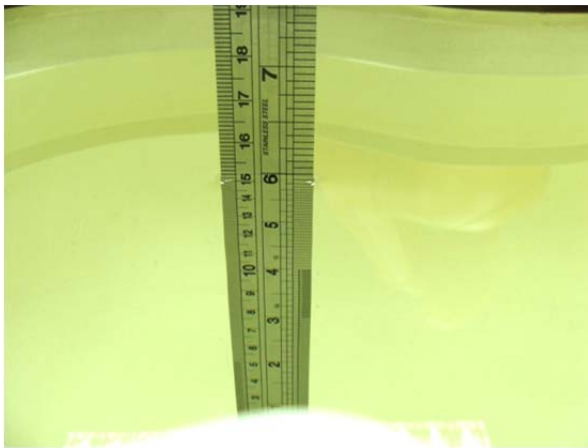

Fig 6.1 Photo of Liquid Height for Head SAR



Fig 6.2 Photo of Liquid Height for Body SAR

The following table gives the recipes for tissue simulating liquid.

| Frequency (MHz) | Water (%) | Sugar (%) | Cellulose (%) | Salt (%) | Preventol (%) | DGBE (%) | Conductivity (σ) | Permittivity (ϵ_r) |
|------------------|-----------|-----------|---------------|----------|---------------|----------|---------------------------|-------------------------------|
| For Head | | | | | | | | |
| 835 | 40.3 | 57.9 | 0.2 | 1.4 | 0.2 | 0 | 0.90 | 41.5 |
| 1800, 1900, 2000 | 55.2 | 0 | 0 | 0.3 | 0 | 44.5 | 1.40 | 40.0 |
| For Body | | | | | | | | |
| 835 | 50.8 | 48.2 | 0 | 0.9 | 0.1 | 0 | 0.97 | 55.2 |
| 1800, 1900, 2000 | 70.2 | 0 | 0 | 0.4 | 0 | 29.4 | 1.52 | 53.3 |

Table 6.1 Recipes of Tissue Simulating Liquid



The dielectric parameters of the liquids were verified prior to the SAR evaluation using an Agilent 85070D Dielectric Probe Kit and an Agilent Network Analyzer.

The following table shows the measuring results for simulating liquid.

| Freq. | Liquid Type | Temp. (°C) | Conductivity (σ) | Permittivity (ε _r) | Conductivity Target (σ) | Permittivity Target (ε _r) | Delta (σ) (%) | Delta (ε _r) (%) | Limit (%) | Date |
|-------|-------------|------------|------------------|--------------------------------|-------------------------|---------------------------------------|---------------|-----------------------------|-----------|---------------|
| 835 | Head | 21.4 | 0.915 | 41.529 | 0.9 | 41.5 | 1.67 | 0.07 | ±5 | Mar. 08, 2012 |
| 835 | Body | 21.7 | 0.978 | 54.403 | 0.97 | 55.2 | 0.82 | -1.44 | ±5 | Mar. 08, 2012 |
| 1900 | Head | 21.2 | 1.445 | 39.686 | 1.4 | 40.0 | 3.21 | -0.79 | ±5 | Mar. 09, 2012 |
| 1900 | Body | 21.5 | 1.531 | 54.671 | 1.52 | 53.3 | 0.72 | 2.57 | ±5 | Mar. 08, 2012 |

Table 6.2 Measuring Results for Simulating Liquid

| CH | Frequency (MHz) | Liquid Type | Conductivity (σ) | Permittivity (ε _r) | Conductivity Target (σ) | Permittivity Target (ε _r) | Conductivity delta (%) (σ) | Permittivity delta (%) (ε _r) | Date |
|-----|-----------------|-------------|------------------|--------------------------------|-------------------------|---------------------------------------|----------------------------|------------------------------------------|---------------|
| 128 | 824.2 | Head | 0.906 | 41.628 | 0.90 | 41.6 | 0.67 | 0.07 | Mar. 08, 2012 |
| 189 | 836.4 | Head | 0.917 | 41.516 | 0.90 | 41.5 | 1.89 | 0.04 | Mar. 08, 2012 |
| 251 | 848.8 | Head | 0.927 | 41.382 | 0.91 | 41.5 | 1.87 | -0.28 | Mar. 08, 2012 |
| 128 | 824.2 | Body | 0.967 | 54.482 | 0.97 | 55.2 | -0.31 | -1.30 | Mar. 08, 2012 |
| 189 | 836.4 | Body | 0.979 | 54.392 | 0.97 | 55.2 | 0.93 | -1.46 | Mar. 08, 2012 |
| 251 | 848.8 | Body | 0.99 | 54.278 | 0.99 | 55.2 | 0.00 | -1.67 | Mar. 08, 2012 |
| 810 | 1909.8 | Head | 1.455 | 39.645 | 1.39 | 40.0 | 4.68 | -0.89 | Mar. 09, 2012 |
| 512 | 1850.2 | Body | 1.47 | 54.773 | 1.50 | 53.4 | -2.00 | 2.57 | Mar. 08, 2012 |

Table 6.3 Low/mid/High channel for liquid validation

7. Uncertainty Assessment

The component of uncertainty may generally be categorized according to the methods used to evaluate them. The evaluation of uncertainty by the statistical analysis of a series of observations is termed a Type A evaluation of uncertainty. The evaluation of uncertainty by means other than the statistical analysis of a series of observation is termed a Type B evaluation of uncertainty. Each component of uncertainty, however evaluated, is represented by an estimated standard deviation, termed standard uncertainty, which is determined by the positive square root of the estimated variance.

A Type A evaluation of standard uncertainty may be based on any valid statistical method for treating data. This includes calculating the standard deviation of the mean of a series of independent observations; using the method of least squares to fit a curve to the data in order to estimate the parameter of the curve and their standard deviations; or carrying out an analysis of variance in order to identify and quantify random effects in certain kinds of measurement.

A type B evaluation of standard uncertainty is typically based on scientific judgment using all of the relevant information available. These may include previous measurement data, experience and knowledge of the behavior and properties of relevant materials and instruments, manufacture’s specification, data provided in calibration reports and uncertainties assigned to reference data taken from handbooks. Broadly speaking, the uncertainty is either obtained from an outdoor source or obtained from an assumed distribution, such as the normal distribution, rectangular or triangular distributions indicated in Table 7.1

| Uncertainty Distributions | Normal | Rectangular | Triangular | U-Shape |
|------------------------------------|--------------------|--------------------|-------------------|----------------|
| Multi-plying Factor ^(a) | 1/k ^(b) | 1/√3 | 1/√6 | 1/√2 |

- (a) standard uncertainty is determined as the product of the multiplying factor and the estimated range of variations in the measured quantity
- (b) κ is the coverage factor

Table 7.1 Standard Uncertainty for Assumed Distribution

The combined standard uncertainty of the measurement result represents the estimated standard deviation of the result. It is obtained by combining the individual standard uncertainties of both Type A and Type B evaluation using the usual “root-sum-squares” (RSS) methods of combining standard deviations by taking the positive square root of the estimated variances.

Expanded uncertainty is a measure of uncertainty that defines an interval about the measurement result within which the measured value is confidently believed to lie. It is obtained by multiplying the combined standard uncertainty by a coverage factor. Typically, the coverage factor ranges from 2 to 3. Using a coverage factor allows the true value of a measured quantity to be specified with a defined probability within the specified uncertainty range. For purpose of this document, a coverage factor two is used, which corresponds to confidence interval of about 95 %. The DASY uncertainty Budget is showed in Table 7.2.



| Error Description | Uncertainty Value (±%) | Probability Distribution | Divisor | Ci (1g) | Standard Uncertainty (1g) |
|--------------------------------------|------------------------|--------------------------|---------|---------|---------------------------|
| Measurement System | | | | | |
| Probe Calibration | 6.0 | Normal | 1 | 1 | ± 6.0 % |
| Axial Isotropy | 4.7 | Rectangular | √3 | 0.7 | ± 1.9 % |
| Hemispherical Isotropy | 9.6 | Rectangular | √3 | 0.7 | ± 3.9 % |
| Boundary Effects | 1.0 | Rectangular | √3 | 1 | ± 0.6 % |
| Linearity | 4.7 | Rectangular | √3 | 1 | ± 2.7 % |
| System Detection Limits | 1.0 | Rectangular | √3 | 1 | ± 0.6 % |
| Readout Electronics | 0.3 | Normal | 1 | 1 | ± 0.3 % |
| Response Time | 0.8 | Rectangular | √3 | 1 | ± 0.5 % |
| Integration Time | 2.6 | Rectangular | √3 | 1 | ± 1.5 % |
| RF Ambient Noise | 3.0 | Rectangular | √3 | 1 | ± 1.7 % |
| RF Ambient Reflections | 3.0 | Rectangular | √3 | 1 | ± 1.7 % |
| Probe Positioner | 0.4 | Rectangular | √3 | 1 | ± 0.2 % |
| Probe Positioning | 2.9 | Rectangular | √3 | 1 | ± 1.7 % |
| Max. SAR Eval. | 1.0 | Rectangular | √3 | 1 | ± 0.6 % |
| Test Sample Related | | | | | |
| Device Positioning | 2.9 | Normal | 1 | 1 | ± 2.9 % |
| Device Holder | 3.6 | Normal | 1 | 1 | ± 3.6 % |
| Power Drift | 5.0 | Rectangular | √3 | 1 | ± 2.9 % |
| Phantom and Setup | | | | | |
| Phantom Uncertainty | 4.0 | Rectangular | √3 | 1 | ± 2.3 % |
| Liquid Conductivity (Target) | 5.0 | Rectangular | √3 | 0.64 | ± 1.8 % |
| Liquid Conductivity (Meas.) | 2.5 | Normal | 1 | 0.64 | ± 1.6 % |
| Liquid Permittivity (Target) | 5.0 | Rectangular | √3 | 0.6 | ± 1.7 % |
| Liquid Permittivity (Meas.) | 2.5 | Normal | 1 | 0.6 | ± 1.5 % |
| Combined Standard Uncertainty | | | | | ± 10.99 % |
| Coverage Factor for 95 % | | | | | K = 2 |
| Expanded Uncertainty | | | | | ± 21.97 % |

Table 7.2 Uncertainty Budget of DASYS for frequency range 300 MHz to 3 GHz

8. SAR Measurement Evaluation

Each DASY system is equipped with one or more system validation kits. These units, together with the predefined measurement procedures within the DASY software, enable the user to conduct the system performance check and system validation. System validation kit includes a dipole, tripod holder to fix it underneath the flat phantom and a corresponding distance holder.

8.1 Purpose of System Performance check

The system performance check verifies that the system operates within its specifications. System and operator errors can be detected and corrected. It is recommended that the system performance check be performed prior to any usage of the system in order to guarantee reproducible results. The system performance check uses normal SAR measurements in a simplified setup with a well characterized source. This setup was selected to give a high sensitivity to all parameters that might fail or vary over time. The system check does not intend to replace the calibration of the components, but indicates situations where the system uncertainty is exceeded due to drift or failure.

8.2 System Setup

In the simplified setup for system evaluation, the DUT is replaced by a calibrated dipole and the power source is replaced by a continuous wave that comes from a signal generator. The calibrated dipole must be placed beneath the flat phantom section of the SAM twin phantom with the correct distance holder. The distance holder should touch the phantom surface with a light pressure at the reference marking and be oriented parallel to the long side of the phantom. The equipment setup is shown below:

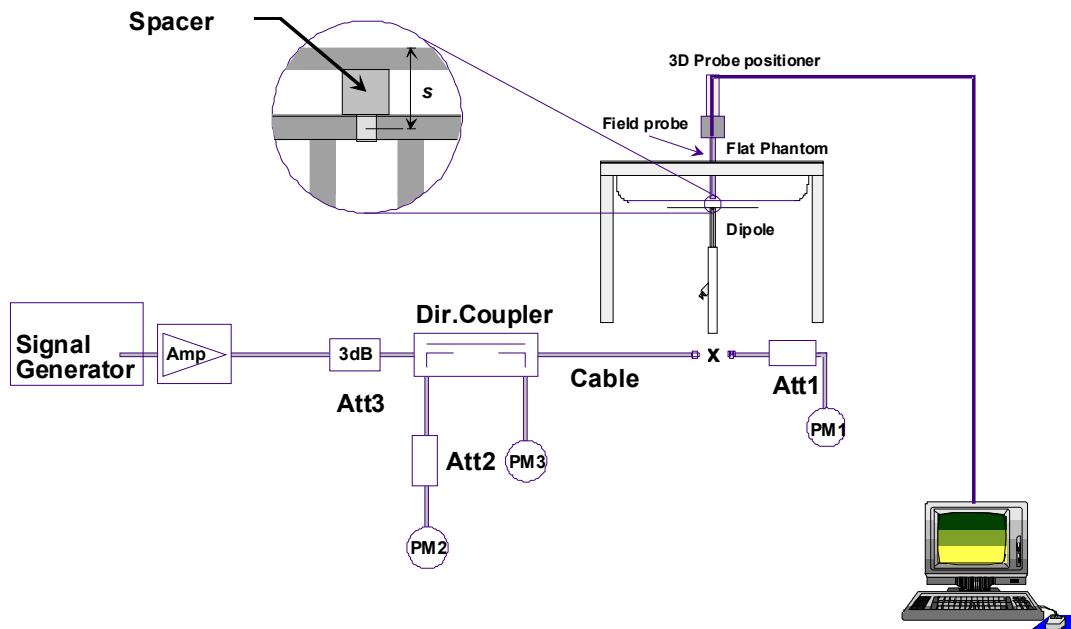

Fig 8.1 System Setup for System Evaluation

1. Signal Generator
2. Amplifier
3. Directional Coupler
4. Power Meter
5. Calibrated Dipole

The output power on dipole port must be calibrated to 24 dBm (250 mW) before dipole is connected.



Fig 8.2 Photo of Dipole Setup

8.3 Validation Results

Comparing to the original SAR value provided by SPEAG, the validation data should be within its specification of 10 %. Table 8.1 shows the target SAR and measured SAR after normalized to 1W input power. The table below indicates the system performance check can meet the variation criterion and the plots can be referred to Appendix A of this report.

| Measurement Date | Frequency (MHz) | Liquid Type | Targeted SAR _{1g} (W/kg) | Measured SAR _{1g} (W/kg) | Normalized SAR _{1g} (W/kg) | Deviation (%) |
|------------------|-----------------|-------------|-----------------------------------|-----------------------------------|-------------------------------------|---------------|
| Mar. 08, 2012 | 835 | Head | 9.4 | 2.37 | 9.48 | 0.85 |
| Mar. 08, 2012 | 835 | Body | 9.42 | 2.51 | 10.04 | 6.58 |
| Mar. 09, 2012 | 1900 | Head | 40.3 | 10.6 | 42.40 | 5.21 |
| Mar. 08, 2012 | 1900 | Body | 41.8 | 10.3 | 41.20 | -1.44 |

Table 8.1 Target and Measurement SAR after Normalized

9. DUT Testing Position

This DUT was tested in six different positions. They are right cheek, right tilted, left cheek, left tilted, face of the DUT with phantom 1.5 cm gap, bottom of the DUT with phantom 1.5 cm gap, as illustrated below:

1. Define two imaginary lines on the handset

- (a) The vertical centerline passes through two points on the front side of the handset - the midpoint of the width w_t of the handset at the level of the acoustic output, and the midpoint of the width w_b of the bottom of the handset.
- (b) The horizontal line is perpendicular to the vertical centerline and passes through the center of the acoustic output. The horizontal line is also tangential to the face of the handset at point A.
- (c) The two lines intersect at point A. Note that for many handsets, point A coincides with the center of the acoustic output; however, the acoustic output may be located elsewhere on the horizontal line. Also note that the vertical centerline is not necessarily parallel to the front face of the handset, especially for clamshell handsets, handsets with flip covers, and other irregularly shaped handsets.

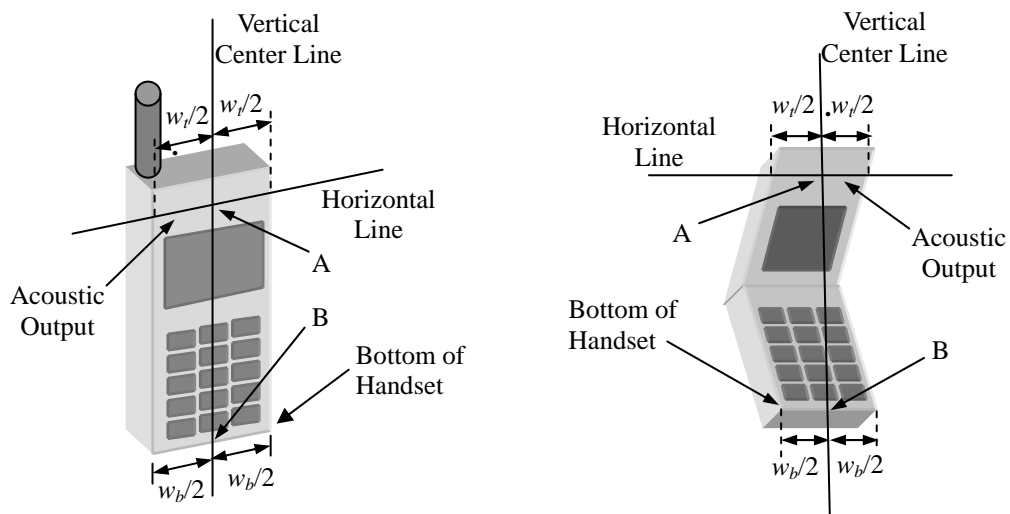

Fig 9.1 Illustration for Handset Vertical and Horizontal Reference Lines

2. Cheek Position

- (a) To position the device with the vertical center line of the body of the device and the horizontal line crossing the center piece in a plane parallel to the sagittal plane of the phantom. While maintaining the device in this plane, align the vertical center line with the reference plane containing the three ear and mouth reference point (M: Mouth, RE: Right Ear, and LE: Left Ear) and align the center of the ear piece with the line RE-LE.
- (b) To move the device towards the phantom with the ear piece aligned with the line LE-RE until the phone touched the ear. While maintaining the device in the reference plane and maintaining the phone contact with the ear, move the bottom of the phone until any point on the front side is in contact with the cheek of the phantom or until contact with the ear is lost (see Fig. 9.2).

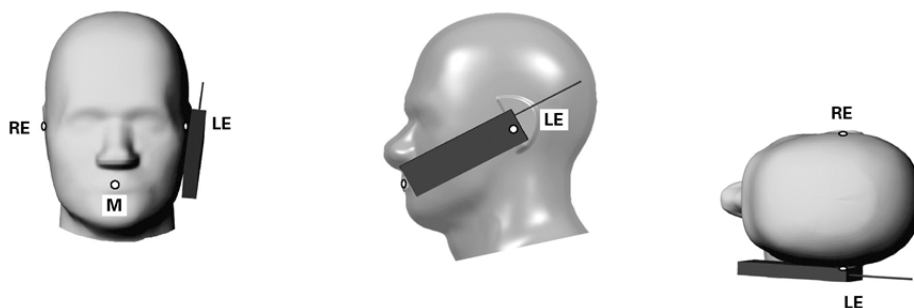

Fig 9.2 Illustration for Cheek Position

3. Tilted Position

- (a) To position the device in the “cheek” position described above.
- (b) While maintaining the device the reference plane described above and pivoting against the ear, moves it outward away from the mouth by an angle of 15 degrees or until contact with the ear is lost (see Fig. 9.3).

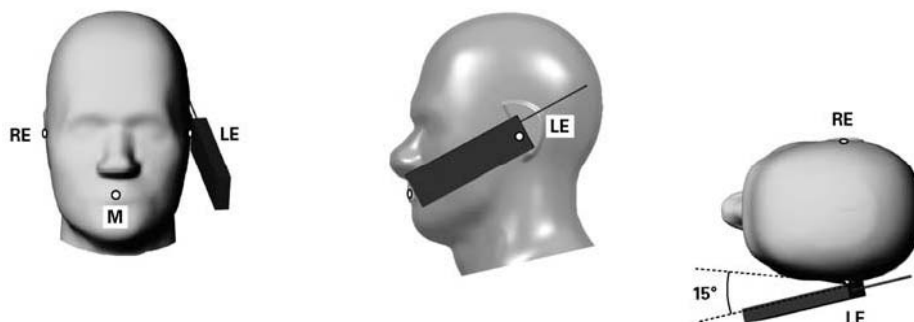

Fig 9.3 Illustration for Tilted Position

4. Body Worn Position

- (a) To position the device parallel to the phantom surface with either keypad up or down.
- (b) To adjust the device parallel to the flat phantom.
- (c) To adjust the distance between the device surface and the flat phantom to 1.5 cm.

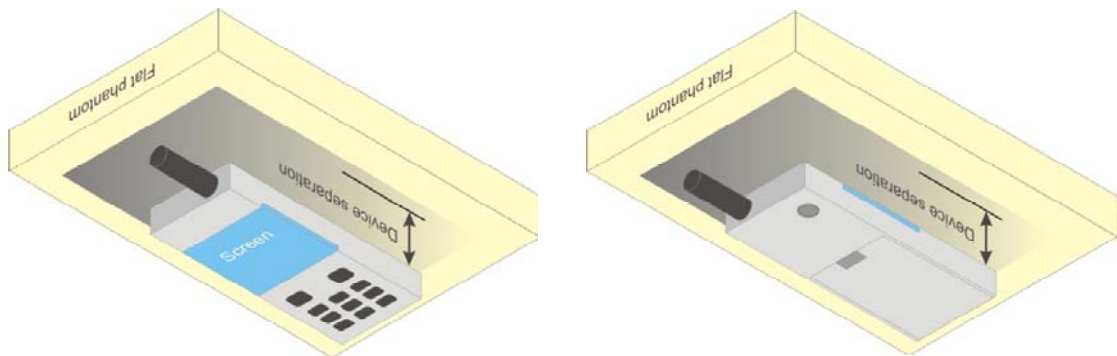

Fig 9.4 Illustration for Body Worn Position

<DUT Setup Photos>

Please refer to Appendix E for the test setup photos.

10. Measurement Procedures

The measurement procedures are as follows:

- (a) Use base station or engineering software (if applicable) to transmit RF power continuously (continuous Tx) in the highest power channel Set base station emulator to allow DUT to radiate maximum output power.
- (b) Measure output power through RF cable and power meter.
- (c) Place the DUT in the positions as Appendix E demonstrates.
- (d) Set scan area, grid size and other setting on the DASY software.
- (e) Measure SAR results for the highest power channel on each testing position.
- (f) Find out the largest SAR result on these testing positions of each band
- (g) Measure SAR results for other channels in worst SAR testing position if the SAR of highest power channel is larger than 0.8 W/kg

According to the test standard, the recommended procedure for assessing the peak spatial-average SAR value consists of the following steps:

- (a) Power reference measurement
- (b) Area scan
- (c) Zoom scan
- (d) Power drift measurement

10.1 Spatial Peak SAR Evaluation

The procedure for spatial peak SAR evaluation has been implemented according to the test standard. It can be conducted for 1g and 10g, as well as for user-specific masses. The DASY software includes all numerical procedures necessary to evaluate the spatial peak SAR value.

The base for the evaluation is a "cube" measurement. The measured volume must include the 1g and 10g cubes with the highest averaged SAR values. For that purpose, the center of the measured volume is aligned to the interpolated peak SAR value of a previously performed area scan.

The entire evaluation of the spatial peak values is performed within the post-processing engine (SEMCAD). The system always gives the maximum values for the 1g and 10g cubes. The algorithm to find the cube with highest averaged SAR is divided into the following stages:

- (a) Extraction of the measured data (grid and values) from the Zoom Scan
- (b) Calculation of the SAR value at every measurement point based on all stored data (A/D values and measurement parameters)
- (c) Generation of a high-resolution mesh within the measured volume
- (d) Interpolation of all measured values from the measurement grid to the high-resolution grid
- (e) Extrapolation of the entire 3-D field distribution to the phantom surface over the distance from sensor to surface
- (f) Calculation of the averaged SAR within masses of 1g and 10g

10.2 Area & Zoom Scan Procedures

First Area Scan is used to locate the approximate location(s) of the local peak SAR value(s). The measurement grid within an Area Scan is defined by the grid extent, grid step size and grid offset. Next, in order to determine the EM field distribution in a three-dimensional spatial extension, Zoom Scan is required. The Zoom Scan measures 5x5x7 points with step size 8, 8 and 5 mm for 300 MHz to 3 GHz, and 8x8x8 points with step size 4, 4 and 2.5 mm for 3 GHz to 6 GHz. The Zoom Scan is performed around the highest E-field value to determine the averaged SAR-distribution over 10 g.

10.3 Volume Scan Procedures

The volume scan is used for assess overlapping SAR distributions for antennas transmitting in different frequency bands. It is equivalent to an oversized zoom scan used in standalone measurements. The measurement volume will be used to enclose all the simultaneous transmitting antennas. For antennas transmitting simultaneously in different frequency bands, the volume scan is measured separately in each frequency band. In order to sum correctly to compute the 1g aggregate SAR, the DUT remain in the same test position for all measurements and all volume scan use the same spatial resolution and grid spacing (step-size is 4, 4 and 2.5 mm). When all volume scan were completed, the software, SEMCAD postprocessor can combine and subsequently superpose these measurement data to calculating the multiband SAR.

10.4 SAR Averaged Methods

In DASYS, the interpolation and extrapolation are both based on the modified Quadratic Shepard's method. The interpolation scheme combines a least-square fitted function method and a weighted average method which are the two basic types of computational interpolation and approximation.

Extrapolation routines are used to obtain SAR values between the lowest measurement points and the inner phantom surface. The extrapolation distance is determined by the surface detection distance and the probe sensor offset. The uncertainty increases with the extrapolation distance. To keep the uncertainty within 1% for the 1 g and 10 g cubes, the extrapolation distance should not be larger than 5 mm.

10.5 Power Drift Monitoring

All SAR testing is under the DUT install full charged battery and transmit maximum output power. In DASYS measurement software, the power reference measurement and power drift measurement procedures are used for monitoring the power drift of DUT during SAR test. Both these procedures measure the field at a specified reference position before and after the SAR testing. The software will calculate the field difference in dB. If the power drift more than 5%, the SAR will be retested.

11. SAR Test Configurations

11.1 Exposure Positions Consideration

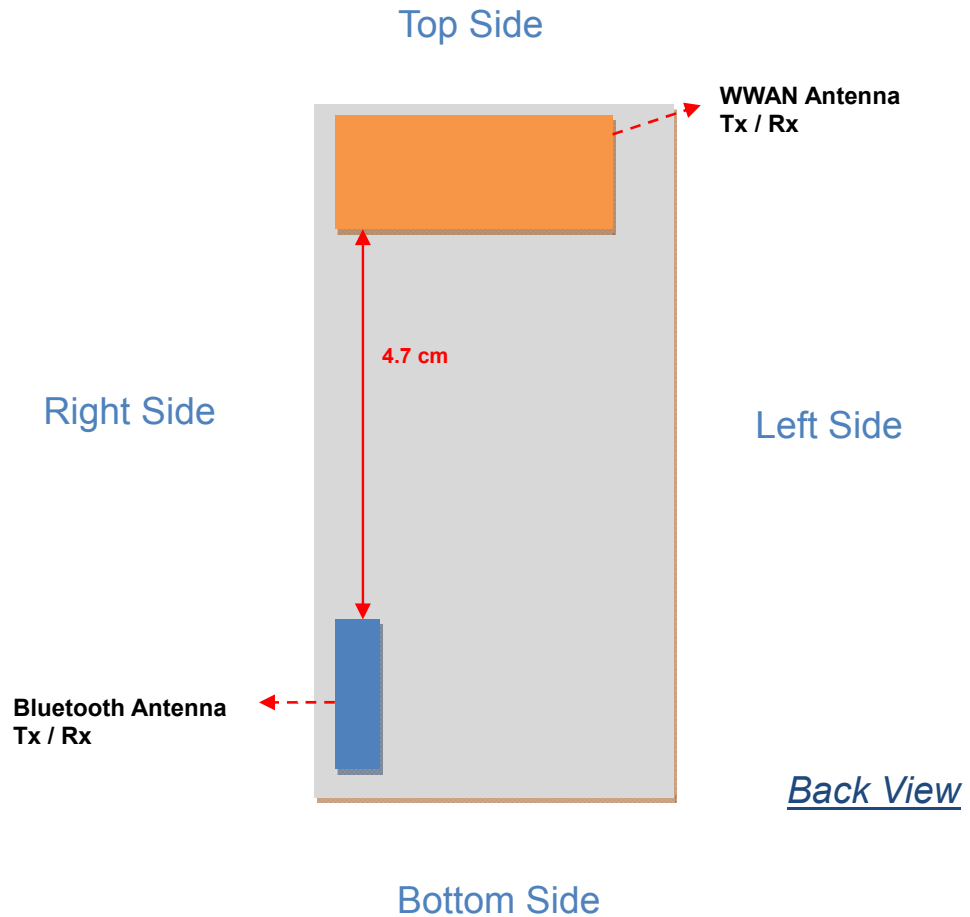

| | |
|-------------------|---------------------------|
| WWAN Antenna | GSM 850, GSM 1900 (Tx/Rx) |
| Bluetooth Antenna | Bluetooth (Tx/Rx) |



11.2 Simultaneous Transmitting Configurations

| | Applicable Combination |
|---------------------------|------------------------|
| Simultaneous Transmission | GSM/GPRS + Bluetooth |

Note:

According to KDB 648474, Per KDB 648474 D01, Bluetooth (4.42 dBm) output power \leq PRef, and antenna is \geq 2.5 cm, so the Bluetooth stand-alone SAR is not required; because the maximum WWAN SAR (1.11 W/kg) and Bluetooth stand-alone SAR is not required, so the sum SAR is $<$ 1.6 W/kg, therefore, simultaneous transmission SAR for WWAN and Bluetooth were not required.

12. SAR Test Results

12.1 Conducted Power (Unit: dBm)

<GSM/GPRS>

| Burst Average Power | | | | | | |
|--------------------------|--------|-------|-------|---------|--------|--------|
| Band | GSM850 | | | GSM1900 | | |
| Channel | 128 | 189 | 251 | 512 | 661 | 810 |
| Frequency (MHz) | 824.2 | 836.4 | 848.8 | 1850.2 | 1880.0 | 1909.8 |
| GSM (1 Uplink) | 31.86 | 31.88 | 31.81 | 28.76 | 28.77 | 28.89 |
| GPRS 8 (1 Uplink) – CS1 | 31.77 | 31.78 | 31.72 | 28.63 | 28.67 | 28.78 |
| GPRS 10 (2 Uplink) – CS1 | 31.45 | 31.33 | 31.04 | 27.94 | 27.95 | 28.06 |
| GPRS 11 (3 Uplink) – CS1 | 30.23 | 29.79 | 29.16 | 26.75 | 26.71 | 26.80 |
| GPRS 12 (4 Uplink) – CS1 | 29.09 | 28.50 | 27.71 | 25.90 | 25.83 | 25.88 |

| Source-Based Time-Averaged Power | | | | | | |
|----------------------------------|--------|-------|-------|---------|--------|--------|
| Band | GSM850 | | | GSM1900 | | |
| Channel | 128 | 189 | 251 | 512 | 661 | 810 |
| Frequency (MHz) | 824.2 | 836.4 | 848.8 | 1850.2 | 1880.0 | 1909.8 |
| GSM (1 Uplink) | 22.86 | 22.88 | 22.81 | 19.76 | 19.77 | 19.89 |
| GPRS 8 (1 Uplink) – CS1 | 22.77 | 22.78 | 22.72 | 19.63 | 19.67 | 19.78 |
| GPRS 10 (2 Uplink) – CS1 | 25.45 | 25.33 | 25.04 | 21.94 | 21.95 | 22.06 |
| GPRS 11 (3 Uplink) – CS1 | 25.97 | 25.53 | 24.90 | 22.49 | 22.45 | 22.54 |
| GPRS 12 (4 Uplink) – CS1 | 26.09 | 25.50 | 24.71 | 22.90 | 22.83 | 22.88 |

Remark: The source-based time-averaged power is linearly scaled the maximum burst averaged power based on time slots. The calculated method are shown as below:

Source based time averaged power = Maximum burst averaged power (1 Uplink) - 9 dB

Source based time averaged power = Maximum burst averaged power (2 Uplink) - 6 dB

Source based time averaged power = Maximum burst averaged power (3 Uplink) - 4.26 dB

Source based time averaged power = Maximum burst averaged power (4 Uplink) - 3 dB

Note:

1. For Head SAR testing, GSM should be evaluated, therefore the DUT was set in GSM for GSM850 and set in GSM for GSM1900 due to its highest source-based time-average power.
2. For Body-worn SAR testing, GPRS should be evaluated, therefore the DUT was set in GPRS 12 for GSM850 and set in GPRS 12 for GSM1900 due to its highest source-based time-average power.
3. Per 2010/10 workshop, the maximum output power channel is used for SAR testing and for further SAR test reduction.
4. The DUT do not support DTM function.

| Band | Bluetooth | | |
|---------------|-----------|------|------|
| Channel | 0 | 39 | 78 |
| Frequency | 2402 | 2441 | 2480 |
| Average Power | 4.42 | 4.16 | 3.65 |
| Peak Power | 4.93 | 4.95 | 4.97 |

12.2 Test Records for Head SAR Test

<GSM>

| Plot No. | Band | Mode | Test Position | Ch. | SAR _{1g} (W/kg) |
|-----------|----------------|------------|-------------------|------------|--------------------------|
| 7 | GSM850 | GSM | Right Cheek | 189 | 0.95 |
| 8 | GSM850 | GSM | Right Tilted | 189 | 0.528 |
| 9 | GSM850 | GSM | Left Cheek | 189 | 0.97 |
| 10 | GSM850 | GSM | Left Tilted | 189 | 0.525 |
| 11 | GSM850 | GSM | Right Cheek | 128 | 0.753 |
| 12 | GSM850 | GSM | Right Cheek | 251 | 1.1 |
| 13 | GSM850 | GSM | Left Cheek | 128 | 0.768 |
| 14 | GSM850 | GSM | Left Cheek | 251 | 1.11 |
| 15 | GSM1900 | GSM | Right Cheek | 810 | 0.453 |
| 16 | GSM1900 | GSM | Right Tilted | 810 | 0.264 |
| 17 | GSM1900 | GSM | Left Cheek | 810 | 0.613 |
| 18 | GSM1900 | GSM | Left Tilted | 810 | 0.32 |

Note: Per KDB 648474, if the highest output channel SAR for each exposure position ≤ 0.8 W/kg other channels SAR tests are not necessary.

12.3 Test Records for Body-worn SAR Test

<GSM>

| Plot No. | Band | Mode | Test Position | Gap (cm) | Ch. | SAR _{1g} (W/kg) |
|----------|----------------|---------------|---------------|------------|------------|--------------------------|
| 1 | GSM850 | GPRS12 | Face | 1.5 | 128 | 0.449 |
| 2 | GSM850 | GPRS12 | Bottom | 1.5 | 128 | 0.861 |
| 3 | GSM850 | GPRS12 | Bottom | 1.5 | 189 | 0.854 |
| 4 | GSM850 | GPRS12 | Bottom | 1.5 | 251 | 0.851 |
| 5 | GSM1900 | GPRS12 | Face | 1.5 | 512 | 0.297 |
| 6 | GSM1900 | GPRS12 | Bottom | 1.5 | 512 | 0.496 |

Note:

Per KDB 648474, if the highest output channel SAR for each exposure position ≤ 0.8 W/kg other channels SAR tests are not necessary.

Test Engineer : Jeme Li



13. References

- [1] FCC 47 CFR Part 2 “Frequency Allocations and Radio Treaty Matters; General Rules and Regulations”
- [2] IEEE Std. C95.1-1991, “IEEE Standard for Safety Levels with Respect to Human Exposure to Radio Frequency Electromagnetic Fields, 3 kHz to 300 GHz”, 1991
- [3] IEEE Std. 1528-2003, “Recommended Practice for Determining the Peak Spatial-Average Specific Absorption Rate (SAR) in the Human Head from Wireless Communications Devices: Measurement Techniques”, December 2003
- [4] FCC OET Bulletin 65 (Edition 97-01) Supplement C (Edition 01-01), “Evaluating Compliance with FCC Guidelines for Human Exposure to Radiofrequency Electromagnetic Fields”, June 2001
- [5] SPEAG DASY System Handbook
- [6] FCC KDB 248227 D01 v01r02, “SAR Measurement Procedures for 802.11 a/b/g Transmitters”, May 2007
- [7] FCC KDB 447498 D01 v04, “Mobile and Portable Device RF Exposure Procedures and Equipment Authorization Policies”, November 2009
- [8] FCC KDB 447498 D02 v02, “SAR Measurement Procedures for USB Dongle Transmitters”, November 2009
- [9] FCC KDB 616217 D01 v01r01, “SAR Evaluation Considerations for Laptop Computers with Antennas Built-in on Display Screens”, November 2009
- [10] FCC KDB 616217 D03 v01, “SAR Evaluation Considerations for Laptop/Notebook/Netbook and Tablet Computers”, November 2009
- [11] FCC KDB 648474 D01 v01r05, “SAR Evaluation Considerations for Handsets with Multiple Transmitters and Antennas”, September 2008
- [12] FCC KDB 941225 D01 v02, “SAR Measurement Procedures for 3G Devices – CDMA 2000 / Ev-Do / WCDMA / HSDPA / HSPA”, October 2007
- [13] FCC KDB 941225 D02 v02 “3GPP R6 HSPA and R7 HSPA+ SAR Guidance”, December 2009.
- [14] FCC KDB 941225 D03 v01, “Recommended SAR Test Reduction Procedures for GSM / GPRS / EDGE”, December 2008
- [15] FCC KDB 941225 D04 v01, “Evaluating SAR for GSM/(E)GPRS Dual Transfer Mode”, January 27 2010