



FCC Test Report

APPLICANT : Brightstar Corporation
EQUIPMENT : Mobile Phone
BRAND NAME : mint
MODEL NAME : M245
FCC ID : WVB245M
STANDARD : FCC 47 CFR FCC Part 15 Subpart B
CLASSIFICATION : Certification

The product was received on Feb. 02, 2016 and testing was completed on Mar. 10, 2016. We, SPORTON INTERNATIONAL (SHENZHEN) INC., would like to declare that the tested sample has been evaluated in accordance with the test procedures given in ANSI C63.4-2009 and has been in compliance with the applicable technical standards.

The test results in this report apply exclusively to the tested model / sample. Without written approval of SPORTON INTERNATIONAL (SHENZHEN) INC., the test report shall not be reproduced except in full.

Prepared by: Andy Yeh / Manager

Approved by: Jones Tsai / Manager



Testing Laboratory

2353

SPORTON INTERNATIONAL (SHENZHEN) INC.

**1F & 2F, Building A, Morning Business Center, No. 4003 ShiGu Rd., Xili Town,
Nanshan District, Shenzhen, Guangdong, P. R. China**



TABLE OF CONTENTS

REVISION HISTORY.....3

SUMMARY OF TEST RESULT4

1. GENERAL DESCRIPTION5

 1.1. Applicant.....5

 1.2. Manufacturer5

 1.3. Product Feature of Equipment Under Test5

 1.4. Product Specification of Equipment Under Test6

 1.5. Modification of EUT6

 1.6. Test Location7

 1.7. Applicable Standards7

2. TEST CONFIGURATION OF EQUIPMENT UNDER TEST.....8

 2.1. Test Mode8

 2.2. Connection Diagram of Test System 10

 2.3. Support Unit used in test configuration and system..... 11

 2.4. EUT Operation Test Setup 12

3. TEST RESULT.....13

 3.1. Test of AC Conducted Emission Measurement13

 3.2. Test of Radiated Emission Measurement 19

4. LIST OF MEASURING EQUIPMENT25

5. UNCERTAINTY OF EVALUATION26

APPENDIX A. SETUP PHOTOGRAPHS



REVISION HISTORY

REPORT NO.	VERSION	DESCRIPTION	ISSUED DATE
FC620201	Rev. 01	Initial issue of report	Mar. 16, 2016



SUMMARY OF TEST RESULT

Report Section	FCC Rule	Description	Limit	Result	Remark
3.1	15.107	AC Conducted Emission	< 15.107 limits	PASS	Under limit 6.77 dB at 0.150 MHz
3.2	15.109	Radiated Emission	< 15.109 limits	PASS	Under limit 3.77 dB at 37.020 MHz



1. General Description

1.1. Applicant

Brightstar Corporation

9725 NW 117th Ave., Miami, Florida, FL 33178, United States

1.2. Manufacturer

Heng Da Chuang Xin Technology Limited

Rm14H Taibang Building, 4 Rd., High Tech South, Nanshan, SZ, P. R. C. 518000

1.3. Product Feature of Equipment Under Test

Product Feature	
Equipment	Mobile Phone
Brand Name	mint
Model Name	M245
FCC ID	WVB245M
EUT supports Radios application	GSM/GPRS/EGPRS(Downlink Only)/WCDMA/HSPA/ HSPA+(16QAM uplink is not supported)/ WLAN2.4GHz 802.11b/g/n HT20/HT40/ Bluetooth v3.0+EDR/Bluetooth v4.0 LE
IMEI Code	Conduction/Radiation: 358395070001997/358395070003993
HW Version	V1_0_1
SW Version	MINT_M245_V1_0_1
EUT Stage	Pre-Production

Remark: The above EUT's information was declared by manufacturer. Please refer to the specifications or user's manual for more detailed description.



1.4. Product Specification of Equipment Under Test

Standards-related Product Specification	
Tx Frequency	GSM850: 824.2 MHz ~ 848.8 MHz GSM1900: 1850.2 MHz ~ 1909.8MHz WCDMA Band V: 826.4 MHz ~ 846.6 MHz WCDMA Band II: 1852.4 MHz ~ 1907.6 MHz 802.11b/g/n: 2412 MHz ~ 2462 MHz Bluetooth: 2402 MHz ~ 2480 MHz
Rx Frequency	GSM850: 869.2 MHz ~ 893.8 MHz GSM1900: 1930.2 MHz ~ 1989.8 MHz WCDMA Band V: 871.4 MHz ~ 891.6 MHz WCDMA Band II: 1932.4 MHz ~ 1987.6 MHz 802.11b/g/n: 2412 MHz ~ 2462 MHz Bluetooth: 2402 MHz ~ 2480 MHz GPS : 1.57542 GHz
Antenna Type	WWAN : IFA Antenna WLAN : IFA Antenna Bluetooth : IFA Antenna GPS : IFA Antenna
Type of Modulation	GSM: GMSK GPRS: GMSK EDGE(MCS 0-4): GMSK / (MCS 5-9): 8PSK(Downlink Only) WCDMA: QPSK (Uplink) HSDPA: QPSK (Uplink) HSUPA: QPSK (Uplink) HSPA+: 16QAM (Uplink is not supported) 802.11b : DSSS (DBPSK / DQPSK / CCK) 802.11g/n : OFDM (BPSK / QPSK / 16QAM / 64QAM) Bluetooth v4.0 LE : GFSK Bluetooth (1Mbps) : GFSK Bluetooth (2Mbps) : $\pi/4$ -DQPSK Bluetooth (3Mbps) : 8-DPSK GPS : BPSK

1.5. Modification of EUT

No modifications are made to the EUT during all test items.



1.6. Test Location

Test Site	SPORTON INTERNATIONAL (SHENZHEN) INC.	
Test Site Location	1F & 2F, Building A, Morning Business Center, No. 4003 ShiGu Rd., Xili Town, Nanshan District, Shenzhen, Guangdong, P. R. China TEL: +86-755-8637-9589 FAX: +86-755-8637-9595	
Test Site No.	Sporton Site No.	
	CO01-SZ	

Test Site	SPORTON INTERNATIONAL (SHENZHEN) INC.	
Test Site Location	No. 3 Building, the third floor of south, Shahe River west, Fengzeyuan warehouse, Nanshan District, Shenzhen, Guangdong, P. R. China TEL: +86-755-3320-2398	
Test Site No.	Sporton Site No.	FCC Registration No.
	03CH01-SZ	831040

1.7. Applicable Standards

According to the specifications of the manufacturer, the EUT must comply with the requirements of the following standards:

- ♦ FCC 47 CFR FCC Part 15 Subpart B
- ♦ ANSI C63.4-2009

Remark: All test items were verified and recorded according to the standards and without any deviation during the test.



2. Test Configuration of Equipment Under Test

2.1. Test Mode

The EUT has been associated with peripherals pursuant to ANSI C63.4-2009 and configuration operated in a manner tended to maximize its emission characteristics in a typical application.

Frequency range investigated: conduction (150 kHz to 30 MHz), radiation (30MHz to the 5th harmonic of the highest fundamental frequency or to 40 GHz, whichever is lower).

The following tables are showing the test modes as the worst cases and recorded in this report.

Item	EUT Configuration	Test Condition		
		EMI AC	EMI RE<1G	EMI RE≥1G
1.	Charging Mode (EUT with adapter)	☒	☒	☒
2.	Data application transferred mode (EUT connected with notebook)	☒	☒	☒

Abbreviations:

- EMI AC: AC conducted emissions
- EMI RE ≥ 1G: EUT radiated emissions ≥ 1GHz
- EMI RE < 1G: EUT radiated emissions < 1GHz



Test Items	EUT Configure Mode	Function Type
AC Conducted Emission	1/2	<p>Mode 1: WCDMA Band II Idle + USB Cable (Charging from Adapter) + Bluetooth Idle + WLAN Idle + Earphone + Camera (Front) + SIM1 <Fig.1></p> <p>Mode 2: GSM850 Idle + USB Cable (Charging from Adapter) + Bluetooth Idle + WLAN Idle + Earphone + Camera (Back) + SIM2 <Fig.1></p> <p>Mode 3: GSM1900 Idle + USB Cable (Charging from Adapter) + Bluetooth Idle + WLAN Idle + Earphone + MPEG4 + SIM1 <Fig.1></p> <p>Mode 4: WCDMA Band V Idle + USB Cable (Data Link with Notebook) + Bluetooth Idle + WLAN Idle + Earphone + GPS Rx + SD Card + SIM2 <Fig.2></p>
Radiated Emissions < 1GHz	1/2	<p>Mode 1: WCDMA Band II Idle + USB Cable (Charging from Adapter) + Bluetooth Idle + WLAN Idle + Earphone + Camera (Front) + SIM1 <Fig.1></p> <p>Mode 2: GSM850 Idle + USB Cable (Charging from Adapter) + Bluetooth Idle + WLAN Idle + Earphone + Camera (Back) + SIM2 <Fig.1></p> <p>Mode 3: GSM1900 Idle + USB Cable (Charging from Adapter) + Bluetooth Idle + WLAN Idle + Earphone + MPEG4 + SIM1 <Fig.1></p> <p>Mode 4: WCDMA Band V Idle + USB Cable (Data Link with Notebook) + Bluetooth Idle + WLAN Idle + Earphone + GPS Rx + SD Card + SIM2 <Fig.2></p>
Radiated Emissions ≥ 1GHz	2	<p>Mode 1: GSM850 Idle + USB Cable (Charging from Adapter) + Bluetooth Idle + WLAN Idle + Earphone + Camera (Back) + SIM2 <Fig.1></p> <p>Mode 2: WCDMA Band V Idle + USB Cable (Data Link with Notebook) + Bluetooth Idle + WLAN Idle + Earphone + GPS Rx + SD Card + SIM2 <Fig.2></p>

Remark:

1. The worst case of AC is mode 1; and the USB link mode of AC is mode 4, the test data of these modes are reported.
2. The worst case of RE < 1G is mode 2; and the USB link mode of RE is mode 4, the test data of these modes are reported.
3. Data Link with Notebook means data application transferred mode between EUT and Notebook.

2.2. Connection Diagram of Test System

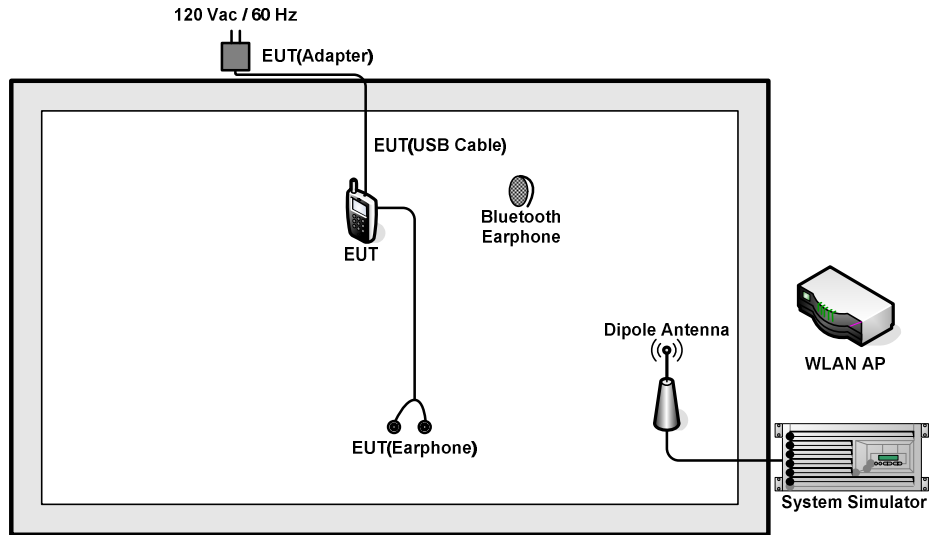

<Fig.1>

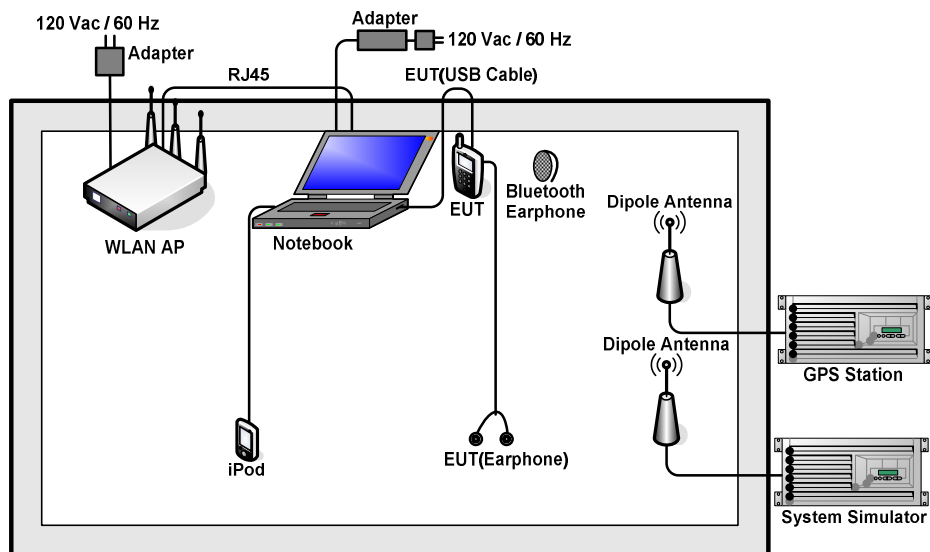

<Fig.2>



2.3. Support Unit used in test configuration and system

Item	Equipment	Trade Name	Model Name	FCC ID	Data Cable	Power Cord
1.	System Simulator	R&S	CMU 200	N/A	N/A	Unshielded, 1.8 m
2.	GPS Station	ADIVIC	MP9000	N/A	N/A	Unshielded, 1.8 m
3.	WLAN AP	ASUSTek	RT-AC66U	MSQ-RTAC66U	N/A	Unshielded, 2.7 m
4.	WLAN AP	D-Link	DIR-628	KA2DIR628A2	N/A	Unshielded, 1.8 m
5.	Bluetooth Earphone	Nokia	BH-108	PYAHS-107W	N/A	N/A
6.	Bluetooth Earphone	Samsung	HS3000	A3LHS3000	N/A	N/A
7.	Notebook	Lenovo	E540	FCC DoC	N/A	AC I/P: Unshielded, 1.2 m DC O/P: Shielded, 1.8 m
8.	SD Card	SanDisk	4G class 4	FCC DoC	N/A	N/A
9.	iPod nano 8GB	Apple	MC690 ZP/A	FCC DoC	Shielded, 1.2 m	N/A
10.	iPod	Apple	MC525 ZP/A	FCC DoC	Shielded, 1.0 m	N/A



2.4. EUT Operation Test Setup

The EUT was in GSM or WCDMA idle mode during the testing. The EUT was synchronized to the BCCH, and was in continuous receiving mode by setting system simulator's paging reorganization.

At the same time, the EUT was attached to the Bluetooth earphone or WLAN AP, and the following programs installed in the EUT were programmed during the test.

1. Data application is transferred between notebook and EUT via USB cable.
2. Execute "GPS Test" to make the EUT receive continuous signals from GPS station.
3. Execute "Video player" to play MPEG4 files.
4. Turn on camera to capture images.



3. Test Result

3.1. Test of AC Conducted Emission Measurement

3.1.1 Limits of AC Conducted Emission

For equipment that is designed to be connected to the public utility (AC) power line, the radio frequency voltage that is conducted back onto the AC power line on any frequency or frequencies within the band 150 kHz to 30 MHz shall not exceed the limits in the following table.

Frequency of emission (MHz)	Conducted limit (dBuV)	
	Quasi-peak	Average
0.15-0.5	66 to 56*	56 to 46*
0.5-5	56	46
5-30	60	50

*Decreases with the logarithm of the frequency.

3.1.2 Measuring Instruments

The measuring equipment is listed in the section 4 of this test report.

3.1.3 Test Procedure

1. The EUT was placed 0.4 meter from the conducting wall of the shielding room was kept at least 80 centimeters from any other grounded conducting surface.
2. Connect EUT to the power mains through a line impedance stabilization network (LISN).
3. All the support units are connecting to the other LISN.
4. The LISN provides 50 ohm coupling impedance for the measuring instrument.
5. The FCC states that a 50 ohm, 50 microhenry LISN should be used.
6. Both sides of AC line were checked for maximum conducted interference.
7. The frequency range from 150 kHz to 30 MHz was searched.
8. Set the test-receiver system to Peak Detect Function and specified bandwidth (IF Bandwidth = 9kHz) with Maximum Hold Mode. Then measurement is also conducted by Average Detector and Quasi-Peak Detector Function respectively.

3.1.4 Test Setup





3.1.5 Test Result of AC Conducted Emission

Test Mode :	Mode 1	Temperature :	21~23°C
Test Engineer :	Jacky Yang	Relative Humidity :	41~43%
Test Voltage :	120Vac / 60Hz	Phase :	Line
Function Type :	WCDMA Band II Idle + USB Cable (Charging from Adapter) + Bluetooth Idle + WLAN Idle + Earphone + Camera (Front) + SIM1		

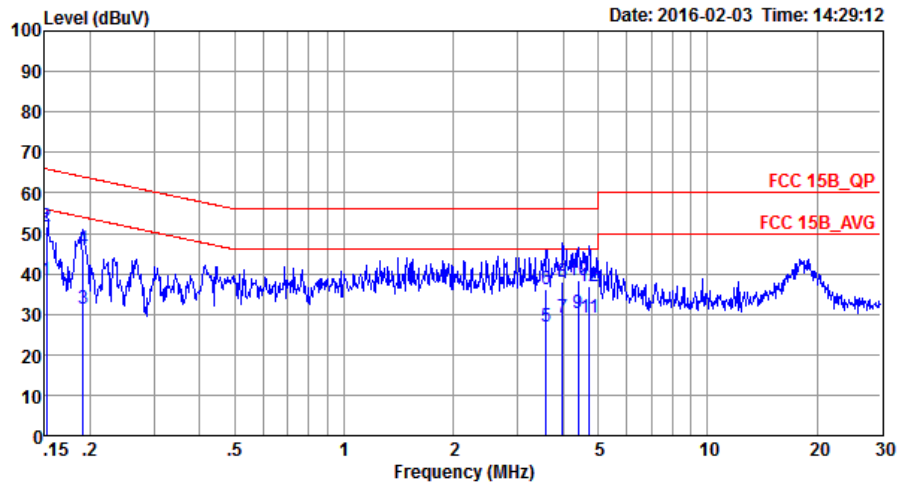

Site : CO01-SZ
 Condition: FCC 15B_QP LISN_L_20160112 LINE
 Project : (FC) 620201
 Mode : Mode 1
 IMEI : 358395070001997/358395070003993

	Freq	Level	Over Limit	Limit Line	Read Level	LISN Factor	Cable Loss	Remark
	MHz	dBuV	dB	dBuV	dBuV	dB	dB	
1	0.15	38.49	-17.42	55.91	27.70	0.43	10.36	Average
2 *	0.15	51.59	-14.32	65.91	40.80	0.43	10.36	QP
3	0.19	31.41	-22.57	53.98	20.60	0.51	10.30	Average
4	0.19	46.11	-17.87	63.98	35.30	0.51	10.30	QP
5	3.60	27.11	-18.89	46.00	16.30	0.59	10.22	Average
6	3.60	36.31	-19.69	56.00	25.50	0.59	10.22	QP
7	3.99	29.14	-16.86	46.00	18.30	0.61	10.23	Average
8	3.99	37.94	-18.06	56.00	27.10	0.61	10.23	QP
9	4.41	30.16	-15.84	46.00	19.31	0.62	10.23	Average
10	4.41	38.46	-17.54	56.00	27.61	0.62	10.23	QP
11	4.72	28.97	-17.03	46.00	18.10	0.63	10.24	Average
12	4.72	36.77	-19.23	56.00	25.90	0.63	10.24	QP



Test Mode :	Mode 1	Temperature :	21~23°C
Test Engineer :	Jacky Yang	Relative Humidity :	41~43%
Test Voltage :	120Vac / 60Hz	Phase :	Neutral
Function Type :	WCDMA Band II Idle + USB Cable (Charging from Adapter) + Bluetooth Idle + WLAN Idle + Earphone + Camera (Front) + SIM1		

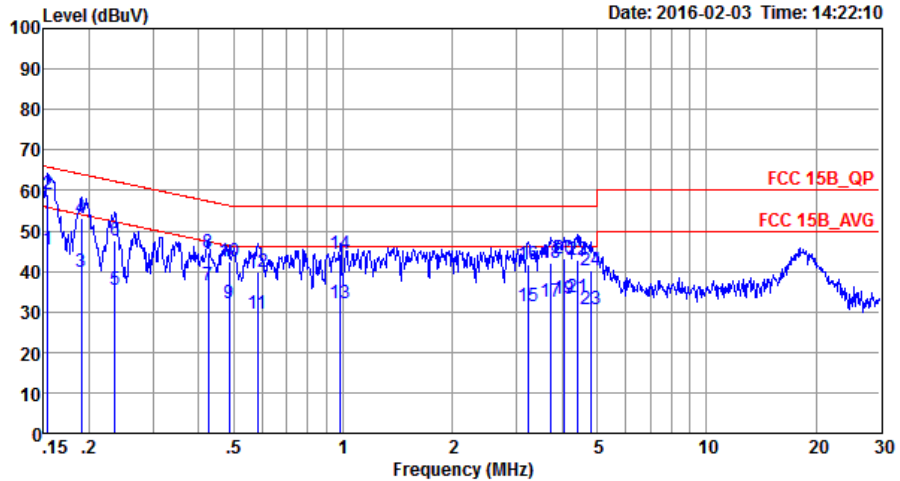

Site : CO01-SZ
 Condition: FCC 15B_QP LISN_N_20160112 NEUTRAL
 Project : (FC)620201
 Mode : Mode 1
 IMEI : 358395070001997/358395070003993

	Freq	Level	Over Limit	Limit	Read	LISN	Cable	Remark
	MHz	dBuV	dB	dBuV	dBuV	dB	dB	
1	0.15	45.51	-10.27	55.78	34.70	0.46	10.35	Average
2 *	0.15	59.01	-6.77	65.78	48.20	0.46	10.35	QP
3	0.19	40.00	-14.02	54.02	29.19	0.50	10.31	Average
4	0.19	53.00	-11.02	64.02	42.19	0.50	10.31	QP
5	0.24	35.30	-16.96	52.26	24.50	0.54	10.26	Average
6	0.24	47.70	-14.56	62.26	36.90	0.54	10.26	QP
7	0.43	36.53	-10.80	47.33	25.79	0.57	10.17	Average
8	0.43	44.63	-12.70	57.33	33.89	0.57	10.17	QP
9	0.49	32.16	-14.07	46.23	21.40	0.60	10.16	Average
10	0.49	42.36	-13.87	56.23	31.60	0.60	10.16	QP
11	0.58	29.43	-16.57	46.00	18.70	0.58	10.15	Average
12	0.58	39.83	-16.17	56.00	29.10	0.58	10.15	QP
13	0.98	32.21	-13.79	46.00	21.50	0.56	10.15	Average
14	0.98	44.31	-11.69	56.00	33.60	0.56	10.15	QP
15	3.22	31.33	-14.67	46.00	20.50	0.61	10.22	Average
16	3.22	41.63	-14.37	56.00	30.80	0.61	10.22	QP
17	3.72	32.65	-13.35	46.00	21.81	0.62	10.22	Average
18	3.72	42.25	-13.75	56.00	31.41	0.62	10.22	QP
19	4.07	33.26	-12.74	46.00	22.40	0.63	10.23	Average
20	4.07	43.06	-12.94	56.00	32.20	0.63	10.23	QP
21	4.43	33.47	-12.53	46.00	22.60	0.64	10.23	Average
22	4.43	42.87	-13.13	56.00	32.00	0.64	10.23	QP
23	4.82	30.69	-15.31	46.00	19.80	0.65	10.24	Average
24	4.82	40.29	-15.71	56.00	29.40	0.65	10.24	QP



Test Mode :	Mode 4	Temperature :	21~23°C
Test Engineer :	Jacky Yang	Relative Humidity :	41~43%
Test Voltage :	120Vac / 60Hz	Phase :	Line
Function Type :	WCDMA Band V Idle + USB Cable (Data Link with Notebook) + Bluetooth Idle + WLAN Idle + Earphone + GPS Rx + SD Card + SIM2		

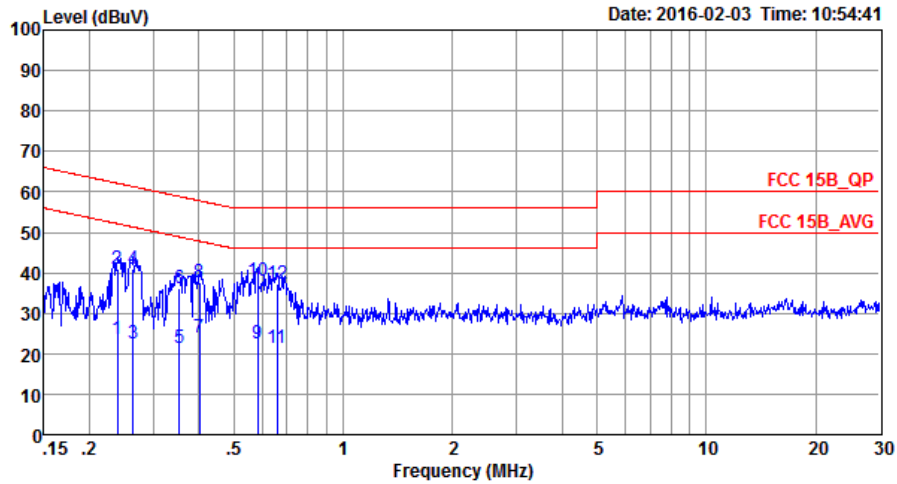

Site : C001-SZ
 Condition: FCC 15B_QP LISN_L 20160112 LINE
 Project : (FC) 620201
 Mode : Mode 4
 IMEI : 358395070001997/358395070003993

	Freq	Level	Over Limit	Limit Line	Read Level	LISN Factor	Cable Loss	Remark
	MHz	dBuV	dB	dBuV	dBuV	dB	dB	
1	0.24	23.49	-28.64	52.13	12.70	0.54	10.25	Average
2	0.24	41.09	-21.04	62.13	30.30	0.54	10.25	QP
3	0.26	22.68	-28.61	51.29	11.89	0.56	10.23	Average
4	0.26	40.88	-20.41	61.29	30.09	0.56	10.23	QP
5	0.35	21.34	-27.53	48.87	10.61	0.55	10.18	Average
6	0.35	36.34	-22.53	58.87	25.61	0.55	10.18	QP
7	0.40	23.91	-23.90	47.81	13.20	0.54	10.17	Average
8	0.40	37.81	-20.00	57.81	27.10	0.54	10.17	QP
9	0.58	22.46	-23.54	46.00	11.70	0.61	10.15	Average
10 *	0.58	37.96	-18.04	56.00	27.20	0.61	10.15	QP
11	0.66	21.51	-24.49	46.00	10.80	0.56	10.15	Average
12	0.66	37.11	-18.89	56.00	26.40	0.56	10.15	QP



Test Mode :	Mode 4	Temperature :	21~23°C
Test Engineer :	Jacky Yang	Relative Humidity :	41~43%
Test Voltage :	120Vac / 60Hz	Phase :	Neutral
Function Type :	WCDMA Band V Idle + USB Cable (Data Link with Notebook) + Bluetooth Idle + WLAN Idle + Earphone + GPS Rx + SD Card + SIM2		

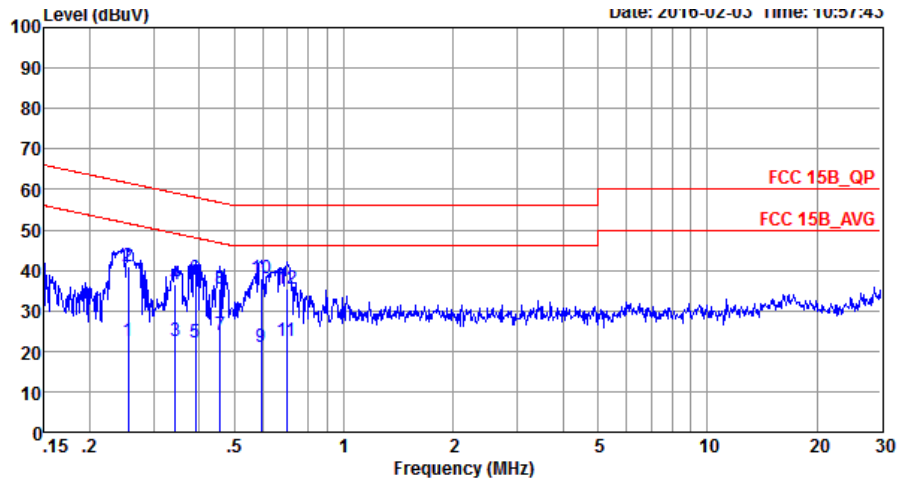

Site : CO01-SZ
 Condition: FCC 15B_QP LISN_N_20160112 NEUTRAL
 Project : (FC)620201
 Mode : Mode 4
 IMEI : 358395070001997/358395070003993

	Freq	Level	Over Limit	Limit Line	Read Level	LISN Factor	Cable Loss	Remark
	MHz	dBuV	dB	dBuV	dBuV	dB	dB	
1	0.25	22.50	-29.10	51.60	11.70	0.56	10.24	Average
2	0.25	41.10	-20.50	61.60	30.30	0.56	10.24	QP
3	0.34	22.66	-26.43	49.09	11.90	0.57	10.19	Average
4	0.34	36.46	-22.63	59.09	25.70	0.57	10.19	QP
5	0.39	22.13	-25.90	48.03	11.41	0.55	10.17	Average
6	0.39	37.93	-20.10	58.03	27.21	0.55	10.17	QP
7	0.46	23.95	-22.81	46.76	13.20	0.59	10.16	Average
8	0.46	35.55	-21.21	56.76	24.80	0.59	10.16	QP
9	0.59	21.03	-24.97	46.00	10.30	0.58	10.15	Average
10 *	0.59	38.13	-17.87	56.00	27.40	0.58	10.15	QP
11	0.70	22.50	-23.50	46.00	11.80	0.55	10.15	Average
12	0.70	35.40	-20.60	56.00	24.70	0.55	10.15	QP



3.2. Test of Radiated Emission Measurement

3.2.1. Limit of Radiated Emission

The emissions from an unintentional radiator shall not exceed the field strength levels specified in the following table:

Frequency (MHz)	Field Strength (microvolts/meter)	Measurement Distance (meters)
30 – 88	100	3
88 – 216	150	3
216 - 960	200	3
Above 960	500	3

3.2.2. Measuring Instruments

The measuring equipment is listed in the section 4 of this test report.

3.2.3. Test Procedures

1. The EUT was placed on a turntable with 0.8 meter above ground.
2. The EUT was set 3 meters from the interference receiving antenna, which was mounted on the top of a variable height antenna tower.
3. The table was rotated 360 degrees to determine the position of the highest radiation.
4. The antenna is a Bi-Log antenna and its height is adjusted between one to four meters above ground to find the maximum value of the field strength for both horizontal polarization and vertical polarization of the antenna.
5. For each suspected emission, the EUT was arranged to its worst case and then tune the antenna tower (from 1 m to 4 m) and turntable (from 0 degree to 360 degrees) to find the maximum reading.
6. Set the test-receiver system to Peak Detect Function and specified bandwidth with Maximum Hold Mode (RBW=120kHz/VBW=300kHz for frequency below 1GHz; RBW=1MHz VBW=3MHz (Peak), RBW=1MHz/VBW=10Hz (Average) for frequency above 1GHz).
7. If the emission level of the EUT in peak mode was 3 dB lower than the limit specified, peak values of EUT will be reported. Otherwise, the emission will be repeated by using the quasi-peak method and reported.
8. Emission level (dBµV/m) = 20 log Emission level (µV/m)
9. Corrected Reading: Antenna Factor + Cable Loss + Read Level - Preamp Factor = Level

3.2.4. Test Setup of Radiated Emission

For radiated emissions from 30MHz to 1GHz

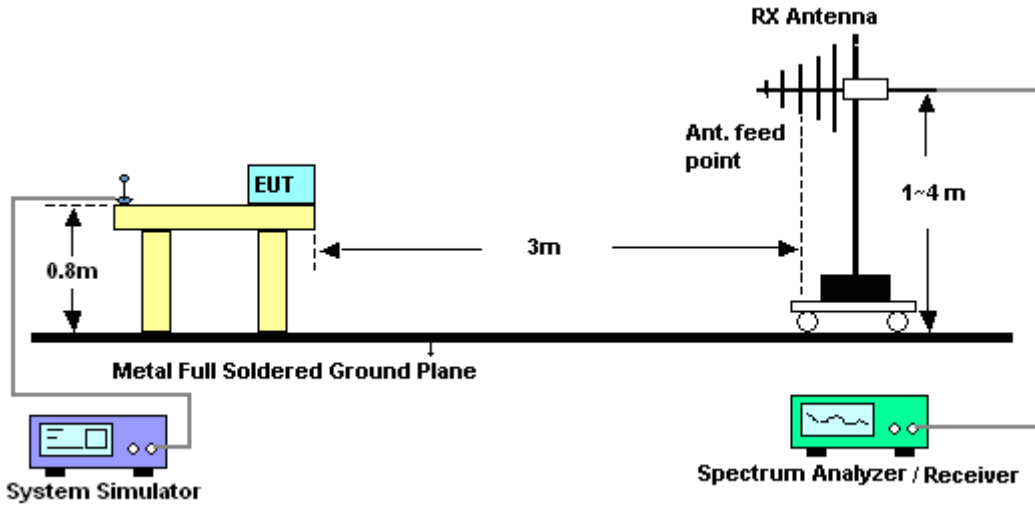

For radiated emissions above 1GHz

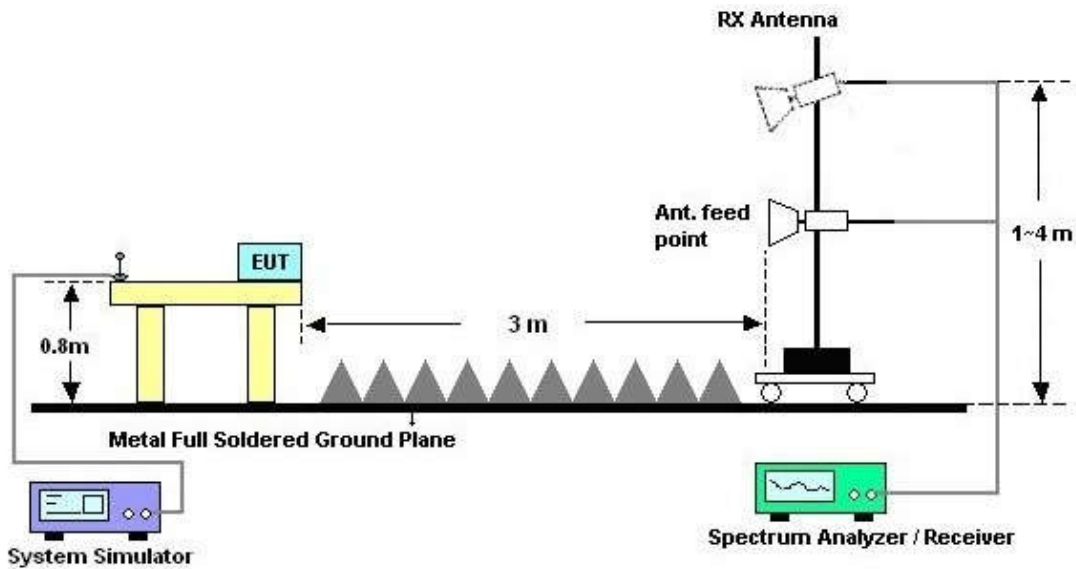



3.2.5. Test Result of Radiated Emission

Test Mode :	Mode 2	Temperature :	23~25°C
Test Engineer :	Jeff Yao	Relative Humidity :	48~52%
Test Distance :	3m	Polarization :	Horizontal
Function Type :	GSM850 Idle + USB Cable (Charging from Adapter) + Bluetooth Idle + WLAN Idle + Earphone + Camera (Back) + SIM2		
Remark :	#7 is system simulator signal which can be ignored.		

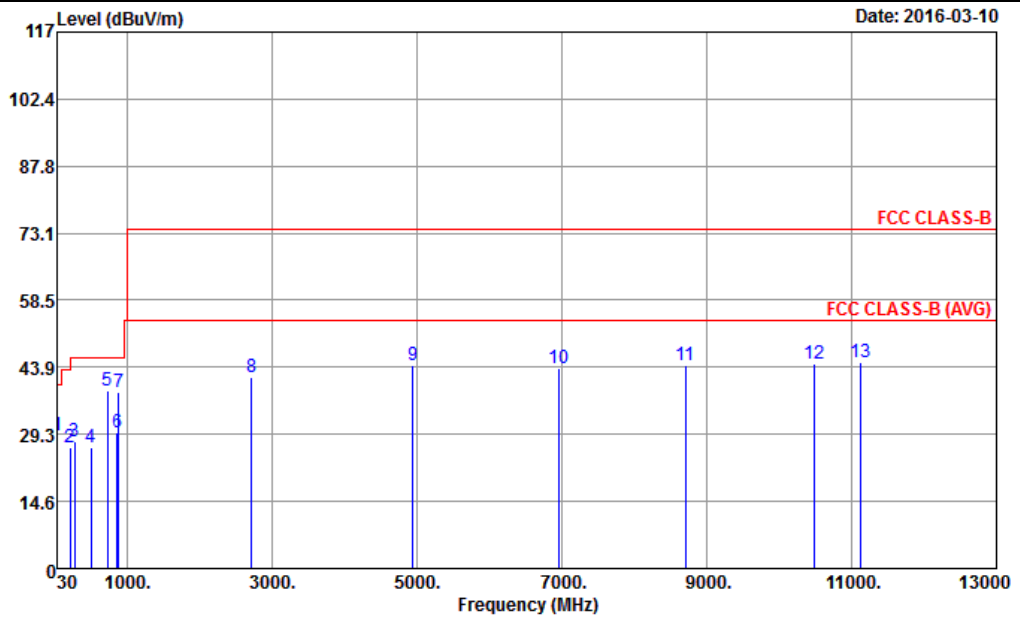

Site : 03CH01-SZ
 Condition : FCC CLASS-B 3m LF_ANT(23188)_151017 HORIZONTAL
 Project : (FC) 620201
 Mode : Mode 2
 IMEI : 358395070001997/358395070003993

	Freq	Level	Over Limit	Limit Line	ReadAntenna	Cable	Preamp	A/Pos	T/Pos	Remark	
	MHz	dBuV/m	dB	dBuV/m	dBuV	dB/m	dB	dB	cm	deg	
1	30.27	29.12	-10.88	40.00	28.84	25.60	0.75	26.07	---	---	Peak
2	213.06	26.48	-17.02	43.50	38.34	11.82	1.54	25.22	---	---	Peak
3	273.27	27.81	-18.19	46.00	38.14	13.20	1.57	25.10	---	---	Peak
4	500.20	26.46	-19.54	46.00	31.23	19.40	2.17	26.34	---	---	Peak
5	727.70	38.71	-7.29	46.00	41.48	20.90	2.65	26.32	100	0	Peak
6	864.20	29.50	-16.50	46.00	30.54	21.92	3.02	25.98	---	---	Peak
7	881.70	38.61			39.75	21.77	3.02	25.93	---	---	Peak
8	2716.00	41.76	-32.24	74.00	62.49	32.87	5.46	59.06	---	---	Peak
9	4938.00	44.37	-29.63	74.00	60.75	34.47	7.56	58.41	---	---	Peak
10	6956.00	43.66	-30.34	74.00	55.77	36.12	9.26	57.49	---	---	Peak
11	8710.00	44.32	-29.68	74.00	54.63	36.46	10.95	57.72	---	---	Peak
12	10490.00	44.72	-29.28	74.00	52.96	38.49	12.30	59.03	---	---	Peak
13	11132.00	45.10	-28.90	74.00	53.22	38.91	12.58	59.61	100	0	Peak



Test Mode :	Mode 2	Temperature :	23~25°C
Test Engineer :	Jeff Yao	Relative Humidity :	48~52%
Test Distance :	3m	Polarization :	Vertical
Function Type :	GSM850 Idle + USB Cable (Charging from Adapter) + Bluetooth Idle + WLAN Idle + Earphone + Camera (Back) + SIM2		
Remark :	#7 is system simulator signal which can be ignored.		

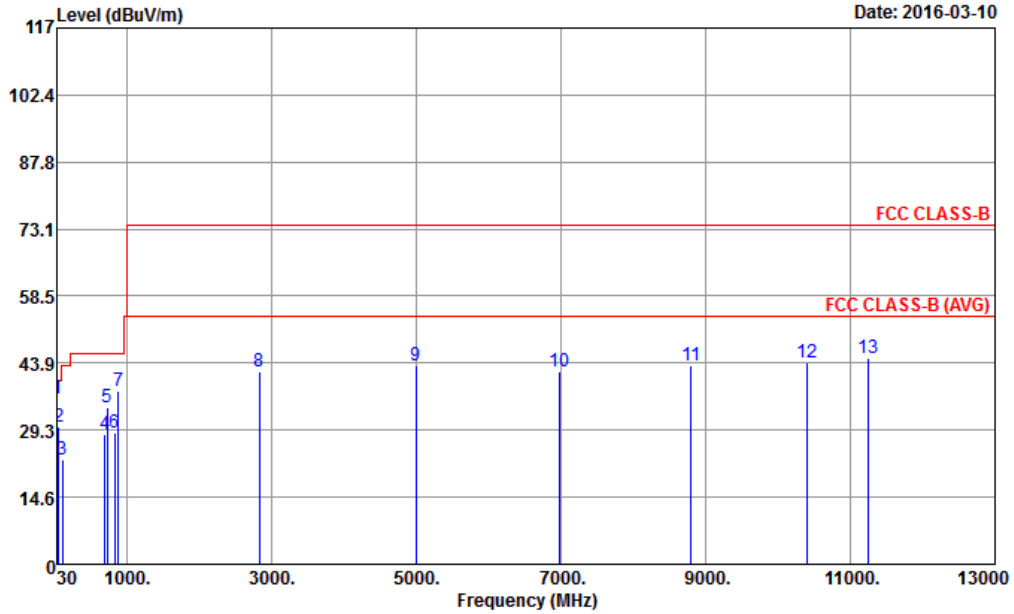

Site : 03CH01-SZ
 Condition : FCC CLASS-B 3m LF_ANT(23188)_151017 VERTICAL
 Project : (FC) 620201
 Mode : Mode 2
 IMEI : 358395070001997/358395070003993

	Freq	Level	Over Limit	Limit Line	ReadAntenna Level	Antenna Factor	Cable Loss	Preamp Factor	A/Pos	T/Pos	Remark
	MHz	dBuV/m	dB	dBuV/m	dBuV	dB/m	dB	dB	cm	deg	
1	37.02	36.23	-3.77	40.00	45.48	16.03	0.75	26.03	100	0	Peak
2	53.76	29.84	-10.16	40.00	45.35	9.48	0.98	25.97	---	---	Peak
3	109.92	22.98	-20.52	43.50	34.49	13.08	1.14	25.73	---	---	Peak
4	696.20	28.42	-17.58	46.00	31.86	20.28	2.65	26.37	---	---	Peak
5	727.70	34.10	-11.90	46.00	36.87	20.90	2.65	26.32	---	---	Peak
6	828.50	28.69	-17.31	46.00	29.58	22.25	2.95	26.09	---	---	Peak
7	881.70	37.73			38.87	21.77	3.02	25.93	---	---	Peak
8	2834.00	41.95	-32.05	74.00	62.46	32.97	5.62	59.10	---	---	Peak
9	4996.00	43.27	-30.73	74.00	59.25	34.50	7.59	58.07	---	---	Peak
10	6984.00	42.16	-31.84	74.00	53.92	36.11	9.30	57.17	---	---	Peak
11	8802.00	43.45	-30.55	74.00	53.85	36.56	10.90	57.86	---	---	Peak
12	10392.00	44.00	-30.00	74.00	52.37	38.41	12.23	59.01	---	---	Peak
13	11252.00	45.12	-28.88	74.00	53.20	39.00	12.58	59.66	100	0	Peak



Test Mode :	Mode 4	Temperature :	23~25°C
Test Engineer :	Jeff Yao	Relative Humidity :	48~52%
Test Distance :	3m	Polarization :	Horizontal
Function Type :	WCDMA Band V Idle + USB Cable (Data Link with Notebook) + Bluetooth Idle + WLAN Idle + Earphone + GPS Rx + SD Card + SIM2		
Remark :	#7 is system simulator signal which can be ignored.		

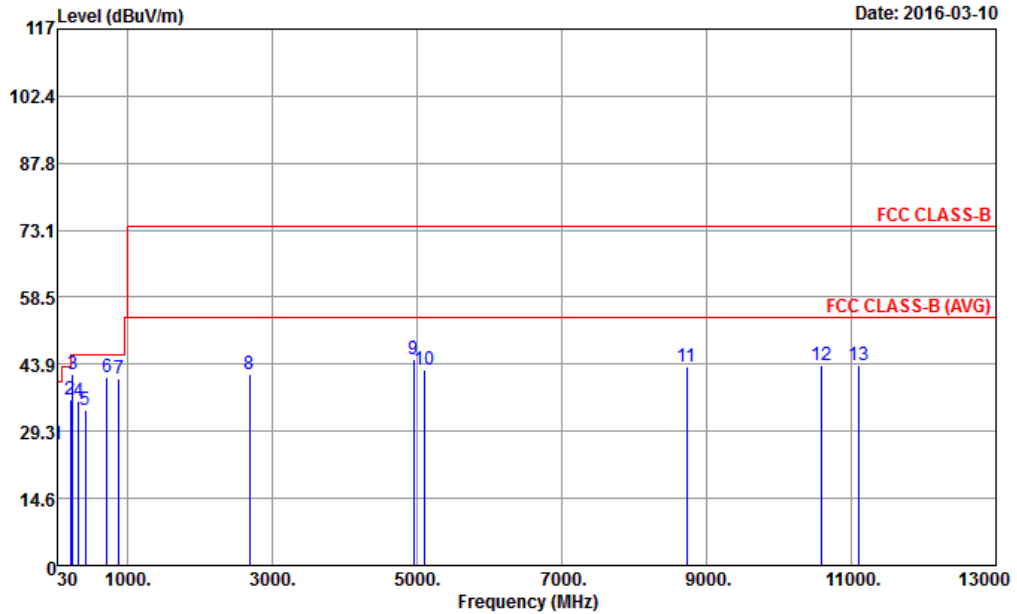

Site : 03CH01-SZ
 Condition : FCC CLASS-B 3m LF35407CBL6112D_6DB HORIZONTAL
 Project : (FC) 620201
 Mode : Mode 4
 IMEI : 358395070001997/358395070003993

	Freq	Level	Over Limit	Limit Line	ReadAntenna Level	Cable Factor	Preamp Loss	A/Pos	T/Pos	Remark
	MHz	dBuV/m	dB	dBuV/m	dBuV	dB/m	dB	cm	deg	
1	30.27	26.39	-13.61	40.00	27.91	23.80	0.75	26.07	---	Peak
2	207.93	36.09	-7.41	43.50	43.24	16.58	1.50	25.23	---	Peak
3	240.06	41.70	-4.30	46.00	47.55	17.77	1.54	25.16	100	0 Peak
4	324.50	35.81	-10.19	46.00	38.77	20.56	1.71	25.23	---	Peak
5	416.20	33.98	-12.02	46.00	35.12	22.68	2.08	25.90	---	Peak
6	720.00	41.03	-4.97	46.00	38.87	25.84	2.65	26.33	---	Peak
7	881.70	40.77			36.55	27.13	3.02	25.93	---	Peak
8	2684.00	41.71	-32.29	74.00	62.47	32.85	5.41	59.02	---	Peak
9	4948.00	44.83	-29.17	74.00	61.21	34.47	7.56	58.41	100	0 Peak
10	5112.00	42.69	-31.31	74.00	57.96	34.64	7.69	57.60	---	Peak
11	8728.00	43.34	-30.66	74.00	53.68	36.48	10.93	57.75	---	Peak
12	10588.00	43.74	-30.26	74.00	51.97	38.55	12.35	59.13	---	Peak
13	11110.00	43.55	-30.45	74.00	51.69	38.89	12.58	59.61	---	Peak



Test Mode :	Mode 4	Temperature :	23~25°C
Test Engineer :	Jeff Yao	Relative Humidity :	48~52%
Test Distance :	3m	Polarization :	Vertical
Function Type :	WCDMA Band V Idle + USB Cable (Data Link with Notebook) + Bluetooth Idle + WLAN Idle + Earphone + GPS Rx + SD Card + SIM2		
Remark :	#6 is system simulator signal which can be ignored.		

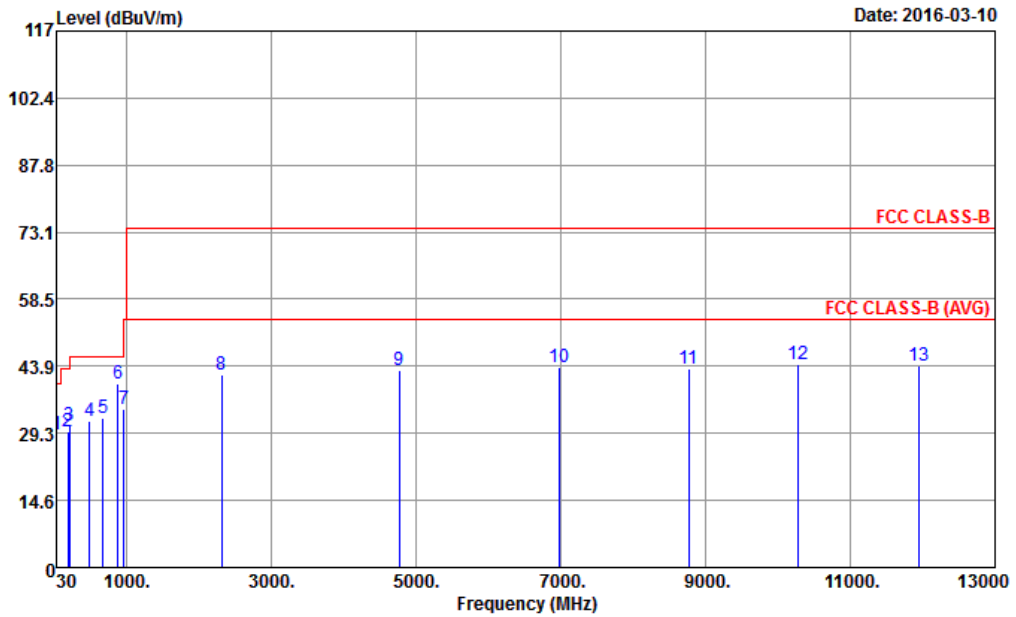

Site : 03CH01-SZ
 Condition : FCC CLASS-B 3m LF35407CBL6112D_6DB VERTICAL
 Project : (FC) 620201
 Mode : Mode 4
 IMEI : 358395070001997/358395070003993

	Freq	Level	Over	Limit	ReadAntenna	Cable	Preamp	A/Pos	T/Pos	Remark
	MHz	dBuV/m	dB	dBuV/m	dBuV	dB/m	dB	dB	cm	deg
1	30.00	28.92	-11.08	40.00	30.44	23.80	0.75	26.07	100	0 Peak
2	184.98	29.67	-13.83	43.50	36.88	16.62	1.50	25.33	---	---
3	207.93	30.96	-12.54	43.50	38.11	16.58	1.50	25.23	---	---
4	492.50	31.85	-14.15	46.00	32.46	23.52	2.17	26.30	---	---
5	674.50	32.68	-13.32	46.00	31.07	25.39	2.61	26.39	---	---
6	881.70	40.22			36.00	27.13	3.02	25.93	---	---
7	960.80	34.67	-19.33	54.00	29.02	27.91	3.15	25.41	---	---
8	2310.00	42.17	-31.83	74.00	63.26	32.51	4.98	58.58	---	---
9	4768.00	43.03	-30.97	74.00	59.85	34.37	7.43	58.62	---	---
10	6984.00	43.60	-30.40	74.00	55.36	36.11	9.30	57.17	---	---
11	8770.00	43.22	-30.78	74.00	53.60	36.52	10.90	57.80	---	---
12	10286.00	44.48	-29.52	74.00	52.93	38.33	12.19	58.97	100	0 Peak
13	11940.00	43.99	-30.01	74.00	52.11	39.47	12.62	60.21	---	---



4. List of Measuring Equipment

Instrument	Manufacturer	Model No.	Serial No.	Characteristics	Calibration Date	Test Date	Due Date	Remark
EMI Test Receiver&SA	Agilent Technologies	N9038A	MY52260185	20Hz~26.5GHz	May 26, 2015	Mar. 10, 2016	May 25, 2016	Radiation (03CH01-SZ)
Spectrum Analyzer	KEYSIGHT	N9010A	MY55150213	10Hz~44GHz;Max 30dBm	Jun. 07, 2015	Mar. 10, 2016	Jun. 06, 2016	Radiation (03CH01-SZ)
Bilog Antenna	TeseQ	CBL6112D	23188	30MHz~2GHz	Oct. 17, 2015	Mar. 10, 2016	Oct. 16, 2016	Radiation (03CH01-SZ)
Double Ridge Horn Antenna	ETS Lindgren	3117	00119436	1GHz~18GHz	Oct. 17, 2015	Mar. 10, 2016	Oct. 16, 2016	Radiation (03CH01-SZ)
Amplifier	HP	8447F	3113A04622	9kHz ~1300MHz / 30 dB	Aug. 07, 2015	Mar. 10, 2016	Aug. 06, 2016	Radiation (03CH01-SZ)
Amplifier	Agilent Technologies	83017A	MY39501302	500MHz~26.5GHz	Jan. 12, 2016	Mar. 10, 2016	Jan. 11, 2017	Radiation (03CH01-SZ)
AC Power Source	Chroma	61601	616010001985	N/A	NCR	Mar. 10, 2016	NCR	Radiation (03CH01-SZ)
Turn Table	EM	EM1000	N/A	0~360 degree	NCR	Mar. 10, 2016	NCR	Radiation (03CH01-SZ)
Antenna Mast	EM	EM1000	N/A	1 m~4 m	NCR	Mar. 10, 2016	NCR	Radiation (03CH01-SZ)
EMI Receiver	R&S	ESC17	100724	9kHz~3GHz;	Nov. 23, 2015	Feb. 03, 2016	Nov. 22, 2016	Conduction (CO01-SZ)
AC LISN	EMCO	3816/2SH	00103892	9kHz~30MHz	Jan. 12, 2016	Feb. 03, 2016	Jan. 11, 2017	Conduction (CO01-SZ)
AC LISN (for auxiliary equipment)	MessTec	3816/2SH	00103912	9kHz~30MHz	Jan. 12, 2016	Feb. 03, 2016	Jan. 11, 2017	Conduction (CO01-SZ)
AC Power Source	Chroma	61602	616020000891	100Vac~250Vac	Aug. 07, 2015	Feb. 03, 2016	Aug. 06, 2016	Conduction (CO01-SZ)
Pulse Limiter	COM-POWER	LIT-153 Transient Limiter	53139	150kHz~30MHz	Oct. 20, 2015	Feb. 03, 2016	Oct. 19, 2016	Conduction (CO01-SZ)

NCR: No Calibration Required



5. Uncertainty of Evaluation

Uncertainty of Conducted Emission Measurement (150 kHz ~ 30 MHz)

Measuring Uncertainty for a Level of Confidence of 95% ($U = 2Uc(y)$)	2.3dB
---	-------

Uncertainty of Radiated Emission Measurement (30 MHz ~ 1000 MHz)

Measuring Uncertainty for a Level of Confidence of 95% ($U = 2Uc(y)$)	4.8dB
---	-------