



FCC Test Report

APPLICANT : Brightstar Corporation
EQUIPMENT : Smartphone
BRAND NAME : mint
MODEL NAME : Mint 135
FCC ID : WVB135M
STANDARD : FCC 47 CFR FCC Part 15 Subpart B
CLASSIFICATION : Certification

The product was received on Sep. 09, 2015 and testing was completed on Sep. 16, 2015. We, SPORTON INTERNATIONAL (SHENZHEN) INC., would like to declare that the tested sample has been evaluated in accordance with the test procedures given in ANSI C63.4-2009 and has been in compliance with the applicable technical standards.

The test results in this report apply exclusively to the tested model / sample. Without written approval of SPORTON INTERNATIONAL (SHENZHEN) INC., the test report shall not be reproduced except in full.

Reviewed by: Louis Wu / Manager

Approved by: Jones Tsai / Manager



Testing Laboratory
2353

SPORTON INTERNATIONAL (SHENZHEN) INC.

**1F & 2F, Building A, Morning Business Center, No. 4003 ShiGu Rd., Xili Town,
Nanshan District, Shenzhen, Guangdong, P. R. China**



TABLE OF CONTENTS

REVISION HISTORY.....	3
SUMMARY OF TEST RESULT	4
1. GENERAL DESCRIPTION	5
1.1. Applicant.....	5
1.2. Manufacturer	5
1.3. Product Feature of Equipment Under Test	5
1.4. Product Specification subjective to this standard.....	6
1.5. Modification of EUT.....	7
1.6. Test Location.....	7
1.7. Applicable Standards	7
2. TEST CONFIGURATION OF EQUIPMENT UNDER TEST.....	8
2.1. Test Mode	8
2.2. Connection Diagram of Test System	10
2.3. Support Unit used in test configuration and system.....	11
2.4. EUT Operation Test Setup.....	12
3. TEST RESULT.....	13
3.1. Test of AC Conducted Emission Measurement	13
3.2. Test of Radiated Emission Measurement	19
4. LIST OF MEASURING EQUIPMENT	23
5. UNCERTAINTY OF EVALUATION	24
APPENDIX A. SETUP PHOTOGRAPHS	



SUMMARY OF TEST RESULT

Report Section	FCC Rule	Description	Limit	Result	Remark
3.1	15.107	AC Conducted Emission	< 15.107 limits	PASS	Under limit 17.04 dB at 0.520 MHz
3.2	15.109	Radiated Emission	< 15.109 limits	PASS	Under limit 4.32 dB at 240.060 MHz for Quasi-Peak



1. General Description

1.1. Applicant

Brightstar Corporation

9725 NW 117th Ave., Miami, Florida, FL 33178, United States

1.2. Manufacturer

KCMobile Co., Ltd

#1305-1, Kolon Digital Tower Villant II, 31, Digital-ro 30-gil, Guro-Gu, Seoul, KOREA (152-727)

1.3. Product Feature of Equipment Under Test

Product Feature	
Equipment	Smartphone
Brand Name	mint
Model Name	Mint 135
FCC ID	WVB135M
EUT supports Radios application	GSM/GPRS/WCDMA/HSPA/HSPA+(Downlink Only) WLAN2.4GHz 802.11b/g/n HT20/HT40 Bluetooth v3.0+EDR Bluetooth v4.0 LE
IMEI Code	Conduction: 353041070004285/353041070004293 Radiation: 353041070004368/353041070004376
HW Version	Y721_MB_V1
SW Version	Mint.135S.OC.W25.V01
EUT Stage	Production Unit

Remark:

1. The above EUT's information was declared by manufacturer. Please refer to the specifications or user's manual for more detailed description.
2. There are two types of EUT, sample 1 is dual SIM card, sample 2 is single SIM card. The others are the same including circuit design, PCB board, structure and all components. It is special to declare. After pre-scan two types of EUT, we found test result of the sample that dual SIM was the worst, so we choose dual SIM card mobile to perform all test.



1.4. Product Specification subjective to this standard

Product Specification subjective to this standard	
Tx Frequency	GSM850 : 824.2 MHz ~ 848.8 MHz GSM1900 : 1850.2 MHz ~ 1909.8MHz WCDMA Band V : 826.4 MHz ~ 846.6 MHz WCDMA Band II : 1852.4 MHz ~ 1907.6 MHz 802.11b/g/n: 2412 MHz ~ 2462 MHz Bluetooth: 2402 MHz ~ 2480 MHz
Rx Frequency	GSM850 : 869.2 MHz ~ 893.8 MHz GSM1900 : 1930.2 MHz ~ 1989.8 MHz WCDMA Band V : 871.4 MHz ~ 891.6 MHz WCDMA Band II : 1932.4 MHz ~ 1987.6 MHz 802.11b/g/n: 2412 MHz ~ 2462 MHz Bluetooth: 2402 MHz ~ 2480 MHz GPS : 1.57542 GHz
Antenna Type	WWAN : PIFA Antenna WLAN : PIFA Antenna Bluetooth : PIFA Antenna GPS : PIFA Antenna
Type of Modulation	GSM: GMSK GPRS: GMSK WCDMA: QPSK (Uplink) HSDPA: QPSK (Uplink) HSUPA: QPSK (Uplink) HSPA+: 16QAM (Downlink Only) 802.11b : DSSS (DBPSK / DQPSK / CCK) 802.11g/n : OFDM (BPSK / QPSK / 16QAM / 64QAM) Bluetooth LE : GFSK Bluetooth (1Mbps) : GFSK Bluetooth (2Mbps) : $\pi/4$ -DQPSK Bluetooth (3Mbps) : 8-DPSK GPS : BPSK



1.5. Modification of EUT

No modifications are made to the EUT during all test items.

1.6. Test Location

Test Site	SPORTON INTERNATIONAL (SHENZHEN) INC.	
Test Site Location	1F & 2F, Building A, Morning Business Center, No. 4003 ShiGu Rd., Xili Town, Nanshan District, Shenzhen, Guangdong, P. R. China TEL: +86-755-8637-9589 FAX: +86-755-8637-9595	
Test Site No.	Sporton Site No.	
	CO01-SZ	

Test Site	SPORTON INTERNATIONAL (SHENZHEN) INC.	
Test Site Location	No. 3 Building, the third floor of south, Shahe River west, Fengzeyuan warehouse, Nanshan District, Shenzhen, Guangdong, P. R. China TEL: +86-755- 3320-2398	
Test Site No.	Sporton Site No.	FCC Registration No.
	03CH01-SZ	831040

Note: The test site complies with ANSI C63.4 2009 requirement.

1.7. Applicable Standards

According to the specifications of the manufacturer, the EUT must comply with the requirements of the following standards:

- ♦ FCC 47 CFR FCC Part 15 Subpart B
- ♦ ANSI C63.4-2009

Remark: All test items were verified and recorded according to the standards and without any deviation during the test.

2. Test Configuration of Equipment Under Test

2.1. Test Mode

The EUT has been associated with peripherals pursuant to ANSI C63.4-2009 and configuration operated in a manner tended to maximize its emission characteristics in a typical application.

Frequency range investigated: conduction (150 kHz to 30 MHz), radiation (30MHz to the 5th harmonic of the highest fundamental frequency or to 40 GHz, whichever is lower).

The following tables are showing the test modes as the worst cases and recorded in this report.

Item	EUT Configuration	Test Condition		
		EMI AC	EMI RE<1G	EMI RE≥1G
1.	Charging Mode (EUT with adapter)	☒	☒	Note 1
2.	Data application transferred mode (EUT connected with notebook)	☒	☒	☒

Abbreviations:

- EMI AC: AC conducted emissions
- EMI RE ≥ 1G: EUT radiated emissions ≥ 1GHz
- EMI RE < 1G: EUT radiated emissions < 1GHz

Note 1: Testing for this mode is not required or not the worst case.

Remark: For signal above 1GHz, the worst case was test item 2.

Test Items	EUT Configure Mode	Function Type
AC Conducted Emission	1/2	Mode 1: GSM850 Idle + Bluetooth Idle + WLAN Idle + USB Cable (Charging from Adapter) + Battery + Earphone + MPEG4 + SIM 1<Fig.1> Mode 2: WCDMA Band II Idle + Bluetooth Idle + WLAN Idle + USB Cable (Charging from Adapter) + Battery + Earphone + Camera + SIM2<Fig.1> Mode 3: GSM1900 Idle + Bluetooth Idle + WLAN Idle + USB Cable (Data Link with Notebook) + Battery + Earphone + GPS Rx + SD Card + SIM 1<Fig.2>
Radiated Emissions < 1GHz	1/2	Mode 1: GSM850 Idle + Bluetooth Idle + WLAN Idle + USB Cable (Charging from Adapter) + Battery + Earphone + MPEG4 + SIM 1<Fig.1> Mode 2: WCDMA Band II Idle + Bluetooth Idle + WLAN Idle + USB Cable (Charging from Adapter) + Battery + Earphone + Camera + SIM2<Fig.1> Mode 3: GSM1900 Idle + Bluetooth Idle + WLAN Idle + USB Cable (Data Link with Notebook) + Battery + Earphone + GPS Rx + SD Card + SIM 1<Fig.2>
Radiated Emissions ≥ 1GHz	2	Mode 1: GSM1900 Idle + Bluetooth Idle + WLAN Idle + USB Cable (Data Link with Notebook) + Battery + Earphone + GPS Rx + SD Card + SIM 1<Fig.2>
<p>Remark:</p> <ol style="list-style-type: none"> The worst case of AC is mode 1; and the USB Link mode of AC is mode 3, the test data of these modes were reported. The worst case of RE < 1G is mode 3; only the test data of this mode was reported. Link with Notebook means data application transferred mode between EUT and Notebook. 		

2.2. Connection Diagram of Test System

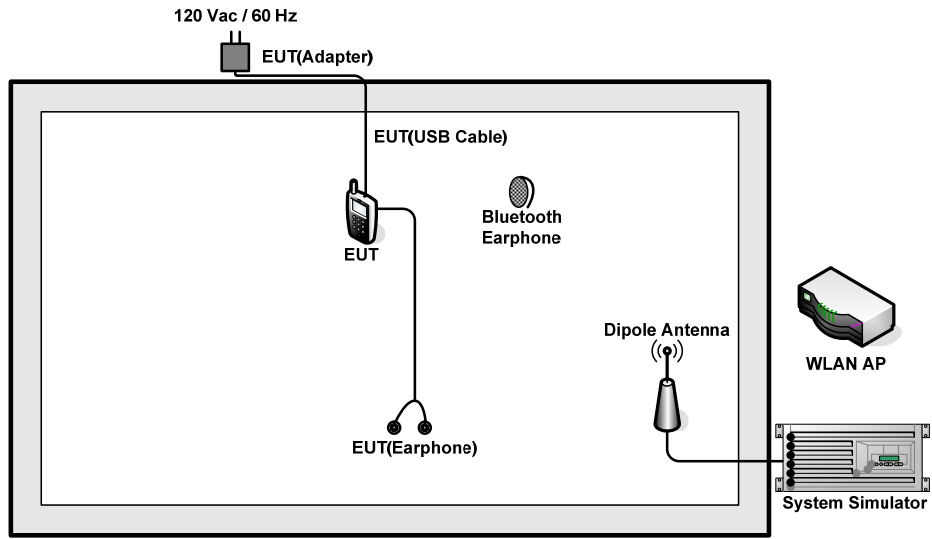

<Fig.1>

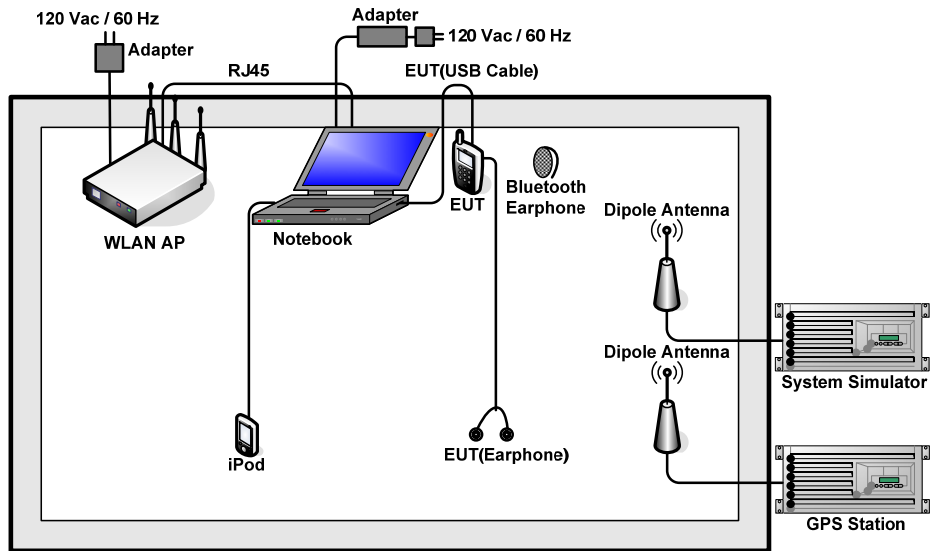

<Fig.2>



2.3. Support Unit used in test configuration and system

Item	Equipment	Trade Name	Model Name	FCC ID	Data Cable	Power Cord
1.	System Simulator	Anritsu	MT8820C	N/A	N/A	Unshielded, 1.8 m
2.	GPS Station	ADIVIC	MP9000	N/A	N/A	Unshielded, 1.8 m
3.	WLAN AP	ASUSTek	RT-AC66U	MSQ-RTAC66U	N/A	Unshielded, 2.7 m
4.	WLAN AP	D-Link	DIR-628	KA2DIR628A2	N/A	Unshielded, 1.8 m
5.	Bluetooth Earphone	Nokia	BH-108	PYAHS-107W	N/A	N/A
6.	Notebook	Lenovo	E540	FCC DoC	N/A	AC I/P: Unshielded, 1.2 m DC O/P: Shielded, 1.8 m
7.	SD Card	SanDisk	4G class 4	FCC DoC	N/A	N/A
8.	iPod nano 8GB	Apple	MC690 ZP/A	FCC DoC	Shielded, 1.2 m	N/A
9.	iPod	Apple	MC525 ZP/A	FCC DoC	Shielded, 1.0 m	N/A



2.4. EUT Operation Test Setup

The EUT was in GSM or WCDMA idle mode during the testing. The EUT was synchronized to the BCCH, and was in continuous receiving mode by setting system simulator's paging reorganization.

At the same time, the EUT was attached to the Bluetooth earphone or WLAN AP, and the following programs installed in the EUT were programmed during the test.

1. Data application is transferred between Notebook and EUT via USB cable.
2. Turn on GPS function to make the EUT receive continuous signals from GPS station.
3. Execute "Video player" to play MPEG4 files.
4. Turn on camera to capture images.



3. Test Result

3.1. Test of AC Conducted Emission Measurement

3.1.1 Limits of AC Conducted Emission

For equipment that is designed to be connected to the public utility (AC) power line, the radio frequency voltage that is conducted back onto the AC power line on any frequency or frequencies within the band 150 kHz to 30 MHz shall not exceed the limits in the following table.

Frequency of emission (MHz)	Conducted limit (dBuV)	
	Quasi-peak	Average
0.15-0.5	66 to 56*	56 to 46*
0.5-5	56	46
5-30	60	50

*Decreases with the logarithm of the frequency.

3.1.2 Measuring Instruments

The measuring equipment is listed in the section 4 of this test report.

3.1.3 Test Procedure

1. The EUT was placed 0.4 meter from the conducting wall of the shielding room was kept at least 80 centimeters from any other grounded conducting surface.
2. Connect EUT to the power mains through a line impedance stabilization network (LISN).
3. All the support units are connecting to the other LISN.
4. The LISN provides 50 ohm coupling impedance for the measuring instrument.
5. The FCC states that a 50 ohm, 50 microhenry LISN should be used.
6. Both sides of AC line were checked for maximum conducted interference.
7. The frequency range from 150 kHz to 30 MHz was searched.
8. Set the test-receiver system to Peak Detect Function and specified bandwidth (IF Bandwidth = 9kHz) with Maximum Hold Mode. Then measurement is also conducted by Average Detector and Quasi-Peak Detector Function respectively.

3.1.4 Test Setup

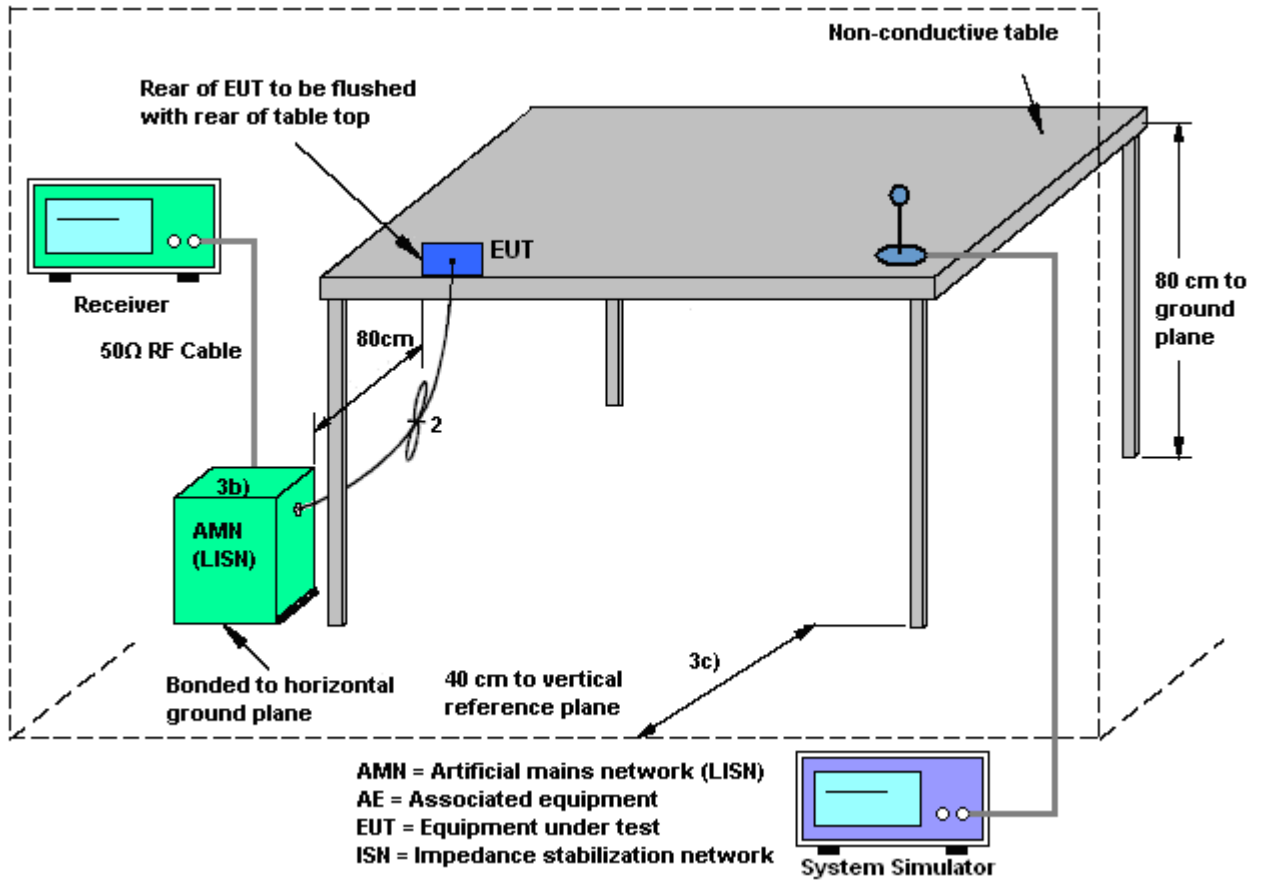



3.1.5 Test Result of AC Conducted Emission

Test Mode :	Mode 1	Temperature :	21~23°C
Test Engineer :	Jacky Yang	Relative Humidity :	41~43%
Test Voltage :	120Vac / 60Hz	Phase :	Line
Function Type :	GSM850 Idle + Bluetooth Idle + WLAN Idle + USB Cable (Charging from Adapter) + Battery + Earphone + MPEG4 + SIM 1		

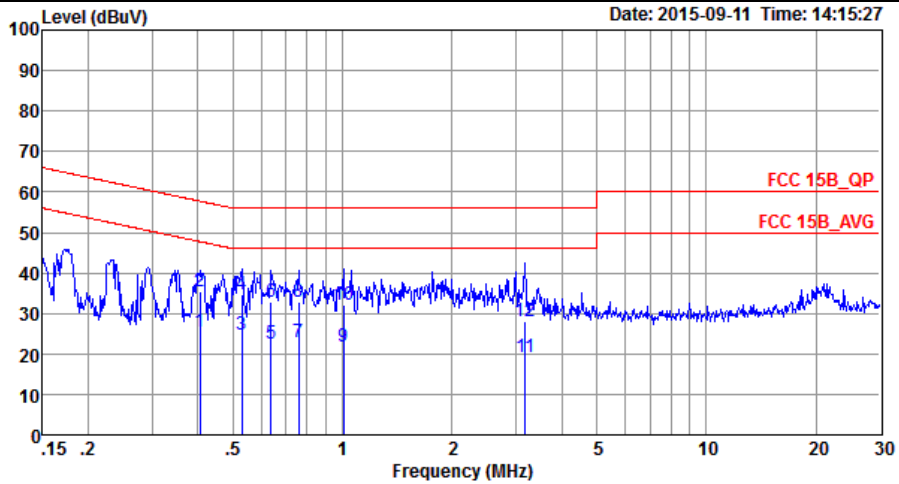

Site : C001-SZ
 Condition: FCC 15B_QP LISN_L_20150304 LINE
 Project : (FC)590902
 Mode : Mode 1
 IMEI : 353041070004285/353041070004293

	Freq	Level	Over Limit	Limit Line	Read Level	LISN Factor	Cable Loss	Remark
	MHz	dBuV		dB	dBuV	dB	dB	
1	0.41	25.62	-22.11	47.73	14.90	0.55	10.17	Average
2	0.41	35.52	-22.21	57.73	24.80	0.55	10.17	QP
3 *	0.53	24.90	-21.10	46.00	14.10	0.65	10.15	Average
4	0.53	34.80	-21.20	56.00	24.00	0.65	10.15	QP
5	0.64	22.43	-23.57	46.00	11.70	0.58	10.15	Average
6	0.64	32.83	-23.17	56.00	22.10	0.58	10.15	QP
7	0.76	22.78	-23.22	46.00	12.10	0.53	10.15	Average
8	0.76	32.88	-23.12	56.00	22.20	0.53	10.15	QP
9	1.00	21.66	-24.34	46.00	11.00	0.51	10.15	Average
10	1.00	31.96	-24.04	56.00	21.30	0.51	10.15	QP
11	3.17	19.07	-26.93	46.00	8.30	0.56	10.21	Average
12	3.17	28.17	-27.83	56.00	17.40	0.56	10.21	QP



Test Mode :	Mode 1	Temperature :	21~23°C
Test Engineer :	Jacky Yang	Relative Humidity :	41~43%
Test Voltage :	120Vac / 60Hz	Phase :	Neutral
Function Type :	GSM850 Idle + Bluetooth Idle + WLAN Idle + USB Cable (Charging from Adapter) + Battery + Earphone + MPEG4 + SIM 1		

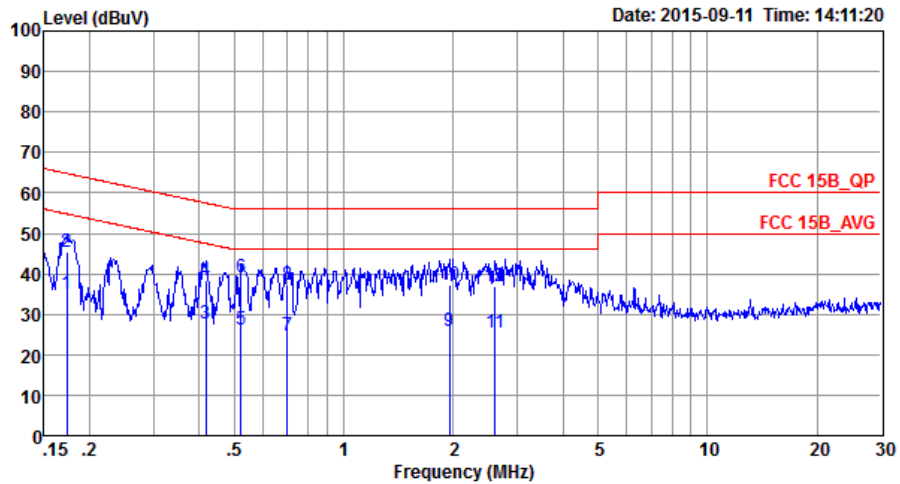

Site : C001-SZ
 Condition: FCC 15B_QP LISN_N_20150304 NEUTRAL
 Project : (FC)590902
 Mode : Mode 1
 IMEI : 353041070004285/353041070004293

	Freq	Level	Over Limit	Limit Line	Read Level	LISN Factor	Cable Loss	Remark
	MHz	dBuV		dB	dBuV		dB	
1	0.17	35.21	-19.60	54.81	24.40	0.48	10.33	Average
2	0.17	45.31	-19.50	64.81	34.50	0.48	10.33	QP
3	0.42	27.73	-19.78	47.51	17.00	0.56	10.17	Average
4	0.42	38.23	-19.28	57.51	27.50	0.56	10.17	QP
5	0.52	26.06	-19.94	46.00	15.31	0.60	10.15	Average
6 *	0.52	38.96	-17.04	56.00	28.21	0.60	10.15	QP
7	0.70	24.70	-21.30	46.00	14.00	0.55	10.15	Average
8	0.70	37.10	-18.90	56.00	26.40	0.55	10.15	QP
9	1.95	25.86	-20.14	46.00	15.10	0.57	10.19	Average
10	1.95	37.26	-18.74	56.00	26.50	0.57	10.19	QP
11	2.61	25.30	-20.70	46.00	14.51	0.59	10.20	Average
12	2.61	36.90	-19.10	56.00	26.11	0.59	10.20	QP



Test Mode :	Mode 3	Temperature :	21~23°C
Test Engineer :	Jacky Yang	Relative Humidity :	41~43%
Test Voltage :	120Vac / 60Hz	Phase :	Line
Function Type :	GSM1900 Idle + Bluetooth Idle + WLAN Idle + USB Cable (Data Link with Notebook) + Battery + Earphone + GPS Rx + SD Card + SIM 1		

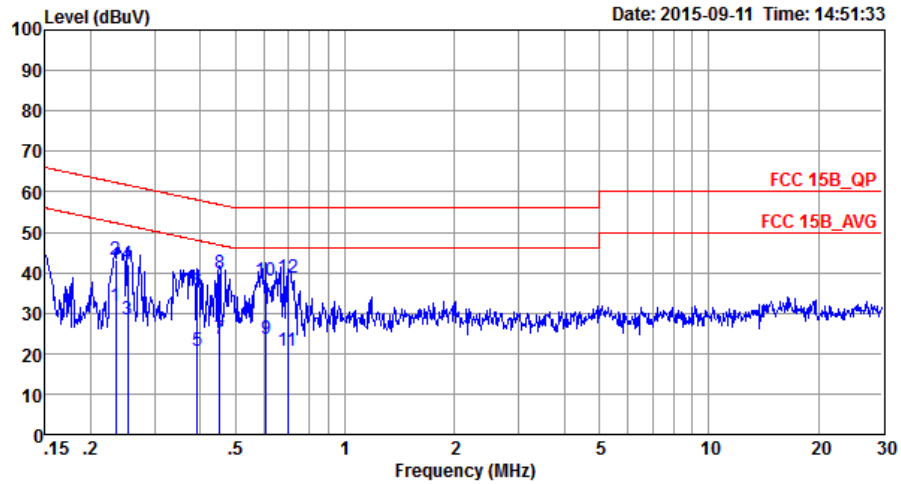

Site : CO01-SZ
 Condition: FCC 15B_QP LISN_L_20150304 LINE
 Project : (FC)590902
 Mode : Mode 3
 IMEI : 353041070004285/353041070004293

	Freq	Level	Over Limit	Limit Line	Read Level	LISN Factor	Cable Loss	Remark
	MHz	dBuV	dB	dBuV	dBuV	dB	dB	
1	0.23	31.80	-20.50	52.30	21.00	0.54	10.26	Average
2	0.23	43.10	-19.20	62.30	32.30	0.54	10.26	QP
3	0.25	28.39	-23.25	51.64	17.60	0.55	10.24	Average
4	0.25	41.99	-19.65	61.64	31.20	0.55	10.24	QP
5	0.39	20.51	-27.48	47.99	9.80	0.54	10.17	Average
6	0.39	35.51	-22.48	57.99	24.80	0.54	10.17	QP
7	0.45	23.47	-23.38	46.85	12.70	0.61	10.16	Average
8	0.45	39.67	-17.18	56.85	28.90	0.61	10.16	QP
9	0.61	23.75	-22.25	46.00	13.00	0.60	10.15	Average
10	0.61	37.85	-18.15	56.00	27.10	0.60	10.15	QP
11	0.70	20.79	-25.21	46.00	10.10	0.54	10.15	Average
12 *	0.70	38.89	-17.11	56.00	28.20	0.54	10.15	QP



Test Mode :	Mode 3	Temperature :	21~23°C
Test Engineer :	Jacky Yang	Relative Humidity :	41~43%
Test Voltage :	120Vac / 60Hz	Phase :	Neutral
Function Type :	GSM1900 Idle + Bluetooth Idle + WLAN Idle + USB Cable (Data Link with Notebook) + Battery + Earphone + GPS Rx + SD Card + SIM 1		

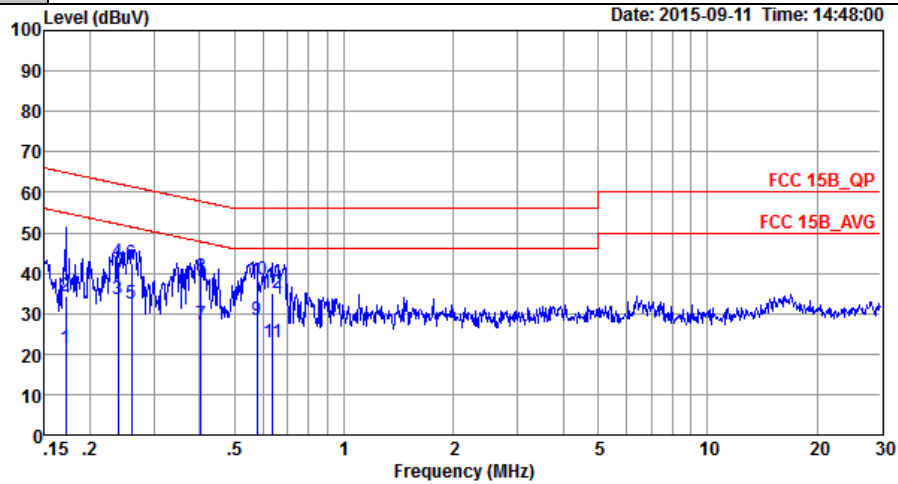

Site : CO01-SZ
 Condition: FCC 15B_QP LISN_N_20150304 NEUTRAL
 Project : (FC)590902
 Mode : Mode 3
 IMEI : 353041070004285/353041070004293

	Freq	Level	Over Limit	Limit Line	Read Level	LISN Factor	Cable Loss	Remark
	MHz	dBuV	dB	dBuV	dBuV	dB	dB	
1	0.17	21.41	-33.49	54.90	10.60	0.48	10.33	Average
2	0.17	34.39	-30.51	64.90	23.58	0.48	10.33	QP
3	0.24	33.40	-18.73	52.13	22.60	0.55	10.25	Average
4	0.24	42.80	-19.33	62.13	32.00	0.55	10.25	QP
5	0.26	32.50	-18.92	51.42	21.71	0.56	10.23	Average
6	0.26	42.40	-19.02	61.42	31.61	0.56	10.23	QP
7	0.40	27.22	-20.55	47.77	16.50	0.55	10.17	Average
8	0.40	39.12	-18.65	57.77	28.40	0.55	10.17	QP
9	0.58	28.24	-17.76	46.00	17.51	0.58	10.15	Average
10 *	0.58	38.54	-17.46	56.00	27.81	0.58	10.15	QP
11	0.64	22.82	-23.18	46.00	12.10	0.57	10.15	Average
12	0.64	35.12	-20.88	56.00	24.40	0.57	10.15	QP



3.2. Test of Radiated Emission Measurement

3.2.1. Limit of Radiated Emission

The emissions from an unintentional radiator shall not exceed the field strength levels specified in the following table:

Frequency (MHz)	Field Strength (microvolts/meter)	Measurement Distance (meters)
30 – 88	100	3
88 – 216	150	3
216 - 960	200	3
Above 960	500	3

3.2.2. Measuring Instruments

The measuring equipment is listed in the section 4 of this test report.

3.2.3. Test Procedures

1. The EUT was placed on a turntable with 0.8 meter above ground.
2. The EUT was set 3 meters from the interference receiving antenna, which was mounted on the top of a variable height antenna tower.
3. The table was rotated 360 degrees to determine the position of the highest radiation.
4. The antenna is a Bi-Log antenna and its height is adjusted between one to four meters above ground to find the maximum value of the field strength for both horizontal polarization and vertical polarization of the antenna.
5. For each suspected emission, the EUT was arranged to its worst case and then tune the antenna tower (from 1 m to 4 m) and turntable (from 0 degree to 360 degrees) to find the maximum reading.
6. Set the test-receiver system to Peak Detect Function and specified bandwidth with Maximum Hold Mode (RBW=120kHz/VBW=300kHz for frequency below 1GHz; RBW=1MHz VBW=3MHz (Peak), RBW=1MHz/VBW=10Hz (Average) for frequency above 1GHz).
7. If the emission level of the EUT in peak mode was 3 dB lower than the limit specified, peak values of EUT will be reported. Otherwise, the emission will be repeated by using the quasi-peak method and reported.
8. Emission level (dB μ V/m) = 20 log Emission level (μ V/m)
9. Corrected Reading: Antenna Factor + Cable Loss + Read Level - Preamp Factor = Level

3.2.4. Test Setup of Radiated Emission

For radiated emissions from 30MHz to 1GHz

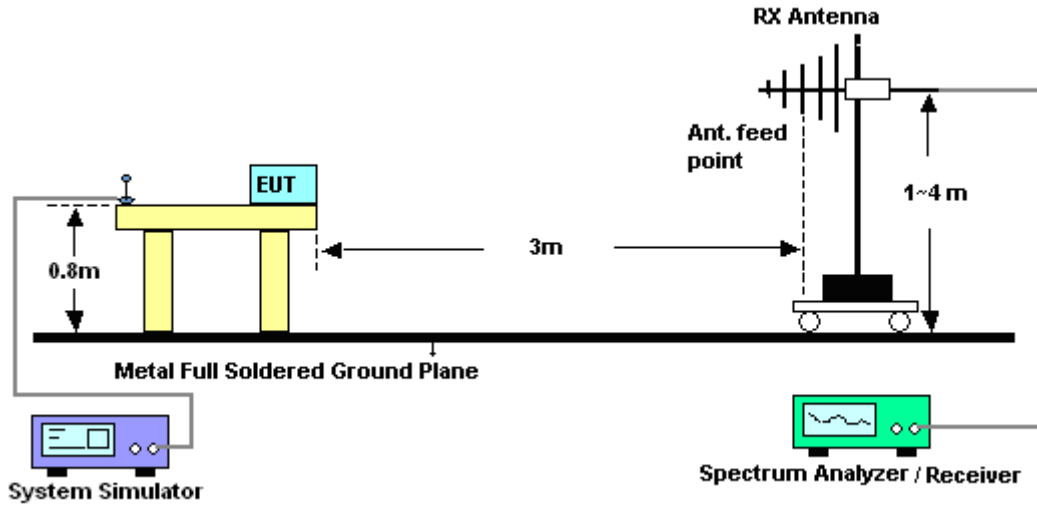

For radiated emissions above 1GHz

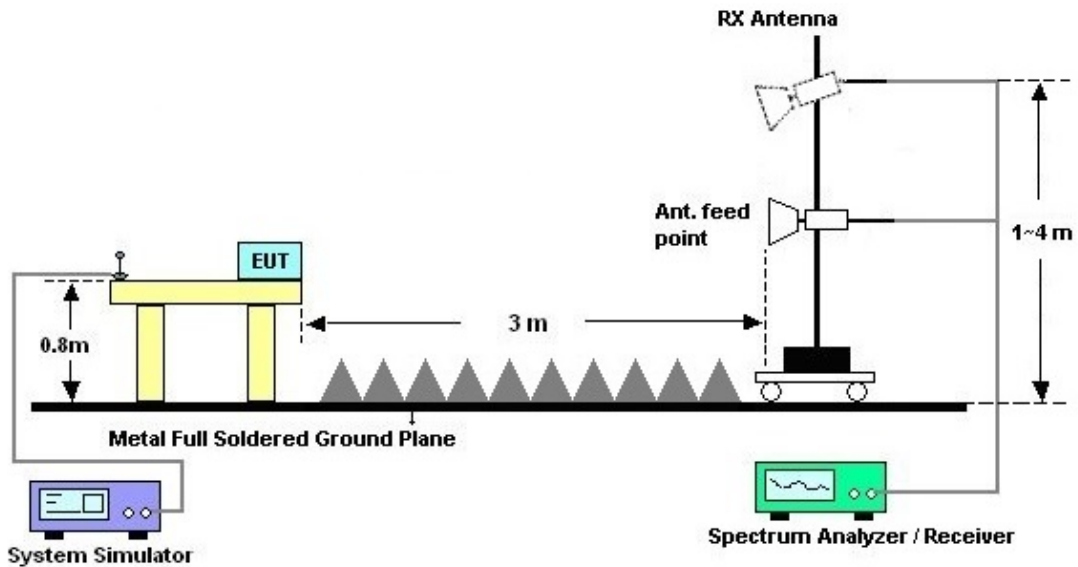



3.2.5. Test Result of Radiated Emission

Test Mode :	Mode 3	Temperature :	23~25°C
Test Engineer :	Kaer Huang	Relative Humidity :	48~52%
Test Distance :	3m	Polarization :	Horizontal
Function Type :	GSM1900 Idle + Bluetooth Idle + WLAN Idle + USB Cable (Data Link with Notebook) + Battery + Earphone + GPS Rx + SD Card + SIM 1		
Remark :	#7 is system simulator signal which can be ignored.		

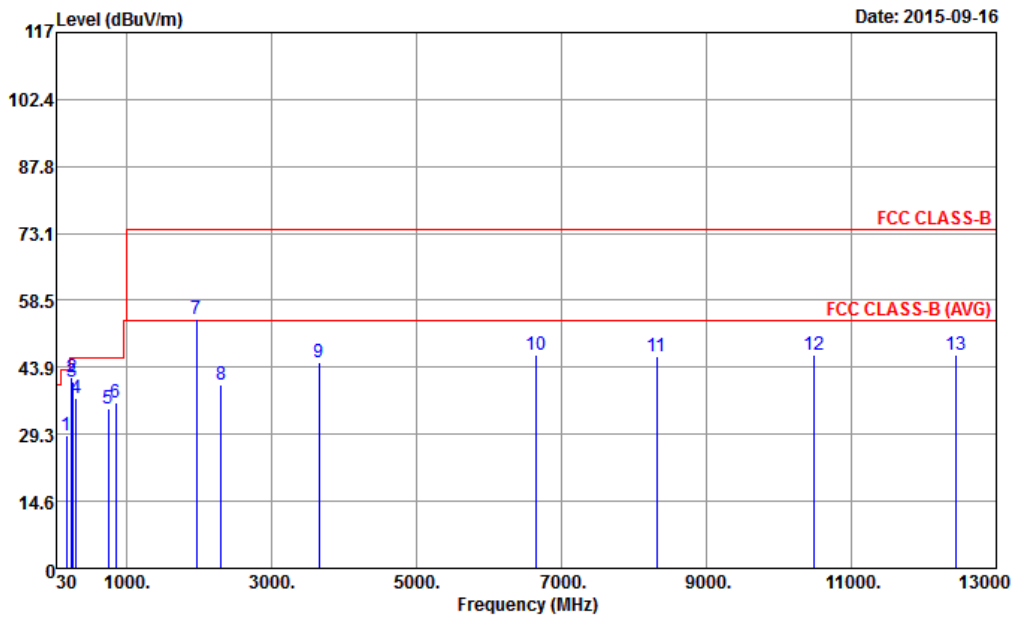

Site : 03CH01-SZ
 Condition : FCC CLASS-B 3m LF_ANT_141107 HORIZONTAL
 Project : (FC) 590902
 Mode : Mode 3

	Freq	Level	Over Limit	Limit Line	ReadAntenna Level	Antenna Factor	Cable Loss	Preamp Factor	A/Pos	T/Pos	Remark
	MHz	dBuV/m	dB	dBuV/m	dBuV	dB/m	dB	dB	cm	deg	
1	165.27	29.10	-14.40	43.50	40.60	12.03	1.91	25.44	---	---	Peak
2	240.06	41.68	-4.32	46.00	52.24	12.25	2.35	25.16	100	105	QP
3	249.78	40.79	-5.21	46.00	51.13	12.40	2.40	25.14	---	---	Peak
4	300.00	37.13	-8.87	46.00	45.42	14.10	2.65	25.04	---	---	Peak
5	749.40	34.77	-11.23	46.00	34.85	21.39	4.80	26.27	---	---	Peak
6	849.50	36.20	-9.80	46.00	34.94	22.05	5.23	26.02	---	---	Peak
7	1960.00	54.52			64.16	31.74	9.63	51.01	---	---	Peak
8	2300.00	40.08	-33.92	74.00	47.57	32.49	10.69	50.67	---	---	Peak
9	3652.00	45.03	-28.97	74.00	48.45	33.56	13.84	50.82	---	---	Peak
10	6648.00	46.57	-27.43	74.00	44.14	36.24	16.66	50.47	---	---	Peak
11	8318.00	46.30	-27.70	74.00	41.85	36.31	17.88	49.74	---	---	Peak
12	10482.00	46.60	-27.40	74.00	40.17	38.49	18.34	50.40	---	---	Peak
13	12452.00	46.70	-27.30	74.00	38.87	39.31	18.29	49.77	100	20	Peak



Test Mode :	Mode 3	Temperature :	23~25°C
Test Engineer :	Kaer Huang	Relative Humidity :	48~52%
Test Distance :	3m	Polarization :	Vertical
Function Type :	GSM1900 Idle + Bluetooth Idle + WLAN Idle + USB Cable (Data Link with Notebook) + Battery + Earphone + GPS Rx + SD Card + SIM 1		
Remark :	#7 is system simulator signal which can be ignored.		

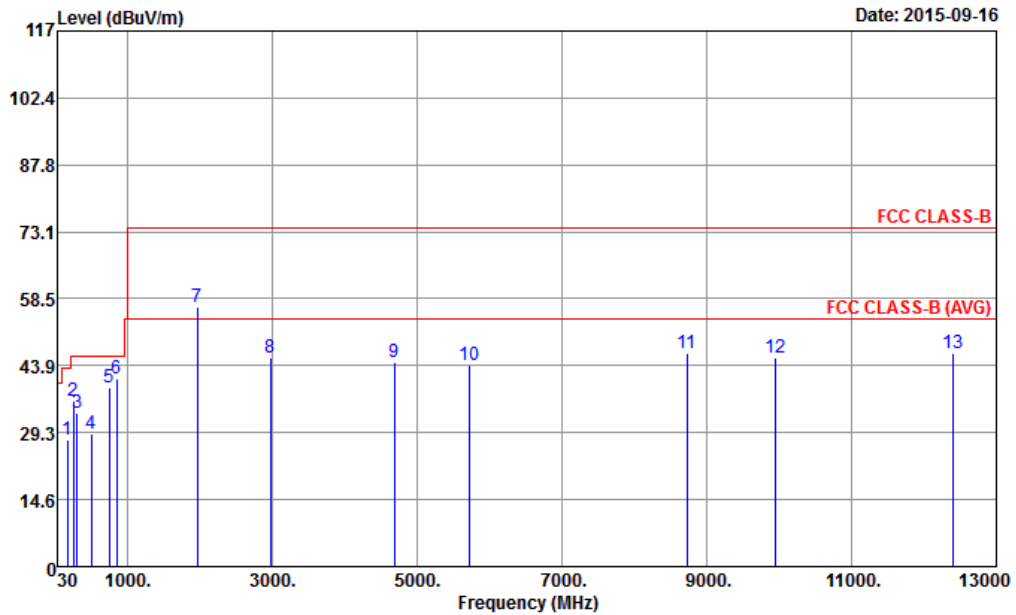

Site : 03CH01-SZ
 Condition : FCC CLASS-B 3m LF_ANT_141107 VERTICAL
 Project : (FC) 590902

	Freq	Level	Over Limit	Limit Line	ReadAntenna Level	Antenna Factor	Cable Loss	Preamp Factor	A/Pos	T/Pos	Remark
	MHz	dBuV/m	dB	dBuV/m	dBuV	dB/m	dB	dB	cm	deg	
1	166.08	27.64	-15.86	43.50	39.15	12.00	1.92	25.43	---	---	Peak
2	249.78	36.30	-9.70	46.00	46.64	12.40	2.40	25.14	---	---	Peak
3	298.92	33.65	-12.35	46.00	41.97	14.07	2.65	25.04	---	---	Peak
4	498.10	28.84	-17.16	46.00	32.21	19.32	3.64	26.33	---	---	Peak
5	749.40	39.02	-6.98	46.00	39.10	21.39	4.80	26.27	---	---	Peak
6	849.50	41.07	-4.93	46.00	39.81	22.05	5.23	26.02	100	20	Peak
7	1960.00	56.59			66.23	31.74	9.63	51.01	---	---	Peak
8	2970.00	45.47	-28.53	74.00	50.43	33.07	12.87	50.90	---	---	Peak
9	4682.00	44.51	-29.49	74.00	46.13	34.31	15.25	51.18	---	---	Peak
10	5730.00	44.00	-30.00	74.00	41.96	35.41	16.09	49.46	---	---	Peak
11	8726.00	46.66	-27.34	74.00	41.81	36.46	17.95	49.56	---	---	Peak
12	9938.00	45.52	-28.48	74.00	38.41	38.04	18.99	49.92	---	---	Peak
13	12392.00	46.69	-27.31	74.00	39.01	39.34	18.14	49.80	125	90	Peak



4. List of Measuring Equipment

Instrument	Manufacturer	Model No.	Serial No.	Characteristics	Calibration Date	Test Date	Due Date	Remark
EMI Receiver	R&S	ESCI7	100724	9kHz~3GHz;	Jan. 28, 2015	Sep. 11, 2015	Jan. 27, 2016	Conduction (CO01-SZ)
AC LISN	EMCO	3816/2SH	103892	9kHz~30MHz	Feb. 02, 2015	Sep. 11, 2015	Feb. 01, 2016	Conduction (CO01-SZ)
AC LISN (for auxiliary equipment)	MessTec	AN3016	16850	9kHz~30MHz	Feb. 02, 2015	Sep. 11, 2015	Feb. 01, 2016	Conduction (CO01-SZ)
AC Power Source	Chroma	61602	61602000089 1	100Vac~250Vac	Aug. 07, 2015	Sep. 11, 2015	Aug. 06, 2016	Conduction (CO01-SZ)
Pulse Limiter	COM-POWER	LIT-153 Transient Limiter	53139	150kHz~30MHz	Oct. 24, 2014	Sep. 11, 2015	Oct. 23, 2015	Conduction (CO01-SZ)
EMI Test Receiver&SA	Agilent Technologies	N9038A	MY52260185	20Hz~26.5GHz	May 26, 2015	Sep. 16, 2015	May 25, 2016	Radiation (03CH01-SZ)
Spectrum Analyzer	R&S	FSV40	101041	10kHz~40GHz; Max 30dBm	Oct. 15, 2014	Sep. 16, 2015	Oct. 14, 2015	Radiation (03CH01-SZ)
Bilog Antenna	TeseQ	CBL6112D	23188	30MHz~2GHz	Nov. 07, 2014	Sep. 16, 2015	Nov. 06, 2015	Radiation (03CH01-SZ)
Double Ridge Horn Antenna	ETS-Lindgren	3117	00119436	1GHz~18GHz	Oct. 15, 2014	Sep. 16, 2015	Oct. 14, 2015	Radiation (03CH01-SZ)
Amplifier	ADVANTEST	BB525C	E9007003	9kHz~3000MHz / 30 dB	Jan. 28, 2015	Sep. 16, 2015	Jan. 27, 2016	Radiation (03CH01-SZ)
Amplifier	Yiai	AV3860B	04030	2GHz~26.5GHz	May 05, 2015	Sep. 16, 2015	May 04, 2016	Radiation (03CH01-SZ)
Amplifier	Agilent Technologies	83017A	MY39501302	500MHz~26.5G Hz	Jan. 28, 2015	Sep. 16, 2015	Jan. 27, 2016	Radiation (03CH01-SZ)
AC Power Source	Chroma	61601	61601000198 5	N/A	NCR	Sep. 16, 2015	NCR	Radiation (03CH01-SZ)
Turn Table	EM	EM1000	N/A	0~360 degree	NCR	Sep. 16, 2015	NCR	Radiation (03CH01-SZ)
Antenna Mast	EM	EM1000	N/A	1 m~4 m	NCR	Sep. 16, 2015	NCR	Radiation (03CH01-SZ)



5. Uncertainty of Evaluation

Uncertainty of Conducted Emission Measurement (150 kHz ~ 30 MHz)

Measuring Uncertainty for a Level of Confidence of 95% ($U = 2Uc(y)$)	2.3 dB
---	--------

Uncertainty of Radiated Emission Measurement (30 MHz ~ 1000 MHz)

Measuring Uncertainty for a Level of Confidence of 95% ($U = 2Uc(y)$)	3.9 dB
---	--------