



47 CFR PART22 H

TEST REPORT

of

CDMA Phone

Model Name: CT800P
Brand Name: CANTV
Report No.: SZ08120019E02
FCC ID: WVB-CT800P

prepared for

Brightstar Corporation

9725 NW 117th Ave#300 Miami-FL 33178-USA

Shenzhen Morlab Communications Technology Co., Ltd.

3/F, Electronic Testing Building, Shahe Road, Xili,

Nanshan District, Shenzhen, 518055, P. R. China

Tel: +86 755 86130398

Fax: +86 755 86130218



NOTE: This test report can be duplicated completely for the legal use with the approval of the applicant, it shall not be reproduced except in full, without the written approval of Shenzhen Morlab Communications Technology Co., Ltd. Any objections should be raised to us within thirty workdays since the date of issue.



TABLE OF CONTENTS

1.	TEST RESULT CERTIFICATION	4
2.	GENERAL INFORMATION	5
2.1	Equipment under Test (EUT) Description	5
2.2	Test Standards and Results	6
2.3	Facilities and Accreditations	7
2.3.1	Facilities	7
2.3.2	Test Equipments	7
2.3.3	Test Environment Conditions.....	8
3.	47 CFR PART 2, PART 22H REQUIREMENTS	9
3.1	General Information.....	9
3.1.1	Conducted Related Tests	9
3.1.2	Radiated Power and Spurious Emission Tests	10
3.1.3	Frequency Stability Test.....	11
3.2	Frequencies.....	12
3.2.1	Requirement	12
3.2.2	Test Procedure	12
3.2.3	Test Result	12
3.3	Conducted RF Output Power	14
3.3.1	Requirement	14
3.3.2	Test Procedure	14
3.3.3	Test Result	14
3.4	Occupied Bandwidth	17
3.4.1	Occupied Bandwidth Definition	17
3.4.2	Test Procedure	17
3.4.3	Test Result	17
3.5	Conducted Spurious Emission.....	20
3.5.1	Requirement	20
3.5.2	Test Procedure	20
3.5.3	Test Result	21
3.6	Transmitter Radiated Power (EIRP/ERP).....	25



3.6.1	Requirement	25
3.6.2	Test Procedure	25
3.6.3	Test Result	25
3.7	Radiated Spurious Emission	28
3.7.1	Requirement	28
3.7.2	Test Procedure	28
3.7.3	Test Result	29
3.8	Frequency Stability	33
3.8.1	Frequency Stability Requirement	33
3.8.2	Test Procedure	33
3.8.3	Test Result	34



1. Test Result Certification

Equipment under Test: CDMA Phone

Brand Name: CANTV
Model Name: CT800P
FCC ID: WVB-CT800P

Applicant: Brightstar Corporation
9725 NW 117th Ave#300 Miami-FL 33178-USA
Manufacturer: LINKTOP TECHNOLOGY CO., LTD..
Guangye Building, Torch Hi-Tech Industrial Development Zone, Xiamen, China

Test Standards: 47 CFR Part 2
47 CFR Part 22 Subpart H
Test date: December 1, 2008 –December 14, 2008
Test Result: PASS

* We Hereby Certify That:

The equipment under test was tested by Shenzhen Morlab Communications Technology Co., Ltd. The test data, data evaluation, test procedures and equipment configurations shown in this report were made in accordance with the requirement of related FCC rules.

The test results of this report only apply for the tested sample equipment identified above. The test report shall be invalid without all the signatures of the test engineer, the reviewer and the approver.

Tested by: Li Yi Dated: 2008.12.18
Li Yi

Reviewed by: Wei Yanquan Dated: 2008.12.18
Wei Yanquan

Approved by: Shu Luan Dated: 2008.12.18
Shu Luan

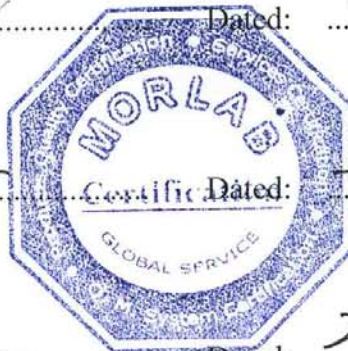

2. General Information

2.1 Equipment under Test (EUT) Description

Description: CDMA Phone
Model Name: CT800P
Brand Name.....: CANTV
Serial No.....: CT800PHBUSK
MEID.....: (n.a)
Hardware Version: CT800P-DATA-V1.3
Software Version: HT618-VENV1.00-081112.bin
Emission Designator.....: 1M25F9W
Modulation: CDMA 1X
Frequency: Tx: 824.7 – 848.31MHz; Rx: 869.7 - 893.31MHz
Power Supply:: Battery
Brand name: BOFUNENG/SHIDE
Model Name: LT50AA 1200H (PN: 11W0012)
Capacitance: 1200mAh
Rated voltage: 3.6V
Charge limited: 4.3V
Manufacturer: Jiangsu Cell Battery Co., Ltd.
No.47, Jianshe Road, Licheng Town, Jinhu,
Huai'an, Jiangsu, China
Accessory Equipment:..... AC Adapter (Charger for Battery)
Brand Name: Chi Yuan
Model Name: CHG50100-3A
Rated Input: ~ 100V-240V, 0.2A, 50/60Hz
Rated Output: = 5V, 1A
Manufacturer: Shenzhen Chi Yuan Industrial Co Ltd.
City Plaza, B1 Bldg, 13th Fl, Room C, Chang An
Town, Dongguan, Guangdong523850 Cn
Wire Length: 145cm

NOTE:

1. The EUT is a model of CDMA 1X mobile station operating in Cellular band.
2. The normal configuration for the EUT is the CDMA Phone (MS) associated with ancillary equipments e.g. the Battery and/or the AC Adapter (Charger).
3. For detailed features about the EUT, please see user manual supplied by the applicant.



2.2 Test Standards and Results

The objective of the report is to perform tests according to 47 CFR Part 2, Part 15 Part 22 for FCC ID Certification:

No.	Identity	Document Title
1	47 CFR Part 2 (10-1-05 Edition)	Frequency Allocations and Radio Treaty Matters; General Rules and Regulations
2	47 CFR Part 22 (10-1-05 Edition)	Public Mobile Services

Test detailed items and the results are as below:

No.	Rules	Test Type	Result	Date of Test
FCC Part 22 Requirement				
1	§2.106 §22.905	Frequencies	PASS	2008-12-13
2	§2.1046	Conducted RF Output Power at Antenna Terminal	PASS	2008-12-13
3	§2.1049	Occupied Bandwidth	PASS	2008-12-13
4	§2.1051 §2.1057 §22.917	Conducted Spurious Emission at Antenna Terminal	PASS	2008-12-13
5	§22.913	Transmitter Radiated Power (EIPR/ERP)	PASS	2008-12-13
6	§2.1053 §2.1057 §22.917	Radiated Spurious Emission	PASS	2008-12-13
7	§2.1055 §22.355	Frequency Stability	PASS	2008-12-13

2.3 Facilities and Accreditations

2.3.1 Facilities

Shenzhen Electronic Product Quality Testing Center Morlab Laboratory is a testing organization accredited by China National Accreditation Service for Conformity Assessment (CNAS) according to ISO/IEC 17025. The accreditation certificate number is CNAS L1659.

All measurement facilities used to collect the measurement data are located at Electronic Testing Building, Shahe Road, Xili, Nanshan District, Shenzhen, P. R. China. The site was constructed in conformance with the requirements of ANSI C63.7, ANSI C63.4 and CISPR Publication 22, the FCC registration number is 741109.

2.3.2 Test Equipments

No.	Description	Specification
1	System Simulator	Manufacturer: Rohde&Schwarz Model No.: CMU200 Serial No.: 100448
2	System Simulator	Manufacturer: Agilent Model No.: E5515C Serial No.: GB43130131
3	Spectrum Analyzer	Manufacturer: Agilent Model No.: E7405A Serial No.: US44210471
4	Telecommunication Antenna	Manufacturer: European Antennas Model No.: PSA-45010R/356 Serial No.: 403688-001
5	Trilogy Antenna	Manufacturer: Schwarzbeck Model No.: VULB 9163 Serial No.: 9163-274
6	Horn Antenna	Manufacturer: Schwarzbeck Model No.: BBHA 9120C Serial No.: 9120C-384
7	Power Splitter	Manufacturer: WEINSCHEL Model No.: 1506A Serial No.: NW521
8	Anechoic Chamber	Manufacturer: Albatross Projects GmbH
9	DC Power Supply	Manufacturer: Good Will Instrument Co., Ltd.
10	Temperature Chamber	Manufacturer: Chongqing YinHe Experimental Equip. Co., Ltd.

NOTE:

1. Equipments listed above have been calibrated and are in the period of validation.

2.3.3 Test Environment Conditions

During the measurement, the environmental conditions were within the listed ranges:

Temperature:	20 - 25°C
Relative Humidity:	40 - 60%
Atmospheric Pressure:	86-106kPa

3. 47 CFR Part 2, Part 22H Requirements

3.1 General Information

3.1.1 Conducted Related Tests

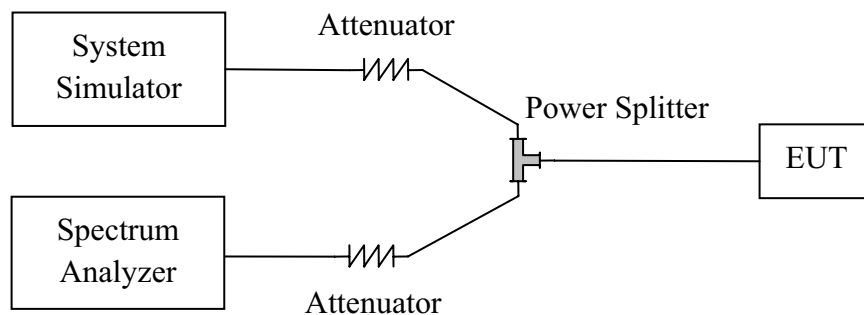

1. The EUT is coupled to the Spectrum Analyzer and the System Simulator with the suitable Attenuators through the Power Splitter; the path loss is calibrated to correct the reading.
2. The EUT is configured here as MS + Battery.
3. The EUT is commanded via the System Simulator (SS) to operate at the maximum output power .A communication link is established between the EUT and the SS.
4. The Spectrum Analyzer is set to max-peak detector function and maximum hold mode.

3.1.2 Radiated Power and Spurious Emission Tests

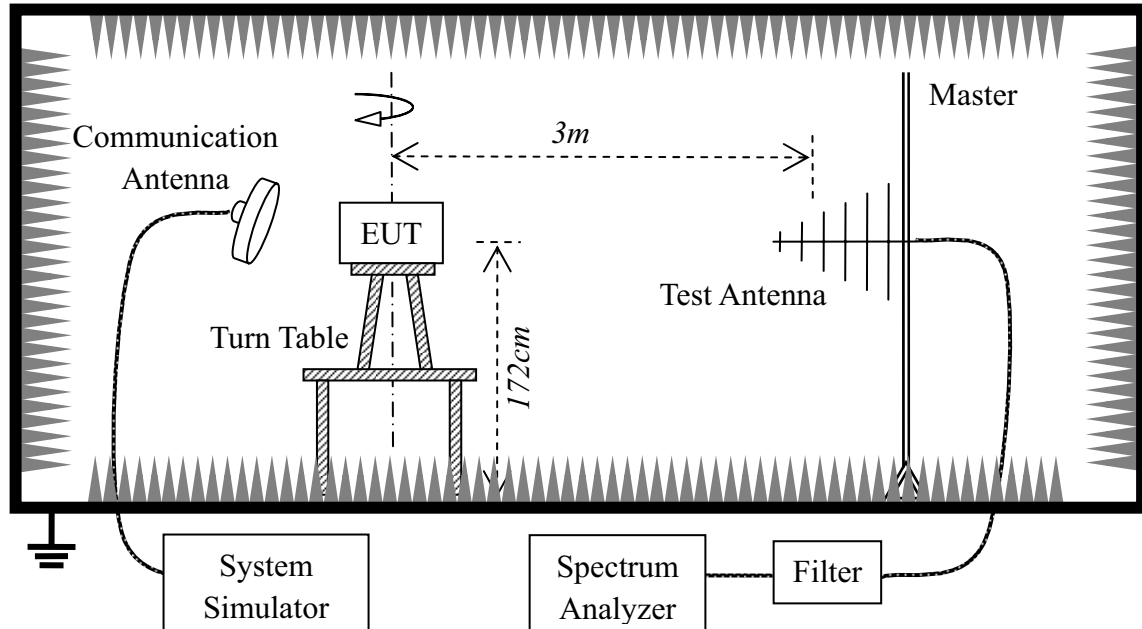

1. The test is performed in a full-Anechoic Chamber; the air loss of the site and the factors of the test system are pre-calibrated using the substitution method.
2. The EUT is configured as MS + Battery.
3. The EUT is placed on the vertical axis of a Turn Table 1.72 meters above the ground.
4. The Test Antenna is a bi-log one or a horn one, and the Test Antenna is at the same height as the EUT.
5. The EUT is commanded via the System Simulator (SS) to operate at the maximum output power. A communication link is established between the EUT and the SS.
6. The Spectrum Analyzer is set to max-peak detector function and maximum hold mode.

3.1.3 Frequency Stability Test

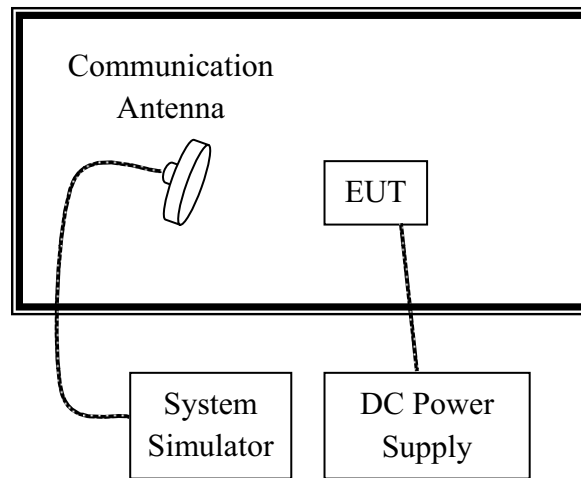

1. The test is performed in a Temperature Chamber.
2. The EUT is configured as MS + DC Power Supply.

3.2 Frequencies

3.2.1 Requirement

According to FCC §22.905, the frequencies blocks assignment for the Cellular Radiotelephone Service are listed as below.

- (a) Channel Block A:
 - Mobile 824 - 835MHz, Base 869 - 880MHz;
 - Mobile 845 - 846.5MHz, Base 890 - 891.5MHz
- (b) Channel Block B:
 - Mobile 835 - 845 MHz, Base 880 - 890MHz;
 - Mobile 846.5 - 849 MHz, Base 891.5 - 894MHz

3.2.2 Test Procedure

1. Perform test system setup as section 3.1.1.
2. The resolution bandwidth (RBW) of the Spectrum Analyzer was set to at least 1% of the emission bandwidth of the fundamental emission of the transmitter, e.g. for GSM modulated signal (here used): $RBW=VBW=3kHz$, for CDMA modulated signal: $RBW=VBW=30kHz$.
3. The transmitter frequency arrangement of the Cellular 850MHz band employed by the EUT should be from 825.27MHz to 847.74MHz. The lowest and the highest channel were selected to perform tests respectively. Set the TCH number to 9.
4. Set the Spectrum Analyzer suitably to capture the waveform, search peak and mark, and then record the plot.
5. Set the TCH number to 758, then repeat step 5.

3.2.3 Test Result

The frequencies of the lowest channel and the highest channel are as the following figures.

1. Plot when the TCH number set to 9:

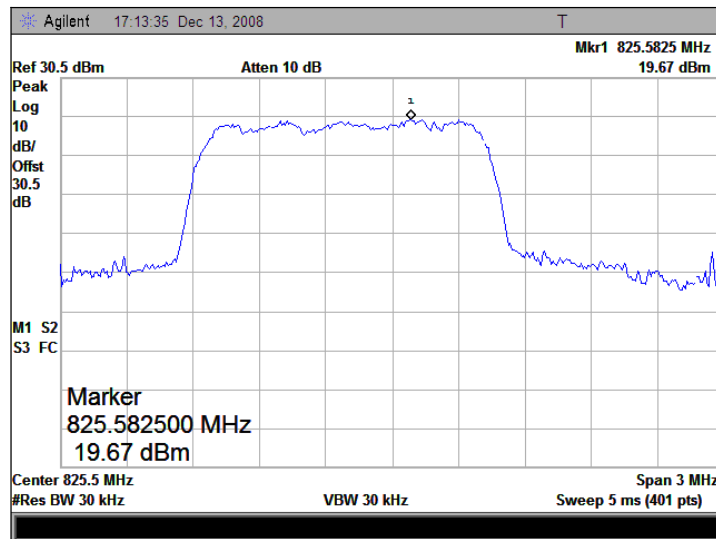

2. Plot when the TCH number set to 758:

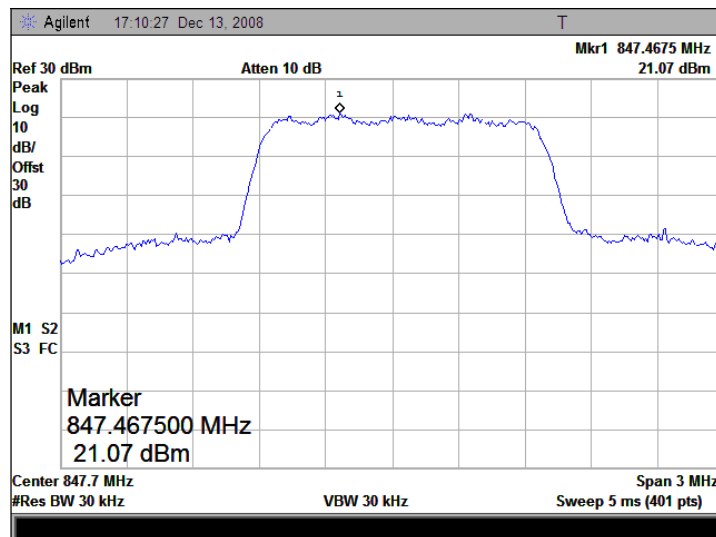

3.3 Conducted RF Output Power

3.3.1 Requirement

According to FCC §2.1046 (a), for transmitters other than single sideband, independent sideband and controlled carrier radiotelephone, power output shall be measured at the RF output terminals when the transmitter is adjusted in accordance with the tune-up procedure to give the values of current and voltage on the circuit elements specified in §2.1033 (c)(8). The electrical characteristics of the radio frequency load attached to the output terminals when this test is made shall be stated.

3.3.2 Test Procedure

1. Perform test system setup as section 3.1.1 (the radio frequency load attached to the EUT antenna terminal is 50Ω).
2. The resolution bandwidth of the Spectrum Analyzer is set to be comparable to the emission bandwidth of the transmitter, e.g. for GSM modulated signal (here used): $RBW=VBW=1MHz$, for CDMA modulated signal: $RBW=VBW=3MHz$.
3. The low, middle and the high channels are selected to perform tests respectively. Set the TCH number to 9 as the low channel.
4. Set the frequency range of the Spectrum Analyzer suitably to capture the waveform; search peak and mark it; finally record the peak and the plot.
5. Set the TCH number to 384 as the middle channel, then repeat step 4.
6. Set the TCH number to 758 as the high channel, then repeat step 4.

3.3.3 Test Result

No.	Channel Number	Frequency (MHz)	Measured Power		Rated Power	
			dBm	W	dBm	W
1	9	825.27	28.43	0.70	33	2
2	384	836.52	27.25	0.53	33	2
3	758	847.74	28.73	0.75	33	2

1. Plot when the TCH number set to 9:

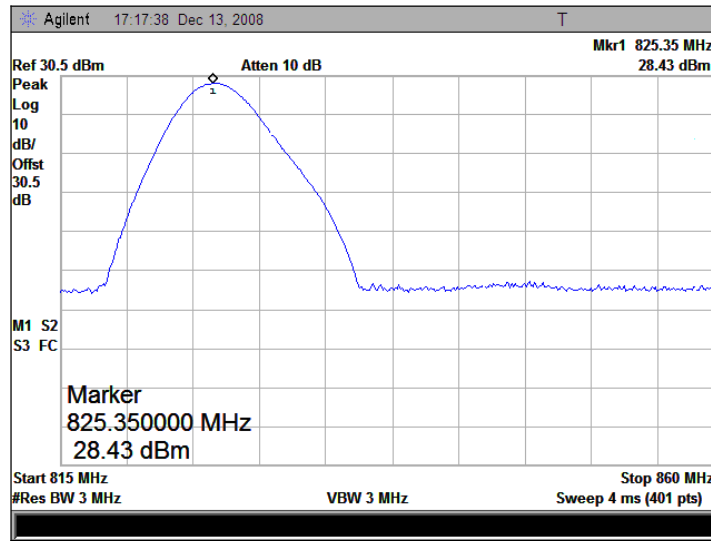

2. Plot when the TCH number set to 384:

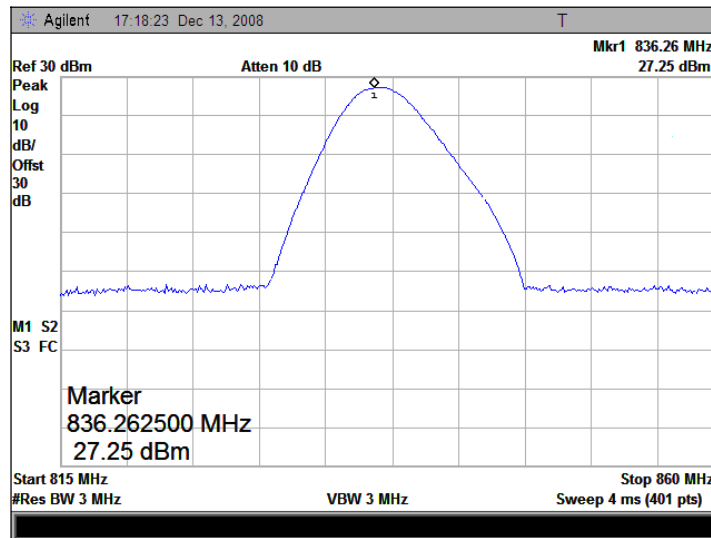

3. Plot when the TCH number set to 758:

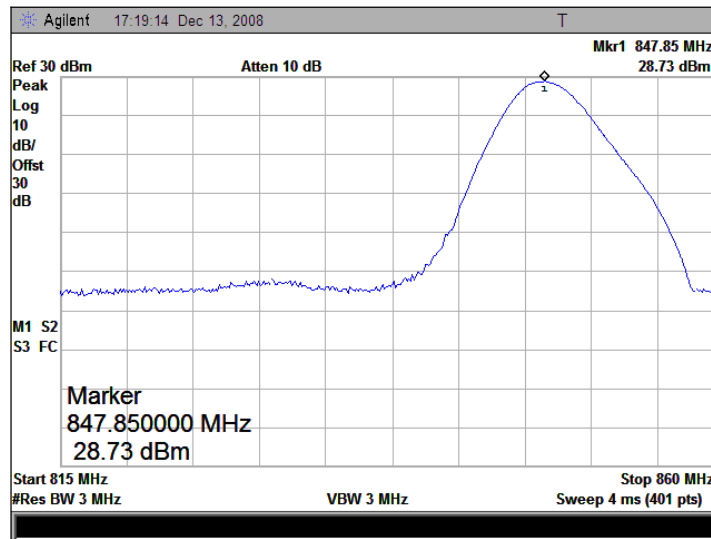

3.4 Occupied Bandwidth

3.4.1 Occupied Bandwidth Definition

According to FCC §2.1049, the occupied bandwidth is the frequency bandwidth such that, below its lower and above its upper frequency limits, the mean powers radiated are each equal to 0.5 percent of the total mean power radiated by a given emission.

Occupied bandwidth is also known as the 99% emission bandwidth. The emission bandwidth is defined as the width of the signal between two points, one below the carrier center frequency and one above the carrier center frequency, outside of which all emissions are attenuated at least 26dB below the transmitter power.

3.4.2 Test Procedure

1. Perform test system setup as section 3.1.1.
2. The resolution bandwidth of the Spectrum Analyzer is set to at least one percent of the emission bandwidth, e.g. for GSM modulated signal (here used): $RBW=VBW=3kHz$, for CDMA modulated signal: $RBW=VBW=30kHz$.
3. The low, middle and the high channels are selected to perform tests respectively. Set the TCH number to 9 as the low channel.
4. Set the frequency range of the Spectrum Analyzer suitably to capture the waveform; search peak; make a line whose value is 20dB lower than the peak; mark two points which the line intersected the waveform at; finally record the delta of the two points as the occupied bandwidth and the plot.
5. Set the TCH number to 384 as middle channel, then repeat step 4.
6. Set the TCH number to 758 as high channel, then repeat step 4.

3.4.3 Test Result

No.	Channel Number	Frequency (MHz)	Measured Occupied Bandwidth (MHz)
1	9	825.27	1.41
2	384	836.52	1.40
3	758	847.74	1.40

1. Plot when the TCH number set to 9:

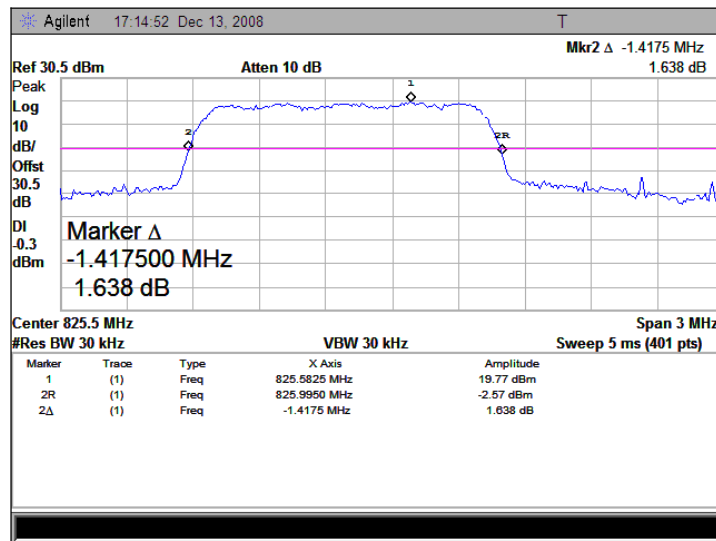

2. Plot when the TCH number set to 384:

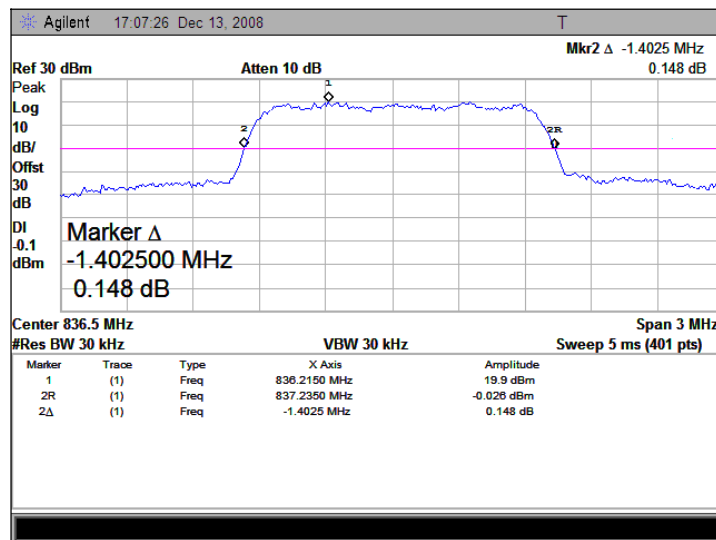

3. Plot when the TCH number set to 758:

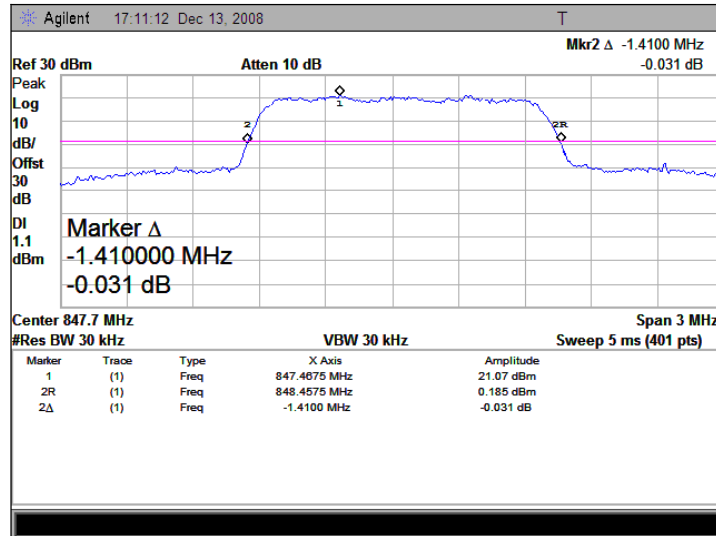

3.5 Conducted Spurious Emission

3.5.1 Requirement

According to FCC §22.917(a), the power of any emission outside of the authorized operating frequency ranges must be attenuated below the transmitting power (P) by a factor of at least $43+10*\log(P)$ dB. This calculated to be -13dBm.

According to FCC §22.917 (a), in the 1MHz bands immediately outside and adjacent to the frequency block a resolution bandwidth of at least one percent of the emission bandwidth of the fundamental emission of the transmitter may be employed. Thus the 26dB emission bandwidth is measurement for showing compliance at the band-edge.

3.5.2 Test Procedure

1. Perform test system setup as section 3.1.1.
2. Make a limit line whose value is -13dBm on the Spectrum Analyzer.
3. The lowest, middle and the highest channels are selected to perform tests respectively. Set the TCH number to 9 as the lowest channel.
4. Set the RBW of the Spectrum Analyzer to 1MHz, and the measuring frequency range from 9kHz to 10th harmonic of the fundamental frequency (here used 10GHz); mark the fundamental frequency and the harmonics thereof; finally record the harmonics and the plot. Note: the measuring frequency range can be divided into several parts to perform tests.
5. In the 1MHz bands immediately outside and adjacent to the frequency black, the RBW of the Spectrum Analyzer was set to at least one percent of the emission bandwidth of the fundamental emission of the transmitter, e.g. for GSM modulated signal (here used): RBW=3kHz, for CDMA modulated signal: RBW=30kHz.
6. Set the TCH number to 384 as the middle channel, then repeat step 4 and 5.
7. Set the TCH number to 758 as the highest channel, then repeat step 4 and 5.

3.5.3 Test Result

3.5.3.1 Table for the Harmonics and Plots for the Spurious Emission

1. Table for the Harmonics:

No.	Channel	Frequency(MHz)	Measured Max Spurious Emission(dBm)	Limit(dBm)
1.	9	825.27	<-20	-13
2.	384	836.52	<-20	-13
3.	758	847.74	<-20	-13

2. Plot for Spurious Emission:

The measuring frequency range was from 9kHz to 10GHz.

NOTE: The marker points are the Mobile Phone and/or System Simulator transmitting frequencies which should be ignored.

2.1 Plot when the TCH number set to 9:

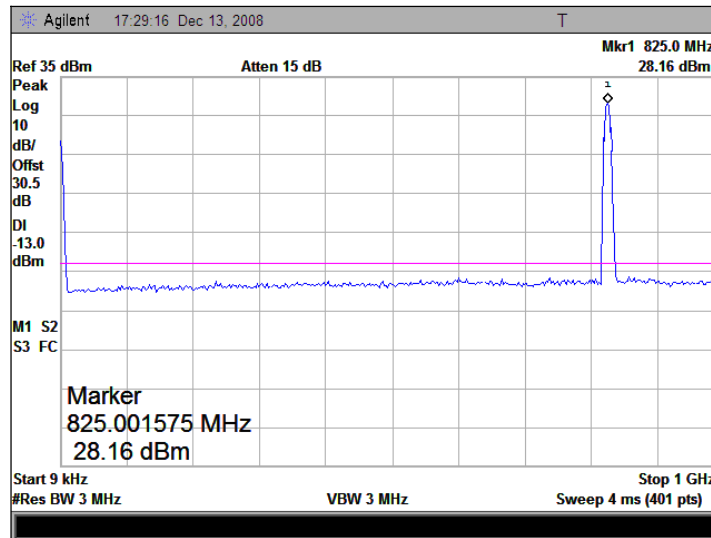

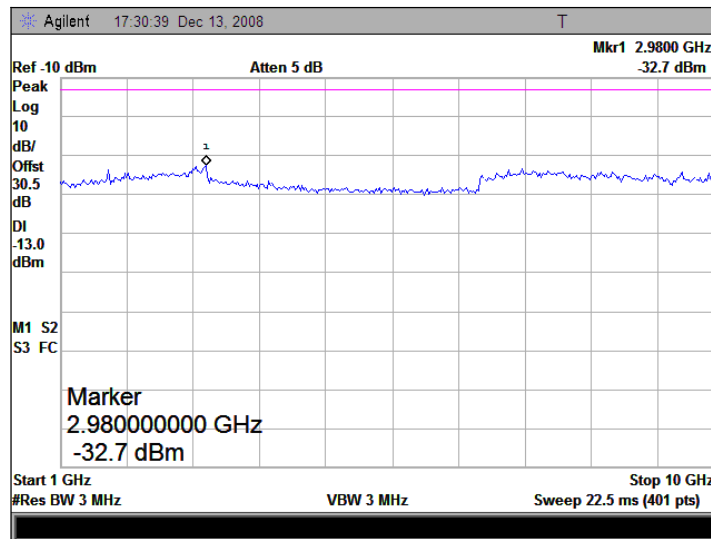

2.2 Plot when the TCH number set to 384:

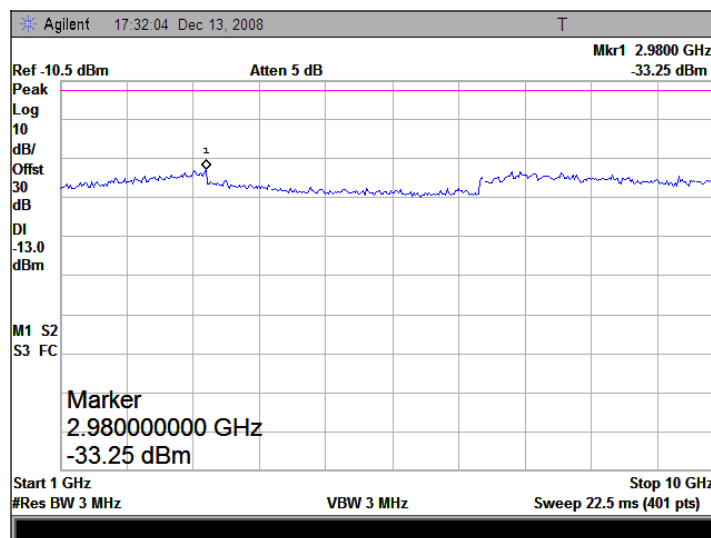
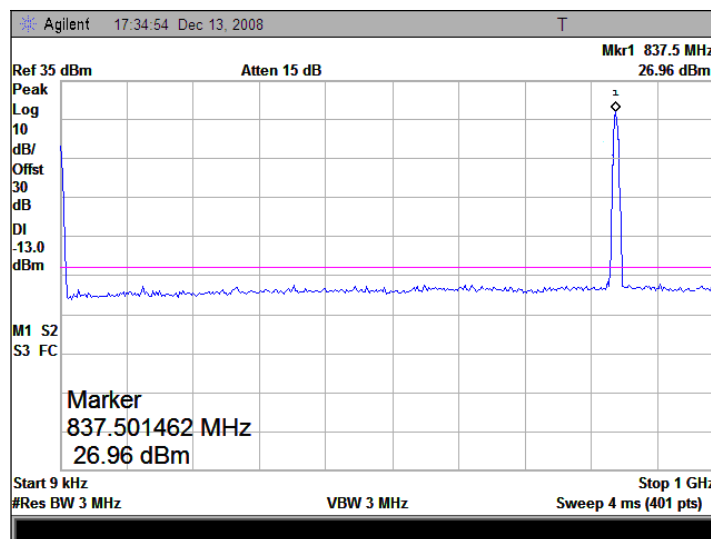

2.3 Plot when the TCH number set to 758:

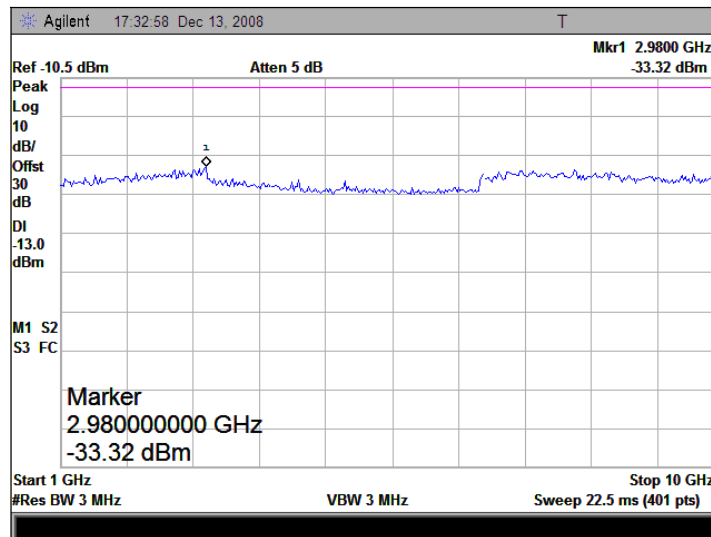
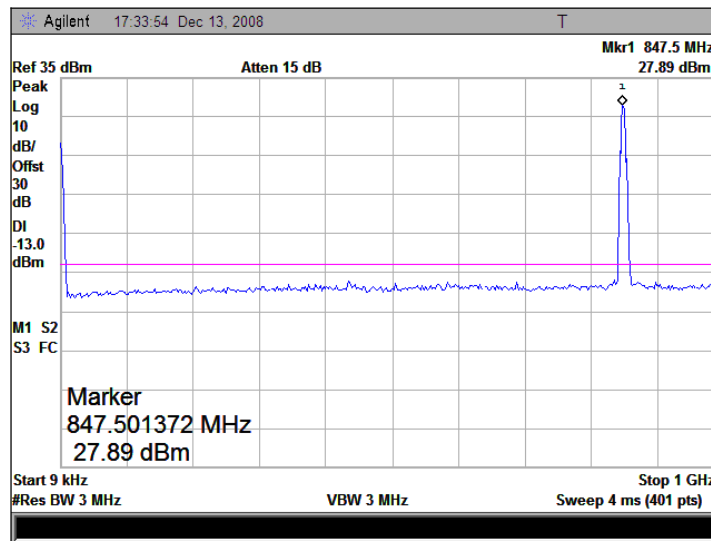

3.5.3.2 Plot for Band-edge

1. Plot when the TCH number set to 9:

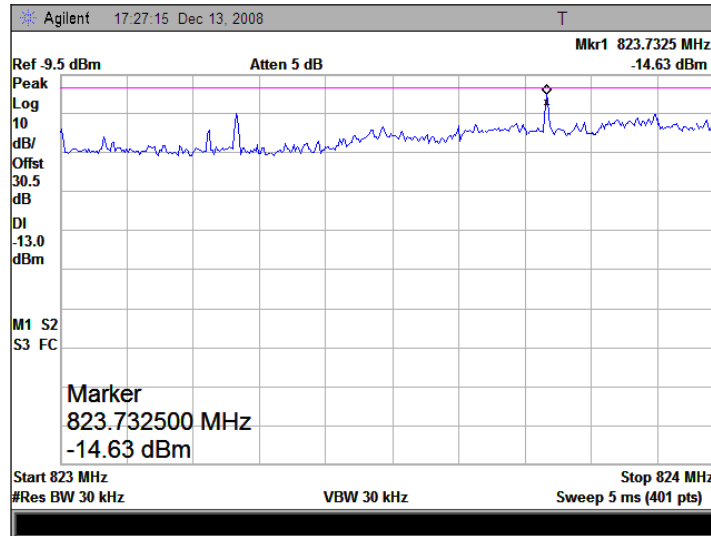

2. Plot when the TCH number set to 758:

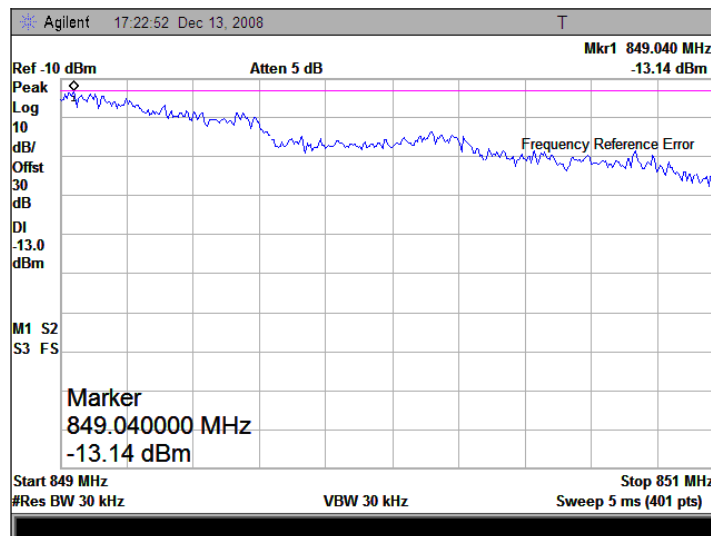

3.6 Transmitter Radiated Power (EIRP/ERP)

3.6.1 Requirement

According to FCC §22.913, the ERP of Cellular mobile transmitters must not exceed 7 Watts (38.5dBm).

3.6.2 Test Procedure

1. Perform test system setup as section 3.1.2.
2. The resolution bandwidth of the Spectrum Analyzer is set to be comparable to the emission bandwidth of the transmitter, e.g. for GSM modulated signal (here used): RBW=VBW=1MHz, for CDMA modulated signal: RBW=VBW=3MHz.
3. The low, middle and the high channels are selected to perform tests respectively. Set the TCH number to 9 as the low channel.
4. Employ the bi-log Test Antenna as the test system receiving antenna; set the polarization of the Test Antenna to be the same as that of the EUT transmitting antenna.
5. Set the frequency range of the Spectrum Analyzer suitably to capture the waveform; actuate the Turn Table to turn from 0 degrees to 360 degrees to find the maximum reading via the Spectrum Analyzer, mark the peak; finally record the peak and the plot.
6. Set the TCH number to 384 as the middle channel, then repeat step 5.
7. Set the TCH number to 758 as the high channel, then repeat step 5.

3.6.3 Test Result

No.	Channel	Frequency (MHz)	Measured ERP		Limit ERP	
			dBm	W	dBm	W
1	9	825.27	23.77	0.24	< 38.5	< 7
2	384	836.52	23.76	0.24	< 38.5	< 7
3	758	847.74	23.84	0.24	< 38.5	< 7

1. Plot when the TCH number set to 9:

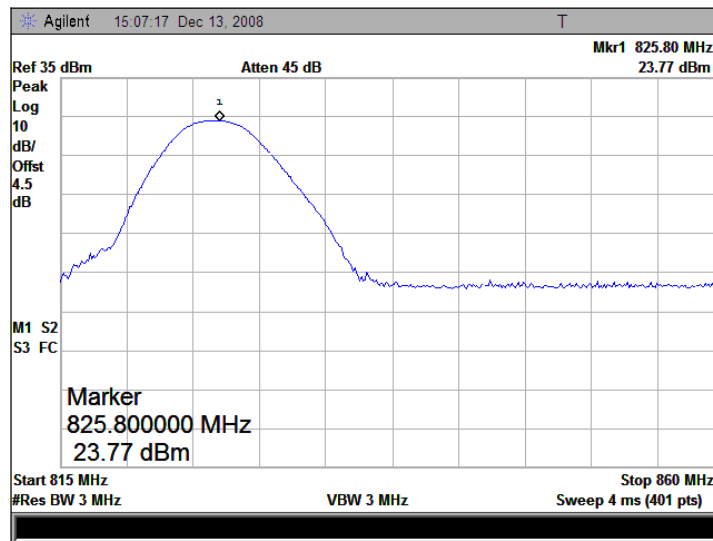

2. Plot when the TCH number set to 384:

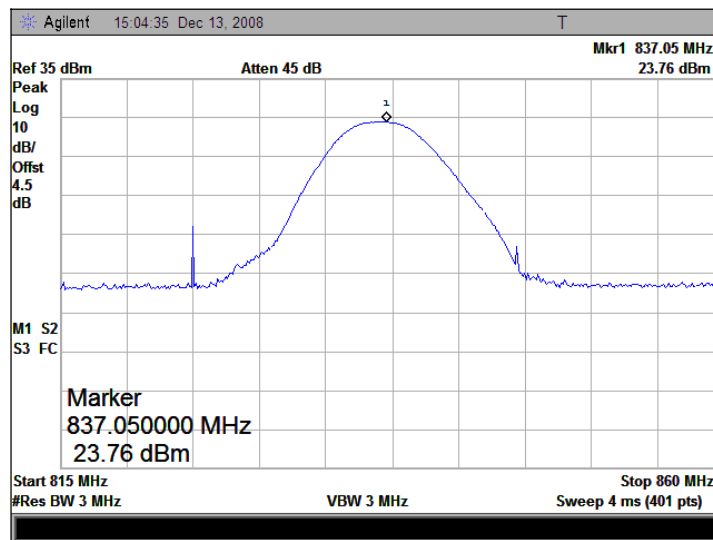

3. Plot when the TCH number set to 758:

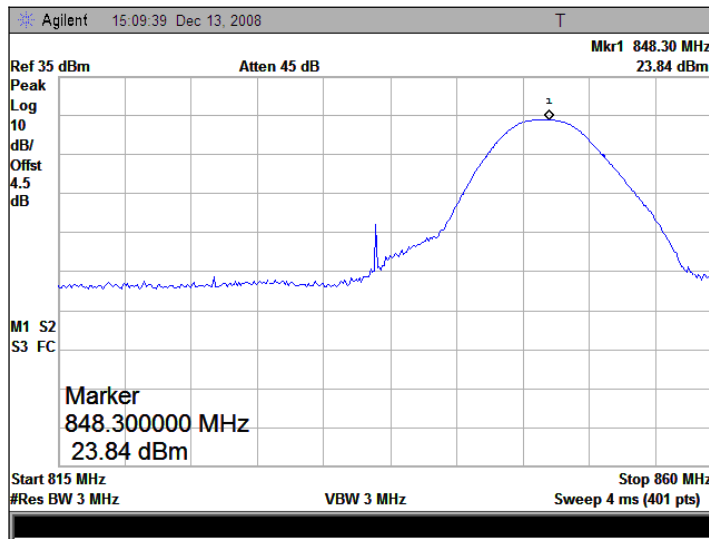

3.7 Radiated Spurious Emission

3.7.1 Requirement

According to FCC §22.917(a), the power of any emission outside of the authorized operating frequency ranges must be attenuated below the transmitting power (P) by a factor of at least $43+10*\log(P)$ dB. This calculated to be -13dBm.

3.7.2 Test Procedure

1. Perform test system setup as section 3.1.2.
2. Make a limit line whose value is -13dBm on the Spectrum Analyzer, and set the RBW of the Spectrum Analyzer to 1MHz.
3. The low, middle and the high channels are selected to perform tests respectively. Set the TCH number to 9 as the low channel.
4. Employ the bi-log Test Antenna as the test system receiving antenna and set the frequency range of the Spectrum Analyzer from 30MHz to 3GHz.
5. The measurement is performed with the Test Antenna at both horizontal and vertical polarization respectively. Set the polarization of the Test Antenna to be horizontal.
6. Actuate the Turn Table to turn from 0 degrees to 360 degrees to find the maximum reading via the Spectrum Analyzer, mark the fundamental frequency and the harmonics thereof, after then record the harmonics and the plot.
7. Set the polarization of the Test Antenna to be vertical, then repeat step 6.
8. Employ the horn Test Antenna as the test system receiving antenna and set the frequency range of the Spectrum Analyzer from 3GHz to 10th harmonic of the fundamental frequency (here used 10GHz), then repeat step 5 to 7.
9. Set the TCH number to 384 as the middle channel, then repeat step 4 to 8.
10. Set the TCH number to 758 as the high channel, then repeat step 4 to 8.

3.7.3 Test Result

3.7.3.1 Table for the Harmonics

NOTE: “---” in the table following means that the emission power was too small to be measured and was at least 12dB below the limit.

No.	Frequency (MHz)	Emission Power (dBm)		Limit (dBm)
		Test Antenna Vertical	Test Antenna Horizontal	
TCH number set to 9 (825.27MHz)				
1	1650.54	---	---	-13
2	2475.81	---	---	-13
3	3301.08	---	---	-13
4	4126.35	---	---	-13
5	4951.62	---	---	-13
6	5776.89	---	---	-13
7	6602.16	---	---	-13
8	7427.43	---	---	-13
9	8252.70	---	---	-13
TCH number set to 384 (836.52MHz)				
10	1673.04	---	---	-13
11	2509.56	---	---	-13
12	2509.56	---	---	-13
13	3346.08	---	---	-13
14	4182.6	---	---	-13
15	5855.64	---	---	-13
16	6692.16	---	---	-13
17	7528.68	---	---	-13
18	8365.20	---	---	-13
TCH number set to 758 (847.74MHz)				
19	1695.48	---	---	-13
20	2543.22	---	---	-13
21	3390.96	---	---	-13
22	4238.70	---	---	-13
23	5086.44	---	---	-13
24	5934.18	---	---	-13
25	6781.92	---	---	-13
26	7629.66	---	---	-13
27	8477.40	---	---	-13

3.7.3.2 Test Plot

1. Plot when the TCH number set to 9:

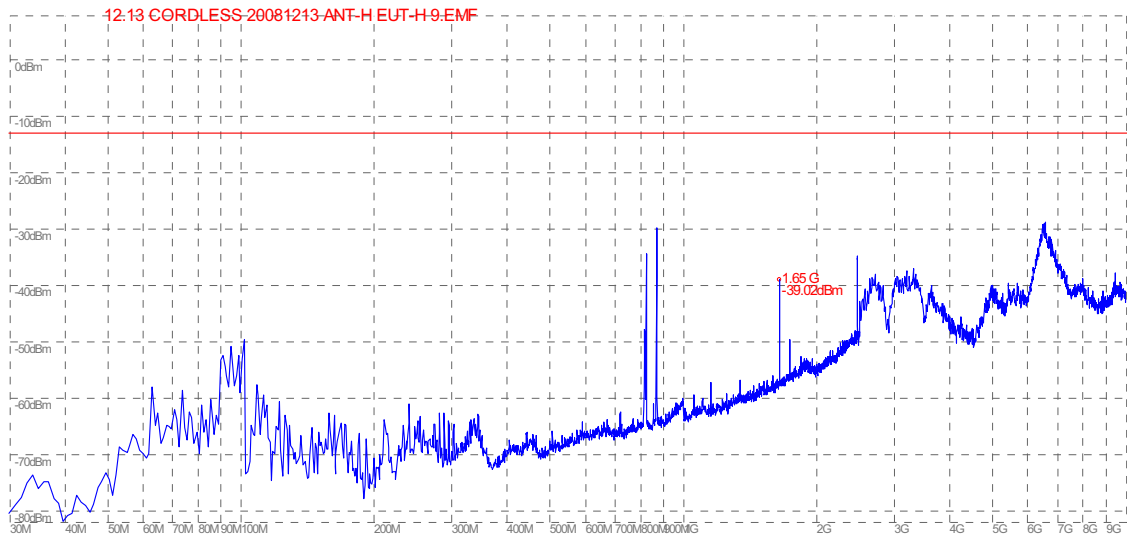

(Plot A: Test Antenna Horizontal)

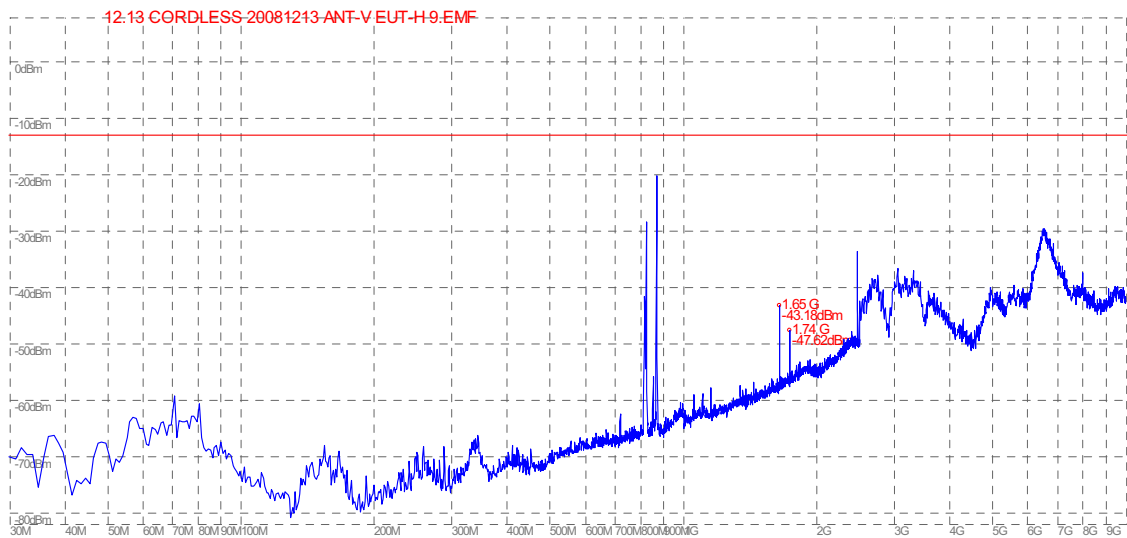

(Plot B: Test Antenna Vertical)

2. Plot when the TCH number set to 384:

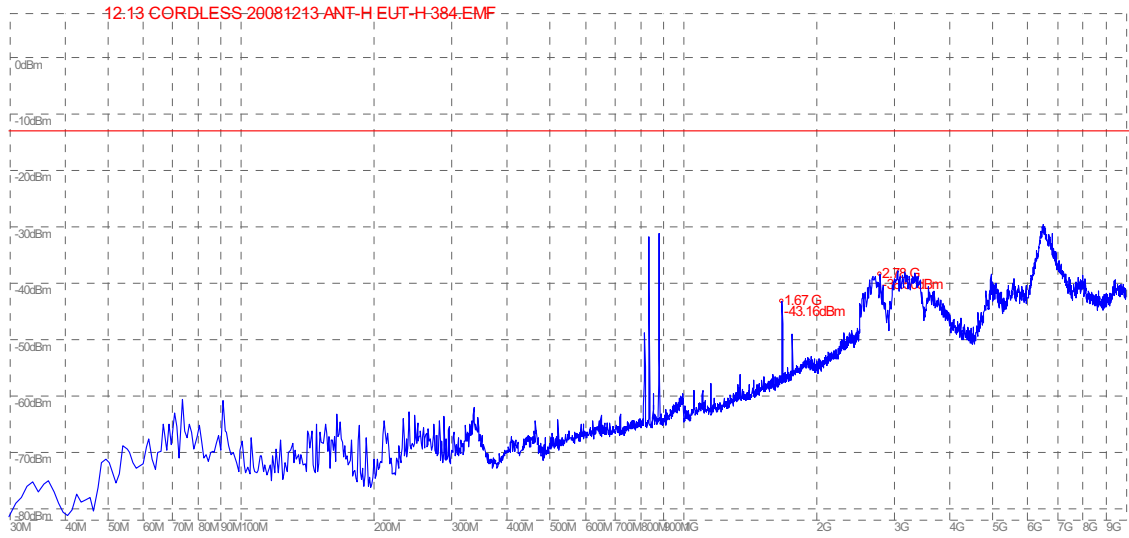

(Plot A: Test Antenna Horizontal)

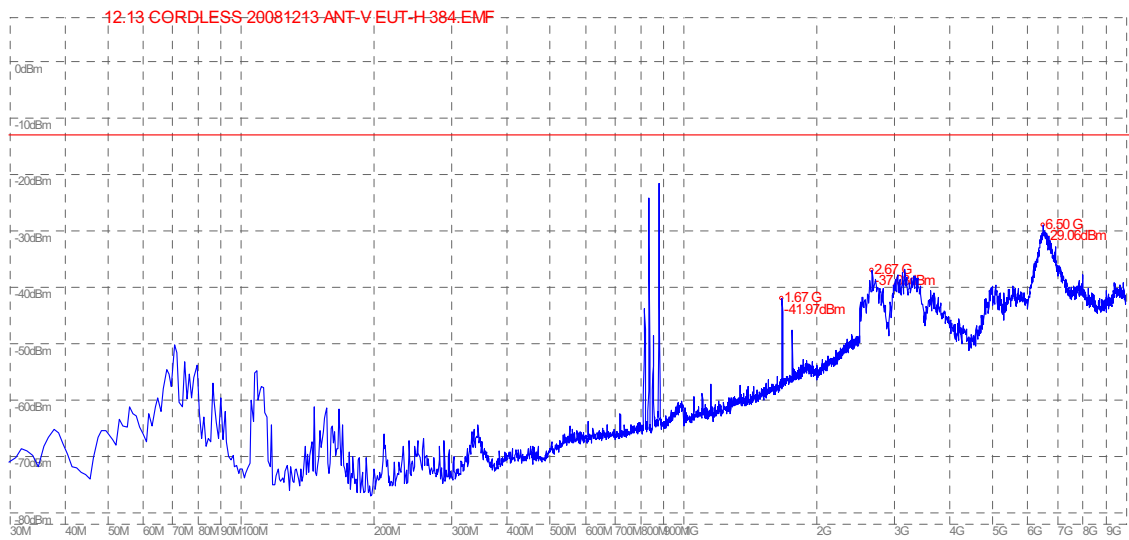

(Plot B: Test Antenna Vertical)

3. Plot when the TCH number set to 758:

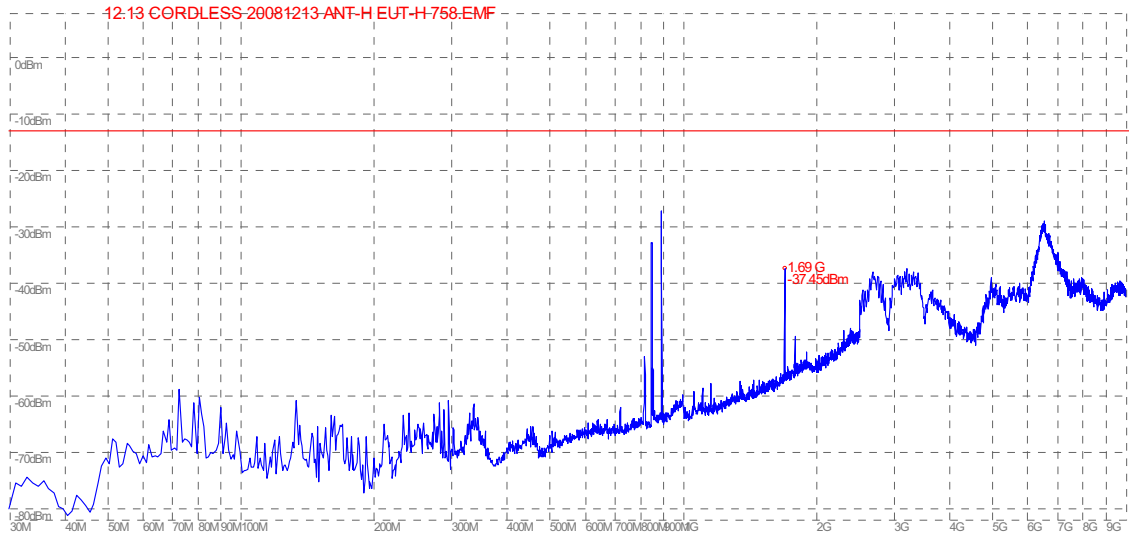

(Plot A: Test Antenna Horizontal)

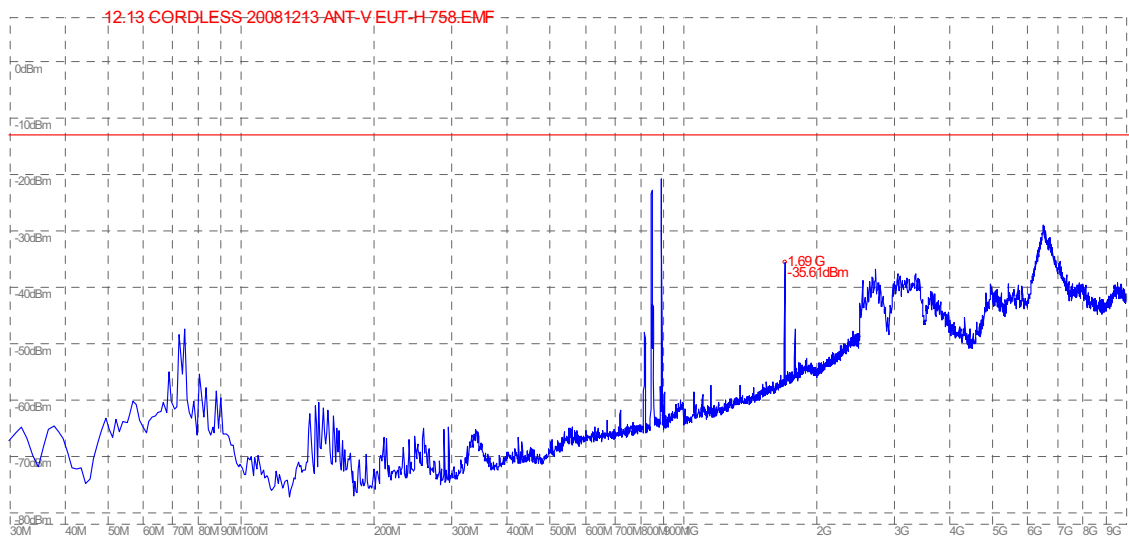

(Plot B: Test Antenna Vertical)

3.8 Frequency Stability

3.8.1 Frequency Stability Requirement

According to FCC §22.355, the frequency stability shall be sufficient to ensure that the fundamental emission stays within the authorized frequency block.

According to FCC §2.1055, the test conditions are:

- (a) Temperature:
The temperature is varied from -30°C to $+50^{\circ}\text{C}$ at intervals of not more than 10°C .
- (b) Primary Supply Voltage:
For hand carried battery powered equipment, the primary supply voltage is reduced to the battery operating end point which shall be specified by the manufacture. The supply voltage shall be measured at the input to the cable normally provided with the equipment, or at the power supply terminals if cables are not normally provided.

3.8.2 Test Procedure

1. Perform test system setup as section 3.1.3.
2. Set the voltage of the DC Power Supply to normal supply voltage (here used 3.7V) and the temperature of the Temperature Chamber to vary from -30°C to $+50^{\circ}\text{C}$ at intervals of 10°C .
3. At each temperature level, the EUT is powered off and kept in the Temperature Chamber for two hours. After sufficient stabilization, turn on the EUT, command it via the System Simulator (SS) to operate at the maximum output power i.e. A communication link is established between the EUT and the SS.
4. The low, middle and the high channels are selected to perform tests respectively. Set the TCH number to 9 as the low channel.
5. The frequency deviation is measured (directly read from the SS, which can report the parameter) within three minutes.
6. Set the TCH number to 384 as the middle channel, then repeat step 5.
7. Set the TCH number to 758 as the high channel, then repeat step 5.
8. Adjust the temperature of the Temperature Chamber as specified in step 2, then repeat step 3 to 7.
9. Set the voltage of the DC Power Supply to high extreme supply voltage (here used 4.2V) and the temperature of the Temperature Chamber to normal (here used $+22^{\circ}\text{C}$), then repeat step 3 to 8.
10. Set the voltage of the DC Power Supply to low extreme supply voltage (here used 3.6V) and the temperature of the Temperature Chamber to normal (here used $+22^{\circ}\text{C}$), then repeat step 3 to 8.

3.8.3 Test Result

No.	Test Conditions		Frequency Deviation (Hz) at Channels Used			
	Voltage	Temperature	9	384	758	Limit
1	3.7V	-30°C	-7.58	8.26	6.43	±300Hz
2		-20°C	-5.65	-7.24	4.98	
3		-10°C	-6.54	7.64	6.07	
4		0°C	8.50	8.12	4.45	
5		+10°C	9.63	3.86	7.52	
6		+20°C	8.15	4.82	6.75	
7		+30°C	7.46	5.73	5.56	
8		+40°C	5.45	-6.48	4.15	
9		+50°C	7.76	4.68	2.37	
10	4.2V	+22°C	8.47	6.43	5.09	
11	3.6V	+22°C	9.19	4.85	5.07	

Result: PASS

*****END OF REPORT*****