

SmartClass

Triple Play Services Tester

User's Guide

SmartClass

Triple Play Services Tester

User's Guide



Network and Service Enablement
One Milestone Center Court
Germantown, Maryland 20876-7100 USA
Toll Free 1-855-ASK-JDSU • Tel +1-301-353-1560 • Fax +1-240-404-1996
www.jdsu.com

Notice

Every effort was made to ensure that the information in this document was accurate at the time of printing. However, information is subject to change without notice, and JDSU reserves the right to provide an addendum to this document with information not available at the time that this document was created.

Copyright

© Copyright 2014, JDS Uniphase Corporation. All rights reserved. JDSU, Enabling Broadband and Optical Innovation, Communications Test and Measurement Solutions, and the JDSU logo are trademarks of JDS Uniphase Corporation (“JDS Uniphase”). All other trademarks are the property of their respective owners. No part of this guide may be reproduced or transmitted electronically or otherwise without written permission of the publisher.

Copyright release

Reproduction and distribution of this guide is authorized for Government purposes only.

Trademarks

Broadcom is either a trademark or registered trademark of Broadcom Corporation in the United States and/or other countries.

Cisco is a registered trademark of Cisco Systems, Inc. and/or its affiliates in the U.S. and certain other countries.

iPad is a registered trademark of Apple, Inc. in the United States and/or other countries.

JDS Uniphase, JDSU, and SmartClass are trademarks or registered trademarks of JDS Uniphase Corporation in the United States and/or other countries.

Microsoft and Internet Explorer are either a trademarks or registered trademarks of Microsoft Corporation in the United States and/or other countries.

Netscape and Netscape Navigator are either trademarks or registered trademarks of AOL LLC in the United States and/or other countries.

NETGEAR is a registered trademark of NETGEAR, Inc. and/or its affiliates in the U.S. and certain other countries.

Rolling Stream is either a trademark or registered trademark of UTStarcom Inc. in the United States and/or other countries.

Specifications, terms, and conditions are subject to change without notice. All trademarks and registered trademarks are the property of their respective companies.

Ordering information

This guide is a product of JDSU's Technical Information Development Department, issued as part of the SmartClass TPS. The catalog number for a printed guide is SCTP-Manual-Printed. The catalog number for a USB stick containing all user documentation and utilities is SCTP-USB-G2.

Terms and conditions

Specifications, terms, and conditions are subject to change without notice. The provision of hardware, services, and/or software are subject to JDSU's standard terms and conditions, available at www.jdsu.com/terms.

Federal Communications Commission (FCC) Notice

This equipment has been tested and found to comply with the limits for a Class A digital device, pursuant to Part 15 of the FCC Rules. These limits are designed to provide reasonable protection against harmful interference in a residential installation. This equipment generates, uses and can radiate radio frequency energy and, if not installed and used in accordance with the instructions, may cause harmful interference to radio communications. However, there is no guarantee that interference will not occur in a particular installation.

This device complies with Part 15 of the FCC Rules. Operation is subject to the following two conditions: (1) This device may not cause harmful interference, and (2) This device must accept any interference received, including interference that may cause undesired operation.

If this equipment does cause harmful interference to radio or television reception, which can be determined by turning the equipment off and on, the user is encouraged to try to correct the interference by one or more of the following measures:

- Reorient or relocate the receiving antenna.
- Increase the separation between the equipment and receiver.
- Connect the equipment into an outlet on a circuit different from that to which the receiver is connected.
- Consult the dealer or an experienced radio/TV technician for help.

In order to maintain compliance with the limits of a Class A digital device JDSU requires that quality interface cables be used when connecting to this equipment. Any changes or modifications not expressly approved by JDSU could void the user's authority to operate the equipment.

CAUTION:

- 1 To comply with FCC RF exposure compliance requirements, a separation distance of at least 20 cm must be maintained between the antenna of this device and all persons.
- 2 This transmitter must not be co-located or operating in conjunction with any other antenna or transmitter.

Industry Canada Requirements

This device complies with Industry Canada license-exempt RSS standard(s). Operation is subject to the following two conditions: (1) this device may not cause interference, and (2) this device must accept any interference, including interference that may cause undesired operation of the device.

Le présent appareil est conforme aux CNR d'Industrie Canada applicables aux appareils radio exempts de licence. L'exploitation est autorisée aux deux conditions suivantes : (1) l'appareil ne doit pas produire de brouillage, et (2) l'utilisateur de l'appareil doit accepter tout brouillage radioélectrique subi, même si le brouillage est susceptible d'en compromettre le fonctionnement.

This equipment complies with Industry Canada radiation exposure limits set forth for an uncontrolled environment.

Cet équipement est conforme à l'exposition aux rayonnements Industry Canada limites établies pour un environnement non contrôlé.

This Class A digital apparatus complies with Canadian ICES-003.

Cet appareil numérique de la classe A est conforme à la norme NMB-003 du Canada.

CAUTION:

This transmitter must not be co-located or operating in conjunction with any other antenna or transmitter.

Cet émetteur ne doit pas être co-localisées ou opérant en conjonction avec une autre antenne ou émetteur.

R&TTE Directive Compliance

This product is in compliance with essential requirements and other relevant provisions of Directive 1999/5/EC.

Low Voltage Directive Compliance

This product was tested and conforms to the Low Voltage Directive, 73/23/EEC as amended by 93/68/EEC. Conformity with this directive is based upon compliance with the harmonized safety standard, EN60950.

WEEE and Battery Directive Compliance

JDSU has established processes in compliance with the Waste Electrical and Electronic Equipment (WEEE) Directive, 2002/96/EC, and the Battery Directive, 2006/66/EC.

This product, and the batteries used to power the product, should not be disposed of as unsorted municipal waste and should be collected separately and disposed of according to your national regulations. In the European Union, all equipment and batteries purchased from JDSU after 2005-08-13 can be returned for disposal at the end of its useful life. JDSU will ensure that all waste equipment and batteries returned are reused, recycled, or disposed of in an environmentally friendly manner, and in compliance with all applicable national and international waste legislation.

It is the responsibility of the equipment owner to return equipment and batteries to JDSU for appropriate disposal. If the equipment or battery was imported by a reseller whose name or logo is marked on the equipment or battery, then the owner should return the equipment or battery directly to the reseller.

Instructions for returning waste equipment and batteries to JDSU can be found in the Environmental section of JDSU's web site at www.jdsu.com. If you have questions concerning disposal of your equipment or batteries, contact JDSU's WEEE Program Management team at WEEE.EMEA@jdsu.com.



Table of Contents

About this Guide	xiii
Purpose and scope	xiv
Assumptions	xiv
Safety and compliance information	xiv
Conventions	xiv

Chapter 1 Getting Started	1
About the SmartClass TPS	2
Ship list	2
Configurations and options	2
Configurations	3
Software options	3
Features and capabilities	4
Preparation for use	6
General preparation	6
Changing the AC line plug fitting	7
Exploring the front panel	8
Status LEDs	8
LCD	9
Cancel key	9
OK key	9
Arrow keys	9
Keypad	9
Utility key	9
Power key	10
Exploring the connector panel	11
DSL connector	11
POTS connector	11
USB host connector	11
Ethernet connector	12

Exploring the bottom panel	12
Exploring the top panel	13
Navigating the user interface	13
Menu screens	14
Data entry screens	15
Result screens	15
Scroll bar	15
Colors	15
Ellipses	16
Using the keypad	16
Selecting a menu option	16
Specifying On/Off or Yes/No values	16
Entering numeric values	16
Typing text	16
Using a USB keyboard	17
Customizing the user interface	17
<hr/>	
Chapter 2 Instrument Settings	19
Managing files	20
Managing jobs	21
Creating and editing jobs	21
Activating a job	22
Exporting a job	22
Deleting a job	22
Associating test results to a job	23
Communicating with a mobile device	23
Accessing the SmartClass Triple Play Services remotely using VNC	24
Setting the date and time	25
Setting the date	25
Setting the time	26
Specifying auto power down settings	26
Adjusting the screen settings	27
Changing keypad setup	27
Setting the repeat delay	27
Setting the repeat rate	27
Specifying the volume level	28
Specifying international settings	28
Managing test configurations	29
Saving test configurations	29
Loading a configuration	29
Viewing unit revisions, options, and IDs	30
Restoring factory defaults	30
<hr/>	
Chapter 3 Automated Testing	31
About the automated tests	32
Running the OneCheck test	32
Running the VideoCheck test	34

Chapter 4	Using the SmartClass TPS with a mobile device	35
	Controlling the SmartClass with a mobile device	36
	Controlling the device interface	37
	Testing with SmartIDs	37
	Viewing video on a mobile device	39
Chapter 5	Ethernet TE Testing	41
	About Ethernet TE testing	42
	Specifying the network setup	42
	Connecting to the line	44
	Viewing results	45
Chapter 6	DSL Testing	47
	About xDSL testing	48
	BCM96368 test options	48
	BCM963168 test options	48
	Selecting the test mode	49
	Specifying test settings	49
	Specifying the modem operation	50
	Specifying DSL settings	52
	Specifying DSL (single line) settings	52
	Specifying DSL settings for Bonded mode (For BCM96368 modem only)	53
	Specifying network settings	54
	Specifying WAN settings	54
	Specifying LAN settings	56
	Connecting to the line	57
	Connecting to a single twisted pair	57
	Connecting to bonded twisted pairs	57
	Connecting to a single pair at the NID/demarc	58
	Connecting to bonded pairs at the NID/demarc	58
	Testing the physical layer	58
	Testing line quality	58
	Terminating the loop (SELT)	60
Chapter 7	Data testing	61
	About data testing	62
	Connecting to the line	62
	IP Ping testing	62
	Monitoring pings	63
	Throughput testing	64
	Tracing the packet route	65
	Capturing network traffic	65

Chapter 8	Wi-Fi Testing	67
	About Wi-Fi Testing	68
	Scanning for Wi-Fi networks.....	68
	Emulating a Wi-Fi end point	70
	Providing Wi-Fi access	71
Chapter 9	HPNA Testing	73
	About HPNA Testing	74
	Connecting to the line	74
	Monitoring the HPNA network	74
	Testing the HPNA network	75
Chapter 10	SmartID Testing	77
	About the SmartIDs	78
	Registering SmartIDs.....	79
	Configuring SmartID settings	79
	Locating SmartIDs	80
	Testing the home run for VDSL service.....	81
	Testing the home network.....	82
Chapter 11	VoIP Testing	85
	About VoIP	86
	Specifying test settings.....	86
	Connecting to the line	91
	Placing and receiving calls	91
	Placing a call	91
	Receiving a call	92
	Answering calls automatically	92
Chapter 12	IP Video Testing	95
	About IP Video Testing	96
	Specifying test settings.....	97
	Connecting to the line	100
	Analyzing video streams.....	100
	Terminate mode.....	100
	Monitor mode.....	101
	VideoCheck test	101
Chapter 13	Web browser	103
	About the web browser	104
	Browsing the web	104
	Navigating the browser	104

Scrolling the view	104
Selecting links	105
Moving among or refreshing pages	105
Typing text in a field	105
Selecting items in a drop-down list	106
Exiting the browser	106
<hr/>	
Chapter 14 Optical Tools	107
About the optical tools	108
Measuring optical power	108
<hr/>	
Chapter 15 Copper Testing	111
About copper testing	112
Cord compensation	112
Specifying Copper settings	113
Running a CableCheck	114
Performing a snapshot test	114
Running copper measurements	115
Placing and receiving POTS calls	117
Calibrating the unit	117
<hr/>	
Chapter 16 Test Results	119
Saving results	120
Saving results to a file	120
Saving results to a job	120
Network Status	121
LAN Statistics	122
DSL Results	122
Summary	122
Bonded DSL statistics (For Catalogs CSC-TPSVW and CSC-TPSVW-CU only)	123
Signal	123
SNR Margin	124
DSL Errors	124
DSL Alarms	125
Band statistics	125
G.INP statistics	125
DSL Identity	125
Tone Graphs	126
Navigating the graph	126
Troubleshooting using the graphs	126
ATM results	127
Cell Count	127
Errors	127
IP Data results	128
Ping results	128
File Transfer results	128

Traceroute results	129
Wi-Fi results	129
Status	129
Results	130
HPNA results	130
SmartID results	131
Test Summary	131
Detailed View	131
Network Map	132
Sweep Data	132
VoIP results	132
Call Information results	132
Throughput	132
Audio Delay	132
Audio Quality Scores	133
Local and Remote QoS	134
Video results	134
Stream Results	134
Video Results	135
Optical power results	135
Copper results	135
AC voltage	135
DC voltage	136
Resistance	136
Distance to short	137
Leakage	137
Opens/Capacitance	137
DC current	138
Longitudinal balance	139
Good Ground check	139
Load coil	139
<hr/>	
Chapter 17 StrataSync	141
About StrataSync	142
Synchronizing to the StrataSync server	142
<hr/>	
Chapter 18 Maintenance and Troubleshooting	145
Cleaning the instrument	146
Prolonging battery life	146
Recharging the battery	146
Replacing the battery pack	147
Updating the software	148
Adding options	149
Getting Technical Assistance	149
Additional information	150
Resolving problems	150
Operating the unit	150

Performing tests	151
General test problems	151
DSL test problems	151
Data test problems	152
VoIP test problems	154
Video test problems	156
Copper test problems	157

Appendix A Specifications	161
Physical specifications	162
Connector specifications	162
Environmental specifications	162
Safety specification	162
Power specifications	163
Calibration	163
Self calibration	163
Factory calibration	163
Warranty information	163



About this Guide

This chapter describes how to use this guide. Topics discussed in this chapter include the following:

- [“Purpose and scope” on page xiv](#)
- [“Assumptions” on page xiv](#)
- [“Safety and compliance information” on page xiv](#)
- [“Conventions” on page xiv](#)

Purpose and scope

The purpose of this guide is to help you successfully use the features and capabilities of the Smart-Class Triple Play Services (TPS).

This guide includes task-based instructions that describe how to configure, use, and troubleshoot the general functions of the SmartClass Triple Play Services. Additionally, this guide provides a description of JDSU's warranty. For terms and conditions of the licensing agreement, go to go to www.jdsu.com.

Assumptions

This guide is intended for novice, intermediate, and experienced users who want to use the Smart-Class TPS effectively and efficiently. We are assuming that you have basic computer experience and are familiar with basic telecommunication concepts, terminology, and safety.

Safety and compliance information

Safety and compliance information are contained in a separate guide and are provided in printed format with the product.

Conventions

This symbols and safety terms used in this guide are described in the following tables.

Table 1 Symbol conventions





	This symbol represents a general hazard.
	This symbol represents a risk of electrical shock.
	This symbol represents a risk of explosion
	This symbol represents a Note indicating related information or tip.
	This symbol, located on the equipment, its battery, or its packaging indicates that the equipment must not be disposed of in a land-fill site or as municipal waste, and should be disposed of according to your national regulations.

Table 2 Safety definitions

DANGER	Indicates an imminently hazardous situation which, if not avoided, will result in death or serious injury.
WARNING	Indicates a potentially hazardous situation which, if not avoided, could result in death or serious injury.
CAUTION	Indicates a potentially hazardous situation which, if not avoided, may result in minor or moderate injury.

Getting Started

This chapter provides a general description of the SmartClass Triple Play Services. Topics discussed in this chapter include the following:

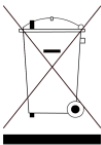
- [“Ship list” on page 2](#)
- [“Configurations and options” on page 2](#)
- [“Features and capabilities” on page 4](#)
- [“Preparation for use” on page 6](#)
- [“Exploring the front panel” on page 8](#)
- [“Exploring the connector panel” on page 11](#)
- [“Exploring the bottom panel” on page 12](#)
- [“Exploring the top panel” on page 13](#)
- [“Navigating the user interface” on page 13](#)
- [“Using the keypad” on page 16](#)
- [“Customizing the user interface” on page 17](#)

About the SmartClass TPS

The SmartClass TPS is an all-in-one tool that fully test the access network (copper, fiber, POTS, and ADSL2+/VDSL2 including bonded pairs) as well as broadband services (data, VoIP, and IP video) so technicians can rapidly correlate and resolve triple-play service problems to potential physical-layer causes.

The JDSU SmartClassTPS (<product name>) tester helps field technicians who roll out broadband access networks and services deliver a pristine copper access infrastructure that can support triple-play services and meet critical quality of service (QoS) and quality of experience (QoE) requirements.

This all-in-one DSL tester tool can test copper, fiber, asymmetrical and very high speed digital subscriber lines including bonded VDSL2 pairs Internet Protocol (IP) data, voice over IP (VoIP), and IP video with straightforward pass/fail results and detailed analysis of physical-and application-layer-related problems.

The OneCheck and VideoCheck one button automated testing applications help technicians significantly reduce testing times and improves overall quality. The SmartClass TPS verifies the physical health of the access copper loop, digital subscriber line (DSL) performance, and QoS/QoE of triple-play services to ensure that field technicians have successfully completed the installation and repair job. Operators and service providers can more quickly locate and repair faults and, thus, guarantee their service quality.

Ship list

The SmartClass Triple Play Services typically ships in anti-static packing material to stabilize the unit inside the box. The following are typical items that ship with the SmartClass Triple Play Services:

- SmartClass Triple Play Services
- Universal Power Adapter — A power adapter designed specifically for the SmartClass Tester is included. When supplying power to the SmartClass Tester using an adapter, you must use this adapter. Additional AC line plug adapters are also included.
- Carrying Bag
- Rechargeable Lilon Battery Pack (installed)
- Ethernet Cable (CAT5 shielded RJ-45)
- RJ-45 DSL to 2-Telco Clips Cable
- Banana to 3-Clips Cable (only included if the unit includes the Copper option)
- Documentation USB. The User's Guide is included as a PDF on the USB. Safety and compliance information are provided separately, in printed format.

When unpacking the unit, verify that each of the standard items, and any optional items you ordered, are included in the package.

Configurations and options

The SmartClass Triple Play Services is available in several configurations and software options are available to enhance your instrument's test capabilities.

Configurations

The SmartClass Triple Play Services is factory-configured to meet your testing requirements. When you place an order for a SmartClass Triple Play Services, a customer service or sales representative will help you determine the right configuration for your needs.

Table 3 describes the available configurations for the BCM96368 modem.

Table 3 SmartClass Triple Play Services configurations for BCM96368

Catalog Number	Configuration
CSC-TPSVW	SmartClass TPS VDSL (Broadcom) with Wi-Fi
CSC-TPSVW-CU	SmartClass TPS VDSL (Broadcom) with Wi-Fi and Copper

Table 4 describes the available configurations for the BCM963168 modem.

Table 4 SmartClass Triple Play Services configurations for BCM963168

Catalog Number	Configuration
SCTPS-AB	SmartClass TPS VDSL Mainframe (ANX A/B – VDSL 30a)
SCTPS-AB-CU	SmartClass TPS VDSL/Copper Mainframe (ANX A/B – VDSL 30a)

Software options

You can order software options to add functionality to the SmartClass Triple Play Services. Table 5 lists the software options offered for the Triple Play Services.

Table 5 SmartClass Triple Play Services software options

Catalog Number	Option
SCTP-APP-REV01	Mobile App Connectivity (Revision 1) option
SCTP-HPNA	HPNA Test option
SCTP-IPVIDEO	Allows you to test IP Video services.
SCTP-MOS	Mean Opinion Score (MOS) analysis option for VoIP
SCTP-SCCP	VoIP Signalling option for Cisco SCCP
SCTP-VMOS	Mean Opinion Score (MOS) analysis option for IP Video
SCTP-VOIP	Allows you to place and receive calls using internet protocol (IP), and analyze the call quality.
SCTP-WEB	Allows you to view and navigate web sites using a DSL or Ethernet interface.
SCTP-WIFI	Wi-Fi Test option
SCTP-ANXB	ADSL1/2/2+ Annex B Software Option

To discuss a specific configuration or to order options and accessories for your SmartClass Triple Play Services, contact JDSU Customer Care or your regional sales office. Contact information for regional sales headquarters is provided on the back cover of this manual. You can also contact JDSU through the company web site, www.jdsu.com.

Features and capabilities

Features and capabilities of the SmartClass Triple Play Services include the following:



NOTE:

The features available on your unit depend on which unit configuration was ordered and which options are installed.

xDSL

- Turn up and troubleshoot DSL services
- Provide packet statistics and analysis.
- Supports G.992.5
- Supports INP >2 (Impulse Noise Protection settings greater than 2)
- Compatibility with VDSL, ADSL2+, and ADSL1 service
- VDSL2 PTM Bonding
- VDSL2 ATM Bonding
- Supports Vectoring
- Supports SOS
- ADSL2+ ATM Bonding
- ADSL2+ PTM Bonding
- RE-ADSL support (Reach Extended ADSL2 - "Annex L")
- Supports G.INP
- BPT, SNR, Hlog per tone, and QLN per tone graphs

IP Data

- IP layer testing over PPPoE, PPPoA, IPoA, and IPoE including:
 - IP ping (IPoE and IPv6oE)
 - FTP/HTTP throughput
 - Trace route
- Terminate/Through Mode testing
- Web Browser

WiFi

Coax

- Testing with SmartID accessories

HPNA

VoIP

- Phone Emulation
- Voice conversation/generate tone/IP voice announce

- Auto answer mode
- Real-time packet metrics (delay, jitter, packet loss)
- E-model QoS and RTCP statistics
- User selectable CODEC

IP Video

- STB Emulation
- Monitor/Through mode
- IP Video QoX (QoS, QoE)
- VMOS
- RTP Loss Distance/Period

STB Boot Test

- Refer to the *SmartClass Triple Play Services Tester Addendum to User Guide for STB Boot Test* (document number).

Optical Power

- Testing with the MP60 and MP-80 optical power accessories

Copper

- AC volts
- DC volts
- Resistance
- Leakage
- Distance to short
- Opens (distance) and capacitance
- DC current
- Balance
- Load coil detect
- Good ground test
- POTS calls

Ease of use

- Configurable User Interface
- Save test report to USB stick
- Sent test reports to a FTP server
- Job Manager

StrataSync

- Upload and share test results

- Upload and download configuration files
- Download and enable options
- Check and upgrade software updates

Mobile Device Application

- Support for iOS, and support for Android
- Remote control the SmartClass TPS
- Video Continuity Check from STB
- Technician support content (user manual, quick start guide, training videos, accessory guide)

Preparation for use

This section explains how to start using your SmartClass Triple Play Services.

General preparation

When you unpack the SmartClass Triple Play Services, do the following:

- Inspect the tester for damage.
- If undamaged, save the box and packing materials in case you need to ship the tester in the future.

Before using the SmartClass Triple Play Services for the first time, do the following:

- Charge the battery.
- Turn the unit ON, and then verify that it is operating properly by navigating through a few menus.

Changing the AC line plug fitting

The SmartClass Triple Play Services's AC Adapter/Charger allows different AC line plug fittings.

To change the AC line plug fitting

- 1 If an AC line plug fitting is already installed, do the following:
- 2 Press and hold the button just below the fitting.
- 3 Slide the fitting out of the slot.



- 4 Select the appropriate AC line plug adapter.
- 5 Slide the AC line plug adapter into the slot.
You will hear a click when the fitting is fully inserted.

The AC Adapter/Charger is ready for use.

Exploring the front panel

The controls and LEDs on the SmartClass Triple Play Services front panel, shown in [Figure 1](#), are used to operate the unit, set up tests, and view data.



Figure 1 SmartClass Triple Play Services front panel

The following paragraphs describe each of the controls and LEDs on the front panel.

Status LEDs

The LEDs on the front panel report the status of the unit. The function of each LED is described in [Table 6](#).

Table 6 Status LEDs

LED	Function
Sync	Reports the status of modem synchronization. <ul style="list-style-type: none"> Flashing green indicates that the modem is training. Solid green indicates that the modem is synchronized.
Frame	Reports the status of the data connection. Solid green indicates that a data connection has been established with the network (so that the Triple Play Services may send and receive data on the network).
Error	Reports error and alarm conditions. Solid red indicates one of the following: CRC, LOF, LOS, LOM, or LOF.

Table 6 Status LEDs (Continued)

LED	Function
Batt	<p>A multi-color LED that indicates the battery status.</p> <ul style="list-style-type: none"> – Solid green indicates that an external source is powering the unit. – Solid red indicates a low battery - 10% of battery life (at 5%, the LED blinks to indicate that the unit will shut down soon if the adapter is not plugged in). – Solid amber indicates the battery is charging. – The LED is off when the unit is running on battery power and the battery has sufficient charge.

LCD

The LCD is a 320 x 240 pixel color display with contrast, brightness, and backlight controls.

Cancel key

Use the Cancel key to exit a menu and to return to the previous menu.

OK key

Use OK to accept a changed setting or to proceed to the next menu.

Arrow keys

Use the arrow keys to navigate through menu selections.

Keypad

Use the keypad to enter numbers, make menu selections, enter alphabetic characters, and so on. Throughout the menus, the numbers associated with each function provide a quick way to perform tests with simple number sequences.

Utility key

Use the  Utility key to view the Information menu, which gives access to additional menus. The menus that display will vary depending on where within the menu structure you pressed the Utility key. For example, when using the Web Browser, there are items specific to the browser, such as previous page and refresh; or when testing DSL, and you press it when viewing the Hlog graph, there is a selection to Calculate the Bridge Tap Length.









Information – displays the technical assistance phone number.

The phone number that appears depends on the Country setting you specified on the International Settings menu. For example, if you set the country to Belgium, the JDSU Germany phone number appears.

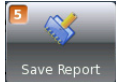
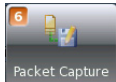

Home – returns to the main menu. **NOTE:** If you press this during a test, the test will be stopped.

	System Setup – a shortcut to the main System Setup menu. For more information on this menu, see “Instrument Settings” on page 19).
	Capture screen shot – saves the screen as a .png file. (NOTE: The Utility menu itself cannot be captured this way. To capture the Utility menu, remotely access the unit and capture it using the PrintScreen (PrtScn) key on the PC.)
	Report Settings – specify the filename, file format, report header information, and other details related to the report.
	Packet Capture – Shortcut to the Packet Capture menu, used to capture network packets to a file on the SmartClass or to a file on a USB drive.
	Outdoor Mode – changes the screen’s settings for better viewing outdoors.
	Save To Job – launches the Save Test Result menu, allowing the results to be saved to a specific job or saved to a file. See “Saving results” on page 120 .)
	Menu Settings – customize the user interface. (For example, increase font size, move menu item up or down in the list, and so on. See “Customizing the user interface” on page 17 .)

The available menus vary depending on the layout of the active menu when you press the Utility key. Items 1 through 6 are always available. Items 7 and 8 are only available on list menus (tile menus cannot be customized). For more detail on menus and layouts, see [“Navigating the user interface” on page 13](#).

Power key

Use the  power key to turn the unit power on or off. Press and hold for 2 seconds to turn on. Press to turn off, and then OK to confirm.

Exploring the connector panel

The SmartClass Triple Play Services connector panel is used to connect to the line under test. Figure 2 shows the connector panel.

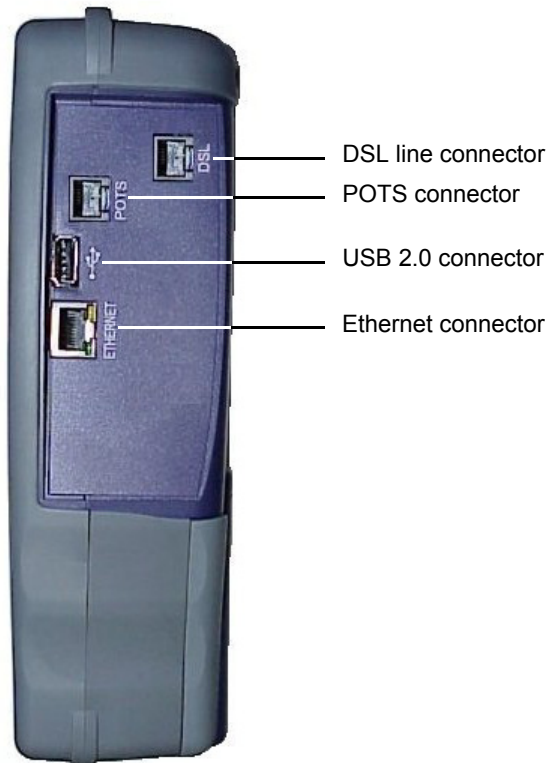

Figure 2 SmartClass Triple Play Services connector panel

The connector panel varies slightly depending on the configuration. The following paragraphs describe each of the connectors on the right-side connector panel.

DSL connector

Use the 8-pin modular **DSL** jack when connecting to DSL circuits.



CAUTION: FIRE HAZARD

To reduce the risk of fire, use only 26 AWG / 0.6mm or larger telecommunications line cord between the DSL jack and the wall.

POTS connector

Use the POTS connector when placing or receiving POTS calls.

USB host connector

Use the USB host connector (USB 2.0) for saving results and configurations, or for firmware updates.

Ethernet connector

Use the Ethernet connector with an Ethernet cable when in either DSL through mode or Ethernet TE mode.



NOTE:

The Ethernet port is auto configured to accept either a patch or cross-over cable.



WARNING: ELECTRICAL SHOCK

Electrical shock may result in serious injury or death. Use care when connecting to telecommunications circuits, to be sure that you do not come in contact with exposed conductors or power mains. Connect TNV signals to TNV ports only.



NOTE: ELECTROSTATIC DISCHARGE IMMUNITY

When using an Ethernet crossover cable, JDSU recommends using a shielded crossover cable for the best immunity to electrostatic discharge (ESD).

Exploring the bottom panel

The SmartClass Triple Play Services's AC Adapter/charger and USB device port are located on the bottom panel.

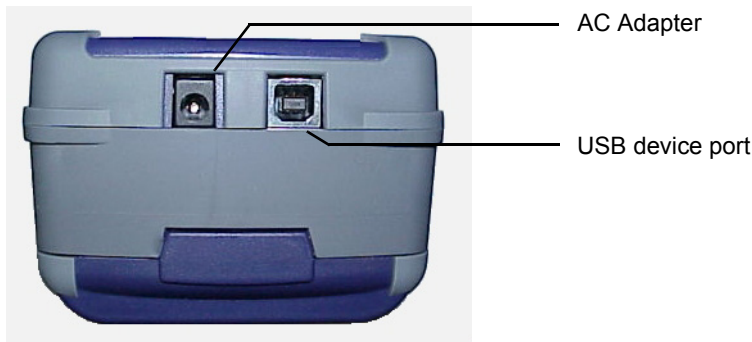

Figure 3 SmartClass Triple Play Services bottom panel

Exploring the top panel

If equipped with the Copper option, the top panel of the SmartClass Triple Play Services includes three mini-banana jacks, as shown in [Figure 4](#).



Figure 4 SmartClass Triple Play Services top panel

These are used to connect to Tip (A), Ring (B), and ground (sleeve or Earth).



CAUTION: INSTRUMENT DAMAGE

Connecting to circuits with voltage higher than 300V peak-peak, compared to ground, may damage the internal components. Connect only to circuits with less than 300V.



WARNING: ELECTRICAL SHOCK

Electrical shock may result in serious injury or death. Use care when connecting to telecommunications circuits, to be sure that you do not come in contact with exposed conductors or power mains. Connect TNV signals to TNV ports only.

Navigating the user interface

The user interface of the SmartClass Triple Play Services is designed to be intuitive and easy to use. Using the LCD and keypad, you can view test results, set up the unit, and configure test parameters. This section describes the user interface, and explains how to navigate through the menus and screens.

When you power up the SmartClass Triple Play Services, the user interface appears. [Figure 5](#) shows the main menu.



Figure 5 SmartClass TPS Main Menu

The items on this menu vary, depending on the configuration and options.

The upper right area of the main screen provides a quick status of the following:

- battery strength
- whether the adapter is being used (the lightning bolt)
- the time

There are two layouts of menus:

- Tile - the selections are on square tiles, as seen on the Main Menu (Figure 5)
- List - the selections appear in a list, as seen on the Network menu (Figure 6) or DSL Results (Figure 7).

There are three types of screens on the user interface:

- Menu screens
- Data entry screens
- Results screens

Menu screens

Figure 6 illustrates a typical Menu screen.

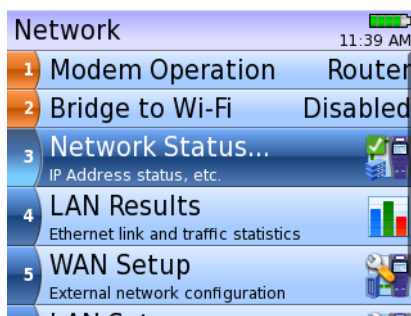

Figure 6 SmartClass Triple Play Services Menu screen (example)

Menu screens provide a series of selections that take you to another menu screen, a data entry screen, or a results screen.

Data entry screens

Figure 7 illustrates a typical Data entry screen.

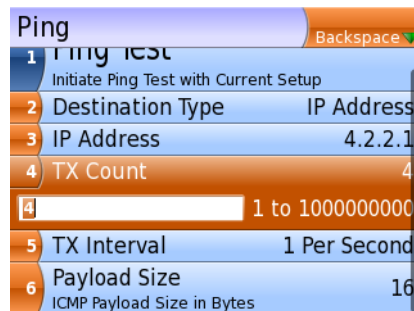

Figure 7 SmartClass Triple Play Services Data entry screen (example)

Data entry screens provide you selections to either choose from a list of options, or enter data using the keypad. Use the up arrow to change the entry type (**ABC** is upper case, **abc** is lower case, **123** is numeric), or the down arrow to delete one character to the left.

Result screens

Figure 8 illustrates a typical Result screen.

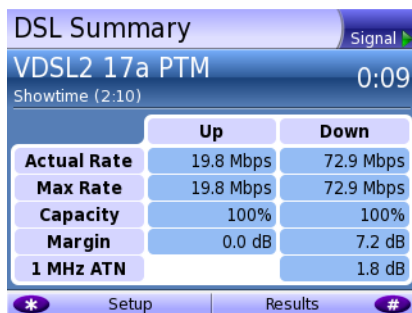

Figure 8 SmartClass TPS Result screen (example)

These screens display test results or error logs. The results are split into categories. Press the arrow keys to navigate among the results categories (screens).

Scroll bar

If a screen has more items than can be displayed, a scroll bar appears momentarily when you scroll up or down among the items. While at the top or bottom of a menu, you can press and hold the up or down arrow for one second to wrap back around (for example, at the bottom, hold the down arrow to wrap up to the top).

Colors

The color of the menu item changes, depending on the type of menu: for data entry screens, the item number is white in an orange background; for menu screens, the item number is white in a dark blue background.

Ellipses

The ellipses (...) character appears at the end of a highlighted menu item to indicate that this item will take you to another screen (such as “Network Status...” in [Figure 6 on page 14](#)).

Using the keypad

Use the instrument’s keypad to enter alpha-numeric values, or to navigate to different screens by specifying the menu number corresponding to the screen.

Selecting a menu option

There are two ways to select a menu option.

- Use the arrow keys to scroll to the desired option then press the OK key.
- Press the number associated with the menu option.

Specifying On/Off or Yes/No values

On a data entry screen you enter data or specify values. There are two ways to specify on/off or yes/no values.

- Use the arrow keys to scroll to the desired option then press the OK key to toggle the value on or off.
- Press the number associated with the menu option to toggle the value on or off.

Entering numeric values

To enter numeric values

- 1 Use the arrow keys to scroll to and highlight the setting you want to specify.
- 2 Press OK.
- 3 Use the up arrow to change the entry type to numeric (**123** in upper right area of screen).
- 4 Use the keypad to type the numeric value.

Typing text

To type text

- 1 Use the arrow keys to scroll to and highlight the setting you want to specify, and then press OK.

- 2 Use the keypad to type the text.
 - Repeated presses scroll through the selections for that key. For example, repeatedly pressing the 2 key will scroll through A, B, C and 2.
 - To enter special characters, use either the asterisk/star or pound/hash key until the desired character appears.

The same characters are available with both keys, but they scroll in opposite directions. This is helpful if you scroll past the desired character because you can go back using the other key rather than scrolling all the way back around.
 - To cycle through upper/lower case and numeric entry, press the up arrow. This is indicated in the upper right area of the screen with “abc, ABC, or 123”.
 - Use the down arrow to backspace (delete one character to the left).
 - To move to the next field, either wait one second for the cursor to jump, or use the right arrow key.
 - If you move the cursor between characters, typing characters will insert new characters at that location. To append characters, position the cursor at the end of your text, after the last character.

Using a USB keyboard

If you connect a USB keyboard to the instrument, you can use it to navigate the menus and control the instrument.

- Use the arrow keys to navigate.
- Use the numbered keys to select a menu item or for entering numbers.
- Use Enter as the OK key.
- Use Esc as the Cancel key.
- Use F5 key as the Utility key.

Customizing the user interface

The Utility key allows you to customize the user interface. For example, you can move more important menu items up to the top of the screen, increase the font size, hide less important items, and so on. Note: this feature is only available on list menus (tile menus cannot be customized).

To customize the interface

- 1 Navigate to the menu you wish to customize.
- 2 Press the **Utility** key, and then select **Edit Menu**.

- 3 Choose one of the following:
 - Increase Font Size
 - Decrease Font Size
 - Move Item Up
 - Move Item Down
 - Make Hidable (This will hide the menu item and a “Show More” line will appear at the bottom of the screen to show the hidden items.)
To unhide the item, return to the hidden menu item, press the Utility key, press 8, and then select “Show Always”.

If a selection is greyed out, it is not available. For example, if Decrease Font Size is greyed out, the font is at the smallest size allowed.
- 4 Continue with steps 1 through 3 until the interface is customized as desired.
- 5 *Optional.* To return the user interface to factory defaults, press the **Utility** key, and then select **Restore Menu**.

Instrument Settings

This chapter describes how to configure the basic system settings of the instrument. Topics discussed in this chapter include the following:

- [“Managing files” on page 20](#)
- [“Managing jobs” on page 21](#)
- [“Communicating with a mobile device” on page 23](#)
- [“Accessing the SmartClass Triple Play Services remotely using VNC” on page 24](#)
- [“Setting the date and time” on page 25](#)
- [“Specifying auto power down settings” on page 26](#)
- [“Adjusting the screen settings” on page 27](#)
- [“Changing keypad setup” on page 27](#)
- [“Specifying the volume level” on page 28](#)
- [“Specifying international settings” on page 28](#)
- [“Managing test configurations” on page 29](#)
- [“Viewing unit revisions, options, and IDs” on page 30](#)
- [“Restoring factory defaults” on page 30](#)

Managing files

The File Manager enables you to open, copy to unit, or delete files or folders either on the internal filing system or a USB flash drive.

To manage files

1 From the Main menu, select **System Settings**, and then select **File Management**.

2 Select **File Browser**.

If you have a USB memory stick inserted, an additional menu appears to browse Local files or the USB device.

A list of folders appears.



3 Use the asterisk (*) key to view the file or folder options.

– To **copy** file or folder/directory, do the following:

a Press the * key to view the options.

b Press the 1 key to copy.

c Navigate to the desired location (where you want to paste the file/folder).

d Press the # key to paste the directory.

This is only available if you have copied a file or folder.

– To **view** files inside a folder, highlight a folder and then press OK. A list of files appears.

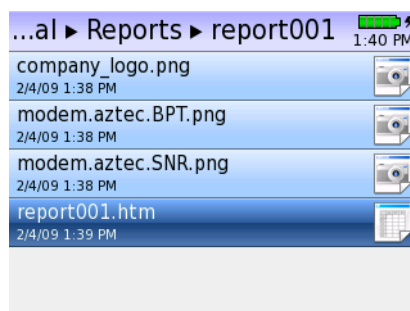

A screen shot or logo will have a camera icon, report files will have an icon that looks like a spreadsheet.

– To **open** a file, navigate to the desired file, press the OK key.

The contents of the file appear.

- To **copy** a file or entire folder to a USB stick, navigate to the desired file or folder, press the * key, and then select **Copy to USB**. The file or folder is copied. If no USB stick is inserted, the selection will not be selectable; the number will not have a box around it and the text will be grey.
- To **rename** a file or folder, navigate to the desired file or folder, press the * key, and then select **Rename**. A box appears to enter the new name. Enter the name, and then press OK.
The new file or folder name appears in the list.
- To **transfer** your test reports to a server, navigate to the desired file or folder, press the * key, and then select **Send to Remote Server**. A setup screen appears to specify the server address and directory, as well as the login and password. Press # to send the file. Note: This will typically be a company-provided server that you are given access to.
- To **delete** a file or entire folder, navigate to the desired file or folder, press the * key, and then select **Delete**. An acknowledgement screen appears. Press OK to delete.

Managing jobs

The Job Manager is used to associate test results from different applications to a single job.

Tests supported:

- DSL test (sync)
- OneCheck (DSL, Ethernet TE, and Wi-Fi Network)
- Wi-Fi Scan test
- SmartID test
- HPNA Network test
- CableCheck for Copper Pair Test
- Optical Power Meter test

If any jobs have been saved, they appear in the list. The Job Manager allows you to setup a new job, edit an existing job, activate a job, or delete a job.

Creating and editing jobs

To create a new job or edit an existing job

- 1 From the System Settings menu, select **Job Manager**.
- 2 Select Job Management.
The Job Manager screen appears. If any jobs have been created, they will be listed on the screen.
- 3 Do one of the following:
 - To create a new job, press the * key.
 - To edit an existing job, highlight the job, and then press OK.
The Job Edit screen appears.

- 4 Navigate to the field to edit, and then enter the information.

The new or updated job appears on the list.



NOTE:

Newly created jobs are automatically activated.

Activating a job

To activate a job

- 1 On the Job Manager screen, highlight the job to activate, and then press the OK key.
The Job Edit menu appears.
- 2 Verify the job details and modify the details if needed.
- 3 Press the * key to activate.
The Job Management Menu appears.

Exporting a job

To export a job

- 1 From the Job Manager menu, select **Job Export**.
The Job List appears.
- 2 Press the * key to verify the Job Export Server settings, and update if necessary.
- 3 On the Job List menu, highlight the job you wish to export, and then press the * key. Repeat this step for any additional jobs you wish to export.
The job will be exported as a XML file.
The job is exported, and then the Utilities Menu is displayed.



NOTE:

Once a job has been successfully uploaded to the job server, the job is deactivated and locked (i.e., cannot edit the ticket number or other fields). The next job must be a new ticket. This ensures that the correct test data is being saved and exported with the correct job. The check box next to the job will be greyed out.

If additional test results must be saved to an exported job, that job can be reactivated. Then, when the job is exported, the job file will include the new saved test results appended to the end of the previously saved file.

Deleting a job

To delete a job

- 1 On the Job Management screen, highlight the job to delete, and then press the # key.
- 2 A confirmation box appears. Press the **OK** key.
Repeat for each desired job.

The job is deleted.

Associating test results to a job

After running your test, you can associate the results to the job using the “Save to job” feature. See [“Saving results to a job” on page 120](#).

Communicating with a mobile device

Using an app on the mobile device (such as an iPad), you can connect to a SmartClass and control the user interface. SmartClass TPS supports mobile device applications on both iOS and Android.



NOTE:

In order to use this feature, the Mobile App Connectivity software option is required.

Before connecting to the mobile device, configure the SCTriple Play Services to communicate with the mobile device.

To setup the SmartClass to communicate with the mobile device

- 1 From the System Settings menu, select **Remote Access**.
- 2 Select **Wi-Fi Interface**.
- 3 Press **OK** to toggle Disabled to Enabled.
- 4 Press the * key to configure the Wi-Fi setup.

To change a setting, use the arrow keys to highlight the item, and then press the OK key to edit.

- a** Specify the **Wi-Fi Access Point** settings.

Setting	Description
Wi-Fi Mode	Specify Access Point (AP).
SSID	The Service Set Identifier is the public name of a wireless network.
HW Mode	Specify whether the wireless network is using 802.11b, 802.11g, or 802.11n
Channel	Specify which channel to connect to.
Security	Specify the type of security used on the network.

- b** If needed, specify the **WAN Network Setup** (see [“Specifying WAN settings” on page 54](#)).

After specifying the SmartClass TPS setup, you can control it with the mobile device.

See [“Using the SmartClass TPS with a mobile device” on page 35](#).

Accessing the SmartClass Triple Play Services remotely using VNC

The Remote Access feature allows you to access the SmartClass Triple Play Services user interface from a PC or laptop computer through a virtual network connection (VNC), connecting over an Ethernet interface, Wi-Fi interface, or DSL interface.

To use this feature, you must have a VNC viewer installed on the PC or laptop, the SmartClass Triple Play Services must be connected to the same network and subnet as the PC or laptop, and you must know the IP address of the SmartClass Triple Play Services.

The VNC program can control the following functions:

- You can do a ping, trace route and FTP tests, but be careful that changes do not affect your VNC connection.
- For VoIP and Video, VNC is not recommended.
- Results may not match the expected results.

To access the SmartClass Triple Play Services remotely

- 1 Using an Ethernet cable, connect the SmartClass Triple Play Services to same Ethernet LAN as the PC or laptop you will use for the VNC.
- 2 Turn the Remote Operation feature **On** by doing the following:
 - a From the System Settings menu, select **Remote Access**.
 - b Select the desired interface.



NOTE:

VNC over Ethernet and DSL are always available (standard); VNC over Wi-Fi is only supported if the Mobile App Connectivity SW option is enabled.

- c Press **OK** to toggle Disabled to Enabled.
- 3 Configure the network setup to match your Ethernet, Wi-Fi, or DSL network.
- 4 Establish the VNC connection.
 - a Launch VNC viewer.
 - b In the viewer's server address field, type the SmartClass Triple Play Services's IP address, and then select **OK**.

The SmartClass Triple Play Services user interface appears in the VNC viewer.



TIP:

If the message, "Failed to connect to server" appears, the VNC viewer was not able to communicate with the SmartClass Triple Play Services. If this happens, try the following solutions:

- Make sure you are using the correct IP address for the SmartClass Triple Play Services.
- From the PC or laptop, ping the SmartClass Triple Play Services IP address to verify the network link is working. If the link is not working, restart the SmartClass Triple Play Services and repeat [step 2](#) through [step 4](#).

- 5 Use the computer's mouse or keyboard to control the SmartClass Triple Play Services.
Table 7 shows how the PC/laptop keys map to the SmartClass Triple Play Services keypad.

Table 7 PC/laptop to SmartClass Triple Play Services key map

PC/Laptop key	SmartClass Triple Play Services Keys
Arrow keys	Arrows
Escape	Cancel
Enter	OK
F5	Utility

- To enter data (for example, entering a DNS name for a traceroute), use the arrow keys or mouse to scroll to and highlight the setting to specify, and then press Enter. Use the keyboard to type the text.
- 6 To end a remote operation session, on the PC or laptop running the VNC viewer, end the VNC session.

Table 8 shows the constraints for using the remote access feature.

Table 8 Remote access support

Test	Remote Access		
	Wi-Fi	Ethernet	DSL
DSL with data	Supported	Not Available	Not Available
Ethernet Test with data	Supported	Supported	Not Available
Wi-Fi Scan	Not Available	Supported	Supported
Wi-Fi EP with data	Not Available	Not Available	Not Available
Wi-Fi AP	Not Available	Supported	Not Available
HPNA	Supported	Not Available	Not Available
Copper	Supported	Supported	Not Available
SmartID	Supported	Supported	Supported
Optical Power Meter	Supported	Supported	Supported

Setting the date and time

The SmartClass Triple Play Services has an internal clock that you can set to provide accurate time stamps for test results.

Setting the date

The following procedure describes how to set the date.

To set the date

- 1 Select **System Settings** from the Main Menu.
- 2 Select **Hardware Settings**, and then **Date and Time**.

- 3 Select **Date**.
- 4 Enter the current month, day, and year (or day, month, and year) in numerical form.



NOTE:

The date format changes automatically when you change the Country setting on the International Settings menu. For example, the date April 2, 2004 would appear as 4/2/2004 when the country is set to United States but would appear as 2/4/2004 when the country is set to Germany.

- 5 Press the **OK** key.

The date is set.

Setting the time

The Date and Time menu allows you to set the time of day, as well as the time format (12 hour or 24 hour).

The following procedure describes how to set the time.

To set the time

- 1 Select **System Settings** from the Main Menu.
- 2 Select **Hardware Settings**, and then **Date and Time**.
- 3 Select **Time**.
- 4 Enter the current hour, minutes, and seconds.
Use the arrow keys to move among each field.
- 5 Press the **OK** key.

The time is set.

The following procedure describes how to specify the time format.

To specify the time format

- 1 Select **System Settings** from the Main Menu.
- 2 Select **Hardware Settings**, and then **Date and Time**.
- 3 Select **Time Format**.
- 4 Choose **12 Hour** or **24 Hour** display.
- 5 Press the **OK** key.

The time format is specified.

Specifying auto power down settings

The Power Management menu allows you to view the battery level, as well as set the time to wait before the unit turns off to conserve battery.

To specify auto power down settings

- 1 Select **System Settings** from the Main Menu.

- 2 Select **Hardware Settings**, and then **Power Management**.
The Power Setup menu appears, showing the battery level and the current power off delay.
- 3 Select **Power Off Delay** to set the power off delay.
This is the amount of time to wait (in minutes) after a keypress or no line activity before power down.
The auto power down settings are specified.

Adjusting the screen settings

The Screen Settings menu allows you to adjust contrast and brightness.

To adjust the screen settings

- 1 Select **System Settings** from the Main Menu.
- 2 Select **Hardware Settings**, and then **Screen Setup**.
- 3 To change the screen for better viewing outdoors, select **Outdoor Screen Mode**.
- 4 Select the setting you wish to adjust: **Contrast**, **Brightness**, or **Backlight**.
- 5 Change the level using the up or down arrow key, followed by the **OK** key.
- 6 *Optional.* To make more precise adjustments, select **Show More**, and then select Red Contrast, Blue Contrast, Red Brightness, or Blue Brightness.

The screen settings are adjusted.

Changing keypad setup

Using the Keypad menu, you can set the repeat delay and repeat rate.

Setting the repeat delay

The following procedure describes how to set the repeat delay. This setting defines the time to wait after a key is held down until it begins to repeat. You can set the delay from 0.5 up to 10 seconds, in 0.1 second increments.

To change the repeat delay

- 1 Select **System Settings** from the Main Menu.
- 2 Select **Hardware Settings**, and then **Keypad Setup**.
- 3 Select **Auto Repeat Delay**.
- 4 Change the level using the arrow keys, followed by the **OK** key.

The repeat delay is set.

Setting the repeat rate

The following procedure describes how to set the repeat rate. This setting defines how many times the character will be repeated per second.

To change the repeat rate

- 1 Select **System Settings** from the Main Menu.
- 2 Select **Hardware Settings**, and then **Keypad Setup**.
- 3 Select **Auto Repeat Rate**.
- 4 Change the level using the arrow keys, followed by the **OK** key.

The repeat rate is set.

Specifying the volume level

The Volume Setup menu allows you to adjust the handset volume.

To specify the volume level

- 1 Select **System Settings** from the Main Menu.
- 2 Select **Hardware Settings**, and then **Volume Setup**.
- 3 Select **Handset Volume** to specify the volume played through the built-in speaker.

The volume level is set.

Specifying international settings

The International Settings menu allows you to change the language of the user interface and specify the measurement units.

To specify international settings

- 1 Select **System Settings** from the Main Menu.
- 2 Select **Administration**, and then **International Settings**.
- 3 Select the setting you wish to change:
 - Language—changes the language of the user interface.
 - Country—automatically sets the units based on the country.

The countries available will change depending on the language. For example, if you change the language to Français, countries such as France and Canada are listed and there will be no English speaking countries listed (for example, United Kingdom and Australia). The only exception is English; all countries are listed when English is selected.

Other changes that happen automatically based on country include:
the cable pair names (from Tip, Ring, Ground to A, B, and E) and the technical assistance phone number.

- Units—changes the measurement units (metric or imperial).

The international settings are specified.

Managing test configurations

After you specify settings for a configuration, you can store the configuration for future use, or load a saved configuration.

Saving test configurations

You can define and store configurations using your most common settings, and then load an existing configuration and edit the settings as needed for your current test.



NOTE:

If you change a setting, it is not automatically saved. You must either save the configuration again and overwrite the previous settings, or create a new configuration.

To save test configurations

- 1 Specify the settings for the configuration.
- 2 Select **System Settings** from the Main Menu, and then **File Management**.
- 3 Select **Save Setup**, and then do one of the following:
 - To save as a new configuration, select **New**.
 - To overwrite a previously saved configuration, navigate to the desired configuration file, and then press OK.

The test configuration is stored.

Loading a configuration

After you save a configuration, you can load it at any time to run a test using the configuration settings.



NOTE:

Configurations cannot be loaded while a test is running. Load the configuration before testing.

To load a test configuration

- 1 Select **System Settings** from the Main Menu, and then **File Management**.
- 2 Select **Load Setup**.
- 3 Scroll to the desired file name to load, and then press OK.

The test configuration is loaded.

Viewing unit revisions, options, and IDs

The Options and Revisions screens provide the software and hardware versions and list the installed options.

To view the installed options

- 1 Select **System Settings** from the Main Menu, and then **Administration**.
- 2 Select **Options**.

A list of current options appears and indicates whether the option is installed on your unit.

The unit's unique Hardware ID number also appears on this screen. You will need this ID if you are adding options to the unit. For more information, see [“Adding options” on page 149](#).

To view the unit revisions

- 1 Select **System Settings** from the Main Menu, and then **Administration**.
- 2 Select **Revisions**.
The system software version appears.
- 3 To view more detailed information for a specific component, select **System Information**, **Modem Information**, or **Copper Board Information** (if the copper board is installed).
This will report the hardware type and rev and the software rev of each component.

**NOTE:**

The PHY Rev that is displayed on the Modem Information screen varies depending on which application you are running when you entered the menu. For DSL applications, the rev is displayed but is different based on single line versus bonded and ADSL versus VDSL. The PHY rev is not displayed when you are in the Copper or Ethernet TE application.

Restoring factory defaults

The following procedure describes how to reset the SmartClass Triple Play Services to factory default settings.

**NOTE:**

Restoring factory defaults will reset test application settings and system settings (such as contrast and language). It does NOT change or delete stored configurations or saved results.

To reset to factory defaults

- 1 Select **System Settings** from the Main Menu.
- 2 Select **Restore Settings**.
A confirmation menu appears.
- 3 Press the **OK** key to reset the defaults or **Cancel** to keep the current settings.

After resetting, the unit reboots.

Automated Testing

This chapter provides information on using the automated tests (automated sequence of tests, also called “scripts”) to verify connectivity, upload and download rates, or to verify the video channels. The following topics are discussed in this chapter:

- [“About the automated tests” on page 32](#)
- [“Running the OneCheck test” on page 32](#)
- [“Running the VideoCheck test” on page 34](#)

About the automated tests

The SmartClass Triple Play Services includes two automated tests:

OneCheck — Allows triple play testing by running a DSL, Ethernet, or Wi-Fi test to verify network connectivity and upstream/downstream thresholds, a ping test to verify data layer connectivity, a FTP or HTTP test to verify data upload and download rates, a video test (as described in the video check below), and a VoIP test. Then the test reports pass/fail results.

VideoCheck — Verifies whether all channels are available as ordered by the subscriber. The test is included as a part of the OneCheck test, but can be run as a separate test when only the Video layer needs to be verified.

Running the OneCheck test

The OneCheck test is an automated sequence of tests. The test runs a DSL, Ethernet, or Wi-Fi test to test connectivity and upstream/downstream thresholds, a ping test to verify connectivity, a FTP test to verify upload and download rates, a video test to verify the channels are provisioned as the subscriber requested, and a VoIP test to verify call placement and QoS thresholds.

To run the OneCheck test

1 Launch the desired application: DSL, Ethernet, or Wi-Fi.

2 Select **OneCheck**.

The OneCheck menu appears. From this menu, you can start the test sequence or go to the setup menus for each test.

3 To select which tests to run, either highlight the test and then press OK, or press the number for that test to toggle enabled or disabled.

The only exception is VoIP. Select VoIP and then specify how the OneCheck script will place the VoIP call:

- Automatic – automatically place a call
- Manual – display the VoIP call screen and wait for you to initiate the call manually
- Disable – don't run the VoIP test

4 To specify the test settings, press the * key, and then select which test to setup.

a Select **DSL Setup**, and then specify the following:



NOTE:

DSL Setup is only available if testing over DSL. If testing over Ethernet or Wi-Fi, this selection will not appear.

- **Group Thresholds** - pass/fail thresholds for upstream connection rate, max up rate, downstream connection rate, and max down rate. The Group Thresholds only appear when testing in Bonded modes.
- **Upstream Thresholds** - pass/fail thresholds for upstream connection rate, max rate, margin, and LATN (for ADSL) or 1MHz attenuation (xDSL).
- **Downstream Thresholds** - pass/fail thresholds for downstream connection rate, max rate, margin, and LATN (for ADSL) or 1MHz attenuation (xDSL or VDSL).

- **DSL Setup** - specify the Sync Timeout (the time to wait for synchronization to occur before timing out), and then if needed, specify the other DSL settings as described in [“Specifying test settings” on page 49](#).
 - b** Select **Network Setup**, and then specify the settings as described in [“Specifying the network setup” on page 42](#).
 - c** Select **Ping Setup**, and then specify the pass/fail settings for replies lost, average ping time, and max ping time. If needed, also specify the settings as described in [“IP Ping testing” on page 62](#).
 - d** Select **File Transfer Setup**, and then specify the following:
 - Pass/Fail thresholds for upload rate and download rate.
 - FTP/HTTP Test Setup as described in [step 1 of “Throughput testing” on page 64](#)
 - e** Select **Video Setup**, and then specify the following:
 - Channel List - import the video channel list.

Use this menu to import the .txt file (tab delimited) that contains the channel list. It can be in one of the following places:
the TestSetup\VideoCheck directory on the unit or on a USB stick,
the TestSetup directory on a USB stick,
or the root directory of a USB stick.

By default, the channellist.xls template is located in the root directory on the unit (/cust/public). Copy that file, update it, save as a .txt file (tab delimited), and then import it as mentioned above.
 - IGMP Version - specify the version of IGMP signaling being used on the circuit: version 2 or version 3.
 - Concurrent video streams - specify the number of streams to test simultaneously, up to three.
 - Test duration - specify the amount of time to test each video stream. Selecting 0 seconds will only verify that we can connect to the video stream. QoS values will not be gathered.
 - QoS Thresholds - specify the thresholds as described in [step 3 of “Specifying test settings” on page 97](#). The pass/fail result based on these thresholds will be included in the test, unless the test duration is zero seconds.
 - f** Select **VoIP Setup**, and then specify the following:
 - Number to call - On the General Setup menu, enter a phone number to dial.
 - Call duration - On the General Setup menu, specify the length of time to leave the call up.
 - All other settings as described in [“Specifying test settings” on page 86](#)
 - g** Press **Cancel** to return to the OneCheck menu.
- 5** Press the **#** key to **Start** the test.
- The test begins. The test may take several minutes.
- As the test runs, the status and results of the test are displayed.
- A check mark indicates pass; an “X” indicates fail, an exclamation point indicates a marginal result.
- The test stops automatically when complete.
- For more information on the other results, see [Chapter 16 “Test Results”](#).
- 6** To save a test report, press the utility (i) key and then select **Save Report** or **Save To Job**, and then specify the report settings such as report name, report format, technician ID, location, and other settings as needed.

Running the VideoCheck test

The VideoCheck test is used to verify the channels are provisioned as the subscriber requested.

To run the VideoCheck test

1 Launch the desired application: DSL, Ethernet, or Wi-Fi.

2 Select **VideoCheck**.

The VideoCheck menu appears. From this menu, you can start the test sequence or go to the setup menu.

3 If you haven't already specified the settings, press the * key to do so. See [step e](#) above.

4 Press the # key to **Start** the test.

The test begins.

As the test runs, the status and results of the test are displayed. A check mark indicates pass; an "X" indicates fail, an exclamation point indicates a marginal result.

The test stops automatically when complete.

5 View the results.

The following table describes the VideoCheck results.

Result	Description
Ch	The channel index number. It should match the channel ID configured in the channel list.
Name	The channel name. It should match the channel name configured in the channel list.
Status	The status of the stream. Media wait - evaluating the status Stream up - stream is under test Available or Unavailable - status after test is done.
QoS	A pass/fail indication of the quality of the stream. It only appears if the stream is available and the test duration is more than zero seconds.

To view details for a specific stream, highlight the stream/channel, and then press OK.

Details are available for loss, jitter, error ind, join latency, leave latency, and channel settings such as IP address and stream type.

For more information on the other results, see [Chapter 16 "Test Results"](#).

6 To save a test report, press the utility (i) key and then select **Save Report** or **Save To Job**, and then specify the report settings such as report name, report format, technician ID, location, and other settings as needed.

Using the SmartClass TPS with a mobile device

This chapter provides task-based instructions for using the optional app that is available for mobile devices. Topics discussed in this chapter include the following:

- [“Controlling the SmartClass with a mobile device” on page 36](#)
- [“Controlling the device interface” on page 37](#)
- [“Testing with SmartIDs” on page 37](#)
- [“Viewing video on a mobile device” on page 39](#)

Controlling the SmartClass with a mobile device

Using an app on the mobile device, you can connect to a SmartClass and control the user interface. SmartClass TPS supports mobile device applications on both iOS and Android.

To control the SmartClass with a mobile device

- 1 To configure the SmartClass TPS as a Wi-Fi access point for the mobile device, see [“Communicating with a mobile device”](#) on page 23.
- 2 Setup the mobile device to connect to the <product name>’s Wi-Fi network.
 - a Go to the Settings menu.
 - b Select Wi-Fi and find the SSID for the SmartClass that you wish to connect to.
- 3 On the mobile device, launch the **SCTPS** app.



The Controller page appears.

From this page, you can select whether to control the <product name> user interface, check video with Dazzle, or test with SmartIDs.

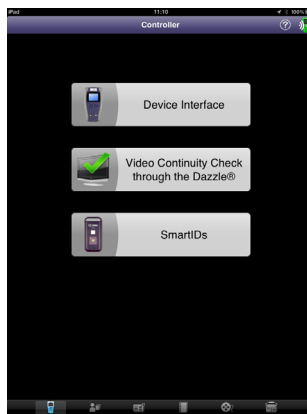

Across the bottom, icons are available for:

- Controller page—the screen above, allows control of the user interface, launching a video check, and testing with SmartIDs (see [“Controlling the device interface”](#), [“Viewing video on a mobile device”](#), and [“Testing with SmartIDs”](#))
- Job Manager—used to manage test results
- Quick Cards—view quick cards (short documents of instructions)
- Manual—read the manual
- Videos—view instructional videos
- Accessories—view the guide for the accessories

For iOS mobile device, if you are controlling the <product name> using an iPhone instead of an iPad, the screen will appear slightly different: the SmartID app is replaced with the Job Manager (SmartID tests are only available on the iPad and Job Manager is not an icon at the bottom).

For Android device, the SmartClass TPS GUI is very similar to that of the iOS mobile device.

Controlling the device interface

From the mobile device (such as an iPad), you can run tests on the <product name>.

To control the device interface

- On the Controller page select **Device Interface**.

The SmartClass TPS interface appears on the mobile device. You can now control the device as if you were pressing the actual buttons on the device.



You can run most of the tests that are available on the SmartClass TPS. See [Table 8 “Remote access support” on page 25](#).

To return to the main Controller page, select the Controller button in the upper left.

Testing with SmartIDs

The mobile device app allows you to test with SmartIDs.

To test with SmartIDs

- 1 On the main Controller page select **SmartIDs**.

The <product name> goes into remote control mode and the mobile device screen displays the Locate SmartID page.

You can now use either the instrument’s user interface or the SmartID App in the main Controller page to run the Good Home Check.

To return to the main Controller page, select the Controller button in the upper left.

- 2 To locate SmartIDs, tap Start Scan

The progress bar at the top will indicate Scanning...

The located SmartIDs appear in the left pane. If a SmartID is registered with the <product name> but not located, it will be in the left page as Registered but will be greyed out.

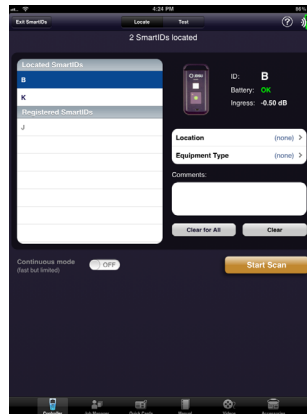

- 3 *Optional.* Specify the location and equipment type for each SmartID.
 - a Select the letter of the SmartID in the left pane.
 - b Tap **Location** in the right pane, and then select a location (Living Room, Kitchen, etc.).
 - c Tap **Equipment Type** in the right pane, and then specify the type of equipment (RG, STB, computer, phone, etc.).

The picture of the equipment updates to show the equipment selected.

- 4 To run other tests, in the top center area of the screen, tap **Test** and then select the type of test.

As the test progresses, the screen updates indicating the status of each part of the test.

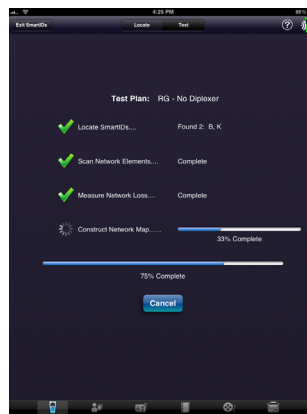

After the test finishes, the results are displayed.

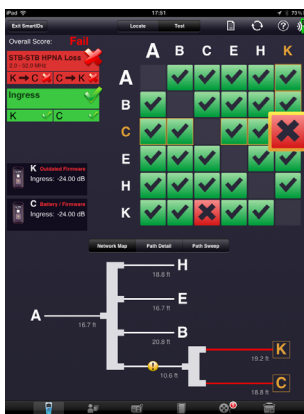

For more information on testing with SmartIDs, see [Chapter 10 “SmartID Testing”](#).

Viewing video on a mobile device

SmartClass TPS provides a means to display video output from a set-top box. This is useful for installations where the customer’s television is not yet accessible but the video service must be verified. This test uses a device such as the Dazzle[®] to view the video.

To view video on the mobile device

- 1 If you haven’t already done so, launch the **SCTPS** app.
- 2 Connect the Dazzle device to the RGB video outputs on the STB.
- 3 Connect the output side (USB) of the Dazzle device to the USB port of the SmartClass TPS.
- 4 Configure the SmartClass TPS as a Wi-Fi access point and connect the mobile device to the SmartClass TPS. See [“Communicating with a mobile device” on page 23](#).
- 5 From the mobile device’s Controller screen, select **Video Continuity Check through the Dazzle**.

The MPEG stream from the Dazzle USB output is streamed through the SmartClass TPS to the iPad.

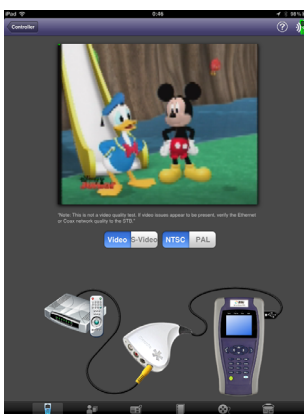

- 6 View the video in the mobile device application.



NOTE:

This is not a video analysis. It is only passing the raw uncompressed video from the RGB output from the STB. The image may not be of high quality due to the uncompressed nature from which the video is being retrieved from the STB output and being sent thru the SmartClass TPS over the Wi-Fi link to the mobile device. This is useful for verifying the presence (or lack) of video when there is no television present. If service issues are suspected on the STB receiver, be sure to use other testing and troubleshooting methods on the physical layer that is supplying the STB.

Ethernet TE Testing

This chapter provides task-based instructions for using the Ethernet TE testing features of the SmartClass Triple Play Services. Topics discussed in this chapter include the following:

- [“About Ethernet TE testing” on page 42](#)
- [“Specifying the network setup” on page 42](#)
- [“Connecting to the line” on page 44](#)
- [“Viewing results” on page 45](#)

About Ethernet TE testing

In Ethernet TE mode, you can use the Triple Play Services to emulate Ethernet terminal equipment by connecting to an Ethernet LAN or to the Ethernet port on the customer's modem. After connecting to the circuit, you can then test for connectivity and throughput.

You can also ping through the modem to a network switch or web address to test for connectivity.

To select Ethernet TE mode

- From the Main Menu, select **Ethernet TE**.
The Ethernet TE menu appears.

The Ethernet TE test involves the following steps:

- Specifying test settings
- Connecting to the line
- Performing tests
- Viewing results

Specifying the network setup

Before you begin testing, make sure the test settings on the Triple Play Services match the settings of the line that you are testing.

To specify test settings

- 1 From the main application menu, select **Network**.
- 2 Select **Network Setup**, and then specify the settings.
Configuring the settings can be done one of two ways:
 - Press a number on the key pad that corresponds to the setting you want to configure.
 - Use the arrow keys to highlight the setting you want to change, and then press the **OK** key. Press the **Cancel** key to exit a menu.



CAUTION: FAULTY RESULTS

Any time the Network settings are changed, the network layer resets. If you change these settings during a test, you may cause errors in the test. Only change them before you begin a test.

The following table describes the settings.

Setting	Description
Data Mode	Select the data mode. IPoE is IP over Ethernet PPPoE is PPP over Ethernet Multi-VLAN is multiple VLAN; multiple Virtual LANs are used on this network. In this mode, the SmartClass Triple Play Services assumes that the networks that are accessed via each VLAN are unique, and thus provides access to a different range of IP addresses. A typical scenario would be one VLAN for Internet data, another VLAN for Voice, and another VLAN for Video. IPv6oE is IPv6 over Ethernet. To review the basic differences in IPv4 vs. IPv6, see “About data testing” on page 62 IPv6 Multi-VLAN is multiple VLAN over IPv6 (up to 3 VLANs).
Interface Count	If Multi-VLAN Data Mode is used, specify the number of VLAN interfaces, up to three.
VLAN x Setup (or IPv6 VLANx Setup)	If Multi-VLAN Data Mode is used, specify the settings for each LAN. On this menu, the Client Mode specifies the data mode for the VLAN. Other setup items appear depending on the Client (Data) Mode (such as Use DHCP Vendor ID, or Username and Password). You must also define a purpose for IPv4 VLANs 2 and 3 (Internet, Video, or Voice).
MAC Addr. Mode	If IPoE or PPPoE Data Mode is used, specify whether the MAC is the factory default or user defined.
VLAN	If IPoE or PPPoE Data Mode is used, specify whether VLANs are used.
VLAN ID	If VLAN is On, specify the VLAN ID.
VLAN Priority	If VLAN is On, specify the VLAN Priority.
IP Mode (IPv4)	If IPoE Data Mode is used, select either Static or DHCP (dynamic host configuration protocol) mode.
IP Addr. (IPv4)	If the IP Mode is Static, enter the IP address that the tester will use.
IP Netmask (IPv4)	If the IP Mode is Static, enter the net mask address.
Gateway (IPv4)	If the IP Mode is Static, enter the gateway address.
DNS Server	If the IP Mode is Static enter the address of the DNS server.
Use DHCP Vendor ID	Select Yes or No to whether to use the vendor ID. This is only available if you selected DHCP as the “IP Mode”.
DHCP Vendor ID	Enter the Vendor ID. This is required if you selected Yes for “Use DHCP Vendor ID.”
Use User Class	Select Yes or No to whether to use the User Class. This is only available if you selected DHCP as the “IP Mode”.
DHCP User Class	Enter the User Class. This is required if you selected Yes for “Use User Class.”
IPv6 Mode	If IPv6oE Data Mode is used, select DHCPv6 (stateful configuration per RFC 3315) Stateless (auto-configuration per RFC 2462), or Manual mode.
DHCPv6 Option	If using IPv6oE and the mode is DHCP, specify whether IA PD (prefix delegation) is used.

Setting	Description
Global Addr.	If using IPv6oE and the IPv6 Mode is Manual, specify the global IPv6 address.
Local Address Mode	If the IPv6 Mode is Manual, specify whether the local address mode is automatic or manual.
IPv6 Local Address	If the IPv6 Mode is Manual, and the Local Address Mode is Manual, specify the local address.
Subnet Prefix Length	If you selected Manual IPv6 mode, specify the length of the subnet prefix, from 0 to 128.
IPv6 Gateway	If using IPv6oE and the IPv6 Mode is Manual, enter the gateway address.
DNS Mode	If you selected Stateless IPv6 Mode, specify the DNS Mode: Manual or DHCPv6. This determines whether DHCP will be used to get the DNS server address.
PPP Username	Enter a valid user name. This must be a valid user account with an ISP.
PPP Password	Enter the user password. This must be a valid password that matches the user name above. Passwords are often case-sensitive.
PPP Use Provider	Select Yes or No . This option indicates whether to append the user name with the service provider domain name (for example, earthlink.net). Select Yes only if user names for the ISP must include the domain name as part of the user name. This setting automatically appends the @ sign for you.
PPP Provider	Enter the provider name. This is required if you selected Yes for "Use Provider."
PPP Use Service Name	Select Yes or No to whether to use the Service Name.
PPP Service Name	Enter the Service Name. This is required if you selected Yes for "Use Service."
Login Mode	Specify whether to automatically or manually login. If set to manual, the data synchronization will not occur until you login.

If you are connecting over WiFi

You are finished specifying the network setup.

Connecting to the line

After specifying the test settings, you can connect to the line.

To connect to the line

- 1 Connect one end of an Ethernet cable to the Ethernet jack on the right side of the unit.
- 2 Connect the other end of the cable to an Ethernet jack.

Viewing results

After specifying test settings and connecting to the line, you can view results.

To view results

- 1 Do one of the following:
 - Press the **Cancel** key to return to the Network menu, and then select Network Status or LAN Stats.
 - From the Network Setup menu, press the left arrow to move to the LAN Results menu, and then the left arrow again to move to the Network Status menu.
- 2 To save a test report, press the utility (i) key and then select **Save Report**, and then specify the report settings such as report name, report format, technician ID, location, and other settings as needed.
- 3 To clear the results, use the asterisk (*) key.

See [Chapter 16 “Test Results”](#) to learn what your results mean.

DSL Testing

This chapter provides task-based instructions for using the SmartClass Triple Play Services to gather DSL (VDSL, ADSL2+/2/1) statistics and verify connectivity. Topics discussed in this chapter include the following:

- [“About xDSL testing” on page 48](#)
- [“Selecting the test mode” on page 49](#)
- [“Specifying test settings” on page 49](#)
- [“Testing the physical layer” on page 58](#)
- [“Testing line quality” on page 58](#)
- [“Terminating the loop \(SELT\)” on page 60](#)

About xDSL testing

The purpose of the DSL tests are to assess the quality of the xDSL signal and to verify the xDSL rates achieved at various points in the network.

The tests involve three main steps:

- selecting the test mode and specifying test settings
- connecting to the line
- running the tests

The SmartClass Triple Play Services supports two types of modems - the classical BCM96368 modem and the new BCM963168 modem.

BCM96368 test options

The classical BCM96368 modem supports an optional bonded modem emulate mode, where the SmartClass replaces a bonded modem (terminates the line instead of the CPE). The options available for purchase are as follows:

Table 9 DSL testing options for BCM96368

Option	Description	Order Number
ADSL Bonded	Bonded mode for ADSL	SCTP-ADSL-BONDED
VDSL Bonded	Bonded mode for VDSL	SCTP-VDSL-BONDED

Refer to [Table 3 on page 3](#) for the corresponding catalog numbers.

BCM963168 test options

The new BCM963168 modem features in supporting Single channel ADSL Annex A and Annex B, as well as Single channel VDSL up to 30a. It does not support the bonded modem emulate mode. The option available for purchase is as follow:

Table 10 DSL testing options for BCM963168

Option	Description	Order Number
ADSL1/2/2+ Annex B	ADSL1/2/2+ Annex B Software Option	SCTP-ANXB

Refer to [Table 4 on page 3](#) for the corresponding catalog numbers.

For additional information about SmartClass Triple Play Services options and services, contact your local JDSU representative or contact JDSU through the company web site, www.jdsu.com.

Selecting the test mode

Before running any DSL tests, you must specify the test mode and specify test settings.

To select the test mode

- 1 From the main menu, select **DSL Test**.
- 2 Select the test mode.

For the BCM96368 modem, you can select from:

- ADSL/VDSL (Single Pair)
- VDSL Bonded (Two-Pair)
- ADSL Bonded (Two-Pair)
- xDSL SELT

For the BCM963168 modem, you can select from:

- xDSL (ANX A)
- xDSL (ANX B)
- xDSL SELT

- 3 Specify test settings. See [“Specifying test settings” on page 49](#).

Specifying test settings

Before you begin testing, make sure the test settings on the SmartClass Triple Play Services match the settings of the line that you are testing. The following settings typically must be set:

- Modem operation
- DSL settings
- WAN Network settings
- LAN Network settings

Configuring the settings can be done one of two ways:

- Press a number on the key pad that corresponds to the setting you want to configure.
- Use the arrow keys to highlight the setting you want to change, and then press the **OK** key. Press the **Cancel** key to exit a menu.



TIP:

Test configurations can be stored for easy recall and use (see [“Managing test configurations” on page 29](#)).

Specifying the modem operation

The test settings that you must specify will vary depending on the modem operation mode. You should specify the modem operation mode first.

To specify the modem operation mode

- 1 For the BCM96368 modem: from the ADSL/VDSL menu, select **Network**.

For the BCM963168 modem: from the xDSL menu, select **Network**.

- 2 Specify the **Modem Operation** (Router or Bridge).

The SmartClass Triple Play Services can test DSL services in two modes: DSL-Bridge and DSL-Modem/Router. They include the same testing capabilities, but the difference is in the IP addressing.

In **DSL-Modem/Router** mode, the SmartClass Triple Play Services replaces the modem, router, and test interface. As the router, it stops the service provider's IP on the network side and assigns private IPs to equipment on the customer side, as shown in [Figure 9 on page 50](#).

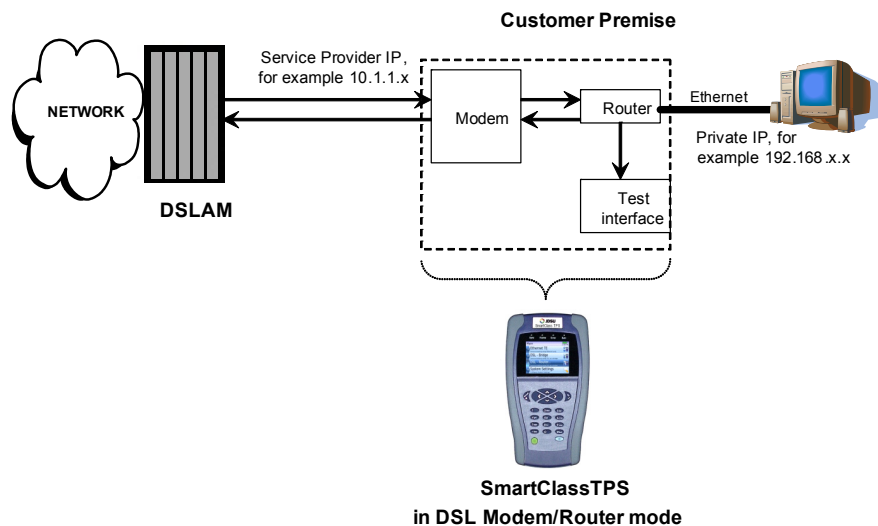

Figure 9 DSL-Modem/Router circuit

In **DSL-Bridge** mode, the SmartClass Triple Play Services replaces the modem, hub, and test interface. It does not use a DHCP server so it does not assign IP addresses to other equipment. The end equipment uses either the service provider-supplied IP address or one that is on the same network (same netmask). See [Figure 10 on page 51](#).

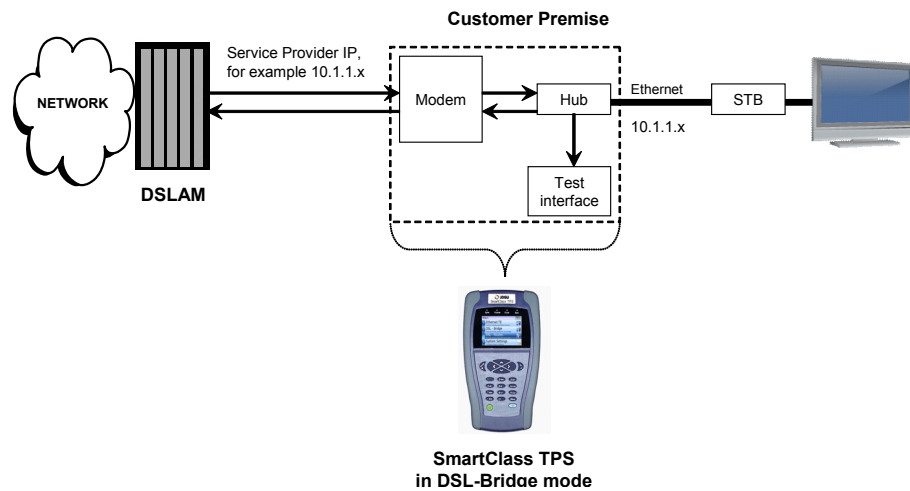

Figure 10 DSL-Bridge circuit

To test in DSL Terminate Mode, use Bridge Mode as it allows VLAN tags to be assigned. To use IPv6 (IPv6oE or IPv6 Multi VLAN), Bridge mode should be used.

- 3 *Optional* -Specify **Ethernet Router**. You do not need to perform this step if not to replace the bridge running on Ethernet interface with a router.

You can select **Ethernet Router** and enable the router between the DSL interface and the Ethernet interface. Note this is another router in addition to that in [Figure 9 on page 50](#). Using the Router Mode the SmartClass TPS will work as the router for the devices connected through the Ethernet port. Not using the Router Mode it will work as a bridge.

- 4 Press **Cancel** to return to the previous menu.

The modem operation mode is specified.

Specifying DSL settings

The settings vary depending on whether testing on a single line or bonded.

Specifying DSL (single line) settings

To specify DSL test settings

- 1 From the ADSL/VDSL menu, select **DSL**.
The DSL Summary results menu appears.
Press the asterisk (*) to view the Setup menu.
- 2 Select **xDSL Standard** and then choose ADSL, VDSL, Auto, or Incremental. Auto will query the DSLAM for the standard. Incremental will cycle through a period of broadcast sequences to the DSLAM, going from VDSL to ADSL and then repeating.
- 3 If you specified ADSL as the DSL standard, do the following:
 - a Select **Operation** and then select Over POTS or Over ISDN.
 - b Specify the **ADSL Modulation** standard in use.
 - **Auto** will revert to ADSL2 if the line doesn't support ADSL2+ or revert to G.DMT if line doesn't support ADSL2. Select Auto if using Annex M.
 - Annex M
 - G.DMT
 - G.Lite (only available if *Operation* is **Over POTS**)
 - ADSL2
 - ADSL2+
 - T1.413 (only available if *Operation* is **Over POTS**)

**NOTE:**

You may not see all of the settings above. The available selections vary, depending on the configuration and installed options.

- c Select **Transport Mode** and then choose the transport.
ATM specifies Asynchronous Transfer Mode. **PTM** specifies Packet Transfer Mode. Auto will query the DSLAM for the transport mode.
- 4 If you specified VDSL as the DSL standard, do the following:
 - a Select **Operation** and then select Over POTS or Over ISDN.
 - b Specify the **VDSL Profile** profile (for example, 8a, 12b, and so on).
 - **Auto** will query the DSLAM for the profile.
 - 8a
 - 8b
 - 8c
 - 8d
 - 12a
 - 12b
 - 17a
 - 30a

- c Select **Transport Mode** and then choose the transport.

ATM specifies Asynchronous Transfer Mode. **PTM** specifies Packet Transfer Mode. Auto will query the DSLAM for the transport mode.

- 5 Select **G.INP Setup** and then specify whether the unit will advertise upstream or downstream G.INP support to the DSLAM. If the selection is changed, the modem resyncs in order to apply the new setting.



NOTE:

Enabling G.INP only *advertises* support to the DSLAM. It does not guarantee the connection will use G.INP because G.INP is specified in the CO configuration.

- 6 Select **Vector Mode** and then select **Full**, **Friendly**, or **Off**.

Vectoring technology is used on VDSL2 connections to reduce cross-talk from other pairs in a binder group resulting in higher downstream and upstream rates for all the pairs in the group. Vector mode is available for single-line VDSL circuits only (not available for bonded, not available for ADSL2). Vector Friendly mode is suggested when there is a need to emulate CPE incapable of full vectoring, but which have been designed to synchronize to a vectoring DSLAM without losing sync. It is a special software that is downloaded to the VTU-R modem enabling it to respond to a vectored request from a VTU-O to allocate net data rates across all bearer channels and to minimize excess SNR per channel.



NOTE:

When testing on a line that is configured for vectoring, the time to achieve showtime may be longer than a VDSL2 line without vectoring because it takes additional time to negotiate with the DSLAM while assessing all of the pairs for cross-talk.

- If using vectoring, the Data network must be enabled and configured because the data layer is used to communicate parameters between the DSLAM and modem during showtime.

- 7 Select **SOS Mode** and then specify whether to use SOS mode.

This setting is only applicable to VDSL.

When enabled, SOS mode ensures that a connection is maintained on the DSL link regardless of suddenly degraded conditions (such as large increases in noise or a large degradation in SNR) and allows the application to maintain at least a minimal connection during a period of degradation. SOS mode can prevent retraining, allowing a more graceful return to normal operation when the period of degradation has ended.

- 8 Press **Cancel** to return to the DSL Summary results menu.

Specifying DSL settings for Bonded mode (For BCM96368 modem only)

To specify Bonded DSL test settings

- 1 From the ADSL Bonded or VDSL Bonded menu, select **ADSL** or **VDSL**.

The Group Summary results menu appears.

Press the asterisk (*) to view the Setup menu.

- 2 Do one of the following:

- If you are testing ADSL Bonded, select **ADSL Modulation** and then choose ADSL2, ADSL2+, Annex M, or Auto. Auto will query the DSLAM for the modulation.
- If you are testing VDSL Bonded, select **VDSL Profile** and then choose a profile. Auto will query the DSLAM for the modulation.

- 3 Select **Transport Mode** and then choose ATM, PTM, or Auto. Auto will query the DSLAM for the transport mode.
- 4 Select **SOS Mode** and then specify whether to use SOS mode.
This setting is only applicable to VDSL.
When enabled, SOS mode ensures that a connection is maintained on the DSL link regardless of suddenly degraded conditions (such as large increases in noise or a large degradation in SNR) and allows the application to maintain at least a minimal connection during a period of degradation. SOS mode can prevent retraining, allowing a more graceful return to normal operation when the period of degradation has ended.
- 5 Press **Cancel** to return to the Group Summary results menu.

Specifying network settings

If the modem operation mode is Bridge (which is the default mode), the Network Setup is available. If using Router mode, specify the WAN Setup.

To specify Network settings

- 1 From the ADSL or ADSL/VDSL menu, select **Network**.



CAUTION: FAULTY RESULTS

Any time the Network settings are changed, the network layer resets. If you change these settings during a test, you may cause errors in the test. Only change them before you begin a test.

- 2 Select **Network Setup** and then specify the **ATM Layer Setup**. This selection is greyed out if you specified PTM transport mode on the DSL setup. The following table describes the settings.

Setting	Description
WAN VPI / VCI	Specifies the VPI and VCI for the customer-facing port on the DSLAM.
Encapsulation	Select LCC-SNAP or VC-MUX .

- 3 Specify other network settings as described in [“Specifying the network setup” on page 42](#).
The network settings are specified.

Specifying WAN settings

If the modem operation mode is Router, the WAN Setup is available. If using Bridge mode, specify the Network Setup.

To specify WAN settings

- 1 From the ADSL/VDSL or Bonded menu, select **Network**, and then select **WAN Setup**.



CAUTION: FAULTY RESULTS

Any time the Network settings are changed, the network layer resets. If you change these settings during a test, you may cause errors in the test. Only change them before you begin a test.

- 2 Select **ATM Operation** and then specify the settings. This selection is greyed out if you specified PTM transport mode on the DSL settings menu (Broadcom only).

The following table describes the settings.

Setting	Description
Data Mode	Select the network type. (only in Router mode) None turns the data layer off <ul style="list-style-type: none"> – IPoE is IP over Ethernet – PPPoE is PPP over Ethernet – IPoA is IP over ATM – PPPoA is PPP over ATM
IP Mode	Select either Static or Dynamic (DHCP).
IP Addr.	If the IP Mode is Static, enter the IP address that the tester will use.
Netmask	If the IP Mode is Static, enter the net mask address.
Gateway	If the IP Mode is Static, enter the gateway address.
DNS Server	If the IP Mode is Static enter the address of the DNS server.
Login Mode	Only appears if IP mode is Dynamic, specify whether to automatically or manually login. If set to manual, the data synchronization will not occur until you login.
WAN VPI / VCI	Specifies the VPI and VCI for the customer-facing port on the DSLAM.
Encapsulation	Select LCC-SNAP or VC-MUX .
PPP Authentication (TI modem only)	If the Data Mode is PPPoE or PPPoA, select the authentication mode <ul style="list-style-type: none"> – Auto means that the SmartClass Triple Play Services picks the mode that matches the far end mode – CHAP is Challenge Handshake Authentication Protocol – PAP is Password Authentication Protocol
PPP Username	Enter a valid user name. This must be a valid user account with an ISP.
PPP Password	Enter the user password. This must be a valid password that matches the user name above. Passwords are often case-sensitive.
PPP Use Provider (TI modem only)	Select Yes or No . This option indicates whether to append the user name with the service provider domain name (for example, earthlink.net). Select Yes only if user names for the ISP must include the domain name as part of the user name. This setting automatically appends the @ sign for you.
PPP Provider	Enter the provider name. This is required if you selected Yes for “Use Provider.”

- 3 Select **PTM Operation** and then specify the settings. The PTM settings are available if your unit has a Broadcom modem. It is greyed out if you specified ATM transport mode. The following table describes the settings.

Setting	Description
Data Mode	Select the network type. – None turns the data layer off – IPoE is IP over Ethernet – PPPoE is PPP over Ethernet
IP Mode	Select either Static or Dynamic (DHCP) if using IPoE.
IP Addr.	If the IP Mode is Static, enter the IP address that the tester will use.
IP Netmask	If the IP Mode is Static, enter the net mask address.
Gateway	If the IP Mode is Static, enter the gateway address.
DNS Server	If the IP Mode is Static enter the address of the DNS server.
Login Mode	Only appears if IP mode is Dynamic, specify whether to automatically or manually login. If set to manual, the data synchronization will not occur until you login.
PPP Username	Enter a valid user name. This must be a valid user account with an ISP.
PPP Password	Enter the user password. This must be a valid password that matches the user name above. Passwords are often case-sensitive.

- 4 Specify the **Mac Addr. Mode** — factory default or user defined.

The WAN settings are specified.

Specifying LAN settings

If the modem operation mode is Router, the LAN Setup is available

To specify LAN settings

- 1 From the Network menu, select **LAN Setup**, and then specify the settings. The following table describes the settings.

Setting	Description
Server IP	Enter the tester's LAN server IP address.
Netmask	Enter the LAN net mask address.
LAN DHCP Server	Enable or disable the tester's DHCP server. You should enable the DHCP server when the customer's CPE is configured to receive an IP address automatically.
DHCP Start	If DHCP Server is enabled, enter the starting IP address for the tester's DHCP server.
DHCP End	If DHCP Server is enabled, enter the ending IP address for the tester's DHCP server.

Setting	Description
Test IP Mode	Select the Test IP Mode. Disabled means the SmartClass Triple Play Services will act only as a basic router and not do any data tests. (See Figure 9 on page 50.) Automatic means that the test set will automatically determine an IP address on the same netmask. Manual means a specific IP has been assigned for testing.
Test IP Mode	If Test IP Mode is set to manual, enter the Test IP.

The LAN settings are specified.

Connecting to the line

The method used to connect to the line varies depending on the test mode and line configuration.

Connecting to a single twisted pair

To connect to a single twisted pair

- 1 Using the RJ-45 to telco clips cable, connect the **RJ-45 to bed of nails** test lead to the **DSL** connector on the right panel of the SmartClass.
- 2 Connect the **RJ-45 to bed of nails** test leads to the desired pair, black to tip(A) and red to ring(B).

The line is connected.

Connecting to bonded twisted pairs

To connect to bonded twisted pairs

- 1 Using the RJ-45 to telco clips cable, connect the **RJ-45 to telco clips** test lead to the **DSL** connector on the right panel of the SmartClass.
- 2 Connect the **RJ-45 to telco clips** test leads to the pairs: black to tip(A) and red lead to ring(B) for pair one; blue to T1 and yellow to R1.

The line is connected. The modems begin to train on the lines automatically.



NOTE:

You may see both lines sync, drop, and then re-sync again. This is typical for bonded lines. The modems include a test probe that syncs both pairs, drops, and then re-syncs in bonded mode.

If one of the pairs is not capable of bonding, or the pairs do not bond, a red error message box appears.

Connecting to a single pair at the NID/demarc

To connect to a single twisted pair using the “Y” cable

- 1 Connect the single end of the test cable to the jack on the side of the SmartClass.
- 2 Connect the blue end of the cable to Modem on the NID/demarc.

The line is connected.

Connecting to bonded pairs at the NID/demarc

To connect to bonded twisted pairs

- 1 Using the RJ-45 “Y” cable, connect the single end of the “Y” test cable to the jack on the side of the <product name>.
- 2 Connect the blue end of the cable to Modem 1 and the orange end of the cable to Modem 2 on the NID/demarc.

The line is connected. The modems begin to train on the lines automatically.



NOTE:

You may see both lines sync, drop, and then re-sync again. This is typical for bonded lines. The modems include a test probe that syncs both pairs, drops, and then re-syncs in bonded mode.

If one of the pairs is not capable of bonding, or the pairs do not bond, a red error message box appears.

Testing the physical layer

You can use the SmartClass Triple Play Services to test the physical layer of the ADSL link. The following procedure describes the basic test for the DSL link.

To perform a basic DSL link test

- Connect to the line and allow the unit to train on the line.

If the unit achieves sync, you have verified the physical layer.

Testing line quality

Once connected to the line, the SmartClass Triple Play Services gathers statistics for the line. These statistics are used to determine the line quality.

To test line quality

- 1 Connect to the line. See [“Connecting to the line” on page 57](#).

The modem begins the training process automatically. When it reaches show time, the SmartClass Triple Play Services begins gathering statistics.

- 2 Use the **DSL Summary** results menu to view different types of statistics.

If the unit achieves sync at the desired data rates, noise margins, and attenuation, the ADSL link is good.

Use the # key to view more statistics.

- 3 To save a test report, press the utility (i) key and then select **Save Report** or **Save To Job**, and then specify the report settings such as report name, report format, technician ID, location, and other settings as needed.

For more information on the results, see [“DSL Results” on page 122](#).

Terminating the loop (SELT)

Single End Loop Test (SELT) is used to test a copper loop when there is no equipment installed at the far end. It is typically used for pre-qualification, that is, testing whether a loop is capable of supporting DSL service. In some cases, SELT testing is aided by placing a termination at the far end of the line. This test sets the DSL modem to provide a line termination where the modem is idle and not transmitting.

To run a SELT termination

- 1 On the right panel of the SmartClass, connect one end of the test cable to the **DSL** connector, and the other end to the line under test.
- 2 Select **DSL Test**, and then select **xDSL SELT**.
After initializing the modem, the SELT verification screen is displayed.
- 3 The far end technician can continue testing.

Data testing

This chapter provides task-based instructions for using the SmartClass Triple Play Services data testing features. Topics discussed in this chapter include the following:

- [“About data testing” on page 62](#)
- [“Connecting to the line” on page 62](#)
- [“IP Ping testing” on page 62](#)
- [“Monitoring pings” on page 63](#)
- [“Throughput testing” on page 64](#)
- [“Tracing the packet route” on page 65](#)
- [“Capturing network traffic” on page 65](#)

About data testing

With the SmartClass Triple Play Services you can test data services such as IP ping, FTP/HTTP, and traceroute.

To access the Data application

- Select an interface (Ethernet TE, Wi-Fi, DSL-Bridge, or DSL-Modem/Router), and then select **IP Data**.

This test involves the following steps:

- Connecting to the line
- Specifying test settings
- Performing tests

Connecting to the line

Before running the test, connect to the line. The procedure varies depending on the interface.

To connect to the line

- 1 If you are on an Ethernet circuit, connect to the line by doing the following:
 - a Connect one end of an Ethernet cable to the **Ethernet** jack on the right side of the unit.
 - b Connect the other end of the cable to an Ethernet jack.
- 2 If you are on a xDSL circuit, connect to the line as described in [“Connecting to the line” on page 57](#). If you wish to allow CPE connectivity, use the Ethernet cable to connect to the CPE by connecting one end of the Ethernet cable to the Ethernet jack on the right side of the SmartClass TPS, and then connecting the other end of the cable to the PC, hub, or router.
- 3 If you are on a Wi-Fi circuit, configure the Wi-Fi as described in [“Emulating a Wi-Fi end point” on page 70](#).

The test leads are connected.

IP Ping testing

Run an IP ping test when you want to send and receive ping packets to test connectivity.

When running an IP ping test, the SmartClass Triple Play Services sends out a ping request packet to which the destination (target) responds by sending a response packet. IP ping tests tell you if the destination is alive and awake, how fast the ping went to the destination and back to the SmartClass Triple Play Services, and if ping packets were dropped and lost along the way.

To run an IP ping test

- 1 If you haven't already done so, specify the Network settings. (See [“Specifying the network setup” on page 42](#).)
- 2 Do one of the following:
 - If testing using IPv4oE, from the IP Data menu, select **Ping Test**.
 - If testing using IPv6oE, select the IPv6 Ping menu.

Specify the settings. The following table describes the settings.

Setting	Description
Destination Type	Specify whether the destination is an IP Address , DNS Name (domain name server), or IPv6 Address . IP address uses the numeric address. DNS name uses the domain name, such as www.jdsu.com. JDSU recommends using the IP address or DNS name of the ISP gateway of the customer's service provider.
IP Address	If the destination is IP Address, enter the IP address.
DNS Name	If the destination is DNS Name, enter the DNS name.
TX Count	Enter the number of pings to send before stopping.
TX Interval	Specify the number of pings per second.
Payload Size	Enter the ICMP Payload Size in Bytes. The default is 16. Change this only if needed.

- 3 Select **Ping Test Menu** to start the ping and display the test results menu.
Use the **#** key to stop the test, if desired.
- 4 To save a test report, press the utility (i) key and then select **Save Report** or **Save To Job**, and then specify the report settings such as report name, report format, technician ID, location, and other settings as needed.

For more information on the results, see ["IP Data results" on page 128](#).

Monitoring pings

The Ping Monitor allows you to monitor incoming pings on an active line. This is useful for network administrators to watch the network states and identify trouble.

To monitor pings

- 1 From the IP Data menu, select **Ping Monitor**.



NOTE:

The Ping Monitor is only available when the modem is synchronized and the data layer is active.

- 2 View the results.
The results include the IP address and number of pings received. The IP address is for the most recent device detected.
- 3 To save a test report, press the utility (i) key and then select **Save Report** or **Save To Job**, and then specify the report settings such as report name, report format, technician ID, location, and other settings as needed.

Throughput testing

This test uses FTP or HTTP to transfer files and measure the resulting throughput which yields a throughput that the end user would experience.

To test throughput

- 1 From the IP Data menu, select **File Transfer Test**, and then specify the settings. The following table describes the settings.

Setting	Description
Transfer Direction	Specify whether the transfer will be in the upload or download direction.
Transfer Protocol	Specify whether to use FTP or HTTP protocol for the transfer
HTTP Auth. Type	If you selected HTTP as the transfer protocol, select an HTTP Authentication type <ul style="list-style-type: none">– None – no user name/password authentication needed– Basic – the client sends the user name and password entered, with no security– Digest – the client sends the user name and password in a series of hashes for added security.
Username	Enter a valid user name. (appears if Basic or Digest is the Authentication Type)
Password	Enter the user password. This must be a valid password that matches the user name above. Passwords are often case-sensitive. (appears if Basic or Digest is the Authentication Type)
Download URL or Upload URL	Enter the URL address to upload to or to download from.
Upload real file	Select whether to send a block of random data or to upload a real file.
Upload file	Specify the file to be uploaded (appears if Upload real file is Yes). The file must be in the root directory or in the FTP directory of the unit or a connected USB stick.
Upload pattern	Specify the type of pattern to include when uploading random data. (appears if Upload real file is No)
File size	Specify the file size to upload, in number of bytes. (appears if Upload real file is No)
Save Downloaded File	Select whether to save the downloaded file. NOTE: Selecting YES can impact the performance of the unit.
Download filename	If you selected YES to “Save the Downloaded File”, enter a name for the file.
Concurrent Downloads	Specify whether you wish to do multiple downloads at the same time. Concurrent downloads can utilize the bandwidth pipe better than a single download and is a better estimate of actual bandwidth.
Auto Repeat	Specify whether you want to automatically repeat the transfer as it runs in the background. This is useful to verify whether it causes problems with other services.

- 2 Select **File Transfer Menu** to start the transfer and display the test results menu.
Use the * key to clear the results or the # key to restart the test.
- 3 To save a test report, press the utility (i) key and then select **Save Report** or **Save To Job**, and then specify the report settings such as report name, report format, technician ID, location, and other settings as needed.

For more information on the results, see [“IP Data results” on page 128](#).

Tracing the packet route

Using the trace route feature, you can trace the IP packet path through the network. The following procedure describes how to trace the packet route.

To trace the packet route

- 1 From the IP Data menu, select **Traceroute Test**, and then specify the settings. The following table describes the settings.

Setting	Description
Destination Type	Select either IP address or DNS Name (domain name server name) as the destination type.
IP Address	If the Destination Type is IP Address, enter the destination IP Address.
DNS Name	If the Destination Type is DNS Name, enter the destination DNS Name.
Packet Type	Select either ICMP (Internet Control Message Protocol) or UDP (User Datagram Packet) as the packet type.
DNS Lookup Hops	Specify whether you want to lookup names for hops.

- 2 Select **Start Traceroute Test** to start the test and display the test results menu. Use the * key to clear the results or the # key to restart the test.
- 3 To save the results, press the **Utility** key and then the **5** key. For more information on the results, see [Chapter "IP Data results"](#).

The packet route is traced.

Capturing network traffic

The SmartClass Triple Play Services allows you to capture network packets to a file on the SmartClass or to a file on a USB drive.

The capture feature allows you to filter captured information by IP address, port number, or by a user-defined filter string. The information can be saved to a file, using PCAP format, which can be sent to a network technician for analysis on a protocol analyzer.



NOTE:

Packet Capture is only available in IPv4 modes (not available in IPv6).

If you insert a USB drive into the SmartClass Triple Play Services, it will recognize the drive and it will become the default location where the packets will be saved. Otherwise, the packets will be saved to a file in the internal File Manager. The maximum file size for packets stored in the internal File Manager is 1 Mbytes; for USB capture, file size depends on the space available on the USB drive.

To capture network traffic

- 1 Select an interface (Ethernet TE, Wi-Fi, DSL-Bridge, or DSL-Modem/Router), and then select **Network**.
- 2 From the Interfaces menu, select **Packet Capture**.

3 Specify the Packet Capture settings. The following table describes the settings.

Setting	Description
Filename	Name of the file where the captured packets are saved.
Packet limit	The packet limit indicates how much information can be stored in the capture file (in other words, the size of the capture file). You can specify from 1 to 10000000 packets. When the maximum file size has been reached, the SmartClass Triple Play Services automatically stops capturing packets.
Promiscuous mode	Enabling Promiscuous mode causes the SmartClass Triple Play Services to capture all IP traffic regardless of source or destination addresses.
Use IP filter	Specify whether to filter messages by IP address (No will disable the filter).
IP Filter	If you selected "Yes" to Use IP filter, enter an IP address to filter on. Only information from the IP address you entered will be captured.
Use Port Filter	Specify whether to filter messages by port (No will disable the filter).
Port Filter	If you selected "Yes" to Use Port Filter, enter the port number to filter on. You can enter a number from 2 to 65534. Only messages from the port you entered will be captured.
Use Custom Filter	Specify whether to filter messages using a custom filter (No will disable the filter)
Custom Filter	If you selected "Yes" to Use Custom Filter, enter a text string using the keypad. Some commonly used strings are as follows: <ul style="list-style-type: none"> - tcp - captures only TCP packets - udp - captures only UDP packets - igmp - captures only IGMP packets - not tcp - captures all packets except TCP - less 1000 - captures all packets less than 1000 bytes in length - greater 1000 - captures all packets greater than 1000 bytes in length.

4 Select **Packet Capture Menu**

5 Press the # key to start the capture.



NOTE:

The Start key is only available if a valid network connection is present.

Captured information is saved to the file. If you have a USB storage device connected, it will be saved there. If not, the file will be saved to the SmartClass Triple Play Services file system.



CAUTION: CORRUPTED DATA

Removing the USB drive during a file capture or file save may corrupt the data. Do not remove the drive until all files have been saved or the packet capture is complete.

You have captured network traffic.

Wi-Fi Testing

This chapter provides task-based instructions for using the optional Wi-Fi testing features. Topics discussed in this chapter include the following:

- [“About Wi-Fi Testing” on page 68](#)
- [“Scanning for Wi-Fi networks” on page 68](#)
- [“Emulating a Wi-Fi end point” on page 70](#)
- [“Providing Wi-Fi access” on page 71](#)

About Wi-Fi Testing

The SmartClass Triple Play Services's optional Wi-Fi testing features allow performance assessment and troubleshooting the customer premise Wi-Fi network.

The Wi-Fi testing features of the SmartClass include the following:

- Quickly determine the available SSIDs, level and channel of Wi-Fi networks visible from any location. The test set can attach to a customer's network and provide assessment of the signal strength throughout the premises.
- Provide a generic Wi-Fi access point (bridged Ethernet to WiFi) to verify IP connectivity, run tests to back office, or configure CPE.

To access the Wi-Fi tools

- On the Main Menu screen, select Wi-Fi.

The Wi-Fi menu appears.



Figure 11 Wi-Fi menu

Depending on your unit configuration, your menu may vary.

Wi-Fi testing is only available on the two Wi-Fi enabled configurations: CSC-TPSVW and CSC-TPSVW-CU. Software options also enable certain features.

Table 11 Wi-Fi software options

Option	Description
WiFiTest	Allows all of the WiFi related capable test features (WiFi scan & Histogram, connect to a WiFi Network for testing, and WiFi-to-Ethernet Bridge)
Mobile App Connectivity	Provides connectivity to the iOS App.

For additional information about SmartClass Triple Play Services options and services, contact your local JDSU representative or contact JDSU through the company web site, www.jdsu.com.

Scanning for Wi-Fi networks

The Wi-Fi Network Scan is used to determine whether any Wi-Fi networks are available, and provides the SSIDs, level and channel of any networks detected.

To run a network scan

- 1 From the Wi-Fi Tools menu, select **Wi-Fi Scan**.

The test will start searching for active Wi-Fi networks. The Wi-Fi search process may take a few seconds.

After Wi-Fi search is finalized, results are gathered and displayed. A sample result screen is shown in [Figure 12](#).

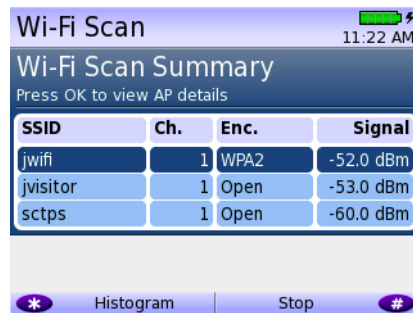

Figure 12 Wi-Fi Scan Summary results

[Table 12](#) describes the Wi-Fi summary results.

Table 12 Wi-Fi scan summary results

Results	Description
SSID	The Service Set Identifier Of the specific wireless network
Ch	Wi-Fi channel being used by the specific network
Enc.	The security encryption being used on the Wi-Fi network
Signal	The signal power level of the selected Wi-Fi Network

To select a located network, use the up and down arrow keys to highlight the network.

- 2 To view a histogram of the network, press the * key. A sample screen is shown in [Figure 13](#).

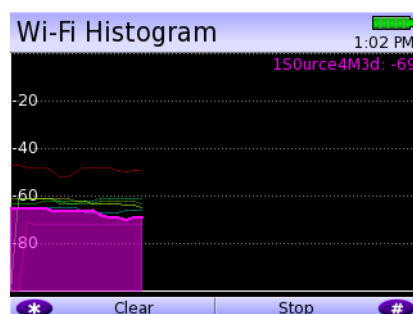

Figure 13 Wi-Fi Histograms

The signal power over time is shown in graphical form.

- 3 To view the details for a network, on the Scan Summary results, use the up and down arrows to highlight the desired network, and then press the **OK** key.

Table 13 describes the Wi-Fi detailed results.

Table 13 Wi-Fi scan detailed results

Results	Description
MAC Address	The MAC address of the specific wireless network.
SSID	The Service Set Identifier of the specific wireless network
Protocol	The IEEE protocol used on the network.
Channel	The Wi-Fi channel being used by the specific network
Frequency	The signal frequency of the Wi-Fi network
Encryption	The security encryption being used on the Wi-Fi network
Max Bit Rates	The highest bit rates measured on the Wi-Fi network
Signal Level	The power level of the selected Wi-Fi Network

Emulating a Wi-Fi end point

The “Wi-Fi Network” feature is used to provide a connection to the Wi-Fi network as a managed end point. This allows you to ping or surf the web to verify data connectivity, place VoIP calls, and perform other tests.

To emulate a Wi-Fi end point

- 1 From the Wi-Fi menu, select **Wi-Fi Network**.
 - 2 Select **Network**.
 - 3 Select **End Point Setup**, and then do the following:
 - a Select SSID to verify the network ID that you are connect to.
 - b Specify the **Key**, if necessary (the network has security enabled).
 - c If needed, specify the Network Setup as described in [“Specifying the network setup” on page 42](#).
 - 4 Select **End Point Status** to view the network status.
 - 5 Select **End Point Results** to view statistics.
 - 6 If desired, browse the web, place a VoIP call, or run an automatic test.
- IP connectivity is verified.

Providing Wi-Fi access

The Wi-Fi AP selection is an Ethernet-to-Wi-Fi bridge mode to create an access point for mobile devices such as Smart Phones, Tablets, Laptops, and so on. Connection to the internet comes from the broadband service behind the RG or router. This mode allows the mobile devices to verify internet connectivity without hunting for CPE passwords, running tests to the CO, or even configuring (or reconfiguring) the RG as required.

To provide Wi-Fi access

- 1 From the Wi-Fi menu, select **Wi-Fi AP**.
- 2 Select **Network Setup** to verify network settings.
 - a If needed, specify the Wireless Setup as described in [“Communicating with a mobile device” on page 23](#).
 - b If needed, specify the Network Setup as described in [“Specifying the network setup” on page 42](#).
- 3 If needed, configure the Wi-Fi settings on the mobile device to connect to the SmartClass Triple Play Services.

HPNA Testing

This chapter provides task-based instructions for using the optional HPNA testing features. Topics discussed in this chapter include the following:

- [“About HPNA Testing” on page 74](#)
- [“Monitoring the HPNA network” on page 74](#)

About HPNA Testing

The capabilities of the SmartClass Triple Play Services's optional HPNA testing features include the following:

Operational mode — This mode monitors the active network during its normal operation and periodically updates statistics.

Network test mode — This transient mode performs a disruptive network test that transfers a configurable number of packets across each unidirectional logical link in the network and gathers statistics.

These features are available if the HPNA software option is enabled.

Connecting to the line

After specifying the test settings, you can connect to the line.

To connect to the line

- 1 Connect one end of an Ethernet cable to the Ethernet jack on the right side of the unit.
- 2 Connect the other end of the cable to the Ethernet port of the CPE that is on the HPNA network (such as a set-top-box or residential gateway).

Monitoring the HPNA network

The following procedure describes how to monitor the HPNA network.

To monitor the HPNA network

- 1 On the Main Menu, select **HPNA**.
The Station List screen appears.

Table 14 Station List results

Results	Description	Units	Range/Values
H	This column indicates the host/client of every HPNA device in the network		H: Host device
Id	The station identifier for the HPNA device.	numeric digit	0-9
Hpna MAC	The MAC address of the HPNA device in the network	aa:bb:cc:dd:ee:ff	Each field is 00-FF hex
Ver-Chip	The device's firmware version and CopperGate™ chip ID.	revision-chip id	Chip ID = Chipset 0 3010 1 3110 2 3210 3 3310 4 3320

- 2 If desired, use the arrow keys to highlight a specific node and then press the OK key to view more detailed statistics for that node.

Testing the HPNA network

This test verifies that all installed devices are operating correctly.

To test the HPNA network

- 1 On the Main Menu, select **HPNA**.
A list of HPNA nodes appears.
Verify that all HPNA devices are present on the network before proceeding.
- 2 Press the * key to specify the HPNA settings.
 - Specify the **HPNA Minimum Rate** (the minimum rate, in Mbps, that will pass)
 - Specify the **HPNA Minimum SNR** (the minimum SNR, in dB, that will pass)
 - Specify the **Quick Max Packet Lost** (the maximum packet loss, in number of packets, allowed for the Quick Test)
 - Specify the **Chronic Max Packet Lost** (the maximum packet loss, in number of packets, allowed for the Chronic Test)
- 3 Select the # key to select the type of test to run:
Quick – 5,000 packets. Used to quickly test the HPNA network for common issues.
Chronic – 100,000 or more packets. Used to exhaustively test the HPNA network for chronic trouble.



NOTE:

The size and number of packets may be adjusted from the default settings for each Quick or Chronic test prior to proceeding.

- 4 Select the # key to begin the test.
After the network test finishes, the screen updates to report the data rate, modulation, packet error rate, and signal to noise ratio on the current link.
If the packet error rate is zero and the data rate is over 112Mb, the screen will indicate a pass. If the packet error rate is non-zero, SNR is less than -34 dB, or the data rate is less than 112Mb, the screen will indicate a failure in red.
- 5 Use the up and down arrow keys to view the results.
- 6 Highlight a specific node and then press the OK key to view node-to-node link information, such as the MAC addresses and the received power.
- 7 Press the # key to view live statistics between the selected HPNA nodes.
- 8 To save a test report, press the utility (i) key and then select **Save Report** or **Save To Job**, and then specify the report settings such as report name, report format, technician ID, location, and other settings as needed.

For more information on the results, see [“HPNA results” on page 130](#).

SmartID Testing

This chapter provides task-based instructions for testing with SmartIDs. Topics discussed in this chapter include the following:

- [“About the SmartIDs” on page 78](#)
- [“Registering SmartIDs” on page 79](#)
- [“Configuring SmartID settings” on page 79](#)
- [“Locating SmartIDs” on page 80](#)
- [“Testing the home run for VDSL service” on page 81](#)
- [“Testing the home network” on page 82](#)

About the SmartIDs

The SmartIDs (Figure 14) allow a technician to connect the <product name> directly to any single SmartID device which then communicates with any other connected SmartID devices in order to certify an in-home network and provide distances to found impairments. See Figure 15.



Figure 14 SmartID

The difference in the SmartIDs versus the other terminators is that the terminators only indicate their location, whereas the SmartIDs each also are used to identify their location, but also each SmartID does a broadband noise ingress measurement, dual-ended FDR for coax mapping and frequency sweeping to locate impairments.

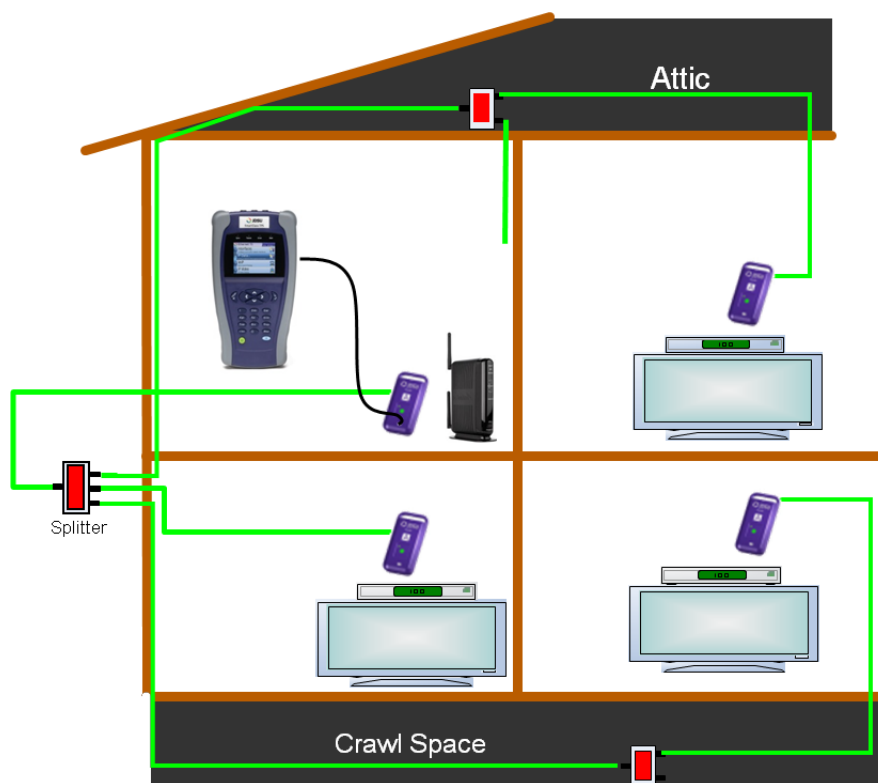

Figure 15 SmartID connection

If a Diplexer is on the network, disconnect the VDSL connection.

There are three test modes

- Locate SmartIDs – finds and identifies all SmartIDs currently connected to the network.
- VDSL Home Run Check – a two-point (two SmartIDs) test across the cable connecting at the residential gateway and the diplexer locations. This test is to qualify a coaxial cable home run intended to be used for VDSL service from the NID to a RG (i.e. instead of supplying VDSL signal to the RG over twisted pair).
- Whole Home Check – tests a complex cable network that may or may not include a Diplexer. It is intended to qualify the network for HPNA.

Registering SmartIDs

Before the first test with the SmartIDs, you must register all of the SmartIDs with the instrument. This registration applies to the SmartID that the <product name> is physically connected to. You will need to repeat the procedure for each SmartID, connecting it directly to the <product name>.

To register SmartIDs

- 1 From the Main Menu, select **SmartID**.
- 2 On the SmartID screen, select **Settings**.
- 3 On the SmartID Settings screen, select **SmartID Registration**.
- 4 Press the * key to add a new SmartID.
- 5 Enter the label (A-Z) for the SmartID. This is the letter that is on the SmartID. You may need to apply the label if one is not present, and the label can be changed, if desired.
- 6 Enter the serial number (found under the battery cover or on the side of the SmartID) or plug in the SmartID. If the SmartID is plugged in, it will advertise its serial number to the <product name>.
- 7 Repeat [step 4](#) through [step 6](#) for each SmartID.

The SmartIDs are registered.

Configuring SmartID settings

This menu specifies settings used for locating SmartIDs.

To configure SmartID settings

- 1 From the Main Menu, select **SmartID**.
- 2 On the SmartID screen, select **Settings**.
- 3 Select **Cable Types** to add, edit, or remove cable types.
- 4 Select **Configuration**, and then specify the following:
 - patch cable length
 - noise threshold (values at or above this limit are failing)
 - fast scan limit (amount of time the Continuous Fast-Scan Locate SmartID mode runs before requiring a restart)
 - power off limit (this is the time at which the SmartIDs will auto power-off after a test)

The settings are specified.

Locating SmartIDs

The purpose of this test is to identify up to 16 SmartIDs on the network. The SmartIDs will work through splitters, and multiple SmartIDs can be detected simultaneously.

To locate SmartIDs

- 1 Connect SmartIDs to the network at any location in the home where network qualification or troubleshooting is desired, such as set top boxes or residential gateways (see [Figure 15](#) for examples).
- 2 Connect the USB cable from <product name> to one of the SmartIDs.
- 3 On the SmartID screen, select **Locate SmartIDs**.
If a warning message appears saying that no SmartIDs are registered, register the SmartIDs as described in ["Registering SmartIDs" on page 79](#).
- 4 If the test doesn't automatically start, press the # key to restart.
The test runs and then displays the IDs found.
- 5 To enter Fast-Scan mode, press the * key.
The Locate SmartIDs test performs a single locate function. Fast-Scan mode continuously scans for connected SmartIDs to allow you to quickly identify multiple coax runs in succession. Since continuously scanning for SmartIDs can drain battery life, the default timeout can be adjusted in the ["Configuring SmartID settings" on page 79](#).
- 6 To save a test report, press the utility (i) key and then select **Save Report** or **Save To Job**, and then specify the report settings such as report name, report format, technician ID, location, and other settings as needed.

Testing the home network

The Whole Home Check maps a coax network and provide distances to found impairments.

To run a Whole Home Check

- 1 Disconnect the cable or DSL feed. If using a diplexer, disconnect the feed to the diplexer (and leave it open).

**NOTE:**

All live network signals must be disconnect from the coax network under test.

- 2 Connect a SmartID at the point of entry and use the USB cable to connect the SmartClass Triple Play Services to the SmartID.

In order to map the network accurately, make sure that you connect to the primary SmartID (connected to the SmartClass Triple Play Services with a USB cable) on the main side of the residential gateway or splitter and not on a branch leg.

- 3 Place other SmartIDs at any location in the home wherever network qualification or troubleshooting is desired.

There are three possible test configurations:

- a NID without diplexer: The primary SmartID (connected to the SCH with a USB cable) should be connected at the RG (in place of the RG), and the remaining SmartID probes should be connected at the STBs (in place of the STBs).
- b NID with diplexer: The primary SmartID (connected to the SCH with a USB cable) should be connected at the RG (in place of the RG), and the remaining SmartID probes should be connected at the STBs.

When a Diplexer is on the network, the VDSL connection must be disconnected.

- c INID: The primary SmartID (connected to the SCH with a USB cable) should be connected at the INID coax connection feeding into the home (disconnected from the INID), and the remaining SmartID probes should be connected at the STBs.

When connecting a SmartID to a wall plate, it is recommended to use a coax jumper cable of at least 3 feet in length.

Ensure that all devices except SmartIDs are disconnected from the network.

- 4 On the Main Menu, select **SmartID**.
- 5 On the SmartID screen, select **Whole Home Check**.
- 6 On the Select SmartID Test Plan screen, select whether to test through a diplexer (RG - Through Diplexer) or not (RG - No Diplexer).
 - For the NID without diplexer configuration (configuration a, above), select **RG - No Diplexer**.
 - For the NID with diplexer configuration (configuration b, above), select **RG - Through Diplexer**.
 - For the INID configuration (configuration c, above), select **RG - No Diplexer**.
- 7 Begin the test.

After the test completes, the result test summary appears.

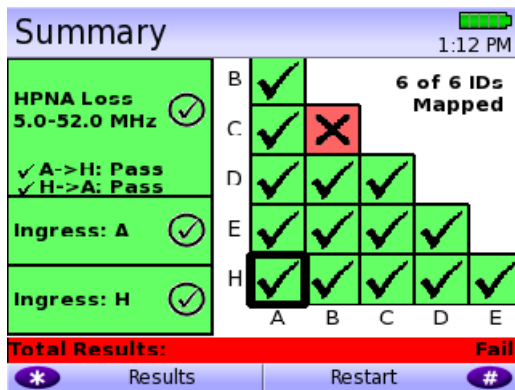

Figure 17 Whole Home Test Summary (Example)

The test summary displays the paths between SmartIDs and indicates whether the quality of the path between the two points is passing or failing based on pre-set limits. The left side of the screen will show the frequency sweep and noise ingress measurement results for each highlighted box, which corresponds to the two points between SmartIDs in the coax network.

To view other test results, press the * key and then either use the arrow keys to navigate to different SmartID results or directly select the desired result: Test Summary, Detailed View, Network Map, or Sweep Data. For more detail on the results, see [“SmartID results” on page 131](#).

- 8 To save a test report, press the utility (i) key and then select **Save Report** or **Save To Job**, and then specify the report settings such as report name, report format, technician ID, location, and other settings as needed.

VoIP Testing

This chapter provides task-based instructions for using the optional SmartClass Triple Play Services voice over IP (VoIP) testing features. Topics discussed in this chapter include the following:

- [“About VoIP” on page 86](#)
- [“Specifying test settings” on page 86](#)
- [“Connecting to the line” on page 91](#)
- [“Placing and receiving calls” on page 91](#)

About VoIP

Using the optional VoIP testing features, you can emulate a VoIP phone to place and receive VoIP calls.

You can expand your testing capability by purchasing additional VoIP testing options. The options available for purchase are as follows:

Table 15 VoIP testing options

Option	Description	Order Number
VoIP	VoIP application, including SIP, H.323, and MGCP signaling	SCTP-VoIP
MOS	Mean Opinion Score (MOS) option (requires VoIP option)	SCTP-MOS
SCCP	Cisco SCCP call control (requires VoIP option)	SCTP-SCCP

For additional information about SmartClass Triple Play Services options and services, contact your local JDSU representative or contact JDSU through the company web site, www.jdsu.com.

To access the VoIP application

- Select an interface (Ethernet TE, Wi-Fi, DSL-Bridge, or DSL-Modem/Router), and then select **VoIP**.



NOTE:

VoIP is only available in IPv4 modes (not available in IPv6).

The VoIP phone test involves the following steps:

- Specifying test settings
- Connecting to the line
- Placing and receiving calls

Specifying test settings

Before you begin testing, make sure that the SmartClass Triple Play Services settings match the settings of the phone you are emulating.



TIP:

Test configurations can be stored for easy recall and use (see “[Managing test configurations](#)” on page 29).

To specify test settings

- 1 From the VoIP menu, select **VoIP Setup**.

Configuring the settings can be done one of two ways:

- Press a number on the key pad that corresponds to the setting you want to configure.
- Use the arrow keys to highlight the setting you want to change, and then press the **OK** key. Press the **Cancel** key to exit a menu.



NOTE:

You must specify the interface settings before specifying VoIP settings. For example, you must configure the Network, LAN, and other applicable settings for a xDSL line.

2 Select **General Setup**, and then specify the settings.

The available settings depend on the call control selected. The following table describes the settings.

Setting	Description
CC Standard	Specify the call control standard: H.323 (Fast connect), H.323 (Full), SIP, SCCP, or MGCP. NOTE: Some call controls are options, so if your unit is not equipped with the option, you will not see all of the selections.
Auto Answer	Specify whether to automatically answer incoming calls. Yes means <i>all</i> incoming calls are answered automatically. No is the typical setup and means that calls will be answered manually.
Alias (H.323 or SIP)	For H.323, this is the phone number alias that will be associated with the phone that you are trying to emulate. This phone number will be included in the connection request messages that are exchanged with the Gatekeeper/Proxy or other endpoint devices. For SIP, this specifies the registrar. If you have a network that uses one server for registration (the registrar) and another for placing and receiving calls “Alias” specifies the registrar. (“Proxy IP” on the Proxy Settings menu specifies the server used for placing and receiving calls.) There are two ways to get the Alias for SIP - you can specify the Alias by directly entering a value by yourself; or alternatively, by querying a web server to get back an Alias value. Using the latter way, you need to enter the URL of the web server.
H.323 ID (H.323)	Enter the ID, using up to 40 characters. This is an ID element field in the ALIAS information that is sent to the Gatekeeper during all registration and request messages. The H.323 gateway registers with an H.323 ID. This is either an email ID or an E.164 address. For example: Email ID (H.323 ID): gwy-01@domain.com E.164 Address: 5125551212
Bearer Capability (H.323)	This sets the Bearer Cap information element in the H.323 setup message for outgoing calls: Voice, 3.1K audio, Unrestricted digital
Calling Plan (H.323)	If required, this sets the Calling Party Numbering Plan information element in the H.323 setup message for outgoing calls: Unknown, ISDN/Telephony, Data, Telex, National, Private.
Calling Type (H.323)	If required, this sets the Calling Party Type information element in the H.323 setup message for outgoing calls: Unknown, International, National, Network Specific, Subscriber, Abbreviated.
Called Plan (H.323)	If required, this sets the Called Party Numbering Plan information element in the H.323 setup message for outgoing calls: Unknown, ISDN/Telephony, Data, Telex, National, Private.

Setting	Description
Called Type (H.323)	If required, this sets the Called Party Type information element in the H.323 setup message for outgoing calls: Unknown, International, National, Network Specific, Subscriber, Abbreviated.
Outbound Alias Type (SIP)	Select the method for outbound dialing: Dial by Phone Number or Dial by Name/URL/Email.
SIP Vendor (SIP)	Specify the vendor: Standard SIP, Nortel SIP, Huawei SIP.
Device Type (SCCP)	Select the device type.
Device Name Type (SCCP)	Select one of the following: Automatic based on MAC address, or User Defined
Device Name (SCCP)	If Device Name Type is set to "User Defined", enter a device name.
Endpoint ID Type (MGCP)	Select one of the following: user defined or automatic based on the IP address (for example, aaln/01@[10.50.20.2]).
Endpoint ID (MGCP)	If Endpoint ID Type is set to "User Defined", enter the ID of the endpoint.

- 3 Press the right arrow to move to the **Audio/Codec** settings, and then specify the settings. The following table describes the settings.

Setting	Description
Audio codec	This selects which codec will be used.
Frame Interval	Set the speech per frame. This is the number of milliseconds of speech per transmission frame when using a sample based codec (such as G.711).
Jitter buffer	Set the jitter buffer size. This is the number of milliseconds of speech that will be collected before an attempt will be made to play the speech back. This allows lost, late, or out-of-sequence packets time to arrive and be reassembled before playback.
Transmit Source	Select the source of transmission: Voice conversation (transmits and receives live voice), IP voice announce (the unit repeats a sequence of words including the calling party's IP address), Tone
Silence suppression	Enable or disable.
RTP Diffserv Value	Enter a value to indicate the Voice IP Quality of Service Differentiated Services (DiffServ) code point. The value will occupy a 6-bit field in the packet headers of RTP stream voice packets and will indicate how packets are treated at each hop. You can specify a number from 0 to 63 to indicate the per-hop behavior.
RTP Port Minimum	Specify the RTP port minimum number. The real-time transport protocol (RTP) port number allows you to identify voice traffic versus other traffic. Some systems only accept RTP traffic on certain port numbers. (It must be a factor of 2.)
RTP Port Maximum	Specify the RTP port maximum number. (It must be a factor of 2.)

The next step depends on the CC Standard selected.

- For H.323, go to [step 4](#).
- For SIP, go to [step 5](#).
- For SCCP or MGCP, go to [step 6](#).

- 4 If you are using H.323 call control, press the right arrow to view the **Gate Keeper Settings**, and then specify the settings.

The following table describes the settings.

Setting	Description
Gatekeeper Mode	Specify one of the following: No Gatekeeper means no RAS (registration, admission, and status) messages will be used, Auto Discover uses a well known IP address and port number, Static allows you to enter the gatekeeper address
Gatekeeper IP	If the Gatekeeper mode is Static or Auto Discover mode, enter the IP address of the Gatekeeper.
Call Control Port	Enter the Call Control Port number. This is a UDP port that is used for call control messages (for placing and receiving calls).
RAS Port	Enter the port number of the Gatekeeper. This is a UDP port that is used for registration (RAS messages).
Remote RAS Port	Enter the Remote Call Control Port number.

- 5 If you are using SIP call control, press the right arrow to view the **Proxy Settings**, and then specify the settings.

The following table describes the settings.

Setting	Description
Proxy Mode	Specify whether the proxy uses a Static address or no proxy.
Address Type	Select IP Address or DNS Name .
Proxy IP	If Address Type is IP Address, enter the IP address of the proxy server. This is the outbound proxy, or the device from which the SmartClass will send and receive all SIP messages. If you have a network that uses one server for registration and another for placing and receiving calls, the Proxy IP specifies the address for placing and receiving calls ("Alias" on the General Settings menu specifies the registrar address).
Proxy Name	If Address Type is DNS Name, enter the DNS name of the proxy server.
Proxy Port	Enter the port number of the proxy.
Call Control Port	Enter the Call Control Port number.
Proxy User name	Enter the Proxy User name
Proxy Password	Enter the Proxy Password

- 6 If you are using SCCP or MGCP, press the right arrow to view the **Call Manager** or **Call Agent** settings, and then specify the settings.

The following table describes the settings.

Setting	Description
Call Manager IP / Call Agent IP	Enter the IP address of the Call Manager or Call Agent .
Call Manager Port / Call Agent Port	Enter the Call Manager Port or Call Agent Port . The range is from 1 to 65535.

- 7 Press the right arrow to view the **Stun Configs** settings, and then specify the settings.

STUN (Simple Transversal of UDP [User Datagram Protocol] Through NATs [Network Address Translators]) allows VoIP calls across a NAT router. These settings should only be changed if necessary.

The following table describes the settings.

Setting	Description
Stun	Enable or disable.
Server Address Type	Select IP Address or DNS Name .
Server IP Address	If the Server Address Type is IP Address, enter the IP address of the stun server.
Server Address	If the Server Address Type is DNS Name, enter the DNS name of the stun server.
Server Port	Enter the port number of the stun server.
Client Port	Enter the client port number.
Refresh Period	Specify the NAT refresh rate. This is the number of seconds between messages to the STUN server to keep the NAT mapping alive.



NOTE:

If STUN is enabled, the network layer will not come up until the STUN client on the SmartClass Triple Play Services has determined the type of NAT used between the SmartClass Triple Play Services and the STUN server.

- 8 Press the right arrow to view the **QOS Thresholds**, and then specify the settings.

The quality of service (QoS) measurement uses two thresholds – good and poor – to produce three quality ratings: good, poor, and fair. If the value is less than the good threshold, it is considered good and is indicated with a check mark. A value between good and poor is considered fair and is indicated by an exclamation mark. If the value is greater than the poor threshold, it is considered poor and is indicated by an X.

The following table describes the settings.

Setting	Description
Jitter Good	Enter the Pass threshold, in milliseconds.
Jitter Poor	Enter the Fail threshold, in milliseconds.
Delay Good	Enter the Pass threshold, in milliseconds.
Delay Poor	Enter the Fail threshold, in milliseconds.
Loss Good	Enter the Pass threshold, in milliseconds.
Loss Poor	Enter the Fail threshold, in milliseconds.
MOS Scaling	Select the scaling method. This selection affects the scaling of the CQ-MOS and LQ-MOS results (on the “Call Scores” result screen). This selection is only available if your unit is equipped with the MOS option.

The test settings are specified.

Connecting to the line

After specifying the test settings, you can connect to the line. The procedure is different depending on the access interface.

- For Ethernet connections, connect as described in “Connecting to the line” on page 44.
- For DSL connections, connect as described in “Connecting to the line” on page 57.

Placing and receiving calls

After specifying test settings and connecting to the line, you are ready to place and receive calls.

By placing and receiving calls you can do the following:

- If you can successfully register with the Gateway (or Call Agent/TPS/Proxy/etc.) you have verified the provisioning.
- If you can successfully place and receive calls from internal and external networks, you have verified connectivity.
- During an active call, you can view statistics such as MOS, Loss, and Jitter, to measure the call quality.

Placing a call

The following procedure describes how to place a VoIP call.

To place a VoIP call

- 1 From the main VoIP menu, select **VoIP Call**.

The VoIP Call menu appears.

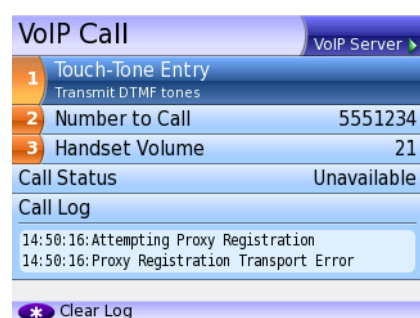

- 2 Select **Number to Call**.

The last number dialed appears.

To enter a different number, use the keypad. To backspace, use the down arrow key.

If the gatekeeper mode is None, enter the **IP to Call** also.

- 3 Select **Handset Volume**, and then use the arrow keys to adjust the volume.

- 4 Use the # key to **Dial**.

The unit goes off hook and places the call.

The call status will update at the bottom of the screen.

- 5 To transmit DTMF tones, select **Touch-Tone Entry**, and then use the keypad to specify the tone to transmit. You should hear the tone.
 - 6 If you are using the handset (internal speaker), **press the * key to talk**.
This feature is only available on the VoIP Call menu and only when a call is active. It is not available if you are transmitting (using IP voice announce or Tones as the transmit source, selected on the Audio/Codec setup menu).
 - 7 To view additional results, do one of the following:
 - Press the right arrow three times.
 - Press the **Cancel** key, and then select **VoIP Results**.
 - 8 *Optional*. Use the **Utility** key to save the results to a file.
 - 9 Use the **#** key to **Hang Up**.
The unit goes back on hook and ends the call.
 - 10 Press the * key to clear the log.
- See [“VoIP results” on page 132](#) to learn what your results mean.

Receiving a call

The following procedure describes how to receive a VoIP call.

To receive a VoIP call

- 1 When the SmartClass Triple Play Services signals an incoming call, use the **#** key to **Answer**.
The unit goes off hook and answers the call.
After the call is connected, the results will update in the bottom area of the screen.
 - 2 *Optional*. Press the * key to talk.
This feature is only available on the VoIP Call menu and only when a call is active.
 - 3 To view additional results, do one of the following:
 - Press the right arrow twice.
 - Press the **Cancel** key, and then select VoIP Results.
 - 4 To save a test report, press the utility (i) key and then select **Save Report**, and then specify the report settings such as report name, report format, technician ID, location, and other settings as needed.
 - 5 Use the **#** key to **Hang Up**.
The unit goes back on hook and ends the call.
- See [“VoIP results” on page 132](#) to learn what your results mean.

Answering calls automatically

The Auto Answer feature allows you to verify incoming service as well as caller ID service. When the SmartClass Triple Play Services answers a call, it logs the following information: time the call was answered, caller's IP address, time the call ended.

The following procedure describes how to answer calls automatically.

To answer calls automatically

- 1 From the VoIP menu, select **VoIP Settings** key, and then **GeneralSettings**.
- 2 Select **Auto Answer** and then specify **Yes**.
- 3 Press the **Cancel** key twice to return to the VoIP screen, and then select **VoIP call**.
- 4 Place a call to the SmartClass Triple Play Services from a VoIP phone (or a second Smart-Class Triple Play Services).
The SmartClass answers the call with a voice announcement, and then basic call statistics are provided.
- 5 To disable Auto Answer, do the following.
 - a Press the **Cancel** key to return to the VoIP main screen.
 - b Select **VoIP Settings**, and then **General Configs**.
 - c Select **Auto Answer**, and then specify **No**.

IP Video Testing

This chapter provides task-based instructions for using the optional IP video testing features. Topics discussed in this chapter include the following:

- [“About IP Video Testing” on page 96](#)
- [“Specifying test settings” on page 97](#)
- [“Connecting to the line” on page 100](#)
- [“Analyzing video streams” on page 100](#)

About IP Video Testing

The SmartClass Triple Play Services's optional IP video testing features allow verification of video service and testing of video quality.

The capabilities of the IP video feature include the following:

- Physical medium test
- IP connectivity test
- Video service verification
 - IP multicast test - Broadcast video service
Generate IGMP “join” and “leave” requests, verifying stream flows, changing channels, and multi-cast communications are working.
 - IP unicast test - VOD video service
Generate RTSP client requests for access to VOD media server, verifying that program stream flows and uni-cast communications are working.
 - UT Starcom Rolling Stream service
- Video quality test
 - Analyze video streams (ISO/IEC 13818 packet formats)
 - Provide detailed analysis of up to three streams

You can expand your testing capability by purchasing additional IP Video testing options. The options available for purchase are as follows:

Table 16 IP Video testing options

Option	Description	Order Number
IP Video	The IP Video application	SCTP-IPVIDEO
Video MOS	Provides mean opinion score (MOS) for IP video applications (requires IPVideo option)	SCTP-VMOS

For additional information about SmartClass Triple Play Services options and services, contact your local JDSU representative or contact JDSU through the company web site, www.jdsu.com.

To access the IP video application

- Select an interface (Ethernet TE, Wi-Fi, DSL-Bridge, or DSL-Modem/Router), and then select **IP Video**.



NOTE:

IP Video is only available in IPv4 modes (not available in IPv6).

IP video testing involves the following steps:

- specifying test settings
- connecting to the line
- analyzing video streams

Specifying test settings

Before you begin testing, make sure the test settings on the SmartClass Triple Play Services match the settings of the line and network configuration you are testing.



TIP:

Test configurations can be stored for easy recall and use (see [“Managing test configurations” on page 29](#)).

To specify test settings

- 1 From the IP Video menu, select **Video Setup**, and then specify the settings.
Configuring the settings can be done one of two ways:
 - Press a number on the key pad that corresponds to the setting you want to configure.
 - Use the arrow keys to highlight the setting you want to change, and then press the **OK** key. Press the **Cancel** key to exit a menu.



NOTE:

You must specify the interface settings before specifying Video settings. For example, you must configure the Data, LAN, and other applicable settings for a xDSL line.

The following table describes the settings.

Setting	Description
Mode	Select Terminate or Monitor mode.
Analysis Type	Select Normal or UT Starcom. Use UT Starcom when analyzing Rolling Stream video streams.
IGMP Version	If you are in Terminate mode, specify the version of IGMP signaling being used on the circuit: version 2 or version 3.
RTSP Port	Enter the RTSP port number. This is the port where RTSP signaling communication takes place in a particular network.
RTSP Vendor	Enter the RTSP vendor. This setting is only relevant in Terminate mode.

- 2 To specify settings for a particular stream, do the following:
 - a From the Video Setup menu, select the **Stream Setup** for the desired stream, for example **Stream 1 Setup**.
These settings are only available in Terminate Mode.

b Specify the settings.

The following table describes the settings.

Setting	Description
Stream Type	Select the video stream type: <ul style="list-style-type: none"> – Broadcast Auto – Broadcast MPEG2-TS/UDP – Broadcast MPEG2-TS/RTP/UDP – Broadcast RTP/UDP – Broadcast Rolling Stream – RTSP MPEG2-TS/(RTP)/UDP – RTSP RTP/UDP – RTSP RTP/TCP
IP	Enter the IP address of the stream. (Not available for RTSP streams.)
Port Number	Enter the port number of the stream. (Not available for stream type “Broadcast Auto” or RTSP streams)
URL	Enter the URL for the stream. (Only available with RTSP streams)

3 On the Video Setup menu, select **QoS Thresholds**, and then specify the settings.

The quality of service (QoS) measurement uses two thresholds – good and poor – to produce three quality ratings: good, poor, and fair. If the value is less than the good threshold, it is considered good and is indicated with a check mark. A value between good and poor is considered fair and is indicated by an exclamation mark. If the value is greater than the poor threshold, it is considered poor and is indicated by an X.

Additionally, RFC 2680 and RFC 3357 define enhanced analysis methods that are used to measure the quality of a media stream. There are two main statistics for this: Loss Period and Loss Distance.

The following table describes the settings.

Setting	Description
Latency Good	Enter the Pass threshold, in milliseconds. Latency is the amount of time between sending the “join” message and receiving the first video packet on the STB.
Latency Poor	Enter the Fail threshold, in milliseconds.
Leave Latency Good	Enter the Pass threshold, in milliseconds. Leave Latency is the amount of time between sending the “leave” message and receiving the last video packet on the STB.
Leave Latency Poor	Enter the Fail threshold, in milliseconds.
Jitter Good	Enter the Pass threshold, in milliseconds.
Jitter Poor	Enter the Fail threshold, in milliseconds.
Loss Good	Enter the Pass threshold, in milliseconds.
Loss Poor	Enter the Fail threshold, in milliseconds.
MPEG2-TS Error Ind. Good	Enter the Pass threshold.
MPEG2-TS Error Ind. Poor	Enter the Fail threshold.

Setting	Description
MPEG2-TS PID Timeout	Enter the PID Timeout. This is the amount of time to wait for a PID that has been declared as having video or audio data for traffic, since the last traffic was received. If this threshold is violated, then the PID Timeout result will increment.
MPEG2-TS PAT/PMT Timeout	Enter the PAT/PMT Timeout. This is the amount of time to wait after the last received PAT or PMT packet before declaring a timeout condition (which would then increment the PAT Errors or PMT Errors statistics)
RTP Loss Distance	Enter the Loss Distance threshold, in number of packets. This triggers when RTP losses cause a RTP LD Error. “Loss Distance” measures the difference in sequence numbers of two loss events, with a “loss event” being the loss of one or more packets in a row. So for the following stream (1 x 3 4 5 x 8 9 10) the loss distance between the two events is 4. If the loss distance is less than the configured threshold, then the “Loss Distance Error” statistic will increment.
RTP Loss Period	Enter the Loss Period threshold, in number of packets. This triggers when RTP losses cause a RTP LP Error. “Loss period” is the length of a single loss event, that is, the number of lost packets between two successfully received packets. So for the following example stream (1 x x x 5 6 7 x x 10 x 12), there are three loss periods, with lengths of 3, 2, and 1.

4 On the Video Setup menu, select **MOS Setup**, and then specify the settings.



NOTE:

When MOS Support is enabled, analysis is limited to one stream.

The following table describes the settings.

Setting	Description
MOS Support	Specify whether MOS Support is enabled or disabled.
ISMA Video Type	Specify the type of video codec used for analysis of ISMA streams.
ISMA Audio Type	Specify the type of video codec used for analysis of ISMA streams.

You are finished specifying test settings.

Connecting to the line

After specifying the test settings, you can connect to the line. The procedure is different depending on the access interface.

- For Ethernet connections, connect as described in [“Connecting to the line” on page 44](#).
- For DSL connections, connect as described in [“Connecting to the line” on page 57](#).

Analyzing video streams

The SmartClass Triple Play Services analyzes the video data packet flow at the packet level. Since the initial video quality is established by the source material and encoding process at the head end, and the decoding quality is established by the STB, the effects of the transport and access networks on the video streams are the variables requiring analysis. Actual video content decoding is not performed.



NOTE:

The data connection must be established for video streams to be visible to the SmartClassTriple Play Services and the video statistics screens to show activity.

After the SmartClass Triple Play Services is setup, it can analyze video performance. Up to three streams can be simultaneously analyzed in Terminate mode. In monitor mode, up to 3 simultaneous streams can be analyzed at one time, with statistics available for up to 10 previous streams. To view statistics on another stream, use the up or down arrow keys.

Terminate mode

In the terminate mode, you can emulate a set-top-box and request broadcast programs.

To run IP video tests in Terminate mode

- 1 Verify that the network connection is established.
- 2 From the IP Video menu, select **Stream 1 Results** (or your desired stream number).
- 3 Select **Start Stream** to request the program material.
This initiates the IGMP signaling protocol sequence. The state of the IGMP messaging is shown on the screen. Typically, the status will change from `Idle` to `Media Wait` to `Stream Up`.
- 4 To view additional results, do one of the following:
 - Press the right arrow.
 - Press the **Cancel** key, and then select either **Stream Results** (to view results per stream) or **Video Results** (to view total video results).
- 5 To save a test report, press the utility (i) key and then select **Save Report**, and then specify the report settings such as report name, report format, technician ID, location, and other settings as needed.
- 6 To clear (or reset) the results, use the * key.
This will either **Clear Stream** if you are on a Stream Results menu or **Clear Stats** if you are on the Total Video Results menu.

See [“Video results” on page 134](#) to learn what your results mean.

Monitor mode

In the monitor mode, up to 3 simultaneous streams can be analyzed at one time, with statistics available for up to 10 previous streams.

If monitoring on an Ethernet interface, you may need an Ethernet hub (such as a NETGEAR® EN 104) between the CO and the set-top-box, as shown in [Figure 18](#) below.

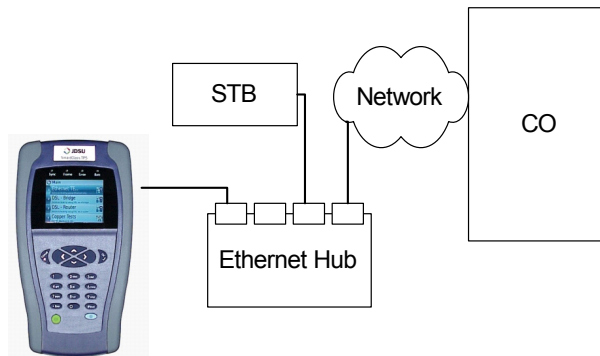

Figure 18 IP video monitoring with a hub

To run IP video tests in Monitor mode

- 1 Verify that the network connection is established.
- 2 From the main Video menu, select a result menu.
 - To view results for a specific stream, select **Stream 3 Results** (or the desired stream number).
 - To view total results for all streams, select **Video Results**.
- 3 Use the left or right arrow key to scroll through the screens.
- 4 To save a test report, press the utility (i) key and then select **Save Report**, and then specify the report settings such as report name, report format, technician ID, location, and other settings as needed.
- 5 To clear (or reset) the results, use the * key.
This will either **Clear Stream** if you are on a Stream Results menu or **Clear Stats** if you are on the Total Video Results menu.

See [“Video results” on page 134](#) to learn what your results mean.

VideoCheck test

The VideoCheck test is an automated test used to verify the channels are provisioned as the subscriber requested. See [“Running the VideoCheck test” on page 34](#).

Web browser

This chapter describes the optional web browser. Topics discussed in this chapter include the following:

- [“About the web browser” on page 104](#)
- [“Browsing the web” on page 104](#)
- [“Navigating the browser” on page 104](#)
- [“Exiting the browser” on page 106](#)

About the web browser

With the web browser feature, you can provide visual proof to customers that a circuit is correctly provisioned all the way to the Internet. The browser works over both DSL and Ethernet interfaces, allowing you to verify connectivity from the customer's NID or demarcation point using only the SmartClass Triple Play Services.

Because the browser's primary purpose is to demonstrate connectivity, it does not have all the capabilities of typical web browsers, such as Internet Explorer or Netscape Navigator (for example, viewing online video, or viewing secure http "https" sites).



NOTE:

The web browser is only available in IPv4 modes (not available in IPv6).

The following sections in this chapter describe how to access and use the web browser.

Browsing the web

Like IP ping, you must have an established underlying network connection, such as Ethernet TE mode with PPPoE data mode, before you can use the browser. After you have a successful network connection, the Frame LED turns green. If the Frame LED is off, the underlying connection is not ready, and the web browser (and IP ping) will not work.

To browse the web

- 1 Select an interface (Ethernet TE, Wi-Fi, DSL-Bridge, or DSL-Modem/Router), and then select Web Browser.
The Web Browser Setup menu appears.
- 2 Specify the web site address (URL) where you wish to go.
- 3 Select Go.

You are browsing the web.

Navigating the browser

Use the SmartClass TPS keypad to navigate the web browser. The following sections describe how to use keypad to navigate the web browser.

Scrolling the view

Because of the size of the screen, the SmartClass TPS initially displays only the top left section of a full page. To view other areas of a web page, use the arrow keys to scroll the page view.

Selecting links



The following procedure describes how to select a link on a web page.

To select a link

- 1 Navigate the cursor to the link using the arrow keys.
A dotted line box highlights the link.
- 2 Press the **OK** key.
The screen changes as appropriate.

Moving among or refreshing pages

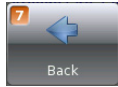
As with a typical browser, you can move among viewed web pages with the NEXT and PREVIOUS page buttons. In addition, you can refresh a page. To move among or refresh pages, press the utility (i) key and then select one of the following.

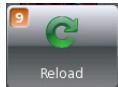
Icon	Function
	Previous page to go back to the previous page
	Next page to go forward a page
	Refresh to reload the current page



NOTE:

These icons are only available when running the Browser.

Typing text in a field

If you wish to enter text in a field on a web page (such as a search bar), the following procedure describes how to type text.

To type text in a field

- 1 Use the asterisk (*) or pound/hash (#) keys to go to the field.
- 2 Press the OK key.
This enables text entry mode.
- 3 Use the keypad to enter characters.
 - Text entry is done the same way as on a cell phone, where repeated presses move among characters. For example, repeated presses of the 3 key will move among d, e, f, or 3.
 - To enter special characters, use the asterisk (*) or pound/hash (#) keys. The same characters are available with each key, but they scroll in opposite directions.
 - When in text entry mode, the arrow keys do the following:
 - the down arrow deletes one character to the left (backspace)

- the up arrow changes the text entry type: lower case (abc), upper case (ABC), or numeric (123)
- the left and right arrows allow you to move among typed characters

Selecting items in a drop-down list

If you are in a field that uses a drop-down list, the following procedure describes how to select drop-down items.

To select items on a drop-down list

- 1 Use the asterisk (*) or pound/hash (#) keys to go to the field.
 - 2 Press the OK key to select the field.
If this is a field that also allows text entry (such as a search bar, enter a few characters. See [“Typing text in a field” on page 105](#).
 - 3 Press the Cancel key to allow movement up and down the list.
 - 4 Use the up and down arrows to navigate to the desired item, and then press the OK key.
- The item is selected and the screen changes as appropriate.

Exiting the browser

When you are finished demonstrating internet access to the user, you should exit the browser.

To exit the browser

- 1 Press the Cancel key.
You will get a verification pop-up, asking if you are sure you want to exit.
- 2 Press the OK key.

Optical Tools

This chapter describes the optical accessories and how to use them with the SmartClass Triple Play Services. Topics discussed in this chapter include the following:

- [“About the optical tools” on page 108](#)
- [“Measuring optical power” on page 108](#)

About the optical tools

The Optical Power Meter is a JDSU accessory used to measure optical power.

- The MP-60 meter measures 850, 1300, 1310, 1490, and 1550 nm wavelengths
- The MP-80 meter measures 980, 1310, 1480, and 1550 nm wavelengths

The features of the Optical Power Meter include:

- Takes power measurements for all single-mode and multi-mode connectors via USB 2.0 connection.
- Measures optical power with multiple pre-calibrated wavelengths.
- Integrates digital power measurements, fiber inspection, and analysis into a single, unified work sequence.

Measuring optical power

To measure optical power, a Power Meter must be inserted into the USB port.

To measure optical power

- 1 From the Main menu, select **Optical Power**.
The Optical Power Setup menu appears.
- 2 Specify the settings.

Table 17 Optical Power Meter Settings

Setting	Description
Wavelength	To measure a specific wavelength, select the wavelength. Use Auto to automatically detect the wavelength. NOTE: Auto-Detect requires a JDSU optical source.
Units	Specifies the absolute measurement unit: mW or dBm.
LED Threshold	Specify the LED threshold (in dBm). This specifies the threshold for the power LED on the Optical Power Meter. Solid indicates the power is below the threshold (low power), flashing indicates the power is above the threshold.
Pass/Fail Thresh.	Specify the pass/fail threshold (in dBm) for the test. If the measured power is below the threshold, it fails.
Pass/Fail Enable	Specify whether to run the pass/fail test.
Meter FW Rev	Reports the firmware rev of the attached power meter.

- 3 Connect the Optical Power Meter to the USB connector on the right side of the instrument.
- 4 Connect the optical patch cord to the power meter.

5 Select Optical Power Test Menu.

This menu item appears only when an Optical Power Meter is plugged into the USB connector; otherwise, "Insert USB Power Meter" appears.

The power meter test results appear. The measurement begins as soon as the test is launched.

6 To change the measurement mode to relative mode, press the # key.

This sets the current absolute power level as the new reference value.

7 To save a test report, press the utility (i) key and then select **Save Report or **Save To Job**, and then specify the report settings such as report name, report format, technician ID, location, and other settings as needed.**

For descriptions of the results, see ["Optical power results" on page 135](#).

Copper Testing

This chapter provides task-based instructions for using the optional copper testing features. Topics discussed in this chapter include the following:

- [“About copper testing” on page 112](#)
- [“Cord compensation” on page 112](#)
- [“Specifying Copper settings” on page 113](#)
- [“Running a CableCheck” on page 114](#)
- [“Performing a snapshot test” on page 114](#)
- [“Running copper measurements” on page 115](#)
- [“Placing and receiving POTS calls” on page 117](#)
- [“Calibrating the unit” on page 117](#)

About copper testing

The SmartClass Triple Play Services's optional copper features allow quick turn-up and basic troubleshooting of the copper local loop.

The copper features include two quick tests:

- CableCheck
- Snapshot test

You can also perform specific measurements for the following tests:

- AC volts
- DC volts
- Resistance
- Leakage
- Distance to short
- Opens (distance) and capacitance
- DC current
- Balance
- Load coil detect
- POTS calls

Each of these tests is described in the following sections.

Cord compensation

For greatest accuracy, JDSU recommends that you perform a cord compensation to remove the effects of the test leads from the test measurements. There are two scenarios for compensation: all leads open and all leads shorted (resistance).

To compensate for the cords

- 1 From the main menu, select **Copper**.
- 2 Select **Calibration**.
- 3 Select which cable compensation you wish to perform: Opens (capacitance) or Short (resistance).
- 4 Follow the instructions on the screen to connect the black, red, and green leads to perform test lead compensation.
- 5 Press the **OK** key to begin the compensation.

The compensation stops automatically when finished.

Specifying Copper settings

Before running the copper tests, you need to specify copper settings. The following procedure describes how to specify the Copper settings.

To specify Copper settings

1 Select **Copper** from the Main Menu.

2 Select **Setup**.

The Setup menu appears.

Some of the setup values change, depending on the country settings specified on the International Settings menu.

3 Specify the settings.

Configuring the settings can be done one of two ways:

- Press a number on the key pad that corresponds to the setting you want to configure.
- Use the arrow keys to highlight the setting you want to change, and then press the **OK** key. Press the **Cancel** key to exit a menu.

The following table describes the settings.

Setting	Description
Default Pair	Specify which two leads will be tested.-
Cable Type	Specify which type of cable will be tested.
Custom Cable Mutual (if Custom cable type)	Specify the mutual conversion factor in $\mu\text{F}/\text{mile}$ (or per km). This is used for Tip-to-Ring (or A-B) capacitance.
Custom Cable Ground (if Custom cable type)	Specify the ground capacitance between Tip (A) to Ground (E), and Ring (B) to Ground (E), in $\mu\text{F}/\text{mile}$ (or per km). This is used for Tip (A) or Ring (B) to Ground (E) capacitance.
Cable Gauge	Specify the gauge of the cable to be tested.
Temperature	Specify the temperature of the cable to be tested.
Units	Specify which unit of measure to use: Metric or US.
Termination	Specify the volt meter measurement impedance.
Limits	<p>Specify pass/fail thresholds.</p> <ul style="list-style-type: none"> – Specify the Low and High values for AC Voltage. If the AC result is below the low value, it passes. If the result is above the high value, it fails. Values between the high and low are marginal. – Specify the Low and High values for DC Voltage. If the DC result is below the low value, it passes. If the result is above the high value, it fails. Values between the high and low are marginal. – Specify the Low and High values for Resistance. If the Resistance result is below the low value, it fails. If the result is above the high value, it passes. Values between the high and low are marginal. – Specify the threshold value (length) for Opens. If the Opens result is above the value, it passes. – Specify the dB limit for Balance and percentage limit for Capacitive Balance. If the Balance result is below the low value, it fails. If the Capacitive Balance is above the high value, it fails. – Specify the percentage (delta from the Balance measurement) for Good Ground Check. If the Good Ground result is below the value, it fails.

Running a CableCheck

The CableCheck is an JDSU out-of-service pair quality test. It automatically performs a series of tests and compares results to user-defined threshold values and provides a pass/fail indication.

To run a CableCheck

1 Connect the Tip (A), Ring (B), and Ground (E) leads to the line under test.

2 From the main menu, select **Copper**.

3 Select **CableCheck**.

The test begins to run the series of tests.

- DVOM (AC/DC volts, resistance, Leakage)
- Opens/Capacitance
- Balance
- Load Coil Detect
- Good Ground Test

As each test runs, the test summary is updated. The summary provides a simple pass/fail indication.



NOTE:

You can specify the pass/fail threshold values on the Copper> Setup menu.

4 To view more detail, use the arrow keys to scroll through the result values.

To learn what your results mean, see [“Copper results” on page 135](#).

5 To save a test report, press the utility (i) key and then select **Save Report** or **Save To Job**, and then specify the report settings such as report name, report format, technician ID, location, and other settings as needed.

Performing a CableCheck is complete.

Performing a snapshot test

The snapshot feature performs a quick test of AC volts, DC volts, and resistance across all pairs (T-R/T-G/R-G).

To perform a snapshot test

1 Connect the Tip (A), Ring (B), and Ground (E) leads to the line under test.

2 From the main menu, select **Copper**.

3 Select **Snapshot**.

The test begins to run.

The test stops automatically when complete.

4 To save a test report, press the utility (i) key and then select **Save Report**, and then specify the report settings such as report name, report format, technician ID, location, and other settings as needed.

To learn what your results mean, see [“Copper results” on page 135](#).

Running copper measurements

Using the Measure menu, you can individually perform all of the copper measurements. If you want to skip a measurement, use the down arrow to move to the next test. Use the up and down arrow keys to change the pair. After a one second pause, the test begins automatically. To clear the results and restart the test, press the asterisk (*) key.

To run copper measurements

- 1 Connect the Tip (A), Ring (B), and Ground (E) leads to the line under test.
- 2 From the main menu, select **Copper**.
- 3 Select **Measure**.



NOTE:

This procedure describes how to run all of the measurements in one test sequence. If desired, you may run a single copper test, such as measuring DC Current only. To do this, from the Measure menu, select the test you wish to run and then view the results.

- 4 Select **AC Volts**.

The AC voltage test can detect the presence of hazardous voltages, measure induced AC current from power lines and other AC sources, and measure ringer voltage levels.

After a one second pause, the test begins automatically and results appear on the screen.

- 5 Press the right arrow to move to **DC Volts**.

The DC voltage test can detect and measure CO/exchange battery current and detect crossed battery conditions.

After a one second pause, the test begins automatically and results appear on the screen.

- 6 Press the right arrow to move to **Resistance**.

Resistance should be measured with the battery disconnected, so that the resistance of the battery itself doesn't affect the measurements.

After a one second pause, the test begins automatically and results appear on the screen.



NOTE:

The unit will check for damaging voltages before performing the resistance test. If detected, the unit will display “WARNING! VOLTAGE DETECTED” and will not perform the test.

- 7 If resistance is 4 k Ω or less, use the pound/hash (#) key to measure the **Distance to Short**.



NOTE:

For the resistive distance to be accurate, it is critical that you enter the correct gauge and temperature (in the COPPER SETUP menu).

After a one second pause, the test begins automatically and results appear on the screen.

- 8 Press the right arrow to move to **Leakage**.

After a one second pause, the test begins automatically and results appear on the screen.

- 9 Press the right arrow to move to **Opens**.

This test measures the total electrical (capacitive) length of a pair.

After a one second pause, the test begins automatically and results appear on the screen.



NOTE:

When measuring from Tip (A) or Ring (B) to Ground (E), you should connect the Ground (E) lead to the shield (ground), and be sure to enter the fill type (in the COPPER SETUP menu) or the distance will not be accurate. If you connect to some other ground that is not parallel to your pair, and do not enter the appropriate fill type, this measurement will be inaccurate.

10 Press the right arrow to move to **DC Current**.

This test checks for continuity and checks for proper loop current for POTS lines (to verify if enough current is present to operate equipment including the phone or caller ID boxes).

After a one second pause, the test begins automatically and results appear on the screen.

11 Press the right arrow to move to **Balance**.

Balance is a number representing the quality of the telephone circuit and the degree to which the Tip (A) and Ring (B) conductors are electrically the same in their ability to cancel noise.

The balance measurement is used to identify poor loop quality or cable bonding and grounding issues that allow excessive loop noise.



NOTE:

A ground connection is required to measure balance.

After a one second pause, the test begins automatically and results appear on the screen.

12 Press the right arrow to move to **Load Coil**.

The SmartClass Triple Play Services can detect up to five load coils that may exist on the line, out to 27,000 (8,200 meters) feet. It will also report a short, open, or a high noise condition, if detected. For accurate load coil detection, disconnect the pair from the CO/exchange to remove CO battery/wetting current. Although the detector will work with voltage on a pair, accuracy will be reduced. In addition, the detector works best when the last coil is followed by at least 1200 feet (336 meters) of cable.

After a one second pause, the test begins automatically and results appear on the screen.

13 To save a test report, press the utility (i) key and then select **Save Report**, and then specify the report settings such as report name, report format, technician ID, location, and other settings as needed.

To learn what your results mean, see [“Copper results” on page 135](#).

You are finished performing measurements.

Placing and receiving POTS calls

The POTS dialer allows you to place and receive voice calls to verify that the service is working properly.

To test voice service

- 1 Connect to the line using the POTS jack.
- 2 From the main menu, select **Copper**.
- 3 Select **POTS Dialer**.
- 4 Place a call.
 - a Select **Touch-Tone Entry**, and then use the keypad to enter the number to dial.
 - b Press the pound/hash (#) key to go off hook and initiate the call.
 - c *Optional.* Use the keypad to send DTMF tones.
 - d Press the asterisk (*) key to talk, and then speak into the microphone located on the left side of the unit.
 - e Press the pound/hash (#) key to go on hook and end the call.
- 5 Receive a call.
 - a Request someone to call you.
 - b When the SmartClass Triple Play Services indicates an incoming call, press the pound/hash (#) key.
 - c Press the asterisk (*) key to talk, and then speak into the microphone located on the left side of the unit.
 - d Press the pound/hash (#) key to go on hook and end the call.

Testing voice service is complete.

Calibrating the unit

On occasion, your unit may need calibration to maintain accuracy of the copper test functions. For example, if the test environment changes significantly (such as extreme temperature) and you wish to maintain the highest accuracy given the new circumstances, perform the self calibration. This built-in calibration replaces the need for factory calibration.

To calibrate the unit

- 1 From the main menu, select **Copper**.
- 2 Select **Calibration**.
- 3 Select **Self Calibration**.

The SmartClass Triple Play Services performs a self calibration. The self-calibration values are stored in internal memory.

Press Cancel to return to the **Copper Test** menu.

Test Results

This chapter describes the test results that are gathered when running a test. To view the different categories of statistics, use either the left and right arrows, or press the number for the desired result category. Topics in this chapter include the following:

- [“Saving results” on page 120](#)
- [“Network Status” on page 121](#)
- [“LAN Statistics” on page 122](#)
- [“DSL Results” on page 122](#)
- [“IP Data results” on page 128](#)
- [“Wi-Fi results” on page 129](#)
- [“HPNA results” on page 130](#)
- [“SmartID results” on page 131](#)
- [“VoIP results” on page 132](#)
- [“Video results” on page 134](#)
- [“Optical power results” on page 135](#)
- [“Copper results” on page 135](#)

Saving results

After running tests, there are two ways to save results:

to a file - used to save the file as text, HTML, or PDF and then export for viewing or printing using a PC.

to a job - used to associate test results from different applications to a single job

Saving results to a file

After running tests, you can save the results to a report file, and then export for viewing or printing.

To save results to a file

- 1 After your test is finished, press the **Utility** (ⓘ) key, and then press the **5** key.
- 2 Specify the report settings.

Setting	Description
Report Name	Specify a file name for the report. The default file name uses the type of test followed by a three digit number that increments with each file save (for example, cablecheck001 or DSL002).
Report File Format	Specify the file format for the report: Text, HTML, PDF.
Technician ID	Enter the technician ID.

If you select **Show More**, you can enter more detailed information, such as Circuit Name, ID, and location, as well as Telephone and Fax Numbers.

- 3 Do one of the following:
 - a Press * to **Save** the file to internal or USB storage.
 - b Press # to **Save and Send** the file to a FTP server.
The report is saved and then the Report Send menu appears.
Verify the server settings, and then press # to send the report.

The test results are stored.

Use the File Browser to copy the file to USB for viewing or printing using a PC.

Saving results to a job

If you ran a Copper Pair Check, HPNA test, SmartID test, DSL test, OneCheck test, or an Optical Power Meter test, you can save the results to a job.

To save results to a job

- 1 After running a test, press the **Utility** key, and then select **Save to Job**.
If the "Save To Job" selection is not available, verify you ran one of the tests listed above. (For example, Save To Job is not available for Ethernet TE tests, IPVideo tests, and VoIP tests).
The Save Test Result menu appears.
- 2 Select **Save Result** and then select **To Job**.

- 3 Verify the circuit ID and other job information. If there is no active job, a popup appears, asking you to create and activate a job. If the job information is not the desired job, return to the Job Manager screen and activate the desired job.
- 4 If you ran a Copper or DSL test, select **Location**, and then specify where the test was performed (for example, Crossbox, Splitter, or RG).

The SmartClass TPS returns to the last viewed result screen.

Network Status

Table 18 describes the Network Status results.

Table 18 Network Status results

Result	Description
Network Status	Status of the connection. If testing in Router mode, there are separate status indications for WAN and LAN.
LAN x	If using Multi-VLAN, reports the status of up to three LAN connections.
IP Address	The SmartClass Triple Play Services's IP address to the access the provider network. (IPv4)
Global	If using IPv6oE, this is the SmartClass Triple Play Services's IP address to the access the global network, beyond the router.
Local	If using IPv6oE, this is the SmartClass Triple Play Services's IP address to the access the local network.
Subnet prefix	If using IPv6oE, this is the length of the subnet prefix.
Netmask	The SmartClass Triple Play Services's netmask address. IP devices use a netmask IP address to determine if IP packets are to be routed to other networks or sub-networks. (IPv4)
Gateway	The SmartClass Triple Play Services's gateway address. When an IP device has determined that a packet is not addressed to it or devices on the same sub-network (subnet), it sends all such packets to the gateway address for further routing to the correct address.
DNS	Domain Name Services. When using internet addresses such as www.jdsu.com, the SmartClass Triple Play Services (and all IP devices) must translate to an IP address (such as 157.234.12.20) in order to route the packets or data. To do so, it first requests a DNS server to translate an internet address into an IP address; then the SmartClass Triple Play Services can correctly route IP pings or other data. The DNS address must be that of a real DNS server, preferably in the provider network.
MAC Address	The MAC address of the LAN.

LAN Statistics

Table 19 describes the LAN Statistics.

Table 19 LAN Statistics

Result	Definition
Link Status	Status of the connection.
RX Bytes	Total bytes received
RX Frames	Total frames received
RX Errors	Total errors received
RX Dropped	Total dropped frames received
TX Bytes	Total bytes transmitted
TX Frames	Total frames transmitted
TX Errors	Total errors transmitted
TX Dropped	Total dropped frames transmitted
TX Collisions	Ethernet frames are transmitted “space-available” when there is a break on the signal on the cable; sometimes frames are transmitted at the same time as another transmitter, causing a “collision” of frames.

DSL Results

The following section describes the results available in DSL mode. To view the different categories of statistics, use either the left and right arrows, or press the number for the desired result category.

Summary

This category provides a summary of the most frequently used DSL test results. Table 20 describes the DSL Summary results.

Table 20 DSL Summary results

Result	Description	Range
Training State	The state of modem synchronization (appears in the menu heading)	Booting, Idle, Init, Showtime
Trained Mode	The DSL line format agreed upon during training (appears in the menu heading).	T1.413, READSL, ADSL2+, ADSL2, G.Lite, G.DMT, VDSL2
Connection Statistics		
Actual Rate	Current upstream and downstream connection rates	32 kB–3.3 MB ^a (Up) 32 kB–25 MB ^a (Dn) 64 kB–50 MB (Up) ^b 64 kB–100 MB (Dn) ^b

Table 20 DSL Summary results (Continued)

Result	Description	Range
Max Rate	Maximum upstream and downstream connection rates	32 kB–3.3 MB ^a (Up) 32 kB–25 MB ^a (Dn) 64 kB–50 MB (Up) ^b 64 kB–150 MB (Dn) ^b
Capacity	The percentage of total bandwidth currently used by the actual connect rate upstream and downstream.	0–100%
Actual Margin	SNR margin upstream and downstream	0–63.5 dB
ATN	The degradation of signal strength in dB upstream and downstream. It is the difference in Tx power from the transmitter to receiver.	0–126.95 dB (VDLS2) 0–254.9 dB (ADLS2)
Sync Time	The elapsed time (duration) since reaching Showtime.	n/a

a. These are ADSL2 rates.

b. These are VDSL2 rates.

In the saved test report, two additional statistics are included:

- **Start Time** is the time (time of day) when the DSL modem achieves Showtime. The Start time is updated if you clear errors.
- **Stop Time** is the time (time of day) when the report is generated or DSL sync is lost.

Bonded DSL statistics (For Catalogs CSC-TPSVW and CSC-TPSVW-CU only)

For bonded mode, the same results are shown, but the bonded results are separated into different screens:

- Group - results for both pairs combined
- Pair 1 or Pair 2 - Same results as the non-bonded screen, except the title.

Signal

This category provides statistics for the signal. [Table 21](#) describes the DSL Summary results.

Table 21 DSL Signal results

Result	Description
Sync Count	The number of synchronization attempts. It is possible that modems do not synchronize immediately and make multiple attempts before achieving synchronization.
Trained Path	Whether the modems trained with the FAST or INTLV (interleaved) path.
Loop Length	The estimated loop length. ^a
Vectoring Status	V-Configure, V-Full, V-Trigger, V-Running, V-Disabled, Multiple V-Disabled, V-Unconfigd, V-Unknown
Signal	
SATN	Signal attenuation. Attenuation average of the bins/tones that contain the actual signal (empty bins are not included).

Table 21 DSL Signal results (Continued)

Result	Description
LATN	Line attenuation. Attenuation average of <i>all</i> tones/bins (the entire line, including empty bins/tones).
1MHz ATN	Attenuation measured at 1MHz.
Tx Power	Power level, in dB, of the VDSL signal, downstream (from the DSLAM) and upstream (transmitted by the SmartClass Triple Play Services).
INTLV Delay	Interleaving depth set by the DSLAM. This is a measure of latency introduced on the link due to the scrambling of DSL frames to protect data and create a more reliable link.
Actual INP	The INP (Impulse Noise Protection) values negotiated during training.

a. The estimated loop length is a rough estimated based on attenuation. For a more accurate measure of loop length, use the TDR in Copper mode.

SNR Margin

This category provides statistics for the following values in both Up and Down directions.

Table 22 SNR Margin results

Result	Description
Max Margin	The maximum SNR margin upstream and downstream.
Actual Margin	SNR margin upstream and downstream.
Min Margin	The minimum SNR margin upstream and downstream.

DSL Errors

[Table 23](#) describes the DSL Errors.

Table 23 DSL Errors

Result	Description
FEC	Forward Error Correction upstream and downstream for Fast Path and Interleave Path.
CRC	Cyclical redundancy check upstream and downstream for Fast Path and Interleave Path.
ES	Errored Seconds. Number of seconds during which a LOS, SEF, LPR, or CRC occurred since starting the test.
SES	Severely Errored Seconds. Number of seconds during which one or more LOS, SEF, or LPR errors were present, or 18 CRCs occurred.
UAS	Unavailable Seconds. A count of the number of test seconds which met the ITU-T Rec. G.821 definition of unavailable time.

DSL Alarms

[Table 24](#) describes the DSL Alarms.

Table 24 DSL Alarm Seconds results

Result	Description
LOS	Loss of Signal. Number of errored seconds due to loss of signal.
LOF	Loss of Frame. Number of errored seconds due to loss of framing.
LOM	Loss of Margin Errors. Number of errored seconds due to loss of margin.

Band statistics

This category only appears for VDSL lines. It provides loop and signal attenuation (LATN/SATN), SNR margin, and TX power per band.

G.INP statistics

This category provides statistics for DSL retransmission (G.INP). This category is only available in non-bonded mode and the xDSL standard is VDSL. [Table 25](#) describes the G.INP statistics.

Table 25 G.INP statistics

Result	Description
Status	Reports whether G.INP is in use for upstream or downstream.
Retransmitted DTUs	Retransmitted DTUs. The number of retransmitted DTUs that were received.
Corrected DTUs	The number of DTUs the unit received a correction for.
Uncorrected DTUs	Uncorrected DTUs. The number of DTUs that did not get a retransmission (not received within the time limit).
INP Rein	The effective impulse noise protection (INP) as a result of G.INP support.

DSL Identity

[Table 26](#) describes the DSL Identity results.

Table 26 DSL Identity results

Result	Description
ATU-C or VTU-O Vendor	CO vendor code (ATU-C for ADSL, VTU-O for VDSL)
ATU-C or VTU-O Revision	CO revision number (ATU-C for ADSL, VTU-O for VDSL)
xTU-R SW Revision	SW revision of the local modem (ATU-R for ADSL, VTU-R for VDSL)
xTU-R PHY Revision	PHY firmware revision for the local modem (ATU-R for ADSL, VTU-R for VDSL), based on the setup.

Tone Graphs

The graphs provide a graphical representation of the following:

- SNR (signal to noise ratio) Per Tone
- Bits Per Tone (BPT)

Figure 19 provides an example of a Bits Per Tone graph.

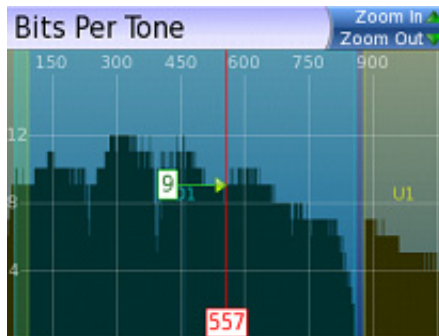

Figure 19 Bits Per Tone graph

- QLN (quiet line noise) Per Tone (Broadcom only)
- Hlog Per Tone (Broadcom only). If a bridged tap is found, press the **Utility** key and then select **Calculate Bridge Tap Length**. The bottom number on the cursor display changes from frequency and tone to frequency and length (for example, “2.10 MHz (486)” changes to “2.10 MHz (77 ft)”).

Navigating the graph

To view the cursor

- Press the **OK** key when viewing the graph.
The cursor appears (the red line in Figure 19).

The number at the bottom indicates the cursor location (tone 557 in Figure 19). The upper number indicates the numeric value (BPT=9 in Figure 19). Use the left and right arrows to scroll among the tones.

To zoom

- Press the up arrow to zoom in or the down arrow to zoom out.

Troubleshooting using the graphs

The SNR graph indicates line quality. The BPT graph indicates the total bit rate and is a useful tool for finding disturbers. Bits per tone is defined as bits assigned per DMT tone.

Examine the portions of the graphs where there are dips or breaks. These dips represent areas where interference is degrading the DSL signal.

Table 27 lists common noise sources and the corresponding frequencies and tones.

Table 27 Noise sources and tones

Noise Source	Noise Frequency (kHz)	Tone #	Tone Frequency (kHz)
ISDN BRI	40	9	38.8125
HDSL passband center	196	45	194.0625
HDSL passband max	392	91	392.4375
HDSL2	274	64	276
T1 passband center	772	179	772
E1 passband center	1024	237	1022

ATM results

ADSL typically transports data over ATM (Asynchronous Transfer Mode) circuits. (VDSL, as well as some ADSL systems transmit over packet mode circuits.) The ATM category provides results that help you troubleshoot these connections. These results are helpful if IP pings are not working, but your tester is still sending and receiving ATM cells.

Cell Count

Table 28 describes the ATM Cell Count results.

Table 28 ATM Cell Count results

Result	Definition
User	Number of cells that contain user data.
OAM	Number of cells that contain OAM data.
Bad	Number of bad cells received.
Dropped	Total number of dropped cells. The ATM network will discard or “drop” erred cells which must then be retransmitted (this is done automatically). The SmartClass Triple Play Services counts the number of ATM cells and how many were dropped, giving an indication of service quality.

Errors

Table 29 describes the ATM Error results.

Table 29 ATM Error results

Result	Definition
HEC	Header error correction. Errored ATM cell headers that have been automatically corrected.
OCD	Out-of Cell Delineation. Occurs when cells fail to contain a valid HEC (Header Error Check)
LCD	A Loss of Cell Delineation. Initially triggered when an OCD condition occurs and doesn't clear for more than 4ms.

IP Data results

The following section describes the results available in IP Data mode. To view the different categories of statistics, use either the left and right arrows, or press the number for the desired result category.

Ping results

[Table 30](#) describes the ping results.

Table 30 IP Ping results

Result	Definition
Destination	Destination address where the ping is being sent.
Message	Status message.
Echos TX	The number of ping messages sent.
Replies RX	The number of echo reply messages returned to the SmartClass from the destination.
Replies Lost	The number of pings that did not return to the SmartClass Triple Play Services. This could be caused by an unresponsive target (destination) or by heavy congestion on the network; the more packets lost the more congested the network, indicating slow or poor throughput.
Replies Lost %	The percentage of lost echos compared to echos sent.
Echos RX	The number of ping messages sent to the Triple Play Services from other devices on the network.
Ping Time	The current, minimum, maximum, and average time in milliseconds it has taken one transmitted ping to reach its destination and receive a reply back to the SmartClass Triple Play Services.

File Transfer results

[Table 31](#) describes the File Transfer results.

Table 31 File Transfer results

Result	Description
Status	The status of the transfer.
Percent Transferred	The percentage of the file that has been transferred.
File Size	Size of the file being transferred.
Bytes Transferred	The number of bytes transferred.
Transfer Rate	The speed that the file was uploaded or downloaded.
Total Transfer Time	The total time it took for the entire transfer, from beginning to end.
Pretransfer Time	The number of seconds of processing elapsed before the transfer began.
Start Transfer Time	The time that the transfer began.
Name Lookup Time	The number of seconds it took to lookup the name.
Connection Time	The time that the transfer began.

Table 31 File Transfer results (Continued)

Result	Description
Redirect count	The number of times the client was redirected.
HTTP Code	HTTP status code message
Header Size	Number of bytes in the header
Request Size	Number of bytes in the request message

Traceroute results

Table 32 describes the trace route results.

Table 32 Trace route results

Result	Definition
State	Current state of the trace
Number of hops	The number of points crossed from the source to the destination

Wi-Fi results

The following section describes the results available in Wi-Fi mode.

Status

Table 37 describes the status results. The status may be included on the Access Point Status menu or the End Point Status menu.

Table 33 Status

Result	Definition
Status	Indicates the link status. Scanning – Scanning for the SSID configured in setup Associating – associating to a BSS Associated – Associated to a BSS. However, the link is not fully up yet. WPA Handshake – Completing the WPA handshake to set up encryption Link up – Link is fully up.
SSID	The Wi-Fi network ID that you are connected to.
BSSID	The access point MAC address.
Signal Strength	The strength of the signal, in dBm.
Protocol	The Wi-Fi protocol in use (such as IEEE 802.11bg).
Channel	The 802.11b/g channel the particular BSS is operating in.
Encryption Type	The type of encryption (WPA/WEP)
Maximum BW	The maximum bandwidth available on the network.
Network Status	Status of the data network.

Table 33 Status (Continued)

Result	Definition
Connection duration	The amount of time the instrument has been connected to the Wi-Fi network.
IP address	The IP address assigned to the instrument by the network.
Netmask	The instrument's netmask address. IP devices use a netmask IP address to determine if IP packets are to be routed to other networks or sub-networks
Gateway	The instrument's gateway address. When an IP device has determined that a packet is not addressed to it or devices on the same sub-network (subnet), it sends all such packets to the gateway address for further routing to the correct address.
DNS	Domain Name Services. When using internet addresses such as www.jdsu.com, the SmartClass Triple Play Services (and all IP devices) must translate to an IP address (such as 157.234.12.20) in order to route the packets or data. To do so, it first requests a DNS server to translate an internet address into an IP address; then the SmartClass Triple Play Services can correctly route IP pings or other data. The DNS address must be that of a real DNS server, preferably in the provider network.
MAC Address	The MAC address of the LAN.
Connected Devices	The number of devices connected to the Wi-Fi network.

Results

[Table 37](#) describes the End Point result

Table 34 End Point results

Result	Definition
Status	Indication of the status of the Wi-Fi link
Rx & Tx Results	
Bytes	Total bytes received or transmitted.
Frames	Total frames received or transmitted.
Errors	Number of errors received or transmitted.
Dropped	Number of dropped bytes received or transmitted.
Collisions	Number of transmit collisions

HPNA results

The following section describes the results available in HPNA mode.

[Table 35](#) describes the HPNA results.

Table 35 HPNA results

Results	Description	Units	Range/Values
Station ID -> ID	This is a directional indication of each link denoted by each node ID		

Table 35 HPNA results (Continued)

Results	Description	Units	Range/Values
Rate, Mod Mbps	This is the current data rate, and baud/constellation of the specific link.	Mbps, MBaud/bits per symbol	0-112, 2-24/2-10
PER	The Packet Error Rate on the specific link.	Rate x.xx+yy	0.00e0 - 1.00e0
SNR	This is the Signal to Noise Ratio of the specific link.	dB	
Receive and Transmit Results			
bytes	The number of total (good and bad) transmitted or received bytes	Bytes	
packets	The number of total (good and bad) transmitted or received packets.	Packets	
bcast	The number of transmitted or received broadcast packets.	Packets	
mcast	The number of transmitted or received multicast packets.	Packets	
dropped	The number of transmitted or received packets dropped due to lack of resources.	Packets	
crc	The number of received packets that have had an invalid checksum. (NOTE: There is no count for transmitted packets)	Packets	
Protocol Messages			
ctrl_log_req	The number of control requests from the local host (CERT protocol.)		
ctrl_log_rec	The number of control replies to the local host (CERT protocol.)		
ctrl_rem_req	The number of control requests from a remote host (CERT protocol.)		
ctrl_rem_rec	The number of control replies to a remote host (CERT protocol.)		

SmartID results

The following section paragraphs describes the results available in SmartID tests.

Test Summary

This category provides an overview of the results, including basic pass/fail indications of the links between the SmartIDs. Use the arrow keys to navigate and highlight a section. The details for that section appear. If you navigate to a section/link that failed, the results on the left update and you can see which measurement failed.

Detailed View

This category shows detail of the selected section/link of the network between two SmartIDs. Use the # key to reverse the direction (change the focus from the near end of the cable to the far end).

Network Map

This category shows the layout of the network. The SmartID connected to the <product name> is on the left and the home network cascades to the right. Use the up and down arrow keys to select different SmartIDs on the map. Press OK to see details of a particular segment.

Sweep Data

This category shows a graph of the frequency sweep. Use the # key to reverse the direction.

VoIP results

The following section describes the results available in VoIP mode. To view the different categories of statistics, use either the left and right arrows, or press the number for the desired result category.

Call Information results

[Table 37](#) describes the Call Information results.

Table 36 Call Info results

Result	Definition
Call Duration	Length of time for the current call. If the call duration continues beyond 59:59 (meaning, is more than an hour), the display changes from mm:ss to hh::mm (note the change from : to ::).
Far End Information	The IP address, ID Name, Alias, and Connect method for the incoming call.
Audio Parameters	The receive and transmit codec being used, whether RTCP is being used for the Audio or Video path, and whether silence suppression is enabled.

Throughput

[Table 37](#) describes the Throughput results.

Table 37 Throughput results

Result	Definition
Local Audio Bytes	Total number of bytes transmitted (TX) or received (RX)
Local Audio Packets	Total number of packets transmitted (TX), received (RX), lost, or out of sequence (OOS).

Audio Delay

[Table 37](#) describes the Audio Delay results.

Table 38 Audio Delay results

Result	Definition
Incoming Audio Codec	The audio codec used for the incoming call

Table 38 Audio Delay results (Continued)

Result	Definition
Network Delay	Time, in milliseconds, needed to travel the network (only displayed when a call is active)
Encoding Delay	Time, in milliseconds, needed to convert samples in selected codec form
Packetization Delay	Number of milliseconds needed to fill the frame(s) comprising one RTP data packet
Buffering Delay	Time, in milliseconds, that the data was held in a jitter buffer
Total Delay	Total of all delays

Audio Quality Scores

[Table 39](#) describes the VoIP Audio Quality Score results. These results relate to one call.

Table 39 Audio Quality Score results

Result	Definition
Best Possible CQ MOS	The best conversation quality (CQ) mean opinion score (MOS) possible
CQ MOS	Current conversation quality mean opinion score
LQ MOS	Current listener quality mean opinion score
PQ MOS	Current packet quality mean opinion score
Best Possible CQ R Factor	The best conversation quality R factor possible
CQ R Factor	Current conversation quality R factor
LQ R Factor	Current listener quality R factor
G.107 R Factor	Current G.107 R factor
Burst R	Current burst R factor
Gap R	Current gap R factor

To view audio quality scores for multiple calls, select **Multi-Call Quality Stats**. The same results will be reported as above with the minimum, maximum, and average results for the calls. The two “Best Possible” results aren’t included because they don’t apply to multi-call results.

Local and Remote QoS

This category provides quality of service (QoS) test results. The Local QoS reports what we receive (in the test set), while the Remote QoS reports what they receive (at the far end). [Table 20](#) describes the QoS results.

Table 40 QoS results

Result	Definition
Delay	End to end delay in milliseconds
Jitter	Deviation in packet arrival times, in milliseconds)
Loss	Packet loss based as a percentage lost divided by total packets



NOTE:

The Delay result is only calculated if the RTCP signaling is active.

Video results

The following section describes the results available in IP Video mode. To view the different categories of statistics, use either the left and right arrows, or press the number for the desired result category.

Stream Results

This category provides statistics for each test stream. [Table 42](#) describes the Video Stream Results.

Table 41 Stream results

Result	Description
State	Status of the stream – Stream Up - Active – Idle - No active stream – Failed - A stream is no longer detected. All streams brought up using RTSP protocol will eventually reach the Failed state. This is because the SmartClass Triple Play Services does not detect RTSP termination messages or RTSP messages used for special features such as pause.
Media Type	The type of media detected: – udp (for MPEG-2 TS Video over UDP) – rtp (MPEG-2 TS Video over RTP)
Media IP	The IP address of the stream.
Media Port	The RTSP port of the stream.
NOTE: The State, Type, IP address, and Port results refer to the media stream, not the signaling protocol (IGMP or RTSP) that brought up the stream.	
Packet Loss Stats	Current, Maximum, and Total Packet Gap Errors, as well as the Maximum Packet Gap in ms.
Packet Jitter Stats	Current and Maximum results for PCR Jitter and IP Jitter.

Table 41 Stream results (Continued)

Result	Description
Delay Stats	The current latency and the maximum latency since the stream became active. (Latency is the time to complete a program change, in milliseconds.)
Rate Stats	Reports individual bit rates for each portion of the video stream. The "IP Total" statistics measure the bandwidth used by the video stream, including the UDP and IP headers.

Video Results

This category reports the total number of active video streams and provides the combined total data rate associated with the ATM Video Virtual Channel selected when configuring the ADSL interface or the Ethernet port used in the Ethernet mode. The screen provides a quick summary of the total data rates for all of the video program flows present on the interface under test.

The total video bandwidth (data rate) peaks can be important in analyzing total bandwidth available. The total bandwidth is found on the ADSL Summary screen. The difference in the two numbers is the bandwidth available for either Internet data or Internet data and VoIP data.

[Table 42](#) describes the video results.

Table 42 Total video rates results

Result	Description
Active Streams	Number of active streams
Current Combined Rate	The combined rate at this moment.
Maximum Combined Rate	The maximum combined rate seen since the start of the test.
Average Combined Rate	The average of all combined rates.

Optical power results

The optical power is displayed as dBm or mW (depending on your selection on the Setup menu) along with the **Min**, **Max**, and **Average**. The wavelength is displayed just under the power measurement.

If using relative measurement mode, the received signal is compared to the reference value, and displays the *difference* in dB. **NOTE:** If no reference value has been stored, 0.00 dBm will be used as reference value.

Copper results

The copper results are described in the tables below.

AC voltage

You measure AC volts to:

- detect the presence of hazardous voltage.
- measure stray or foreign voltages.
- measure ringer voltage level.

AC voltage results on Tip (A) to Ring (B) should be 0.0 volts. Tip (A) to ground and Ring (B) to ground should be equal to each other. Anything else indicates AC signal interference and/or an unbalanced line.

Table 43 describes the AC voltage result.

Table 43 AC Voltage result specifications

Range (VAC)	Resolution (V)	Accuracy
AC peak + [VDC] ≤ 300	1	2% ± 1.0V



WARNING: INSTRUMENT DAMAGE

Although the SmartClass Triple Play Services is designed to measure hazardous voltage, it is designed to do so on telecom circuits, not power mains. Hazardous voltages may be on the power lines. 220 mains (RMS) are equivalent to 308 peak. Connecting to these circuits may result in damage to equipment or serious injury.

DC voltage

You measure DC volts to:

- detect and measure CO/exchange battery voltage.
- detect crossed battery conditions.

To measure DC volts, remove the line battery and measure Tip (A) and Ring (B) to ground. It should be < 3.0 volts; anything else indicates crossed battery that inhibits digital signals.

Table 44 describes the DC voltage result.

Table 44 DC voltage result specifications

Range (VDC)	Resolution (V)	Accuracy
AC peak + [VDC] ≤ 300	1	2% ± 1.0V

Resistance

You measure resistance to test line continuity and quality, and to detect corrosion, shorts, opens, and faults.

The SmartClass Triple Play Services is able to measure resistance in the presence of noise and foreign voltage, but the accuracy may be reduced, depending on the noise level.

Resistance should be measured with the line disconnected, so that the battery voltage and CO/Exchange termination don't affect the measurement.

Normal resistance should be at least 5 MΩ; lower values indicate the presence of faults.

Table 45 describes the resistance result.

Table 45 Resistance result specifications (no ambient)

Range (Ω)	Resolution (Ω)	Accuracy
0 to 999	1	2% \pm 2.5 Ω
1.0K to 9.99K	10	2%
10.0K to 99.9K	100	2%
100.0K to 999K	1K	2%
1.0M to 9.9M	10K	6.5%
10.0M to 100M	100K	10%

Distance to short

This result measure the distance to the short. A resistance measurement of 4 k Ω or less typically indicates a short. For values greater than 4 k Ω , this function is disabled.

Table 46 describes the distance to short result.

Table 46 Distance to short result specifications

Range (feet)	Resolution	Range (meters)	Resolution
0 to 3000	30 feet	0 to 999	9 meters
3000 to 30,000	100 feet	1000 to 10,000	30.5 meters

Leakage

Leakage is a resistance measurement using higher voltage.

Table 47 describes the leakage result.

Table 47 Leakage result specifications (no ambient)

Range (Ω)	Resolution (Ω)	Accuracy
0 to 49.99	1	2% \pm 2.5 Ω
50 to 999	1	5% \pm 2.5 Ω
1.0K to 9.99K	10	5%
10.0K to 99.9K	100	5%
100.0K to 999K	1K	5%
1.0M to 9.9M	10K	10%
10.0M to 100M	100K	15%

Opens/Capacitance

You measure opens/capacitance to:

- measure total electrical loop length (includes length of bridged taps).

- find wet sections, bridged taps or open faults.

Opens/Capacitance: < 3% difference between Tip (A) and Ring (B) values indicate an acceptably balanced loop. Anything greater indicates an unbalanced line or open fault, which inhibit digital signals.

Table 48 describes the opens/capacitance result.

Table 48 Opens/Capacitance result specifications (no ambient)

Range (feet)	Resolution (feet)	Range (meters)	Resolution (meters)	Range (capacitance)	Accuracy (applies to capacitance only)
0 to 2,999	1 foot	0 to 999	0.1 meter	0 to 44.9 nF	3% ± 45 pF
3000 to 66000	1 foot	1,000 to 20,000	0.1 meter	45 nF to 1.04 µF	3%

DC current

You measure DC current to verify if enough current is present to operate equipment including the phone or caller ID boxes.

DC current on Tip (A) to Ring (B) should be ≥ 23 mA at the NID. Anything less will not allow for differences in temperature and phone equipment will not operate during extremes.

Table 49 describes the DC current result.

Table 49 DC current result specifications

Range	Resolution	Accuracy
0 to 110 ma	1ma	2% ± 1ma

Longitudinal balance

You measure longitudinal balance to:

- measure the quality of the pair: a measurement of the degree to which the Tip (A) lead is electrically the same as the Ring (B) lead.

The more each lead is electrically identical (capacitance, inductance, impedance), the better the pair will resist induced noise.

The balance result should be >60 dB. Anything less indicates electrical differences between Tip (A) and Ring (B) that can lead to noise and other signal problems.

[Table 50](#) describes the DC current result.

Table 50 Balance result specifications

Range	Resolution	Accuracy
35 to 70 dB	1 dB	2 dB

Good Ground check

The good ground check is a ground resistance measurement. It tests whether the ground used for longitudinal balance is acceptable. The result should be <35dB.

Load coil

You check for load coils to ensure there are no load coils present on a digital line (such as ADSL or ISDN). Load coil detection and elimination is essential in the installation of an xDSL circuit

[Table 49](#) describes the load coil result.

Table 51 Load coil result specifications

Range	Resolution	Accuracy
Up to 27,000 ft (8229.6 m)	up to 5	± 1

StrataSync

This chapter provides task-based instructions for synchronizing the SmartClass TPS with a central StrataSync server. Topics discussed in this chapter include the following:

- [“About StrataSync” on page 142](#)
- [“Synchronizing to the StrataSync server” on page 142](#)

About StrataSync

StrataSync® is a hosted, cloud-based software application that provides JDSU instrument asset, configuration, and test-data management. StrataSync manages inventory, test results, and performance data anywhere with browser-based ease and improves technician and instrument efficiency.

Features include the following:

- Uploading test results to StrataSync server
- Uploading configuration settings to StrataSync server
- Pushing certain configuration settings to multiple SmartClass TPS units
- Adding and/or removing software options on multiple SmartClass TPS units
- Updating the software on the SmartClass TPS
- Tracking ownership of the SmartClass TPS

To access the StrataSync menu

- 1 From the Main menu, select **System Setup**.
- 2 Select **StrataSync**.

The StrataSync menu appears.

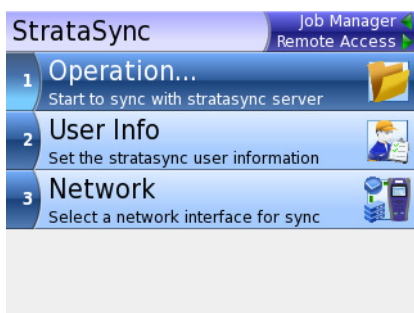

Synchronizing to the StrataSync server

To obtain the latest configuration settings, software options and updates, and ownership registration information, the SmartClass TPS can synchronize with a JDSU server via the internet. The synchronization also stores any user files saved on the unit to the StrataSync server. This procedure should be undertaken immediately upon receipt of the unit and on a regular (daily) basis thereafter to ensure that the unit is as up-to-date as possible and to allow all user information to be backed up. Before attempting to synchronize with StrataSync, please confirm your server settings with your manager or your company's IT organization.

To sync with StrataSync

- 1 If you haven't already done so, specify the user information on the User Info menu - from the StrataSync main menu, select **User Info**. A valid account ID must be entered in order to synchronize with the StrataSync server.
- 2 If the network connection has already been set up, the Network entry on the StrataSync menu will be greyed-out.

If not, from the StrataSync main menu, select **Network** and then Select **Connect With** and specify the access technology through which the SmartClass TPS will be connected to the network.

- Ethernet
- DSL
- Wi-Fi

- 3 Depending on the access technology specified in the step above, specify the interface to use for the connection:

For Ethernet, select **Network Setup** to do the configuration. Refer to [“Specifying the network setup” on page 42](#) for the definitions of the parameters.

For DSL, select **DSL Setup** to do the DSL configuration. Refer to [“Specifying DSL settings” on page 52](#) for the definitions of the parameters. Next, select DSL Network Setup to do the network configuration. Refer to [“Specifying the modem operation” on page 50](#), [“Specifying network settings” on page 54](#), and [“Specifying WAN settings” on page 54](#) for the definitions of the parameters.

For Wi-Fi, select **Wi-Fi Network Setup** to do the configuration. SSID is the public name of the wireless network. Refer to [“Specifying the network setup” on page 42](#) for the definitions of the rest parameters.

- 4 From the StrataSync main menu, select **Operation** and then specify additional connection and server settings.

Setting	Description
Connection Type	Specify how to connect to the server. <ul style="list-style-type: none"> – Lookup – Use an intermediate server that will automatically identify (“lookup”) the specific StrataSync server to be addressed. The lookup server connection type is typically used when there are multiple StrataSync servers in the user’s corporate footprint.) – Direct – Use a direct reference to a specific StrataSync server) <p>NOTE: The SmartClass TPS uses HTTPS (secure HTTP) to connect to the server.</p>
Server Method	Specify how to refer to the server (this applies for both connection types) <ul style="list-style-type: none"> – Address Server by IP (192.168.0.1) – Address Server by Name (myServer)
Server IP/Lookup Server IP, or Server Name/Lookup Server Name	Enter the server IP/lookup server IP or the server name/lookup server name on demand.
Server Port/Lookup Server Port	Enter the server port number.
Proxy URL	Enter the proxy URL. You can leave it blank - as by default and not using any proxy.

- 5 On the StrataSync screen, press the **Sync** soft key to start the synchronisation.

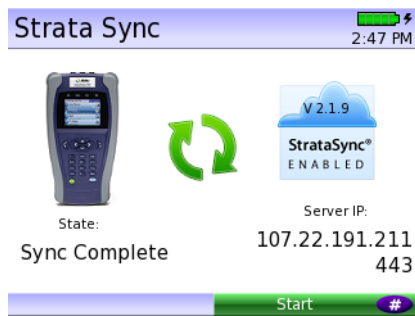

As the process runs, the sync state is displayed in the lower left.

The server name or IP and port are shown in the lower right.

The StrataSync software version is displayed on the cloud icon.

You can press the **Stop** soft key to stop the synchronisation.

- 6 Upon synchronization with the StrataSync server, the unit will send to the server the following information:
- The unit's serial number.
 - The unit's hardware information - constituent assemblies and their revision levels.
 - The unit's MAC address.
 - The unit's User settings - name (user/technician) and ID.
- If the configuration information contained on the server is newer than that on the unit, the server will be considered to be the most up-to-date.
- 7 The server will then send any files to the unit being synchronized that it determines are newer than those on the unit.
- 8 The unit will then send any Reports, Configuration profiles, screen shots, etc. that have been saved on the unit since the last configuration.
- 9 The server then applies any applicable Options or Configuration Templates to the unit.

When successful, a message box will be displayed.

For applying the option, the message is "New option was deployed to this unit by StrataSync. It will become effective after the next startup."

For applying the configuration, the message is "New configuration was deployed to this unit by StrataSync. It will become effective after the next startup."



NOTE:

If an Option Code was entered as a part of synchronization, power must be cycled to the unit to complete the process and initialize the option.

- 10 Lastly, if any upgrades are available, the user will be informed of their availability and asked to verify their desire to receive the upgrade.
- 11 When synchronization is complete, the Status will indicate "Sync Complete". The unit may be disconnected from the server.

The unit has been synchronized to the StrataSync Server.

Maintenance and Troubleshooting

This chapter describes how to maintain the SmartClass Triple Play Services instrument and its battery and how to identify and correct problems related to the SmartClass Triple Play Services. Topics discussed in this chapter include the following:

- “Cleaning the instrument” on page 146
- “Prolonging battery life” on page 146
- “Recharging the battery” on page 146
- “Replacing the battery pack” on page 147
- “Updating the software” on page 148
- “Adding options” on page 149
- “Getting Technical Assistance” on page 149
- “Additional information” on page 150
- “Resolving problems” on page 150

Cleaning the instrument

The instrument itself does not require any specialized cleaning. An occasional wipe with a damp cloth is sufficient.



NOTE:

When cleaning the instrument, JDSU recommends a damp cloth and water only. Cleaning with chemicals could cause damage to the plastic case, buttons, or removal of markings.

Prolonging battery life

The SmartClass Triple Play Services uses a rechargeable Lithium Ion (Lilon) battery pack. To prolong the life span of any batteries, follow the guidelines below:

- When not connected to the unit, store the battery in a cool, dry, and clean environment. Do not leave the battery in a car or truck, particularly during extremely hot or cold weather.
- The first time you use the SmartClass Triple Play Services, or after prolonged storage, use the AC adapter to power the unit.
- If the battery capacity is depleted or if the battery has been stored for a prolonged period, charge the battery before use.
- If charging the battery while they are in the unit, use the JDSU AC adapter to charge the batteries. Do not use an un-approved charger.
- The charger will not charge the battery when it is extremely hot or cold.
- Always dispose of batteries properly.

The following section describes how to recharge and replace the batteries.

Recharging the battery

When the Batt LED lights red, the battery should be charged or replaced.



NOTE:

You can test a circuit and recharge the battery at the same time. If you do not want to interrupt the current test, you may leave the power on and connect the AC power adaptor.

To charge the battery

- 1 Connect one end of the AC adapter to the connector on the bottom of the SmartClass Triple Play Services.
- 2 Connect the other end of the AC adapter to an AC power supply.



WARNING: ELECTRICAL SHOCK

Electrical shock may result in serious injury or death. Be sure the AC Adapter is connected to the correct voltage mains. Do not use outdoors or in wet locations. Use only the AC Adapter supplied with the test set.

- 3 Let the SmartClass Triple Play Services charge for 5 hours for a fast charge; for maximum capacity, allow the SmartClass to (trickle) charge overnight.

The charging time will be the same whether the power is on or off.

The **Batt** LED is amber when the unit is fast charging. The SmartClass Triple Play Services will trickle charge at other times when the charger is connected and the Batt LED is green.

After the Batt LED turns green (fast charge is complete), allow the unit to trickle charge overnight for maximum performance.

Charging the batteries is complete.

Replacing the battery pack

The battery compartment is located on the back of the unit, as shown in [Figure 20](#).



Figure 20 Back of the SmartClass Triple Play Services

The following procedure describes how to replace the battery pack.

Before replacing the battery pack, verify that the replacement battery pack is JDSU part number 21129596 (catalog number SCTP-BATTERY).

To replace the battery pack

- 1 Turn the power off.



CAUTION: INSTRUMENT DAMAGE

Failure to turn the power off before removing the batteries from the SmartClass Triple Play Services could damage internal components and/or corrupt the software. Always power down the unit before removing the battery pack.

- 2 Using a phillips screw driver, remove the screw from the battery compartment door.
- 3 Remove the battery compartment door by pressing down and pushing toward the bottom end.
- 4 Disconnect the old battery pack from the wiring.
- 5 Connect the new battery pack to the wiring.

6 Replace the battery compartment door.

Replacing the battery pack is complete.

Updating the software

The SmartClass Triple Play Services's software can be upgraded in the field using either FTP or with the USB port on the right side of the instrument. You can obtain the software (filename "smartclass_XXXX.tps" where XXXX is the version) by doing one of the following:

- [Download it](#) from our web site and then copy it to a USB stick (in the root directory).
- Use the FTP application to download it to the unit.
(This is the "File Transfer Test" in the data application. See ["Throughput testing" on page 64.](#))



NOTE:

If you download or FTP the software, make sure that the filename has a .tps extension. Other extensions will not work.

- Call JDSU Customer Service to order an upgrade. You will receive a USB stick with the software already on it.

To update software

- 1** If using a USB stick for the update, connect it to the USB connector on the right side of the unit.

The unit will auto-detect the USB drive.

- 2** From the Main Menu, select **System Settings**, and then **Administration**, and then select **Software Update**.

The Software Update screen appears.

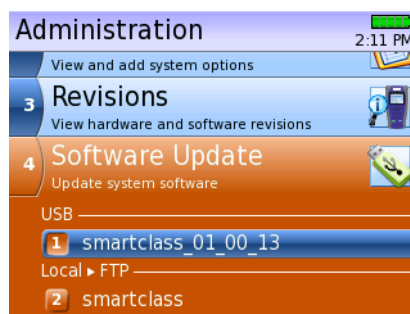

This screen shows two software files, one on USB and the other is a FTP-downloaded file.

- 3** Select which file to use.
- 4** Press the **OK** key to verify, and begin the update.
The update status is displayed on the screen.
The update will take several minutes.



NOTE:

During the update the unit will turn off then back on. This allows the software to validate that the current software update was successful before removing the previous software. If an error occurs during the update, the unit will revert to the previous software version.

5 After the update finishes, turn the unit off then back on.

The software is updated.

Adding options

The SmartClass Triple Play Services allows you to add new options to your unit in the field by entering a unique number key that will un-lock the new feature. Contact your sales representative or call JDSU customer service to order your new feature and obtain the unique key for your unit. This will be a 12 byte (24-digit) number. To generate this key, the JDSU customer service representative will need the following information:

- The serial number of your unit (found on the label on the back of the unit)
- The unique hardware ID number (see “[Viewing unit revisions, options, and IDs](#)” on page 30)

The following procedure describes how to add options. You can also add options through StrataSync by synchronizing your unit with the StrataSync server. Refer to “[StrataSync](#)” on page 141.

To add options

- 1 Contact your JDSU representative to obtain the number key that will enable the option you want to add.
- 2 From the Main Menu, select **System Settings**, and then **Administration**.
- 3 Select **Options**.
A list of current options appears and indicates whether the option is installed on your unit. The unit’s unique Hardware ID number also appears on this screen.
- 4 Select **Add Options**.
A prompt appears to enter the code for the option.
- 5 Enter the code obtained in [step 1](#), then press the **OK** key.
- 6 Restart the unit.

When the menu is viewed again, a check mark appears next to the option indicating it is available for use.

Getting Technical Assistance

If you need assistance or have questions related to the use of this product, use the information in [Table 52 on page 150](#) to contact JDSU’s Technical Assistance Center (TAC) for customer support. For the latest TAC contact information, go to www.jdsu.com or contact your local sales office for assistance.

The regional sales office phone numbers are listed on the back of this manual.

Table 52 Technical assistance centers

Region	Phone Number	
Americas	1-855-ASK-JDSU +1 301 353 1560	tac@jdsu.com
Europe, Africa, and Mid-East	+49 (0) 7121 86 1345 (JDSU Germany)	hotline.europe@jdsu.com
Asia and the Pacific	+852 2892 0990 (Hong Kong)	
	+8610 6833 7477 (Beijing-China)	

During off-hours, you can request assistance by doing one of the following: leave a voice message at the TAC for your region; email the North American TAC (tac@jdsu.com); submit your question using our online Technical Assistance request form at www.jdsu.com.

Additional information

For additional information, visit the SmartClass TPS web page:

<http://www.jdsu.com/products/communications-test-measurement/products/a-z-product-list/smart-class-tps.html>

Resolving problems

If you are having trouble with the SmartClass Triple Play Services, the following sections describe common problems and solutions. You should verify whether your problem is listed here before contacting technical assistance.

Operating the unit

The following section addresses questions that may be asked about operating and performing basic functions with the SmartClass Triple Play Services.

Issue

The handset (internal) microphone does not work.

Resolution

The microphone is only used for POTS and VoIP calls.

Performing tests

The following section addresses questions that may be asked about completing tests with the SmartClass Triple Play Services. The following sections are included:

- General
- Ethernet tests
- DSL tests
- VoIP tests
- Video tests
- Copper tests

General test problems

The following section addresses questions about testing in general.

Issue

Inconsistent test results.

Resolution

Verify that your test leads are good and are connected properly for the test you are performing.

DSL test problems

The following section addresses questions about DSL testing.

Issue

The modem cannot achieve sync with the CO.

Resolution

Inability to sync can have many causes. Perform the following steps to troubleshoot:

- Disconnect the customer's DSL modem.
- Verify tester connection to the correct pair.
- Verify the Data mode.
- Verify that the Standard is correct (ADSL2+, G.DMT, Auto, etc.).
- Isolate premise wiring.
- Check for premise alarm system.
- Verify the copper pair is provisioned for ADSL or VDSL at the CO.
- Test at the CO/Exchange on the customer pair.
- Check the DSLAM modem vendor and software version.

Issue

The modem gets sync with the CO, but the rate is lower than expected.

Resolution

Verify that you are on an ADSL2/2+ or VDSL line, as appropriate.

Check the bits/tone and the SNR/tone for areas of the spectrum with low throughput. This could be caused by bridged taps, cable crosstalk, or AM radio.

Check the DSLAM configuration - the max rate may be limited there.

Check for premise alarm system on the same pair.

Avoid excessive loop length or high attenuation.

Make sure that you are connected on pins 3 and 4.

Verify the noise margin.

Data test problems

The following section addresses questions about Data testing.

Issue

The IP ping menu says pings are being sent, but the network statistics are not incrementing.

Resolution

Verify that the network is up by checking the Frame LED. It should be solid green.

Verify the IP address and netmask.

You may be behind a firewall. Use trace route to determine whether this is the case.

The IP ping function only *attempts* to send a ping every second. Depending on certain conditions, a physical ping packet may not be sent.

If IPoE or PPPoE data mode is being used, the device has to ARP the address first. If this fails eventually you will see a ARP HOST UNREACHABLE message. Check to see that the destination IP address and your configured IP parameters are correct.

If the Ethernet interface is being used, make sure that the cabling is correct. If the Ethernet cable is not hooked up, or is hooked up incorrectly, a packet will not be sent. Thus the Ethernet statistics will not increment.

Issue

The Sync LED is green, but the Frame LED status is not.

Resolution

Verify that the Data Mode is *not* set to None.

Issue

In through mode, I'm connected to the Ethernet connector, but I'm not getting a data connection (green Frame LED).

Resolution

Go to the Ethernet Settings screen and check the Media Type. If it's set to Auto, change it to match the specific LAN speed and duplex type that you are using.

Issue

I'm on an ADSL circuit and the ATM results indicate that I am receiving frames but the Frame LED is not green and IP pings are not working.

Resolution

Check the encapsulation and the mode. The wrong protocol may be in use.

Issue

I'm on an ADSL circuit and I have a PPPoA service and I get a PPP TIMEOUT message

Resolution

Verify that the VPI-VCI is correct.

Verify that the encapsulation is correct.

Verify that the addressing mode is set correctly (IPCP/Static).

Verify that the username and password are correct.

Issue

I have a PPPoE connection and I get a PPPoE FAILED message.

Resolution

Verify that the VPI-VCI is correct.

Verify that the encapsulation is correct.

Verify that the addressing mode is correct.

Verify that the user name and password are correct (including case).

Check for a VLAN.

Issue

I'm on an ADSL circuit and I have a Bridged Ethernet connection and I get a DCHP FAILED message.

Resolution

Verify that the VPI-VCI is correct.

Verify that the encapsulation is correct.

Verify that the DHCP server isn't out of addresses. (Contact your IT department or help desk.)

Issue

I get an INVALID CONFIG message.

Resolution

Verify that a valid IP address is being used (examples of invalid IP addresses would be *.*.*.0 or 127.*.*.* or 10.0.0.1 or 192.168.0.0).

Verify that the IP address and gateway are on the same network as defined by the netmask.

Check the netmasks if Ethernet IP = DSL IP. The netmasks must be different.

Verify that the Netmask is *not* set to 0.0.0.0.

Issue

The Frame LED is green, but IP pings are not working.

Resolution

A green Data status indicator does not guarantee an IP ping (or any routed/bridged packet) will be treated properly once it leaves the unit. In an Ethernet bridged or IP over ATM environment with static addressing, there is no initial communication with the far end, so as soon as ATM sync occurs the interface is deemed active to pass user data.

Make sure that the VPI and VCI is correct.

Make sure that the encapsulation is correct.

Try pinging a different host.

Make sure the DNS server is active with another PC.

Set the ping packet size smaller.

Make sure the Data mode is set correctly for the type of circuit under test (such as PPPoE versus IPoE).

Make sure you are not behind a firewall; they can block ping responses from reaching the host.

Check to see if the connection is unnumbered. If it is, verify that the connection is configured correctly.

View the IP Ping results menu. It can often give important clues as to why the ping is not successful.

VoIP test problems

The following section addresses questions about VoIP testing.

Issue

The VoIP call didn't go through.

Resolution

Check your connections to verify that they are hooked up properly.

Check the status LEDs. The Sync and Frame LEDs should be green.

Verify the LAN settings (IP address, netmask, DNS name).

Verify the call control. Most equipment uses Fast Connect.

If you *do not* have a gatekeeper, verify the outgoing alias and IP address.

If you *are* using a gatekeeper, verify you are registered with the gatekeeper.

If you are on an IPoE line and STUN is enabled, the data layer will not come up until the STUN client on the SmartClass has determined the type of NAT used between the SmartClass and the STUN server. Wait a few minutes and try to resync.

Check with your system administrator to verify that the firewall allows VoIP traffic.

Issue

I am emulating a SIP phone but cannot register with the SIP server.

Resolution

In typical networks, the same server handles both registration and placing and receiving calls. However, in some networks, there is a Proxy server that handles SIP messaging for placing and receiving calls, and a registrar that handles registration, which may be in a different domain.

If this is the case, do the following.

- Verify that you specified the “Proxy” on the Proxy Settings menu as the outbound proxy, or the device from which the SmartClass will send and receive all SIP messages (for placing and receiving calls).
- Verify that you specified the “Alias” on the General Settings menu as the SIP server or registrar (the device that keeps track of all the registered devices), using the following format “phone-Number@domain” where domain is either an IP address of the registrar or a literal domain such as “jdsu.com”.

Issue

The VoIP delay measurement does not appear.

Resolution

The Delay result is only calculated if the RTCP signaling is active.

Issue

I have very little loss, but a high level of delay.

Resolution

Check your network. It may be experiencing high traffic.

Issue

I have a large amount of jitter, but no loss or delay.

Resolution

Check the setup of your router.

Video test problems

Individual program flows should be analyzed to ensure that both content quality and network performance parameters are within desired network specifications. The suggested thresholds are listed below:

Packet loss = less than or equal to 0.1%

Packet jitter = less than or equal to 5 msec*

PCR jitter = less than or equal to 5 msec*

Error indicator = zero count

IGMP latency = less than or equal to 200 msec

*Specific STB/decoder designs may be able to tolerate higher levels of jitter based on larger buffer designs. Less than or equal to 10 msec may be acceptable.

Five to ten msec is a conservative PCR jitter level. As network designs and STBs increase buffer sizes, the acceptable level will rise. The acceptable level for a particular network is a company-specific issue.

When these measurements are made simultaneously on more than one channel, then content problems can be easily separated from distribution network problems, a critical determination for problem resolution.

Issue

I have continuity errors.

Resolution

Packet loss (continuity error) problems are typically seen on all channels/programs coming to the premise because they are not source or content related. If packet loss is present, analysis of the physical layer at the xDSL interface or Ethernet interface will aid in sectionalization. If no physical layer errors are present, then packet loss is most likely being caused by the distribution network not from the access network. Congestion is most likely at issue.

Looking further into the temporal component can help pinpoint the issue. The answers to the following questions can help find the problem area(s). Are packets being lost during known peak traffic times during the day? Are they coming in bursts with intervals with no loss? Are they random single or small packet loss events?

Bursts of loss might be more symptomatic of buffer overflows related to heavy traffic. Random single or small events might be more related to noise hits on the access network impacting packet flows. DSL loop performance in the access network may be pushing the bandwidth limits when signal to noise margins are low and the addition of a second or third channel flow reaches 100% capacity of the loop. The copper may be poorly balanced allowing high impulse noise to impact the data flows. In-home wiring may be introducing noise which also can damage data flows.

Issue

I have a PCR jitter result that is higher than expected.

Resolution

PCR jitter problems may be due to content quality problems as outlined previously or overall network packet jitter. By evaluating more than one channel/program at a time, this can be determined. If excessive PCR jitter is present at more than one channel, network jitter is most likely at fault. If excessive PCR jitter is present on only one channel, then a source problem as described above is normally the cause.

Issue

I am receiving error indicators.

Resolution

Error Indicator counts indicate content problems, since the indicator can only be set by the encoder. Typically this would affect only one program or channel. However, if a multiple program feed in the head end is experiencing problems, more than one program/channel could be affected. Analyzing a channel from another source, or different feed would be instructive. The video may show poor quality with only the Error Indicator count showing a problem. Any count is bad.

Issue

I have significantly more IGMP latency on one channel than the others.

Resolution

IGMP latency measures the network's performance. Typically, IGMP latency would be similar for multiple channels. However, if network topology and management place access to certain program material farther back in the network, then differences could be experienced. If such a hierarchical approach is used, then differences might be detected based upon which programs are accessible deeper in the network. Testing multiple channels/programs to exercise this network design would be useful.

Copper test problems

The following section addresses questions about Copper testing.

Issue

The Tip (A) - Ring (B) voltage is reading negative.

Resolution

The Tip (A) and Ring (B) test leads may be swapped. Check your test leads to verify that they are hooked up properly.

Issue

The AC voltage test result from Tip (A) to Ground (E) is 5 volts and from Ring (B) to Ground (E) is 15 volts.

Resolution

Either Tip (A) is open or Ring (B) is longer. This will also be indicated by noise on the loop. Results on Tip (A) to Ring (B) should be 0.0 volts. Tip (A) to Ground (E) and Ring (B) to Ground (E) should be equal to each other. Anything else indicates AC signal interference and/or an unbalanced line.

Ringer voltage level can be checked by having the CO ring back on the line. Results should be either 85 volts (older switches) or 105 volts (newer switches).

Issue

The DC volt measurement on Tip (A) to Ground (E) is 15 volts with the battery removed.

Resolution

This indicates there may be an open in the insulation drawing current from another pair.

To measure DC volts, remove the line battery and measure Tip (A) and Ring (B) to Ground (E). It should be < 3.0 volts; anything else indicates crossed battery that inhibits digital signals.

To check for span/battery voltage, measure Tip (A) to Ring (B) across several pairs. On good lines Tip (A) to Ring (B) will be 48–52 volts, Tip (A) to Ground (E) will be < 5 volts, and Ring (B) to Ground (E) will be -48–52 volts.

Issue

In the winter, the DC current measured 21 mA from an aerial cable at the NID with are no problems. In the summer, the same line measured 17 mA.

Resolution

The heat has increased resistance and lowered the current.

DC current on Tip (A) to Ring (B) should be ≥ 23 mA at the NID. Anything less will not allow for differences in temperature and phone equipment will not operate during extremes.

The 23 mA threshold covers most temperature extremes.

Issue

The resistance measurement on Tip (A) to Ring (B) is 3.5 M Ω , Ring (B) to Ground (E) is 3.5 M Ω , and Tip (A) to Ground (E) is 5 k Ω .

Resolution

There is a ground fault on Tip (A). The typical resistance is > 3.5 M Ω . Lower values indicate a short or ground fault

Loop resistance is measured with the pair short circuited (shorted) at one end, so a much lower resistance value is measured, as the current can readily flow down one lead and easily back up the other across the short. This “loop resistance” measurement is often required to qualify HICAP (high-capacity) circuits such as ADSL with values approximating 700 Ω .

Resistance is measured not only across Tip (A) to Ring (B), but also from Tip (A) to Ground (E) or Ring (B) to Ground (E). Resistance is also measured from one lead to Ground (E) to check for shorts to the shield and other ground references, indicating a fault on one lead of the wire pair. Resistance measurements made to Ground (E) are used to compare the resistance value of one lead to the other, to see how much difference exists in the resistance of one lead compared to the other. It is important for both leads to be nearly the same (resistive balance), and a difference of more than 3 percent is usually considered unacceptable.

Issue

While running the Opens test, the mutual value looks good, but the Tip (A) and Ring (B) values are really short.

Resolution

Verify the ground. The module must be grounded to the same ground as the pair under test. (Use the Current test to verify the ground. See [step 10 on page 116.](#))

Issue

Two loops in the same bundle display different loop lengths.

Resolution

Use a known good loop to determine capacitance, then run the opens again to determine the length of the bridge tap or location of the fault. Verify with a tester that has TDR capability.

Measure multiple vacant pairs by attaching one lead to Ground (E) and using the other to the Tip (A) of each vacant conductor. (Battery should be removed) Compare the distance for each for consistency.

Opens/Capacitance: < 3% difference between Tip (A) and Ring (B) values indicate an acceptably balanced loop. Anything greater indicates an unbalanced line or open fault, which inhibit digital signals.

You can also compare the distance from the Opens measurement to a resistive distance measurement, and determine the presence of a bridged tap by the difference in the distances.

Issue

The balance measurement is 50 dB.

Resolution

The pair quality is too low as it should mitigate 60 dB. The balance result should be >60 dB. Anything less indicates electrical differences between Tip (A) and Ring (B) that can lead to noise and other signal problems.

This would indicate some imbalance in the quality of each lead and reduced noise immunity. The more each lead is electrically identical (capacitance, inductance, impedance), the better the pair will resist induced noise. If they do not cancel induced noise equally, the difference is realized as unwanted current, or metallic or mutual noise. If the imbalance of the leads is too great, the customer would hear noise.

Issue

The POTS service test is fine but the DSL signal cannot be detected at the NID. The test set indicates 2 load coils on a 15 kft loop.

Resolution

Load coils block high frequency signals such as DSL and they must be removed for digital circuits.

In a normal loading scheme, the first one will be 3 kft from the CO and the second will be 9 kft from the CO. Use a tester that has TDR capability to verify the location of the loads. Loads are used to improve POTS over long loops. On most loops 18 kft or longer, load coils are required to ensure voice quality. Load coils must be evenly spaced starting at 3 kft from the CO and placed at 6 kft intervals thereafter, with at least 2,000 feet between the last load coil and the customer premises.

Specifications

This appendix contains specifications for the SmartClass Triple Play Services. Topics discussed in this appendix include the following:

- [“Physical specifications” on page 162](#)
- [“Connector specifications” on page 162](#)
- [“Environmental specifications” on page 162](#)
- [“Power specifications” on page 163](#)
- [“Calibration” on page 163](#)
- [“Warranty information” on page 163](#)

Physical specifications

Table 53 provides the physical specifications.

Table 53 Physical specifications

Parameter	Specification
Size (H x W x D)	9.05 x 4.72 x 2.75 in (230 x 120 x 70 mm)
Weight, including battery	2.5 lb (1.1 kg)

Connector specifications

Table 54 provides the connector specifications.

Table 54 Connector specifications

Connector	Specification
POTS	8-pin modular (RJ-45)
DSL	8-pin modular (RJ-45)
Ethernet	8-pin modular (RJ-45)
USB	USB 2.0
Power	2.1x5.5mm Center Positive Standard

Environmental specifications

Table 55 provides the environmental specifications.

Table 55 Environmental specifications

Parameter	Specification
Operating Temperature	-0° to +40° C (32° to +104° F)
Storage Temperature	-30° to 60° C (-22° to 140° F)
Humidity	10% to 90% RHNC

Safety specification

Ingress protection is the degree of protection provided against the intrusion of solid objects (including body parts like hands and fingers), dust, accidental contact, and water in mechanical casings and with electrical enclosures.

The degree of ingress protection for the SmartClassTPS is IP20.

Power specifications

Although battery life varies depending on the type of test, [Table 56](#) provides specifications for the battery life and the specifications for the AC adapter.

Table 56 Power specifications

Parameter	Specification
Operating time	Greater than 4 hours (depending on type of test)
Charging time	5 hours for a fast charge; for a full charge, allow to trickle charge overnight
Unit power input	12 V, 2.5 Amp
Power supply input	100 to 240 VAC, 50/60 Hz, autosensing
Power supply output	12 V, 2.5 Amp

Calibration

The following section briefly discusses calibrating the SmartClass Triple Play Services unit.

Self calibration

The SmartClass Triple Play Services can be self calibrated. It includes built-in self calibration routines that allow the instrument's Copper measurement circuits to maintain specification for more than 5 years. For more information on how to perform a self-calibration, see ["Calibrating the unit" on page 117](#).

Factory calibration

JDSU recommends that you return your SmartClass Triple Play Services to the factory every 3 years for complete inspection and calibration. For additional information about options, services, and factory calibration, contact your local JDSU representative or contact JDSU through the company web site, www.jdsu.com.

Warranty information

The warranties described herein shall apply to all commercially available JDSU Communications Test and Measurement products. Any additional or different warranties shall apply only if agreed to by JDSU in writing. These warranties are not transferable without the express written consent of JDSU.

Hardware Warranty — JDSU warrants that Hardware Product sold to customer shall, under normal use and service, be free from defects in materials and workmanship. Information regarding the specific warranty period for this product can be obtained by contacting your local JDSU Customer Service Representative, or at our web site www.jdsu.com. The warranty period shall begin upon shipment to Customer. Hereafter these periods of time shall be collectively referred to as the "Initial Warranty Period."

JDSU's obligation and customer's sole remedy under this Hardware Warranty is limited to the repair or replacement, at JDSU's option, of the defective product. JDSU shall have no obligation to remedy any such defect if it can be shown: (a) that the Product was altered, repaired, or reworked by any party other than JDSU without JDSU's written consent; (b) that such defects were the result of customer's improper storage, mishandling, abuse, or misuse of Product; (c) that such defects were the result of customer's use of Product in conjunction with equipment electronically or mechanically incompatible or of an inferior quality; or (d) that the defect was the result of damage by fire, explosion, power failure, or any act of nature.

JDSU performed repairs shall be warranted from defective material and workmanship for a period of ninety (90) days, or until the end of the Initial Warranty Period, whichever is longer. Risk of loss or damage to Product returned to JDSU for repair or replacement shall be borne by customer until delivery to JDSU. Upon delivery of such product, JDSU shall assume the risk of loss or damage until that time that the product being repaired or replaced is returned and delivered to customer. Customer shall pay all transportation costs for equipment or software shipped to JDSU for repair or replacement. JDSU shall pay all transportation costs associated with returning repaired or replaced product to customer.

Software Warranty — JDSU warrants that Software Products licensed to Customer shall, under normal use and service, and for a period of ninety (90) days from the date of shipment of the Software to Licensee (the "Warranty Period"), perform in all material respects in accordance with the published specifications for such Software as established by JDSU. However, JDSU does not warrant that the Software will operate uninterrupted or error free, operate in the combination with other software, meet Customer's requirements, or that its use will be uninterrupted.

JDSU's obligation and Customer's sole and exclusive remedy under this Software Warranty is limited to, at JDSU's option, either (i) correcting the material errors reported to JDSU in writing by Customer during the Warranty Period and which JDSU is able to reproduce, (ii) replacing such defective Software, provided that JDSU received written notice of such defect within the Warranty Period, or (iii) provided that JDSU received written notice of such defect within the Warranty Period, terminating the License and, upon return to JDSU of the Software, Documentation and all other materials provided by JDSU under the applicable License, providing Customer with a refund of all charges paid with respect thereto. JDSU shall have no warranty obligations hereunder if (a) the Software is altered or modified or is merged with other software by Customer or any third party or (b) all or any part of the Software is installed on any computer equipment other than the Designated Server or used with any operating system for which the Software is not designed.

Customer acknowledges that the Software Products provided by JDSU hereunder may contain third party software not produced by JDSU (a "Third Party Supplier Product"), and may be made available under the software license(s) specific to that Third Party Supplier Product. To the extent a Third Party Supplier Product is made available under the GNU General Public License, such license shall govern the use of such Third Party Supplier Product, and the following notice shall apply:

"(1) This program is free software; you can distribute it and/or modify it under the terms of the GNU General Public License as published by the Free Software Foundation; either version 2 of the License, or (at your option) any later version. This program is distributed in the hope that it will be useful, but WITHOUT ANY WARRANTY; without even the IMPLIED WARRANTY OF MERCHANTABILITY or FITNESS FOR A PARTICULAR PURPOSE. See the GNU General Public License for more details. If you would like to receive further details concerning the use of such General Public License Software or would like to receive a copy of the GNU General Public License, please make a written request to JDSU, One Milestone Center Ct., Germantown, Maryland 20876-4023 or write to the Free Software Foundation, Inc., 59 Temple Place - Suite 330, Boston, MA 02111-1307, USA."

WARRANTY DISCLAIMER — FOR HARDWARE, AND/OR SOFTWARE FURNISHED BY JDSU, THE FOREGOING WARRANTIES ARE IN LIEU OF ALL OTHER WARRANTIES AND CONDITIONS, EXPRESS OR IMPLIED. JDSU SPECIFICALLY DISCLAIMS ALL OTHER WARRANTIES, EITHER EXPRESS OR IMPLIED, ON ANY HARDWARE, SOFTWARE, DOCUMENTATION OR

SERVICES INCLUDING BUT NOT LIMITED TO WARRANTIES RELATING TO QUALITY, PERFORMANCE, NONINFRINGEMENT, MERCHANTABILITY OR FITNESS FOR A PARTICULAR PURPOSE, AS WELL AS THOSE ARISING FROM ANY COURSE OF DEALING, USAGE OR TRADE PRACTICE. UNDER NO CIRCUMSTANCES WILL JDSU BE LIABLE FOR ANY INDIRECT OR CONSEQUENTIAL DAMAGES RELATED TO BREACH OF THIS WARRANTY.



Communications Test and Measurement Regional Sales

North America
Toll Free: 1 855 ASK JDSU

Latin America
Tel: +55 11 5503 3800

Asia Pacific
Tel: +852 2892 0990

EMEA
Tel: +49 7121 86 2222

www.jdsu.com

22035456
Rev 001, 5/2014
English

Important safety instructions

When using the product, basic safety precautions should always be followed to reduce the risk of fire, shock, and injury to persons, including the following:

- 1 Use only the AC Adapter/Charger supplied with the product. Do not use AC Adapter/Charger outdoors or in wet or damp locations. Connect the AC Adapter/Charger to the correct mains voltage as indicated on the ratings label.
- 2 Do not touch or otherwise come in contact with telephone conductors that could be exposed to lightning or accidental connection to power circuits without first isolating them from the telephone network.
- 3 Use appropriate cables when connecting to telecommunications circuits. Putting an RJ-11 connector in a RJ-45 port can damage the RJ45 port.
- 4 **WARNING:** Danger of extreme heat, fire, or explosion if battery is tampered with. Replace only with JDSU battery 21129596 (catalog number SCTP-BATTERY). Dispose of used batteries according to the manufacturer's instructions.
- 5 Do not attempt to service this product yourself, as opening or removing covers may expose you to dangerous high voltage points and other hazards. Refer all servicing to qualified service personnel.
- 6 **CAUTION:** If the equipment is used in a manner not specified by JDSU, the protection provided by the equipment may be impaired.
- 7 Do not use on power circuits or on telecommunications network voltages over 300 VDC or 300 VAC Peak.
- 8 The SmartClass TPS is protected by 500mA fuses. Do not touch the exposed contact of the test clamps.
- 9 Charge the lithium ion battery using only the JDSU battery charger. The battery is to be used only with JDSU test products.
- 10 Be sure that TNV signals are not connected to SELV ports. If you need to access a line that may have TNV or higher voltages present using a SELV port, you must do so through an interface device that is certified to provide a SELV connection point (see [Table 1 on page 3](#)).
- 11 **CAUTION:** To reduce the risk of fire, use only 26 AWG or larger telecommunications line cord.
- 12 Please see "[Safety symbols](#)" for safety symbols. Where the unit is labeled with a warning symbol, the operating manual must be consulted to learn more about the nature of the potential hazard and any action that must be taken.
- 13 The copper testing interface is classified as Measurement Category I . It is not intended to be connected to circuits from Measurement categories II , III , or IV . The maximum voltage, including transients is 300 Volts.

Save these instructions

Consignes de sécurité importantes

Lorsque vous utilisez ce produit, plusieurs consignes de sécurité primaires doivent toujours être appliquées afin de réduire le risque d'incendie, de décharge électrique et de blessure corporelle :

- 1 Utilisez uniquement l'adaptateur/chargeur CA livré avec le produit. N'utilisez pas cet accessoire à l'extérieur ou dans des locaux humides. Raccordez-le à la tension de ligne CA correcte, conformément aux indications de l'étiquette signalétique.
- 2 Ne touchez pas ou n'entrez pas en contact avec des conducteurs téléphoniques susceptibles d'être exposés à la foudre ou à un raccordement accidentel à des circuits d'alimentation électrique, sans les avoir préalablement isolés du réseau téléphonique.
- 3 Employez les câbles appropriés en se reliant aux circuits de télécommunications. La mise d'un connecteur RJ-11 dans un port RJ-45 peut endommager le port RJ45.
- 4 **ATTENTION :** Si vous tentez d'ouvrir la batterie, une situation dangereuse peut apparaître (dégagement de chaleur extrême, incendie ou explosion). Pour remplacer une batterie usagée, utilisez toujours une batterie JDSU du même type 21129596 (référence SCTP-BATTERY). Éliminez les batteries usagées conformément aux instructions fournies par le fabricant.
- 5 Ne tentez pas de réparer ce produit par vos propres moyens car l'ouverture ou le retrait de couvercles peut vous exposer à des points de haute tension dangereux et à d'autres risques. Pour toute réparation, faites appel à un spécialiste qualifié.
- 6 **PRUDENCE :** Si cet équipement est utilisé d'une manière non recommandée par JDSU, la protection intrinsèque pourra être mise en défaut.
- 7 N'employez pas sur des circuits de puissance ou sur des tensions de réseau de télécommunications plus de crête de 300 volts continu ou de 300 VCA.
- 8 Le TPS SmartClass est protégé par des fusibles de 500mA. Ne pas toucher le contact exposé les pinces de test.
- 9 Dans le chargeur JDSU fourni, chargez uniquement une batterie de type lithium-ion. Cette batterie doit être exclusivement utilisée avec les produits JDSU.
- 10 Vérifiez qu'aucun signal TNV n'est transmis aux ports TBTS. Si vous devez accéder à une ligne susceptible de véhiculer une tension TNV ou supérieure en utilisant un port TBTS, vous devez intercaler un équipement d'interface certifié pour fournir un point de raccordement TBTS.
- 11 **PRUDENCE :** Pour réduire le risque du feu, employez seulement 26AWG ou plus grande ligne corde de télécommunications.
- 12 Veuillez voir les "[Safety symbols](#)" pour des symboles de sûreté. Là où l'unité est marquée avec un symbole d'avertissement, le operating manual doit être consulté pour apprendre plus au sujet de la nature du risque et de n'importe quelle mesure qui doivent être pris.
- 13 L'interface d'essai de cuivre est classifiée comme catégorie I de mesure. On ne le prévoit pas pour être relié aux circuits des catégories de mesure II , III , ou IV . La tension maximum, y compris des coupures est de 300 volts.

Mémoirisez ces instructions

Wichtige Sicherheitsinformationen

Zur Verringerung von Brandgefahren, zur Vermeidung eines elektrischen Schlages und von Verletzungen sind alle grundlegenden Sicherheitsvorkehrungen einzuhalten. Dazu zählen auch die folgenden Maßnahmen:

- 1 Verwenden Sie ausschließlich das mit dem Produkt gelieferte Netzteil/Ladegerät. Verwenden Sie das Netzteil/Ladegerät nicht im Freien oder in feuchten Räumen. Schließen Sie das Netzteil/Ladegerät nur an die auf dem Typenschild angegebene Netzspannung an.
- 2 Berühren Sie weder direkt noch indirekt Telefonadern, die durch Blitzschlag gefährdet sind oder bei denen ein versehentlicher Anschluss an Hochspannungsleitungen möglich ist, ohne diese zuvor vom Telefonnetz getrennt zu haben.
- 3 Benutzen Sie passende Kabel beim Anschließen an Fernmeldeleitungen. Das Einstecken eines Steckers RJ-11 in einen RJ-45 Anschluss kann diesen beschädigen.
- 4 **WARNUNG:** Bei Manipulationen an der Batterie (Akku) besteht die Gefahr einer starken Erhitzung, eines Brandes oder einer Explosion. Der Austausch der Batterie sollte nur gegen eine JDSU-Batterie (Bestellnummer: SCTP-BATTERY) erfolgen. Entsorgen Sie gebrauchte Batterien (Akkus) entsprechend den Anweisungen des Herstellers.
- 5 Versuchen Sie nicht, dieses Produkt selbst zu warten. Beim Öffnen bzw. Abnehmen der Abdeckung besteht die Gefahr des Kontaktes mit gefährlichen Spannungsspitzen und anderer gesundheitlicher Risiken. Die Wartung des Produktes darf nur von entsprechend qualifizierten Fachkräften ausgeführt werden.
- 6 **VORSICHT:** Der Einsatz des Gerätes für andere als von JDSU angegebene Zwecke kann die vom Gerät gewährleisteten Schutzfunktionen beeinträchtigen.
- 7 Verwenden Sie nicht auf Energie Stromkreisen oder auf Fernmeldenetzspannungen über 300 VDC oder 300 VAC einer Spitze.
- 8 SmartClass TPS wird von 500mA Sicherungen geschützt. Berühren Sie nicht den exponierten Kontakt Test-Klemmen.
- 9 Laden Sie den Lithium-Ionen-Akku nur mit dem von JDSU gelieferten Ladegerät. Der Akku darf nur mit Testprodukten von JDSU eingesetzt werden.
- 10 Achten Sie darauf, dass TNV-Signale nicht an SELV-Anschlüsse angeschlossen werden. Wenn Sie auf eine Leitung, an der TNV-Spannung oder höhere Spannungen anliegen können, über einen SELV-Anschluss zugreifen, dann müssen Sie hierfür ein Schnittstellengerät verwenden, das nachweislich einen SELV-Anschlusspunkt bereitstellt.
- 11 **VORSICHT:** Um die Gefahr des Feuers zu verringern, benutzen Sie nur 26AWG oder größeres Nachrichtentechnik Netzanschlußschnur.
- 12 Sehen Sie bitte "Safety symbols" für Sicherheit Symbole. Wo die Maßeinheit mit einem Warnsymbol beschriftet wird, muß das Benutzerhandbuch beraten werden, um mehr über die Natur der möglichen Gefahr und aller möglicher Maßnahmen zu erlernen, die ergriffen werden müssen.
- 13 Die Kupfer Prüfschnittstelle wird als Maß-Kategorie I eingestuft. Es soll nicht an Stromkreise von den Maßkategorien angeschlossen werden II, III oder IV. Die maximale Spannung, einschließlich Ausgleichströme ist 300 Volt.

Bewahren Sie diese Hinweise auf

Importanti istruzioni di sicurezza

Quando utilizza il prodotto, l'utente dovrà sempre adottare precauzioni di base per ridurre il rischio di incendi, scosse elettriche e lesioni a terzi. Le precauzioni comprendono quanto riportato di seguito.

- 1 Utilizzare esclusivamente l'adattatore AC/caricabatterie fornito insieme al prodotto. Non utilizzare l'adattatore AC/caricabatterie in esterni oppure in luoghi umidi o bagnati. Collegare l'adattatore AC/caricabatterie alla tensione di rete corretta secondo quanto riportato sull'apposita etichetta.
- 2 Non toccare né entrare in altro modo in contatto con conduttori telefonici che possono essere stati colpiti da fulmini o collegati accidentalmente a circuiti di potenza senza aver prima provveduto a isolarli dalla rete telefonica.
- 3 Usi i cavi adatti quando collegano ai circuiti di telecomunicazioni. Mettendo un connettore RJ-11 in un orificio RJ-45 può danneggiare l'orificio RJ45.
- 4 **AVVERTENZA:** pericolo di estremo calore, incendio o esplosione in caso di manomissione della batteria. Sostituire esclusivamente con batterie JDSU 21129596 (numero per ordinazioni: SCTP-BATTERY). Smaltire le batterie usate secondo le istruzioni della casa produttrice.
- 5 Non cercare di riparare da soli il prodotto; l'apertura o la rimozione dei coperchi potrebbero esporre l'utente a tensione pericolosa e ad altri rischi. Rivolgersi a personale qualificato per tutte le operazioni di manutenzione.
- 6 **ATTENZIONE:** se l'impianto viene utilizzato in modo diverso da quello specificato da JDSU, ciò potrebbe compromettere la protezione fornita.
- 7 Non usi sui circuiti di alimentazione o sulle tensioni della rete di telecomunicazioni oltre un picco VCA da 300 o da 300 VCC
- 8 Il TPS SmartClass è protetta da fusibili 500mA. Non toccare il contatto esposto dei morsetti di prova.
- 9 Per ricaricare la batteria agli ioni di litio, utilizzare esclusivamente il caricabatterie JDSU. La batteria va utilizzata esclusivamente con i prodotti JDSU.
- 10 Verificare che i segnali TNV non siano collegati a porte SELV. Nel caso in cui sia necessario accedere a una linea nella quale sono presenti tensioni TNV o alte tensioni di altro tipo utilizzando una porta SELV, utilizzare un dispositivo di interfaccia omologato per la fornitura di un punto di collegamento SELV.
- 11 **ATTENZIONE:** Per ridurre il rischio di fuoco, usi soltanto 26AWG o la più grande linea cavo di telecomunicazioni.
- 12 Veda prego "Safety symbols" per i simboli di sicurezza. Dove l'unità è identificata con un simbolo d'avvertimento, il operating manual deve essere consultato per imparare più circa la natura del rischio potenziale e di tutta l'azione che devono essere intrapresi.
- 13 L'interfaccia difficile di rame è classificata come categoria I di misura. Non è inteso per essere collegato ai circuiti dalle categorie di misura II, III, o IV. Di Measurement. La tensione massima, compreso i passeggeri è di 300 volt.

Conservare queste istruzioni

Instrucciones de seguridad

Cuando use este producto, observe en todo momento ciertas precauciones básicas para reducir el peligro de incendios, golpes y lesiones personales, incluyendo:

- 1 No utilice un adaptador/cargador de alterna distinto al incluido con este producto. No lo emplee en exteriores ni en lugares mojados o muy húmedos. Conecte el adaptador/cargador de alterna a la tensión de red correcta, indicada en la etiqueta del instrumento.
- 2 No toque conductores telefónicos que pudieran estar expuestos a rayos o a conexiones accidentales con circuitos de alimentación, sin aislarlos previamente de la red telefónica.
- 3 Utilice los cables apropiados al conectar con los circuitos de telecomunicaciones. Poner un conector RJ-11 en un puerto RJ-45 puede dañar el puerto RJ45.
- 4 **ATENCIÓN:** Existe riesgo de incendio o explosión si se sustituye la batería por una batería no adecuada. Utilice siempre baterías de JDSU 21129596 (número de referencia SCTP-BATTERY). Para desechar las baterías siga las instrucciones del fabricante.
- 5 No trate de reparar este producto. Al abrir o quitar las cubiertas pueden quedar al descubierto elementos con tensiones elevadas. Consulte a un técnico de asistencia cualificado.
- 6 **PRECAUCIÓN:** Si este equipo se utiliza de forma distinta a lo especificado por JDSU, los mecanismos de protección previstos pueden dejar de funcionar u operar inadecuadamente.
- 7 No utilice en los circuitos de la energía o en voltajes de la red de telecomunicaciones sobre pico de 300 VDC o de 300 VAC.
- 8 El TPS SmartClass está protegido por fusibles de 500mA. No toque el contacto expuesto de las pinzas de prueba.
- 9 Para cargar la batería litio-ion, utilice siempre el cargador recomendado por JDSU. La batería debe usarse exclusivamente en equipos de JDSU.
- 10 Las señales TNV no deben conectarse a los puertos SELV. Si necesita acceder con un puerto SELV a una línea que pueda tener tensiones TNV o superiores, use un dispositivo de interfaz capaz de proporcionar un puerto SELV.
- 11 **PRECAUCIÓN:** Para reducir el riesgo del fuego, utilice solamente 26AWG o una línea más grande cuerda de las telecomunicaciones.
- 12 Vea por favor los "Safety symbols" para los símbolos de seguridad. Donde la unidad se etiqueta con un símbolo amonestador, el operating manual se debe consultar para aprender más sobre la naturaleza del peligro potencial y de cualquier acción que deban ser tomados.
- 13 El interfaz de prueba de cobre se clasifica como categoría 1 de la medida. No se piensa para ser conectado con los circuitos de categorías de la medida II, III, o IV. De Measurement. El voltaje máximo, incluyendo transeúntes es 300 voltios.

Guarde estas instrucciones

Safety symbols

The following safety symbols are used on the SmartClass Triple Play Tester. All safety precautions must be observed when operating, servicing, or repairing the SmartClass Triple Play Tester unit. Failure to comply with the following safety precautions or with hazards, dangers, warnings, and cautions used throughout this document or related manuals violates the intended use of this instrument.



CAUTION
This symbol indicates caution due to a potential hazard.



ELECTRICAL SHOCK HAZARD
This symbol indicates an electrical shock hazard.

Interfaces and safety classifications

Table 1 lists the SmartClass Triple Play Tester interfaces, port designations, safety classifications, and the maximum working voltage of each port.

Table 1 Safety classifications of connector ports

Connector	Safety Classification	Working Voltage	Connector	Safety Classification	Working Voltage
POTS	TNV-3	120 V DC	USB port	SELV	5 V
DSL	TNV-3	120 V DC	T/A, R/B, Ground	Hazardous Voltage	300 VAC & VDC peak
Ethernet	SELV	+5 V balanced	AC Adapter	SELV	12 V

Safety standards

The SmartClass Triple Play Tester meets the following safety standards:

- UL61010-1/CSA, 2nd Edition, Rev. 7/22/05: "Electrical Equipment for Measurement, Control, and Laboratory Use"
- EC/EN61010-1:2001, Rev 9/19/03, "Electrical Equipment for Measurement, Control, and Laboratory Use"
- UL 60950-1 1st Edition, Rev 11/26/03 "Information Technology Equipment" (for applicable clauses of TNV circuits)



Communications Test and Measurement Solutions
One Milestone Center Court
Germantown, Maryland 20876-7100 USA
Toll Free 1-855-ASK-JDSU • Tel +1-301-353-1650 • Fax +1-240-404-1996
www.jdsu.com

© Copyright 2013 JDS Uniphase Corporation. All rights reserved. JDSU, **Enabling Broadband and Optical Innovation**, Communications Test and Measurement Solutions, and the JDSU logo are trademarks of JDS Uniphase Corporation ("JDS Uniphase"). All other trademarks are the property of their respective owners. No part of this guide may be reproduced or transmitted electronically or otherwise without written permission of the publisher.