

SAR Test Report

Report No. : FCC_SAR_SL19060603-SLX-017 Rev_1.0
FCC ID : WUW-22135255B (BT) , WUW-22135255 (WLAN)
IC : 9613A-22135255B (BT) , 9613A-22135255 (WLAN)
Applicant : Viavi Solutions, Inc.
Address : 6001 America Center Drive, 6th Floor, San Jose, CA 95002
Product : Network & Service Companion
Brand : Viavi
Model No. : NSC-100
Standards : EN 62209-1:2016, IEC 62209-1:2016, EN 62209-2:2010, IEC 62209-2:2010
FCC 47 CFR Part 2 (2.1093), RSS-102 Issue 5
IEEE C95.1:1992, IEEE Std 1528:2013
KDB 865664 D01 v01r04, KDB 865664 D02 v01r04, KDB 447498 D01 v06
Sample Received Date : 09/01/2019
Date of Testing : 09/10/2019-09/29/2019
Issue Date : 10/18/2019
Test Location : 775 Montague Expressway, Milpitas, CA 95035

The above equipment has been tested by **Bureau Veritas Consumer Products Services, Inc., Milpitas Branch**, and found compliance with the requirement of the above standards. The test record, data evaluation & Equipment Under Test (EUT) configurations represented herein are true and accurate accounts of the measurements of the sample's EMC characteristics under the conditions specified in this report.

Prepared By :

Deon Dai / Test Engineer



Approved By :

Chen Ge / Engineer Review

This report is for your exclusive use. Any copying or replication of this report to or for any other person or entity, or use of our name or trademark, is permitted only with our prior written permission. This report sets forth our findings solely with respect to the test samples identified herein. The results set forth in this report are not indicative or representative of the quality or characteristics of the lot from which a test sample was taken or any similar or identical product unless specifically and expressly noted. Our report includes all of the tests requested by you and the results thereof based upon the information that you provided to us. You have 60 days from date of issuance of this report to notify us of any material error or omission caused by our negligence, provided, however, that such notice shall be in writing and shall specifically address the issue you wish to raise. A failure to raise such issue within the prescribed time shall constitute your unqualified acceptance of the completeness of this report, the tests conducted and the correctness of the report contents. Unless specific mention, the uncertainty of measurement has been explicitly taken into account to declare the compliance or non-compliance to the specification. The report must not be used by the client to claim product certification, approval, or endorsement by A2LA or any government agencies.

Table of Contents

Release Control Record	3
1. Summary of Maximum SAR Value	4
2. Description of Equipment Under Test	5
3. SAR Measurement System	6
3.1 Definition of Specific Absorption Rate (SAR)	6
3.2 SPEAG DASY6 System	6
Data Acquisition Electronics (DAE)	7
Probes	8
Light-Beam Unit	8
Phantoms	9
Device Holder	10
DASY6 Measurement Chain	10
Data Evaluation	11
SAR Measurement	14
SAR Measurement Scan Description	14
Device Reference Point	18
Test Configuration – Positioning for Cheek/Touch	20
Test Configuration – Positioning for Ear/15° Tilt	21
Test Configuration – Body Worn Configuration	21
Liquid Depth	23
3.3 SAR System Verification	25
4.1 EUT Configuration and Setting	26
4.2 EUT Testing Position	27
Test Configuration – Positioning for Cheek/Touch	27
Test Configuration – Positioning for Ear/15° Tilt	28
Test Configuration – Body Worn Configuration	28
4.2.1 Face Exposure Conditions	32
4.2.2 Limbs Exposure Conditions	33
4.3 Tissue Verification	34
4.4 System Verification	34
4.5 Maximum Output Power	35
4.5.1 Measured Conducted Power Result	35
Duty factor of 100% was used for SAR evaluation	35
4.6 SAR Testing Results	37
4.6.1 SAR Results for Body Exposure Condition (Separation Distance is 0 mm Gap)	37
WLAN_2.4G	37
WLAN_5G	40
4. Calibration of Test Equipment	46
5. Information of the Testing Laboratories	47
Appendix A. SAR Plots of System Verification	
Appendix B. SAR Plots of SAR Measurement	
Appendix C. Calibration Certificate for Probe and Dipole	
Appendix D. Photographs of EUT	



BUREAU
VERITAS

Release Control Record

Report No.	Reason for Change	Date Issued
FCC_SAR_SL19060603-SLX-017	Initial release	10/14/2019
FCC_SAR_SL19060603-SLX-017 Rev_1.0	Update Per Review	10/18/2019

1. Summary of Maximum SAR Value

Highest Standalone Transmission SAR	Highest Body SAR-1g Tested at 0 mm (W/kg)
5GHz	0.985

Highest Standalone Transmission SAR	Highest Body SAR-1g Tested at 0 mm (W/kg)
2.4GHz	0.055

Highest Simultaneous Transmission SAR	Highest Body SAR-1g Tested at 0 mm (W/kg)
5GHz / BT	1.285

Highest Simultaneous Transmission SAR	Highest Body SAR-1g Tested at 0 mm (W/kg)
2.4GHz / BT	0.355

2. Description of Equipment Under Test

Product	Network & Service Companion
Brand	Viavi
Test Model	NSC-100
Identification No. of EUT	N/A
Model Difference	N/A
Status of EUT	Engineer Sample
Power Supply Rating	100-240VAC, 1.2A, 50-60Hz
Modulation Type	GFSK, π /4DQPSK, 8DPSK CCK, DQPSK, DBPSK for DSSS 64QAM, 16QAM, QPSK, BPSK for OFDM
Modulation Technology	FHSS, DSSS, OFDM
Transfer Rate	BDR/EDR: 1/2/3Mbps BT_LE: 1Mbps 802.11b: up to 11Mbps 802.11g: up to 54Mbps 802.11n: up to 300Mbps 802.11a: 54/48/36/24/18/12/9/6Mbps 802.11n: up to 1200Mbps 802.11ac: up to 3466.4Mbps
Operating Frequency	2402 ~ 2480MHz 2412 ~ 2462MHz 5150 ~ 5350MHz, 5470 ~ 5725MHz, 5745 ~ 5825MHz
Number of Channel	BDR/EDR: 79 BT_LE: 40 2412 ~ 2462MHz 802.11b, 802.11g, 802.11n (HT20): 11, 802.11n (HT40): 7 5180~5240MHz: 802.11a, 802.11n (HT20), 802.11ac (VHT20): 4 802.11n (HT40), 802.11ac (VHT40): 2 802.11ac (VHT80): 1 5260~5320MHz: 802.11a, 802.11n (HT20), 802.11ac (VHT20): 4 802.11n (HT40), 802.11ac (VHT40): 2 802.11ac (VHT80): 1 5500~5700MHz: 802.11a, 802.11n (HT20), 802.11ac (VHT20): 11 802.11n (HT40), 802.11ac (VHT40): 5 802.11ac (VHT80): 2 5745~5825MHz: 802.11a, 802.11n (HT20), 802.11ac (VHT20): 5 802.11n (HT40), 802.11ac (VHT40): 2 802.11ac (VHT80): 1
Antenna Type	PIFA Antenna: 2.4GHz: 2.7dBi / 5GHz: 4.4dBi / Chip Antenna 0.5dBi (BT)
Antenna Connector	U.FL Connector (WLAN)

Note: Device is a 3x3 MIMO configuration. 3x3 MIMO operation was considered during SAR evaluation.

1. The EUT uses following adapter.

Brand	FSP
Model	FSP045-D3MR3
Input Power	100-240V, 1.2A, 50-60Hz
Output Power	5.0V/9.0V/12.0V/15.0V 3.0A
Power Line	20.0V 2.25A

2. The above EUT information is declared by manufacturer and for more detailed features description, please refers to the manufacturer's specifications or user's manual.

3. SAR Measurement System

3.1 Definition of Specific Absorption Rate (SAR)

SAR is related to the rate at which energy is absorbed per unit mass in an object exposed to a radio field. The SAR distribution in a biological body is complicated and is usually carried out by experimental techniques or numerical modeling. The standard recommends limits for two tiers of groups, occupational/controlled and general population/uncontrolled, based on a person’s awareness and ability to exercise control over his or her exposure. In general, occupational/controlled exposure limits are higher than the limits for general population/uncontrolled.

The SAR definition is the time derivative (rate) of the incremental energy (dW) absorbed by (dissipated in) an incremental mass (dm) contained in a volume element (dv) of a given density (ρ). The equation description is as below:

$$SAR = \frac{d}{dt} \left(\frac{dW}{dm} \right) = \frac{d}{dt} \left(\frac{dW}{\rho dv} \right)$$

SAR is expressed in units of Watts per kilogram (W/kg)

SAR measurement can be related to the electrical field in the tissue by

$$SAR = \frac{\sigma |E|^2}{\rho}$$

Where: σ is the conductivity of the tissue, ρ is the mass density of the tissue and E is the RMS electrical field strength.

3.2 SPEAG DASY6 System

The DASY6 system in cDASY6/DASY5 V5.2 SAR Configuration is shown below:

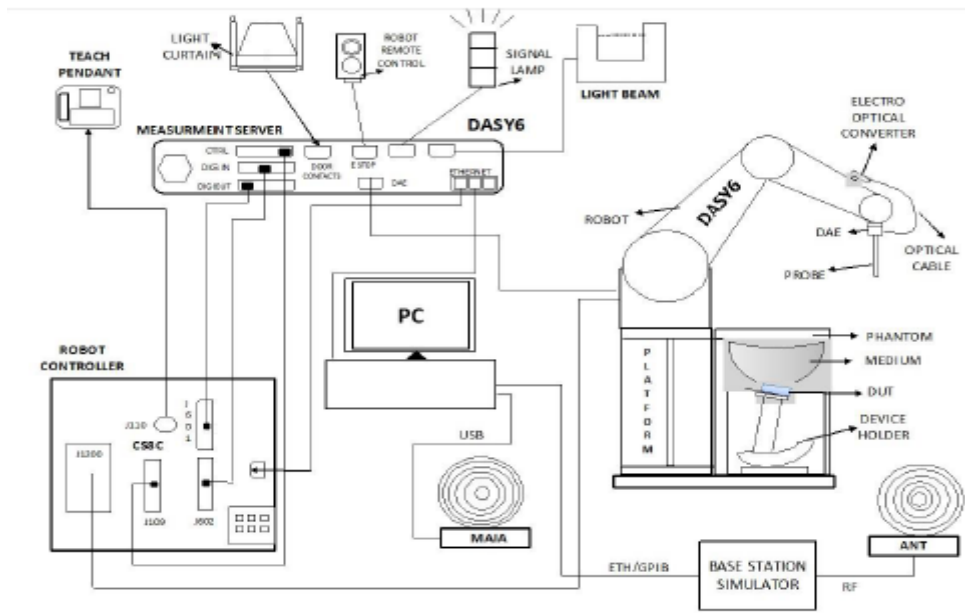

Fig-3.1 SPEAG DASY6 System Setup

The cDASY6 system for performing compliance tests consist of the following items:

- Robot (6 Axis) & Parts
 - Controller
 - Teach Pendant
 - Signal Lamps
 - Remote Control
- Phantoms
- Platforms
- Tissue/Head Sim. Liquids
- Dielectric Measurement Kit
- DUT Holder
- Probes & Dipole Kit
- Data Acquisition Electronics (DAE)
- Measurement Server
- Light Beam Unit
- Computer & Software
- MAIA / ANT

Data Acquisition Electronics (DAE)

The data acquisition electronics (DAE) consist of a highly sensitive electrometer-grade preamplifier with auto-zeroing, a channel and gain-switching multiplexer, a fast 16-bit AD-converter, and a command decoder with a control logic unit. Transmission to the measurement server is accomplished through an optical downlink for data and status information, as well as an optical uplink for commands and the clock.

The mechanical probe mounting device includes two different sensor systems for frontal and sideways probe contacts used for mechanical surface detection and probe collision detection.

The input impedance of the DAE box is 200M Ω ; the inputs are symmetric and floating. Common mode rejection is above 80dB.

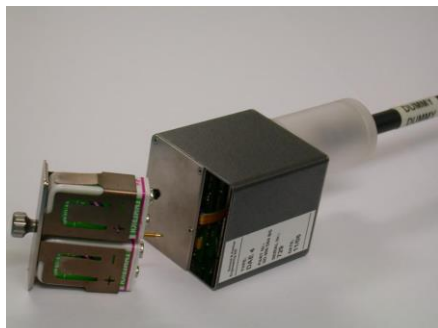

The DAE works with either two standard 9V batteries or two 9V (more precisely, 8.4V or 9.6V) rechargeable batteries. Because the electronics automatically power-down unused components during braking or between measurements, the battery lifetime depends on system usage. Typical lifetimes are >20 hours for standard and >10 hours for rechargeable batteries. Remove the batteries if you do not plan to use the DAE for a long period of time.

Probes

The DASY system can support many different probe types.

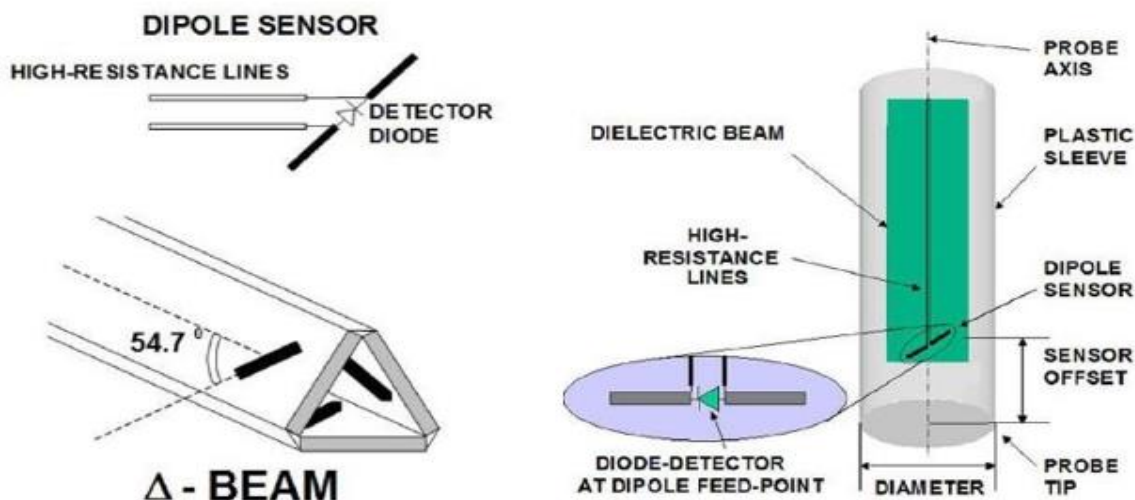

Dosimetric Probes: These probes are specially designed and calibrated for use in liquids with high permittivities. They should not be used in air, since the spherical isotropy in air is poor ($\pm 2\text{dB}$). The dosimetric probes are specially calibrated in various liquids at different frequencies.

Free-Space Probes: These are electric and magnetic field probes specially designed for measurements in free space. The z-sensor is aligned to the probe axis, and the rotation angle of the x-sensor is specified. This allows the DASY system to automatically align the probe in the measurement grid for field component measurement. The free-space probes are generally not calibrated in liquid. (The H-field probes can be used in liquids without any change to the parameters.)

Temperature Probes: These small and sensitive temperature probes for general use are based on a completely different parameter set and evaluation procedures. Temperature rise features allow direct SAR evaluations with these probes.

Audio Magnetic Probes: The AM1D probes are active probes with a single sensor each for axial and radial measurement scans as defined for audio band magnetic (ABM) signals testing in the ANSI C63.19 standard. The AM1D probe is fully RF shielded.

Teaching Probe: Teaching Probes are special probes, which are used for performing mother scans to detect and record the phantom inner surface location. These probes are mounted on special purpose DAEs, shipped along with the probes.

Probe	Freq. Range	Tip Diameter	Sensor Offset	Rec. Sensor- Phantom Dist.
ES3DV3	10 MHz-4 GHz	4.0mm	2mm	3.0mm
EX3DV3	10 MHz-6 GHz	2.5mm	1mm	1.4mm

Light-Beam Unit

The light beam switch allows automatic “tooling” of the probe. During the process, the actual position of the probe tip with respect to the robot arm, as well as the probe length and the horizontal probe offset, are measured. The

software then corrects all movements within the measurement jobs, such that the robot coordinates are valid for the probe tip.



The repeatability of this process is better than 0.1mm. If a position has been taught with an aligned probe, the same position will be reached with another aligned probe within 0.1mm, even if the other probe has different dimensions. During probe rotations, the probe tip will keep its actual position.

Phantoms

SPEAG phantoms are high-quality products constructed of materials compatible with all tissue simulating liquids, including aggressive, e.g., DGBE type, solvents. The shells are constructed with a very tight tolerance of less than 0.2mm, and all parameters correspond to those requested by SAR standards. Full computer-aided design (CAD) information have been predefined in the DASY6 software, enabling fast and easy usage.



The SAM-Twin phantom (shown in front of DASY6) is a fiberglass shell phantom with shell thickness 2mm, except in the ear region where the thickness is increased to 6mm. The phantom has three measurement areas: 1) Left Head, 2) Right Head, and 3) Flat Section. For larger devices, the use of the ELI Phantom (shown behind DASY6) is required.

The ELI phantom is intended for compliance testing of handheld and body-mounted wireless devices in the frequency range of 30MHz to 6GHz. ELI has been optimized for performance and can be integrated into a SPEAG standard phantom table. A cover is provided to prevent evaporation of water and changes in liquid parameters. Reference markings on the phantom allow installation of the complete setup, including all predefined phantom positions and measurement grids, by teaching three points.

Device Holder

The SAR in the phantom is approximately inversely proportional to the square of the distance between the source and the liquid surface. For a source at 5mm distance, a positioning uncertainty of $\pm 0.5\text{mm}$ would produce uncertainty in the SAR of $\pm 20\%$. Accurate device positioning is therefore crucial for accurate and repeatable measurements. The positions at which the devices must be measured are defined by the standards.



The DASy device holder is designed to cope with the different positions described in the standard. It has two scales for device rotation (with respect to the body axis) and device inclination (with respect to the line between the ear reference points). The rotation centers for both scales is the ear reference point (ERP). Thus, the device needs no repositioning when the angles are changed. The DASy device holder is constructed of low-loss polyoxymethylene (POM) material, which has the following dielectric parameters: relative permittivity $\epsilon=3$ and loss tangent $\delta=0.02$. The amount of dielectric material has been reduced in the closest vicinity of the device, since measurements have suggested that the influence of the clamp on the test results could thus be lowered.

DASy6 Measurement Chain

The DASy6 dosimetric measurement system signal chain is shown in the figure below:

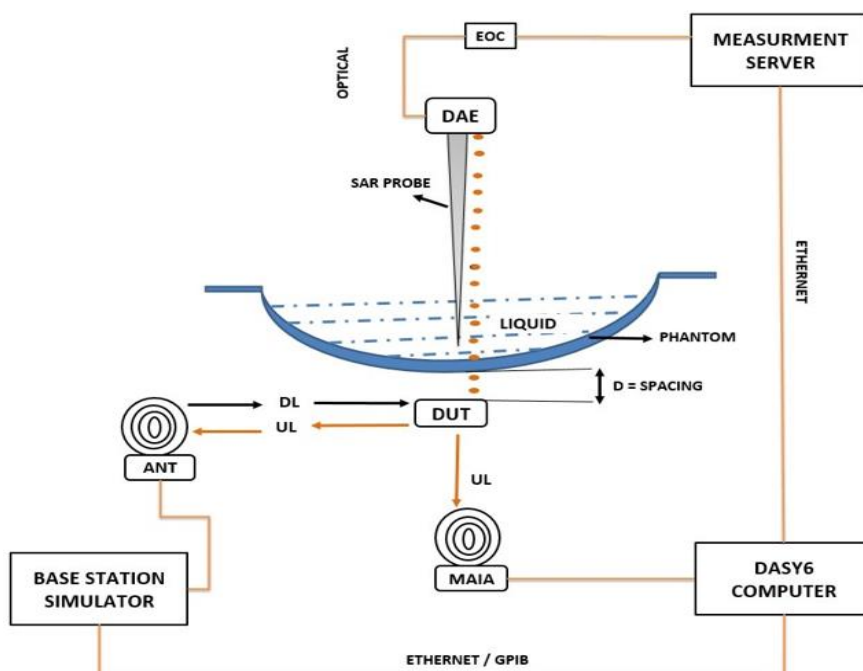

Figure 1: cDASy6 V6.4 Dosimetric Measurement System Signal Chain

The base-station simulator is controlled by the computer, to setup a specific test mode call with the device under test (DUT).

The DUT is placed in the Device Holder and held at a fixed spacing / orientation with respect to the phantom.

The phantom has a fixed geometry and thickness defined by the compliance standards. The phantom is filled with liquid medium of known permittivity and conductivity.

The uplink signal transmitted by the DUT is measured inside the medium by the probe, which is accurately positioned at a precisely known distance and defined orientation with respect to the phantom surface, normal at the point by the 6-axis robot positioner.

The dipole / loop sensors at the probe tips pick up the signal and generate a voltage, which is measured by the voltmeter inside the data acquisition electronics (DAE). The DAE returns digital values, which are converted to an optical signal and transmitted via the electro-optic converter (EOC) to the measurement server (MS). The data is finally recorded in the DASY6 software.

The Modulation and Interference Analyzer (MAIA) measures the uplink signal and the cDASY6 V6.4 software calculated signal characteristics such as bandwidth, modulation frequency, etc. and matches these with the known characteristics of the test mode call parameters set up via the base-station simulator. This is important, as the probe has different calibration factors for different types of uplink signals – to obtain an accurate reading, the uplink signal must match the probe calibration factors applied.

In case of a new or unknown signal, the MAIA is used to ascertain the best match of probe calibration factors depending on the characteristics of measured signal.

The free-space E-field / H-field measurement setup is also similar. The SAR probe is replaced by the E- an/or H-field probe, while the DUT is typically placed on a plane surface. The data acquisition and signaling processing via the DAE, EOC, and MS by the DASY6 software remains the same.

Data Evaluation

The fields and SAR are calculated from the measured voltage (probe voltage acquired by the DAE) and the following parameters:

Probe Parameters	- Sensitivity	normi, ai0, ai1, ai2
	- Conversion factor	ConvFi
	- Diode compression point	dcpi
	- Probe Modulation Response Factors	<i>a_i, b_i, c_i, d</i>
Device Parameter	- Frequency	f
	- Crest factor	cf
Media Parameters	- Conductivity	σ
	- Relative Permittivity	ρ

Parameters are stored in the measurement file.

Approximated Probe Response Linearization using Crest Factor

This linearization method is enabled when a custom defined communication system is measured. The compensation applied is a function of the measured voltage, the detector diode compression points and the crest factor of the measured signal.

$$V_i = U_i + U_i^2 \cdot \frac{cf}{dcp_i}$$

with V_i = linearized voltage of channel i (uV) (i = x,y,z)
 U_i = measured voltage of channel i (uV) (i = x,y,z)

cf = crest factor of exciting field (DASY parameter)
 dcp_i = diode compression points of channel i (μV) (Probe parameter, $i = x,y,z$)

The resulting linearized voltage is only approximated because the probe is not calibrated to this specific signal.

Probe Response Linearization for Specific Calibrated Communication Signals

Modern communication protocols employ complex modulation schemes and channel access techniques. probe linearization using crest factor method may lead to large measurement errors over the full dynamic range when measuring complex modulations. DASY features an advanced probe response linearization that reduces the maximal measurement error while considerably increasing the probe dynamic range.

The measured voltage is first compensated:

$$V_{comp_i} = U_i + U_i^2 \cdot \frac{10^{d/20}}{dcp_i}$$

With V_{comp_i} = compensated voltage of channel i (μV) (i = x,y,z)
 U_i = input voltage of channel i (μV) (i = x,y,z)
 d = PMR factor d (dB) (Probe parameter)
 dcp_i = diode compression point of channel i (μV) (Probe parameter, $i = x,y,z$)

The compensated voltage is converted in $dB\sqrt{\mu V}$:

$$V_{comp_i,dB\sqrt{\mu V}} = 10 \cdot \log_{10}(V_{comp_i})$$

A correction factor specific to the communication signal is calculated using the PMR factors:

$$corr_i = a_i \cdot e^{-\left(\frac{V_{comp_i,dB\sqrt{\mu V}} - b_i}{c_i}\right)^2}$$

with $corr_i$ = correction factor of channel i (dB) (i = x,y,z)
 $V_{comp_i,dB\sqrt{\mu V}}$ = compensated voltage of channel i ($dB\sqrt{\mu V}$) (i = x,y,z)
 a_i = PMR factor a of channel i (dB) (Probe parameter, $i = x,y,z$)
 b_i = PMR factor b of channel i ($dB\sqrt{\mu V}$) (Probe parameter, $i = x,y,z$)
 c_i = PMR factor c of channel i (Probe parameter, $i = x,y,z$)

The voltage $V_{i,dB\sqrt{\mu V}}$ is the linearized voltage in $dB\sqrt{\mu V}$:

$$V_{i,dB\sqrt{\mu V}} = V_{comp_i,dB\sqrt{\mu V}} - corr_i$$

with $V_{i,dB\sqrt{\mu V}}$ = linearized voltage of channel i ($dB\sqrt{\mu V}$) (i = x,y,z)
 $V_{comp_i,dB\sqrt{\mu V}}$ = compensated voltage of channel i ($dB\sqrt{\mu V}$) (i = x,y,z)
 $corr_i$ = correction factor of channel i (dB) (i = x,y,z)

Finally, the linearized voltage is converted in μV :

$$V_i = 10^{\frac{V_{i,dB\sqrt{\mu V}}}{20}}$$

with V_i = linearized voltage of channel i (μV) (i = x,y,z)
 $V_{i,dB\sqrt{\mu V}}$ = linearized voltage of channel i ($dB\sqrt{\mu V}$) (i = x,y,z)

Field and SAR Calculation

The primary field data for each channel are calculated using the linearized voltage:

$$\text{E - fieldprobes : } E_i = \sqrt{\frac{V_i}{\text{Norm}_i \cdot \text{ConvF}}}$$

$$\text{H - fieldprobes : } H_i = \sqrt{V_i} \cdot \frac{a_{i0} + a_{i1}f + a_{i2}f^2}{f}$$

with V_i	= linearized voltage of channel i	(i = x,y,z)
Norm_i	= sensor sensitivity of channel i	(i = x,y,z)
	$\mu\text{V}/(\text{V/m})^2$ for E-field Probes	
ConvF	= sensitivity enhancement in solution	
a_{ij}	= sensor sensitivity factors for H-field probes	
f	= carrier frequency [GHz]	
E_i	= electric field strength of channel i in V/m	
H_i	= magnetic field strength of channel i in A/m	

The RMS value of the field components gives the total field strength (Hermitian magnitude):

$$E_{tot} = \sqrt{E_x^2 + E_y^2 + E_z^2}$$

The primary field data are used to calculate the derived field units.

$$SAR = E_{tot}^2 \cdot \frac{\sigma}{\rho \cdot 1'000}$$

with SAR	= local specific absorption rate in mW/g
E_{tot}	= total field strength in V/m
σ	= conductivity in [mho/m] or [Siemens/m]
ρ	= equivalent tissue density in g/cm ³

Note that the density is set to 1, to account for actual head tissue density rather than the density of the tissue simulating liquid.

SAR Measurement

The procedure for assessing the peak spatial-average SAR value consists of the following steps:

- **Power Reference Measurement**

The reference and drift jobs are useful jobs for monitoring the power drift of the device under test in the batch process. Both jobs measure the field at a specified reference position, at a selectable distance from the phantom surface. The reference position can be either the selected section's grid reference point or a user point in this section. The reference job projects the selected point onto the phantom surface, orients the probe perpendicularly to the surface, and approaches the surface using the selected detection method.

- **Area Scan**

An Area Scan job is part of the compliance testing protocol of the DUT. The main goal of this job is to locate the approximate location(s) of the local peak SAR value(s). The measurement grid within an Area Scan is defined by the grid extent, grid step size and grid offset. The selection of these properties is highly dependent on the size (and position) of the DUT, frequency of operation, DUT-phantom offset and available time for the assessment. If the SAR distribution is a-priori not known, the grid extent should be such that it covers the whole area of the DUT.

- **Zoom Scan**

For dosimetric application, it is necessary to assess the peak spatial SAR value averaged over a volume. For this purpose, fine resolution volume scans need to be performed at the peak SAR location(s) determined during the Area Scan.

A measurement grid within a zoom scan is defined by the grid extents (X,Y,Z), Offsets and Step Sizes (X,Y,Z). While step sizes in X and Y are usually a fixed value, DASY6 software permits to have a graded step size for the Z direction, for which a grading ratio can be defined. Graded grids are useful for SAR evaluations at higher frequencies (> 2GHz) as the decay rate is high and a higher number of measurements closer to the phantom surface is required to accurately extrapolate the measured values to the phantom surface.

- **Power Drift measurement**

The drift job measures the field at the same location as the most recent reference job within the same procedure, and with the same settings. The drift measurement gives the field difference in dB from the reading conducted within the last reference measurement. Several drift measurements are possible for one reference measurement. This allows a user to monitor the power drift of the device under test within a batch process. In the properties of the Drift job, the user can specify a limit for the drift and have OPENSAR software stop the measurements if this limit is exceeded.

SAR Measurement Scan Description

Fast Scan Description

Fast Scan is used to assess the peak spatial SAR values within a cubic averaging volume containing 1g and 10g of simulated tissue in only 10s provided the absorption pattern (antenna and frequency band). Fast Scans compare the measured pattern of a given test configuration to the ones measured previously. If a similar pattern shape (matching configuration) is found, a scaling factor defined as difference in amplitude of the two configurations is computed. The Area and Zoom Scans results available for the matching configuration are then scaled to assess the 1g and 10g SAR of the measured configuration.

Grid Settings

The grid extents used for Fast Scans are the same as for Area Scans.

Area Scan Description

Area Scans are used to determine the peak location of the measured field before doing a finer measurement around the hotspot. Area Scans measure a two-dimensional volume covering the full device under test area. cDASY6 V6.4 uses Fast Averaged SAR algorithm to compute the 1g and 10g of simulated tissue from the Area Scan.

Grid Settings

Automated Grid Settings

cDASY6 V6.4 automatically generates Area Scan grid settings based on device dimensions. The scan extent is defined by the device dimensions plus additional 15mm on each side.

For Flat phantom sections both the device under test and the area scan are centered around the phantom device reference point. For Left Head and Right Head phantom sections, Area Scans are anchored to the ERP (Ear Reference Point) and oriented along the Ear Mouth line. The device under test position on this line is given by the speaker position which is always placed at the ERP. The scans extents are defined by the device height and width increased by 15mm on each side.

Figure 1 shows a typical area scan grid for Flat and Left Head phantom sections.

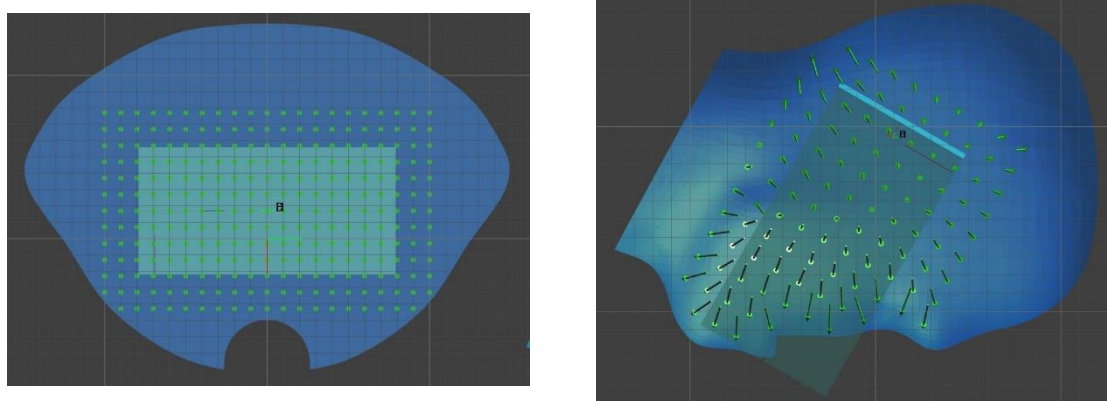

(a) Flat Phantom Section
 (b) Left Head Phantom Section

Figure 1: Measurement Grid for Area Scans

Table 1 describes the Area Scan grid extents used in Flat, Left Head and Right Head phantom sections.

Section	Position	Extent X [mm]	Extent Y [mm]
Flat	TOP (SCREEN)	Width + 30	Height + 30
Flat	BOTTOM (COVER)	Width + 30	Height + 30
Flat	EDGE TOP	Thickness + 30	Width + 30
Flat	EDGE BOTTOM	Thickness + 30	Width + 30
Flat	EDGE LEFT	Thickness + 30	Height + 30
Flat	EDGE RIGHT	Thickness + 30	Height + 30
LEFT / RIGHT HEAD	CHEEK	Width + 30	Height + 30
LEFT / RIGHT HEAD	TILT	Width + 30	Height + 30

Table 1: Area Scan Grid Extents in Flat, Left Head and Right Head Phantom Sections

Area Scan grid steps and sensor distance to surface are defined in Table 2.

f [GHz]	d sensor-surface [mm]	Step X, Y [mm]
0 - 2	3	14
2 - 3	3	14
3 - 4	3	10
4 - 6	3	10

Table 2: Area Scan Grid Settings in Flat Phantom Sections

User defined Grid Settings

In cDASY6 V6.4 user defined grid settings can be applied as well. In the scan properties of the measurement the grid extent, grid step and grid offset can be changed after changing the default selection 'DUT dimensions + 15 mm' to 'User defined' see figure 2. and figure 3.

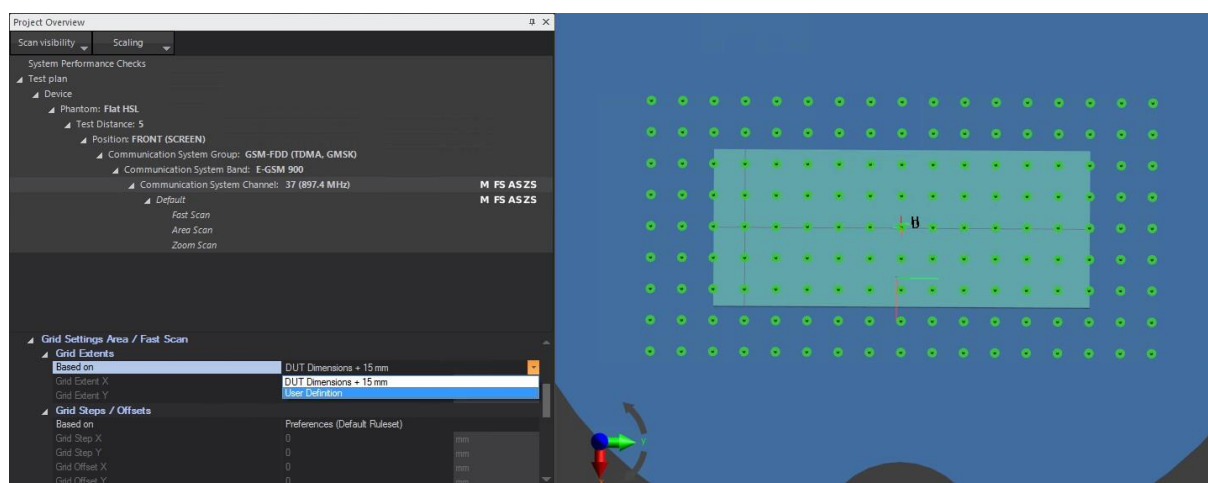

Figure 2: Default grid settings based on DUT dimensions.

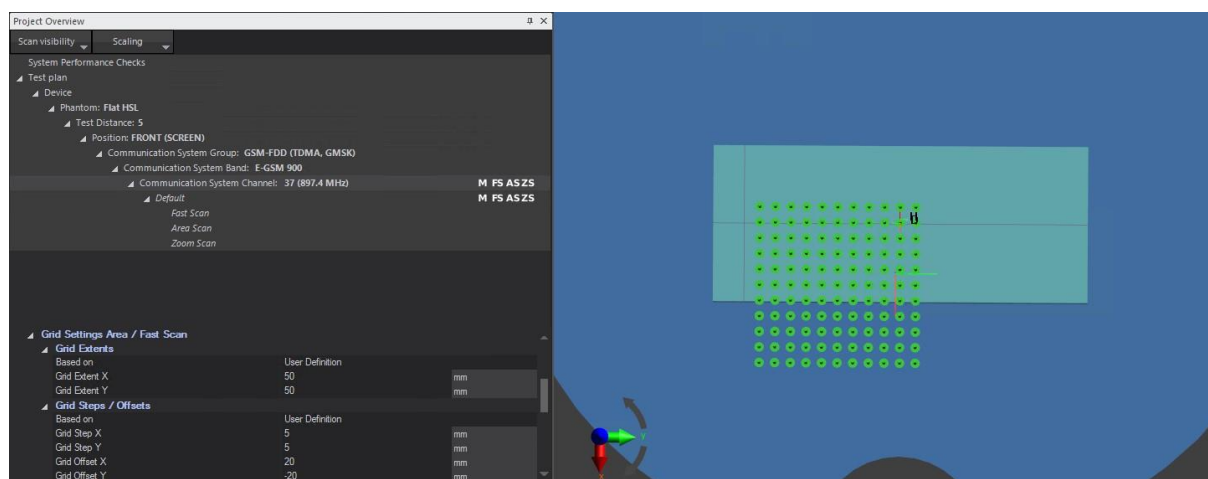

Figure 3: Grid settings as specified by the user.

Special Case of Specialized Phantoms

For Headstand and Facedown phantoms, the DUT can't be defined using a simple brick shape. Also, the transmitting might operate in any area of the head. For these phantoms, cDASY6 V6.4 features a tool to easily define the measurable area: the user can directly draw the grid on the 3D view by defining a tetragonal with 4 points. Due to the geometry of the phantom, no area scan is performed in the Forearm phantom.

Zoom Scan Description

Zoom scans are used to assess the peak spatial SAR values within a cubic averaging volume containing 1g and 10g of simulated tissue. Zoom scans measure a three-dimensional volume (cube). The bottom face of the cube is centered on the maximum of the preceding Area Scan in the same measurement group. For maxima at border of the phantom, auto extend zoom scan when maxima on boundary feature can be enabled in Application Preferences Scan Settings with Administrator access level.

Grid Settings

Automated Grid Settings

Zoom Scans are always anchored to the peak location of the preceding Area Scan. The sensor distance to the surface depends on the probe type used during measurement: 1.4mm for EX probes and 3mm for ES probes. Table 3 describes the grid settings used for Zoom Scans in Flat phantom sections.

f [GHz]	Extend XYZ [mm]	Step XY [mm]	Step Z [mm]	Graded	Grading Ratio [mm]
0 - 2	30 x 30 x 30	6	6	No	-
2 - 3	30 x 30 x 30	6	6	No	-
3 - 4	22 x 22 x 22	4	1.8	Yes	1.4
4 - 6	22 x 22 x 22	4	1.4	Yes	1.4

Table 3: Zoom Scan Grid Settings in Flat, Left Head and Right Head Phantom Sections

User defined Grid Settings

Similar like for Area Scans the grid settings for Zoom Scans can be customized. After selecting the 'User Defined' option, Grid extent x,y,z, grid step x,y,z as well as Graded grid and Grading ratio can be set by the user.

Power Monitoring Scan

Power monitoring scans are used to monitor the power drift of the device under test. The local SAR strength is measured at a reference position at the beginning and at the end of the scan. The power drift is computed using the formula:

$$P_{drift}[dB] = 10 \cdot \log_{10} \frac{SAR_{beginning}}{SAR_{end}}$$

Power monitoring scans are available for fully integrated in Area and Zoom Scans. They can be enabled in Application Preferences Scan Settings. For Area Scans, the reference point is defined as the maximum location of the preceding Fast Scan. A Fast Scan will be automatically performed if none has been performed and power monitoring is enabled. For Zoom Scans, it is defined at the first point of the measured grid.

Check Scan

The Check Scan is used for system check purpose only and consists of a standard Zoom Scan (30x30x30mm) and a 1D Rotation Scan. The 1D Rotation Scan is anchored to the interpolated maximum of the preceding Zoom Scan. The extrapolated peak SAR value is extracted above the dipole center.

Validation Scan

The Validation Scan is used for system validation purpose only and consists of an extended Zoom Scan (50x30x30mm) and a 1D Rotation Scan. The 1D Rotation Scan is anchored to the interpolated maximum of the preceding Zoom Scan. The extrapolated peak SAR values are extracted above the dipole center and at 20mm transverse offset from the Zoom Scan.

Time Averaged SAR Scan

Time Averaged SAR applies to devices which can monitor and control the time averaged transmitted power in real-time over the period define in the applicable standards.

DUT Stability Scan

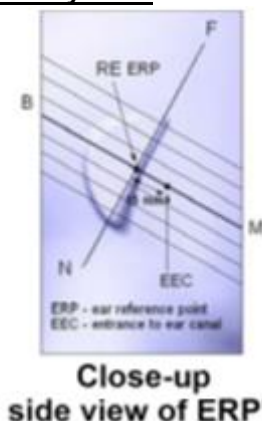

The Scan is the device can be scan bottom

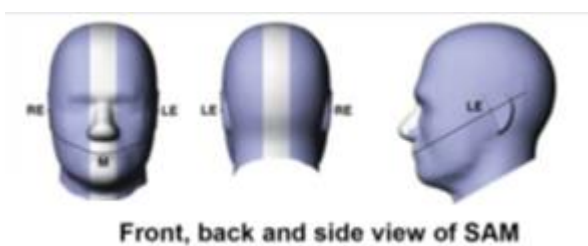

DUT Stability used to measure stability of the transmitting power. This scan enabled in the properties at the of the project

overview window. The user specifies also the scan duration and the measurement interval (time between 2 measurement points). In case the measurement interval is set to 0, measurement points will be acquired continuously.

One measurement point corresponds to measurement samples averaged over the integration time specified in Application Preferences Scan Settings. For instance, if the measurement interval is 5s and the integration time 0.5s, a measurement point will be acquired every 5s. This measurement point corresponds to instantaneous SAR readings averaged over 0.5s. The result shows the DUT power drift in %.

$$SAR_{drift(\%)} = 100 \cdot \left(\frac{SAR_{max} - SAR_{min}}{SAR_{avg}} \right) -$$

$SAR_{drift(\%)}$ is the SAR drift over the measured period in %

SAR_{min} is the minimum measured SAR value

SAR_{max} is the maximum measured SAR value

SAR_{avg} is the SAR value averaged over all measurement points

Device Reference Point

Definition of Reference Points

Ear Reference Point

Figure 6.2 shows the front, back and side views of the SAM Phantom. The point "M" is the reference point for the center of the mouth, "LE" is the left ear reference point (ERP), and "RE" is the right ERP. The ERPs are 15mm posterior to the entrance to the ear canal (EEC) along the B-M line (Back-Mouth), as shown in Figure 6.1. The plane passing through the two ear canals and M is defined as the Reference Plane. The line N-F (Neck-Front) is perpendicular to the reference plane and passing through the RE (or LE) is called the Reference Pivoting Line (see Figure 6.1). Line B-M is perpendicular to the N-F line. Both N-F and B-M lines are marked on the external phantom shell to facilitate handset positioning [5].

Two imaginary lines on the device need to be established: the vertical centerline and the horizontal line. The test device is placed in a normal operating position with the “test device reference point” located along the “vertical centerline” on the front of the device aligned to the “ear reference point” (See Fig. 6.3). The “test device reference point” is then located at the same level as the center of the ear reference point. The test device is positioned so that the “vertical centerline” is bisecting the front surface of the device at its top and bottom edges, positioning the “ear reference point” on the outer surface of both the left and right head phantoms on the ear reference point.

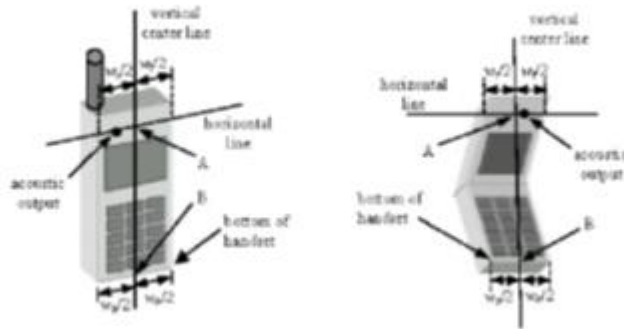

Handset Vertical Center & Horizontal Line Reference Points

Test Configuration – Positioning for Cheek/Touch

Position the device close to the surface of the phantom such that point A is on the (virtual) extension of the line passing through points RE and LE on the phantom (see Figure below), such that the plane defined by the vertical center line and the horizontal line of the device is approximately parallel to the sagittal plane of the phantom



Front, Side and Top View of Cheek/Touch Position

Translate the device towards the phantom along the line passing through RE and LE until the device touches the ear.

While maintaining the device in this plane, rotate it around the LE-RE line until the vertical centerline is in the plane normal to MB-NF including the line MB (called the reference plane).

Rotate the device around the vertical centerline until the device (horizontal line) is symmetrical with respect to the line NF.

While maintaining the vertical centerline in the reference plane, keeping point A on the line passing through RE and LE and maintaining the device contact with the ear, rotate the device about the line NF until any point on the device is in contact with a phantom point below the ear (cheek). See Figure below.

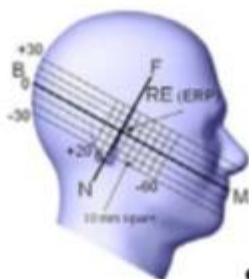

Side view w/ relevant markings

Test Configuration – Positioning for Ear/15° Tilt

With the test device aligned in the Cheek/Touch Position”:

1. While maintaining the orientation of the device, retract the device parallel to the reference plane far enough to enable a rotation of the device by 15 degrees.
2. Rotate the device around the horizontal line by 15 degrees.



Front, Side and Top View of Ear/15° Tilt Position

3. While maintaining the orientation of the device, move the device parallel to the reference plane until any part of the device touches the head. (In this position, point A is located on the line RE-LE). The tilted position is obtained when the contact is on the pinna. If the contact is at any location other than the pinna, the angle of the device shall be reduced. The tilted position is obtained when any part of the device is in contact with the ear as well as a second part of the device is in contact with the head (see Figure below).

Test Configuration – Body Worn Configuration

Body-worn operating configurations are tested with the accessories attached to the device and positioned against a flat phantom in a normal use configuration. A device with a headset output is tested with a headset connected to the device. Body dielectric parameters are used.

Accessories for Body-worn operation configurations are divided into two categories: those that do not contain metallic components and those that do contain metallic components. When multiple accessories that do not contain metallic components are supplied with the device, the device is tested with only the accessory that dictates the closest spacing to the body. Then, when multiple accessories that contain metallic components are supplied with the device, the device is tested with each accessory that contains a unique metallic component. If multiple accessories share an identical metallic component (i.e. the same metallic belt-clip used with different holsters with no other metallic components) only the accessory that dictates the closest spacing to the body is tested.

Body-worn accessories may not always be supplied or available as options for some devices intended to be authorized for body-worn use. In this case, a test configuration where a separation distance between the back of the device and the flat phantom is used. All test position spacing are documented.

Transmitters that are designed to operate in front of a person’s face, as in push-to-talk configurations, are tested for SAR compliance with the front of the device positioned to face the flat phantom. For devices that are carried next to the body such as a shoulder, waist or chest-worn transmitters, SAR compliance is tested with the accessory(ies), including headsets and microphones, attached to the device and positioned against a flat phantom in a normal use configuration.

In all cases SAR measurements are performed to investigate the worst-case positioning. Worst-case positioning is then documented and used to perform Body SAR testing.

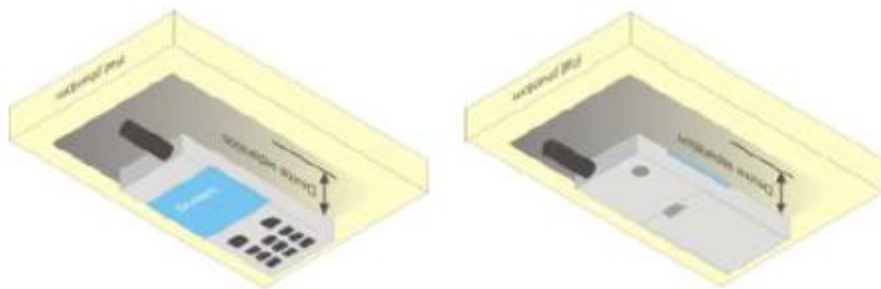

Liquid Depth

For SAR measurement of the field distribution inside the phantom, the phantom must be filled with homogeneous tissue simulating liquid to a depth of at least 15 cm. For head SAR testing, the liquid height from the ear reference point (ERP) of the phantom to the liquid top surface is larger than 15 cm. For body SAR testing, the liquid height from the center of the flat phantom to the liquid top surface is larger than 15 cm. The nominal dielectric values of the tissue simulating liquids in the phantom and the tolerance of 5% are listed in Table-3.1.

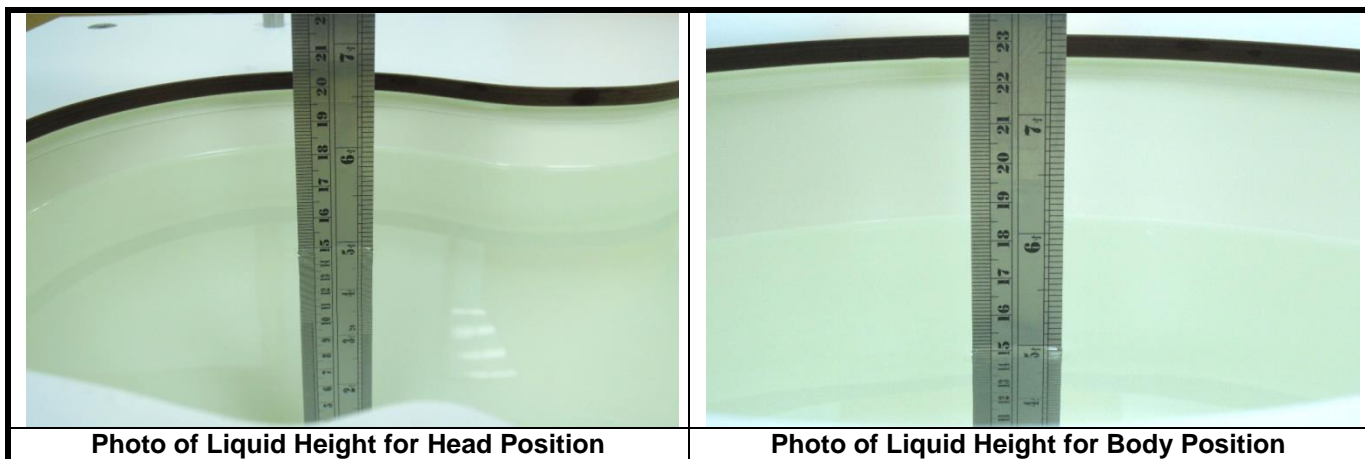

The dielectric properties of the tissue simulating liquids are defined in IEC 62209-1 and IEC 62209-2. The dielectric properties of the tissue simulating liquids were verified prior to the SAR evaluation using a dielectric assessment kit and a network analyzer.

Table-3.1 Targets of Tissue Simulating Liquid

Target Frequency	Head		Body	
	ϵ_r	σ (S/m)	ϵ_r	σ (S/m)
150	52.3	0.76	61.9	0.80
300	45.3	0.87	58.2	0.92
450	43.5	0.87	56.7	0.94
835	41.5	0.90	53.19	0.97
900	41.5	0.97	55.0	1.05
915	41.5	0.98	55.0	1.06
1450	40.5	1.20	54.0	1.30
1610	40.3	1.29	53.8	1.40
1800-2000	40.0	1.40	53.3	1.52
2450	39.2	1.80	52.7	1.95
3000	38.5	2.40	52.0	2.73
5800	35.3	5.27	48.2	6.00

The following table gives the recipes for tissue simulating liquids.

Table-3.2 Recipes of Tissue Simulating Liquid

Tissue Type	Bactericide	DGBE	HEC	NaCl	Sucrose	Triton X-100	Water	Diethylene Glycol Mono-hexylether
H750	0.2	-	0.2	1.5	56.0	-	42.1	-
H835	0.2	-	0.2	1.5	57.0	-	41.1	-
H900	0.2	-	0.2	1.4	58.0	-	40.2	-
H1450	-	43.3	-	0.6	-	-	56.1	-
H1640	-	45.8	-	0.5	-	-	53.7	-
H1750	-	47.0	-	0.4	-	-	52.6	-
H1800	-	44.5	-	0.3	-	-	55.2	-
H1900	-	44.5	-	0.2	-	-	55.3	-
H2000	-	44.5	-	0.1	-	-	55.4	-
H2300	-	44.9	-	0.1	-	-	55.0	-
H2450	-	45.0	-	0.1	-	-	54.9	-
H2600	-	45.1	-	0.1	-	-	54.8	-
H3500	-	8.0	-	0.2	-	20.0	71.8	-
H5G	-	-	-	-	-	17.2	65.5	17.3

3.3 SAR System Verification

The relative permittivity and conductivity of the test liquid should be measured before the system verification and the measured liquid parameters must be entered in the DASY6 software. If the measured values differ from the target liquid parameters in the corresponding standards for testing compliance, the liquid composition should be adjusted. If the system verification is performed with slightly different (measured) liquid parameters, the expected SAR will also be different.

The reference dipole source must be placed beneath the flat phantom or the flat section of the SAM Twin Phantom with the correct distance spacer in place. The distance spacer should touch the phantom surface with a light pressure at the reference marking (little cross) and be oriented parallel to the long side of the phantom. Accurate positioning is not necessary, since the system will search for the peak SAR location, except that the dipole arms should be parallel to the surface. The device holder for mobile phones can be left in place but should be rotated away from the dipole.

The forward power into the reference dipole source at the SMA connector should be determined as accurately as possible. The following section describe the recommended setup to measure the dipole input power. The actual dipole input power level can be between 20mW and several watts. The result can later be normalized to any power level. It is strongly recommended to note the actual power level used; otherwise this crucial information for later reference is lost.

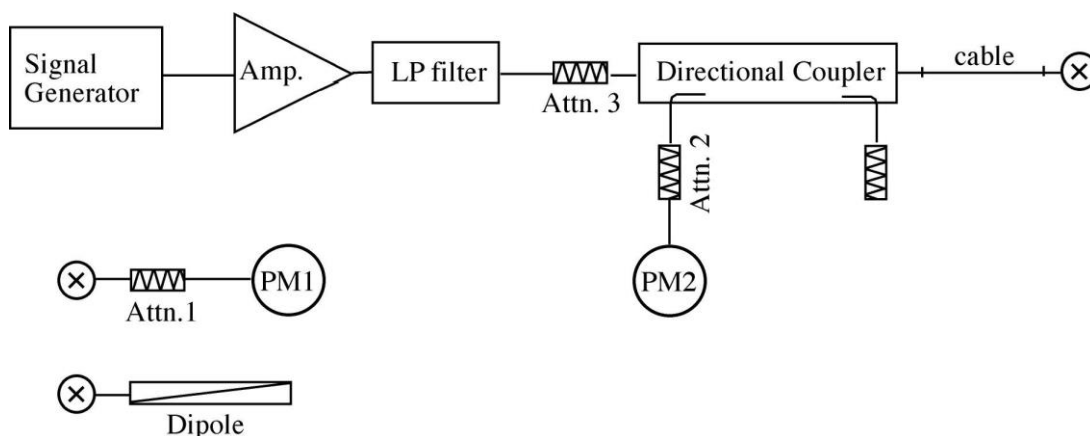

The figure shows the recommended setup. The PM1 (incl. Att1) measures the forward power at the end of the cable where the dipole would be connected. The signal generator is adjusted for the desired forward power at the dipole connector and the power meter PM2 is read at that level. After connecting the cable to the dipole, the signal generator is readjusted for the same reading at power meter PM2. If the signal generator does not allow a setting in 0.01dB steps, the remaining difference at PM2 must be noted and considered in the normalization of the system check results.

4.1 EUT Configuration and Setting

<Considerations Related to WLAN for Setup and Testing>

In general, various vendor specific external test software and chipset based internal test modes are typically used for SAR measurement. These chipset based test mode utilities are generally hardware and manufacturer dependent, and often include substantial flexibility to reconfigure or reprogram a device. A Wi-Fi device must be configured to transmit continuously at the required data rate, channel bandwidth and signal modulation, using the highest transmission duty factor supported by the test mode tools for SAR measurement. The test frequencies established using test mode must correspond to the actual channel frequencies.

This device has installed WLAN engineering testing software which can provide continuous transmitting RF Signal. During WLAN SAR testing, this device was operated to transmit continuously at the maximum transmission duty with specified transmission mode, operating frequency, lowest data rate, and maximum output power.

<Considerations Related to Bluetooth for Setup and Testing>

This device has installed Bluetooth engineering testing software which can provide continuous transmitting RF signal. During Bluetooth SAR testing, this device was operated to transmit continuously at the maximum transmission duty with specified transmission mode, operating frequency, lowest data rate, and maximum output power.

4.2 EUT Testing Position

This variant report is made for verification. All the worst SAR configurations specified in the original SAR report was repeated and verified to ensure the device remains compliant.

According to technical standards, handsets are tested for SAR compliance in head and body-worn accessory described in the following subsections.

According handsets compliance accessory



Front, Side and Top View of Cheek/Touch Position

described in

to technical standards, are tested for SAR in head, body-worn and other use configurations the following subsections.

Since this tablet has receiver and it can be used in close proximity to the ear as handset. According to technical standards, this tablet is tested for SAR compliance in head described in the following subsections.

Test Configuration – Positioning for Cheek/Touch

Position the device close to the surface of the phantom such that point A is on the (virtual) extension of the line passing through points RE and LE on the phantom (see Figure below), such that the plane defined by the vertical center line and the horizontal line of the device is approximately parallel to the sagittal plane of the phantom

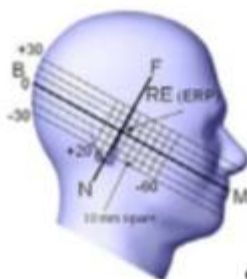

Side view w/ relevant markings

Translate the device towards the phantom along the line passing through RE and LE until the device touches the ear.

While maintaining the device in this plane, rotate it around the LE-RE line until the vertical centerline is in the plane normal to MB-NF including the line MB (called the reference plane).

Rotate the device around the vertical centerline until the device (horizontal line) is symmetrical with respect to the line NF.

While maintaining the vertical centerline in the reference plane, keeping point A on the line passing through RE and LE and maintaining the device contact with the ear, rotate the device about the line NF until any point on the device is in contact with a phantom point below the ear (cheek). See Figure below.

Test Configuration – Positioning for Ear/15° Tilt

With the test device aligned in the Cheek/Touch Position”:

1. While maintaining the orientation of the device, retract the device parallel to the reference plane far enough to enable a rotation of the device by 15 degrees.
2. Rotate the device around the horizontal line by 15 degrees.



Front, Side and Top View of Ear/15° Tilt Position

3. While maintaining the orientation of the device, move the device parallel to the reference plane until any part of the device touches the head. (In this position, point A is located on the line RE-LE). The tilted position is obtained when the contact is on the pinna. If the contact is at any location other than the pinna, the angle of the device shall be reduced. The tilted position is obtained when any part of the device is in contact with the ear as well as a second part of the device is in contact with the head (see Figure below).

Test Configuration – Body Worn Configuration

Body-worn operating configurations are tested with the accessories attached to the device and positioned against a flat phantom in a normal use configuration. A device with a headset output is tested with a headset connected to the device. Body dielectric parameters are used.

Accessories for Body-worn operation configurations are divided into two categories: those that do not contain metallic components and those that do contain metallic components. When multiple accessories that do not contain metallic components are supplied with the device, the device is tested with only the accessory that dictates the closest spacing to the body. Then, when multiple accessories that contain metallic components are supplied with the device, the device is tested with each accessory that contains a unique metallic component. If multiple accessories share an identical metallic component (i.e. the same metallic belt-clip used with different holsters with no other metallic components) only the accessory that dictates the closest spacing to the body is tested.

Body-worn accessories may not always be supplied or available as options for some devices intended to be authorized for body-worn use. In this case, a test configuration where a separation distance between the back of the device and the flat phantom is used. All test position spacing are documented.

Transmitters that are designed to operate in front of a person’s face, as in push-to-talk configurations, are tested for SAR compliance with the front of the device positioned to face the flat phantom. For devices that are carried next to the body such as a shoulder, waist or chest-worn transmitters, SAR compliance is tested with the accessory(ies), including headsets and microphones, attached to the device and positioned against a flat phantom in a normal use configuration.

In all cases SAR measurements are performed to investigate the worst-case positioning. Worst-case positioning is then documented and used to perform Body SAR testing.

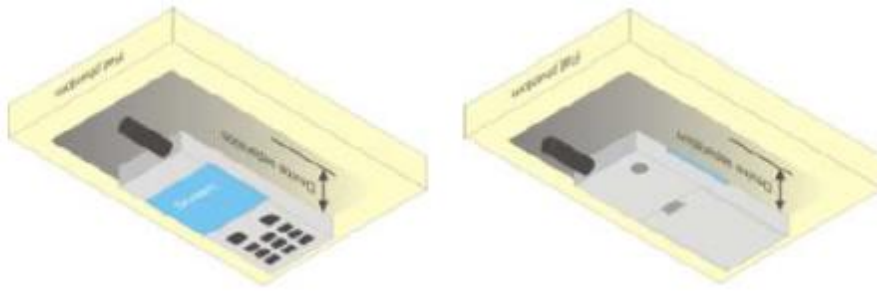

Antenna Location

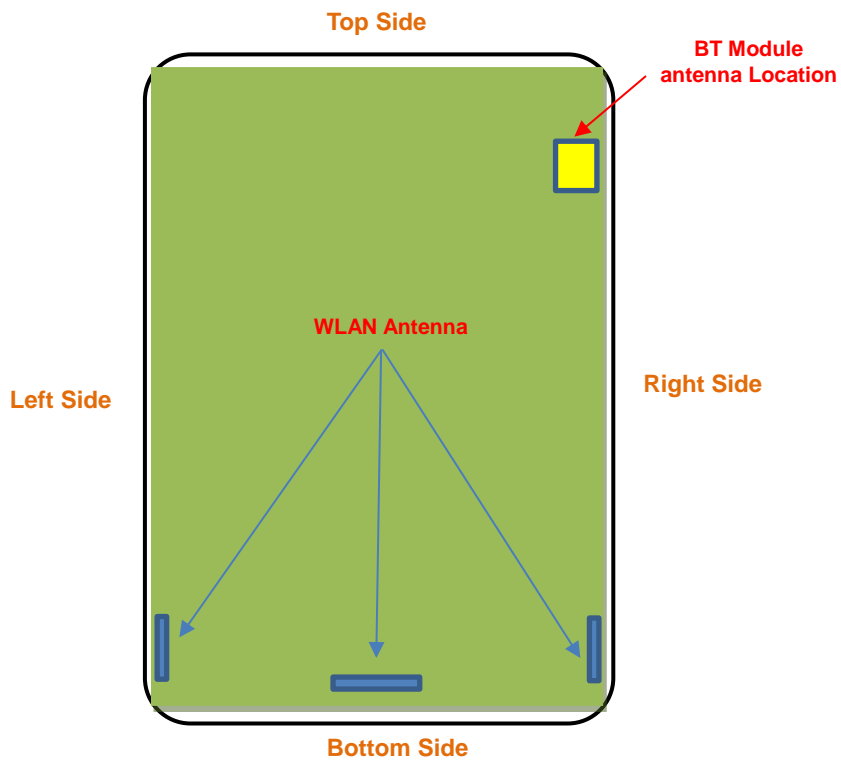

The separation distance for antenna to edge:

Antenna	To Top Side (mm)	To Bottom Side (mm)	To Left Side (mm)	To Right Side (mm)	To Front Side (mm)	To Rear Side (mm)
WLAN	171	11	8	9	5	3
BT	45	150	90	15	10	40

Note:

For PC card setup, SAR evaluation was tested in one position. It is the bottom of laptop PC directly against the flat phantom. In this position, the air gap between the EUT and the phantom is **5 mm**.

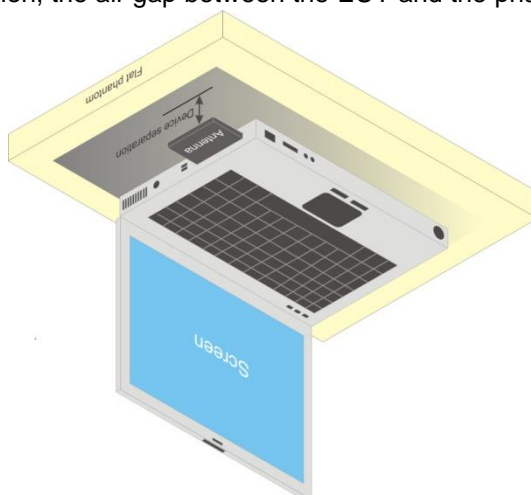

Fig-4.1 Illustration for Lap-touching Position

For USB dongle transmitter, SAR evaluation was tested for all USB orientations illustrated as below with a device-to-phantom separation distance of **5 mm**. Also, the tip of USB dongle was tested as well at the specified separation distance perpendicular to the phantom.

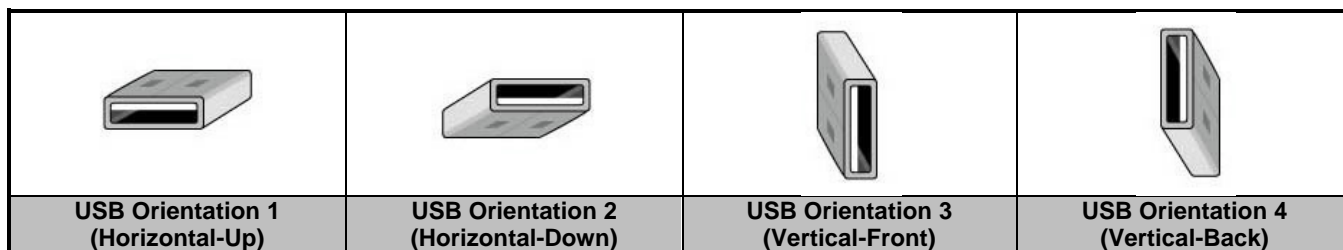

Fig-4.2 Illustration for USB Connector Orientations

4.2.1 Face Exposure Conditions

For two-way radio that is held at a distance from the face of the user when transmitting. The device under test shall be positioned at the distance to the phantom surface that corresponds to the intended use as specified by the manufacturer in the user instructions. If the intended use is not specified, a separation distance of 25 mm between the phantom surface and the device shall be used.

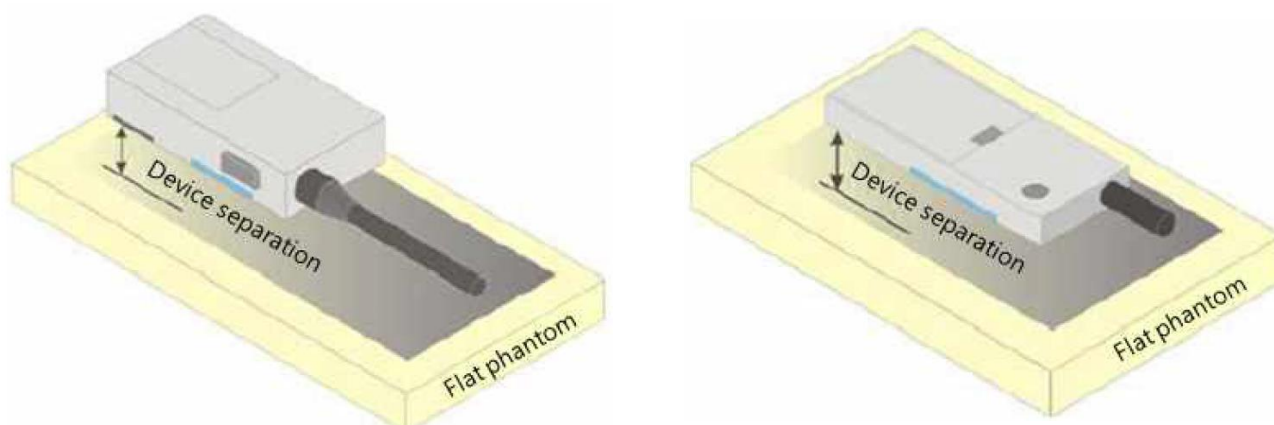

Fig-4.3 Illustration for Two-way Radio Setup

For wireless-enabled video camera that can send data to a network or other device, the device whose intended use requires a separation distance from the user (e.g., device with a viewing screen), this shall be positioned at the distance to the phantom surface that corresponds to the intended use as specified by the manufacturer in the user instructions. If the intended use is not specified, a separation distance of 25 mm between the phantom surface and the device shall be used. The device whose intended use requires the user's face to be in contact with the device (e.g., device with an optical viewfinder), this shall be placed directly against the phantom.

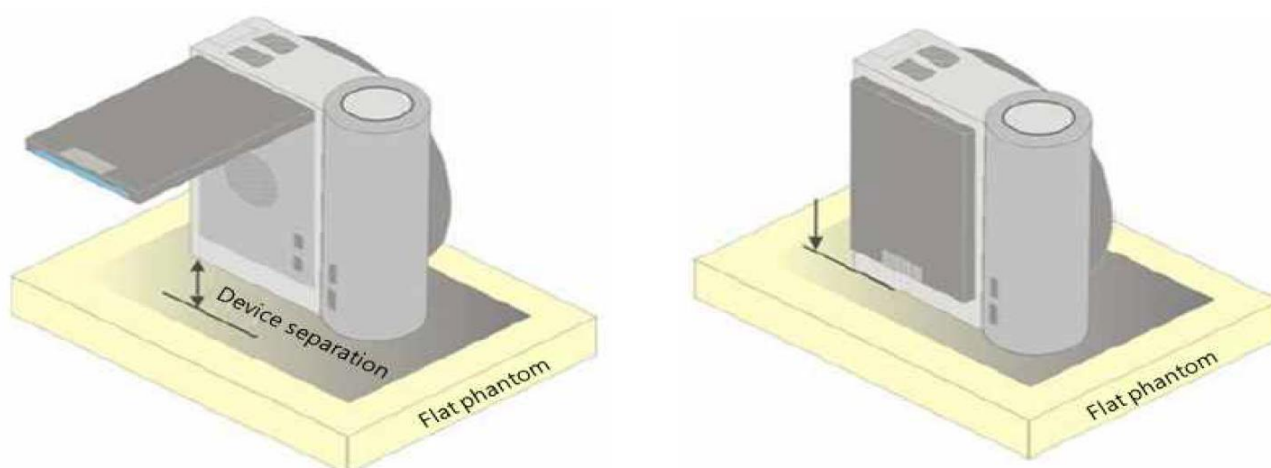

Fig-4.4 Illustration for Wireless-enabled Video Camera Setup

For wireless-enabled digital camera that can send data to a network or other device, the device whose intended use requires a separation distance from the user (e.g., device with a viewing screen), this shall be positioned at the distance to the phantom surface that corresponds to the intended use as specified by the manufacturer in the user instructions. If the intended use is not specified, a separation distance of 25 mm between the phantom surface and

the device shall be used. The device whose intended use requires the user's face to be in contact with the device (e.g., device with an optical viewfinder), this shall be placed directly against the phantom.

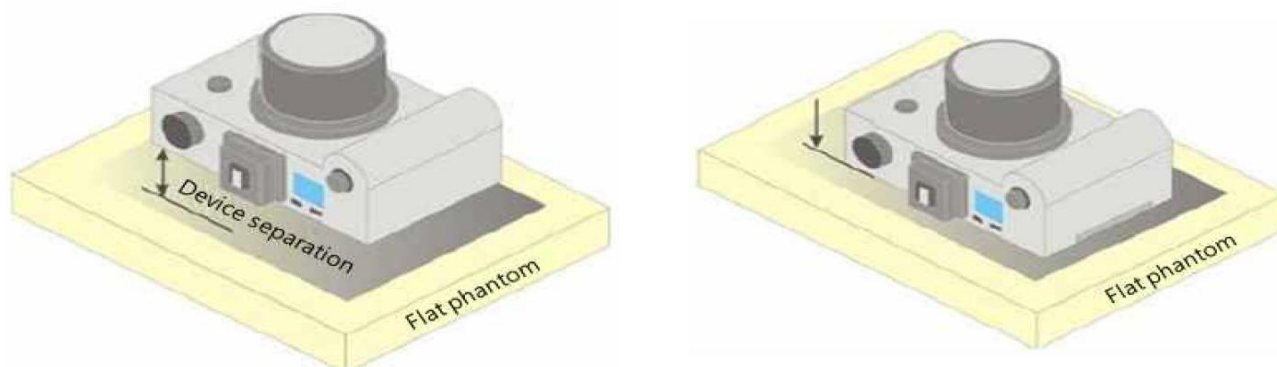

Fig-4.5 Illustration for Wireless-enabled Digital Camera Setup

4.2.2 Limbs Exposure Conditions

For wireless watch whose intended use includes being strapped to the arm or leg of the user while transmitting (except in idle mode), the strap shall be opened so that it is divided into two parts as shown in below. The device shall be positioned directly against the phantom surface with the strap straightened as much as possible and the back of the device towards the phantom. If the strap cannot normally be opened to allow placing in direct contact with the phantom surface, it may be necessary to break the strap of the device but ensuring to not damage the antenna.

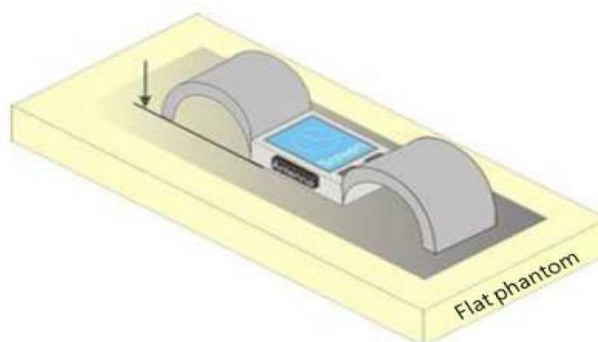

Fig-4.6 Illustration for Wireless Watch Setup

4.3 Tissue Verification

The measuring results for tissue simulating liquid are shown as below.

Tissue Type	Frequency (MHz)	Liquid Temp. (°C)	Measured Conductivity (σ)	Measured Permittivity (ϵ_r)	Target Conductivity (σ)	Target Permittivity (ϵ_r)	Conductivity Deviation (%)	Permittivity Deviation (%)	Test Date
Body	2450	23	2.01	53.1	1.95	52.7	3.08	0.76	09/10/2019
Body	5250	23	5.39	48.2	5.34	48.9	0.94	-1.43	09/10/2019
Body	5600	23	5.89	47.5	5.88	48.5	0.17	-2.06	09/10/2019
Body	5750	23	6.11	47.2	5.94	48.3	2.86	-2.28	09/10/2019

Note:

1. The dielectric properties of the tissue simulating liquid must be measured within 24 hours before the SAR testing and within $\pm 5\%$ of the target values. Liquid temperature during the SAR testing must be within ± 2 °C.
2. Since the maximum deviation of dielectric properties of the tissue simulating liquid is within 5%, SAR correction is evaluated in the measurement uncertainty shown on section 6 of this report.

4.4 System Verification

The measuring results for system check are shown as below.

Test Date	Frequency (MHz)	1W Target SAR-1g (W/kg)	Measured SAR-1g (W/kg)	Normalized to 1W SAR-1g (W/kg)	Deviation (%)
09/10/2019	2450	51.4	5.06	50.6	-1.56
09/10/2019	5250	76.4	7.53	75.3	-1.44
09/10/2019	5600	78.5	7.78	77.8	-0.89
09/10/2019	5750	74.8	7.39	73.9	-1.20

Note:

Comparing to the reference SAR value provided by SPEAG, the validation data should be within its specification of 10 %. The result indicates the system check can meet the variation criterion and the plots can be referred to Appendix A of this report.

4.5 Maximum Output Power

4.5.1 Measured Conducted Power Result

Duty factor of 100% was used for SAR evaluation

The maximum conducted average power (Unit: dBm) including tune-up tolerance is shown as below.

BT&BLE

Type	Test mode	Freq (MHz)	CH	Power (dBm)
Output Power	BDR	2402	Low	7.51
		2441	Mid	7.48
		2480	High	7.20
	EDR	2402	Low	6.92
		2441	Mid	7.02
		2480	High	7.11
	BLE	2402	Low	7.23
		2440	Mid	7.66
		2480	High	7.35

WLAN_2.4G

Type	Test mode	Freq (MHz)	CH	Power (dBm)
Output Power	802.11b	2412	Low	16.76
		2437	Mid	16.82
		2462	High	16.75
	802.11g	2412	Low	16.83
		2437	Mid	16.56
		2462	High	16.84
	802.11n-20M	2412	Low	16.77
		2437	Mid	16.78
		2462	High	16.74
	802.11n-40M	2422	Low	16.77
		2437	Mid	16.82
		2452	High	16.88

WLAN_5G

Type	Test mode	Freq (MHz)	CH	Power (dBm)
Output Power	802.11a	5180	Low	14.65
		5200	Mid	14.89
		5240	High	14.51
		5260	Low	14.67
		5280	Mid	14.75
		5320	High	14.88
		5500	Low	14.92
		5580	Mid	14.65
		5700	High	14.84
		5745	Low	14.81
		5785	Mid	14.66
		5825	High	14.87
	802.11n-20M	5180	Low	13.77
		5200	Mid	13.81
		5240	High	13.79
		5260	Low	13.88
		5280	Mid	13.66
		5320	High	13.71
		5500	Low	13.81
		5580	Mid	13.59
		5700	High	13.92
		5745	Low	13.76
		5785	Mid	13.87
		5825	High	13.88
	802.11n-40M	5190	Low	12.76
		5230	High	12.98
		5270	Low	12.65
		5310	High	12.67
		5510	Low	12.68
		5550	Mid	12.98
		5670	High	12.67
		5755	Low	12.88
		5795	High	12.79
802.11ac-80M	5210	Low	12.77	
	5290	High	12.69	
	5530	Low	12.92	
	5610	High	12.77	
	5775	Mid	12.84	

Note:

1. SAR testing was performed on the maximum frame-averaged power mode.

4.6 SAR Testing Results

4.6.1 SAR Results for Body Exposure Condition (Separation Distance is 0 mm Gap)

WLAN_2.4G

Freq Band	Freq (MHz)	Position	Distance	Rated Max Power (dBm)	Measured Output Power (dBm)	Raw SAR 1g(W/kg)	Crest factor	Power Drift (dB)	Scaled SAR (Tune-up & Duty Cycle) (W/kg)	1g SAR Limit (W/kg)
802.11-b	2412	Left side	0mm	17	16.76	0.019	1	0.16	0.020	1.6
	2437	Left side	0mm	17	16.82	0.021	1	0	0.022	1.6
	2462	Left side	0mm	17	16.75	0.022	1	0.21	0.023	1.6
802.11-g	2412	Left side	0mm	17	16.83	0.02	1	0	0.021	1.6
	2437	Left side	0mm	17	16.56	0.02	1	0	0.022	1.6
	2462	Left side	0mm	17	16.84	0.053	1	0	0.055	1.6
802.11-n	2412	Left side	0mm	17	16.77	0.02	1	0.53	0.021	1.6
	2437	Left side	0mm	17	16.78	0.019	1	0	0.020	1.6
	2462	Left side	0mm	17	16.74	0.02	1	0	0.021	1.6
802.11-n40	2422	Left side	0mm	17	16.77	0.02	1	0	0.021	1.6
	2437	Left side	0mm	17	16.82	0.02	1	0	0.021	1.6
	2452	Left side	0mm	17	16.88	0.021	1	0	0.021	1.6
802.11-b	2412	Right side	0mm	17	16.76	0.019	1	0	0.020	1.6
	2437	Right side	0mm	17	16.82	0.017	1	0	0.018	1.6
	2462	Right side	0mm	17	16.75	0.018	1	0	0.019	1.6
802.11-g	2412	Right side	0mm	17	16.83	0.017	1	0.13	0.018	1.6
	2437	Right side	0mm	17	16.56	0.017	1	0	0.019	1.6
	2462	Right side	0mm	17	16.84	0.018	1	0.16	0.019	1.6
802.11-n	2412	Right side	0mm	17	16.77	0.017	1	0	0.018	1.6
	2437	Right side	0mm	17	16.78	0.017	1	0	0.018	1.6
	2462	Right side	0mm	17	16.74	0.018	1	0	0.019	1.6
802.11-n40	2422	Right side	0mm	17	16.77	0.018	1	0	0.019	1.6
	2437	Right side	0mm	17	16.82	0.019	1	0	0.020	1.6
	2452	Right side	0mm	17	16.88	0.017	1	0	0.017	1.6



Freq Band	Freq (MHz)	Position	Distance	Rated Max Power (dBm)	Measured Output Power (dBm)	Raw SAR 1g(W/kg)	Crest factor	Power Drift (dB)	Scaled SAR (Tune-up & Duty Cycle) (W/kg)	1g SAR Limit (W/kg)
802.11-b	2412	Front side	0mm	17	16.76	0.008	1	0	0.008	1.6
	2437	Front side	0mm	17	16.82	0.01	1	0.2	0.010	1.6
	2462	Front side	0mm	17	16.75	0.005	1	0	0.005	1.6
802.11-g	2412	Front side	0mm	17	16.83	0.008	1	0	0.008	1.6
	2437	Front side	0mm	17	16.56	0.007	1	0	0.008	1.6
	2462	Front side	0mm	17	16.84	0.009	1	0	0.009	1.6
802.11-n	2412	Front side	0mm	17	16.77	0.007	1	0	0.007	1.6
	2437	Front side	0mm	17	16.78	0.006	1	0	0.006	1.6
	2462	Front side	0mm	17	16.74	0.008	1	0	0.008	1.6
802.11-n40	2422	Front side	0mm	17	16.77	0.007	1	0	0.007	1.6
	2437	Front side	0mm	17	16.82	0.008	1	0	0.008	1.6
	2452	Front side	0mm	17	16.88	0.009	1	0	0.009	1.6
802.11-b	2412	Back side	0mm	17	16.76	0.009	1	1.15	0.010	1.6
	2437	Back side	0mm	17	16.82	0.01	1	0	0.010	1.6
	2462	Back side	0mm	17	16.75	0.01	1	0	0.011	1.6
802.11-g	2412	Back side	0mm	17	16.83	0.008	1	0	0.008	1.6
	2437	Back side	0mm	17	16.56	0.009	1	0	0.010	1.6
	2462	Back side	0mm	17	16.84	0.009	1	0	0.009	1.6
802.11-n	2412	Back side	0mm	17	16.77	0.008	1	0	0.008	1.6
	2437	Back side	0mm	17	16.78	0.008	1	0	0.008	1.6
	2462	Back side	0mm	17	16.74	0.008	1	0.28	0.008	1.6
802.11-n40	2422	Back side	0mm	17	16.77	0.008	1	0	0.008	1.6
	2437	Back side	0mm	17	16.82	0.009	1	0.32	0.009	1.6
	2452	Back side	0mm	17	16.88	0.009	1	0.21	0.009	1.6



Freq Band	Freq (MHz)	Position	Distance	Rated Max Power (dBm)	Measured Output Power (dBm)	Raw SAR 1g(W/kg)	Crest factor	Power Drift (dB)	Scaled SAR (Tune-up & Duty Cycle) (W/kg)	1g SAR Limit (W/kg)
802.11-b	2412	Bottom side	0mm	17	16.76	0.033	1	0	0.035	1.6
	2437	Bottom side	0mm	17	16.82	0.033	1	0	0.034	1.6
	2462	Bottom side	0mm	17	16.75	0.035	1	0.02	0.037	1.6
802.11-g	2412	Bottom side	0mm	17	16.83	0.034	1	0.01	0.035	1.6
	2437	Bottom side	0mm	17	16.56	0.034	1	0.01	0.038	1.6
	2462	Bottom side	0mm	17	16.84	0.035	1	0.14	0.036	1.6
802.11-n	2412	Bottom side	0mm	17	16.77	0.033	1	0	0.035	1.6
	2437	Bottom side	0mm	17	16.78	0.034	1	0	0.036	1.6
	2462	Bottom side	0mm	17	16.74	0.035	1	0	0.037	1.6
802.11-n40	2422	Bottom side	0mm	17	16.77	0.033	1	0	0.035	1.6
	2437	Bottom side	0mm	17	16.82	0.035	1	0.04	0.036	1.6
	2452	Bottom side	0mm	17	16.88	0.035	1	0	0.036	1.6



WLAN_5G

Freq Band	Freq (MHz)	Position	Distance	Rated Max Power (dBm)	Measured Output Power (dBm)	Raw SAR 1g(W/kg)	Crest factor	Power Drift (dB)	Scaled SAR (Tune-up & Duty Cycle) (W/kg)	1g SAR Limit (W/kg)
802.11a	5180	Left side	0mm	15	14.65	0.725	1	0	0.786	1.6
	5200	Left side	0mm	15	14.89	0.725	1	0	0.744	1.6
	5240	Left side	0mm	15	14.51	0.742	1	0	0.831	1.6
	5260	Left side	0mm	15	14.67	0.748	1	0	0.807	1.6
	5280	Left side	0mm	15	14.75	0.763	1	0	0.808	1.6
	5320	Left side	0mm	15	14.88	0.765	1	0	0.786	1.6
	5500	Left side	0mm	15	14.92	0.918	1	0	0.935	1.6
	5580	Left side	0mm	15	14.65	0.869	1	0	0.942	1.6
	5700	Left side	0mm	15	14.84	0.872	1	0	0.905	1.6
	5745	Left side	0mm	15	14.81	0.267	1	0	0.279	1.6
	5785	Left side	0mm	15	14.66	0.288	1	0	0.311	1.6
	5825	Left side	0mm	15	14.87	0.926	1	0	0.954	1.6
802.11n	5180	Left side	0mm	14	13.77	0.839	1	0	0.885	1.6
	5200	Left side	0mm	14	13.81	0.728	1	0	0.761	1.6
	5240	Left side	0mm	14	13.79	0.742	1	0	0.779	1.6
	5260	Left side	0mm	14	13.88	0.778	1	0	0.800	1.6
	5280	Left side	0mm	14	13.66	0.774	1	0	0.837	1.6
	5320	Left side	0mm	14	13.71	0.802	1	0	0.857	1.6
	5500	Left side	0mm	14	13.81	0.815	1	0	0.851	1.6
	5580	Left side	0mm	14	13.59	0.865	1	0	0.951	1.6
	5700	Left side	0mm	14	13.92	0.849	1	0	0.865	1.6
	5745	Left side	0mm	14	13.76	0.849	1	0	0.897	1.6
	5785	Left side	0mm	14	13.87	0.821	1	0	0.846	1.6
	5825	Left side	0mm	14	13.88	0.842	1	0	0.866	1.6
802.11n-HT40	5190	Left side	0mm	13	12.76	0.655	1	0	0.692	1.6
	5230	Left side	0mm	13	12.98	0.66	1	0	0.663	1.6
	5270	Left side	0mm	13	12.65	0.712	1	0	0.772	1.6
	5310	Left side	0mm	13	12.67	0.702	1	0	0.757	1.6
	5510	Left side	0mm	13	12.68	0.838	1	0.01	0.902	1.6
	5550	Left side	0mm	13	12.98	0.898	1	0	0.902	1.6
	5670	Left side	0mm	13	12.67	0.913	1	0.05	0.985	1.6
	5755	Left side	0mm	13	12.88	0.911	1	0	0.937	1.6
	5795	Left side	0mm	13	12.79	0.883	1	0	0.927	1.6
802.11ac-VHT80	5210	Left side	0mm	13	12.77	0.778	1	0	0.820	1.6
	5290	Left side	0mm	13	12.69	0.774	1	0	0.831	1.6
	5530	Left side	0mm	13	12.92	0.748	1	0	0.762	1.6
	5610	Left side	0mm	13	12.77	0.868	1	0	0.915	1.6
	5775	Left side	0mm	13	12.84	0.911	1	0	0.945	1.6



Freq Band	Freq (MHz)	Position	Distance	Rated Max Power (dBm)	Measured Output Power (dBm)	Raw SAR 1g(W/kg)	Crest factor	Power Drift (dB)	Scaled SAR (Tune-up & Duty Cycle) (W/kg)	1g SAR Limit (W/kg)
802.11a	5180	Right side	0mm	15	14.65	0.608	1	0.05	0.659	1.6
	5200	Right side	0mm	15	14.89	0.616	1	0	0.632	1.6
	5240	Right side	0mm	15	14.51	0.636	1	0.01	0.712	1.6
	5260	Right side	0mm	15	14.67	0.639	1	0	0.689	1.6
	5280	Right side	0mm	15	14.75	0.643	1	0.04	0.681	1.6
	5320	Right side	0mm	15	14.88	0.661	1	0.02	0.680	1.6
	5500	Right side	0mm	15	14.92	0.781	1	0	0.796	1.6
	5580	Right side	0mm	15	14.65	0.823	1	0	0.892	1.6
	5700	Right side	0mm	15	14.84	0.809	1	0.02	0.839	1.6
	5745	Right side	0mm	15	14.81	0.841	1	0	0.879	1.6
	5785	Right side	0mm	15	14.66	0.857	1	0	0.927	1.6
	5825	Right side	0mm	15	14.87	0.879	1	0	0.906	1.6
802.11n	5180	Right side	0mm	14	13.77	0.614	1	0.01	0.647	1.6
	5200	Right side	0mm	14	13.81	0.63	1	0.02	0.658	1.6
	5240	Right side	0mm	14	13.79	0.643	1	0.01	0.675	1.6
	5260	Right side	0mm	14	13.88	0.662	1	0	0.681	1.6
	5280	Right side	0mm	14	13.66	0.788	1	0	0.852	1.6
	5320	Right side	0mm	14	13.71	0.814	1	0	0.870	1.6
	5500	Right side	0mm	14	13.81	0.781	1	0.01	0.816	1.6
	5580	Right side	0mm	14	13.59	0.823	1	0	0.904	1.6
	5700	Right side	0mm	14	13.92	0.809	1	0.02	0.824	1.6
	5745	Right side	0mm	14	13.76	0.814	1	0	0.860	1.6
	5785	Right side	0mm	14	13.87	0.867	1	0	0.893	1.6
	5825	Right side	0mm	14	13.88	0.889	1	0	0.914	1.6
802.11n-HT40	5190	Right side	0mm	13	12.76	0.612	1	0.03	0.647	1.6
	5230	Right side	0mm	13	12.98	0.629	1	0	0.632	1.6
	5270	Right side	0mm	13	12.65	0.798	1	0	0.865	1.6
	5310	Right side	0mm	13	12.67	0.662	1	0	0.714	1.6
	5510	Right side	0mm	13	12.68	0.787	1	0	0.847	1.6
	5550	Right side	0mm	13	12.98	0.812	1	0	0.816	1.6
	5670	Right side	0mm	13	12.67	0.839	1	0	0.905	1.6
	5755	Right side	0mm	13	12.88	0.821	1	0.02	0.844	1.6
	5795	Right side	0mm	13	12.79	0.809	1	0	0.849	1.6
802.11ac-VHT80	5210	Right side	0mm	13	12.77	0.842	1	0	0.888	1.6
	5290	Right side	0mm	13	12.69	0.833	1	0	0.895	1.6
	5530	Right side	0mm	13	12.92	0.798	1	0	0.813	1.6
	5610	Right side	0mm	13	12.77	0.788	1	0	0.831	1.6
	5775	Right side	0mm	13	12.84	0.774	1	0	0.803	1.6



Freq Band	Freq (MHz)	Position	Distance	Rated Max Power (dBm)	Measured Output Power (dBm)	Raw SAR 1g(W/kg)	Crest factor	Power Drift (dB)	Scaled SAR (Tune-up & Duty Cycle) (W/kg)	1g SAR Limit (W/kg)
802.11a	5180	Front side	0mm	15	14.65	0.032	1	0.92	0.035	1.6
	5200	Front side	0mm	15	14.89	0.038	1	0.05	0.039	1.6
	5240	Front side	0mm	15	14.51	0.033	1	0	0.037	1.6
	5260	Front side	0mm	15	14.67	0.036	1	0	0.039	1.6
	5280	Front side	0mm	15	14.75	0.034	1	1.14	0.036	1.6
	5320	Front side	0mm	15	14.88	0.036	1	0	0.037	1.6
	5500	Front side	0mm	15	14.92	0.041	1	0.78	0.042	1.6
	5580	Front side	0mm	15	14.65	0.043	1	0	0.047	1.6
	5700	Front side	0mm	15	14.84	0.043	1	1.18	0.045	1.6
	5745	Front side	0mm	15	14.81	0.043	1	0	0.045	1.6
	5785	Front side	0mm	15	14.66	0.043	1	0	0.047	1.6
	5825	Front side	0mm	15	14.87	0.047	1	1.11	0.048	1.6
802.11n	5180	Front side	0mm	14	13.77	0.04	1	0	0.042	1.6
	5200	Front side	0mm	14	13.81	0.044	1	0.99	0.046	1.6
	5240	Front side	0mm	14	13.79	0.042	1	0	0.044	1.6
	5260	Front side	0mm	14	13.88	0.048	1	0	0.049	1.6
	5280	Front side	0mm	14	13.66	0.044	1	0	0.048	1.6
	5320	Front side	0mm	14	13.71	0.041	1	0	0.044	1.6
	5500	Front side	0mm	14	13.81	0.039	1	0.11	0.041	1.6
	5580	Front side	0mm	14	13.59	0.04	1	0	0.044	1.6
	5700	Front side	0mm	14	13.92	0.041	1	0	0.042	1.6
	5745	Front side	0mm	14	13.76	0.049	1	0	0.052	1.6
	5785	Front side	0mm	14	13.87	0.04	1	1.18	0.041	1.6
	5825	Front side	0mm	14	13.88	0.043	1	0	0.044	1.6
802.11n-HT40	5190	Front side	0mm	13	12.76	0.047	1	0	0.050	1.6
	5230	Front side	0mm	13	12.98	0.049	1	0	0.049	1.6
	5270	Front side	0mm	13	12.65	0.048	1	0	0.052	1.6
	5310	Front side	0mm	13	12.67	0.048	1	0	0.052	1.6
	5510	Front side	0mm	13	12.68	0.039	1	0	0.042	1.6
	5550	Front side	0mm	13	12.98	0.043	1	1.22	0.043	1.6
	5670	Front side	0mm	13	12.67	0.045	1	0	0.049	1.6
	5755	Front side	0mm	13	12.88	0.045	1	0	0.046	1.6
	5795	Front side	0mm	13	12.79	0.047	1	0	0.049	1.6
802.11ac-VHT80	5210	Front side	0mm	13	12.77	0.048	1	0	0.051	1.6
	5290	Front side	0mm	13	12.69	0.045	1	0	0.048	1.6
	5530	Front side	0mm	13	12.92	0.038	1	0	0.039	1.6
	5610	Front side	0mm	13	12.77	0.039	1	0	0.041	1.6
	5775	Front side	0mm	13	12.84	0.042	1	0	0.044	1.6



Freq Band	Freq (MHz)	Position	Distance	Rated Max Power (dBm)	Measured Output Power (dBm)	Raw SAR 1g(W/kg)	Crest factor	Power Drift (dB)	Scaled SAR (Tune-up & Duty Cycle) (W/kg)	1g SAR Limit (W/kg)
802.11a	5180	Back side	0mm	15	14.65	0.032	1	0	0.035	1.6
	5200	Back side	0mm	15	14.89	0.036	1	0	0.037	1.6
	5240	Back side	0mm	15	14.51	0.034	1	0	0.038	1.6
	5260	Back side	0mm	15	14.67	0.034	1	2.07	0.037	1.6
	5280	Back side	0mm	15	14.75	0.033	1	0.19	0.035	1.6
	5320	Back side	0mm	15	14.88	0.036	1	0	0.037	1.6
	5500	Back side	0mm	15	14.92	0.041	1	0	0.042	1.6
	5580	Back side	0mm	15	14.65	0.042	1	0	0.046	1.6
	5700	Back side	0mm	15	14.84	0.043	1	0	0.045	1.6
	5745	Back side	0mm	15	14.81	0.044	1	0.66	0.046	1.6
	5785	Back side	0mm	15	14.66	0.046	1	0	0.050	1.6
	5825	Back side	0mm	15	14.87	0.044	1	0	0.045	1.6
802.11n	5180	Back side	0mm	14	13.77	0.043	1	0	0.045	1.6
	5200	Back side	0mm	14	13.81	0.046	1	0	0.048	1.6
	5240	Back side	0mm	14	13.79	0.043	1	0	0.045	1.6
	5260	Back side	0mm	14	13.88	0.044	1	0	0.045	1.6
	5280	Back side	0mm	14	13.66	0.043	1	0	0.047	1.6
	5320	Back side	0mm	14	13.71	0.044	1	0	0.047	1.6
	5500	Back side	0mm	14	13.81	0.044	1	0	0.046	1.6
	5580	Back side	0mm	14	13.59	0.041	1	0	0.045	1.6
	5700	Back side	0mm	14	13.92	0.044	1	0	0.045	1.6
	5745	Back side	0mm	14	13.76	0.045	1	0	0.048	1.6
	5785	Back side	0mm	14	13.87	0.041	1	0	0.042	1.6
	5825	Back side	0mm	14	13.88	0.048	1	0	0.049	1.6
802.11n-HT40	5190	Back side	0mm	13	12.76	0.047	1	0	0.050	1.6
	5230	Back side	0mm	13	12.98	0.046	1	0	0.046	1.6
	5270	Back side	0mm	13	12.65	0.046	1	0	0.050	1.6
	5310	Back side	0mm	13	12.67	0.043	1	0	0.046	1.6
	5510	Back side	0mm	13	12.68	0.048	1	0	0.052	1.6
	5550	Back side	0mm	13	12.98	0.041	1	0	0.041	1.6
	5670	Back side	0mm	13	12.67	0.046	1	0	0.050	1.6
	5755	Back side	0mm	13	12.88	0.049	1	0	0.050	1.6
	5795	Back side	0mm	13	12.79	0.041	1	0	0.043	1.6
802.11ac-VHT80	5210	Back side	0mm	13	12.77	0.043	1	0	0.045	1.6
	5290	Back side	0mm	13	12.69	0.042	1	0	0.045	1.6
	5530	Back side	0mm	13	12.92	0.043	1	0	0.044	1.6
	5610	Back side	0mm	13	12.77	0.046	1	0	0.049	1.6
	5775	Back side	0mm	13	12.84	0.043	1	0	0.045	1.6



Freq Band	Freq (MHz)	Position	Distance	Rated Max Power (dBm)	Measured Output Power (dBm)	Raw SAR 1g(W/kg)	Crest factor	Power Drift (dB)	Scaled SAR (Tune-up & Duty Cycle) (W/kg)	1g SAR Limit (W/kg)
802.11a	5180	Bottom side	0mm	15	14.65	0.148	1	0.01	0.160	1.6
	5200	Bottom side	0mm	15	14.89	0.148	1	0	0.152	1.6
	5240	Bottom side	0mm	15	14.51	0.149	1	0.17	0.167	1.6
	5260	Bottom side	0mm	15	14.67	0.154	1	0.28	0.166	1.6
	5280	Bottom side	0mm	15	14.75	0.158	1	2.3	0.167	1.6
	5320	Bottom side	0mm	15	14.88	0.152	1	0.17	0.156	1.6
	5500	Bottom side	0mm	15	14.92	0.175	1	0.1	0.178	1.6
	5580	Bottom side	0mm	15	14.65	0.204	1	0	0.221	1.6
	5700	Bottom side	0mm	15	14.84	0.202	1	0	0.210	1.6
	5745	Bottom side	0mm	15	14.81	0.215	1	0	0.225	1.6
	5785	Bottom side	0mm	15	14.66	0.205	1	0	0.222	1.6
	5825	Bottom side	0mm	15	14.87	0.174	1	0.04	0.179	1.6
802.11n	5180	Bottom side	0mm	14	13.77	0.158	1	0	0.167	1.6
	5200	Bottom side	0mm	14	13.81	0.177	1	0	0.185	1.6
	5240	Bottom side	0mm	14	13.79	0.199	1	0	0.209	1.6
	5260	Bottom side	0mm	14	13.88	0.188	1	0	0.193	1.6
	5280	Bottom side	0mm	14	13.66	0.181	1	0	0.196	1.6
	5320	Bottom side	0mm	14	13.71	0.187	1	0	0.200	1.6
	5500	Bottom side	0mm	14	13.81	0.201	1	0	0.210	1.6
	5580	Bottom side	0mm	14	13.59	0.21	1	0.18	0.231	1.6
	5700	Bottom side	0mm	14	13.92	0.195	1	0	0.199	1.6
	5745	Bottom side	0mm	14	13.76	0.202	1	0	0.213	1.6
	5785	Bottom side	0mm	14	13.87	0.205	1	0	0.211	1.6
	5825	Bottom side	0mm	14	13.88	0.198	1	0	0.204	1.6
802.11n-HT40	5190	Bottom side	0mm	13	12.76	0.178	1	0	0.188	1.6
	5230	Bottom side	0mm	13	12.98	0.125	1	0	0.126	1.6
	5270	Bottom side	0mm	13	12.65	0.130	1	0	0.141	1.6
	5310	Bottom side	0mm	13	12.67	0.132	1	0	0.142	1.6
	5510	Bottom side	0mm	13	12.68	0.195	1	0.28	0.210	1.6
	5550	Bottom side	0mm	13	12.98	0.211	1	0.07	0.212	1.6
	5670	Bottom side	0mm	13	12.67	0.174	1	0.07	0.188	1.6
	5755	Bottom side	0mm	13	12.88	0.168	1	0	0.173	1.6
	5795	Bottom side	0mm	13	12.79	0.178	1	0	0.187	1.6
802.11a c-VHT80	5210	Bottom side	0mm	13	12.77	0.157	1	0	0.166	1.6
	5290	Bottom side	0mm	13	12.69	0.158	1	0	0.170	1.6
	5530	Bottom side	0mm	13	12.92	0.202	1	0	0.206	1.6
	5610	Bottom side	0mm	13	12.77	0.202	1	0	0.213	1.6
	5775	Bottom side	0mm	13	12.84	0.203	1	0	0.211	1.6

Simultaneous Transmission SAR Analysis:

No.	Applicable simultaneous transmission combination
1	WLAN+BT

For simultaneous transmission analysis, Bluetooth SAR is estimated per KDB447498 D01 V06 base on the formula below:

When an antenna qualifies for the standalone SAR test exclusion of 4.3.1 and also transmits simultaneously with other antennas, the standalone SAR value must be estimated according to the following to determine the simultaneous transmission SAR test exclusion criteria:³⁶

- 1) $[(\text{max. power of channel, including tune-up tolerance, mW}) / (\text{min. test separation distance, mm})] \cdot [\sqrt{f(\text{GHz})/x}] \text{ W/kg}$, for test separation distances $\leq 50 \text{ mm}$;
 where $x = 7.5$ for 1-g SAR and $x = 18.75$ for 10-g SAR.

If the test separation distance $\leq 5\text{mm}$, 5mm is used for the estimated SAR calculation.

Mode	Channel Frequency (GHz)	Max Output Power (dBm)	Turn-up Tolerance	Test separation distance (mm)	Estimated Value
BT_LE	2.44	7.66	± 1	5	0.3

Maximum summation:

Position (Body)	WLAN	BT	WLAN+BT
	Max Scaled SAR	Max Scaled SAR	
5GHz	0.985	0.3	1.285
2.4GHz	0.055	0.3	0.355

1g-SAR scalar summation < 1.6W/kg, so no simultaneous SAR is required.

Note: SAR testing was performed on the maximum power mode.

No hotspot detected for Bluetooth BDR/EDR and Low energy.

Test Engineer : Deon Dai

4. Calibration of Test Equipment

Equipment	Model	SN	Cal. Date	Cal. Interval
P C	Dell-U2417H	CN-OXVNNT-WS200-7AE-AONW-AO5	N/A	N/A
MXG Vector Signal Generator	N5182A	MY47071065	06/28/2019	1 Year
Digital Thermometer	DTM3000	1259033	N/A	N/A
S-Parameter Network Analyzer	8753ES	US38161019	11/10/2018	1 Year
Data Acquisition Electronics (DAE)	DAE4	1522	04/11/2019	1 Year
E-field PROBE	EX3DV4	7525	02/20/2019	1 Year
Dielectric parameter probes	DAK3.5 probe	1261	04/09/2019	1 Year
Dipole	D5GHzV2	1267	04/18/2019	1 Year
Dipole	D2450V2	1002	04/18/2019	1 Year
Light Beam Unit	LB5/80	1037	N/A	N/A
Modulation and Interference Analyzer	MAIA	1313	N/A	N/A
Omni-Directional Ultra-Wideband Antenna	ANT	1116	N/A	N/A
DUMMY PROBE	None	SN 31/10	N/A	N/A
SAM-TWIN PHANTOM	Twin-SAM V8.0	1929	N/A	N/A
ELI Phantom	ELI V8.0	2071	N/A	N/A
PHANTOM TABLE	N/A	N/A	N/A	N/A
6 AXIS ROBOT	Staubli Tx 60 L	N/A	N/A	N/A



5. Information of the Testing Laboratories

Bureau Veritas is a global leader in testing, inspection and certification (TIC) services. We help businesses improve safety, sustainability and productivity; and our clients include the majority of leading brands in retail, manufacturing and other industries. With a presence in every major country around the world, our quality assurance and compliance solutions are vital in helping our customers enhance product quality and concept-to-consumer journeys. We also assist with increasing speed to market, profitability and brand equity throughout the supply chain. Bureau Veritas is a leading wireless/IoT testing, inspection, audit and certification provider, with a global network of test laboratories to support the IoT industry in areas of connectivity, security, interoperability as well as quality, health & safety, and environmental/chemical requirements.

If you have any comments, please feel free to contact us at the following:

Milpitas EMC/RF/Safety/Telecom Lab

775 Montague Expressway, Milpitas, CA 95035
Tel: +1 408 526 1188

Sunnyvale OTA/Bluetooth Lab

1293 Anvilwood Avenue, Sunnyvale, CA
94089
Tel: +1 669 600 5293

Littleton EMC/RF/Safety/Environmental Lab

1 Distribution Center Cir #1, Littleton, MA 01460
Tel: +1 978 486 8880

Irvine OTA/PTCRB/Bluetooth/V2X Lab

15 Musick, Irvine, CA 92618
Tel: +1 949 716 6512

Email: sales.eaw@us.bureauveritas.com

Web Site: www.cpsusa-bureauveritas.com

The address and road map of all our labs can be found in our web site also.

Appendix A. SAR Plots of System Verification

The plots for system verification with largest deviation for each SAR system combination are shown as follows.

Test specification:	System Verification				
Environ Conditions:	Temp(oC):	23	Result:	Pass	
	Humidity (%):	44			
	Atmospheric(mPa):	1017			
Mains Power:	N/A				
Test Date:	09/10/2019				
Tested by:	Deon Dai				
Remarks:	System Validation, dipole, CW signal, duty cycle =1				

Frequency (MHz)	2450
Relative Permittivity (real part)	53.1
Conductivity (S/m)	2.01
Probe SN	EX3DV4 - SN7525
DAE SN	DAE4 Sn1522
Conversion Factor (dB)	8.5
Area Scan Resolution (mm)	14.0 x 14.0
Zoom Scan Resolution (mm)	6.0 x 6.0 x 6.0
Zoom Scan Size (mm)	30.0 x 30.0 x 30.0
Power Drift (dB)	1.12
SAR 1g (W/Kg)	5.06

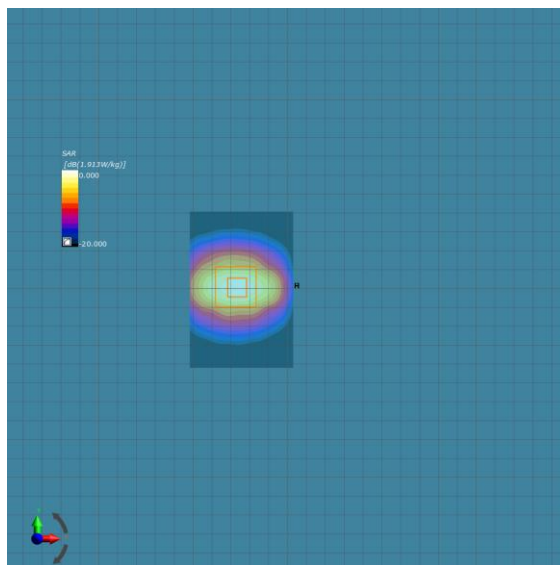

Area and Zoom Scan Plot

Test specification:	System Verification				
Environ Conditions:	Temp(oC):	23	Result:	Pass	
	Humidity (%):	44			
	Atmospheric(mPa):	1017			
Mains Power:	N/A				
Test Date:	09/10/2019				
Tested by:	Deon Dai				
Remarks:	System Validation, dipole, CW signal, duty cycle =1				

Frequency (MHz)	5250
Relative Permittivity (real part)	48.20
Conductivity (S/m)	5.39
Probe SN	EX3DV4 - SN7525
DAE SN	DAE4 Sn1522
Conversion Factor (dB)	5.41
Area Scan Resolution (mm)	10.0 x 10.0
Zoom Scan Resolution (mm)	4.0 x 4.0 x 1.4
Zoom Scan Size (mm)	22.0 x 22.0 x 22.0
Power Drift (dB)	1.01
SAR 1g (W/Kg)	7.53

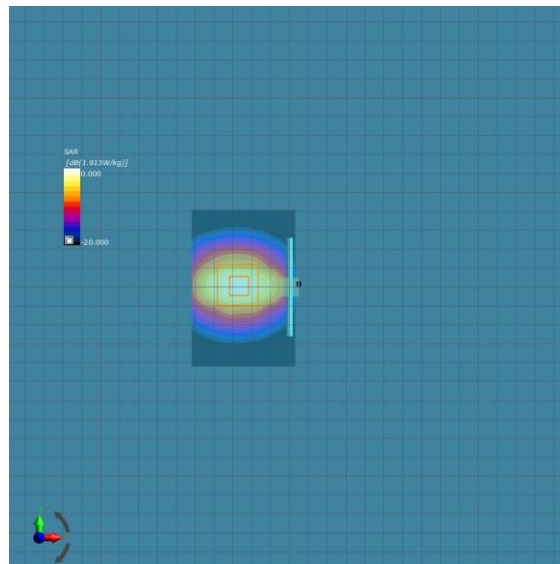

Area and Zoom Scan Plot

Test specification:	System Verification				
Environ Conditions:	Temp(oC):	23	Result:	Pass	
	Humidity (%):	44			
	Atmospheric(mPa):	1017			
Mains Power:	N/A				
Test Date:	09/10/2019				
Tested by:	Deon Dai				
Remarks:	System Validation, dipole, CW signal, duty cycle =1				

Frequency (MHz)	5600
Relative Permittivity (real part)	47.5
Conductivity (S/m)	5.89
Probe SN	EX3DV4 - SN7525
DAE SN	DAE4 Sn1522
Conversion Factor (dB)	5.41
Area Scan Resolution (mm)	10.0 x 10.0
Zoom Scan Resolution (mm)	4.0 x 4.0 x 1.4
Zoom Scan Size (mm)	22.0 x 22.0 x 22.0
Power Drift (dB)	1.13
SAR 1g (W/Kg)	7.78

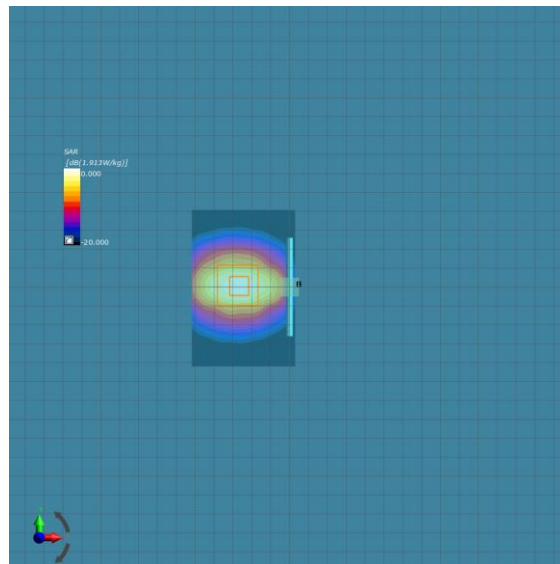

Area and Zoom Scan Plot

Test specification:	System Verification				
Environ Conditions:	Temp(oC):	23	Result:	Pass	
	Humidity (%):	44			
	Atmospheric(mPa):	1017			
Mains Power:	N/A				
Test Date:	09/10/2019				
Tested by:	Deon Dai				
Remarks:	System Validation, dipole, CW signal, duty cycle =1				

Frequency (MHz)	5750
Relative Permittivity (real part)	47.2
Conductivity (S/m)	6.11
Probe SN	EX3DV4 - SN7525
DAE SN	DAE4 Sn1522
Conversion Factor (dB)	5.41
Area Scan Resolution (mm)	10.0 x 10.0
Zoom Scan Resolution (mm)	4.0 x 4.0 x 1.4
Zoom Scan Size (mm)	22.0 x 22.0 x 22.0
Power Drift (dB)	1.21
SAR 1g (W/Kg)	7.39

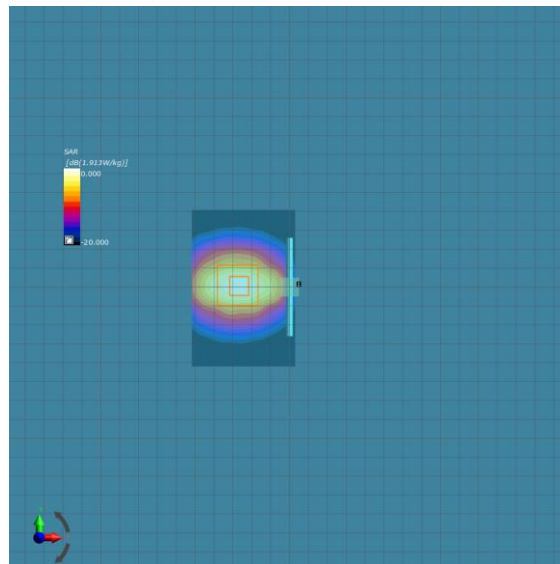

Area and Zoom Scan Plot

Appendix B. SAR Plots of SAR Measurement

The SAR plots for highest measured SAR in each exposure configuration, wireless mode and frequency band combination are shown as follows.

The plots for SAR measurement are shown as follows.

Wlan_2.4G

Test specification:	Body_Low_802.11b_2412_Left Side_0mm		
Environ Conditions:	Temp(oC): 23	Result:	Pass
	Humidity (%): 44		
	Atmospheric(mPa): 1015		
Mains Power:	N/A		
Test Date:	09/17/2019-09/30/2019		
Tested by:	Deon Dai		
Remarks:	-		
Frequency (MHz)	2412 (Channel 1)		
Relative permittivity (real part)	53.2		
Conductivity (S/m)	2.00		
Probe SN	EX3DV4 - SN7525		
DAE SN	DAE4 Sn1522		
Conversion Factor (dB)	8.5		
Area Scan Resolution (mm)	14x14		
Zoom Scan Resolution (mm)	6x6x6		
Zoom Scan Size (mm)	30x30x30		
Power Drift (dB)	0.16		
SAR 1g (W/Kg)	0.019		

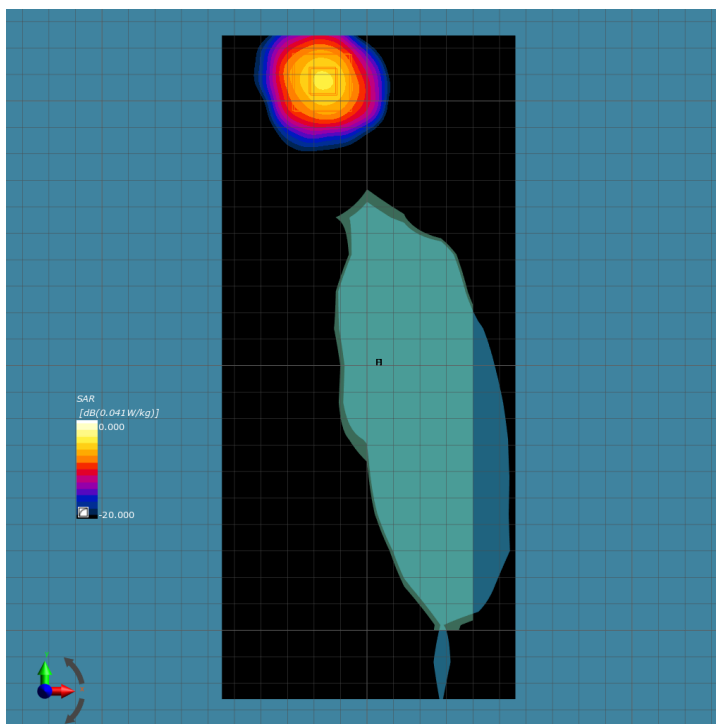

Area and Zoom Scan Plot

Test specification:	Body_Mid_802.11b_2437_Left Side_0mm		
Environ Conditions:	Temp(oC): 23	Result:	Pass
	Humidity (%): 44		
	Atmospheric(mPa): 1015		
Mains Power:	N/A		
Test Date:	09/17/2019-09/30/2019		
Tested by:	Deon Dai		
Remarks:	-		
Frequency (MHz)	2437 (Channel 6)		
Relative permittivity (real part)	53.2		
Conductivity (S/m)	2.00		
Probe SN	EX3DV4 - SN7525		
DAE SN	DAE4 Sn1522		
Conversion Factor (dB)	8.5		
Area Scan Resolution (mm)	14x14		
Zoom Scan Resolution (mm)	6x6x6		
Zoom Scan Size (mm)	30x30x30		
Power Drift (dB)	0		
SAR 1g (W/Kg)	0.021		

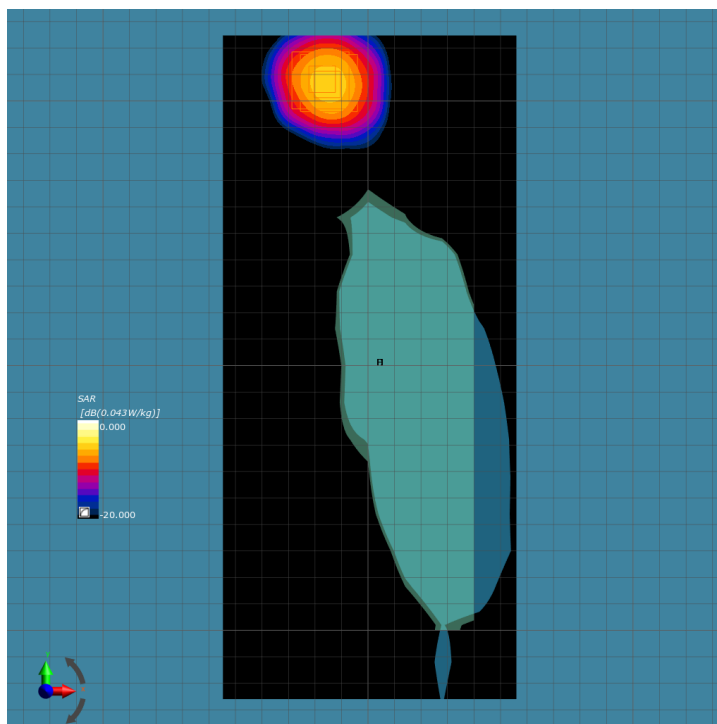

Area and Zoom Scan Plot

Test specification:	Body_High_802.11b_2462_Left Side_0mm		
Environ Conditions:	Temp(oC): 23	Result:	Pass
	Humidity (%): 44		
	Atmospheric(mPa): 1015		
Mains Power:	N/A		
Test Date:	09/17/2019-09/30/2019		
Tested by:	Deon Dai		
Remarks:	-		

Frequency (MHz)	2462 (Channel 11)
Relative permittivity (real part)	53.1
Conductivity (S/m)	2.02
Probe SN	EX3DV4 - SN7525
DAE SN	DAE4 Sn1522
Conversion Factor (dB)	8.5
Area Scan Resolution (mm)	14x14
Zoom Scan Resolution (mm)	6x6x6
Zoom Scan Size (mm)	30x30x30
Power Drift (dB)	0.21
SAR 1g (W/Kg)	0.022

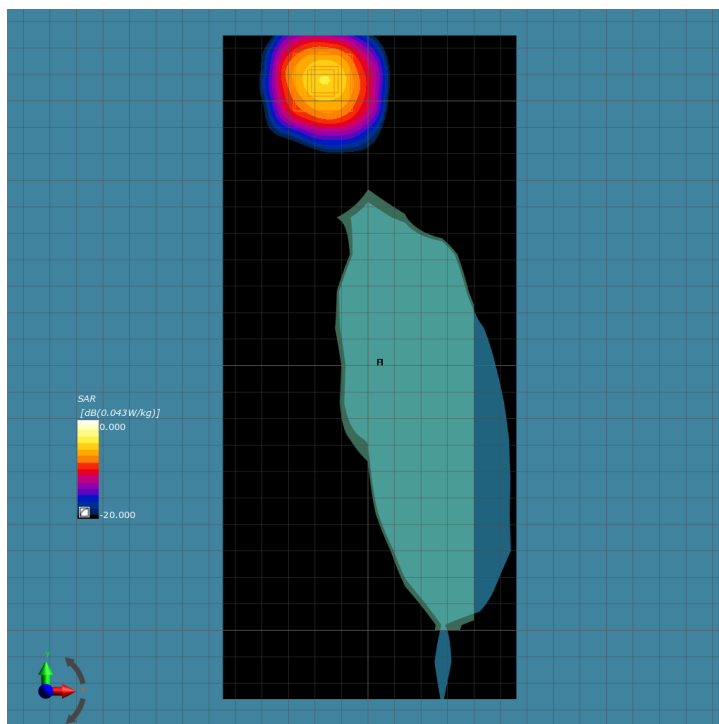

Area and Zoom Scan Plot

Test specification:	Body_Low_802.11g_2412_Left Side_0mm		
Environ Conditions:	Temp(oC): 23	Result:	Pass
	Humidity (%): 44		
	Atmospheric(mPa): 1015		
Mains Power:	N/A		
Test Date:	09/17/2019-09/30/2019		
Tested by:	Deon Dai		
Remarks:	-		
Frequency (MHz)	2412 (Channel 1)		
Relative permittivity (real part)	53.2		
Conductivity (S/m)	1.99		
Probe SN	EX3DV4 - SN7525		
DAE SN	DAE4 Sn1522		
Conversion Factor (dB)	8.5		
Area Scan Resolution (mm)	14x14		
Zoom Scan Resolution (mm)	6x6x6		
Zoom Scan Size (mm)	30x30x30		
Power Drift (dB)	0		
SAR 1g (W/Kg)	0.02		

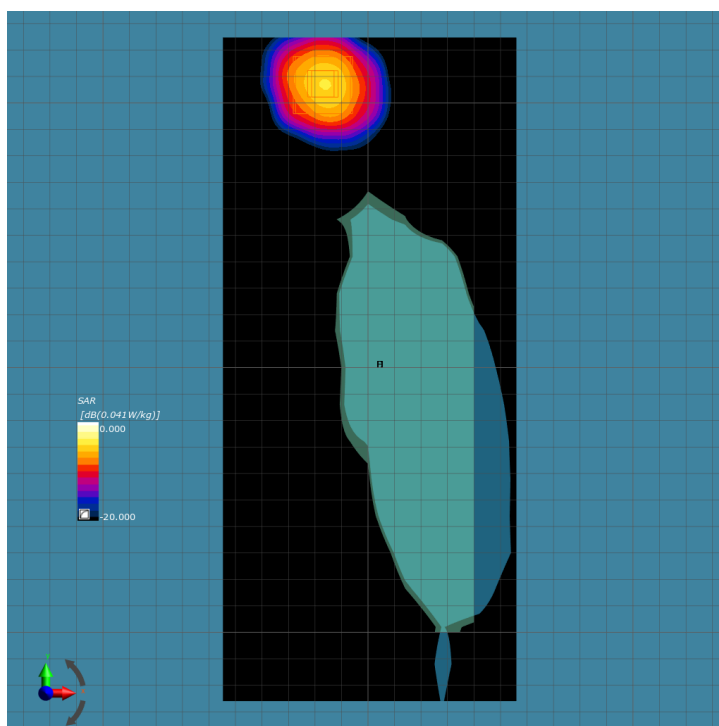

Area and Zoom Scan Plot

Test specification:	Body_Mid_802.11g_2437_Left Side_0mm		
Environ Conditions:	Temp(oC): 23	Result:	Pass
	Humidity (%): 44		
	Atmospheric(mPa): 1015		
Mains Power:	N/A		
Test Date:	09/17/2019-09/30/2019		
Tested by:	Deon Dai		
Remarks:	-		
Frequency (MHz)	2437 (Channel 6)		
Relative permittivity (real part)	53.2		
Conductivity (S/m)	1.99		
Probe SN	EX3DV4 - SN7525		
DAE SN	DAE4 Sn1522		
Conversion Factor (dB)	8.5		
Area Scan Resolution (mm)	14x14		
Zoom Scan Resolution (mm)	6x6x6		
Zoom Scan Size (mm)	30x30x30		
Power Drift (dB)	0		
SAR 1g (W/Kg)	0.02		

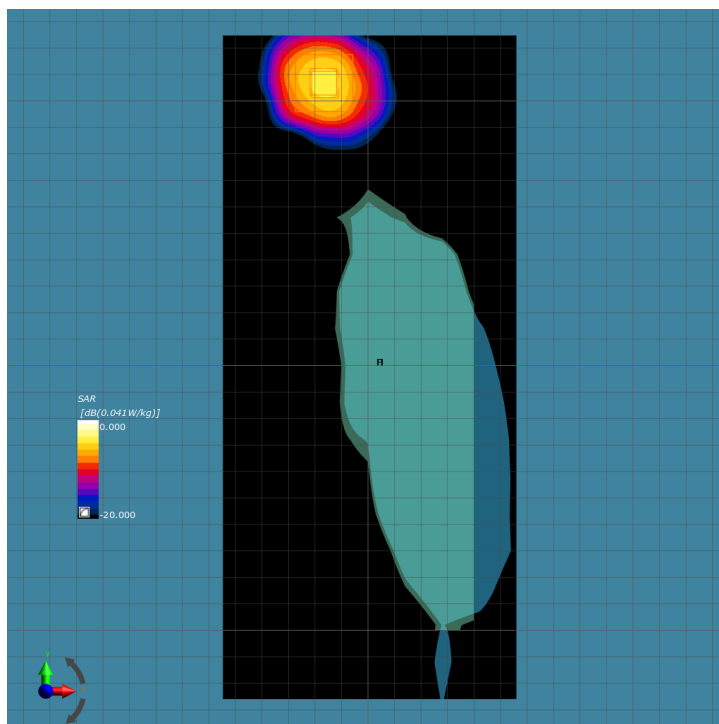

Area and Zoom Scan Plot

Test specification:	Body_High_802.11g_2462_Left Side_0mm		
Environ Conditions:	Temp(oC): 23	Result:	Pass
	Humidity (%): 44		
	Atmospheric(mPa): 1015		
Mains Power:	N/A		
Test Date:	09/17/2019-09/30/2019		
Tested by:	Deon Dai		
Remarks:	-		
Frequency (MHz)	2422 (Channel 11)		
Relative permittivity (real part)	53.2		
Conductivity (S/m)	1.99		
Probe SN	EX3DV4 - SN7525		
DAE SN	DAE4 Sn1522		
Conversion Factor (dB)	8.5		
Area Scan Resolution (mm)	14x14		
Zoom Scan Resolution (mm)	6x6x6		
Zoom Scan Size (mm)	30x30x30		
Power Drift (dB)	0		
SAR 1g (W/Kg)	0.053		

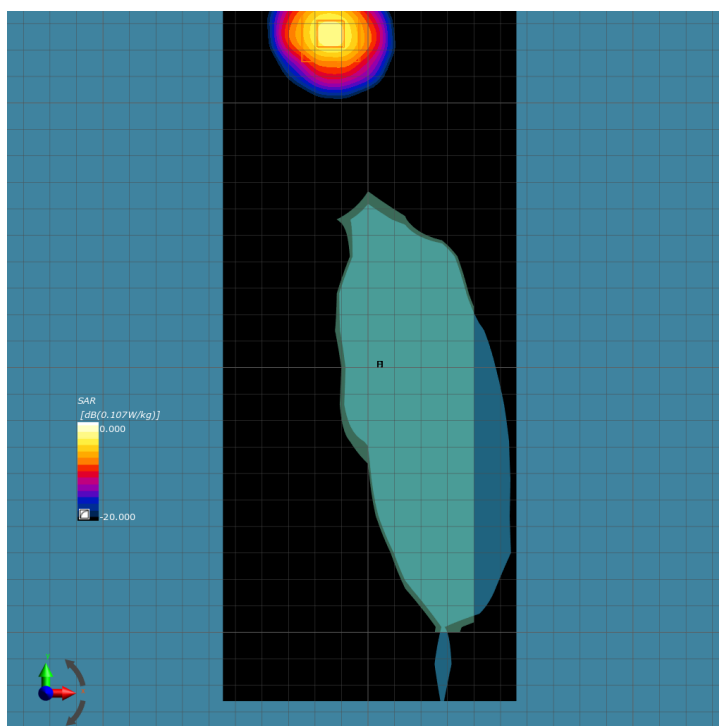

Area and Zoom Scan Plot

Test specification:	Body_Low_802.11n_2412_Left Side_0mm		
Environ Conditions:	Temp(oC): 23	Result:	Pass
	Humidity (%): 44		
	Atmospheric(mPa): 1015		
Mains Power:	N/A		
Test Date:	09/17/2019-09/30/2019		
Tested by:	Deon Dai		
Remarks:	-		

Frequency (MHz)	2412 (Channel 1)
Relative permittivity (real part)	53.2
Conductivity (S/m)	1.99
Probe SN	EX3DV4 - SN7525
DAE SN	DAE4 Sn1522
Conversion Factor (dB)	8.5
Area Scan Resolution (mm)	14x14
Zoom Scan Resolution (mm)	6x6x6
Zoom Scan Size (mm)	30x30x30
Power Drift (dB)	0.53
SAR 1g (W/Kg)	0.02

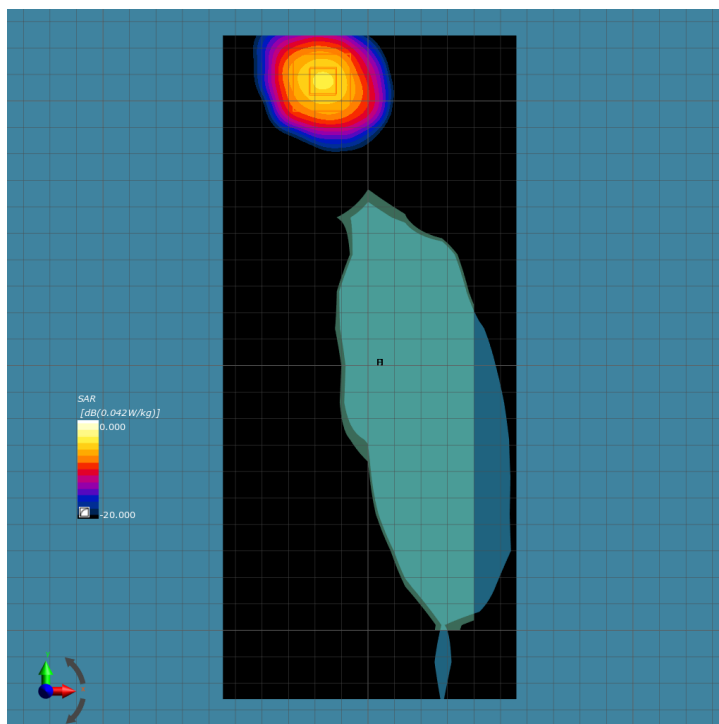

Area and Zoom Scan Plot

Test specification:	Body_Mid_802.11n_2437_Left Side_0mm		
Environ Conditions:	Temp(oC): 23	Result:	Pass
	Humidity (%): 44		
	Atmospheric(mPa): 1015		
Mains Power:	N/A		
Test Date:	09/17/2019-09/30/2019		
Tested by:	Deon Dai		
Remarks:	-		
Frequency (MHz)	2437 (Channel 6)		
Relative permittivity (real part)	53.2		
Conductivity (S/m)	1.99		
Probe SN	EX3DV4 - SN7525		
DAE SN	DAE4 Sn1522		
Conversion Factor (dB)	8.5		
Area Scan Resolution (mm)	14x14		
Zoom Scan Resolution (mm)	6x6x6		
Zoom Scan Size (mm)	30x30x30		
Power Drift (dB)	0		
SAR 1g (W/Kg)	0.019		

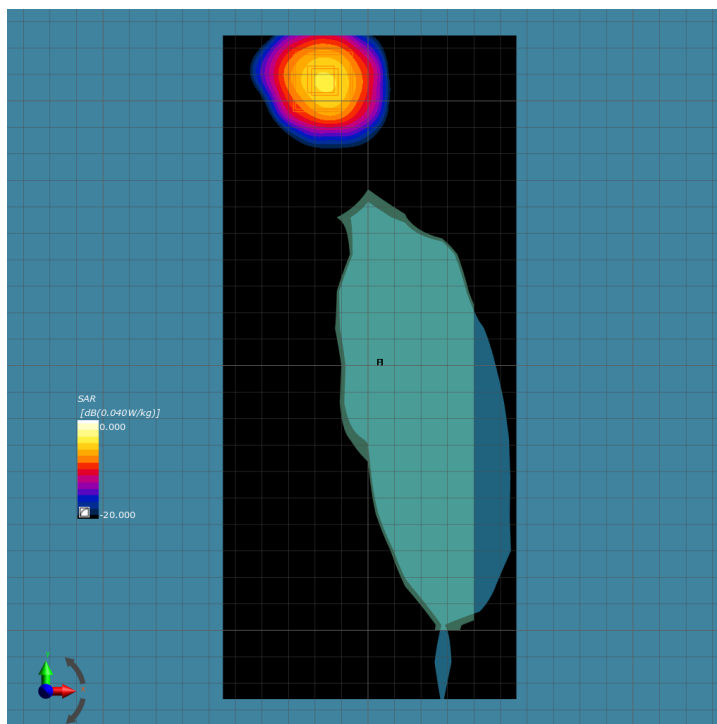

Area and Zoom Scan Plot

Test specification:	Body_High_802.11n_2462_Left Side_0mm		
Environ Conditions:	Temp(oC): 23	Result:	Pass
	Humidity (%): 44		
	Atmospheric(mPa): 1015		
Mains Power:	N/A		
Test Date:	09/17/2019-09/30/2019		
Tested by:	Deon Dai		
Remarks:	-		
Frequency (MHz)	2422 (Channel 11)		
Relative permittivity (real part)	53.2		
Conductivity (S/m)	1.99		
Probe SN	EX3DV4 - SN7525		
DAE SN	DAE4 Sn1522		
Conversion Factor (dB)	8.5		
Area Scan Resolution (mm)	14x14		
Zoom Scan Resolution (mm)	6x6x6		
Zoom Scan Size (mm)	30x30x30		
Power Drift (dB)	0		
SAR 1g (W/Kg)	0.020		

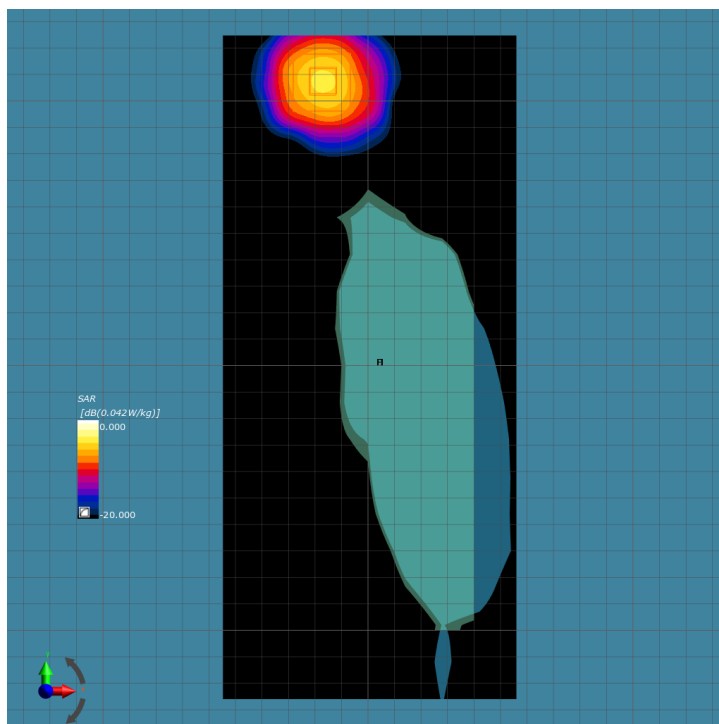

Area and Zoom Scan Plot

Test specification:	Body_Low_802.11n40_2422_Left Side_0mm		
Environ Conditions:	Temp(oC): 23	Result:	Pass
	Humidity (%): 44		
	Atmospheric(mPa): 1015		
Mains Power:	N/A		
Test Date:	09/17/2019-09/30/2019		
Tested by:	Deon Dai		
Remarks:	-		
Frequency (MHz)	2422 (Channel 3)		
Relative permittivity (real part)	53.2		
Conductivity (S/m)	1.99		
Probe SN	EX3DV4 - SN7525		
DAE SN	DAE4 Sn1522		
Conversion Factor (dB)	8.5		
Area Scan Resolution (mm)	14x14		
Zoom Scan Resolution (mm)	6x6x6		
Zoom Scan Size (mm)	30x30x30		
Power Drift (dB)	0		
SAR 1g (W/Kg)	0.02		

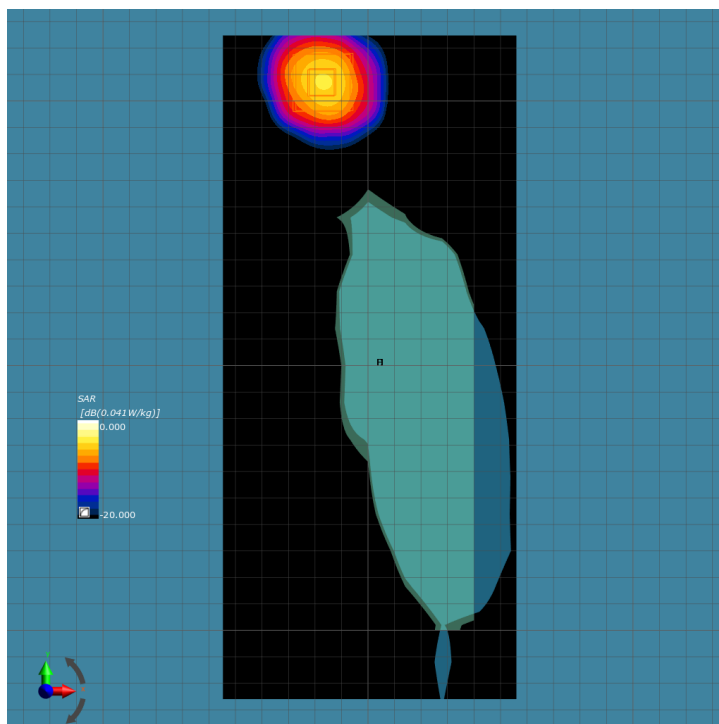

Area and Zoom Scan Plot

Test specification:	Body_Mid_802.11n40_2437_Left Side_0mm		
Environ Conditions:	Temp(oC): 23	Result:	Pass
	Humidity (%): 44		
	Atmospheric(mPa): 1015		
Mains Power:	N/A		
Test Date:	09/17/2019-09/30/2019		
Tested by:	Deon Dai		
Remarks:	-		
Frequency (MHz)	2437 (Channel 6)		
Relative permittivity (real part)	53.1		
Conductivity (S/m)	2.00		
Probe SN	EX3DV4 - SN7525		
DAE SN	DAE4 Sn1522		
Conversion Factor (dB)	8.5		
Area Scan Resolution (mm)	14x14		
Zoom Scan Resolution (mm)	6x6x6		
Zoom Scan Size (mm)	30x30x30		
Power Drift (dB)	0		
SAR 1g (W/Kg)	0.02		

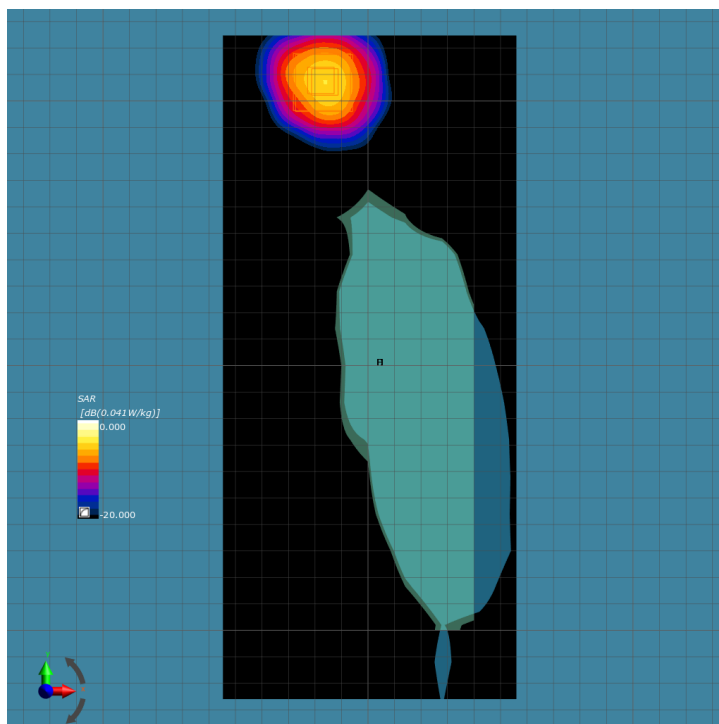

Area and Zoom Scan Plot