

FCC/ISED - TEST REPORT

Report Number : **68.940.21.0029.01** Date of Issue: May 13, 2021

Model : **RD030015DG**

Product Type : **LED LINKABLE SHOPLIGHT**

Applicant : **Winplus Co., Ltd.**

Address : **Suites 6-11, 7th Floor, Corporation Park, 11 On Lai Street, Shatin,
Hong Kong**

Manufacturer : **ADC Solutions Hardware, LLC**

Address : **2975 Red Hill Ave., Ste. 100, Costa Mesa, CA 92626**

Test Result : **Positive** **Negative**

Total pages including Appendices : **27**

TÜV SÜD Certification and Testing (China) Co., Ltd. Shenzhen Branch is a subcontractor to TÜV SÜD Product Service GmbH according to the principles outlined in ISO 17025.

TÜV SÜD Certification and Testing (China) Co., Ltd. Shenzhen Branch reports apply only to the specific samples tested under stated test conditions. Construction of the actual test samples has been documented. It is the manufacturer's responsibility to assure that additional production units of this model are manufactured with identical electrical and mechanical components. The manufacturer/importer is responsible to the Competent Authorities in Europe for any modifications made to the production units which result in non-compliance to the relevant regulations. TÜV SÜD Certification and Testing (China) Co., Ltd. Shenzhen Branch shall have no liability for any deductions, inferences or generalizations drawn by the client or others from TÜV SÜD Certification and Testing (China) Co., Ltd. Shenzhen Branch issued reports.

This report is the confidential property of the client. As a mutual protection to our clients, the public and ourselves, extracts from the test report shall not be reproduced except in full without our written approval



1 Table of Contents

1 Table of Contents.....	2
2 Details about the Test Laboratory.....	3
3 Description of the Equipment Under Test.....	4
4 Summary of Test Standards.....	5
5 Summary of Test Results.....	6
6 General Remarks.....	7
7 Test setups.....	8
8 Technical Requirement.....	9
8.1 Conducted Emission.....	9
8.2 Field strength of emissions and Restricted bands.....	12
8.3 Out of Band Emissions.....	17
8.4 20dB Bandwidth.....	22
9 Test equipment lists.....	26
10 System Measurement Uncertainty.....	27



2 Details about the Test Laboratory

Details about the Test Laboratory

Test Site 1

Company name: TÜV SÜD Certification and Testing (China) Co., Ltd. Shenzhen Branch
Building 12&13, Ziheng Wisdomland Business Park,
Nantou Checkpoint Road 2, Nanshan District,
Shenzhen City, 518052,
P. R. China

FCC Registration Number: 514049

FCC Designation Number: CN5009

ISED#: 10320A

CAB identifier: CN0077

Telephone: 86 755 8828 6998
Fax: 86 755 8828 5299

3 Description of the Equipment Under Test

Description of the Equipment Under Test

Product/PMN:	LED LINKABLE SHOPLIGHT
Model no./HVIN:	RD030015DG
HMN:	46" LED LINKABLE SHOP LIGHT
FCC ID:	WUI-RD030015DG
IC:	7297A-RD030015DG
Options and accessories:	NIL
Ratings:	7.5-12VDC (Supplied by 46" LED LINKABLE SHOP LIGHT)
RF Transmission Frequency:	5830MHz-5862MHz
Modulation:	FMCW
Antenna Type:	Integrated Antenna
Antenna Gain:	5.42dBi
Description of the EUT:	The product is a LED LINKABLE SHOPLIGHT that operated at 5.8GHz, The TX and RX range is 5830MHz-5862MHz

Auxiliary Equipment Used during Test:

DESCRIPTION	MANUFACTURER	RATINGS	MODEL NO.
46" LED LINKABLE SHOP LIGHT	WINPLUS	120VAC/60Hz, 48W	LM030015

4 Summary of Test Standards

Test Standards	
FCC Part 15 Subpart C 10-1-2019 Edition	PART 15 - RADIO FREQUENCY DEVICES Subpart C - Intentional Radiators
RSS-Gen Issue 5, February 2021 Amendment 2	General Requirements and Information for the Certification of Radio Apparatus
RSS-210 Issue 10 December 2019	RSS-210 — Licence-exempt Radio Apparatus (All Frequency Bands): Category I Equipment

All the test methods were according to ANSI C63.10-2013.



5 Summary of Test Results

Technical Requirements					
FCC Part 15 Subpart C 15.249, RSS-Gen, RSS-210					
Test Condition	Pages	Test Site	Test Result		
			Pass	Fail	N/A
15.207 & RSS-Gen A8.8 Conducted emission AC power port	9	Site 1	<input checked="" type="checkbox"/>	<input type="checkbox"/>	<input type="checkbox"/>
§15.205(a), §15.209(a), §15.249(a), §15.249(c) & RSS-210 B.10, RSS-GEN 6.13/8.9/8.10 Field strength of emissions and Restricted bands	12	Site 1	<input checked="" type="checkbox"/>	<input type="checkbox"/>	<input type="checkbox"/>
§15.249(d), RSS-210 B.10 Out of band emissions	17	Site 1	<input checked="" type="checkbox"/>	<input type="checkbox"/>	<input type="checkbox"/>
FCC §15.215(c) 20dB bandwidth & RSS-Gen 6.7 99% Occupied Bandwidth	22	Site 1	<input checked="" type="checkbox"/>	<input type="checkbox"/>	<input type="checkbox"/>
§15.203, RSS-GEN 6.8 Antenna requirement	See note 1		<input checked="" type="checkbox"/>	<input type="checkbox"/>	<input type="checkbox"/>

Remark 1: N/A- Not Applicable;

Note 1: The EUT used an integral PCB antenna, which gain is 5.42dBi. According to §15.203, it is considered sufficiently to comply with the provisions of this section.

Note 2: The radio module does not have shielded cover, so it was tested with a host for this modular approve application, the host information as below:

Company name: Winplus Co., Ltd.

Product/PMN: 46" LED LINKABLE SHOP LIGHT

Model no./HVIN: LM030015



6 General Remarks

Remarks

This submittal(s) (test report) is intended for FCC ID: WUI-RD030015DG and IC: 7297A-RD030015DG complies with Section 15.207, 15.205, 15.209, 15.249 of the FCC Part 15, Subpart C Rules; RSS-Gen Issue 5 and RSS-210 issue 10.

SUMMARY:

All tests according to the regulations cited on page 5 were

- Performed

- **Not** Performed

The Equipment Under Test

- **Fulfills** the general approval requirements.

- **Does not** fulfill the general approval requirements.

Sample Received Date: April 19, 2021

Testing Start Date: April 19, 2021

Testing End Date: April 24, 2021

- TÜV SÜD Certification and Testing (China) Co., Ltd. Shenzhen Branch -

Reviewed by:

Prepared by:

Tested by:

Dawi Xu

Dawi Xu
EMC Project Manager



Henry Chen

Henry Chen
EMC Project Engineer

Louise Liu

Louise Liu
EMC Test Engineer

7 Test setups

7.1 AC Power Line Conducted Emission test setups

AC Power Line Conducted Emission test setups

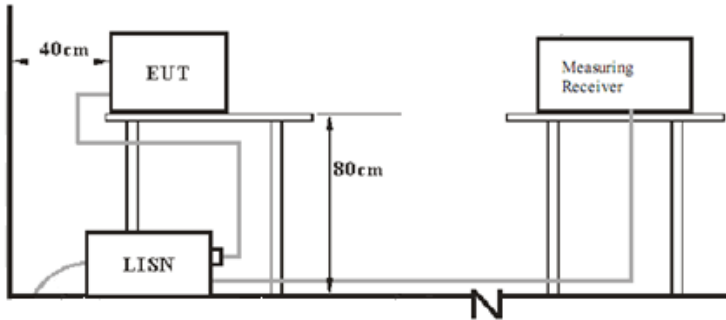

7.2 Radiated test setups

Below 1GHz

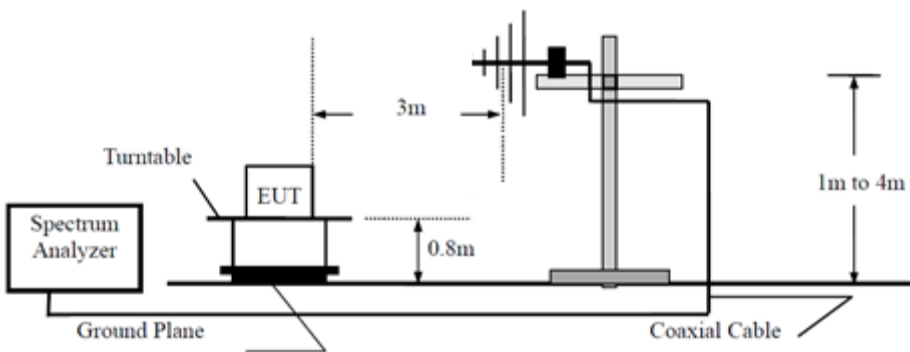

Above 1GHz

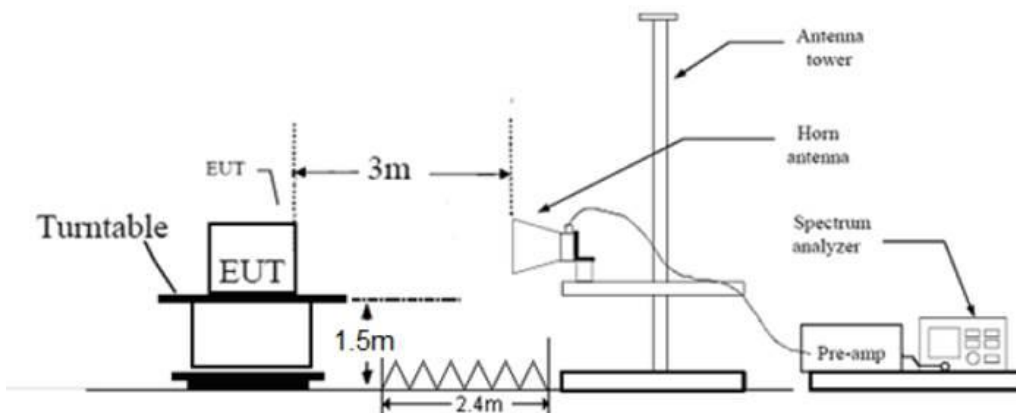

8 Technical Requirement

8.1 Conducted Emission

Test Method

1. The EUT was placed on a table, which is 0.8m above ground plane
2. The power line of the EUT is connected to the AC mains through a Artificial Mains Network (A.M.N.).
3. Maximum procedure was performed to ensure EUT compliance
4. A EMI test receiver is used to test the emissions from both sides of AC line

Limit

Frequency MHz	QP Limit dB μ V	AV Limit dB μ V
0.150-0.500	66-56*	56-46*
0.500-5	56	46
5-30	60	50

*Decreasing linearly with logarithm of the frequency.



Conducted Emission

Product Type : LED LINKABLE SHOPLIGHT
 M/N : RD030015DG
 Operating Condition : Normal working with transmitting
 Test specification : Live
 Comment : AC 120V/60Hz (Powered by 46" LED LINKABLE SHOP LIGHT)

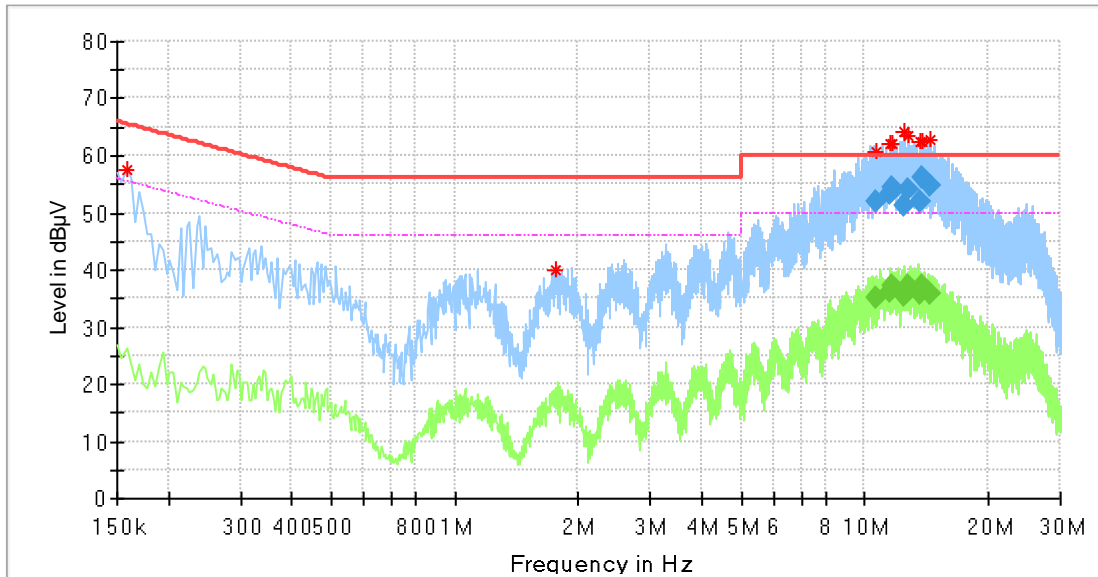

Critical Freqs

Frequency (MHz)	MaxPeak (dBµV)	Average (dBµV)	Limit (dBµV)	Margin (dB)	Line	Corr. (dB)
0.158000	57.58	---	65.57	7.99	L1	10.32
1.758000	40.01	---	56.00	15.99	L1	10.37

Final Result

Frequency (MHz)	QuasiPeak (dBµV)	Average (dBµV)	Limit (dBµV)	Margin (dB)	Line	Corr. (dB)
10.646500	---	35.20	50.00	14.80	L1	10.77
10.646500	51.90	---	60.00	8.10	L1	10.77
11.497500	---	36.31	50.00	13.69	L1	10.79
11.497500	53.22	---	60.00	6.78	L1	10.79
11.721500	---	37.09	50.00	12.91	L1	10.80
11.721500	54.47	---	60.00	5.53	L1	10.80
12.542500	---	35.51	50.00	14.49	L1	10.83
12.542500	51.07	---	60.00	8.93	L1	10.83
12.814500	---	37.33	50.00	12.67	L1	10.84
12.814500	54.12	---	60.00	5.88	L1	10.84
13.653500	---	35.91	50.00	14.09	L1	10.87
13.653500	51.80	---	60.00	8.20	L1	10.87
13.829500	---	37.33	50.00	12.67	L1	10.88
13.829500	56.25	---	60.00	3.75	L1	10.88
14.453500	---	35.80	50.00	14.20	L1	10.91
14.453500	54.90	---	60.00	5.10	L1	10.91

Remark :

Level=Reading Level + Correction Factor

Correction Factor=Cable Loss + LISN Factor

(The Reading Level is recorded by software which is not shown in the sheet)

Conducted Emission

Product Type : LED LINKABLE SHOPLIGHT
 M/N : RD030015DG
 Operating Condition : Normal working with transmitting
 Test specification : Neutral
 Comment : AC 120V/60Hz (Powered by 46" LED LINKABLE SHOP LIGHT)

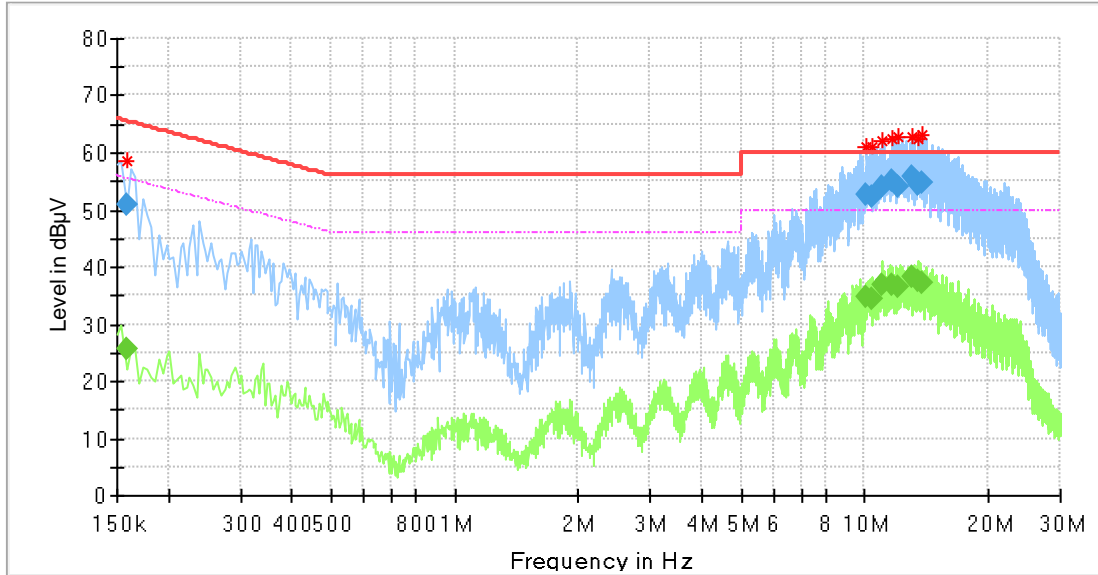

Final Result

Frequency (MHz)	QuasiPeak (dBµV)	Average (dBµV)	Limit (dBµV)	Margin (dB)	Line	Corr. (dB)
0.158000	---	25.48	55.57	30.09	N	10.33
0.158000	50.84	---	65.57	14.73	N	10.33
10.129500	---	34.73	50.00	15.27	N	10.82
10.129500	52.71	---	60.00	7.29	N	10.82
10.437500	---	34.52	50.00	15.48	N	10.84
10.437500	52.15	---	60.00	7.85	N	10.84
10.989500	---	36.91	50.00	13.09	N	10.86
10.989500	53.95	---	60.00	6.05	N	10.86
11.665500	---	37.00	50.00	13.00	N	10.88
11.665500	54.96	---	60.00	5.04	N	10.88
12.017500	---	36.44	50.00	13.56	N	10.90
12.017500	54.14	---	60.00	5.86	N	10.90
13.049500	---	38.19	50.00	11.81	N	10.94
13.049500	55.76	---	60.00	4.24	N	10.94
13.445500	---	37.70	50.00	12.30	N	10.96
13.445500	54.37	---	60.00	5.63	N	10.96
13.782500	---	37.09	50.00	12.91	N	10.98
13.782500	54.85	---	60.00	5.15	N	10.98

Remark :

Level=Reading Level + Correction Factor

Correction Factor=Cable Loss + LISN Factor

(The Reading Level is recorded by software which is not shown in the sheet)

8.2 Field strength of emissions and Restricted bands

Test Method

- 1: The EUT was placed on a turn table which is 1.5m above ground plane for above 1GHz and 0.8m above ground for below 1GHz at 3-meter chamber room for test. The table was rotated 360 degrees to determine the position of the highest radiation.
- 2: The EUT was set 3 meters away from the interference – receiving antenna, which was mounted on the top of a variable – height antenna tower.
- 3: The height of antenna is varied from one meter to four meters above the ground to determine the maximum value of the field strength. Both horizontal and vertical polarizations of the antenna are set to make the measurement.
- 4: For each suspected emission, the EUT was arranged to its worst case and then the antenna was tuned to heights from 1 meter to 4 meters and the rotatable table was turned from 0 degrees to 360 degrees to find the maximum reading.
- 5: Use the following spectrum analyzer settings According to C63.10:

For Above 1GHz

Span = wide enough to capture the peak level of the in-band emission and all spurious
RBW = 1MHz, VBW \geq 3RBW, Sweep = auto, Detector function = peak and RMS,
Trace = max hold.

For Below 1GHz

Use the following spectrum analyzer settings:

Span = wide enough to capture the peak level of the in-band emission and all spurious
RBW = 120KHz, VBW \geq 3RBW, Sweep = auto, Detector function = QP,
Trace = max hold.

Field strength of emissions and Restricted bands

Limits

According to §15.249 (a) & RSS-210 A2.9(a), the field strength of emissions from intentional radiators operated within these frequency bands shall comply with the following:

Fundamental frequency	Field strength of fundamental (millivolts/meter)	Field strength of harmonics (microvolts/meter)
902–928 MHz	50	500
2400–2483.5 MHz	50	500
5725–5875 MHz	50	500
24.0–24.25 GHz	250	2500

According to §15.249 (c) & RSS-210 B.10, Field strength limits are specified at a distance of 3 meters.

According to §15.249 (d) & RSS-210 B.10, Emissions radiated outside of the specified frequency bands, except for harmonics, shall be attenuated by at least 50 dB below the level of the fundamental or to the general radiated emission limits in §15.209 & RSS-Gen, whichever is the lesser attenuation.

According to §15.205 and RSS-GEN 8.10 Unwanted emissions falling into restricted bands in §15.205 (a) and RSS-GEN 8.10 Table 7 shall comply with the limits specified in §15.209 and RSS-Gen.

Frequency MHz	Field Strength uV/m	Field Strength dB μ V/m	Detector
30-88	100	40	QP
88-216	150	43.5	QP
216-960	200	46	QP
960-1000	500	54	QP
Above 1000	500	54	AV
Above 1000	5000	74	PK

Field strength of emissions and Restricted bands

According to C63.10, if the peak (or quasi-peak) measured value complies with the average limit, it is unnecessary to perform an average measurement, so AV emission value did not show in below table if the peak value complies with average limit.

EUT: LED LINKABLE SHOPLIGHT

M/N: RD030015DG

Operating Condition: Tx; 5830MHz

For Peak Value

Radiated Emission								
Value	Emissions Frequency MHz	E-Field Polarity	Reading Level dB μ V/m	Correction Factor dB/m	PK Emission dB μ V/m	Limit dB μ V/m	Margin dBm	Emission Type
PK	91.291875	H	16.87	14.63	31.50	40.00	8.50	Spurious
PK	141.125625	V	23.25	12.89	36.14	40.00	3.86	Spurious
PK	5830.000000	H	66.93	4.85	71.78	114.00	42.22	Fundamental
PK	5830.000000	V	67.62	4.85	72.47	114.00	41.53	Fundamental
PK	17409.000000	H	33.76	18.15	51.91	74.00	22.09	Spurious
PK	16740.000000	V	33.5	17.96	51.46	74.00	22.54	Spurious

For AV Value

Radiated Emission								
Value	Emissions Frequency MHz	E-Field Polarity	Reading Level dB μ V/m	Correction Factor dB/m	AV Emission dB μ V/m	Limit dB μ V/m	Margin dBm	Emission Type
AV	5830.000000	H	66.49	4.85	71.34	94.00	22.66	Fundamental
AV	5830.000000	V	67.27	4.85	72.12	94.00	21.88	Fundamental
AV	/	H	/	/	/	54.00	/	Spurious
AV	/	V	/	/	/	54.00	/	Spurious

Duty cycle=100%

Remark:

1: Data of measurement within this frequency range shown "/" in the table above means the reading of emissions are attenuated more than 20dB below the permissible limits or the field strength is too small to be measured.

2: "*" means the emission(s) appear within the restrict bands shall follow the requirement of section 15.205.

3: PK Emission = Reading Level + Correction Factor

Correction Factor=Antenna Factor + Cable Loss (For Below 1GHz)

Correction Factor = Antenna Factor + Cable Loss- Amplifier Gain (For Above 1GHz)

(The Reading Level is recorded by software which is not shown in the sheet)

Field strength of emissions and Restricted bands

EUT: LED LINKABLE SHOPLIGHT

M/N: RD030015DG

Operating Condition: Tx; 5845MHz

For Peak Value

Radiated Emission								
Value	Emissions Frequency MHz	E-Field Polarity	Reading Level dB μ V/m	Correction Factor dB/m	PK Emission dB μ V/m	Limit dB μ V/m	Margin dBm	Emission Type
PK	5845.000000	H	70.19	4.88	75.07	114.00	38.93	Fundamental
PK	5845.000000	V	60.9	4.88	65.78	114.00	48.22	Fundamental
PK	16741.500000	H	32.97	17.97	50.94	74.00	23.06	Spurious
PK	17379.500000	V	28.5	22.75	51.25	74.00	22.75	Spurious

For AV Value

Radiated Emission								
Value	Emissions Frequency MHz	E-Field Polarity	Reading Level dB μ V/m	Correction Factor dB/m	AV Emission dB μ V/m	Limit dB μ V/m	Margin dBm	Emission Type
AV	5845.000000	H	70.13	4.88	75.01	94.00	18.99	Fundamental
AV	5845.000000	V	60.81	4.88	65.69	94.00	28.31	Fundamental
AV	/	H	/	/	/	54.00	/	Spurious
AV	/	V	/	/	/	54.00	/	Spurious

Duty cycle=100%

Remark:

1: Data of measurement within this frequency range shown "/" in the table above means the reading of emissions are attenuated more than 20dB below the permissible limits or the field strength is too small to be measured.

2: "*" means the emission(s) appear within the restrict bands shall follow the requirement of section 15.205.

3: PK Emission = Reading Level + Correction Factor

Correction Factor=Antenna Factor + Cable Loss (For Below 1GHz)

Correction Factor = Antenna Factor + Cable Loss- Amplifier Gain (For Above 1GHz)

(The Reading Level is recorded by software which is not shown in the sheet)



Field strength of emissions and Restricted bands

EUT: LED LINKABLE SHOPLIGHT
 M/N: RD030015DG
 Operating Condition: Tx; 5862MHz

For Peak Value

Radiated Emission								
Value	Emissions Frequency MHz	E-Field Polarity	Reading Level dBµV/m	Correction Factor dB/m	PK Emission dBµV/m	Limit dBµV/m	Margin dBm	Emission Type
PK	5862.000000	H	68.67	4.90	73.57	114.00	40.43	Fundamental
PK	5862.000000	V	70.98	4.90	75.88	114.00	38.12	Fundamental
PK	17320.000000	H	33.53	18.12	51.65	74.00	22.35	Spurious
PK	16701.000000	V	33.39	17.87	51.26	74.00	22.74	Spurious

For AV Value

Radiated Emission								
Value	Emissions Frequency MHz	E-Field Polarity	Reading Level dBµV/m	Correction Factor dB/m	AV Emission dBµV/m	Limit dBµV/m	Margin dBm	Emission Type
AV	5862.000000	H	68.58	4.90	73.48	94.00	20.52	Fundamental
AV	5862.000000	V	70.85	4.90	75.75	94.00	18.25	Fundamental
AV	/	H	/	/	/	54.00	/	Spurious
AV	/	V	/	/	/	54.00	/	Spurious

Duty cycle=100%

Remark:

- 1: Data of measurement within this frequency range shown “/” in the table above means the reading of emissions are attenuated more than 20dB below the permissible limits or the field strength is too small to be measured.
- 2: “*” means the emission(s) appear within the restrict bands shall follow the requirement of section 15.205.
- 3: PK Emission = Reading Level + Correction Factor
 Correction Factor=Antenna Factor + Cable Loss (For Below 1GHz)
 Correction Factor = Antenna Factor + Cable Loss- Amplifier Gain (For Above 1GHz)
 (The Reading Level is recorded by software which is not shown in the sheet)

Duty Cycle: Duty Cycle=100%

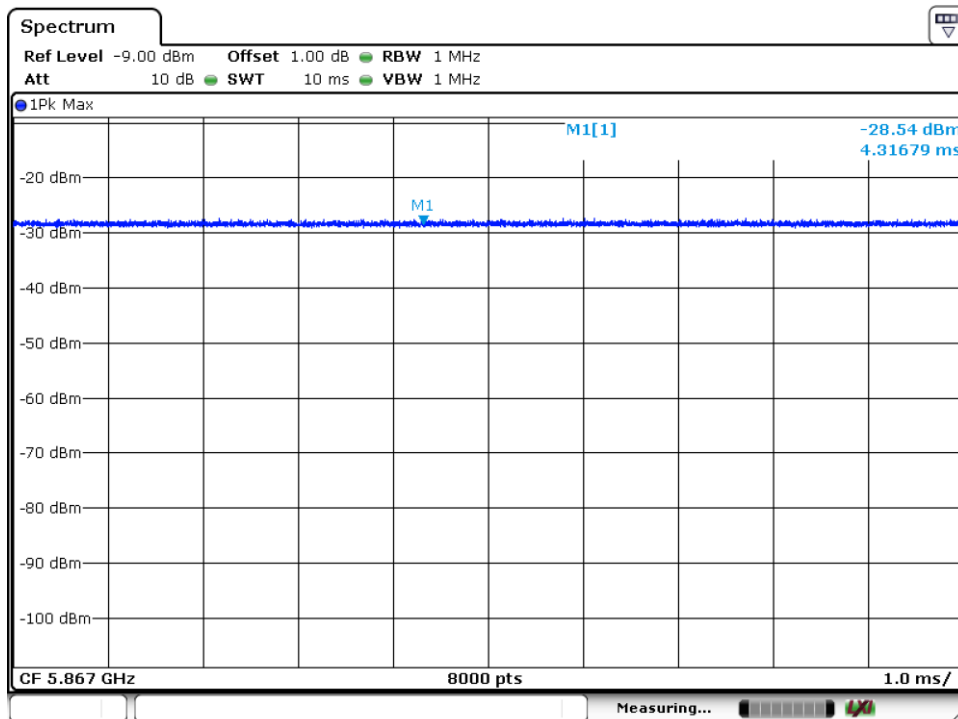

Date: 19.APR.2021 11:48:56

8.3 Out of Band Emissions

Test Method

- 1 Use the following spectrum analyzer settings:
Span = wide enough to capture the peak level of the in-band emission and all spurious
RBW = 100 kHz, VBW \geq RBW, Sweep = auto, Detector function = peak, Trace = max hold.
- 2 Allow the trace to stabilize, use the peak and delta measurement to record the result.
- 3 The level displayed must comply with the limit specified in this Section.

Limits

According to §15.249(d) & RSS-210 B.10 Emissions radiated outside of the specified frequency bands, except for harmonics, shall be attenuated by at least 50 dB below the level of the fundamental or to the general radiated emission limits in §15.209 and RSS-Gen, whichever is the lesser attenuation.

Out of Band Emissions

EUT: LED LINKABLE SHOPLIGHT

M/N: RD030015DG

Operating Condition: Tx; 5830MHz

Polarization: Horizontal

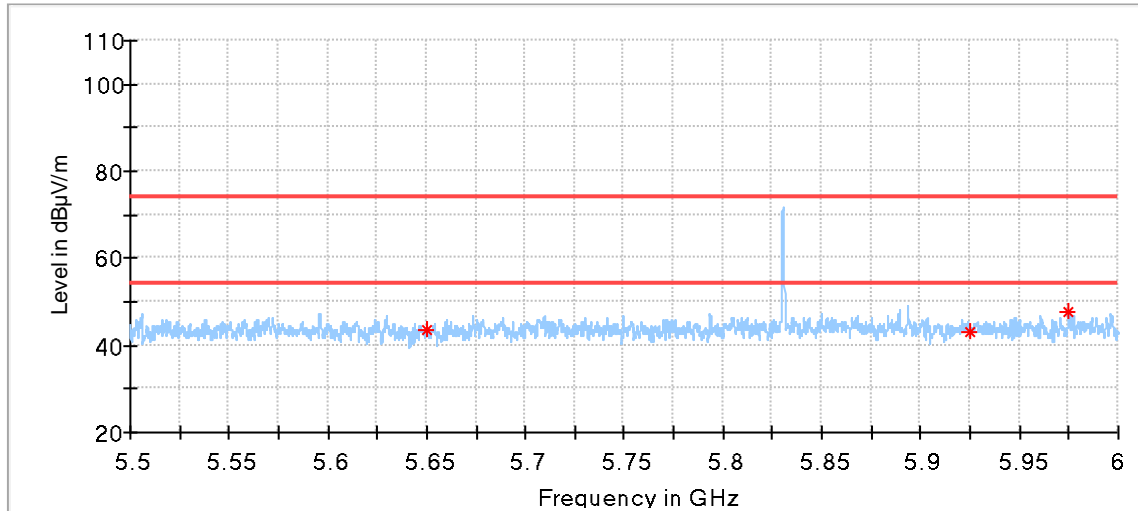

Critical Freqs

Frequency (MHz)	MaxPeak (dBµV/m)	Limit (dBµV/m)	Margin (dB)	Height (cm)	Pol	Azimuth (deg)	Corr. (dB/m)
5650.250000	43.74	68.39	24.65	150.0	H	83.0	4.05
5925.000000	43.08	68.20	25.12	150.0	H	238.0	4.84
5975.000000	47.56	68.20	20.64	150.0	H	0.0	4.96

Remark:

Level=Reading Level + Correction Factor

Correction Factor=Antenna Factor + Cable Loss – Pre-amplifier

(The Reading Level is recorded by software which is not shown in the sheet)

Out of Band Emissions

EUT: LED LINKABLE SHOPLIGHT
 M/N: RD030015DG
 Operating Condition: Tx; 5830MHz
 Polarization: Vertical

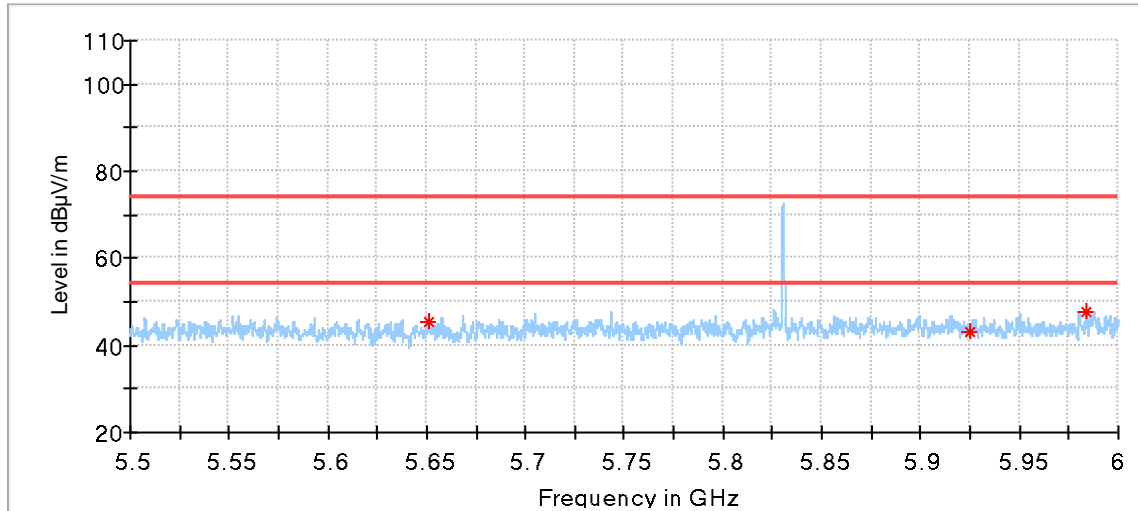

Critical Freqs

Frequency (MHz)	MaxPeak (dBµV/m)	Limit (dBµV/m)	Margin (dB)	Height (cm)	Pol	Azimuth (deg)	Corr. (dB/m)
5650.875000	45.53	68.85	23.32	150.0	V	187.0	4.05
5925.083333	43.14	68.20	25.06	150.0	V	246.0	4.84
5983.375000	47.87	68.20	20.33	150.0	V	268.0	4.98

Remark:

Level=Reading Level + Correction Factor

Correction Factor=Antenna Factor + Cable Loss – Pre-amplifier

(The Reading Level is recorded by software which is not shown in the sheet)

Out of Band Emissions

EUT: LED LINKABLE SHOPLIGHT

M/N: RD030015DG

Operating Condition: Tx; 5862MHz

Polarization: Horizontal

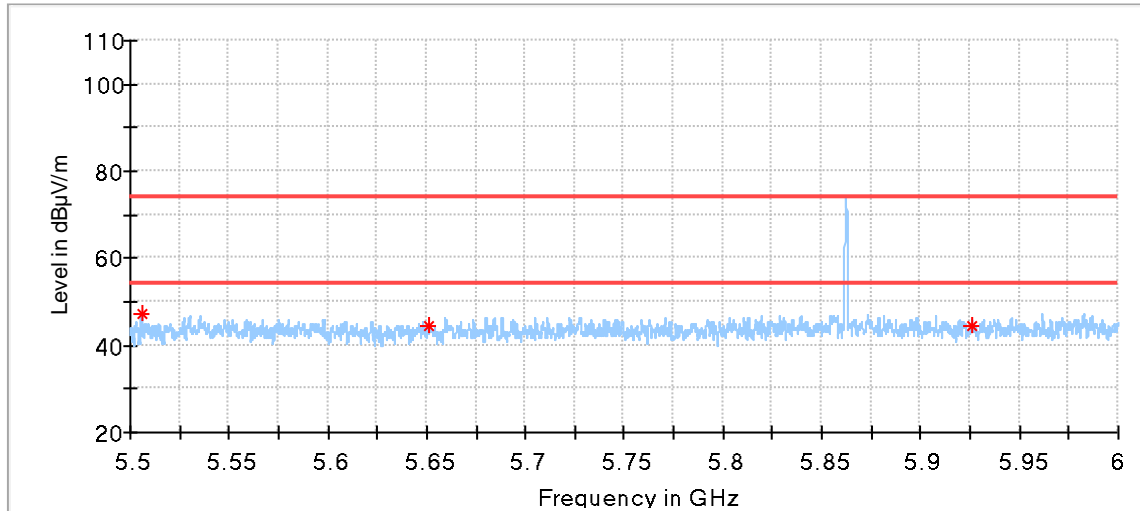

Critical Freqs

Frequency (MHz)	MaxPeak (dBµV/m)	Limit (dBµV/m)	Margin (dB)	Height (cm)	Pol	Azimuth (deg)	Corr. (dB/m)
5505.750000	47.39	68.20	20.81	150.0	H	158.0	4.38
5650.708333	44.54	68.72	24.18	150.0	H	0.0	4.05
5925.958333	44.33	68.20	23.87	150.0	H	144.0	4.84

Remark:

Level=Reading Level + Correction Factor

Correction Factor=Antenna Factor + Cable Loss – Pre-amplifier

(The Reading Level is recorded by software which is not shown in the sheet)

Out of Band Emissions

EUT: LED LINKABLE SHOPLIGHT

M/N: RD030015DG

Operating Condition: Tx; 5862MHz

Polarization: Vertical

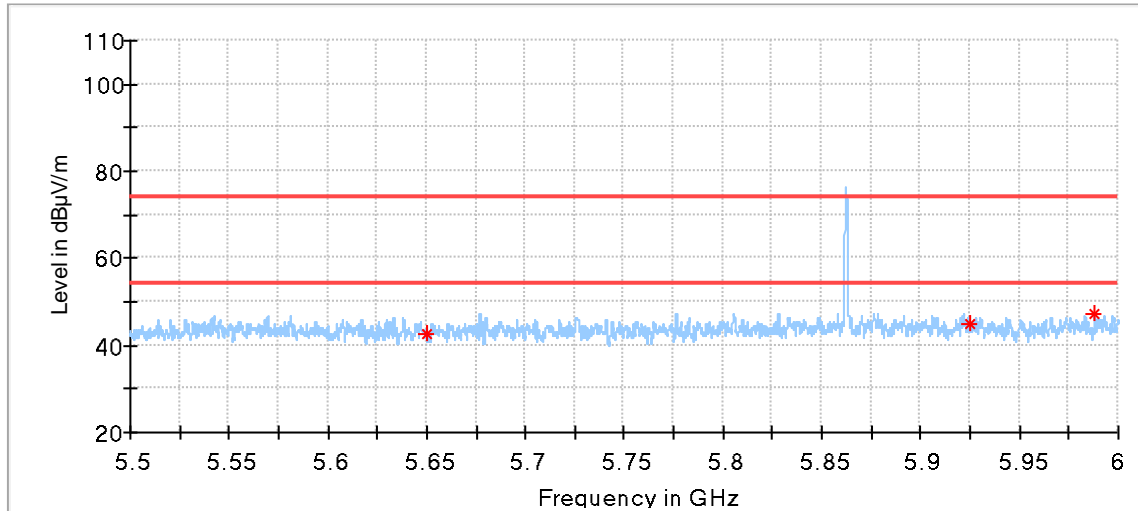

Critical Freqs

Frequency (MHz)	MaxPeak (dBµV/m)	Limit (dBµV/m)	Margin (dB)	Height (cm)	Pol	Azimuth (deg)	Corr. (dB/m)
5650.375000	42.60	68.48	25.88	150.0	V	109.0	4.05
5925.416667	45.05	68.20	23.15	150.0	V	231.0	4.84
5988.083333	47.03	68.20	21.17	150.0	V	205.0	5.00

Remark:

Level=Reading Level + Correction Factor

Correction Factor=Antenna Factor + Cable Loss – Pre-amplifier

(The Reading Level is recorded by software which is not shown in the sheet)

8.4 20dB Bandwidth & 99% Occupied Bandwidth

Test Method

1. Check the calibration of the measuring instrument using either an internal calibrator or a known signal from an external generator.
2. Position the EUT without connection to spectrum analyser. Turn on the EUT and connect it to measurement instrument. Then set it to any one convenient frequency within its operating range. Set a reference level on the measuring instrument equal to the highest peak value.
3. Measure the frequency difference of two frequencies that were attenuated 20dB from the reference level. Record the frequency difference as the emission bandwidth.

Limits:

According to 15.215 (c) Intentional radiators operating under the alternative provisions to the general emission limits, as contained in §§ 15.217 through 15.257 and in Subpart E of this part, must be designed to ensure that the 20 dB bandwidth of the emission, or whatever bandwidth may otherwise be specified in the specific rule section under which the equipment operates, is contained within the frequency band designated in the rule section under which the equipment is operated. The requirement to contain the designated bandwidth of the emission within the specified frequency band includes the effects from frequency sweeping, frequency hopping and other modulation techniques that may be employed as well as the frequency stability of the transmitter over expected variations in temperature and supply voltage. If a frequency stability is not specified in the regulations, it is recommended that the fundamental emission be kept within at least the central 80% of the permitted band in order to minimize the possibility of out-of-band operation.

According to RSS-Gen 6.7 when an occupied bandwidth value is not specified in the applicable RSS, the transmitted signal bandwidth to be reported is to be its 99% emission bandwidth, as calculated or measured.

20dB Bandwidth & 99% Occupied Bandwidth

Frequency	20dB Bandwidth	99% Bandwidth	Limit
MHz	MHz	MHz	MHz
5830	0.246	0.361	--

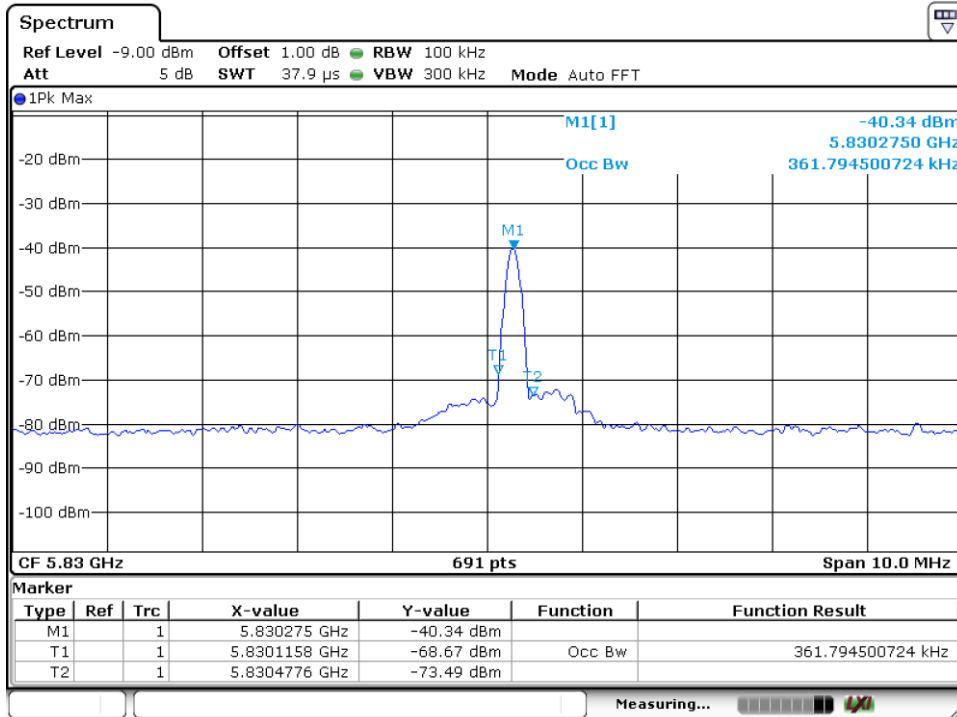

Date: 7.MAY.2021 17:16:41

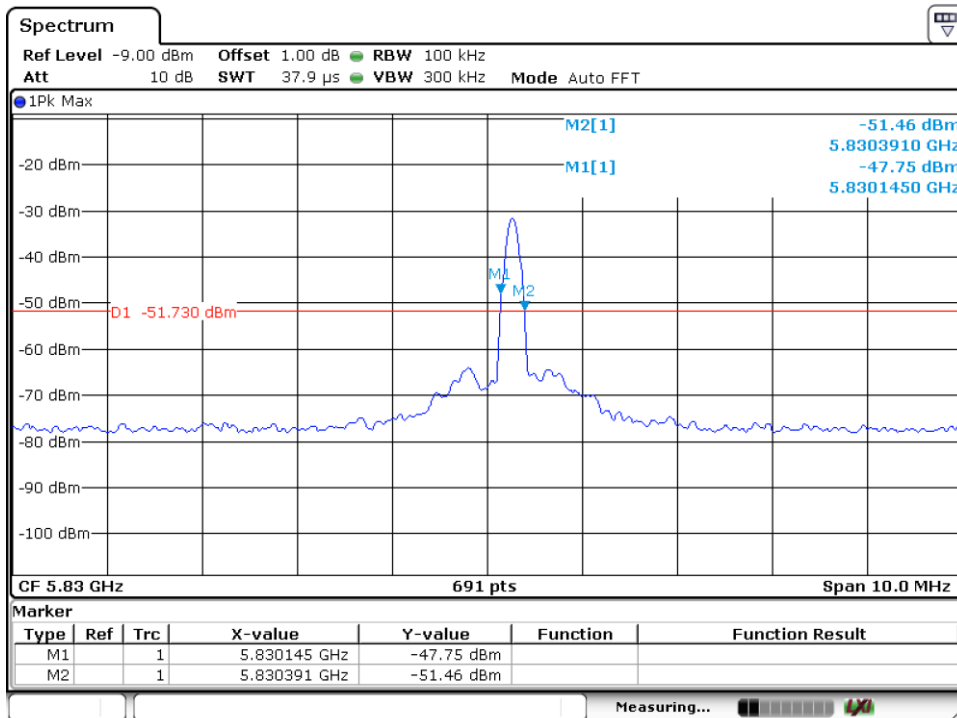

Date: 7.MAY.2021 15:30:50

5830MHz



20dB Bandwidth & 99% Occupied Bandwidth

Frequency	20dB Bandwidth	99% Bandwidth	Limit
MHz	MHz	MHz	MHz
5845	0.246	0.246	--

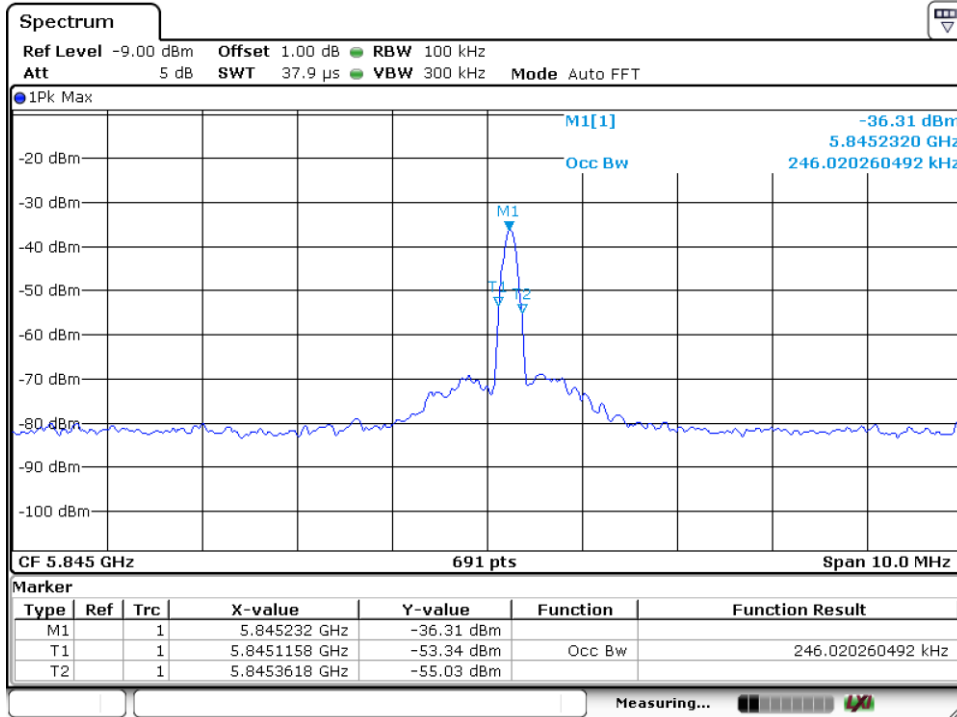

Date: 7.MAY.2021 17:10:55

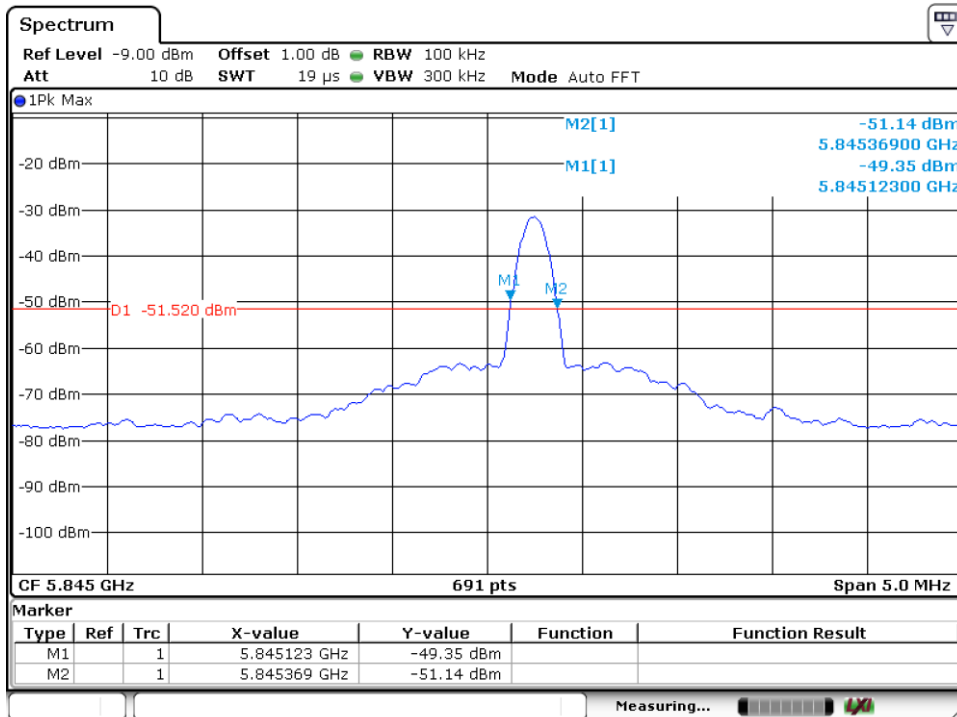

Date: 7.MAY.2021 15:33:39

5845MHz



20dB Bandwidth & 99% Occupied Bandwidth

Frequency	20dB Bandwidth	99% Bandwidth	Limit
MHz	MHz	MHz	MHz
5862	0.246	0.289	--

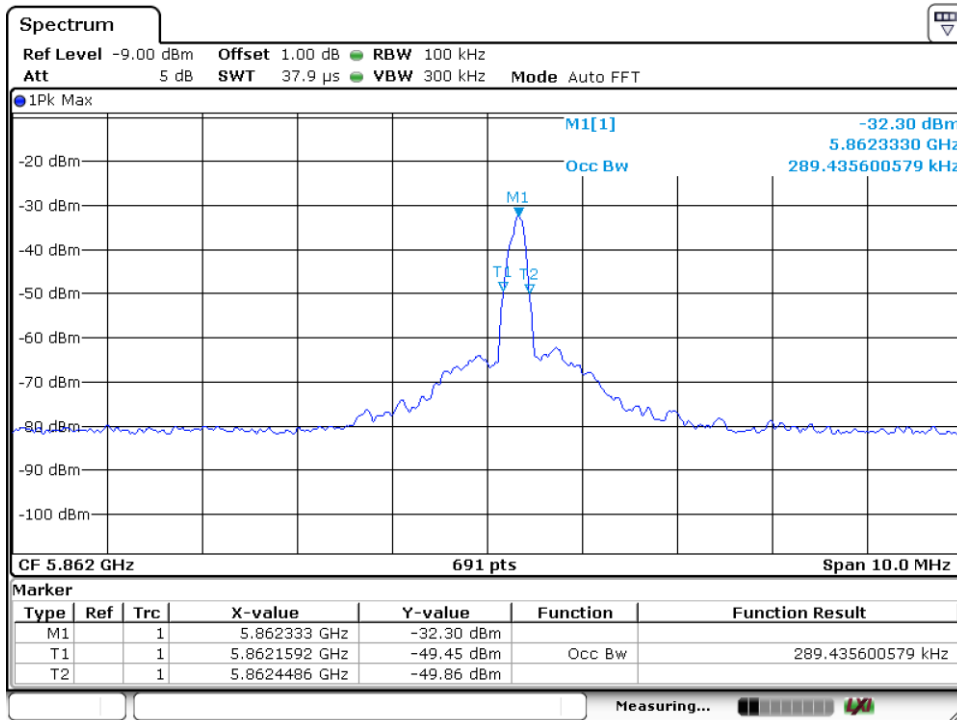

Date: 7.MAY.2021 17:12:30

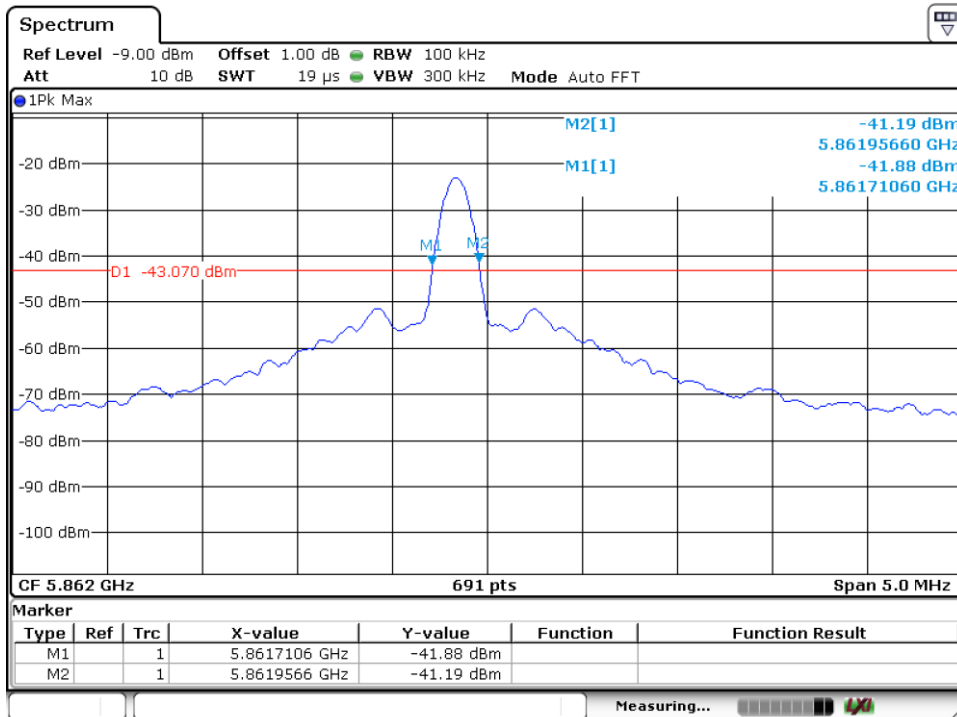

Date: 7.MAY.2021 15:25:33

5862MHz

9 Test equipment lists

Conducted Emission Test

DESCRIPTION	MANUFACTURER	MODEL NO.	EQUIPMENT ID	SERIAL NO.	CAL INTERVAL (YEAR)	CAL. DUE DATE
EMI Test Receiver	Rohde & Schwarz	ESR 3	68-4-74-14-001	101782	1	2021-6-29
LISN	Rohde & Schwarz	ENV4200	68-4-87-14-001	100249	1	2021-6-12
LISN	Rohde & Schwarz	ENV432	68-4-87-16-001	101318	1	2021-6-12
LISN	Rohde & Schwarz	ENV216	68-4-87-14-002	100326	1	2021-6-12
ISN	Rohde & Schwarz	ENY81	68-4-87-14-003	100177	1	2021-6-12
ISN	Rohde & Schwarz	ENY81-CA6	68-4-87-14-004	101664	1	2021-6-12
High Voltage Probe	Schwarzbeck	TK9420(VT9420)	68-4-27-14-001	9420-584	1	2021-6-23
RF Current Probe	Rohde & Schwarz	EZ-17	68-4-27-14-002	100816	1	2021-6-28
Attenuator	Shanghai Huaxiang	TS2-26-3	68-4-81-16-003	080928189	1	2021-6-21
Test software	Rohde & Schwarz	EMC32	68-4-90-14-003-A10	Version9.15.00	N/A	N/A
Shielding Room	TDK	CSR #1	68-4-90-19-004	----	1	2022-11-07

Radiated Emission 1# Test Site

DESCRIPTION	MANUFACTURER	MODEL NO.	EQUIPMENT ID	SERIAL NO.	CAL INTERVAL (YEAR)	CAL. DUE DATE
EMI Test Receiver	Rohde & Schwarz	ESR 7	68-4-74-19-001	102176	1	2021-6-29
Trilog Super Broadband Test Antenna	Schwarzbeck	VULB 9163	68-4-80-14-002	707	1	2021-8-4
Horn Antenna	Rohde & Schwarz	HF907	68-4-80-14-005	102294	1	2021-7-14
Loop Antenna	Rohde & Schwarz	HFH2-Z2	68-4-80-14-006	100398	1	2021-9-2
Pre-amplifier	Rohde & Schwarz	SCU 18	68-4-29-14-001	102230	1	2021-6-21
Attenuator	Agilent	8491A	68-4-81-16-001	MY39264334	1	2021-6-21
3m Semi-anechoic chamber	TDK	9X6X6	68-4-90-14-001	----	3	2022-10-28
Test software	Rohde & Schwarz	EMC32	68-4-90-14-001-A10	Version10.35.02	N/A	N/A

Radiated Emission 2# Test Site

DESCRIPTION	MANUFACTURER	MODEL NO.	EQUIPMENT ID	SERIAL NO.	CAL INTERVAL (YEAR)	CAL. DUE DATE
EMI Test Receiver	Rohde & Schwarz	ESR 26	68-4-74-14-002	101269	1	2021-6-29
Trilog Super Broadband Test Antenna	Schwarzbeck	VULB 9162	68-4-80-19-003	284	1	2022-2-23
Wave Guide Antenna	ETS	3117	68-4-80-19-001	00218954	1	2021-6-15
Pre-amplifier	Rohde & Schwarz	SCU 18F	68-4-29-19-001	100745	1	2021-10-25
Pre-amplifier	Rohde & Schwarz	SCU 08F2	68-4-29-19-004	08400018	1	2021-10-25
Sideband Horn Antenna	Q-PAR	QWH-SL-18-40-K-SG	68-4-80-14-008	12827	1	2021-8-5
Pre-amplifier	Rohde & Schwarz	SCU 40A	68-4-29-14-002	100432	1	2021-7-30
3m Semi-anechoic chamber	TDK	9X6X6	68-4-90-19-006	----	3	2022-12-29
Test software	Rohde & Schwarz	EMC32	68-4-90-19-006-A01	Version10.35.02	N/A	N/A

10 System Measurement Uncertainty

For a 95% confidence level, the measurement expanded uncertainties for defined systems, in accordance with the recommendations of ISO 17025 were:

System Measurement Uncertainty	
Test Items	Extended Uncertainty
Uncertainty for Conducted Emission 150kHz-30MHz (for test using AMN ENV432 or ENV4200)	3.21dB
Uncertainty for Radiated Emission in 3m chamber 30MHz-1000MHz	Horizontal: 5.12dB; Vertical: 5.10dB;
Uncertainty for Radiated Spurious Emission 1000MHz-3000MHz	Horizontal: 4.81dB; Vertical: 4.89dB;
Uncertainty for Radiated Spurious Emission 3000MHz-18000MHz	Horizontal: 4.69dB; Vertical: 4.68dB;
Uncertainty for Radiated Spurious Emission 18000MHz-40000MHz	Horizontal: 4.89dB; Vertical: 4.87dB;