



ROADCAM DUAL

Dual Lens Dashcam with App Control



BT532968

User Manual

**Important, retain for future reference:
Read carefully**



For more detailed instructions, please scan the QR code above or visit www.letsyada.com to access the complete user manual.

QUICK INSTALLATION GUIDE

Before you begin... Gather these items.

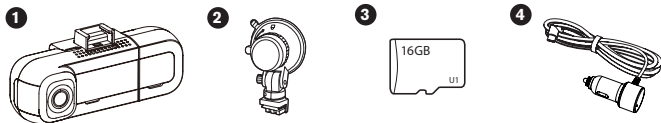

1. Mount the Roadcam

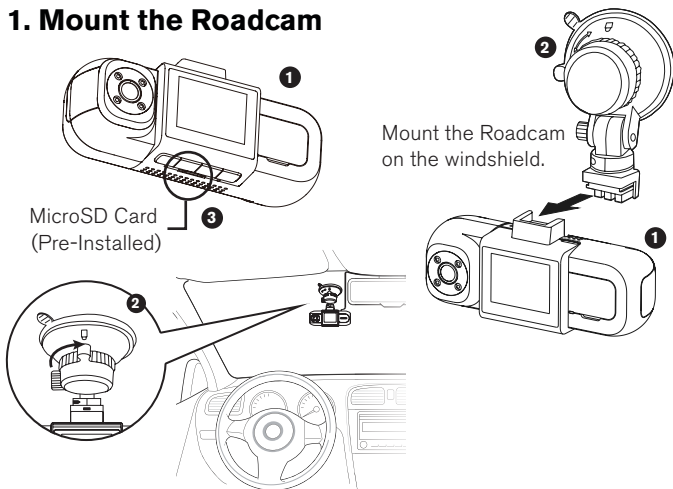

2. Connect to Power

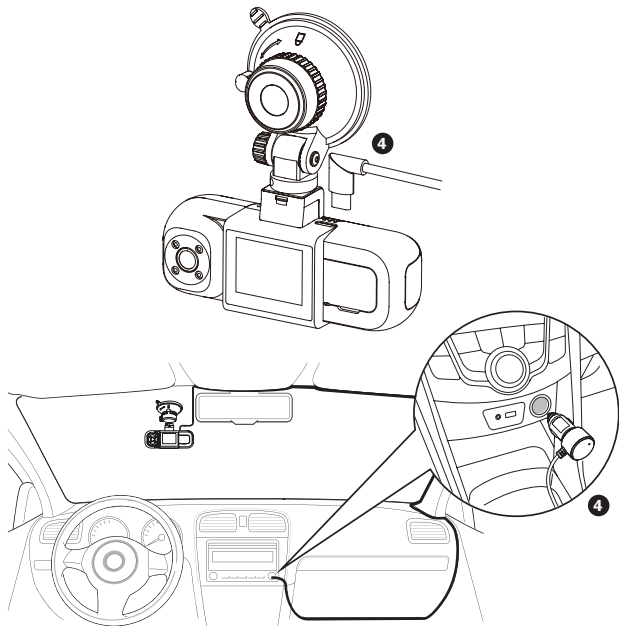

INTRODUCTION

Please read all of the installation instructions carefully before installing the product. Improper installation will void manufacturer's warranty. The installation instructions do not apply to all types of vehicles, and are written as guidelines to assist in installing the product.

Consult an experienced technician if you are not comfortable installing the product. You can also contact YADA at **1.866.294.9244** to speak to one of our installation specialists if you have any specific questions regarding the Roadcam Dual.

BEFORE using the Roadcam Dual, please read the safety information provided in this user manual. ALWAYS use the product as outlined in this user manual.

Please make sure to read and understand all local laws and regulations regarding cameras and their use in a vehicle. Laws vary by state.

PRODUCT SPECIFICATIONS

Display:	1.5 inch display
Lens:	Front View Camera - 135 degrees diagonal Cabin View Camera - 115 degrees diagonal
Video Resolution:	FHD (1920x1080)
Circular Video:	Seamless loop recording
Memory Card:	MicroSD (maximum support 64GB)
Microphone:	Supported
Built-in Audio:	Supported
Operating Temperature:	14°F ~ 140°F (-10°C ~ 60°C)
Operating Voltage:	Cigarette Lighter Adapter - DC 12/24V / DC 5V (USB-C)
Battery:	Built-in 300 mAh Li-ion battery

PACKAGE CONTENTS

1. 1 x Roadcam Dual
2. 1 x Windshield Mount
3. 1 x 16GB MicroSD Card
4. 1 x 12V/24V Power Adapter
5. 1 x Instruction Manual

1

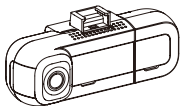

2



3



4

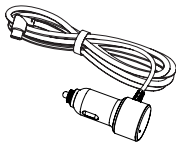

5

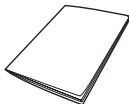

PRODUCT OVERVIEW

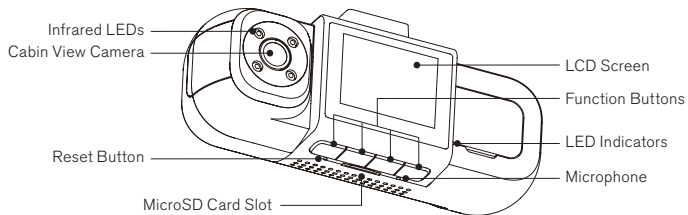
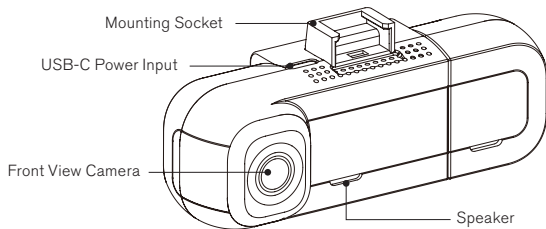

CAMERA CONTROLS

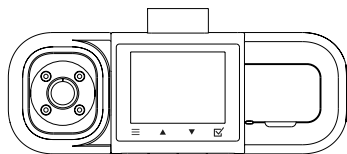

- ☰ Menu / Delete/Protect (press & hold)
Mode / Lock / Return / (click once)
- ▲ Up Navigation /
Switch View (click once)
- ▼ Down Navigation /
Microphone On/Off (click once)
- ☑ Power (press & hold)
OK / Record / Snapshot / Play/Pause
(click once)

For more information about Roadcam operation, please refer to the e-manual on www.letsyada.com.

CAMERA DIMENSIONS

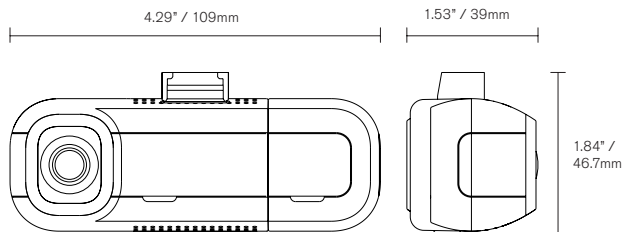

INSTALLATION

1.

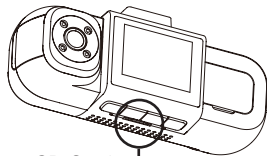

MicroSD Card
(Pre-Installed)

Peel off the protective film
from the LCD screen.

2.

Attach the
Roadcam to
the windshield
mount using the
socket on the
top.

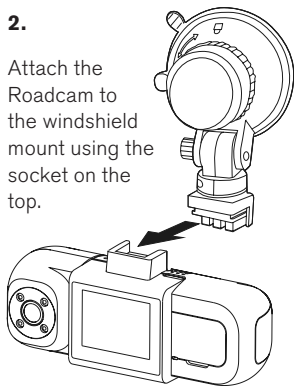

3.

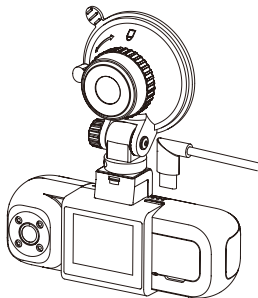

Plug the USB-C power cable into
the input port of the Roadcam.

NOTE: Power on and test camera
before mounting.

4.

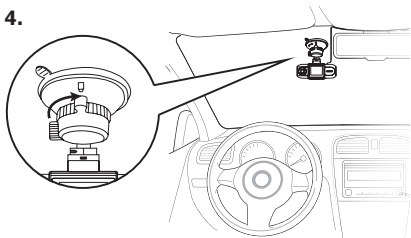

Attach the Roadcam onto the windshield. You can turn on the Roadcam and check the live screen to determine the most suitable mounting position. Utilize the knobs on the mount to tighten the suction cup.

WARNING: Do not install the product in a location where it can obstruct the driver's field of vision.

5. Adjust the Cabin View Camera's position to get the best interior view.

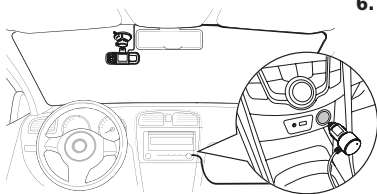
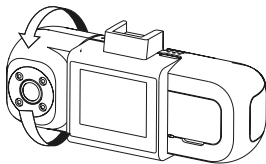

6. Route the power cable in the headliner and pillars in your vehicle. Plug the power adapter into your vehicle's 12/24V DC outlet. We recommend going through the passenger side to prevent the cable from getting into the driver's way.

BATTERY INDICATIONS

Please refer to the diagram below for the battery indication.



Fully charged



Battery moderately low



Battery low



Battery is empty



Charging

NOTE: The Roadcam is designed to be powered on while the vehicle is running. The built-in battery is only designed for storing documents when the vehicle's engine is off. The battery capacity of the built-in battery is limited. Please connect the Roadcam to the vehicle's on-board power supply for daily use.

DOWNLOADING THE APP



The Roadcam Dual auto sync function enables you to control and play back recorded media files using your smartphone with the YADA Drive APP. Scan the QR code on the right or search "YADA Drive" in the APP Store or Google Play. Download and install the APP.



Compatible with iPhone, iPad, Mac and iPod touch with iOS 11 or higher.



Compatible with devices with Android™ 7.0 or higher.

Help / FAQs

- 1) Problem: The Roadcam is unable to take pictures and record videos.
Solution: Please try formatting the MicroSD card.
- 2) Problem: The Roadcam shows that the memory card is full.
Solution: Please 1) Switch the G-sensor to "Medium" or "Low", 2) Turn off the Motion Detection, and 3) Take the MicroSD card out and clear the "Event" folder manually on your computer.
- 3) Problem: Message showing "SD card error".
Solution: Please format the MicroSD card. You'll find the "Format" feature in Menu.
- 4) Problem: The image looks foggy.
Solution: Please try cleaning the camera lens.
- 5) Problem: The image looks too dark.
Solution: If the Roadcam captures an image that is too dark, adjust the exposure level to your desired brightness.
- 6) Question: Can I buy my own MicroSD memory card?
Answer: Yes, but please make sure you purchase one that is U1 rated with the max capacity of 64GB.

SAFETY INFORMATION

IMPORTANT SAFETY INSTRUCTIONS

1. **SAVE THESE INSTRUCTIONS** – This manual contains important safety and operating instructions of the 12V/24V cigarette lighter adapter for Model BT532968.
2. Before using the product, read all instructions and cautionary markings.
3. Do not expose cigarette lighter adapter to rain, moisture, or snow.
4. Use of an attachment not recommended or sold by the product manufacturer may result in a risk of fire, electric shock, or injury to persons.
5. To reduce risk of damage to cigarette lighter connector and cord, pull by cigarette lighter connector rather than cord when disconnecting cigarette lighter adapter.
6. Make sure cord is carefully secured so that it will not be stepped on, tripped over, or otherwise subjected to damage or stress.
7. Do not operate cigarette lighter adapter with damaged cord or cigarette lighter connector – replace it immediately.
8. Do not operate cigarette lighter adapter if it has received a sharp blow, been dropped, or otherwise damaged in any way; take it to a qualified serviceperson.
9. Do not disassemble cigarette lighter adapter; take it to a qualified serviceperson when service or repair is required. Incorrect reassembly may result in a risk of electric shock or fire.
10. To reduce risk of electric shock, unplug cigarette lighter adapter before attempting any maintenance or cleaning. Turning off controls will not reduce this risk.

WARNING: A failure to read and follow these warnings and instructions may result in a serious accident, including damaged property or a serious injury, including loss of life.

- The Roadcam Dual is designed as an aid to the driver in detecting large stationary objects to help avoid damaging the vehicle. However, you, the driver, must use it safely and properly. Use of the Roadcam Dual is not a substitute for safe, proper and legal driving.
- Never depend on the Roadcam Dual entirely when driving. The image on the screen is different from actual conditions. Objects viewed in the Roadcam Dual display screen differ from actual distance because a wide-angle lens is used.
- The Roadcam Dual "Night Vision" feature that is high performance brightness with colorful image is an aid to a driver but is limited. Always use your own eyes to confirm the vehicle's surroundings, as the displayed image may be faint or dark, distorted, or not entirely visible.
- Always check behind and all around the vehicle visually with mirrors before proceeding.
- The area displayed by the Roadcam Dual is limited. The Roadcam Dual does not display objects that are out of the camera's field of view. The area displayed on the screen may vary according to vehicle orientation or road conditions.
- Be sure to check the camera's position and mounting angle before each use.
- Do not strike the Roadcam Dual. It is a precision instrument. Otherwise, it may malfunction or cause damage resulting in a fire or an electric shock.
- This product will only provide images of items that are within the field of view of the Roadcam Dual. Thus, it is imperative that the Roadcam Dual should be kept clean and unobstructed.
- Adhere to all applicable traffic laws and motor vehicle regulations applicable to the device.

- Consult local laws and regulations for any restrictions on installation or use.
- Never allow children to play with the device. Small parts may be a choking hazard.
- There is a plastic cover over the Roadcam Dual. Do not scratch the cover when cleaning dirt or snow from it.
- If the temperature changes rapidly, the system may not operate normally.
- When strong light directly enters a camera, objects may not be displayed clearly.
- The screen may flicker under fluorescent light.
- The colors of objects on the Roadcam Dual may differ from those of the actual objects.
- Do not use alcohol or thinner to clean the camera. This will cause discoloration. To clean the camera, wipe with a clean cloth dampened with mild cleaner diluted with water and then wipe with a dry cloth.

Safety Around and Behind Other Vehicles

Using a Roadcam Dual is not enough to completely overcome a vehicle's blind spot. Many preventable injuries and deaths occur in driveways or parking lots when drivers do not see children, pets, or others near their vehicles. Here are a few safety tips that will help you to avoid an accident:

- Walk completely around your vehicle before getting in. Check for kids, toys, and pets before entering the vehicle and starting the engine.
- Know where children are. Have children stand in a place where they are in full view.
- Be aware of young children. Young children are small and hard to see.
- Parents, caregivers and all adults need to be vigilant in supervising children, especially when children are in the yard, driveway or parking lot playing near parked cars.

- Roll down your window so you will be able to hear what is happening outside your vehicle.
- Owners of SUVs, trucks, and vans need to take extra care to avoid hitting or running over a child.
- Teach children to move away from a vehicle whenever it is started.

MAINTENANCE & WARRANTY

Cleaning

- If dirt, rain or snow attaches to the camera, the display screen may not clearly display objects. If water droplets, snow or mud adhere to the camera lens, rinse with water and wipe with a dry cloth.
- Do not use alcohol, benzene or thinner to clean the camera. This will cause discoloration. To clean the camera, wipe with a clean cloth dampened with mild cleaner diluted with water and then wipe with a dry cloth.

Warranty

YADA LIMITED WARRANTY

YADA warrants, to the original purchaser, that its products are free from defects in material and workmanship for 1 year from the date of original purchase. Where permitted by law, YADA's liability shall be limited to that set forth in this limited express warranty. This limited express warranty shall be the exclusive remedy of the purchaser and YADA makes no other warranty of any kind aside from the limited express warranty stated above.

NOTE: Warranty only applies for North American customers of purchases made in North America.

CONDITIONS OF WARRANTY

If during the 1 year warranty period your new product is found to be defective, YADA will repair such defect, or replace the product, without charge for parts or labor subject to the following conditions:

1. All repairs must be performed by YADA.
2. All warranty claims must be accompanied by a copy of the sales receipt or bill of sale.
3. The equipment must not have been altered or damaged through negligence, accident, improper operation, or failure to follow the product instructions for installation, use, or care.
4. The replacement of parts is excluded from the warranty when replacement is necessary due to normal wear and tear.
5. Repair or replacement parts supplied by YADA under this warranty are protected only for the unexpired portion of the original warranty.
6. This is a "repair or replace" warranty only, and does not cover the costs incurred for the installation, removal or reinstallation of the product, or damage to any mobile phone device or vehicle.

OWNER'S RESPONSIBILITIES:

YADA will make every effort to provide warranty service within a reasonable period of time. SHOULD YOU HAVE ANY QUESTIONS ABOUT SERVICE RECEIVED OR IF YOU WOULD LIKE ASSISTANCE IN OBTAINING SERVICE, PLEASE CALL TOLL FREE 1.866.294.9244 DURING REGULAR BUSINESS HOURS MONDAY THROUGH FRIDAY 8:00 AM TO 5:00PM.

Note: Toll Free # is for North America Customers ONLY. See Customer service section for customer contact numbers for other regions/offices.

For customer service and technical support, please call us at 1.866.294.9244. If at that time it is determined that a replacement unit is

needed, the support representative will issue a Return Authorization and instruct on how to get a new unit.

YADA makes no other warranty of any kind aside from the limited express warranty stated herein.

DISCLAIMER OF WARRANTIES, INCLUDING WARRANTY OF MERCHANTABILITY AND WARRANTY OF FITNESS FOR PARTICULAR PURPOSE: EXCEPT AS SPECIFICALLY SET FORTH HEREIN, NO WARRANTY OR REPRESENTATION, EXPRESS OR IMPLIED, IS MADE AS TO THE ROADCAM DUAL. EXCEPT AS EXPRESSLY SET FORTH HEREIN, YADA AND/OR ITS AFFILIATES EXPRESSLY DISCLAIMS, WITHOUT LIMITATION, ANY STATUTORY WARRANTIES AND ALL IMPLIED WARRANTIES, INCLUDING ANY IMPLIED WARRANTY OF MERCHANTABILITY OR FITNESS FOR A PARTICULAR PURPOSE.

YADA and/or its affiliates do not guarantee or promise that the user of Roadcam Dual will not be in an accident or otherwise not collide with an object and/or person. Our Roadcam Dual is not intended in any way to be a substitute for careful and cautious driving or for the consistent adherence to all applicable traffic laws and motor vehicle safety regulations.

The Roadcam Dual is not intended to be a substitute for rearview mirrors or for any other motor vehicle equipment mandated by law. Even when properly installed, our Roadcam Dual has a limited field of vision and does not provide a comprehensive view of the rear area of the vehicle.

YADA and/or its affiliates are not responsible for a user's intended or actual use of the Roadcam Dual. In no event shall YADA and/ or its affiliates have any liability for any losses (whether direct or indirect, in contract, tort

not limited to damaged property, personal injury and/or loss of life. Neither shall YADA and/or its affiliates have any liability for any decision, action or inaction taken by any person in reliance on the Roadcam Dual, or for any delays, inaccuracies and/or errors in connection with the Roadcam Dual and its functioning.

YADA and/or its affiliates shall have no responsibility or liability for damage and/or injury resulting from accidents occurring with vehicles having the installed, and YADA and/or its affiliates, the manufacturer, distributor and seller shall not be liable for any injury, loss or damage, incidental or consequential, arising out of the use or intended use of the product.

GENERAL INFORMATION

Customer Service/Contact

IF YOU ARE EXPERIENCING ANY ISSUES WITH THE PRODUCT DURING OPERATION, DO NOT RETURN THE PRODUCT TO THE STORE. CONTACT YADA DIRECTLY FOR INSTRUCTIONS ON HOW TO RETURN/ EXCHANGE THE PRODUCT.

FCC Compliance Statement:

This device complies with Part 15 of the FCC rules. Operation is subject to the following two conditions: (1) This device may not cause harmful interference, and (2) this device must accept any interference received, including interference that may cause undesired operation.

WARNING: Changes or modifications to this unit not expressly approved by the party responsible for compliance could void the user's authority to operate the equipment. The manufacturer is not responsible for any radio or TV interference caused by unauthorized modifications or change to this

equipment. Such modifications or change could void the user's authority to operate the equipment.

NOTE: This equipment has been tested and found to comply with the limits for a Class B digital device, pursuant to part 15 of the FCC Rules. These limits are designed to provide reasonable protection against harmful interference in a residential installation. This equipment generates, uses and can radiate radio frequency energy and, if not installed and used in accordance with the instructions, may cause harmful interference to radio communications. However, there is no guarantee that interference will not occur in a particular installation. If this equipment does cause harmful interference to radio or television reception, which can be determined by turning the equipment off and on, the user is encouraged to try to correct the interference by one or more of the following measures:

- Reorient or relocate the receiving antenna.
- Increase the separation between the equipment and the receiver.
- Connect the equipment into an outlet on a circuit different from that to which the receiver is connected.
- Consult the dealer or an experienced radio/TV technician for help.

This equipment complies with FCC RF radiation exposure limits set forth for an uncontrolled environment. In order to avoid the possibility of exceeding the FCC radio frequency exposure limits, human proximity to the antenna shall not be less than 20cm during normal operation.

 **WARNING:** This product can expose you to chemicals including Di(2-ethylhexyl)phthalate (DEHP) and Diisononyl Phthalate (DINP), which are known to the State of California to cause cancer and birth defects or other reproductive harm. For more information go to www.P65Warnings.ca.gov.

Android is a trademark of Google Inc.
iPhone, iPad, Mac and iPod touch are trademarks of Apple Inc.

Roadcam Dual
Dual Lens Dashcam with App Control
BT532968
Responsible Party:
YADA
2975 Red Hill Ave., Ste. 100,
Costa Mesa, CA 92626
Tel: 1.866.294.9244

NOTES



Product code / Code de produit / Código del producto : BT532968

Register this product within 30 days of purchase to receive one **(1) additional year** of warranty coverage (beyond the standard 1-year warranty), along with special product offers and announcements.

Enregistrez ce produit dans les 30 jours suivant l'achat pour recevoir une couverture **supplémentaire de 1 AN** (au-delà de la garantie standard d'un an), ainsi que des offres et des annonces spéciales.

Registre este producto dentro de los 30 días siguientes a la compra para recibir un **(1) año adicional** de cobertura de garantía (más allá de la garantía estándar de un año), junto con ofertas de productos y anuncios especiales.

www.letsyada.com/register



@letsyada



Please contact our customer service before returning this product to the store. Our friendly representatives are happy to help with any questions or concerns you have.

Veuillez communiquer avec notre service à la clientèle avant de retourner le produit au magasin. Nos représentants se feront un plaisir de vous assister pour toute question ou préoccupation.

Póngase en contacto con nuestro servicio a clientes antes de regresar este producto a la tienda. A nuestros amables representantes les dará mucho gusto ayudarle con cualquier pregunta o inquietud que tenga.

**Mon-Fri, 8am-5pm PST / Lundi au vendredi, 8h à 17h HNP /
Lun-vie, 8 a. m. a 5 p. m. Hora del Pacífico
customercare@horizon-brands.com / 1.866.294.9244**



CONNECT
WITH US



@letsyada

2975 Red Hill Ave., Ste. 100, Costa Mesa, CA 92626
1.866.294.9244 | customercare@horizon-brands.com

© 2023 ADC Solutions Auto, LLC.

www.letsyada.com

ML-532968_V1

Product Label Information can be accessed at **Regulatory Info** page as follows.

Starting from Main Menu:

Step 1. Open Settings Menu

Step 2. Switch to System Setting

Step 3. Go to Regulatory Info

YADA

Model: BT532968

Product Name:

ROADCAM DUAL

Input rating: 5V $\overline{=}$ 600mA



1/2

FCC ID: WUI-M08PRO

This device complies with Part 15 of the FCC rules. Operation is subject to the following two conditions:

(1) This device may not cause harmful interference, and

(2) this device must accept any interference received, including interference that may cause undesired operation.

Made in Indonesia

2/2