



FCC/IC - TEST REPORT

Report Number : **68.940.18.0027.01** Date of Issue: September 10, 2018

Model : **LM561232**

Product Type : Microwave sensor for Ceiling light

Applicant : Winplus Co., Ltd.

Address : Suites 6-11, 7th Floor, Corporation Park, 11 On Lai Street, Shatin,
Hong Kong

Manufacture : Winplus Co., Ltd.

Address : Suites 6-11, 7th Floor, Corporation Park, 11 On Lai Street, Shatin,
Hong Kong

Test Result : **Positive** **Negative**

Total pages including Appendices : 27

TÜV SÜD Certification and Testing (China) Co., Ltd. Shenzhen Branch is a subcontractor to TÜV SÜD Product Service GmbH according to the principles outlined in ISO 17025.

TÜV SÜD Certification and Testing (China) Co., Ltd. Shenzhen Branch reports apply only to the specific samples tested under stated test conditions. Construction of the actual test samples has been documented. It is the manufacturer's responsibility to assure that additional production units of this model are manufactured with identical electrical and mechanical components. The manufacturer/importer is responsible to the Competent Authorities in Europe for any modifications made to the production units which result in non-compliance to the relevant regulations. TÜV SÜD Certification and Testing (China) Co., Ltd. Shenzhen Branch shall have no liability for any deductions, inferences or generalizations drawn by the client or others from TÜV SÜD Certification and Testing (China) Co., Ltd. Shenzhen Branch issued reports.

This report is the confidential property of the client. As a mutual protection to our clients, the public and ourselves, extracts from the test report shall not be reproduced except in full without our written approval



1 Table of Contents

1 Table of Contents.....	2
2 Details about the Test Laboratory.....	3
3 Description of the Equipment Under Test.....	4
4 Summary of Test Standards.....	5
5 Summary of Test Results.....	6
6 General Remarks.....	7
7 Test setups.....	8
8 Technical Requirement.....	9
8.1 Conducted Emission.....	9
8.2 Field strength of emissions and Restricted bands.....	12
Field strength of emissions and Restricted bands.....	13
8.3 Out of Band Emissions.....	17
8.4 20dB Bandwidth & 99% Occupied Bandwidth.....	22
9 Test equipment list.....	26
10 System Measurement Uncertainty.....	27



2 Details about the Test Laboratory

Details about the Test Laboratory

Test Site 1

Company name: TÜV SÜD Certification and Testing (China) Co., Ltd. Shenzhen Branch
Building 12&13, Zhiheng Wisdomland Business Park,
Nantou Checkpoint Road 2, Nanshan District,
Shenzhen City, 518052,
P. R. China

FCC Registration Number: 514049

IC Registration Number: 10320A-1

Telephone: 86 755 8828 6998
Fax: 86 755 8828 5299

3 Description of the Equipment Under Test

Description of the Equipment Under Test

Product:	Microwave sensor for Ceiling light
Model no.:	LM561232
FCC ID:	WUI-LM561232
IC:	7297A-LM561232
Options and accessories:	NIL
Ratings:	8-12VDC (Supplied by LED driver)
RF Transmission Frequency:	5750MHz - 5856MHz
Modulation:	Unmodulated
Antenna Type:	PCB
Antenna Gain:	0dBi
Description of the EUT:	The product is a Microwave sensor for Ceiling light that operated at 5.8GHz, The TX and RX range is 5750MHz - 5856MHz

Auxiliary Equipment Used during Test:

DESCRIPTION	MANUFACTURER	RATINGS	MODEL NO.(SHIELD)
LED driver	WINPLUS	Input: 100-240VAC, 50/60Hz, 22W, 200Ma Output: 30-40VDC, 17W, 480mA	---

4 Summary of Test Standards

Test Standards	
FCC Part 15 Subpart C 10-1-2017 Edition	PART 15 - RADIO FREQUENCY DEVICES Subpart C - Intentional Radiators
RSS-Gen Issue 5 April 2018	General Requirements and Information for the Certification of Radio Apparatus
RSS-210 Issue 9 August 2016	RSS-210 — Licence-exempt Radio Apparatus (All Frequency Bands): Category I Equipment

All the test methods were according to ANSI C63.10-2013.

5 Summary of Test Results

Technical Requirements					
FCC Part 15 Subpart C 15.249, RSS-Gen, RSS-210					
Test Condition	Pages	Test Site	Test Result		
			Pass	Fail	N/A
15.207 & RSS-Gen A8.8 Conducted emission AC power port	9	Site 1	<input checked="" type="checkbox"/>	<input type="checkbox"/>	<input type="checkbox"/>
§15.205(a), §15.209(a), §15.249(a), §15.249(c) & RSS-210 B.10, RSS-GEN 6.13/8.9/8.10 Field strength of emissions and Restricted bands	12	Site 1	<input checked="" type="checkbox"/>	<input type="checkbox"/>	<input type="checkbox"/>
§15.249(d), RSS-210 B.10 Out of band emissions	21	Site 1	<input checked="" type="checkbox"/>	<input type="checkbox"/>	<input type="checkbox"/>
FCC §15.215(c) 20dB bandwidth & RSS-Gen 6.7 99% Occupied Bandwidth	26	Site 1	<input checked="" type="checkbox"/>	<input type="checkbox"/>	<input type="checkbox"/>
§15.203, RSS-GEN 6.8 Antenna requirement	See note 1		<input checked="" type="checkbox"/>	<input type="checkbox"/>	<input type="checkbox"/>

Remark 1: N/A- Not Applicable;

Note 1: The EUT used an integral PCB antenna, which gain is 0 dBi. According to §15.203, it is considered sufficiently to comply with the provisions of this section.

6 General Remarks

Remarks

This submittal(s) (test report) is intended for FCC ID: WUI-LM561232 and IC: 7297A-LM561232 complies with Section 15.207, 15.205, 15.209, 15.249 of the FCC Part 15, Subpart C Rules; RSS-Gen Issue 5 and RSS-210 issue 9.

SUMMARY:

All tests according to the regulations cited on page 5 were

- Performed

- **Not** Performed

The Equipment Under Test

- **Fulfills** the general approval requirements.

- **Does not** fulfill the general approval requirements.

Sample Received Date: July 12, 2018

Testing Start Date: July 12, 2018

Testing End Date: August 08, 2018

- TÜV SÜD Certification and Testing (China) Co., Ltd. Shenzhen Branch -

Reviewed by:

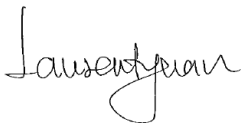

Laurent Yuan
EMC Project Manager

Prepared by:



Henry Chen
EMC Project Engineer

Tested by:



Louise Liu
EMC Test Engineer

7 Test setups

7.1 AC Power Line Conducted Emission test setups

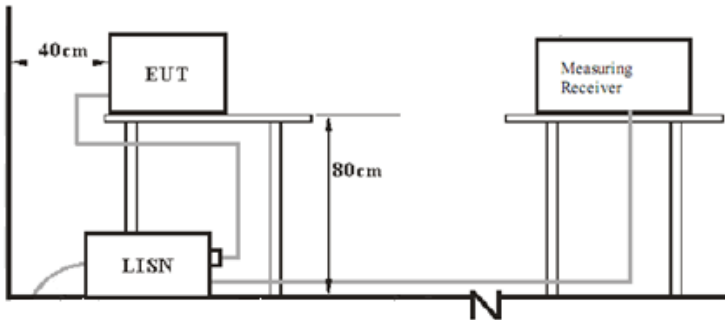

7.2 Radiated test setups

Below 1GHz



Above 1GHz

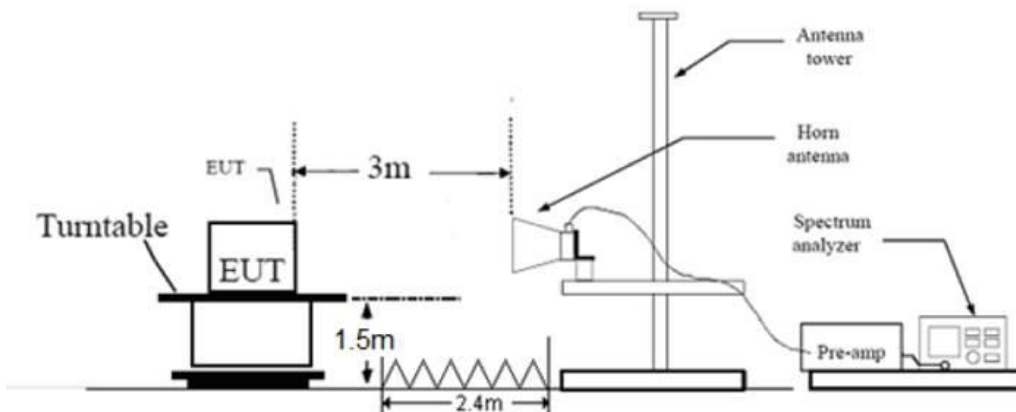

8 Technical Requirement

8.1 Conducted Emission

Test Method

1. The EUT was placed on a table, which is 0.8m above ground plane
2. The power line of the EUT is connected to the AC mains through a Artificial Mains Network (A.M.N.).
3. Maximum procedure was performed to ensure EUT compliance
4. A EMI test receiver is used to test the emissions from both sides of AC line

Limit

Frequency MHz	QP Limit dB μ V	AV Limit dB μ V
0.150-0.500	66-56*	56-46*
0.500-5	56	46
5-30	60	50

*Decreasing linearly with logarithm of the frequency.

Conducted Emission

Product Type : Microwave sensor for Ceiling light
 M/N : LM561232
 Operating Condition : Normal working with transmitting
 Test specification : Positive
 Comment : AC 120V/60Hz (Powered by Ceiling Light)

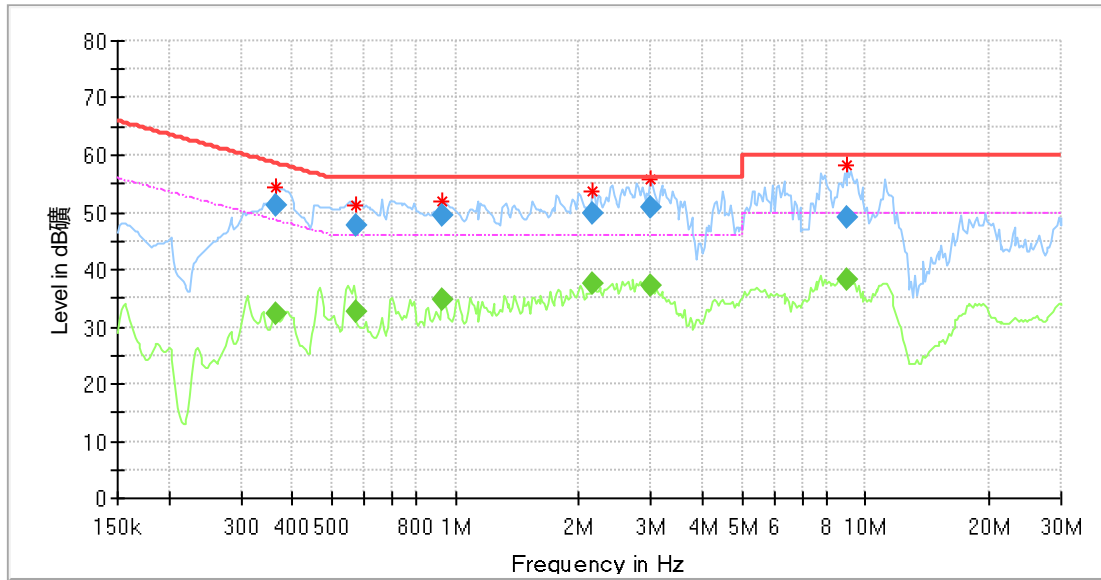

Frequency (MHz)	QuasiPeak (dBµV)	Average (dBµV)	Limit (dBµV)	Margin (dB)	Line	Corr. (dB)
0.366423	---	32.25	48.58	16.33	L1	10.7
0.366423	51.37	---	58.58	7.21	L1	10.7
0.570247	---	32.71	46.00	13.29	L1	10.2
0.570247	47.60	---	56.00	8.40	L1	10.2
0.931389	---	34.74	46.00	11.26	L1	10.2
0.931389	49.49	---	56.00	6.51	L1	10.2
2.154336	---	37.53	46.00	8.47	L1	10.3
2.154336	49.93	---	56.00	6.07	L1	10.3
3.002455	---	37.18	46.00	8.82	L1	10.3
3.002455	51.02	---	56.00	4.98	L1	10.3
9.051353	---	38.14	50.00	11.86	L1	10.6
9.051353	49.26	---	60.00	10.74	L1	10.6

Conducted Emission

Product Type : Microwave sensor for Ceiling light
 M/N : LM561232
 Operating Condition : Normal working with transmitting
 Test specification : Negative
 Comment : AC 120V/60Hz (Powered by Ceiling Light)

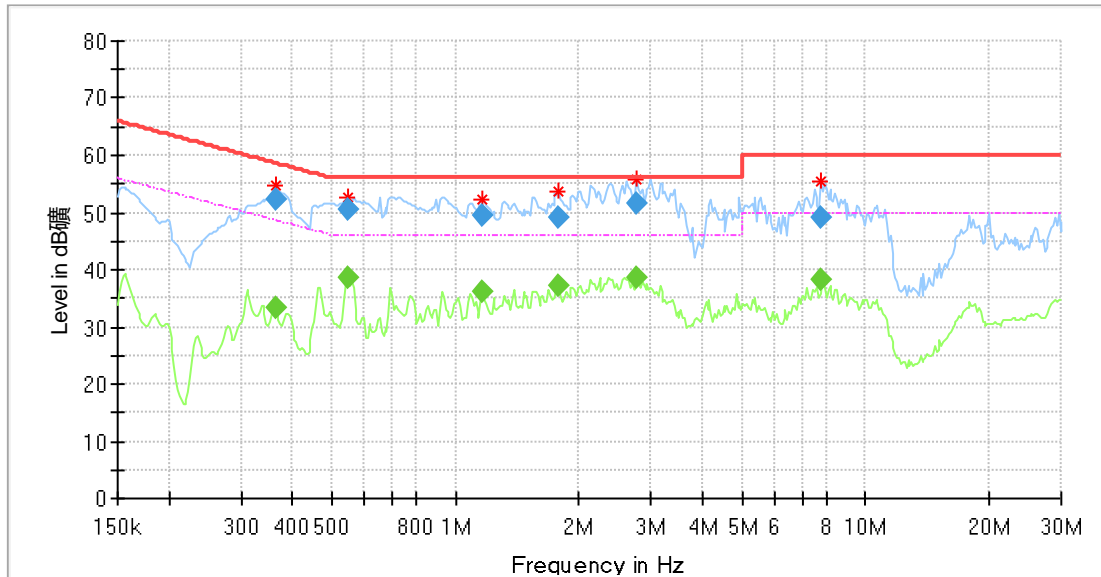

Frequency (MHz)	QuasiPeak (dBµV)	Average (dBµV)	Limit (dBµV)	Margin (dB)	Line	Corr. (dB)
0.362751	---	33.43	48.67	15.24	N	10.3
0.362751	52.12	---	58.67	6.55	N	10.3
0.547776	---	38.44	46.00	7.56	N	10.4
0.547776	50.42	---	56.00	5.58	N	10.4
1.157882	---	36.15	46.00	9.85	N	10.4
1.157882	49.63	---	56.00	6.37	N	10.4
1.791455	---	37.14	46.00	8.86	N	10.4
1.791455	49.13	---	56.00	6.87	N	10.4
2.773061	---	38.76	46.00	7.24	N	10.5
2.773061	51.51	---	56.00	4.49	N	10.5
7.788002	---	38.32	50.00	11.68	N	10.7
7.788002	48.95	---	60.00	11.05	N	10.7

8.2 Field strength of emissions and Restricted bands

Test Method

- 1: The EUT was placed on a turn table which is 1.5m above ground plane for above 1GHz and 0.8m above ground for below 1GHz at 3-meter chamber room for test. The table was rotated 360 degrees to determine the position of the highest radiation.
- 2: The EUT was set 3 meters away from the interference – receiving antenna, which was mounted on the top of a variable – height antenna tower.
- 3: The height of antenna is varied from one meter to four meters above the ground to determine the maximum value of the field strength. Both horizontal and vertical polarizations of the antenna are set to make the measurement.
- 4: For each suspected emission, the EUT was arranged to its worst case and then the antenna was tuned to heights from 1 meter to 4 meters and the rotatable table was turned from 0 degrees to 360 degrees to find the maximum reading.
- 5: Use the following spectrum analyzer settings According to C63.10:

For Above 1GHz

Span = wide enough to capture the peak level of the in-band emission and all spurious
RBW = 1MHz, VBW \geq RBW for peak measurement and VBW = 10Hz for average measurement, Sweep = auto, Detector function = peak, Trace = max hold.

For Below 1GHz

Use the following spectrum analyzer settings:

Span = wide enough to capture the peak level of the in-band emission and all spurious
RBW = 100 KHz, VBW \geq RBW for peak measurement, Sweep = auto, Detector function = peak, Trace = max hold.

Note:

- 1: The resolution bandwidth and video bandwidth of test receiver/spectrum analyzer is 120 KHz for Quasi-peak detection (QP) at frequency below 1GHz.
- 2: The resolution bandwidth of test receiver/spectrum analyzer is 1MHz and the video bandwidth is 3MHz for peak detection (PK) at frequency above 1GHz.
- 3: The resolution bandwidth of test receiver/spectrum analyzer is 1MHz and the video bandwidth is 3MHz for RMS Average ((duty cycle < 98%) for Average detection (AV) at frequency above 1GHz, then the measurement results was added to a correction factor (20log (1/duty cycle)).
- 4: The resolution bandwidth of test receiver/spectrum analyzer is 1MHz and the video bandwidth is 10Hz (duty cycle > 98%) for Average detection (AV) at frequency above 1GHz.

Field strength of emissions and Restricted bands

Limits

According to §15.249 (a) & RSS-210 A2.9(a) , the field strength of emissions from intentional radiators operated within these frequency bands shall comply with the following:

Fundamental frequency	Field strength of fundamental (millivolts/meter)	Field strength of harmonics (microvolts/meter)
902–928 MHz	50	500
2400–2483.5 MHz	50	500
5725–5875 MHz	50	500
24.0–24.25 GHz	250	2500

According to §15.249 (c)& RSS-210 B.10, Field strength limits are specified at a distance of 3 meters.

According to §15.249 (d)& RSS-210 B.10, Emissions radiated outside of the specified frequency bands, except for harmonics, shall be attenuated by at least 50 dB below the level of the fundamental or to the general radiated emission limits in §15.209& RSS-Gen, whichever is the lesser attenuation.

According to §15.205 and RSS-GEN 8.10 Unwanted emissions falling into restricted bands in §15.205 (a) and RSS-GEN 8.10 Table 7 shall comply with the limits specified in §15.209 and RSS-Gen.

Frequency MHz	Field Strength uV/m	Field Strength dBµV/m	Detector
30-88	100	40	QP
88-216	150	43.5	QP
216-960	200	46	QP
960-1000	500	54	QP
Above 1000	500	54	AV
Above 1000	5000	74	PK

Field strength of emissions and Restricted bands

According to C63.10, if the peak (or quasi-peak) measured value complies with the average limit, it is unnecessary to perform an average measurement, so AV emission value did not show in below table if the peak value complies with average limit.

EUT: Microwave sensor for Ceiling light
M/N: LM561232
Operating Condition: Tx; 5750MHz

Below 1GHz

Frequency (MHz)	Emission Level (dB μ V/m)	E-Field Polarity	Limits	Margin	Value Type	Corr. (dB)	Emission Type
			(dB μ V/m)	(dB)			
928.341250	39.75	H	46.0	6.25	QP	31.2	Spurious
954.652500	41.22	V	46.0	4.78	QP	31.6	Spurious
Remark:							
Corrector Factor = Antenna Factor + Cable Loss							

Above 1GHz

Frequency (MHz)	Maximum Emission (dB μ V)	Factor (dB)	E-Field Polarity	Limits	Margin	Corr. (dB)	Value Type	Emission Type
				(dB μ V/m)	(dB)			
5750.000000	75.49	0.00	H	114.00	38.51	4.2	Peak	Fundamental
5750.000000	74.62	0.00	H	94.00	19.38	4.2	AV	Fundamental
5750.000000	83.84	0.00	V	114.00	30.16	4.2	Peak	Fundamental
5750.000000	82.91	0.00	V	94.00	11.09	4.2	AV	Fundamental
11487.312500*	50.73	0.00	H	74.00	23.27	10.5	Peak	Spurious
11487.312500*	50.66	0.00	H	54.00	3.34	10.5	AV	Spurious
11480.781250*	52.16	0.00	V	74.00	21.84	10.7	Peak	Spurious
11480.781250*	52.10	0.00	V	54.00	1.90	10.7	AV	Spurious
Remark:								
Corrector Factor = Antenna Factor + Cable Loss – Amplifier Gain Factor=20log(dutycycle), dutycycle=100%								

Remark

- 1: AV Emission Level= PK Emission Level+20log(dutycycle)
- 2: "*" means the emission(s) appear within the restrict bands shall follow the requirement of section 15.205.
- 3: Below 1GHz: Corrector factor=Antenna Factor + Cable loss
- 4: Above 1GHz: Corrector factor=Antenna Factor + Cable loss-Amplifier Gain

Field strength of emissions and Restricted bands

EUT: Microwave sensor for Ceiling light

M/N: LM561232

Operating Condition: Tx; 5803MHz

Above 1GHz

Frequency (MHz)	Maximum Emission (dB μ V)	Factor (dB)	E-Field Polarity	Limits (dB μ V/m)	Margin (dB)	Corr. (dB)	Value Type	Emission Type
5803.000000	78.61	0.00	H	114.00	35.39	3.5	Peak	Fundamental
5803.000000	77.89	0.00	H	94.00	16.11	3.5	AV	Fundamental
5803.000000	89.41	0.00	V	114.00	24.59	3.5	Peak	Fundamental
5803.000000	88.67	0.00	V	94.00	5.33	3.5	AV	Fundamental
/	/	/	H	74.00	/	/	Peak	Spurious
/	/	/	V	74.00	/	/	Peak	Spurious
Remark:								
Corrector Factor = Antenna Factor + Cable Loss – Amplifier Gain								
Factor=20log(dutycycle), dutycycle=100%								

Remark

- 1: AV Emission Level= PK Emission Level+20log(dutycycle)
- 2: Data of measurement within this frequency range shown “/” in the table above means the reading of emissions are attenuated more than 20db below the permissible limits or the field strength is too small to be measured.
- 3: “*” means the emission(s) appear within the restrict bands shall follow the requirement of section 15.205.
- 4: Below 1GHz: Corrector factor=Antenna Factor + Cable loss
- 5: Above 1GHz: Corrector factor=Antenna Factor + Cable loss-Amplifier Gain

Field strength of emissions and Restricted bands

EUT: Microwave sensor for Ceiling light

M/N: LM561232

Operating Condition: Tx; 5856MHz

Above 1GHz

Frequency (MHz)	Maximum Emission (dB μ V)	Factor (dB)	E-Field Polarity	Limits (dB μ V/m)	Margin (dB)	Corr. (dB)	Value Type	Emission Type
5856.000000	73.37	0.00	H	114.00	40.63	4.2	Peak	Fundamental
5856.000000	72.41	0.00	H	94.00	21.59	4.2	AV	Fundamental
5856.000000	84.63	0.00	V	114.00	29.37	4.3	Peak	Fundamental
5856.000000	83.70	0.00	V	94.00	10.3	4.3	AV	Fundamental
/	/	/	H	74.00	/	/	Peak	Spurious
/	/	/	V	74.00	/	/	Peak	Spurious
Remark:								
Corrector Factor = Antenna Factor + Cable Loss – Amplifier Gain Factor=20log(dutycycle), dutycycle=100%								

Remark

- 1: AV Emission Level= PK Emission Level+20log(dutycycle)
- 2: Data of measurement within this frequency range shown “/” in the table above means the reading of emissions are attenuated more than 20db below the permissible limits or the field strength is too small to be measured.
- 3: “*” means the emission(s) appear within the restrict bands shall follow the requirement of section 15.205.
- 4: Below 1GHz: Corrector factor=Antenna Factor + Cable loss
- 5: Above 1GHz: Corrector factor=Antenna Factor + Cable loss-Amplifier Gain

8.3 Out of Band Emissions

Test Method

- 1 Use the following spectrum analyzer settings:
Span = wide enough to capture the peak level of the in-band emission and all spurious
RBW = 100 kHz, VBW \geq RBW, Sweep = auto, Detector function = peak, Trace = max hold.
- 2 Allow the trace to stabilize, use the peak and delta measurement to record the result.
- 3 The level displayed must comply with the limit specified in this Section.

Limits

According to §15.249(d) & RSS-210 B.10 Emissions radiated outside of the specified frequency bands, except for harmonics, shall be attenuated by at least 50 dB below the level of the fundamental or to the general radiated emission limits in §15.209 and RSS-Gen, whichever is the lesser attenuation.

Out of Band Emissions

EUT: Microwave sensor for Ceiling light
 M/N: LM561232
 Operating Condition: Tx; 5750MHz
 Polarization: Horizontal

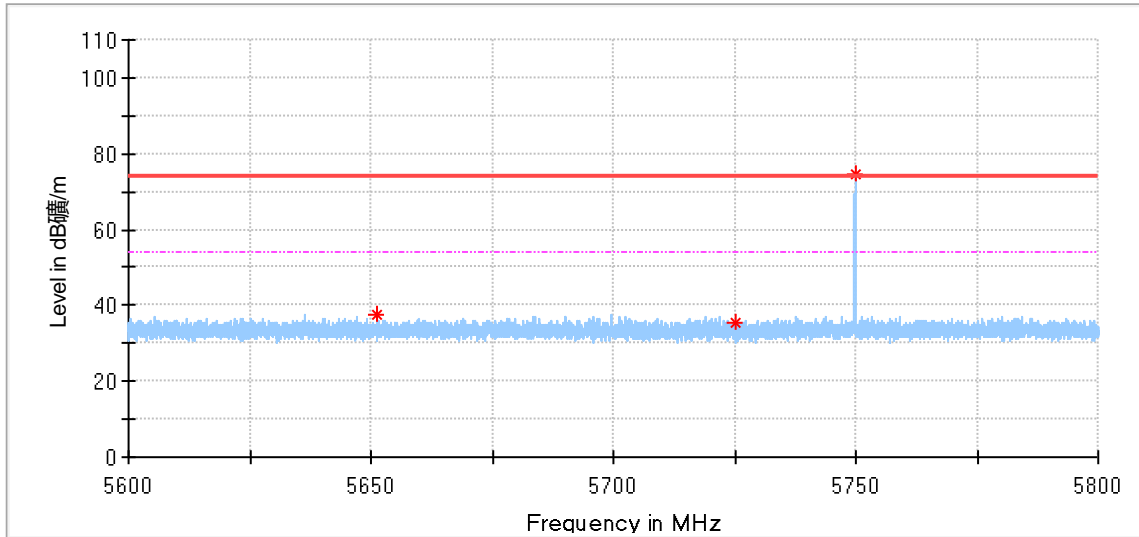

Frequency (MHz)	MaxPeak (dBµV/m)	Limit (dBµV/m)	Margin (dB)	Meas. Time (ms)	Bandwidth (kHz)	Height (cm)	Pol	Azimuth (deg)	Corr. (dB)
5651.243750	37.54	74.00	36.46	---	---	154.0	H	305.0	4.0
5725.037500	35.34	74.00	38.66	---	---	154.0	H	358.0	4.2
5749.875000	74.58	74.00	-0.58	---	---	154.0	H	160.0	4.2

Out of Band Emissions

EUT: Microwave sensor for Ceiling light

M/N: LM561232

Operating Condition: Tx; 5750MHz

Polarization: Vertical

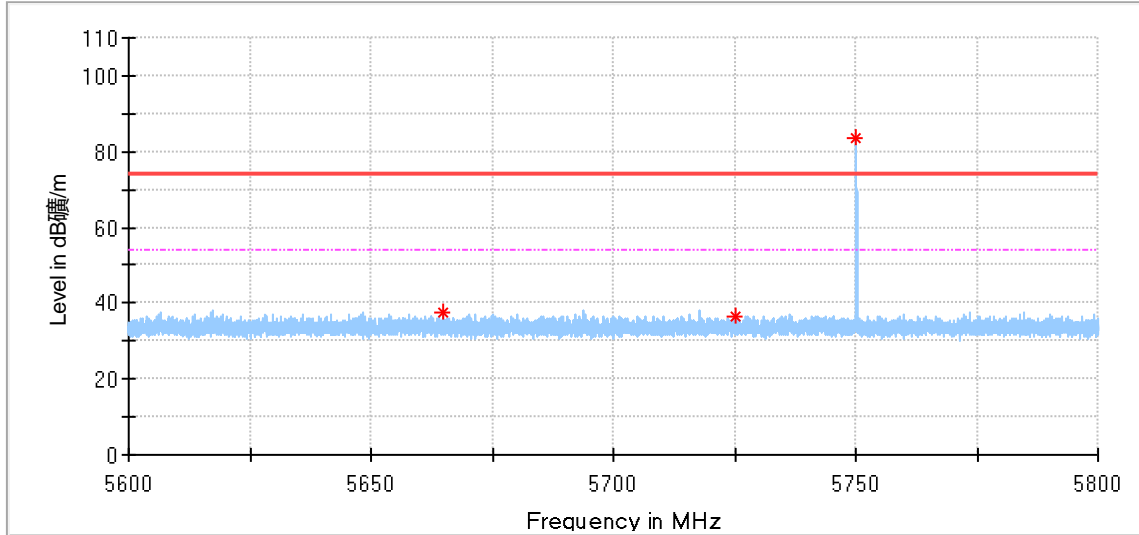

Frequency (MHz)	MaxPeak (dBµV/m)	Limit (dBµV/m)	Margin (dB)	Meas. Time (ms)	Bandwidth (kHz)	Height (cm)	Pol	Azimuth (deg)	Corr. (dB)
5664.975000	37.77	74.00	36.23	---	---	154.0	V	3.0	4.0
5725.306250	36.65	74.00	37.35	---	---	154.0	V	33.0	4.2
5750.100000	83.75	74.00	-9.75	---	---	154.0	V	238.0	4.2

Out of Band Emissions

EUT: Microwave sensor for Ceiling light

M/N: LM561232

Operating Condition: Tx; 5856MHz

Polarization: Horizontal

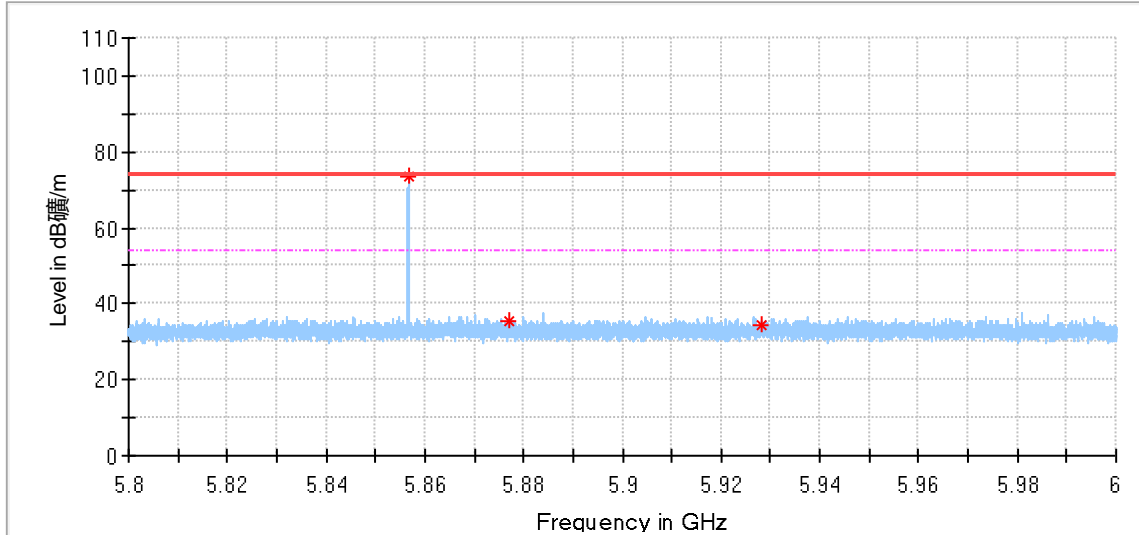

Frequency (MHz)	MaxPeak (dBµV/m)	Limit (dBµV/m)	Margin (dB)	Meas. Time (ms)	Bandwidth (kHz)	Height (cm)	Pol	Azimuth (deg)	Corr. (dB)
5856.637500	73.33	74.00	0.67	---	---	154.0	H	62.0	4.2
5877.231250	35.66	74.00	38.34	---	---	154.0	H	29.0	4.2
5928.275000	34.55	74.00	39.45	---	---	154.0	H	215.0	4.1

Out of Band Emissions

EUT: Microwave sensor for Ceiling light

M/N: LM561232

Operating Condition: Tx; 5856MHz

Polarization: Vertical

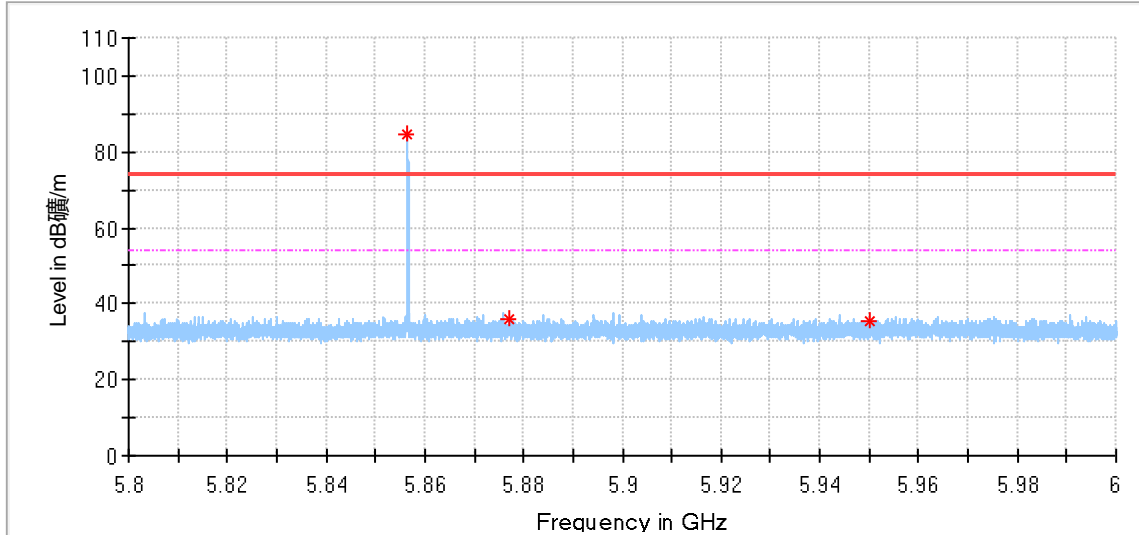

Frequency (MHz)	MaxPeak (dBµV/m)	Limit (dBµV/m)	Margin (dB)	Meas. Time (ms)	Bandwidth (kHz)	Height (cm)	Pol	Azimuth (deg)	Corr. (dB)
5856.493750	84.74	74.00	-10.74	---	---	154.0	V	34.0	4.3
5876.993750	35.72	74.00	38.28	---	---	154.0	V	338.0	4.3
5950.225000	35.32	74.00	38.68	---	---	154.0	V	0.0	4.2

8.4 20dB Bandwidth & 99% Occupied Bandwidth

Test Method

1. Check the calibration of the measuring instrument using either an internal calibrator or a known signal from an external generator.
2. Position the EUT without connection to measurement instrument. Turn on the EUT and connect it to measurement instrument. Then set it to any one convenient frequency within its operating range. Set a reference level on the measuring instrument equal to the highest peak value.
3. Measure the frequency difference of two frequencies that were attenuated 20 dB from the reference level. Record the frequency difference as the emission bandwidth.

Limits:

According to 15.215 (c) Intentional radiators operating under the alternative provisions to the general emission limits, as contained in §§ 15.217 through 15.257 and in Subpart E of this part, must be designed to ensure that the 20 dB bandwidth of the emission, or whatever bandwidth may otherwise be specified in the specific rule section under which the equipment operates, is contained within the frequency band designated in the rule section under which the equipment is operated. The requirement to contain the designated bandwidth of the emission within the specified frequency band includes the effects from frequency sweeping, frequency hopping and other modulation techniques that may be employed as well as the frequency stability of the transmitter over expected variations in temperature and supply voltage. If a frequency stability is not specified in the regulations, it is recommended that the fundamental emission be kept within at least the central 80% of the permitted band in order to minimize the possibility of out-of-band operation.

According to RSS-Gen 6.7 when an occupied bandwidth value is not specified in the applicable RSS, the transmitted signal bandwidth to be reported is to be its 99% emission bandwidth, as calculated or measured.

20dB Bandwidth & 99% Occupied Bandwidth

Frequency	20dB Bandwidth	99% Bandwidth	Limit
MHz	KHz	kHz	kHz
5750	277.90	243.12	--

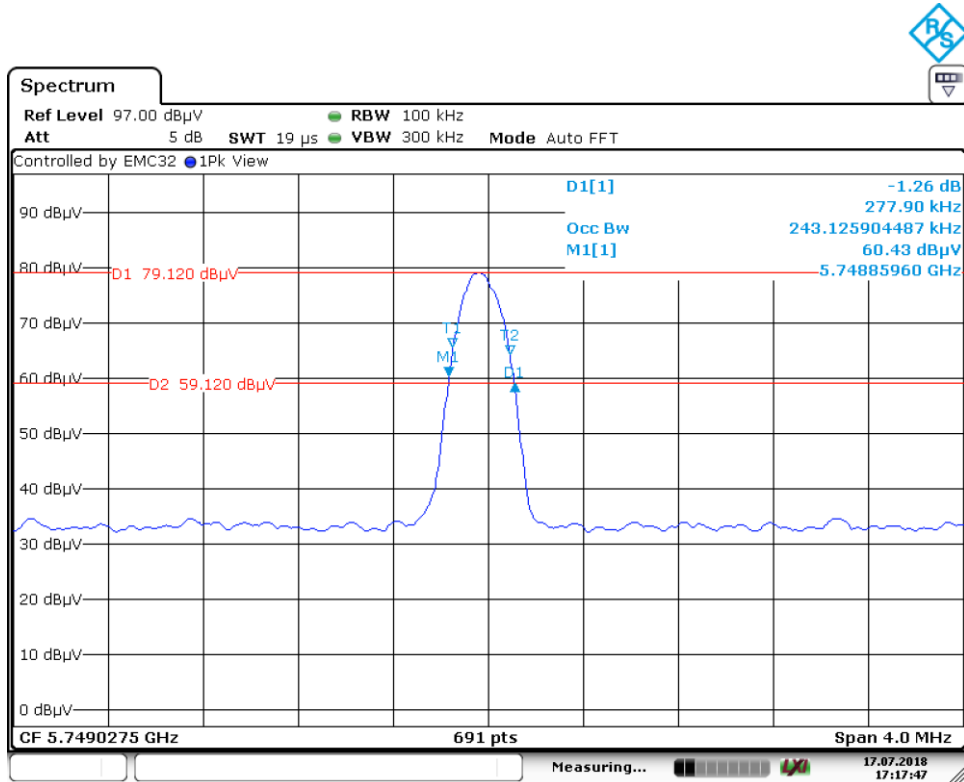

Date: 17.JUL.2018 17:17:46

5750MHz

20dB Bandwidth & 99% Occupied Bandwidth

Frequency MHz	20dB Bandwidth KHz	99% Bandwidth kHz	Limit kHz
5803	267.70	260.49	--

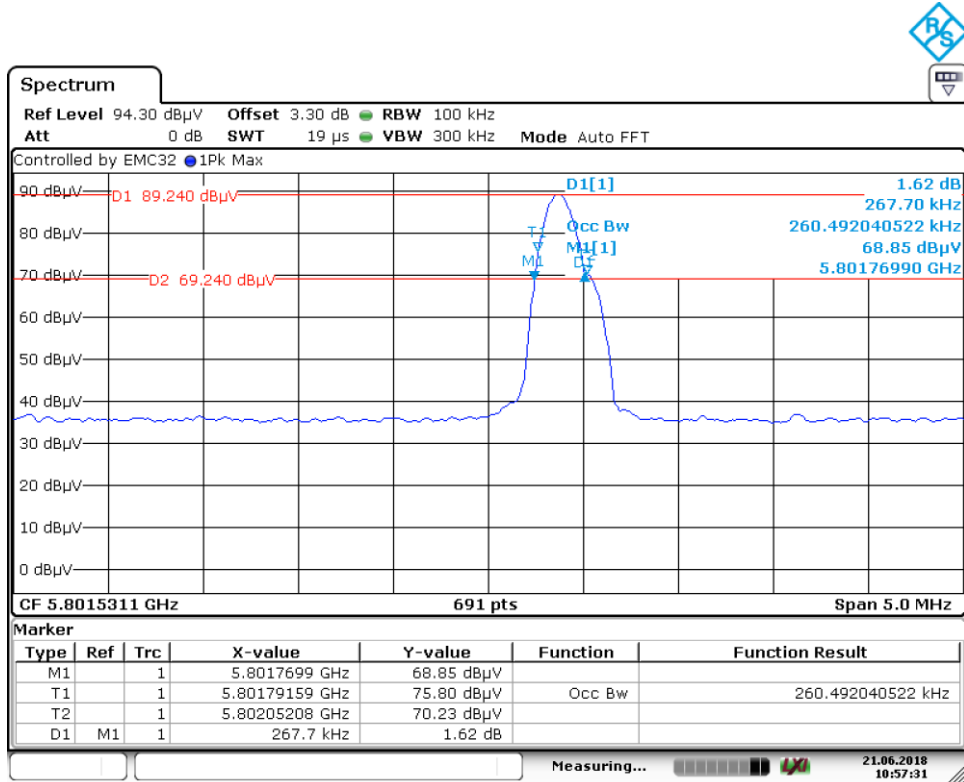

Date: 21.JUN.2018 10:57:31

5803MHz

20dB Bandwidth & 99% Occupied Bandwidth

Frequency	20dB Bandwidth	99% Bandwidth	Limit
MHz	KHz	kHz	kHz
5856	292.90	516.35	--

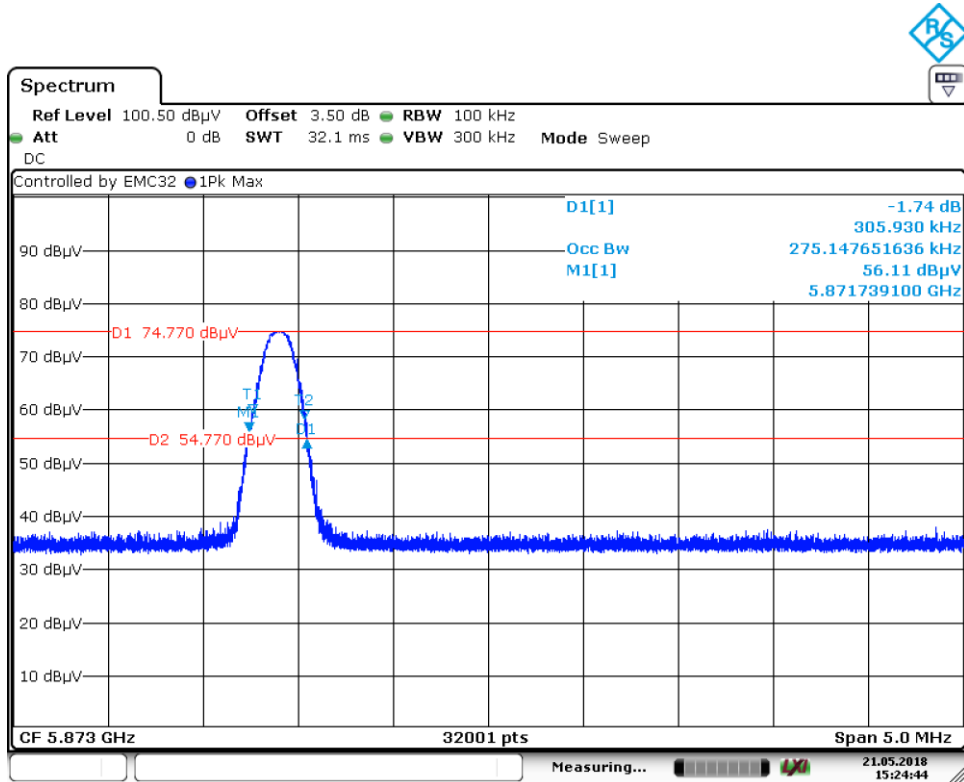

Date: 21.MAY.2018 15:24:44

5856MHz

9 Test equipment lists

List of Test Instruments

Radiated Spurious Emission Test

DESCRIPTION	MANUFACTURER	MODEL NO.	SERIAL NO.	CAL. DUE DATE
Signal Analyzer	Rohde & Schwarz	FSV40	101031	2019-7-6
Trilog Super Broadband Test Antenna	Schwarzbeck	VULB 9163	708	2019-7-13
Horn Antenna	Rohde & Schwarz	HF907	102295	2019-7-13
Wideband Horn Antenna	Q-PAR	QWH-SL-18-40-K-SG	12827	2019-7-12
Pre-amplifier	Rohde & Schwarz	SCU 18	102230	2019-7-6
Pre-amplifier	Rohde & Schwarz	SCU 40A	100432	2019-7-6
Fully Anechoic Chamber	TDK	8X4X4	--	2020-7-7

Radiated Emission Test

DESCRIPTION	MANUFACTURER	MODEL NO.	SERIAL NO.	CAL. DUE DATE
EMI Test Receiver	Rohde & Schwarz	ESR 26	101269	2019-7-6
Trilog Super Broadband Test Antenna	Schwarzbeck	VULB 9163	707	2019-6-28
Horn Antenna	Rohde & Schwarz	HF907	102294	2019-6-28
Pre-amplifier	Rohde & Schwarz	SCU 18	102230	2019-7-6
Signal Generator	Rohde & Schwarz	SMY01	839369/005	2019-7-6
Attenuator	Agilent	8491A	MY39264334	2019-7-6
3m Semi-anechoic chamber	TDK	9X6X6	----	2020-7-7

Conducted Emission Test

DESCRIPTION	MANUFACTURER	MODEL NO.	SERIAL NO.	CAL. DUE DATE
EMI Test Receiver	Rohde & Schwarz	ESR 3	101782	2019-7-6
LISN	Rohde & Schwarz	ENV4200	100249	2019-7-6
LISN	Rohde & Schwarz	ENV432	101318	2019-7-6
LISN	Rohde & Schwarz	ENV216	100326	2019-7-6
ISN	Rohde & Schwarz	ENY81	100177	2019-7-6
ISN	Rohde & Schwarz	ENY81-CA6	101664	2019-7-6
High Voltage Probe	Rohde & Schwarz	TK9420(VT9420)	9420-584	2019-6-30
RF Current Probe	Rohde & Schwarz	EZ-17	100816	2019-6-30
Attenuator	Shanghai Huaxiang	TS2-26-3	080928189	2019-7-6

10 System Measurement Uncertainty

For a 95% confidence level, the measurement expanded uncertainties for defined systems, in accordance with the recommendations of ISO 17025 were:

System Measurement Uncertainty	
Test Items	Extended Uncertainty
Uncertainty for Radiated Emission in 3m chamber 30MHz-1000MHz	Horizontal: 4.91dB; Vertical: 4.89dB;
Uncertainty for Radiated Spurious Emission 25MHz-3000MHz	Horizontal: 4.80dB; Vertical: 4.87dB;
Uncertainty for Radiated Spurious Emission 3000MHz-18000MHz	Horizontal: 4.59dB; Vertical: 4.58dB;
Uncertainty for Radiated Spurious Emission 18000MHz-40000MHz	Horizontal: 5.05dB; Vertical: 5.04dB;
Uncertainty for Conducted Emission 150kHz-30MHz (for test using AMN ENV432 or ENV4200)	3.21dB