

TEST REPORT

Test report no.: 1-3701/11-01-03



Testing laboratory

CETECOM ICT Services GmbH
 Untertuerkheimer Strasse 6 – 10
 66117 Saarbruecken / Germany
 Phone: + 49 681 5 98 - 0
 Fax: + 49 681 5 98 - 9075
 Internet: <http://www.cetecom.com>
 e-mail: ict@cetecom.com

Accredited Testing Laboratory:

The testing laboratory (area of testing) is accredited according to DIN EN ISO/IEC 17025 (2005) by the Deutsche Akkreditierungsstelle GmbH (DAkkS). The accreditation is valid for the scope of testing procedures as stated in the accreditation certificate with the registration number: D-PL-12076-01-01
 Area of Testing: Radio/Satellite Communications

Applicant

Cochlear Limited
 1 University Avenue
 Macquarie University NSW 2109 / AUSTRALIA
 Phone: +61 2 94 28 65 15
 Fax: -/-
 Contact: Bronwyn Evans
 e-mail: bevans@cochlear.com
 Phone: +61 2 94 28 65 15

Manufacturer

Cochlear Limited
 14 Mars Road, Lane Cove
 NSW 2066 Sydney / AUSTRALIA

Test standard/s

47 CFR Part 15	Title 47 of the Code of Federal Regulations; Chapter I Part 15 - Radio frequency devices
RSS - 210 Issue 8	Spectrum Management and Telecommunications - Radio Standards Specification Low-power Licence-exempt Radiocommunication Devices (All Frequency Bands): Category I Equipment

For further applied test standards please refer to section 3 of this test report.

Test Item

Kind of test item:	2,4 GHz Hearing device with two Remote Controls
Model name:	CP910, CP920, DP910, DP920
FCC ID:	WTOP900
IC:	8039A-P900
Frequency:	ISM band 2400 MHz to 2483.5 MHz lowest channel 2402 MHz – highest channel 2482 MHz
Technology tested:	GFSK
Antenna:	Integrated antenna
Power Supply:	3.60 V DC by Li-Ion battery
Temperature Range:	+5°C to +50 °C



This test report is electronically signed and valid without handwriting signature. For verification of the electronic signatures, the public keys can be requested at the testing laboratory.

Test report authorised:

Marco Bertolino
 Testing Manager

Test performed:

Andreas Luckenbill

1 Table of contents	
1	Table of contents2
2	General information3
2.1	Notes and disclaimer3
2.2	Application details.....3
3	Test standard/s3
4	Test environment.....4
5	Test item4
6	Test laboratories sub-contracted4
7	Summary of measurement results5
8	RF measurements6
8.1	Description of test setup6
8.1.1	Radiated measurements.....6
8.2	Additional comments7
8.3	RSP100 test report cover sheet / performance test data8
9	Measurement results.....9
9.1	Timing of the transmitter9
9.2	Spectrum bandwidth – 99% bandwidth.....10
9.3	Maximum field strength13
9.4	Band edge compliance radiated14
9.5	TX spurious emissions radiated17
9.6	RX spurious emissions radiated.....28
9.7	Spurious emissions radiated < 30 MHz.....32
9.8	Spurious emissions conducted < 30 MHz.....35
10	Test equipment and ancillaries used for tests36
11	Observations37
Annex A	Photographs of the test setup38
Annex B	External photographs of the EUT42
Annex C	Internal photographs of the EUT46
Annex D	Document history48
Annex E	Further information.....48
Annex F	Accreditation Certificate49

2 General information

2.1 Notes and disclaimer

The test results of this test report relate exclusively to the test item specified in this test report. CETECOM ICT Services GmbH does not assume responsibility for any conclusions and generalizations drawn from the test results with regard to other specimens or samples of the type of the equipment represented by the test item.

The test report may only be reproduced or published in full. Reproduction or publication of extracts from the report requires the prior written approval of CETECOM ICT Services GmbH.

The testing service provided by CETECOM ICT Services GmbH has been rendered under the current "General Terms and Conditions for CETECOM ICT Services GmbH".

CETECOM ICT Services GmbH will not be liable for any loss or damage resulting from false, inaccurate, inappropriate or incomplete product information provided by the customer.

Under no circumstances does the CETECOM ICT Services GmbH test report include any endorsement or warranty regarding the functionality, quality or performance of any other product or service provided.

Under no circumstances does the CETECOM ICT Services GmbH test report include or imply any product or service warranties from CETECOM ICT Services GmbH, including, without limitation, any implied warranties of merchantability, fitness for purpose, or non-infringement, all of which are expressly disclaimed by CETECOM ICT Services GmbH.

All rights and remedies regarding vendor's products and services for which CETECOM ICT Services GmbH has prepared this test report shall be provided by the party offering such products or services and not by CETECOM ICT Services GmbH.

In no case this test report can be considered as a Letter of Approval.

This test report is electronically signed and valid without handwritten signature. For verification of the electronic signatures, the public keys can be requested at the testing laboratory.

2.2 Application details

Date of receipt of order:	2012-02-07
Date of receipt of test item:	2012-02-07
Start of test:	2012-02-07
End of test:	2012-03-16
Person(s) present during the test:	-/-

3 Test standard/s

Test standard	Date	Test standard description
47 CFR Part 15	2010-10	Title 47 of the Code of Federal Regulations; Chapter I Part 15 - Radio frequency devices
RSS - 210 Issue 8	2010-12	Spectrum Management and Telecommunications - Radio Standards Specification Low-power Licence-exempt Radiocommunication Devices (All Frequency Bands): Category I Equipment

4 Test environment

Temperature:	T_{nom}	+22 °C during room temperature tests
	T_{max}	+50 °C during high temperature tests
	T_{min}	+5 °C during low temperature tests
Relative humidity content:		41 %
Barometric pressure:		not relevant for this kind of testing
Power supply:	V_{nom}	3.60 V DC by Li-Ion battery
	V_{max}	4.25 V
	V_{min}	2.00 V

5 Test item

Kind of test item	:	2,4 GHz Hearing device with two Remote Controls
Type identification	:	CP910, CP920, DP910, DP920
S/N serial number	:	Rad. #101011 0028318 U, #101011 0023474 U Cond. #101011 0023313 U
HW hardware status	:	Build U
SW software status	:	Radio compliance Firmware for N6
Frequency band [MHz]	:	ISM band 2400 MHz to 2483.5 MHz lowest channel 2402 MHz – highest channel 2482 MHz
Type of modulation	:	GFSK
Number of channels	:	41
Antenna	:	Integrated antenna
Power supply	:	3.60 V DC by Li-Ion battery
Temperature range	:	+5°C to +50 °C

6 Test laboratories sub-contracted

None

7 Summary of measurement results

- No deviations from the technical specifications were ascertained
- There were deviations from the technical specifications ascertained

TC Identifier	Description	Verdict	Date	Remark
RF-Testing	CFR Part 15 RSS 210, Issue 8	Passed	2012-04-02	-/-

Test specification clause	Test case	Temperature conditions	Power source voltages	Mode	Pass	Fail	NA	NP	Results (max.)
CFR 15.35(c) RSS Gen (Issue 3) / 4.5	Timing of the transmitter	Nominal	Nominal	TX	<input checked="" type="checkbox"/>	<input type="checkbox"/>	<input type="checkbox"/>	<input type="checkbox"/>	Not limited
RSS Gen (Issue 3) / 4.6.1	99% - Occupied Bandwidth	Nominal	Nominal	TX	<input checked="" type="checkbox"/>	<input type="checkbox"/>	<input type="checkbox"/>	<input type="checkbox"/>	Not limited
§15.249(a)(e) RSS-210 / A2.9(a)	Maximum field strength	Nominal	Nominal	TX	<input checked="" type="checkbox"/>	<input type="checkbox"/>	<input type="checkbox"/>	<input type="checkbox"/>	complies
§15.249(d) RSS-210 / A2.9(a)(b)	Band edge compliance radiated	Nominal	Nominal	TX	<input checked="" type="checkbox"/>	<input type="checkbox"/>	<input type="checkbox"/>	<input type="checkbox"/>	complies
§15.249(d) RSS-210 / A2.9(a)(b)	TX spurious emissions radiated	Nominal	Nominal	TX	<input checked="" type="checkbox"/>	<input type="checkbox"/>	<input type="checkbox"/>	<input type="checkbox"/>	complies
§15.109 RSS-Gen	RX spurious emissions radiated	Nominal	Nominal	Idle	<input checked="" type="checkbox"/>	<input type="checkbox"/>	<input type="checkbox"/>	<input type="checkbox"/>	complies
§15.209(a) RSS-Gen	Spurious emissions radiated < 30 MHz	Nominal	Nominal	TX/Idle	<input checked="" type="checkbox"/>	<input type="checkbox"/>	<input type="checkbox"/>	<input type="checkbox"/>	complies
§15.107(a) RSS-Gen	Spurious emissions conducted < 30 MHz	Nominal	Nominal	TX/Idle	<input type="checkbox"/>	<input type="checkbox"/>	<input checked="" type="checkbox"/>	<input type="checkbox"/>	complies

Note: NA = Not Applicable; NP = Not Performed

8 RF measurements

8.1 Description of test setup

8.1.1 Radiated measurements

The radiated measurements are performed in vertical and horizontal plane in the frequency range from 9 kHz to 25 GHz in semi-anechoic chambers. The EUT is positioned on a non-conductive support with a height of 0.80 m above a conductive ground plane that covers the whole chamber. The receiving antennas are confirmed with specifications ANSI C63.2-1996 clause 15 and ANSI C63.10-2009 clause 4.1.5. These antennas can be moved over the height range between 1.0 m and 4.0 m in order to search for maximum field strength emitted from EUT. The measurement distances between EUT and receiving antennas are indicated in the test setups for the various frequency ranges. For each measurement, the EUT is rotated in all three axes until the maximum field strength is received. The wanted and unwanted emissions are received by spectrum analysers where the detector modes and resolution bandwidths over various frequency ranges are set according to requirement ANSI C63.10-2009 clause 4.2.

Antennas are confirmed with ANSI C63.2-1996 item 15.

Semi anechoic chamber

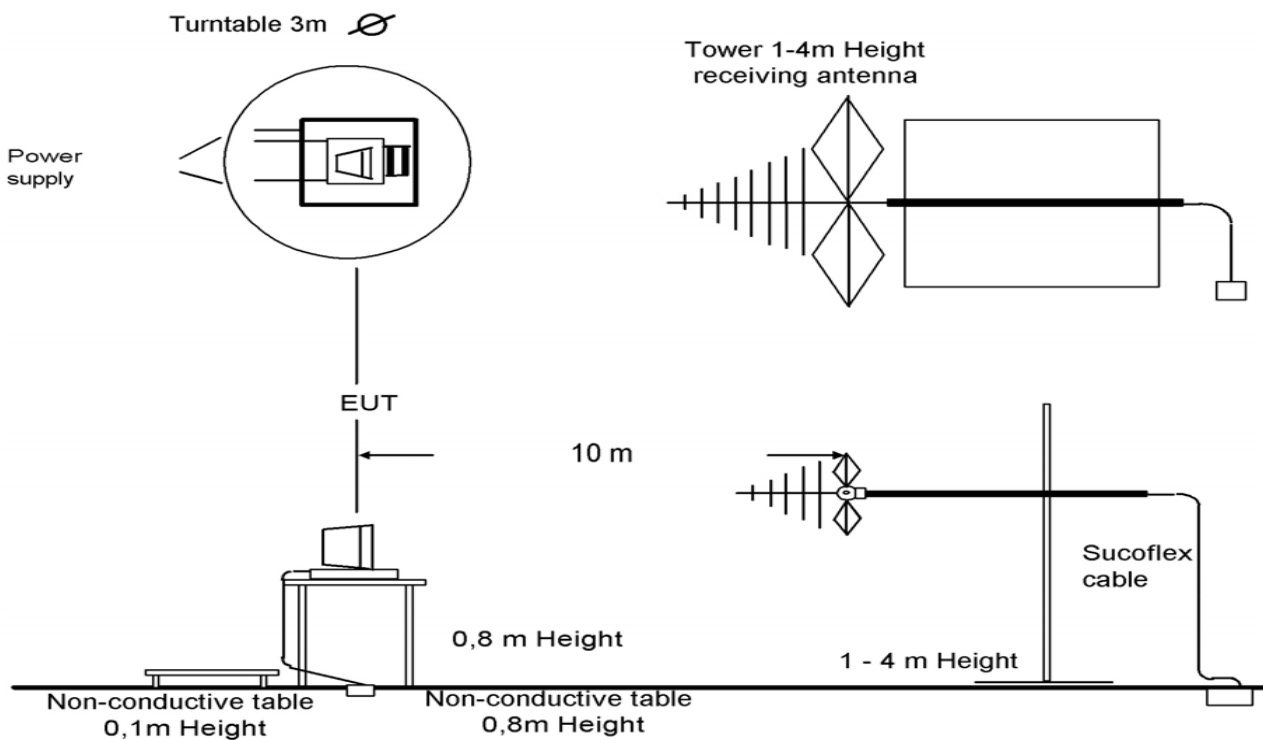

Picture 1: Diagram radiated measurements

9 kHz - 30 MHz:	active loop antenna
30 MHz – 1 GHz:	tri-log antenna
> 1 GHz:	horn antenna

The EUT is powered by an external power supply with nominal voltage or with battery.

8.2 Additional comments

Reference documents: None

Special test descriptions: None

Configuration descriptions: None

Test mode:

- No test mode available.
Iperf was used to ping another device with the largest support packet size
- Special software is used.
EUT is transmitting pseudo random data by itself

8.3 RSP100 test report cover sheet / performance test data

Test report number	:	1-3701/11-01-03
Equipment model number	:	CP910, CP920, DP910, DP920
Certification number	:	8039A-P900
Manufacturer (complete address)	:	Cochlear Limited 14 Mars Road, Lane Cove NSW 2066 Sydney / AUSTRALIA
Tested to radio standards specification no.	:	RSS 210, Issue 8
Open area test site IC No.	:	IC 3462C-1
Frequency range	:	ISM band 2400 MHz to 2483.5 MHz (lowest channel 2402 MHz, highest channel 2482 MHz)
RF-field strength [dB μ V/m @ 3 m] (max.)	:	71.04 dB μ V/m
Occupied bandwidth (99%-BW) [kHz]	:	1560 kHz
Type of modulation	:	Digital Transmission System using GFSK modulation
Emission designator (TRC-43)	:	1M56FXD
Antenna information	:	Integrated antenna
Transmitter spurious (worst case) [dB μ V/m @ 3m]:		44 dB μ V/m (noise floor)
Receiver spurious (worst case) [dB μ V/m @ 3m]	:	44 dB μ V/m (noise floor)

ATTESTATION:

DECLARATION OF COMPLIANCE:

I attest that the testing was performed or supervised by me; that the test measurements were made in accordance with the above-mentioned Industry Canada standard(s); and that the equipment identified in this application has been subjected to all the applicable test conditions specified in the Industry Canada standards and all of the requirements of the standard have been met.

Laboratory manager:

2012-04-02

Andreas Luckenbill



Date

Name

Signature

9 Measurement results

9.1 Timing of the transmitter

Limits:

FCC	IC
Timing of the transmitter	
<p>(c) Unless otherwise specified, e.g. Section 15.255(b), when the radiated emission limits are expressed in terms of the average value of the emission, and pulsed operation is employed, the measurement field strength shall be determined by averaging over one complete pulse train, including blanking intervals, as long as the pulse train does not exceed 0.1 seconds. As an alternative (provided the transmitter operates for longer than 0.1 seconds) or in cases where the pulse train exceeds 0.1 seconds, the measured field strength shall be determined from the average absolute voltage during a 0.1 second interval during which the field strength is at its maximum value. The exact method of calculating the average field strength shall be submitted with any application for certification or shall be retained in the measurement data file for equipment subject to notification or verification.</p>	

Information by the vendor:

The protocol foresees in 901us pulse rate and the duration per emission is approx.
 $50\mu s + [(1+4+8+2) * 8\text{bits} / 2\text{Mbps}] = 110\mu s$.
 Thus $20 * \log((111 * 0.110[\text{ms}]) / 100\text{ms}) = 20 * \log(12.21\%) = -18.26 \text{ dB}$

Calculation:

Transmit time (Tx on) within 100 ms = $111 * 0.110 \text{ ms} = 12.21 \text{ ms}$
 Assumed Transmit time (Tx on) within 100 ms for further calculations: 12.21 ms

The peak-to-average correction factor [dB] is calculated with $20 \text{ Log} [\text{Tx on} / 100\text{ms}]$.

Result:

peak-to-average correction factor [dB]: -18.27

9.2 Spectrum bandwidth – 99% bandwidth

Description:

Measurement of the 99% bandwidth of the modulated signal.

Measurement:

Measurement parameter	
Detector:	Peak
Sweep time:	Auto
Resolution bandwidth:	10 kHz
Video bandwidth:	10 kHz
Span:	3 MHz
Trace-Mode:	Max Hold

Limits:

FCC	IC
Spectrum Bandwidth – 99% Bandwidth	
Required for emission designator	

Results:

Modulation Frequency	99% BANDWIDTH [kHz]		
	2402 MHz	2442 MHz	2482 MHz
ISM 2.4 GHz	1384.5	1518	1560
Measurement uncertainty	± 30 kHz		

Plots:

Plot 1: lowest channel

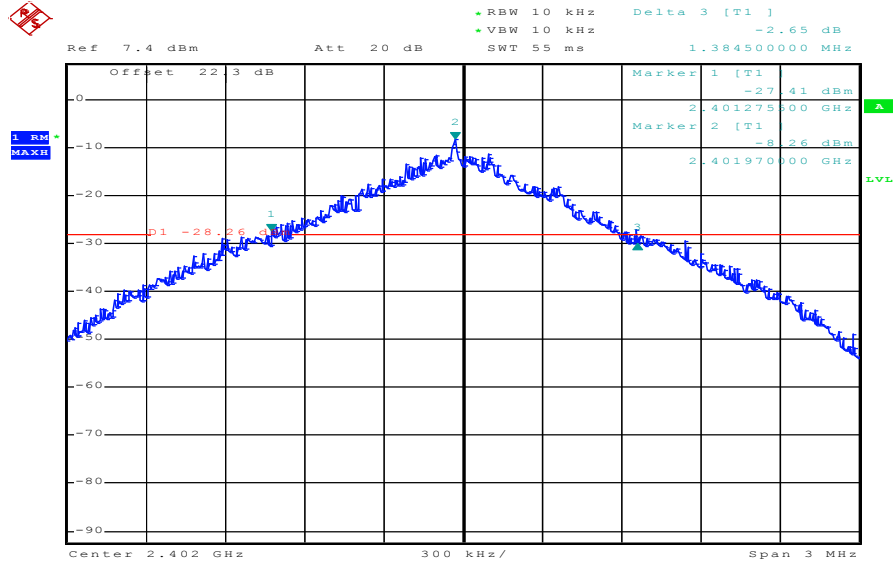

Date: 13.MAR.2012 16:14:28

Plot 2: middle channel

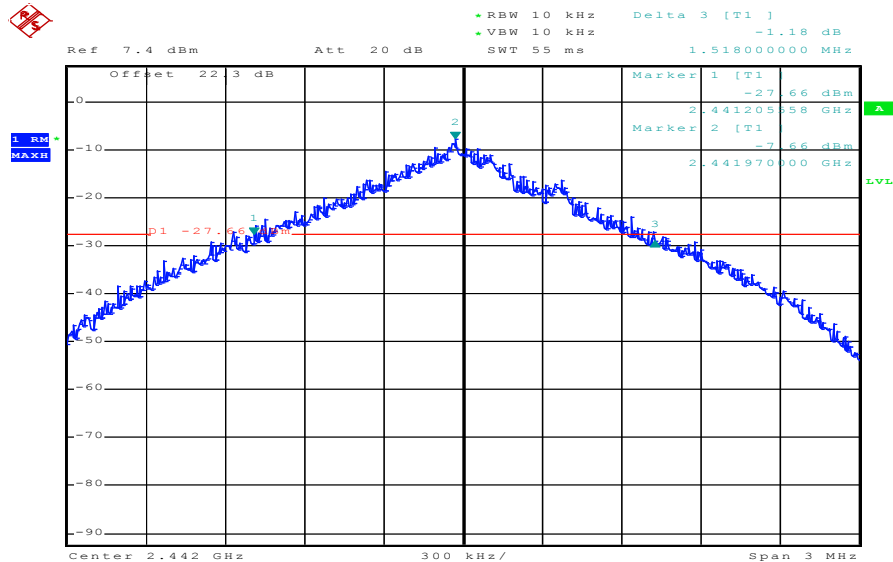

Date: 13.MAR.2012 16:16:34

Plot 3: highest channel

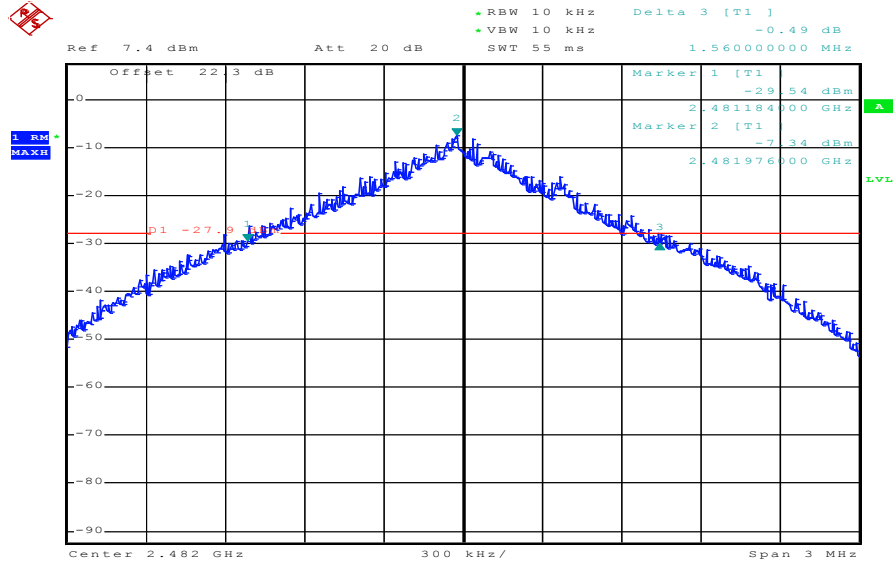

Date: 13.MAR.2012 16:18:32

9.3 Maximum field strength

Description:

Measurement of the maximum field strength radiated.

Measurement:

Measurement parameter	
Detector:	Peak
Sweep time:	Auto
Resolution bandwidth:	1 MHz
Video bandwidth:	1 MHz
Span:	3 MHz
Trace-Mode:	Max Hold
Measurement distance:	3 m

Limits:

FCC	IC
Maximum field strength	
The field strength of emissions of intentional radiators shall comply with the following: Field strength of fundamental: 50 mV/m / (94 dB μ V/m) @ 3 m (AVG) 500 mV/m / (114 dB μ V/m) @ 3 m (Peak)	

Result:

Modulation Frequency	Maximum field strength [dB μ V/m]		
	2402 MHz	2442 MHz	2482 MHz
Peak	89.31	88.76	88.87
AVG*)	71.04	70.49	70.60
Measurement uncertainty	± 3 dB		

*) Average value calculated with duty cycle correction factor. (see chapter 9.1)

Result: The result of the measurement is passed.

9.4 Band edge compliance radiated

Description:

Measurement of the radiated band edge compliance. The EUT is turned in the position that results in the maximum level at the band edge. Then a sweep over the corresponding restricted band is performed. The EUT is set to lowest channel for the lower restricted band and to highest channel for the upper restricted band. Measurement distance is 3m.

Measurement:

Measurement parameter	
Detector:	Peak
Sweep time:	Auto
Resolution bandwidth:	1 MHz
Video bandwidth:	10 Hz
Span:	Lower Band: 2300 – 2400 MHz Higher Band: 2480 – 2500 MHz
Trace-Mode:	Max Hold

Limits:

FCC	IC
Band Edge Compliance Radiated	
Emissions radiated outside of the specified frequency bands, except for harmonics, shall be attenuated by at least 50 dB below the level of the fundamental or to the general radiated emission limits in §15.209 / RSS GEN, whichever is the lesser attenuation.	
54 dB μ V/m (AVG) / 74 dB μ V/m (PP)	

Result:

Modulation	Band Edge Compliance Radiated [dB μ V/m]
	GFSK
Lower Band Edge – Lowest Channel	< 54 dB μ V/m (see plots 1/3)
Upper Band Edge – Highest Channel	< 54 dB μ V/m (see plot 2/4)
Measurement uncertainty	\pm 3 dB

Plots:

Plot 1: lower band edge, horizontal polarization

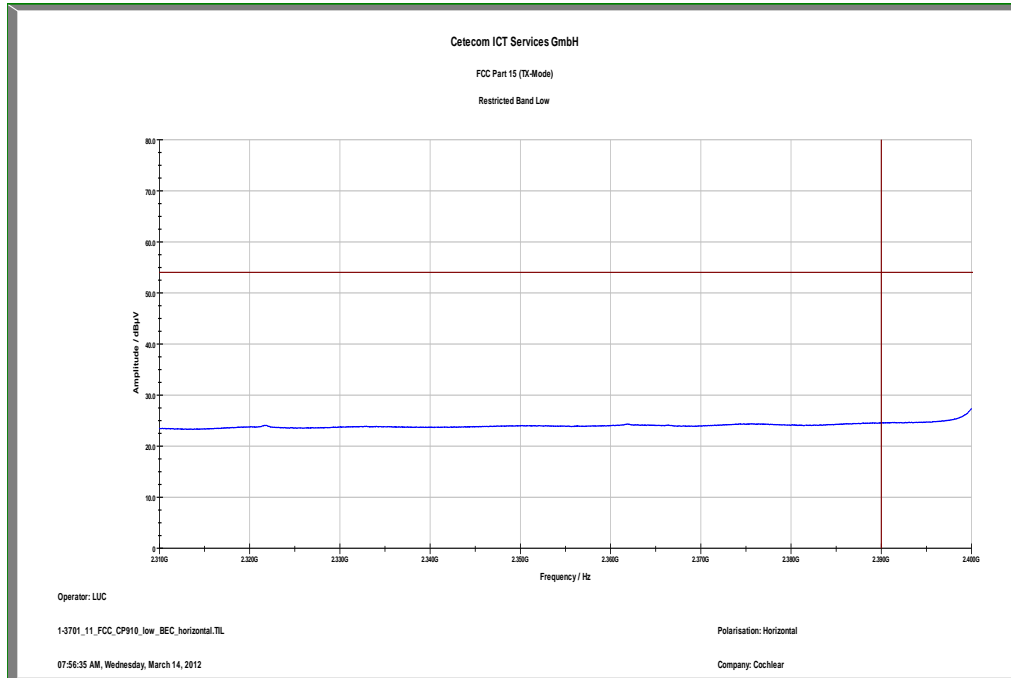

Plot 2: upper band edge, horizontal polarization

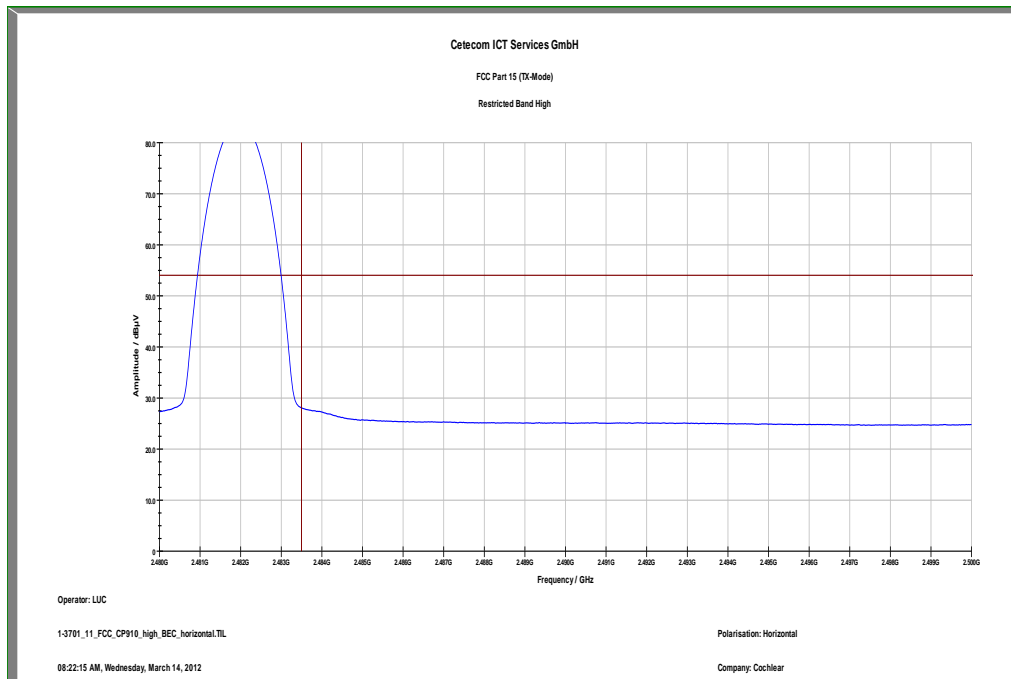

Plot 3: lower band edge, vertical polarization

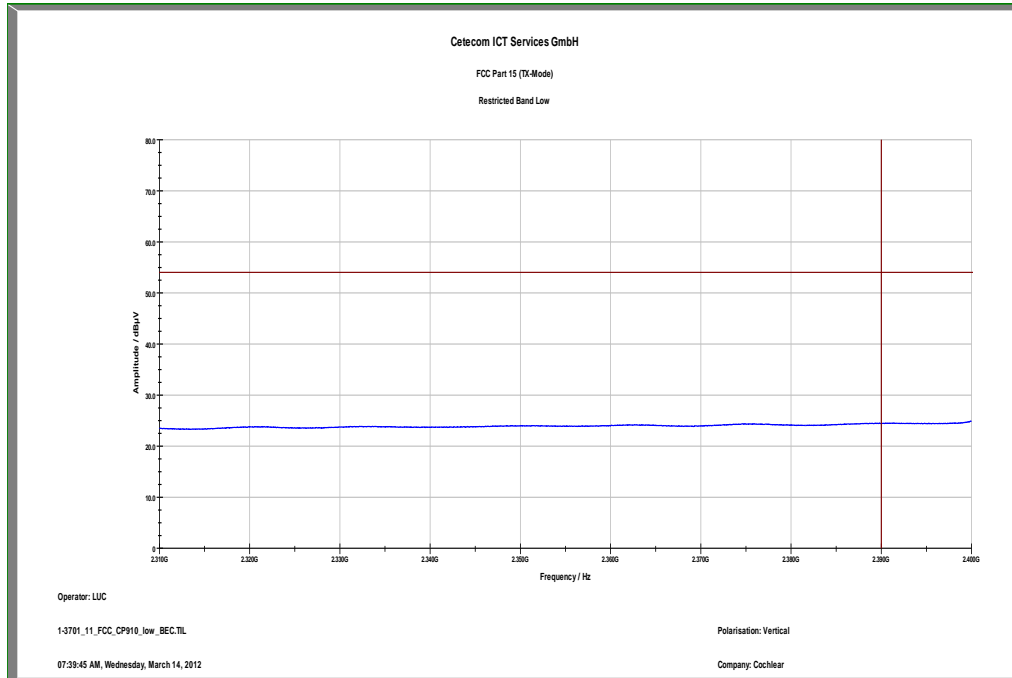

Plot 4: upper band edge, vertical polarization

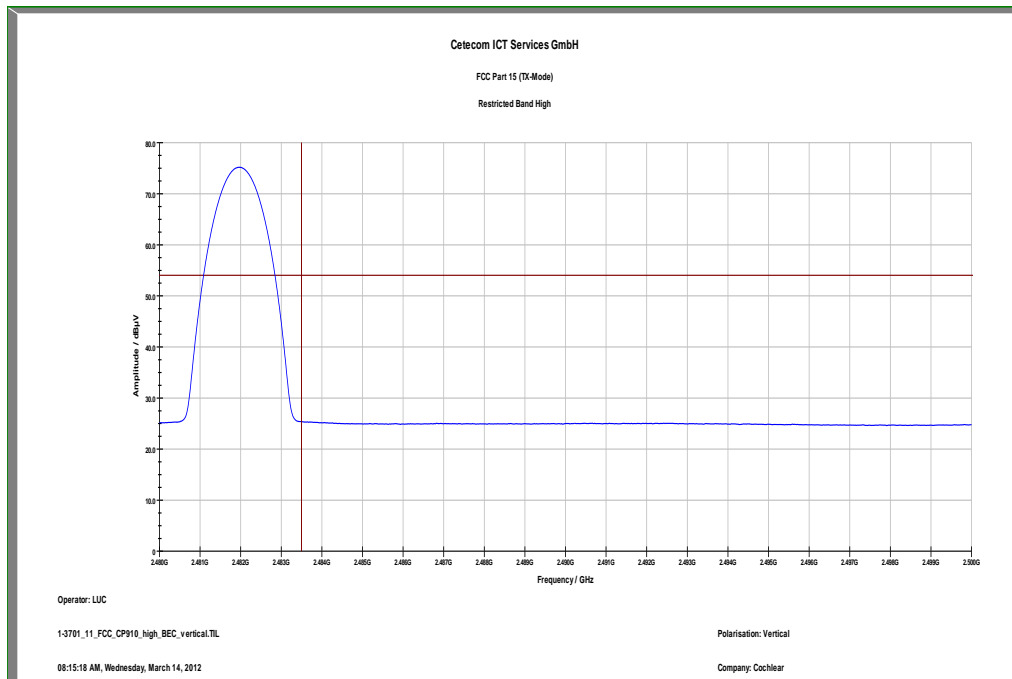

Result: The result of the measurement is passed.

9.5 TX spurious emissions radiated

Description:

Measurement of the radiated spurious emissions in transmit mode. The measurement is performed at lowest, middle and highest channel.

Measurement:

Measurement parameter	
Detector:	Peak / Quasi Peak
Sweep time:	Auto
Resolution bandwidth:	F < 1 GHz: 100 kHz F > 1 GHz: 1 MHz
Video bandwidth:	Sweep: 100 kHz Remeasurement: 10 Hz or Duty cycle correction
Span:	30 MHz to 25 GHz
Trace-Mode:	Max Hold

Limits:

FCC		IC
TX spurious emissions radiated		
Emissions radiated outside of the specified frequency bands, except for harmonics, shall be attenuated by at least 50 dB below the level of the fundamental or to the general radiated emission limits in §15.209 / RSS GEN, whichever is the lesser attenuation.		
§15.209		
Frequency (MHz)	Field Strength (dB μ V/m)	Measurement distance
30 - 88	30.0	10
88 – 216	33.5	10
216 – 960	36.0	10
Above 960	54.0	3

Results:

TX Spurious Emissions Radiated [dB μ V/m]								
2402 MHz			2442 MHz			2482 MHz		
F [MHz]	Detector	Level [dB μ V/m]	F [MHz]	Detector	Level [dB μ V/m]	F [MHz]	Detector	Level [dB μ V/m]
No critical peaks detected			No critical peaks detected			No critical peaks detected		
Measurement uncertainty			± 3 dB					

Result: The result of the measurement is passed.

Plots:

Plot 1: Lowest channel, 30 MHz to 1 GHz, vertical & horizontal polarization

Common Information

EUT: CP910
 Serial Number: #101011;0028318 U
 Test Description: FCC part 15C class B
 Operating Conditions: cont. TX @ 2402 MHz
 Operator Name: Wolsdorfer
 Comment: battery powered

Scan Setup: STAN_Fin [EMI radiated]

Hardware Setup: Electric Field (NOS)
 Receiver: [ESCI 3]
 Level Unit: dBµV/m

Subrange **Step Size** **Detectors** **IF BW** **Meas. Time** **Preamp**
 30 MHz - 2 GHz 60 kHz QPK 120 kHz 1 s 20 dB

FCC_10m(B)_3

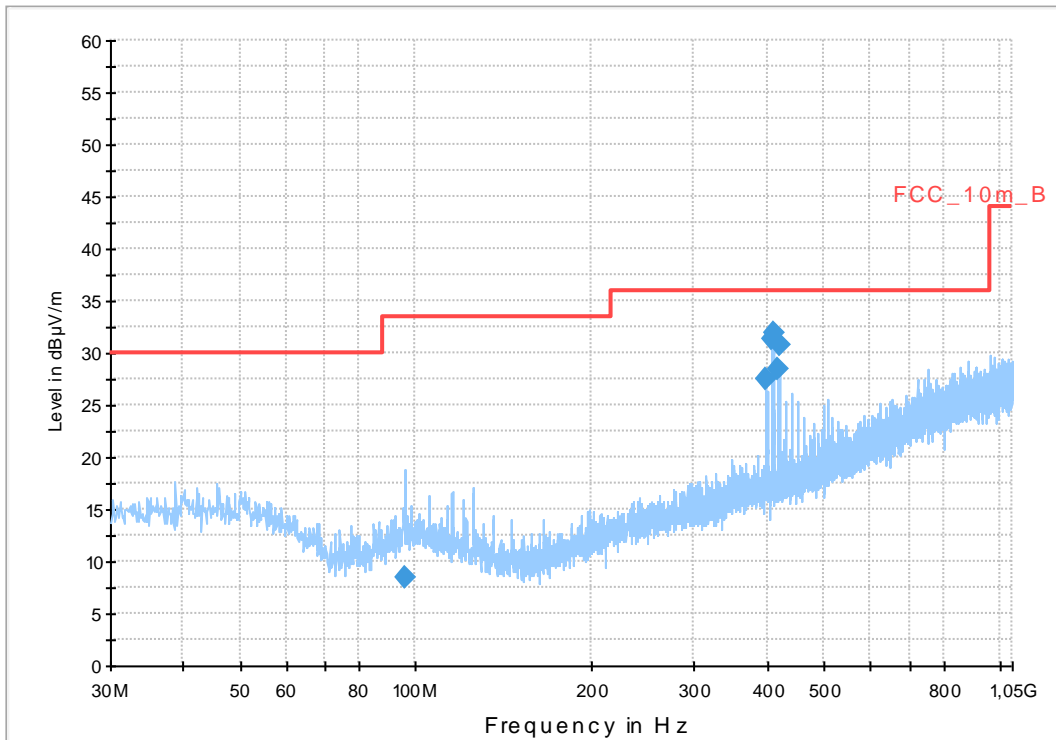

Final Result 1

Frequency (MHz)	QuasiPeak (dBµV/m)	Meas. Time (ms)	Bandwidth (kHz)	Height (cm)	Polarization	Azimuth (deg)	Corr. (dB)	Margin (dB)	Limit (dBµV/m)	Comment
95.596350	8.4	1000.0	120.000	170.0	V	92.0	11.3	25.1	33.5	
396.106500	27.4	1000.0	120.000	98.0	V	283.0	16.8	8.6	36.0	
406.108500	31.3	1000.0	120.000	98.0	V	-7.0	17.0	4.7	36.0	
411.145800	32.0	1000.0	120.000	98.0	V	8.0	17.1	4.0	36.0	
416.143200	28.6	1000.0	120.000	98.0	V	8.0	17.2	7.4	36.0	
421.176000	30.9	1000.0	120.000	98.0	V	260.0	17.2	5.1	36.0	

Plot 2: Lowest channel, 1 GHz to 12.75 GHz, vertical polarization

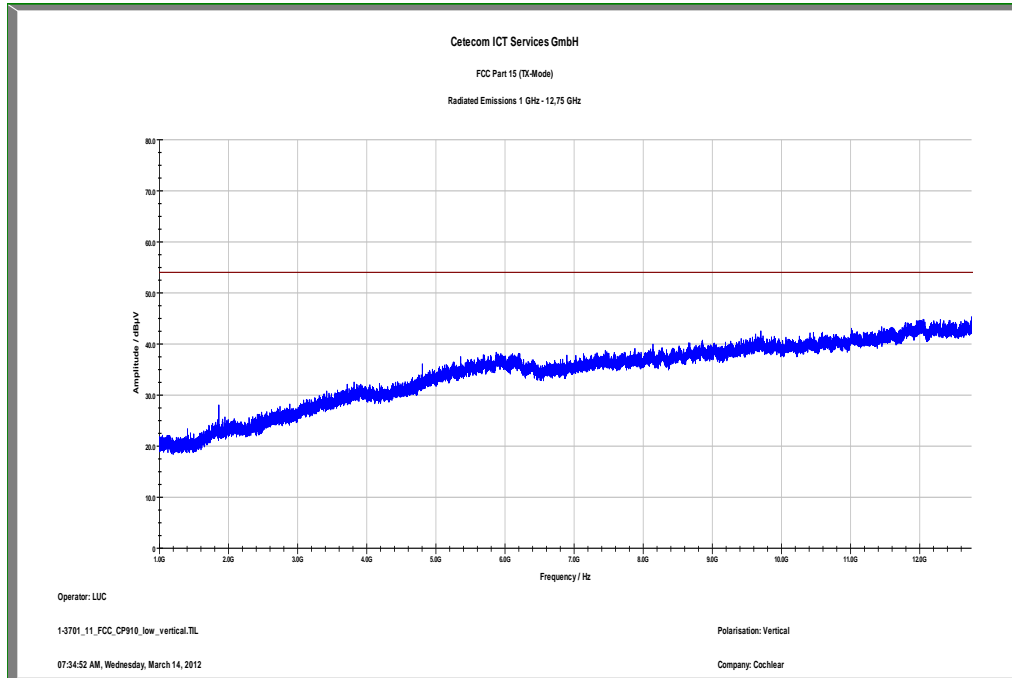

The carrier signal is notched with a 2.4 GHz band rejection filter.

Plot 3: Lowest channel, 1 GHz to 12.75 GHz, horizontal polarization

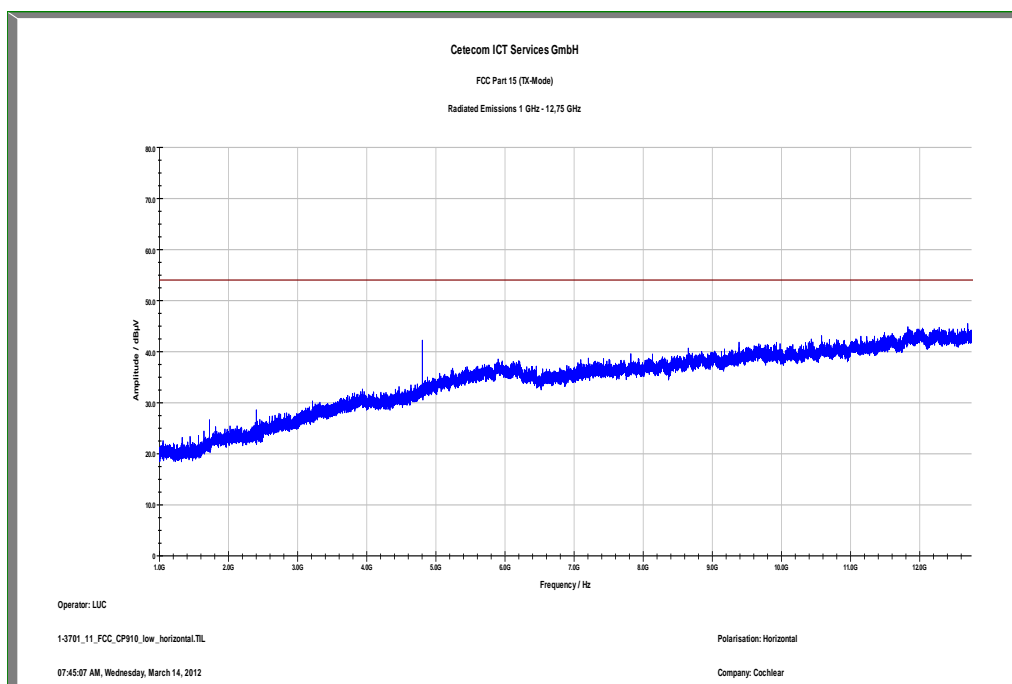

The carrier signal is notched with a 2.4 GHz band rejection filter.

Plot 4: Lowest channel, 12 GHz to 18 GHz, vertical & horizontal polarization

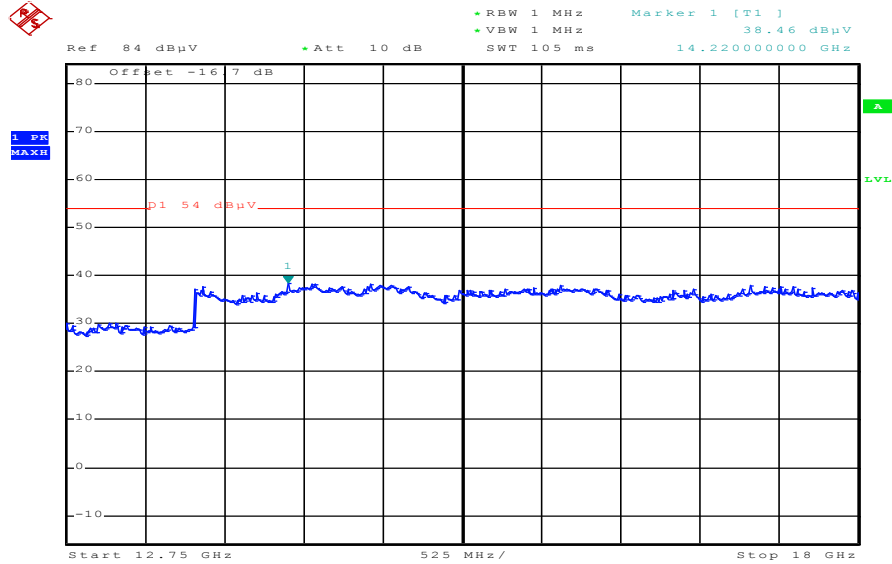

Date: 15.MAR.2012 15:31:05

Plot 5: Lowest channel, 18 GHz to 26 GHz, vertical & horizontal polarization

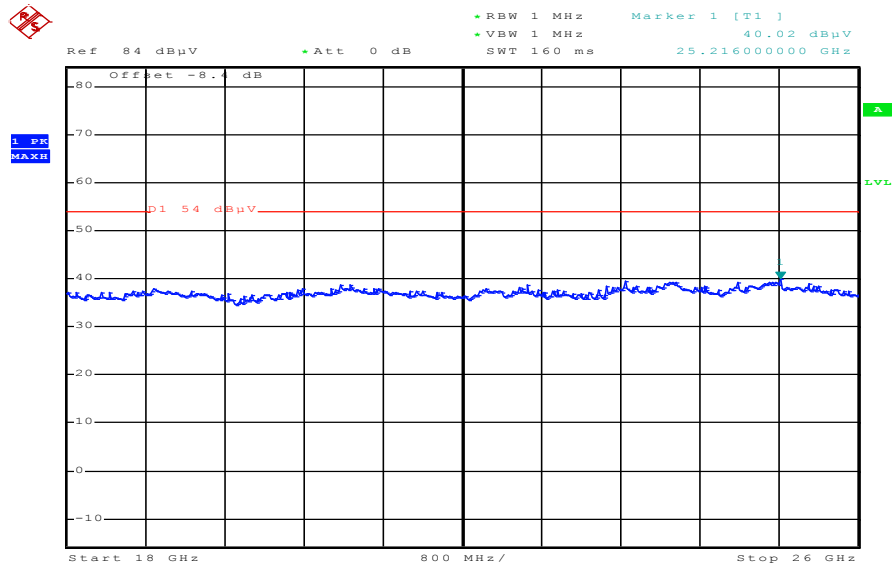

Date: 15.MAR.2012 15:27:16

Plot 6: Middle channel, 30 MHz to 1 GHz, vertical & horizontal polarization

Common Information

EUT: CP910
 Serial Number: #101011;0028318U
 Test Description: FCC part 15C class B
 Operating Conditions: cont. TX @ 2442 MHz
 Operator Name: Wolsdorfer
 Comment: battery powered

Scan Setup: STAN_Fin [EMI radiated]

Hardware Setup: Electric Field (NOS)
 Receiver: [ESCI 3]
 Level Unit: dBµV/m

Subrange	Step Size	Detectors	IF BW	Meas. Time	Preamp
30 MHz - 2 GHz	60 kHz	QPK	120 kHz	1 s	20 dB

FCC_10m(B)_3

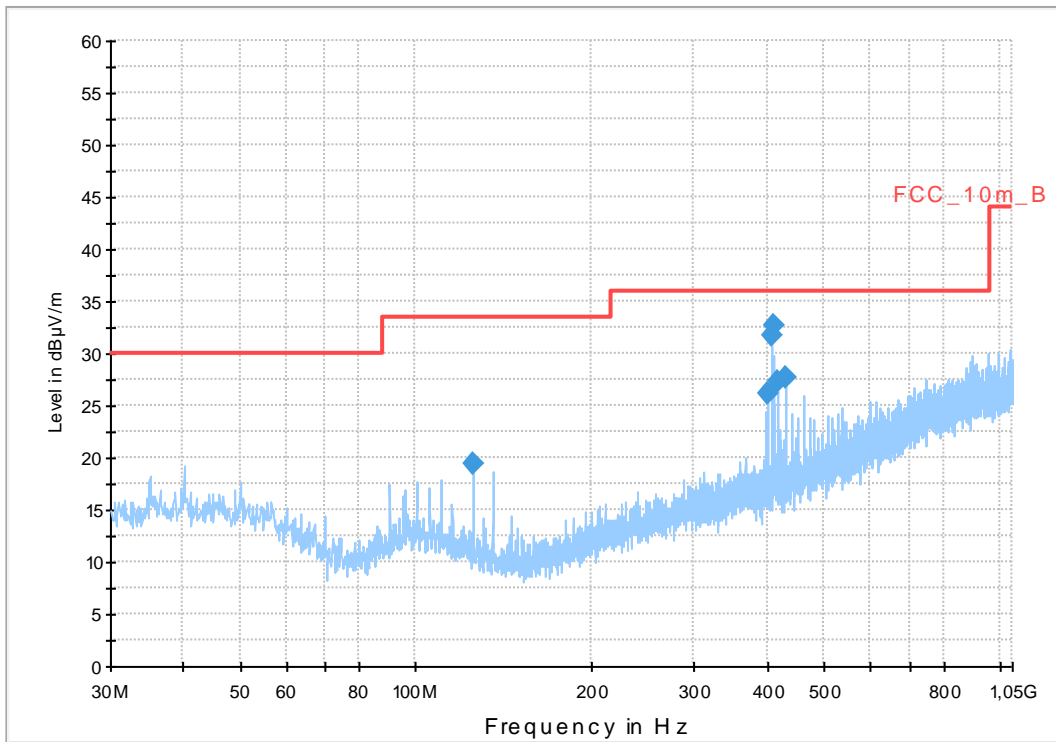

Final Result 1

Frequency (MHz)	QuasiPeak (dBµV/m)	Meas. Time (ms)	Bandwidth (kHz)	Height (cm)	Polarization	Azimuth (deg)	Corr. (dB)	Margin (dB)	Limit (dBµV/m)	Comment
125.369400	19.5	1000.0	120.000	98.0	V	8.0	9.8	14.0	33.5	
401.105400	26.2	1000.0	120.000	98.0	V	196.0	16.9	9.8	36.0	
406.108650	31.8	1000.0	120.000	98.0	V	179.0	17.0	4.2	36.0	
411.125250	32.7	1000.0	120.000	98.0	V	258.0	17.1	3.3	36.0	
416.169150	27.2	1000.0	120.000	98.0	V	283.0	17.2	8.8	36.0	
431.187600	27.7	1000.0	120.000	98.0	V	263.0	17.4	8.3	36.0	

Plot 7: Middle channel, 1 GHz to 12.75 GHz, vertical polarization

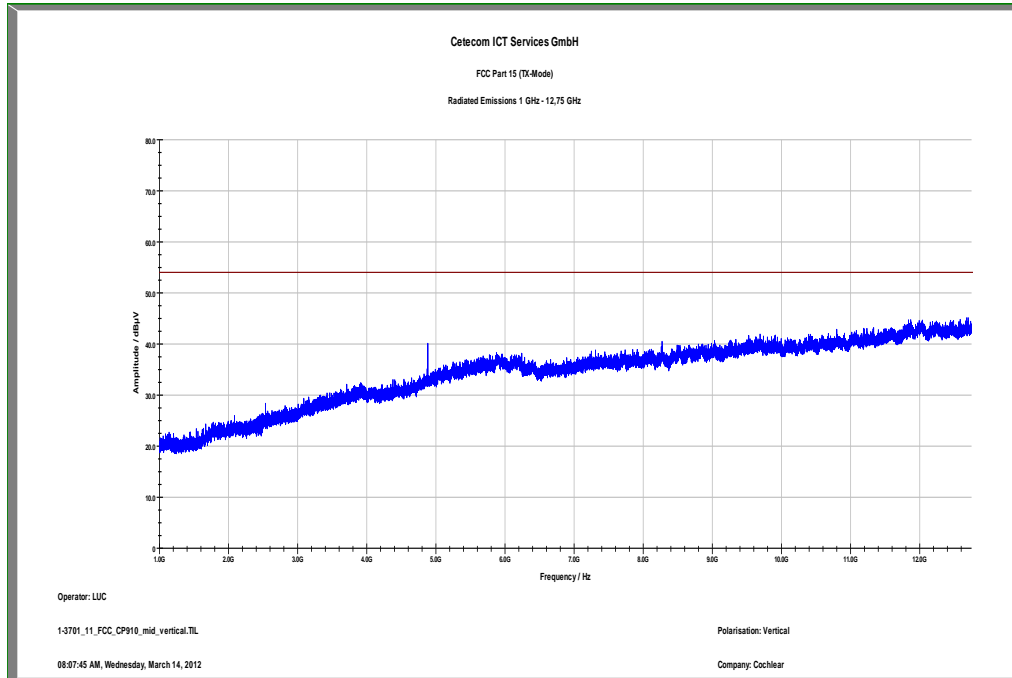

The carrier signal is notched with a 2.4 GHz band rejection filter.

Plot 8: Middle channel, 1 GHz to 12.75 GHz, horizontal polarization

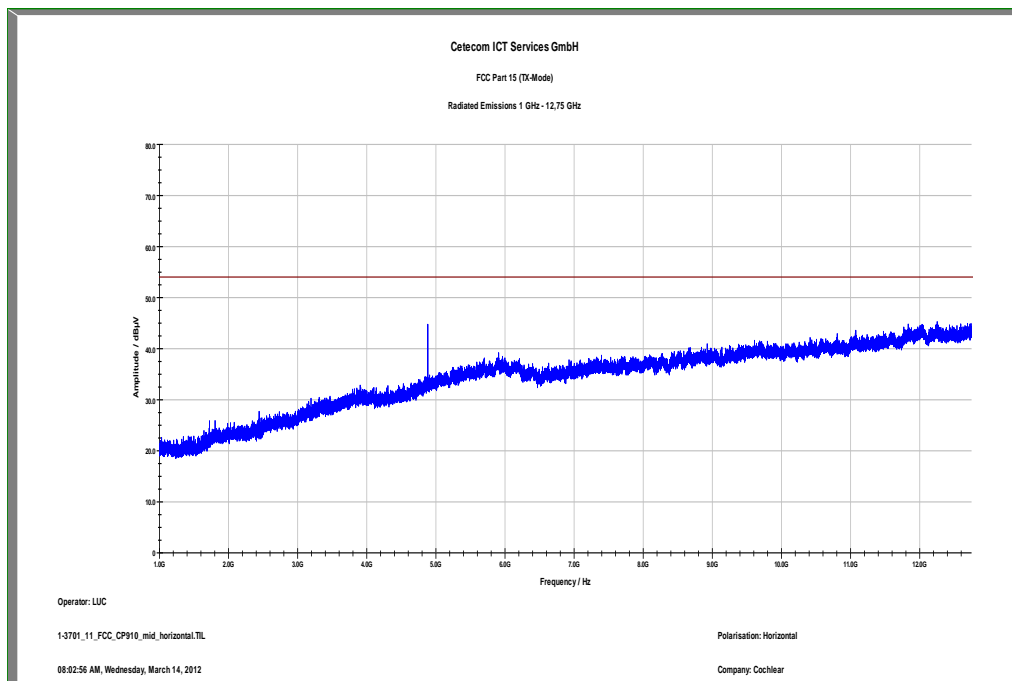

The carrier signal is notched with a 2.4 GHz band rejection filter.

Plot 9: Middle channel, 12 GHz to 18 GHz, vertical & horizontal polarization

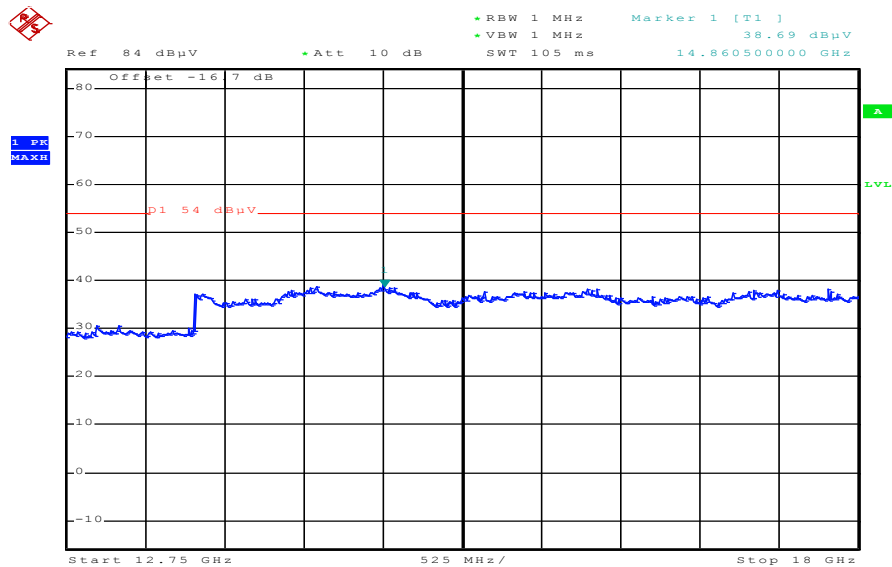

Date: 15.MAR.2012 15:32:08

Plot 10: Middle channel, 18 GHz to 26 GHz, vertical & horizontal polarization

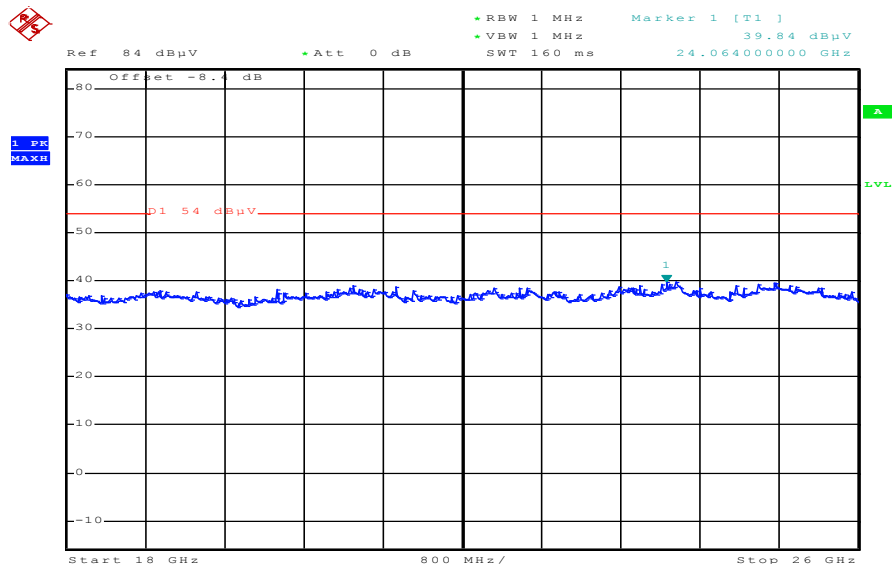

Date: 15.MAR.2012 15:27:57

Plot 11: Highest channel, 30 MHz to 1 GHz, vertical & horizontal polarization

Common Information

EUT: CP910
 Serial Number: #101011;0028318U
 Test Description: FCC part 15C class B
 Operating Conditions: cont. TX @ 2482 MHz
 Operator Name: Wolsdorfer
 Comment: battery powered

Scan Setup: STAN_Fin [EMI radiated]

Hardware Setup: Electric Field (NOS)
 Receiver: [ESCI 3]
 Level Unit: dBµV/m

Subrange	Step Size	Detectors	IF BW	Meas. Time	Preamp
30 MHz - 2 GHz	60 kHz	QPK	120 kHz	1 s	20 dB

FCC_10m(B)_3

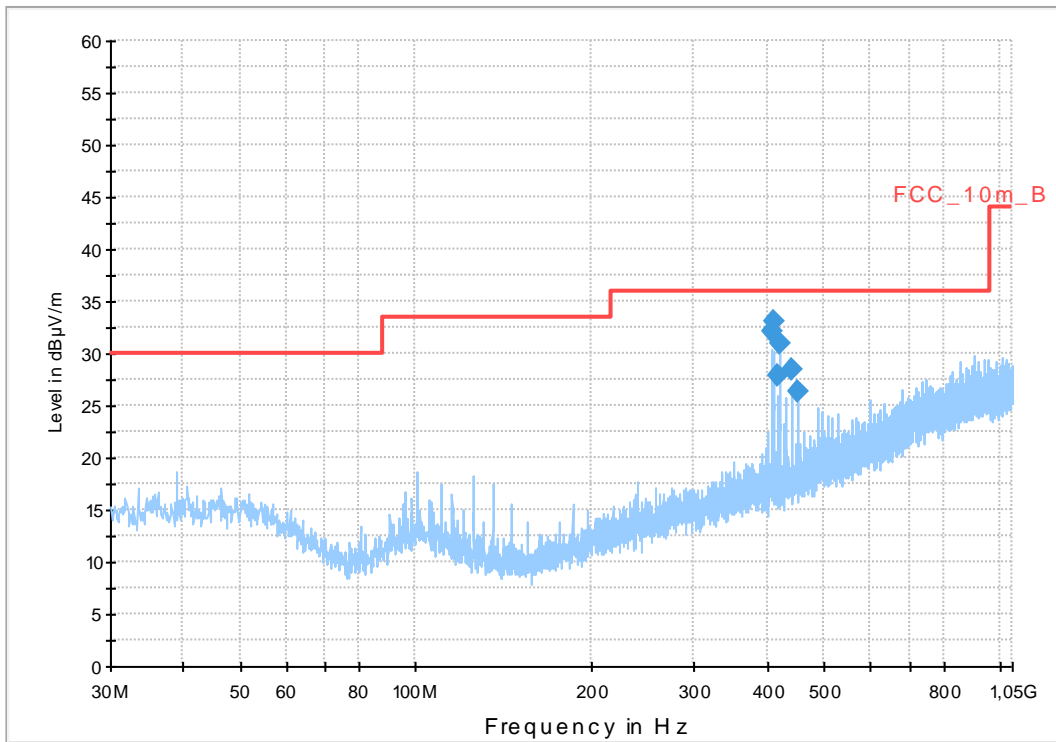

Final Result 1

Frequency (MHz)	QuasiPeak (dBµV/m)	Meas. Time (ms)	Bandwidth (kHz)	Height (cm)	Polarization	Azimuth (deg)	Corr. (dB)	Margin (dB)	Limit (dBµV/m)	Comment
406.099200	32.1	1000.0	120.000	98.0	V	171.0	17.0	3.9	36.0	
411.142650	33.0	1000.0	120.000	98.0	V	260.0	17.1	3.0	36.0	
416.141550	27.9	1000.0	120.000	105.0	V	82.0	17.2	8.1	36.0	
421.142400	30.9	1000.0	120.000	98.0	V	8.0	17.2	5.1	36.0	
441.219900	28.5	1000.0	120.000	98.0	V	273.0	17.5	7.5	36.0	
451.236150	26.4	1000.0	120.000	98.0	V	89.0	17.7	9.6	36.0	

Plot 12: Highest channel, 1 GHz to 12.75 GHz, vertical polarization

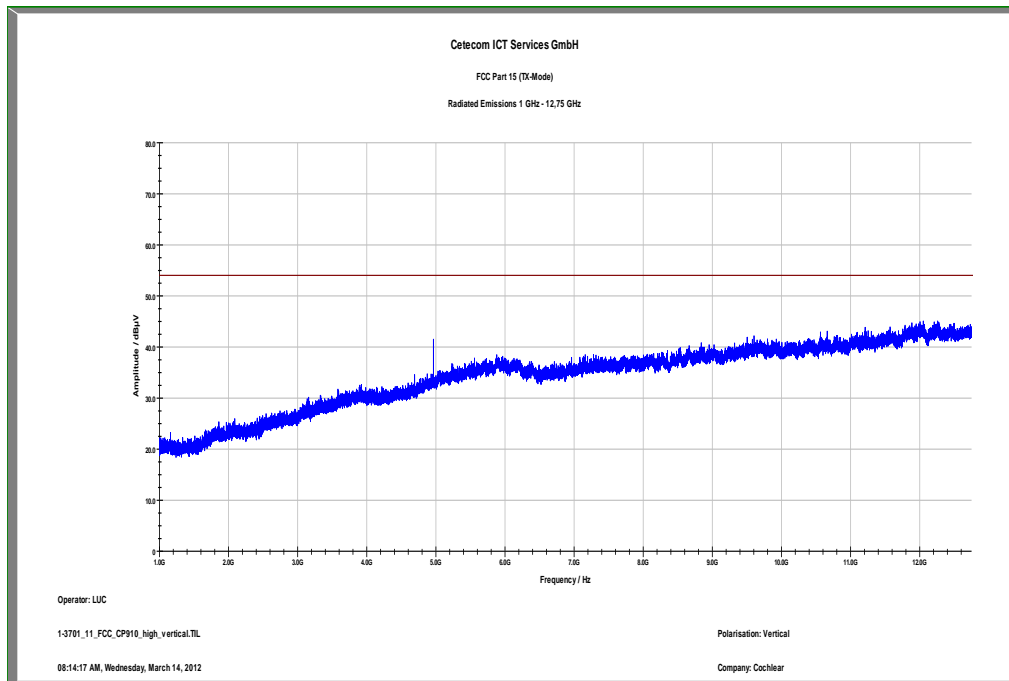

The carrier signal is notched with a 2.4 GHz band rejection filter.

Plot 13: Highest channel, 1 GHz to 12.75 GHz, horizontal polarization

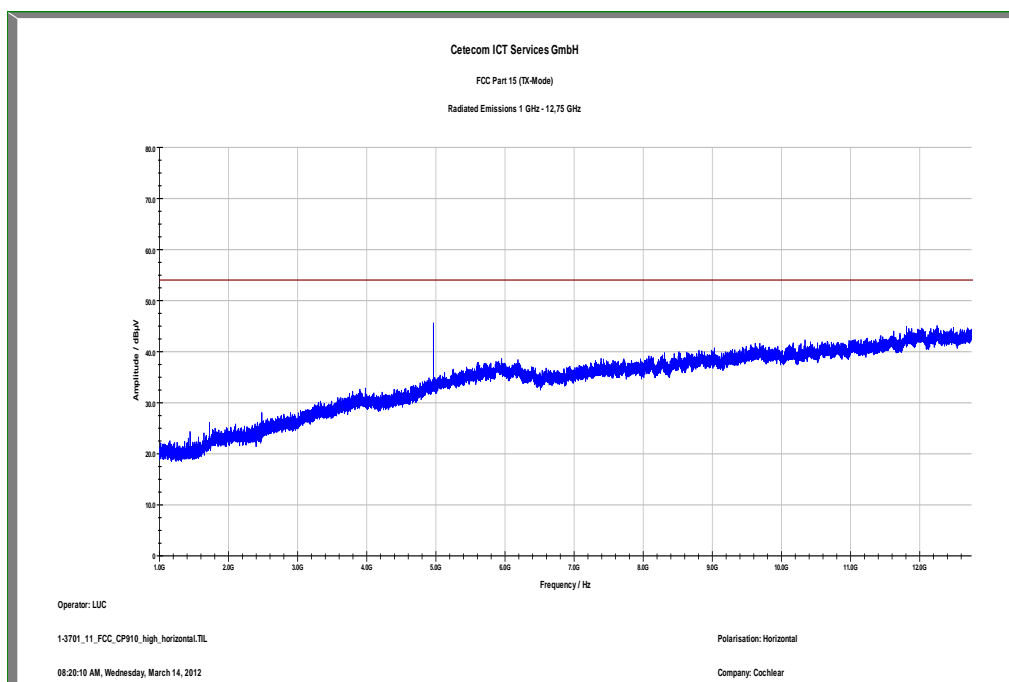

The carrier signal is notched with a 2.4 GHz band rejection filter.

Plot 14: Highest channel, 12 GHz to 18 GHz, vertical & horizontal polarization

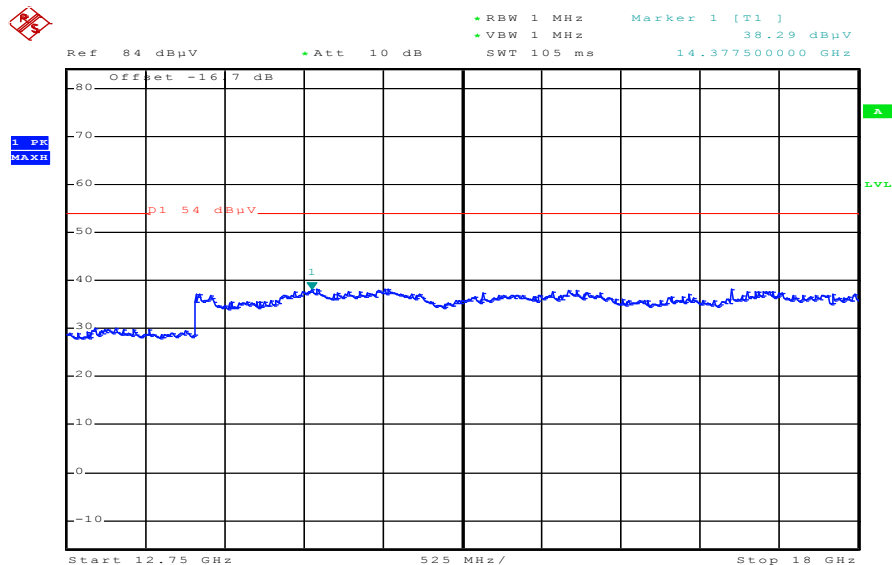

Date: 15.MAR.2012 15:30:24

Plot 15: Highest channel, 18 GHz to 26 GHz, vertical & horizontal polarization

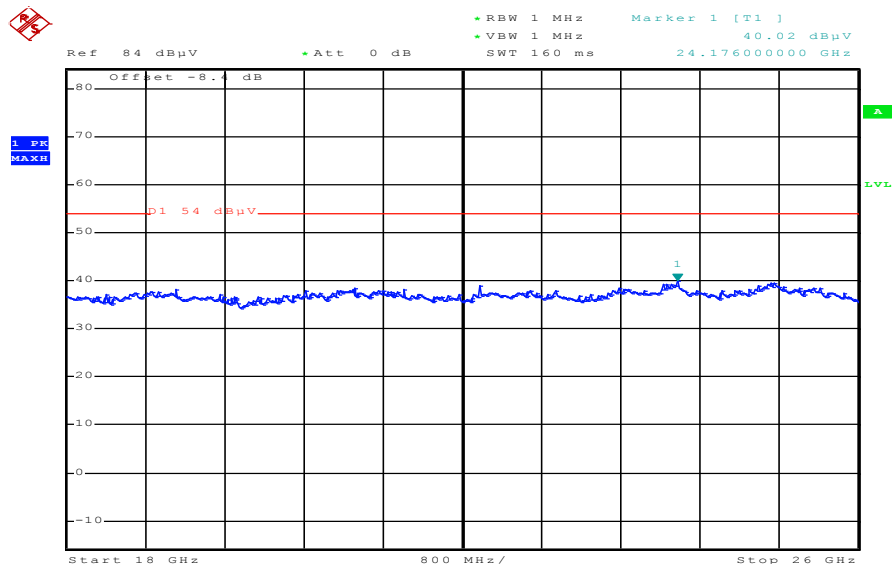

Date: 15.MAR.2012 15:28:34

9.6 RX spurious emissions radiated

Description:

Measurement of the radiated spurious emissions in idle/receive mode.

Measurement:

Measurement parameter	
Detector:	Peak / Quasi Peak
Sweep time:	Auto
Resolution bandwidth:	F < 1 GHz: 100 kHz F > 1 GHz: 1 MHz
Video bandwidth:	Sweep: 100 kHz Remeasurement: 10 Hz
Span:	30 MHz to 25 GHz
Trace-Mode:	Max Hold

Limits:

FCC		IC
RX Spurious Emissions Radiated		
Frequency (MHz)	Field Strength (dB μ V/m)	Measurement distance
30 - 88	30.0	10
88 – 216	33.5	10
216 – 960	36.0	10
Above 960	54.0	3

Results:

RX Spurious Emissions Radiated [dB μ V/m]		
F [MHz]	Detector	Level [dB μ V/m]
No critical peaks detected		
Measurement uncertainty	± 3 dB	

Result: The result of the measurement is passed.

Plots: RX / Idle – mode

Plot 1: 30 MHz to 1 GHz, vertical & horizontal polarization

Common Information

EUT: CP910
 Serial Number: #101012;0032575 U
 Test Description: FCC part 15C class B
 Operating Conditions: RX mode
 Operator Name: Wolsdorfer
 Comment: battery powered

Scan Setup: STAN_Fin [EMI radiated]

Hardware Setup: Electric Field (NOS)
 Receiver: [ESCI 3]
 Level Unit: dBµV/m

Subrange	Step Size	Detectors	IF BW	Meas. Time	Preamp
30 MHz - 2 GHz	60 kHz	QPK	120 kHz	1 s	20 dB

FCC_10m(B)_3

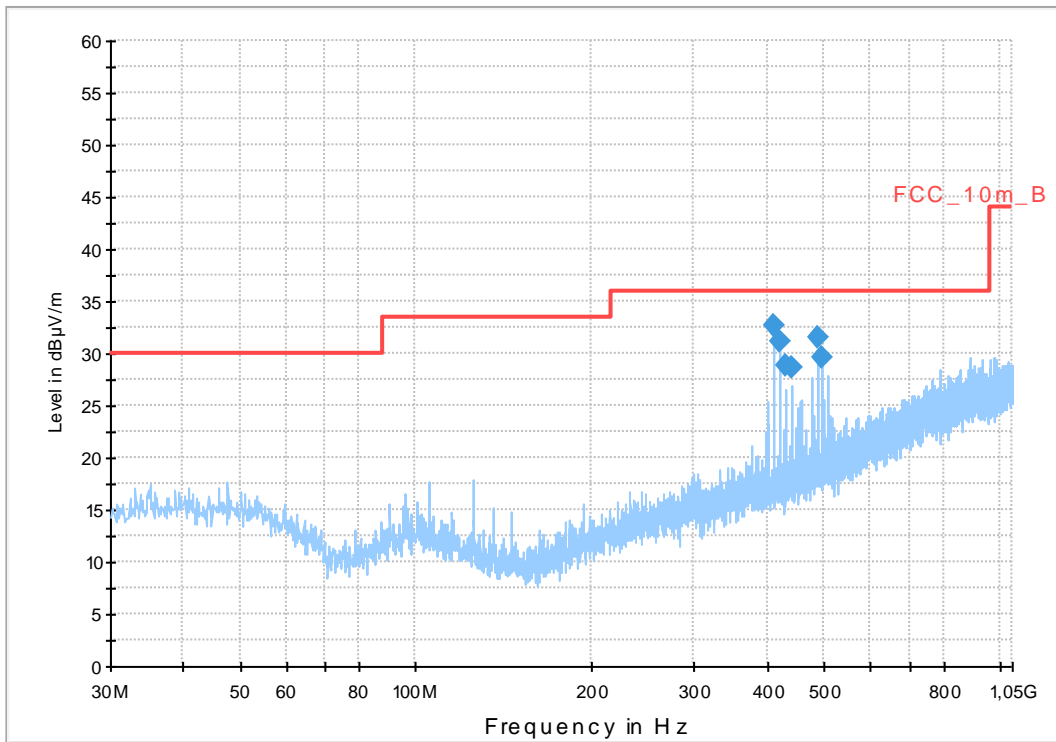

Final Result 1

Frequency (MHz)	QuasiPeak (dBµV/m)	Meas. Time (ms)	Bandwidth (kHz)	Height (cm)	Polarization	Azimuth (deg)	Corr. (dB)	Margin (dB)	Limit (dBµV/m)	Comment
411.122700	32.6	1000.0	120.000	98.0	V	8.0	17.1	3.4	36.0	
421.125750	31.2	1000.0	120.000	98.0	V	80.0	17.2	4.8	36.0	
431.155350	28.9	1000.0	120.000	98.0	V	106.0	17.4	7.1	36.0	
441.180150	28.6	1000.0	120.000	98.0	V	270.0	17.5	7.4	36.0	
486.314700	31.6	1000.0	120.000	98.0	V	179.0	18.4	4.4	36.0	
496.338300	29.7	1000.0	120.000	105.0	V	196.0	18.6	6.3	36.0	

Plot 2: 1 GHz to 12.75 GHz, vertical polarization

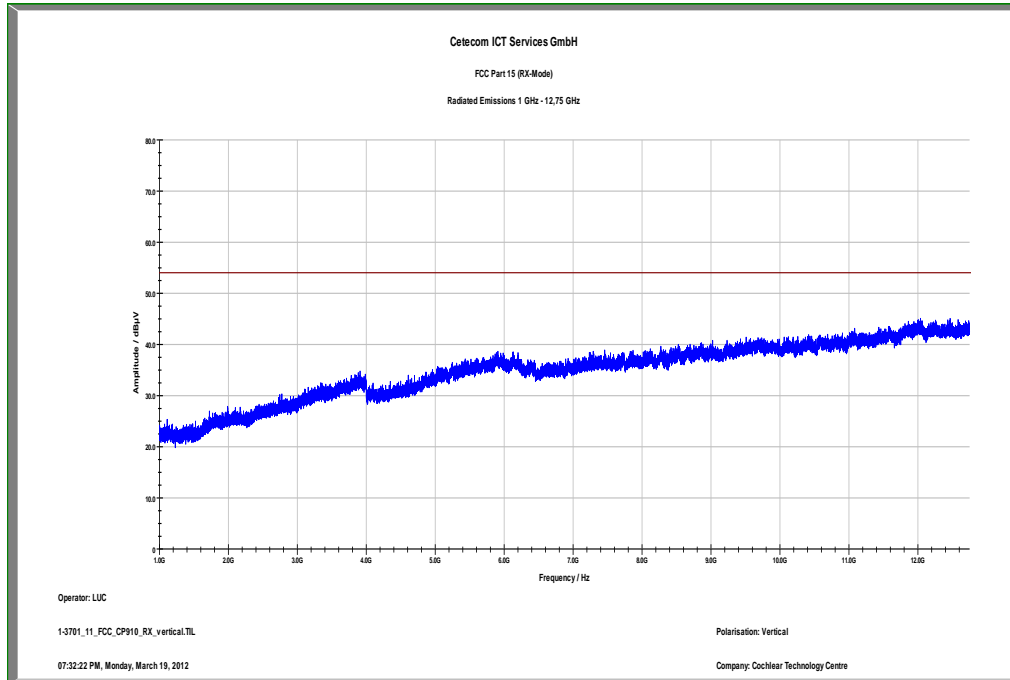

Plot 3: 1 GHz to 12.75 GHz, horizontal polarization

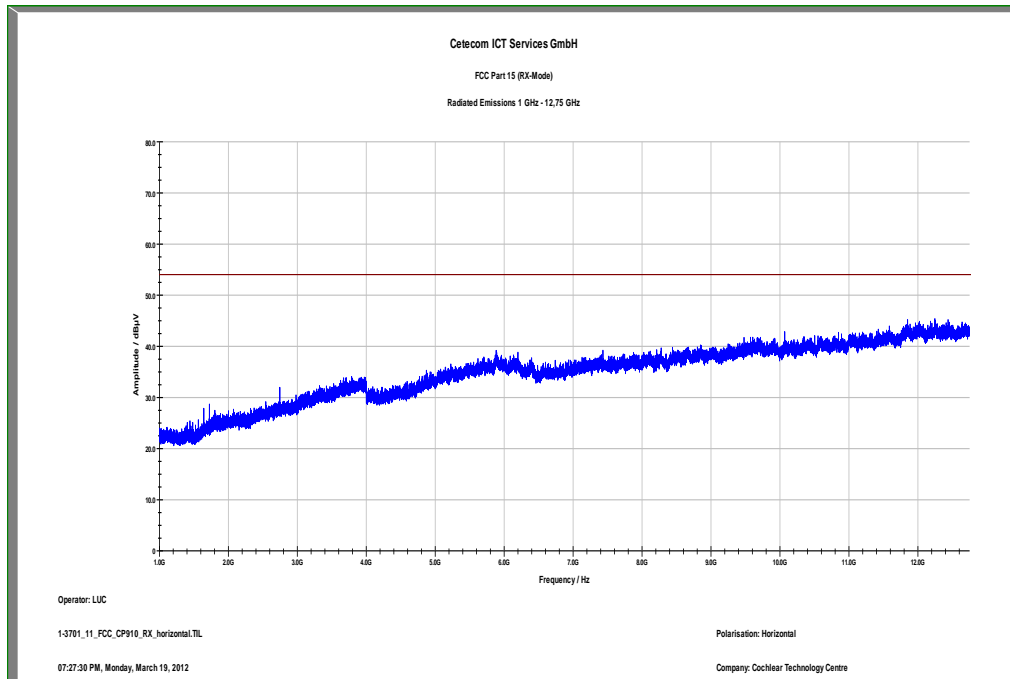

Plot 4: 12 GHz to 18 GHz, vertical & horizontal polarization

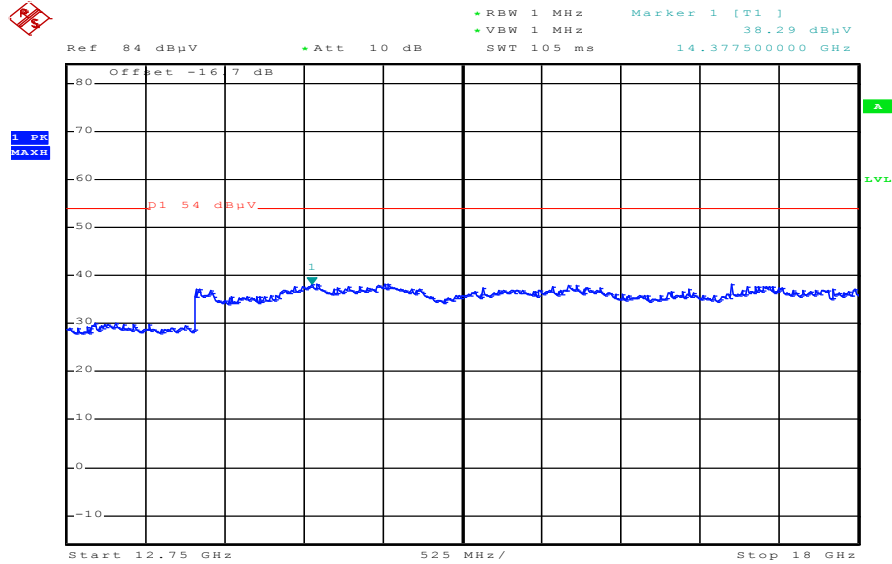

Date: 15.MAR.2012 15:30:24

Plot 5: 18 GHz to 25 GHz, vertical & horizontal polarization

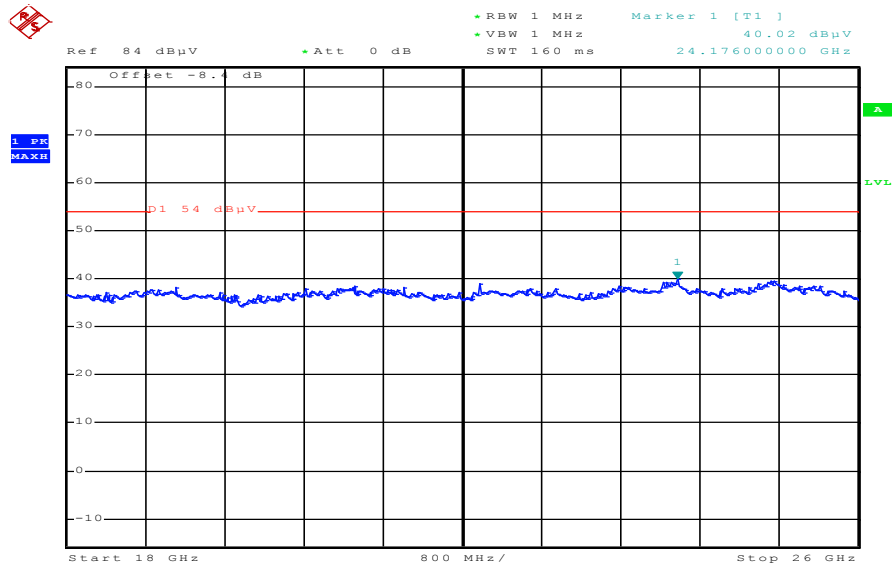

Date: 15.MAR.2012 15:28:34

9.7 Spurious emissions radiated < 30 MHz

Description:

Measurement of the radiated spurious emissions in transmit mode below 30 MHz. The EUT is set to lowest, middle and highest channel. The limits are recalculated to a measurement distance of 3 m with 40 dB/decade according CFR Part 2.

Measurement:

Measurement parameter	
Detector:	Peak / Quasi Peak
Sweep time:	Auto
Resolution bandwidth:	F < 150 kHz: 1 kHz F > 150 kHz: 100 kHz
Video bandwidth:	F < 150 kHz: 200 Hz F > 150 kHz: 9 kHz
Span:	9 kHz to 30 MHz
Trace-Mode:	Max Hold

Limits:

FCC		IC	
Spurious Emissions Radiated < 30 MHz			
Frequency (MHz)	Field Strength (dB μ V/m)	Measurement distance	
0.009 – 0.490	2400/F(kHz)	300	
0.490 – 1.705	24000/F(kHz)	30	
1.705 – 30.0	30	30	

Results:

Spurious Emissions Radiated < 30 MHz [dB μ V/m]								
2402 MHz			2442 MHz			2482 MHz		
F [MHz]	Detector	Level [dB μ V/m]	F [MHz]	Detector	Level [dB μ V/m]	F [MHz]	Detector	Level [dB μ V/m]
No critical peaks detected!			No critical peaks detected!			No critical peaks detected!		
Measurement uncertainty			± 3 dB					

Result: The result of the measurement is passed.

Plots:

Plot 1: 9 kHz to 30 MHz / lowest channel

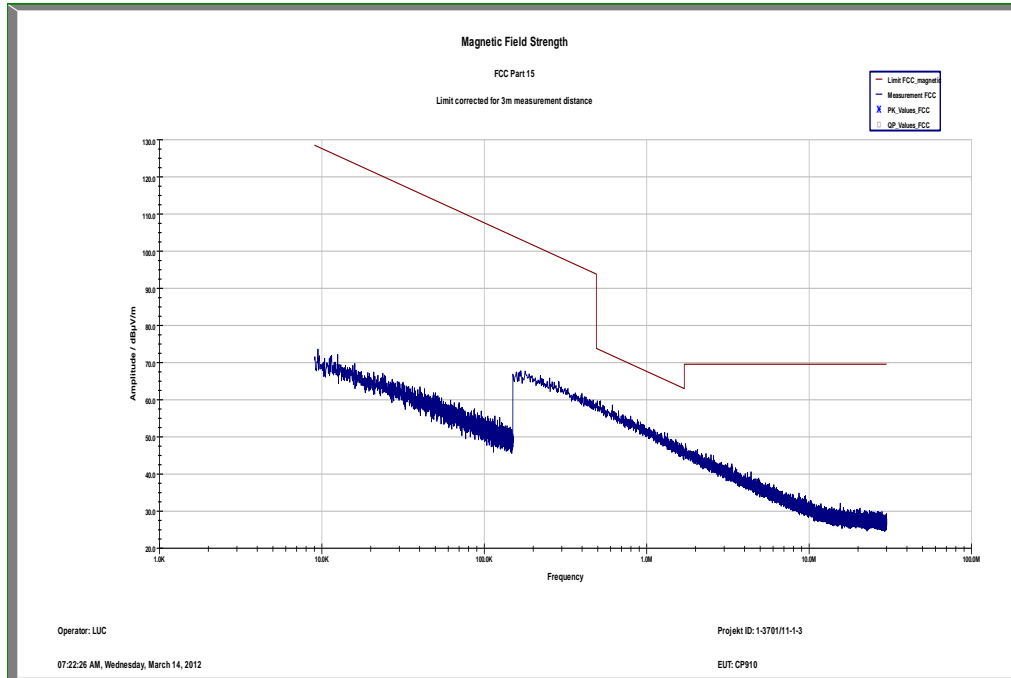

Plot 2: 9 kHz to 30 MHz / middle channel

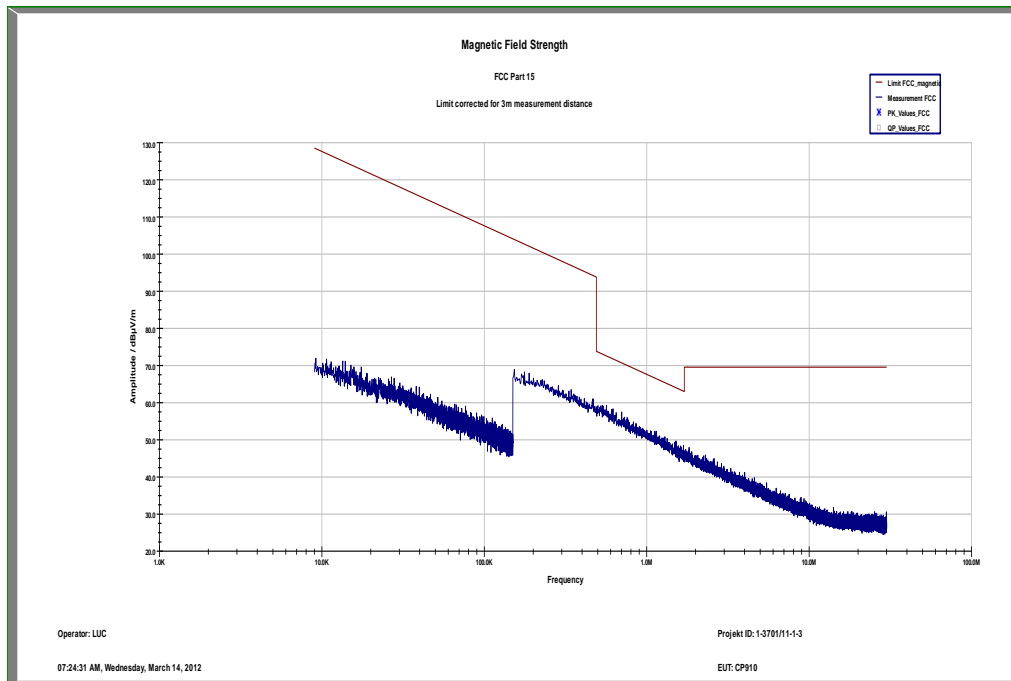

Plot 3: 9 kHz to 30 MHz / highest channel

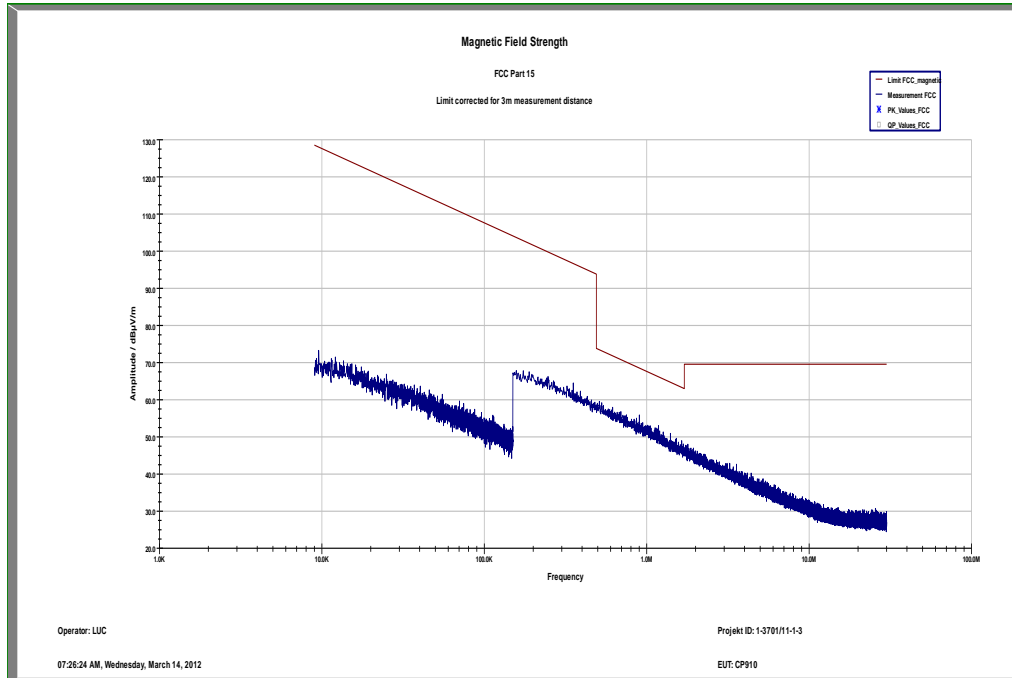

Plot 4: 9 kHz to 30 MHz / Idle mode

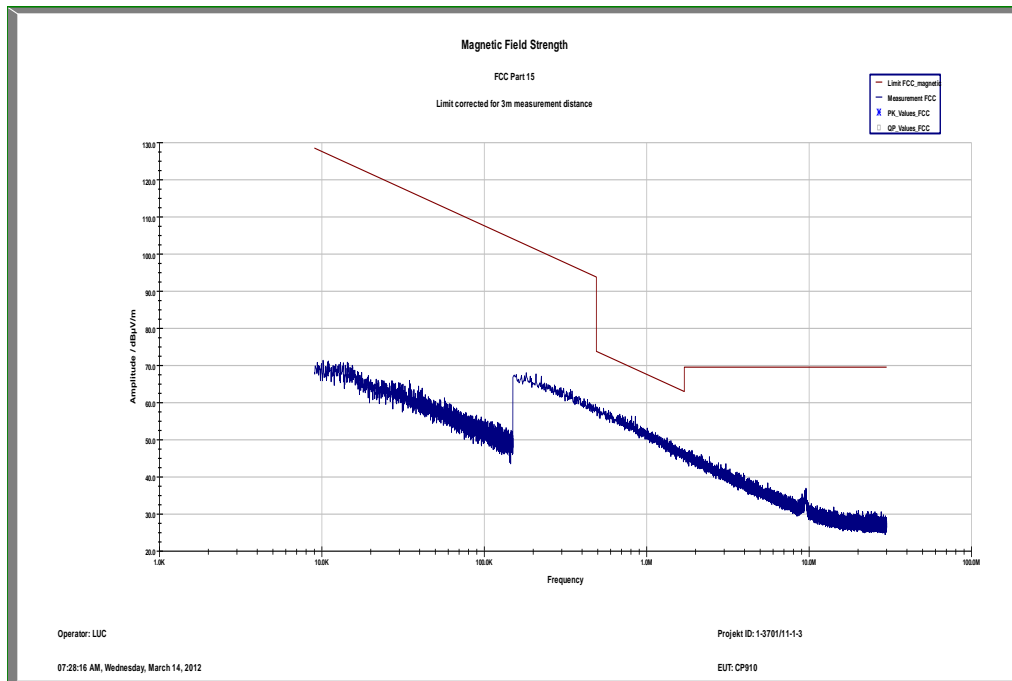

9.8 Spurious emissions conducted < 30 MHz

Not applicable!

10 Test equipment and ancillaries used for tests

Typically, the calibrations of the test apparatus are commissioned to and performed by an accredited calibration laboratory. The calibration intervals are determined in accordance with the DIN EN ISO/IEC 17025. In addition to the external calibrations, the laboratory executes comparison measurements with other calibrated test systems or effective verifications. Weekly chamber inspections and range calibrations are performed. Where possible, rf-generating and signalling equipment as well as measuring receivers and analyzers are connected to an external high-precision 10 MHz reference (GPS-based or rubidium frequency standard).

In order to simplify the identification of the equipment used at some special tests, some items of test equipment and ancillaries can be provided with an identifier or number in the equipment list below (Labor/Item).

No.	Lab / Item	Equipment	Type	Manufact.	Serial No.	INV. No Cetecom	Kind of Calibration	Last Calibration	Next Calibration
11	n. a.	Temperature Test Chamber	VT 4002	Heraeus Voetsch	521/83761	300002326	Ve	20.09.2011	20.09.2013
2	A026	Std. Gain Horn Antenna 12.4 to 18.0 GHz	639	Narda		300000787	ne		
3	A029	Std. Gain Horn Antenna 18.0 to 26.5 GHz	638	Narda		300002442	ne		
4	n. a.	Spectrum Analyzer 9kHz to 30GHz - 140...+30dBm	FSP30	R&S	100886	300003575	k	07.09.2010	07.09.2012
5	11b	Microwave System Amplifier, 0.5-26.5 GHz	83017A	HP Meßtechnik	00419	300002268	ev	10.03.2011	
6	n. a.	DC Power Supply 0 – 32V	1108-32	Heiden	001802	300001383	Ve	23.06.2010	23.06.2013
7	n. a.	Double-Ridged Waveguide Horn Antenna 1-18.0GHz	3115	EMCO	8812-3088	300001032	viKI!	11.05.2011	11.05.2013
8	n. a.	Active Loop Antenna	6502	EMCO	2210	300001015	ne		
9	n. a.	Anechoic chamber	FAC 3/5m	MWB / TDK	87400/02	300000996		23.03.2009	
10	n. a.	Relais Matrix	3488A	HP Meßtechnik	2719A15013	300001156	ne		
11	n. a.	Three-Way Power Splitter, 50 Ohm	11850C	HP Meßtechnik		300000997	ne		
12	n. a.	Switch / Control Unit	3488A	HP	2605e08770	300001443	ne		
13	n. a.	Amplifier	js42-00502650-28-5a	Parzich GMBH	928979	300003143	ne		
14	n. a.	TILE-Software Emission	Quantum Change, Modell TILE-ICS/FULL	EMCO	none	300003451	ne		
15	n. a.	Highpass Filter	WHKX2.9/1 8G-12SS	Wainwright	1	300003492	ev		
16	n. a.	Highpass Filter	WHK1.1/15 G-10SS	Wainwright	3	300003255	ev		
17	n. a.	Highpass Filter	WHKX7.0/1 8G-8SS	Wainwright	18	300003789	ne		
18	n. a.	PSA Spectrum Analyzer 3 Hz - 26.5 GHz	E4440A	Agilent Technologies	MY48250080	300003812	k	08.09.2010	08.09.2012
19	n. a.	RF Filter Section 9kHz - 1GHz	N9039A	Agilent Technologies	MY48260003	300003825	viKI!	08.09.2010	08.09.2012
20	n. a.	TRILOG Broadband Test-Antenna 30 MHz - 3 GHz	VULB9163	Schwarzbeck	371	300003854	viKI!	14.10.2011	14.10.2014
21	45	Switch-Unit	3488A	HP Meßtechnik	2719A14505	300000368	g		
22	50	DC power supply, 60Vdc,	6032A	HP Meßtechnik	2920A04466	300000580	ne		

		50A, 1200 W							
23	n. a.	software	SPS_PHE 1.4f	Spitzberger & Spieß	B5981; 5D1081;B597 9	300000210	ne		
24	n. a.	EMI Test Receiver	ESCI 1166.5950. 03	R&S	100083	300003312	k	05.01.2011	05.01.2013
25	n. a.	Analyzer- Reference- System (Harmonics and Flicker)	ARS 16/1	SPS	A3509 07/0 0205	300003314	k	14.07.2011	14.07.2013
26	n. a.	Amplifier	JS42- 00502650- 28-5A	MITEQ	1084532	300003379	ev		
27	n. a.	Antenna Tower	Model 2175	ETS- LINDGREN	64762	300003745	izw		
28	n. a.	Positioning Controller	Model 2090	ETS- LINDGREN	64672	300003746	izw		
29	n. a.	Turntable Interface-Box	Model 105637	ETS- LINDGREN	44583	300003747	izw		
30	n. a.	TRILOG Broadband Test-Antenna 30 MHz - 3 GHz	VULB9163	Schwarzbe ck	295	300003787	k	01.04.2010	01.04.2012
31	n. a.	Spectrum- Analyzer	FSU26	R&S	200809	300003874	k	10.01.2011	10.01.2013

Agenda: Kind of Calibration

k calibration / calibrated
 ne not required (k, ev, izw, zw not required)
 ev periodic self verification
 Ve long-term stability recognized
 vlk! Attention: extended calibration interval
 NK! Attention: not calibrated

EK limited calibration
 zw cyclical maintenance (external cyclical maintenance)
 izw internal cyclical maintenance
 g blocked for accredited testing
 *) next calibration ordered / currently in progress

11 Observations

No observations exceeding those reported with the single test cases have been made.

Annex A Photographs of the test setup

Photo documentation:

Photo 1:

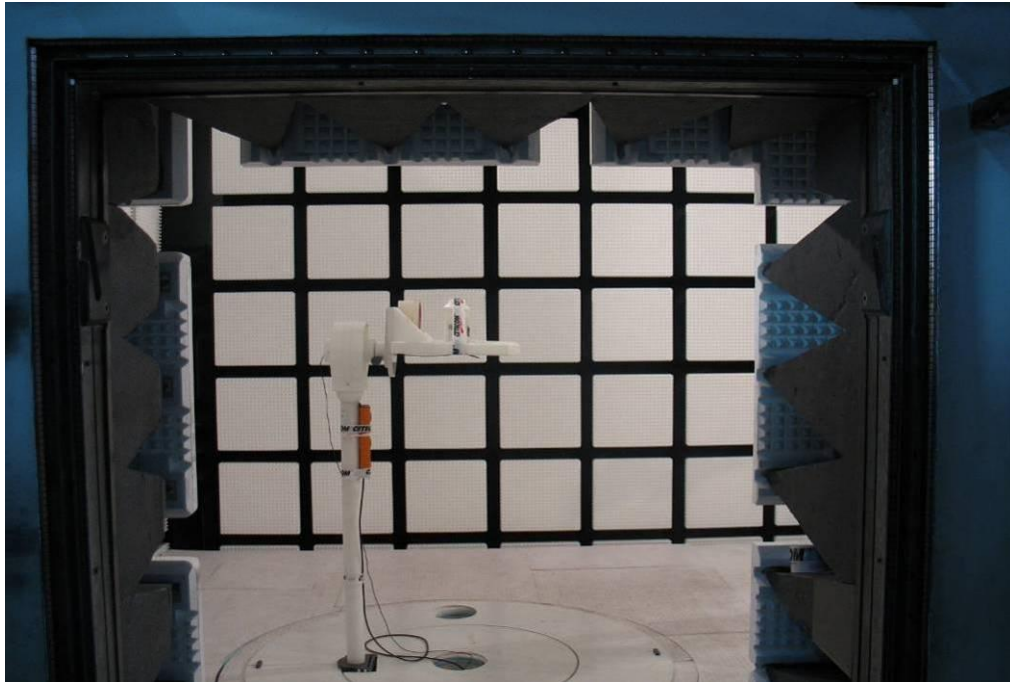

Photo 2:



Photo 3:



Photo 4:



Photo 5:

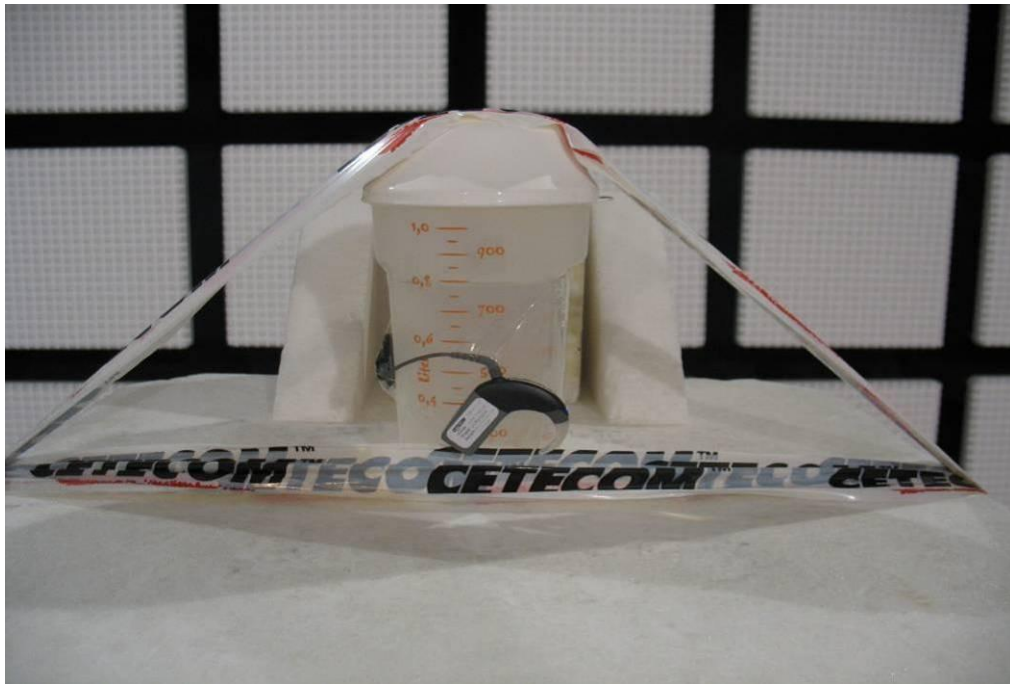

Photo 6:

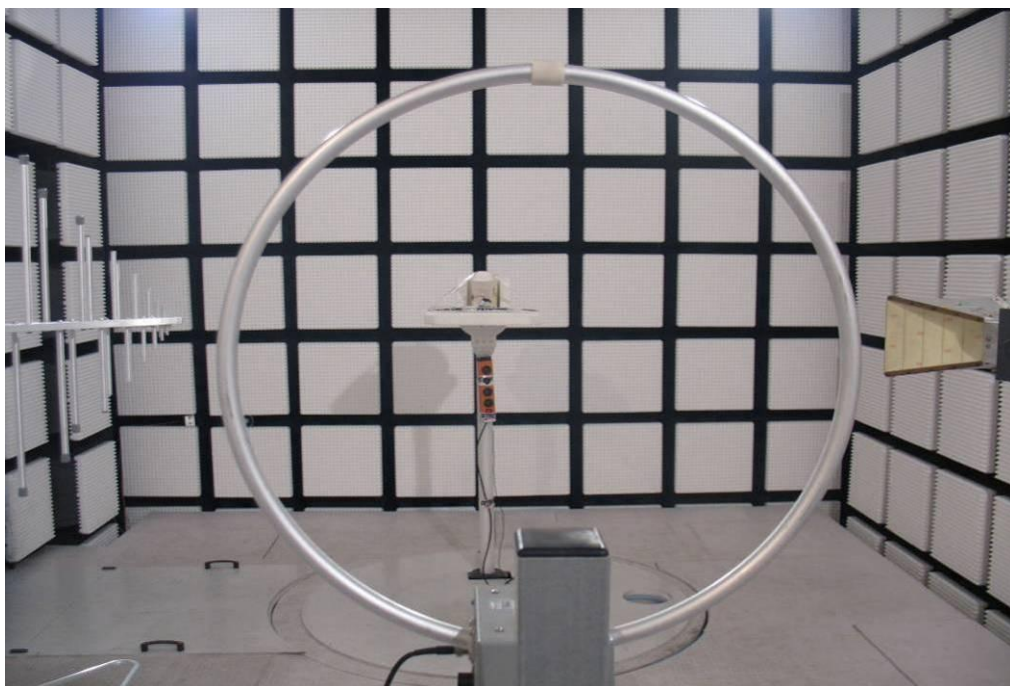

Photo 7:

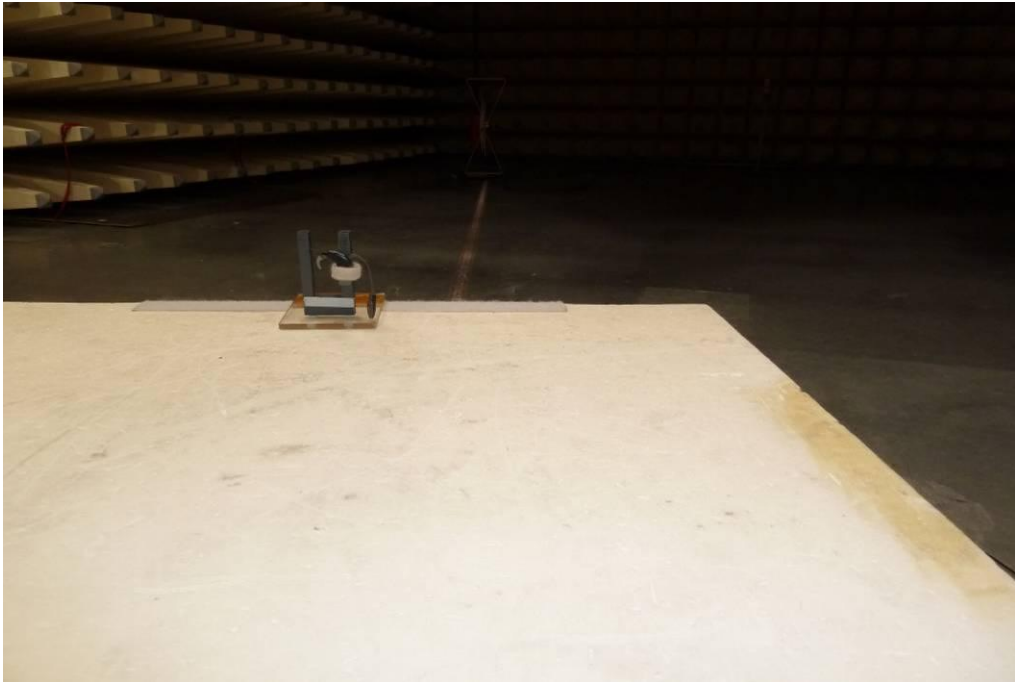

Photo 8:



Annex B External photographs of the EUT

Photo documentation:

Photo 1:



Photo 2:



Photo 3:



Photo 4:



Photo 5:



Photo 6:



Photo 7:



Photo 8:



Annex C Internal photographs of the EUT

Photo documentation:

Photo 1:

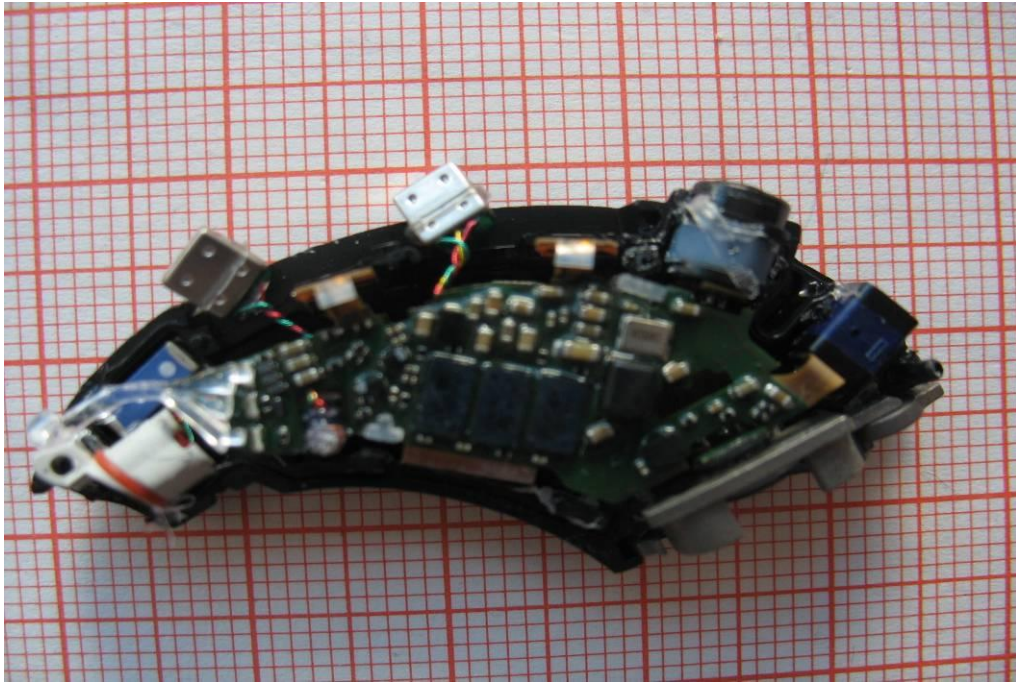

Photo 2:

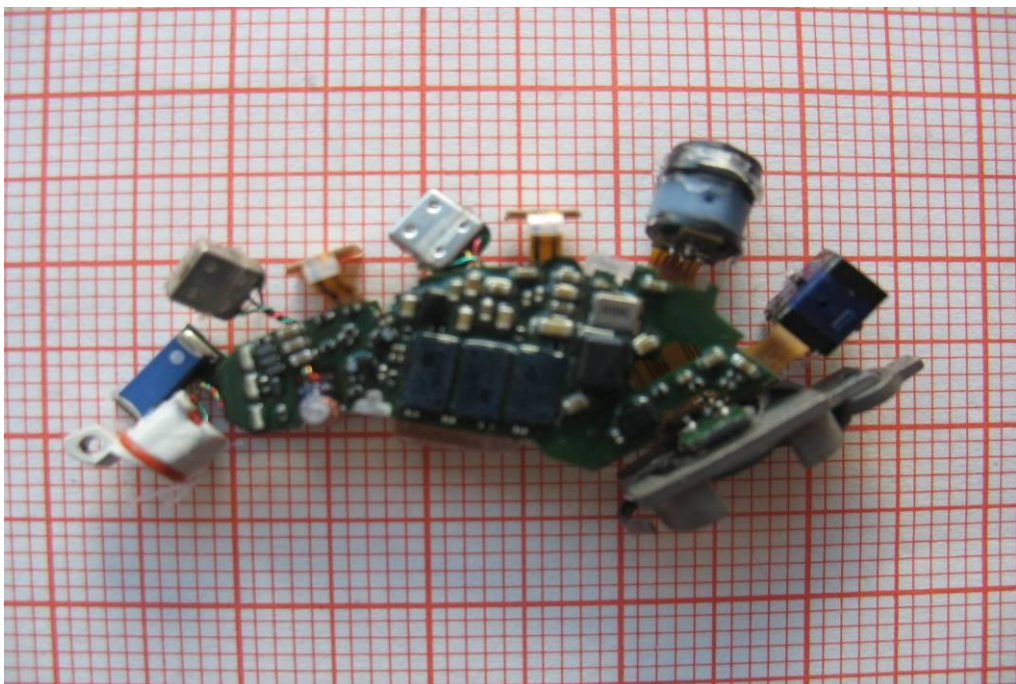
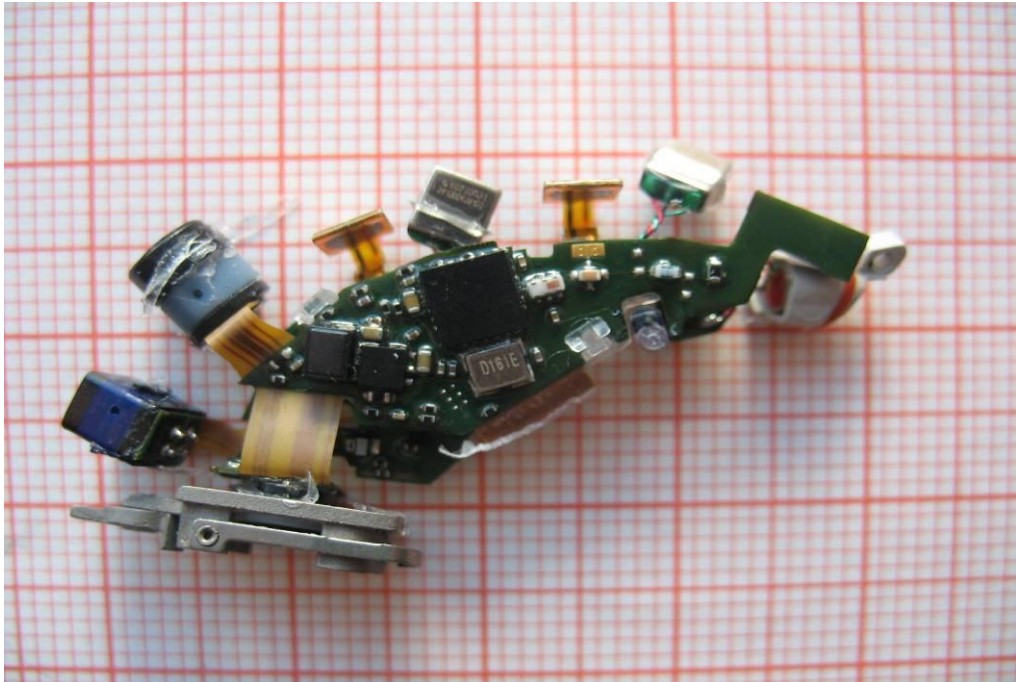

Photo 3:



Annex D Document history

Version	Applied changes	Date of release
1.0	Initial release	2012-04-02

Annex E Further information

Glossary

AVG	-	Average
DUT	-	Device under test
EMC	-	Electromagnetic Compatibility
EN	-	European Standard
EUT	-	Equipment under test
ETSI	-	European Telecommunications Standard Institute
FCC	-	Federal Communication Commission
FCC ID	-	Company Identifier at FCC
HW	-	Hardware
IC	-	Industry Canada
Inv. No.	-	Inventory number
N/A	-	Not applicable
PP	-	Positive peak
QP	-	Quasi peak
S/N	-	Serial number
SW	-	Software

Annex F Accreditation Certificate



Deutsche Akkreditierungsstelle GmbH
German Accreditation Body

Entrusted according to Section 8 subsection 1 AkkStelleG in connection with Section 1 subsection 1 AkkStelleGBV
Signatory to the Multilateral Agreements of EA, ILAC and IAF for Mutual Recognition

Accreditation



The Deutsche Akkreditierungsstelle GmbH (German Accreditation Body) attests that the testing laboratory

CETECOM ICT Services GmbH
Untertürkheimer Straße 6-10
66117 Saarbrücken

is competent under the terms of DIN EN ISO/IEC 17025:2005 to carry out tests in the following fields:

Wired communications and DECT
Acoustic
Radio
Shurt Range Devices (SRD)
RFID
WiMax and Richtfunk
Mobile radio (GSM / DCS), Over the Air (OTA) Performance
Electromagnetic Compatibility (EMC) incl. Automotive
Product safety
SAR and Hearing Aid Compatibility (HAC)
Environmental simulation
Smart Card Terminals
Bluetooth
Wi-Fi-Services

The accreditation certificate shall only apply in connection with the notice of accreditation of 13.04.2011 with the accreditation number D-PL-12076-01 and is valid until 03.09.2014. It comprises the cover sheet, the reverse side of the cover sheet and the following annex with a total of 82 pages.

Registration number of the certificate: **D-PL-12076-01-01**

Frankfurt am Main, 13.04.2011

Dipl.-Ing. (FH) Eberhard Eger
Head of Division 2

This document is a translation. The definitive version is the original German accreditation certificate.
See annex overleaf.

Front side of certificate

Deutsche Akkreditierungsstelle GmbH

Office Berlin
Spittelmarkt 10
10117 Berlin

Office Frankfurt am Main
Gartenstraße 6
60594 Frankfurt am Main

Office Braunschweig
Bundesallee 100
38116 Braunschweig

The publication of extracts of the accreditation certificate is subject to the prior written approval by Deutsche Akkreditierungsstelle GmbH (DAkkS). Exempted is the unchanged form of separate disseminations of the cover sheet by the conformity assessment body mentioned overleaf.

No impression shall be made that the accreditation also extends to fields beyond the scope of accreditation attested by DAkkS.

The accreditation was granted pursuant to the Act on the Accreditation Body (AkkStelleG) of 31 July 2009 (Federal Law Gazette I p. 2625) and the Regulation (EC) No 765/2008 of the European Parliament and of the Council of 9 July 2008 setting out the requirements for accreditation and market surveillance relating to the marketing of products (Official Journal of the European Union L 218 of 9 July 2008, p. 30). DAkkS is a signatory to the Multilateral Agreements for Mutual Recognition of the European co-operation for Accreditation (EA), International Accreditation Forum (IAF) and International Laboratory Accreditation Cooperation (ILAC). The signatories to these agreements recognise each other's accreditations.

The up-to-date state of membership can be retrieved from the following websites:
EA: www.european-accreditation.org
ILAC: www.ilac.org
IAF: www.iaf.nu

Back side of certificate

Note:

The current certificate including annex is published on our website (see link below) or may be received from CETECOM ICT Services on request.

http://www.cetecom.com/fileadmin/de/CETECOM_D_Saarbruecken/accreditations_Jan_2010/DAKKS_Akkredi_Urk_EN17025-En_incl_Annex.pdf