FCC Test Report

Report No.: AGC02039150905FE03

FCC ID : WTDG11
APPLICATION PURPOSE : Original Equipment
PRODUCT DESIGNATION : Sporty Stereo Bluetooth Headset
BRAND NAME : DACOM
MODEL NAME : See Page 4
CLIENT : Shenzhen Sande Dacom Electronics Co., Ltd
DATE OF ISSUE : Oct.09,2015
STANDARD(S) : FCC Part 15 Rules
TEST PROCEDURE(S)
REPORT VERSION : V1.0

Attestation of Global Compliance (Shenzhen) Co., Ltd



CAUTION:

This report shall not be reproduced except in full without the written permission of the test laboratory and shall not be quoted out of context.



Report Revise Record

Report Version	Revise Time	Issued Date	Valid Version	Notes
V1.0	/	Oct.09,2015	Valid	Original Report

TABLE OF CONTENTS

1. VERIFICATION OF CONFORMITY	4
2. GENERAL INFORMATION	5
2.1. PRODUCT DESCRIPTION.....	5
2.2. TABLE OF CARRIER FREQUENCYS.....	5
3. MEASUREMENT UNCERTAINTY.....	7
4. DESCRIPTION OF TEST MODES.....	7
5. SYSTEM TEST CONFIGURATION	8
5.1. CONFIGURATION OF EUT SYSTEM	8
5.2. EQUIPMENT USED IN EUT SYSTEM	8
5.3. SUMMARY OF TEST RESULTS	8
6. TEST FACILITY	9
7 ALL TEST EQUIPMENT LIST	9
8. RADIATED EMISSION	10
8.1TEST LIMIT.....	10
8.2. MEASUREMENT PROCEDURE	11
8.3. TEST SETUP.....	13
8.4. TEST RESULT	15
9. BAND EDGE EMISSION	41
9.1. MEASUREMENT PROCEDURE	41
9.2 TEST SETUP	41
9.3 RADIATED TEST RESULT	42
10. 20DB BANDWIDTH.....	50
10.1. MEASUREMENT PROCEDURE	50
10.2. TEST SET-UP	50
10.3. LIMITS AND MEASUREMENT RESULTS.....	50
11. FCC LINE CONDUCTED EMISSION TEST	60
11.1. LIMITS OF LINE CONDUCTED EMISSION TEST	60
11.2. BLOCK DIAGRAM OF LINE CONDUCTED EMISSION TEST.....	60
11.3. PRELIMINARY PROCEDURE OF LINE CONDUCTED EMISSION TEST	61
11.4. FINAL PROCEDURE OF LINE CONDUCTED EMISSION TEST.....	61
11.5. TEST RESULT OF LINE CONDUCTED EMISSION TEST.....	61
APPENDIX A: PHOTOGRAPHS OF TEST SETUP	62
APPENDIX B: PHOTOGRAPHS OF EUT	63

1. VERIFICATION OF CONFORMITY

Applicant	Shenzhen Sande Dacom Electronics Co., Ltd
Address	Building I, NO.10, East of Shangxue Science & Technology Industrial Park, Bantian, Longgang, Shenzhen, China
Manufacturer	Shenzhen Sande Dacom Electronics Co., Ltd
Address	Building I, NO.10, East of Shangxue Science & Technology Industrial Park, Bantian, Longgang, Shenzhen, China
Product Designation	Sporty Stereo Bluetooth Headset
Brand Name	DACOM
Test Model	G11
Series Model	VBT005, BH1001, LUX BEATS, AngLink G11, Ring
Difference description	All the same except for model name and color.
Date of test	Sep.25,2015 and Sep.28,2015
Deviation	None
Condition of Test Sample	Normal
Report Template	AGCRT-US-BR/RF

We hereby certify that:

The above equipment was tested by Compliance Certification Service (Shenzhen) Inc. The test data, data evaluation, test procedures, and equipment configurations shown in this report were made in accordance with the procedures given in ANSI C63.4 (2009) and the energy emitted by the sample EUT tested as described in this report is in compliance with radiated emission limits of FCC Rules Part 15.249.



Tested By _____
Time Huang(Huang Nanhui) Oct.09,2015



Reviewed By _____
Forrest Lei(Lei Yonggang) Oct.09,2015



Approved By _____
Solger Zhang(Zhang Hongyi)
Authorized Officer Oct.09,2015

2. GENERAL INFORMATION

2.1. PRODUCT DESCRIPTION

A major technical description of EUT is described as following

Operation Frequency	2.402 GHz to 2.480GHz
RF Output Power	-4.96dBm(Max)
Bluetooth Version	V4.1
Modulation	GFSK, $\pi/4$ -DQPSK, 8DPSK
Number of channels	79 for BR/EDR 40 for BLE
Hardware Version	V3
Software Version	V1
Antenna Designation	Ceramic Antenna (Met 15.203 Antenna requirement)
Antenna Gain	2dBi
Power Supply	DC 3.7V
Note: The USB port only used for charging and can't be used to transfer data with PC. BT is not active when charging.	

2.2. TABLE OF CARRIER FREQUENCIES

BR/EDR Bluetooth channel List

Frequency Band	Channel Number	Frequency
2400~2483.5MHZ	0	2402MHZ
	1	2403MHZ
	:	:
	38	2440 MHZ
	39	2441 MHZ
	40	2442 MHZ
	:	:
	77	2479 MHZ
	78	2480 MHZ

BLE Channel List

Frequency Band	Channel Number	Frequency
2400~2483.5MHZ	0	2402MHZ
	1	2404MHZ
	:	:
	38	2478 MHZ
	39	2480 MHZ

3. MEASUREMENT UNCERTAINTY

The reported uncertainty of measurement $y \pm U$, where expanded uncertainty U is based on a standard uncertainty multiplied by a coverage factor of $k=2$, providing a level of confidence of approximately 95 %.

No.	Item	Uncertainty
1	Conducted Emission Test	$\pm 3.18\text{dB}$
2	All emissions, radiated	$\pm 3.91\text{dB}$
3	Temperature	$\pm 0.5^\circ\text{C}$
4	Humidity	$\pm 2\%$

4. DESCRIPTION OF TEST MODES

NO.	TEST MODE DESCRIPTION
1	Low channel GFSK
2	Middle channel GFSK
3	High channel GFSK
4	Low channel $\pi/4$ -DQPSK
5	Middle channel $\pi/4$ -DQPSK
6	High channel $\pi/4$ -DQPSK
7	Low channel 8DPSK
8	Middle channel 8DPSK
9	High channel 8DPSK
10	BT Link

Note:

1. All the test modes can be supply by battery, only the result of the worst case was recorded in the report, if no other cases.
2. For Radiated Emission, 3axis were chosen for testing for each applicable mode.
3. The EUT used fully-charged battery when tested.

5. SYSTEM TEST CONFIGURATION

5.1. CONFIGURATION OF EUT SYSTEM

Configure 1: (Normal hopping)



Configure 2: (Control continuous TX)

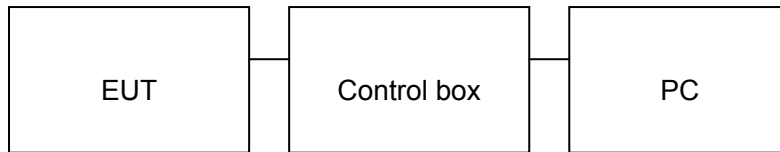

5.2. EQUIPMENT USED IN EUT SYSTEM

Item	Equipment	Model No.	ID or Specification	Remark
1	Sporty Stereo Bluetooth Headset	N/A	G11	EUT
2	PC	Lenovo	SL410K	A.E
3	Control box	N/A	N/A	A.E
4	USB Cable	N/A	1.2m	A.E

5.3. SUMMARY OF TEST RESULTS

FCC RULES	DESCRIPTION OF TEST	RESULT
§15.249	Radiated Emission	Compliant
§15.249	Band Edges	Compliant
§15.207	Conduction Emission	N/A
N/A	BANDWIDTH	Compliant

6. TEST FACILITY

Site	Compliance Certification Service(Shenzhen) Inc.
Location	No.10-1 Mingkeda Logistics Park, No.18 Huanguan South RD. Guan lan Town,Baoan Distr
FCC Registration No.	441872
Description	The test site is constructed and calibrated to meet the FCC requirements in documents ANSI C63.4:2009.

7 ALL TEST EQUIPMENT LIST

Radiated Emission Test Site 966(2)					
Name of Equipment	Manufacturer	Model Number	Serial Number	Last Calibration	Due Calibration
PSA Series Spectrum Analyzer	Agilent	E4446A	US44300399	03/01/2015	03/01/2016
EMI TEST RECEIVER	ROHDE&SCHWARZ	ESCI	100783	03/09/2015	03/08/2016
Amplifier	MITEQ	AM-1604-3000	1123808	03/18/2015	03/17/2016
High Noise Amplifier	Agilent	8449B	3008A01838	03/18/2015	03/17/2016
Board-Band Horn Antenna	Schwarzbeck	BBHA 9170	9170-497	07/10/2015	07/09/2016
Bilog Antenna	SCHAFFNER	CBL6143	5082	03/01/2015	03/01/2016
Horn Antenna	SCHWARZBECK	BBHA9120	D286	03/01/2015	03/01/2016
Loop Antenna	COM-POWER	AL-130	121044	09/27/2014	09/26/2015
Turn Table	N/A	N/A	N/A	N.C.R	N.C.R
Controller	Sunol Sciences	SC104V	022310-1	N.C.R	N.C.R
Controller	CT	N/A	N/A	N.C.R	N.C.R
Temp. / Humidity Meter	Anymetre	JR913	N/A	02/28/2015	02/27/2016
Antenna Tower	SUNOL	TLT2	N/A	N.C.R	N.C.R
Test S/W	FARAD	LZ-RF / CCS-SZ-3A2			

Conducted Emission Test Site					
Name of Equipment	Manufacturer	Model Number	Serial Number	Last Calibration	Due Calibration
EMI TEST RECEIVER	ROHDE&SCHWARZ	ESCI	100783	03/09/2015	03/08/2016
LISN(EUT)	ROHDE&SCHWARZ	ENV216	101543-WX	03/09/2015	03/08/2016
LISN	EMCO	3825/2	8901-1459	03/09/2015	03/08/2016
Temp. / Humidity Meter	VICTOR	HTC-1	N/A	03/04/2015	03/03/2016
Test S/W	FARAD	EZ-EMC/ CCS-3A1-CE			

8. RADIATED EMISSION

8.1 TEST LIMIT

Standard FCC15.249

Fundamental Frequency	Field Strength of Fundamental (millivolts/meter)	Field Strength of Harmonics (microvolts/meter)
900-928MHz	50	500
2400-2483.5MHz	50	500
5725-5875MHz	50	500
24.0-24.25GHz	250	2500

Standard FCC 15.209

Frequency (MHz)	Distance Meters	Field Strengths Limit	
		μ V/m	dB(μ V)/m
0.009 ~ 0.490	300	2400/F(kHz)	---
0.490 ~ 1.705	30	24000/F(kHz)	---
1.705 ~ 30	30	30	---
30 ~ 88	3	100	40.0
88 ~ 216	3	150	43.5
216 ~ 960	3	200	46.0
960 ~ 1000	3	500	54.0
Above 1000	3	Other:74.0 dB(μ V)/m (Peak) 54.0 dB(μ V)/m (Average)	

Remark: (1) Emission level dB μ V = 20 log Emission level μ V/m
(2) The smaller limit shall apply at the cross point between two frequency bands.
(3) Distance is the distance in meters between the measuring instrument, antenna and the closest point of any part of the device or system.

8.2. MEASUREMENT PROCEDURE

1. Configure the EUT according to ANSI C63.4. The EUT was placed on the top of the turntable 0.8 meter above ground. The phase center of the receiving antenna mounted on the top of a height-variable antenna tower was placed 3 meters far away from the turntable.
2. Power on the EUT and all the supporting units. The turntable was rotated by 360 degrees to determine the position of the highest radiation.
3. The height of the broadband receiving antenna was varied between one meter and four meters above ground to find the maximum emissions field strength of both horizontal and vertical polarization.
4. For each suspected emissions, the antenna tower was scan (from 1 M to 4 M) and then the turntable was rotated (from 0 degree to 360 degrees) to find the maximum reading.
5. Set the test-receiver system to Peak or CISPR quasi-peak Detect Function with specified bandwidth under Maximum Hold Mode.
6. For emissions above 1GHz, use 1.5MHz VBW and RBW for peak reading. Then 1.5MHz RBW and 10Hz VBW for average reading in spectrum analyzer.
7. When the radiated emissions limits are expressed in terms of the average value of the emissions, and pulsed operation is employed, the measurement field strength shall be determined by averaging over one complete pulse train, including blanking intervals, as long as the pulse train does not exceed 0.1 seconds. As an alternative (provided the transmitter operates for longer than 0.1 seconds) or in cases where the pulse train exceeds 0.1 seconds, the measured field strength shall be determined from the average absolute voltage during a 0.1 second interval during which the field strength is at its maximum values.
8. If the emissions level of the EUT in peak mode was 3 dB lower than the average limit specified, then testing will be stopped and peak values of EUT will be reported, otherwise, the emissions which do not have 3 dB margin will be repeated one by one using the quasi-peak method for below 1GHz.
9. For testing above 1GHz, the emissions level of the EUT in peak mode was lower than average limit (that means the emissions level in peak mode also complies with the limit in average mode), then testing will be stopped and peak values of EUT will be reported, otherwise, the emissions will be measured in average mode again and reported.
10. In case the emission is lower than 30MHz, loop antenna has to be used for measurement and the recorded data should be QP measured by receiver. High - Low scan is not required in this case.

The following table is the setting of spectrum analyzer and receiver.

Spectrum Parameter	Setting
Start ~Stop Frequency	9KHz~150KHz/RB 200Hz for QP
Start ~Stop Frequency	150KHz~30MHz/RB 9KHz for QP
Start ~Stop Frequency	30MHz~1000MHz/RB 120KHz for QP
Start ~Stop Frequency	1GHz~26.5GHz 1.5MHz/1.5MHz for Peak, 1.5MHz/10Hz for Average

Receiver Parameter	Setting
Start ~Stop Frequency	9KHz~150KHz/RB 200Hz for QP
Start ~Stop Frequency	150KHz~30MHz/RB 9KHz for QP
Start ~Stop Frequency	30MHz~1000MHz/RB 120KHz for QP

8.3. TEST SETUP

Radiated Emission Test-Setup Frequency Below 30MHz

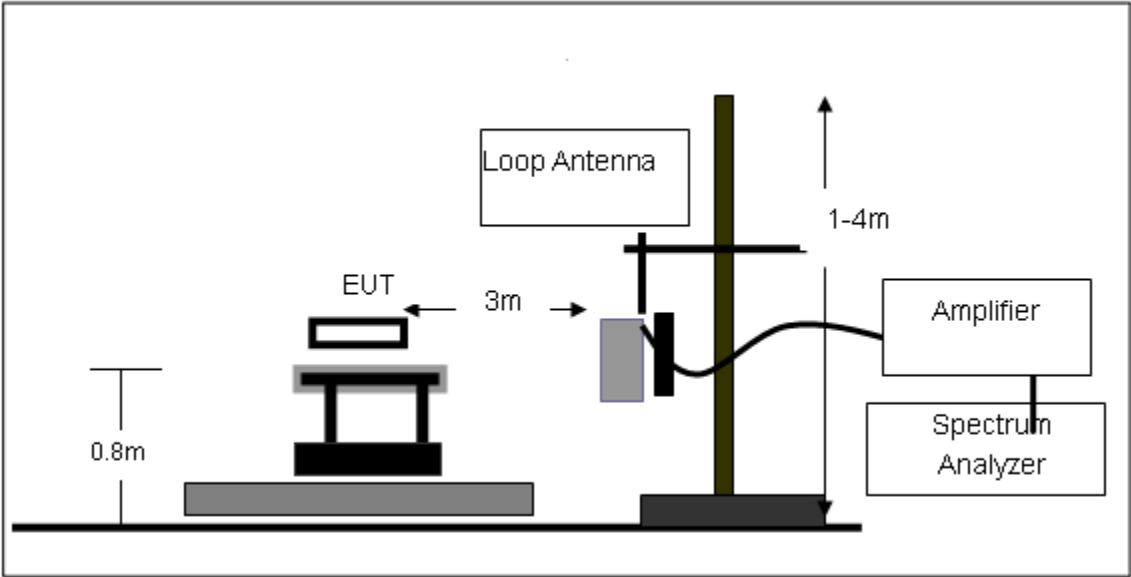

RADIATED EMISSION TEST SETUP 30MHz-1000MHz

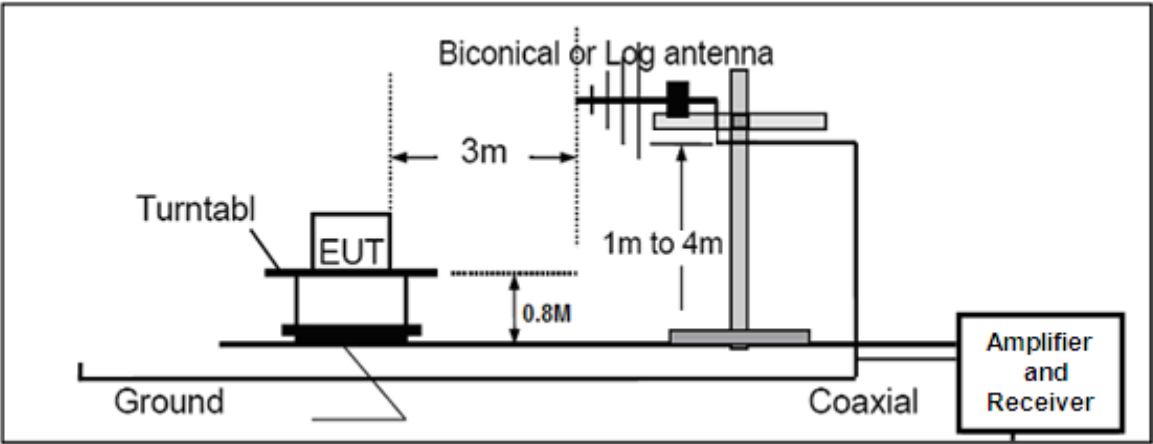

RADIATED EMISSION TEST SETUP ABOVE 1000MHz

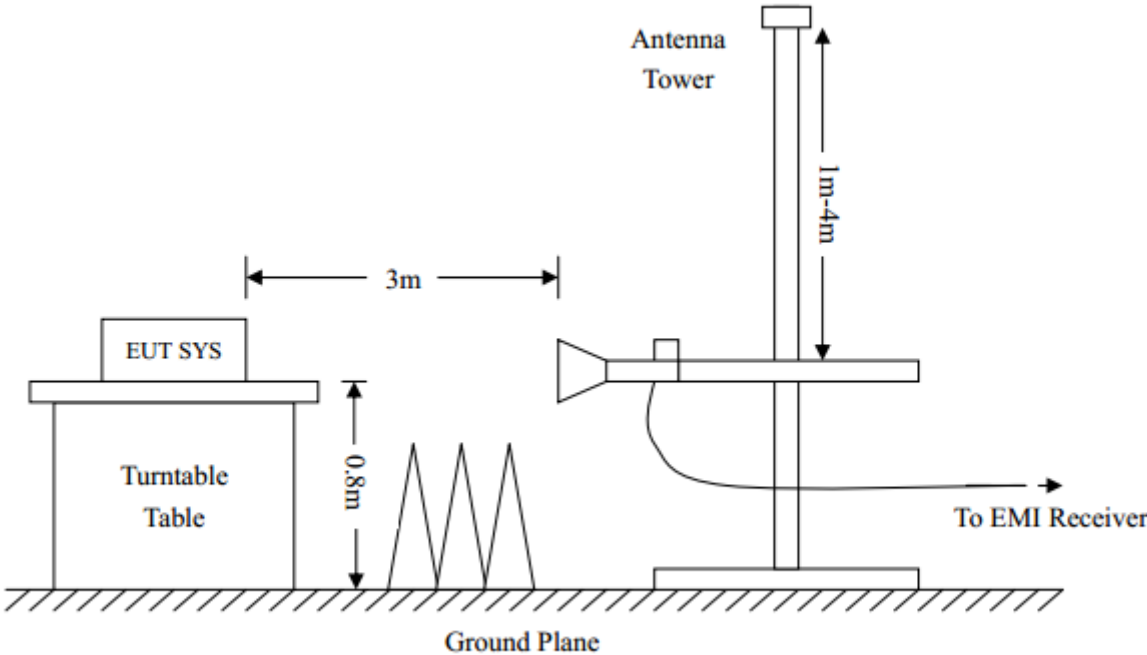

8.4. TEST RESULT

**(Worst modulation: GFSK)
 FOR BR/EDR BLUETOOTH**

RADIATED EMISSION BELOW 30MHZ

No emission found between lowest internal used/generated frequencies to 30MHz.

RADIATED EMISSION BELOW 1GHZ

RADIATED EMISSION TEST- (30MHZ-1GHZ)-LOW CHANNEL-HORIZONTAL

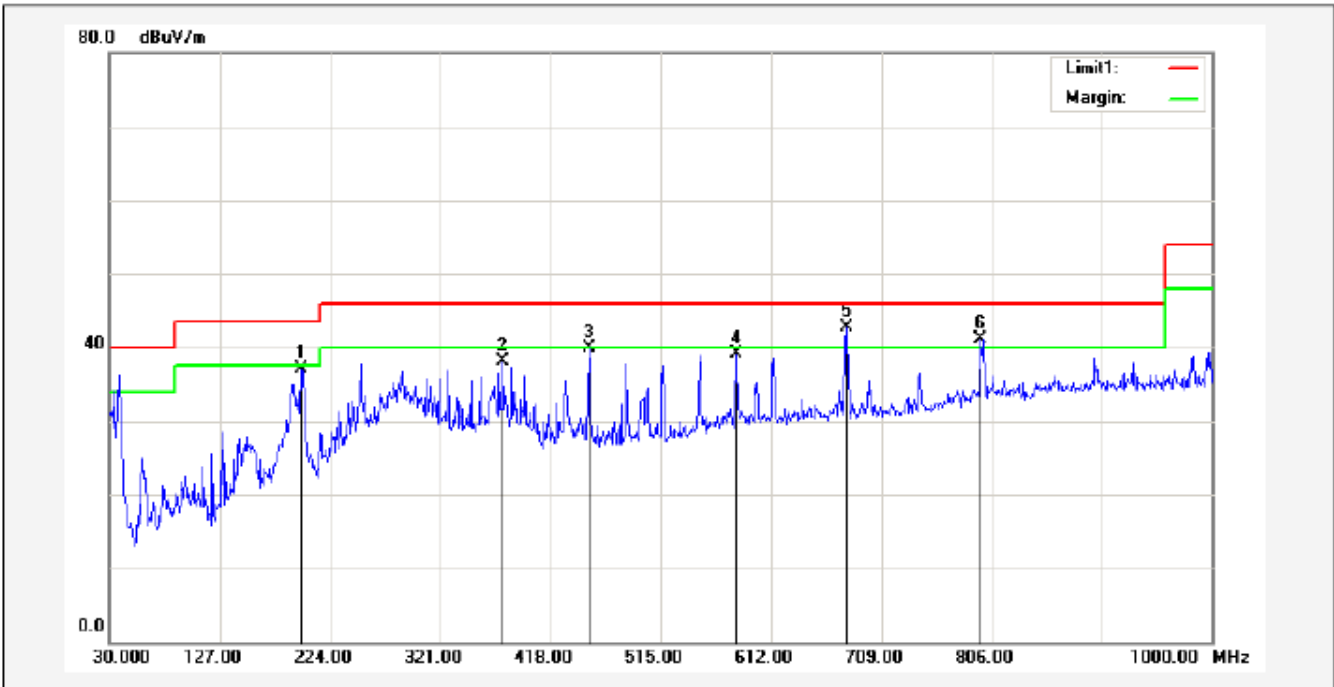

No.	Frequency (MHz)	Reading (dBuV)	Correction factor(dB/m)	Result (dBuV/m)	Limit (dBuV/m)	Margin (dB)	Degree (deg.)	Height (cm)	Remark
1	198.7800	52.02	-14.90	37.12	43.50	-6.38			peak
2	376.2900	47.06	-8.89	38.17	46.00	-7.83			peak
3	451.9500	47.07	-7.18	39.89	46.00	-6.11			peak
4	580.9600	41.91	-2.81	39.10	46.00	-6.90			peak
5*	677.9600	44.14	-1.42	42.72	46.00	-3.28			peak
6!	796.3000	39.98	1.15	41.13	46.00	-4.87			peak

RESULT: PASS

RADIATED EMISSION TEST- (30MHZ-1GHZ)-LOW CHANNEL -VERTICAL

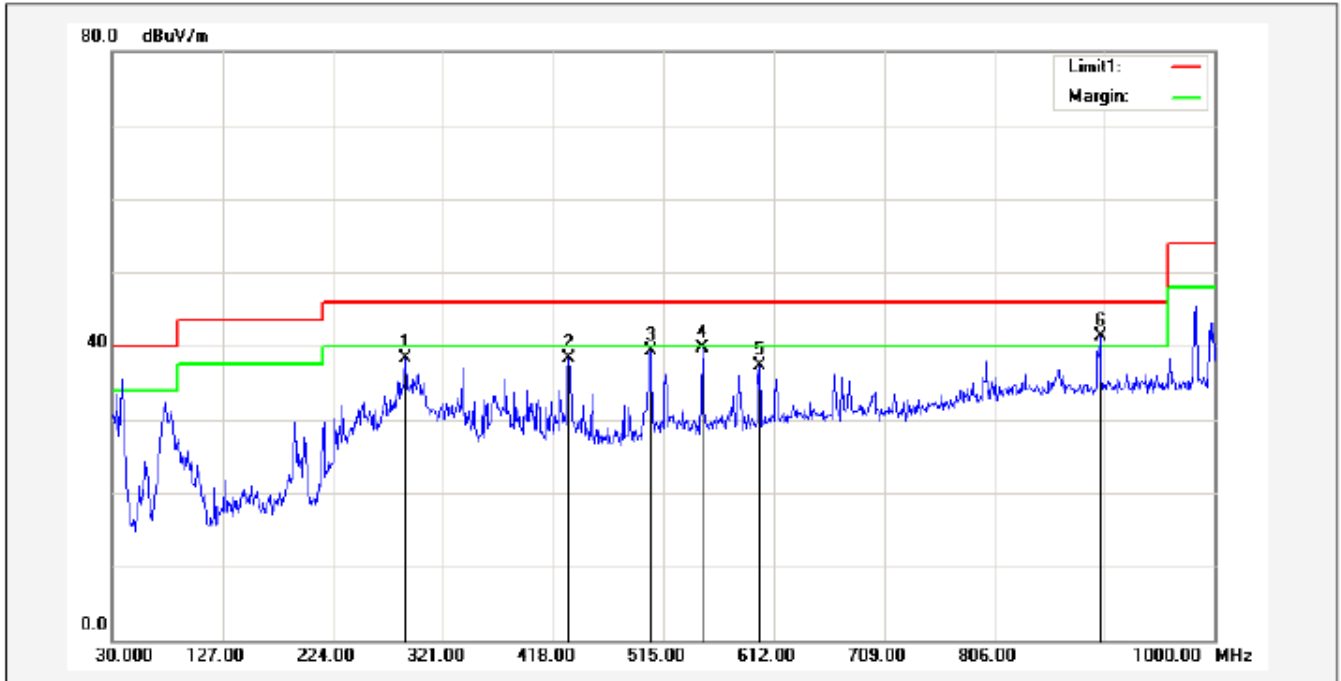

No.	Frequency (MHz)	Reading (dBuV)	Correction factor(dB/m)	Result (dBuV/m)	Limit (dBuV/m)	Margin (dB)	Degree (deg.)	Height (cm)	Remark
1	288.0200	50.51	-12.16	38.35	46.00	-7.65			peak
2	431.5800	45.63	-7.26	38.37	46.00	-7.63			peak
3	503.3600	44.50	-5.18	39.32	46.00	-6.68			peak
4	548.9500	43.05	-3.44	39.61	46.00	-6.39			peak
5	599.3900	39.67	-2.45	37.22	46.00	-8.78			peak
6*	899.1200	39.44	1.79	41.23	46.00	-4.77			peak

RESULT: PASS

Note: 1. Factor=Antenna Factor + Cable loss, Margin=Measurement-Limit.

2. The "Factor" value can be calculated automatically by software of measurement system.

RADIATED EMISSION TEST- (30MHZ-1GHZ)-MIDDLE CHANNEL-HORIZONTAL

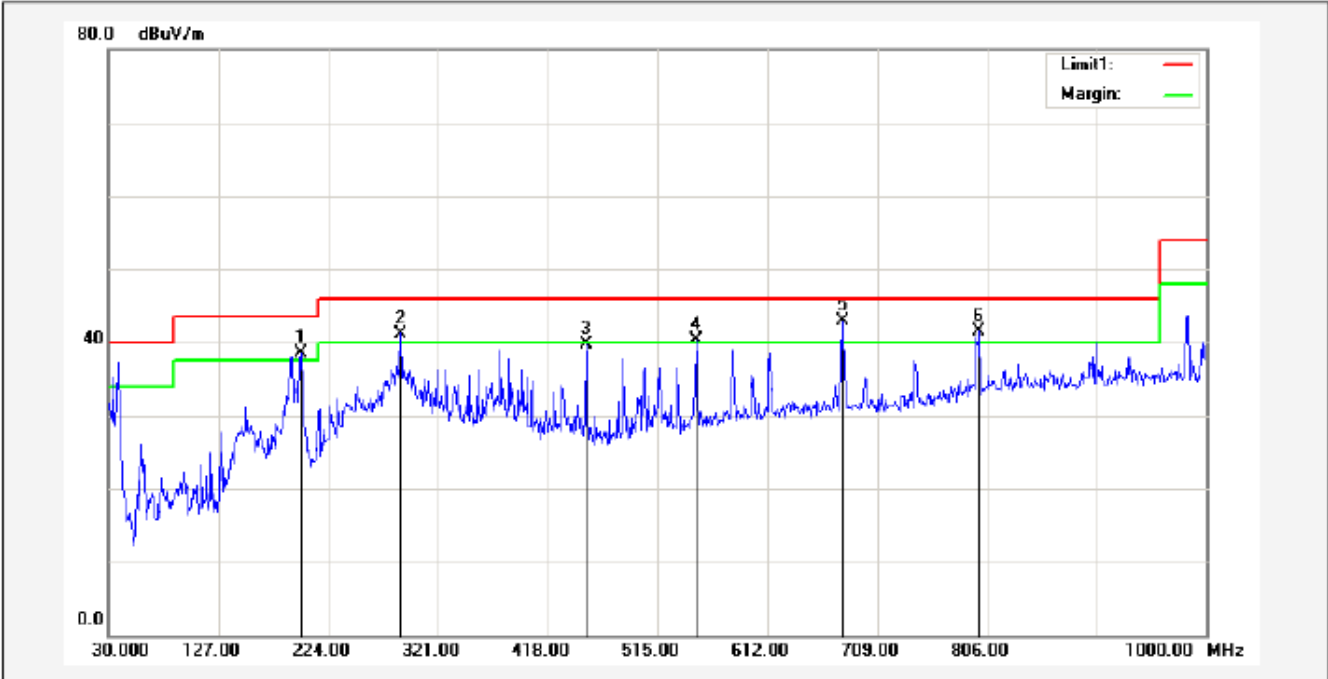

No.	Frequency (MHz)	Reading (dBuV)	Correction factor(dB/m)	Result (dBuV/m)	Limit (dBuV/m)	Margin (dB)	Degree (deg.)	Height (cm)	Remark
1!	199.7500	53.29	-14.82	38.47	43.50	-5.03			peak
2!	288.0200	53.36	-12.16	41.20	46.00	-4.80			peak
3	451.9500	46.97	-7.18	39.79	46.00	-6.21			peak
4!	548.9500	43.70	-3.44	40.26	46.00	-5.74			peak
5*	677.9600	44.24	-1.42	42.82	46.00	-3.18			peak
6!	799.2100	40.34	1.25	41.59	46.00	-4.41			peak

RESULT: PASS

RADIATED EMISSION TEST- (30MHZ-1GHZ)- MIDDLE CHANNEL -VERTICAL

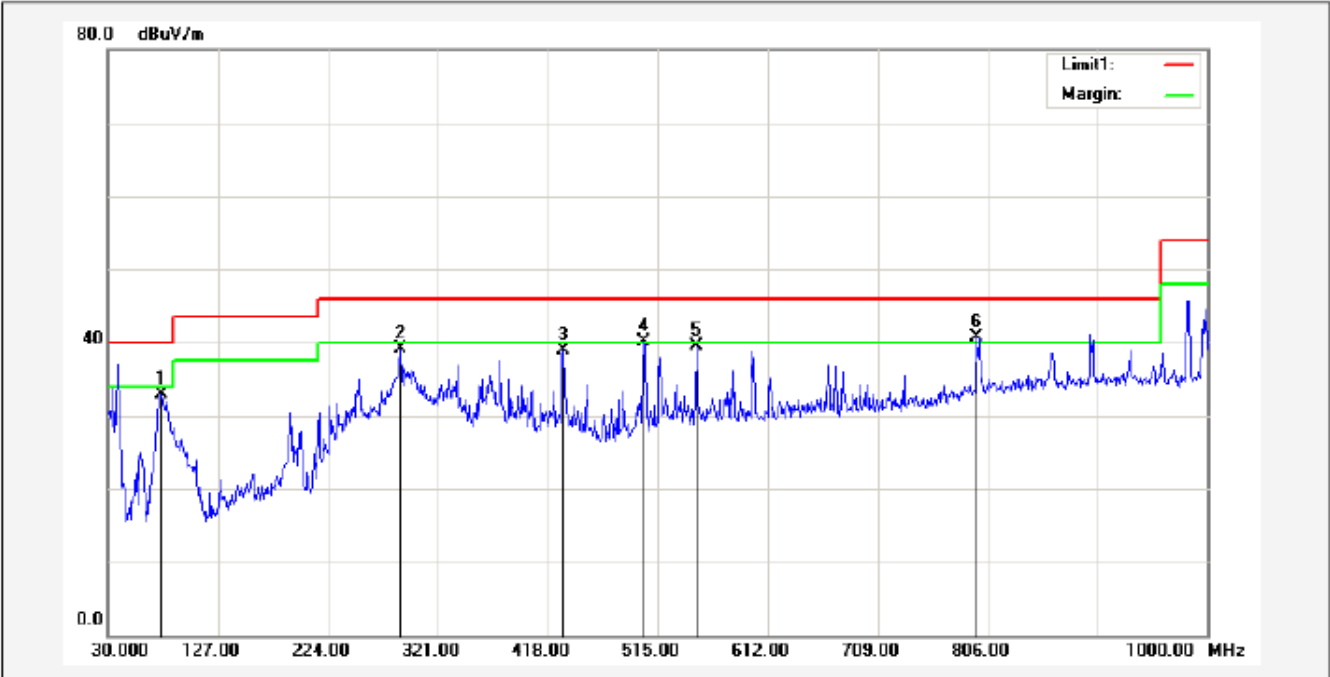

No.	Frequency (MHz)	Reading (dBuV)	Correction factor(dB/m)	Result (dBuV/m)	Limit (dBuV/m)	Margin (dB)	Degree (deg.)	Height (cm)	Remark
1	77.5300	50.20	-17.22	32.98	40.00	-7.02			peak
2	288.0200	51.32	-12.16	39.16	46.00	-6.84			peak
3	431.5800	46.23	-7.26	38.97	46.00	-7.03			peak
4!	502.3900	45.24	-5.18	40.06	46.00	-5.94			peak
5	548.9500	42.88	-3.44	39.44	46.00	-6.56			peak
6*	796.3000	39.61	1.15	40.76	46.00	-5.24			peak

RESULT: PASS

Note: 1. Factor=Antenna Factor + Cable loss, Margin=Measurement-Limit.

2. The "Factor" value can be calculated automatically by software of measurement system.

RADIATED EMISSION TEST- (30MHZ-1GHZ)-HIGH CHANNEL-HORIZONTAL

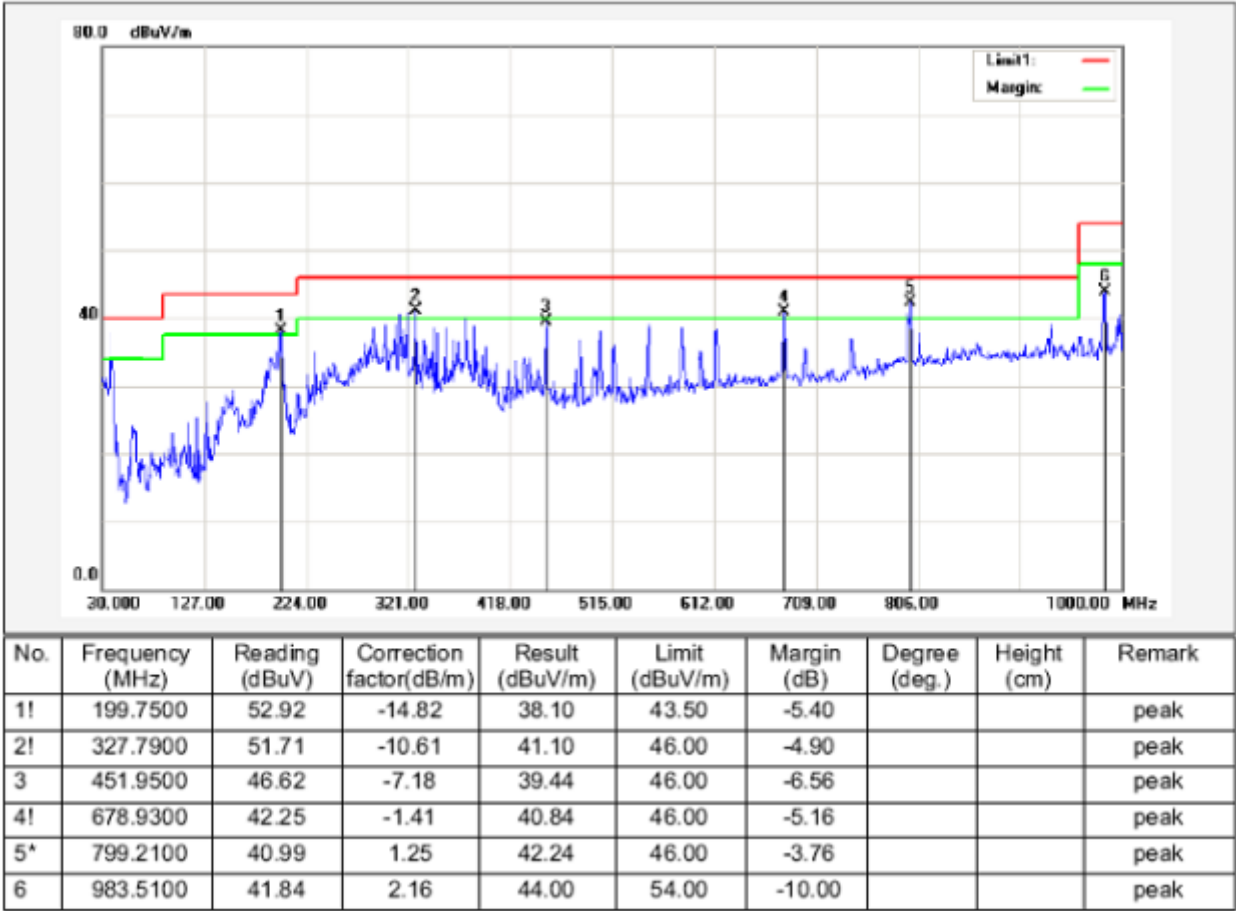

RESULT: PASS

RADIATED EMISSION TEST- (30MHZ-1GHZ)-HIGH CHANNEL -VERTICAL

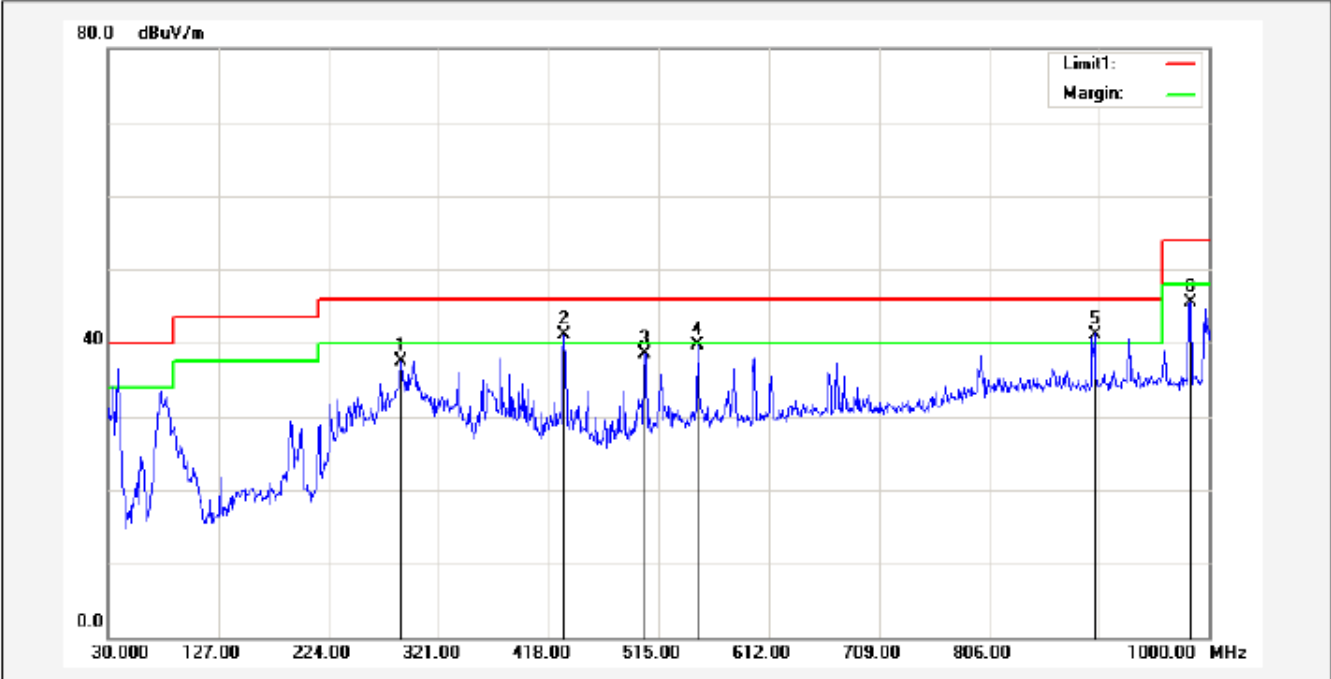

No.	Frequency (MHz)	Reading (dBuV)	Correction factor(dB/m)	Result (dBuV/m)	Limit (dBuV/m)	Margin (dB)	Degree (deg.)	Height (cm)	Remark
1	288.0200	49.69	-12.16	37.53	46.00	-8.47			peak
2!	431.5800	48.28	-7.26	41.02	46.00	-4.98			peak
3	502.3900	43.69	-5.18	38.51	46.00	-7.49			peak
4	548.9500	43.05	-3.44	39.61	46.00	-6.39			peak
5*	899.1200	39.41	1.79	41.20	46.00	-4.80			peak
6	983.5100	43.28	2.16	45.44	54.00	-8.56			peak

RESULT: PASS

- Note:** 1. Factor=Antenna Factor + Cable loss, Margin=Measurement-Limit.
 2. The “Factor” value can be calculated automatically by software of measurement system.

FOR BLE

RADIATED EMISSION BELOW 30MHZ

No emission found between lowest internal used/generated frequencies to 30MHz.

RADIATED EMISSION BELOW 1GHZ

RADIATED EMISSION TEST- (30MHZ-1GHZ)-LOW CHANNEL-HORIZONTAL

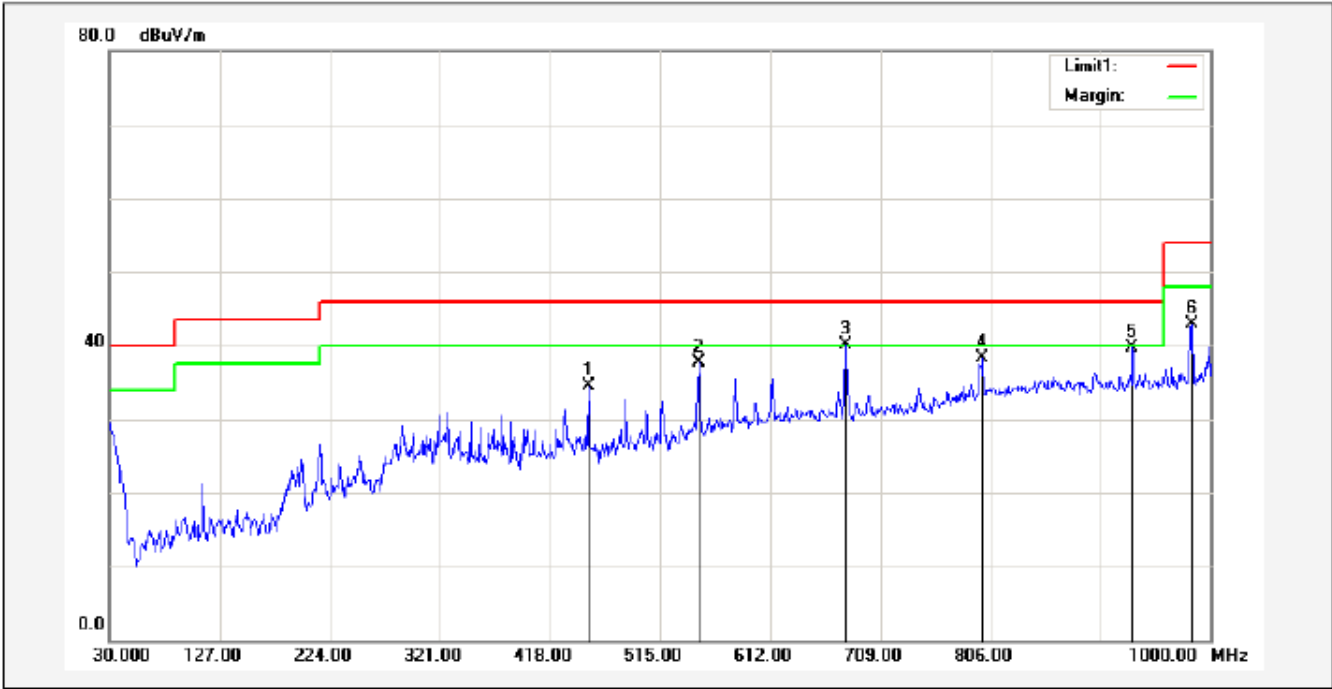

No.	Frequency (MHz)	Reading (dBuV)	Correction factor(dB/m)	Result (dBuV/m)	Limit (dBuV/m)	Margin (dB)	Degree (deg.)	Height (cm)	Remark
1	451.9500	41.71	-7.18	34.53	46.00	-11.47			peak
2	548.9500	41.09	-3.44	37.65	46.00	-8.35			peak
3*	677.9600	41.44	-1.42	40.02	46.00	-5.98			peak
4	799.2100	37.08	1.25	38.33	46.00	-7.67			peak
5	931.1300	37.71	1.93	39.64	46.00	-6.36			peak
6	983.5100	40.81	2.16	42.97	54.00	-11.03			peak

RESULT: PASS

RADIATED EMISSION TEST- (30MHZ-1GHZ)-LOW CHANNEL -VERTICAL

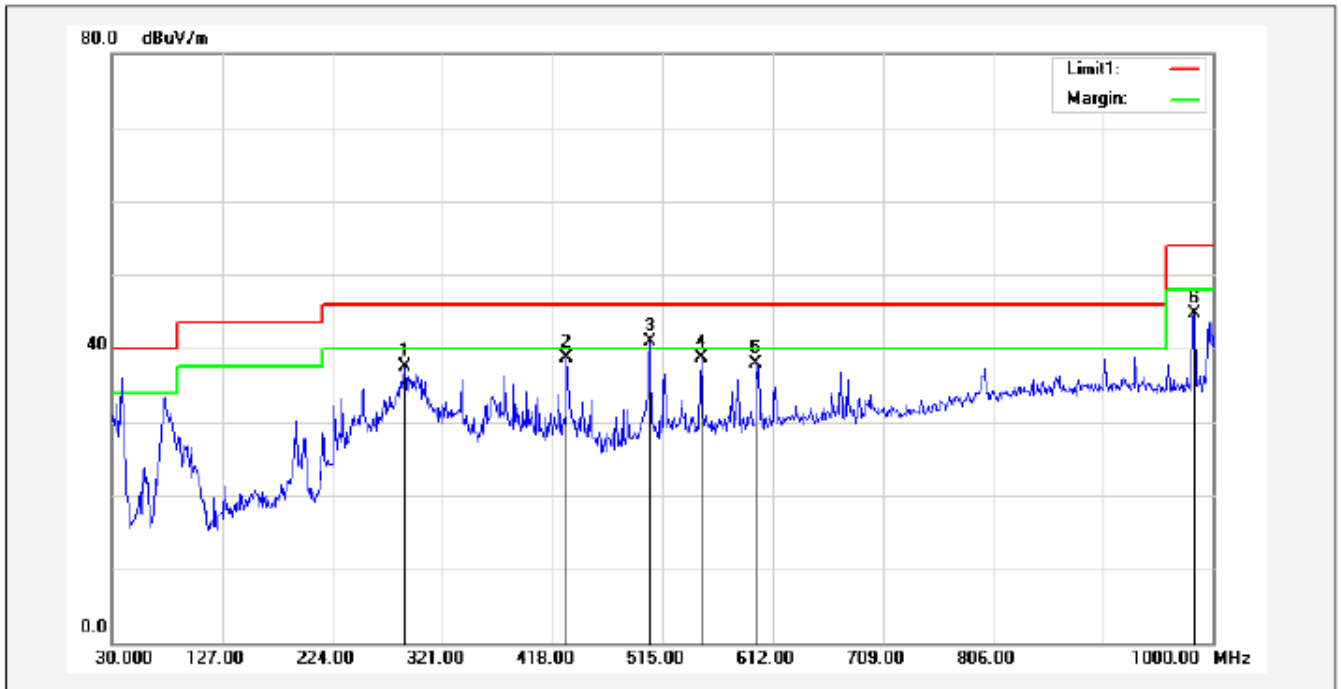

No.	Frequency (MHz)	Reading (dBuV)	Correction factor(dB/m)	Result (dBuV/m)	Limit (dBuV/m)	Margin (dB)	Degree (deg.)	Height (cm)	Remark
1	288.0200	49.59	-12.16	37.43	46.00	-8.57			peak
2	430.6100	46.04	-7.26	38.78	46.00	-7.22			peak
3*	503.3600	45.99	-5.18	40.81	46.00	-5.19			peak
4	548.9500	42.12	-3.44	38.68	46.00	-7.32			peak
5	597.4500	40.35	-2.48	37.87	46.00	-8.13			peak
6	983.5100	42.62	2.16	44.78	54.00	-9.22			peak

RESULT: PASS

Note: 1. Factor=Antenna Factor + Cable loss, Margin=Measurement-Limit.

2. The "Factor" value can be calculated automatically by software of measurement system.

RADIATED EMISSION TEST- (30MHZ-1GHZ)-MIDDLE CHANNEL-HORIZONTAL

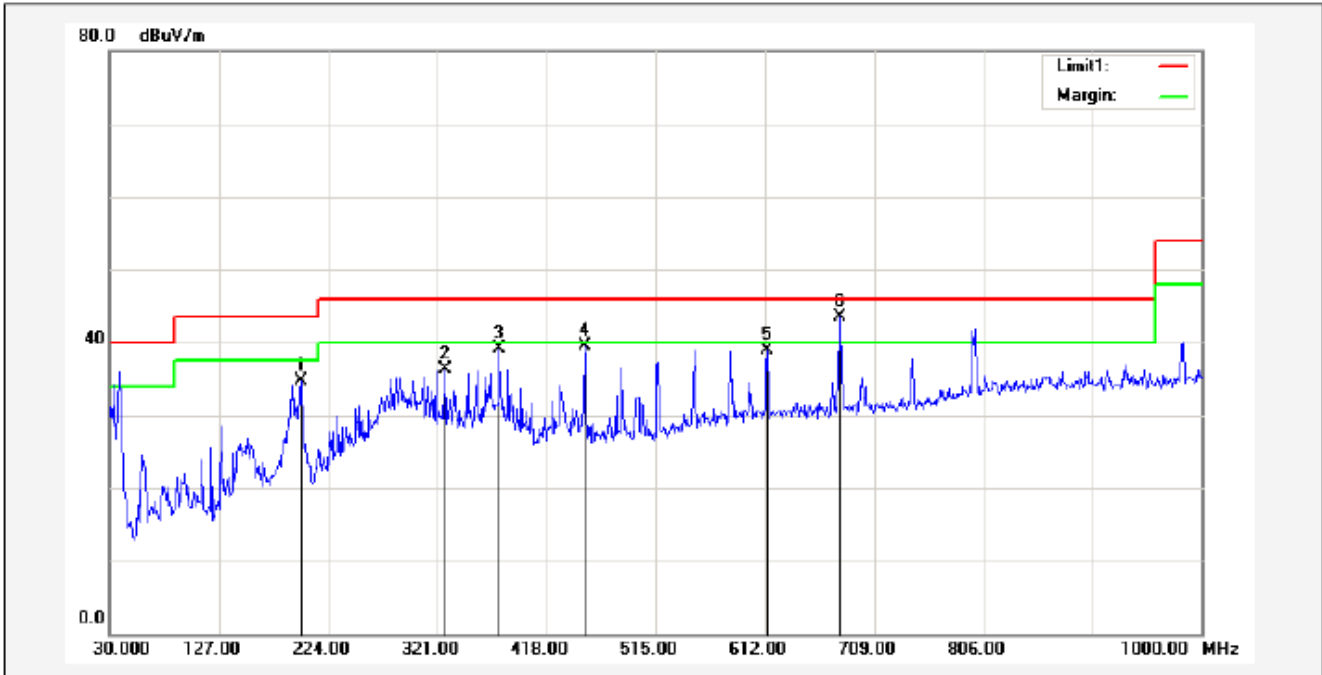

No.	Frequency (MHz)	Reading (dBuV)	Correction factor(dB/m)	Result (dBuV/m)	Limit (dBuV/m)	Margin (dB)	Degree (deg.)	Height (cm)	Remark
1	199.7500	49.43	-14.82	34.61	43.50	-8.89			peak
2	327.7900	46.85	-10.61	36.24	46.00	-9.76			peak
3	376.2900	47.92	-8.89	39.03	46.00	-6.97			peak
4	451.9500	46.67	-7.18	39.49	46.00	-6.51			peak
5	613.9400	41.12	-2.16	38.96	46.00	-7.04			peak
6*	678.9300	44.92	-1.41	43.51	46.00	-2.49			peak

RESULT: PASS

RADIATED EMISSION TEST- (30MHZ-1GHZ)- MIDDLE CHANNEL -VERTICAL

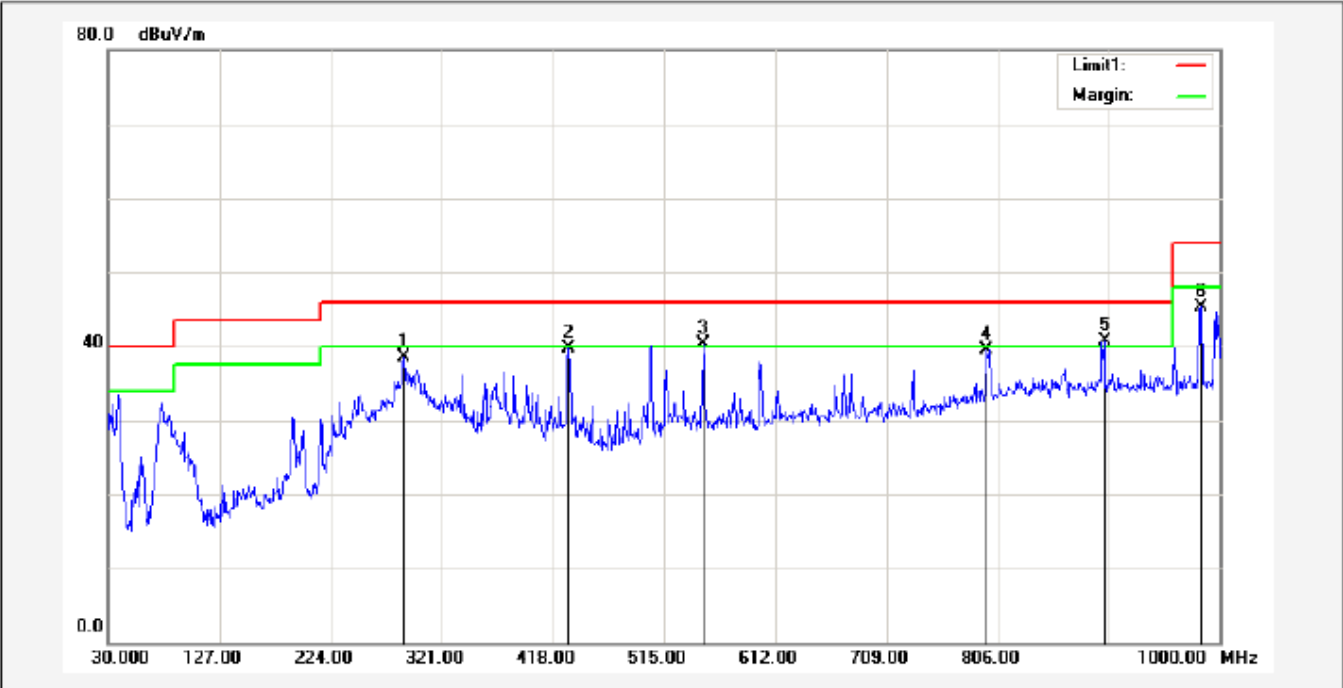

No.	Frequency (MHz)	Reading (dBuV)	Correction factor(dB/m)	Result (dBuV/m)	Limit (dBuV/m)	Margin (dB)	Degree (deg.)	Height (cm)	Remark
1	288.0200	50.66	-12.16	38.50	46.00	-7.50			peak
2	431.5800	47.00	-7.26	39.74	46.00	-6.26			peak
3!	548.9500	43.84	-3.44	40.40	46.00	-5.60			peak
4	796.3000	38.44	1.15	39.59	46.00	-6.41			peak
5*	899.1200	38.89	1.79	40.68	46.00	-5.32			peak
6	983.5100	43.13	2.16	45.29	54.00	-8.71			peak

RESULT: PASS

Note: 1. Factor=Antenna Factor + Cable loss, Margin=Measurement-Limit.

2. The "Factor" value can be calculated automatically by software of measurement system.

RADIATED EMISSION TEST- (30MHZ-1GHZ)-HIGH CHANNEL-HORIZONTAL

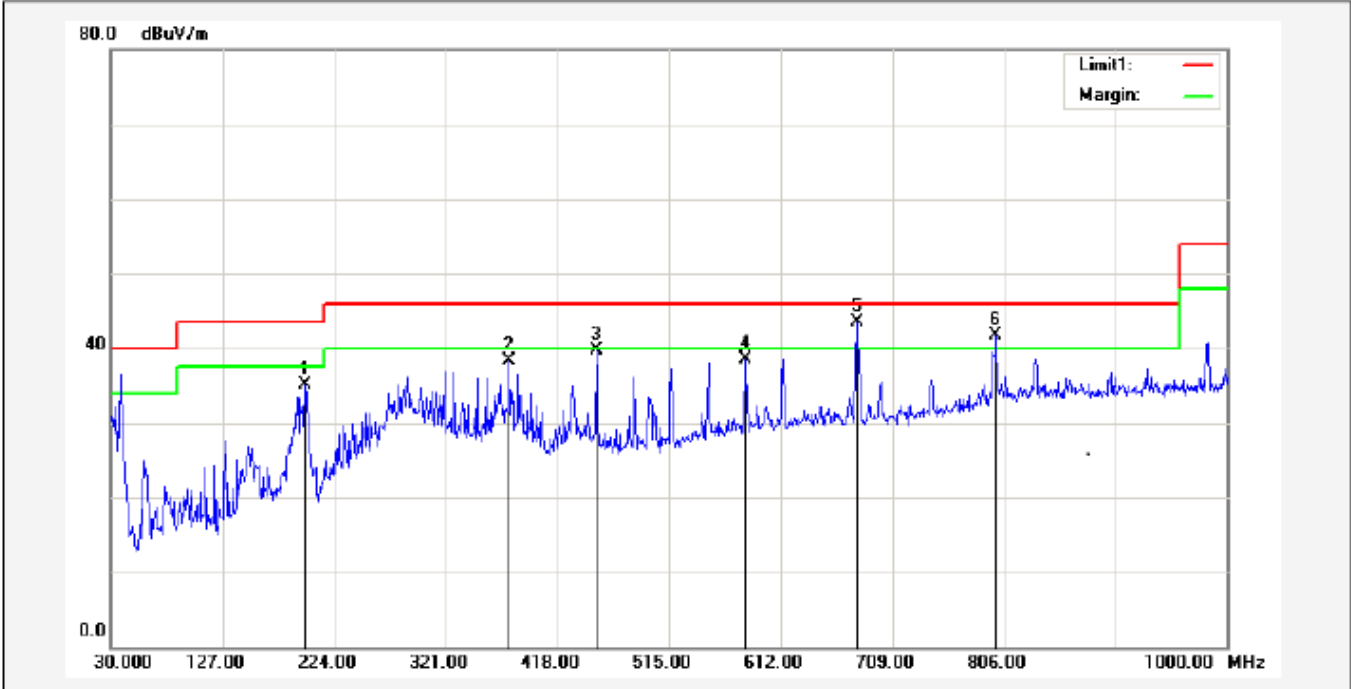

No.	Frequency (MHz)	Reading (dBuV)	Correction factor(dB/m)	Result (dBuV/m)	Limit (dBuV/m)	Margin (dB)	Degree (deg.)	Height (cm)	Remark
1	198.7800	49.95	-14.90	35.05	43.50	-8.45			peak
2	376.2900	47.27	-8.89	38.38	46.00	-7.62			peak
3	451.9500	46.83	-7.18	39.65	46.00	-6.35			peak
4	580.9600	41.22	-2.81	38.41	46.00	-7.59			peak
5*	677.9600	44.98	-1.42	43.56	46.00	-2.44			peak
6!	799.2100	40.40	1.25	41.65	46.00	-4.35			peak

RESULT: PASS

RADIATED EMISSION TEST- (30MHZ-1GHZ)-HIGH CHANNEL -VERTICAL

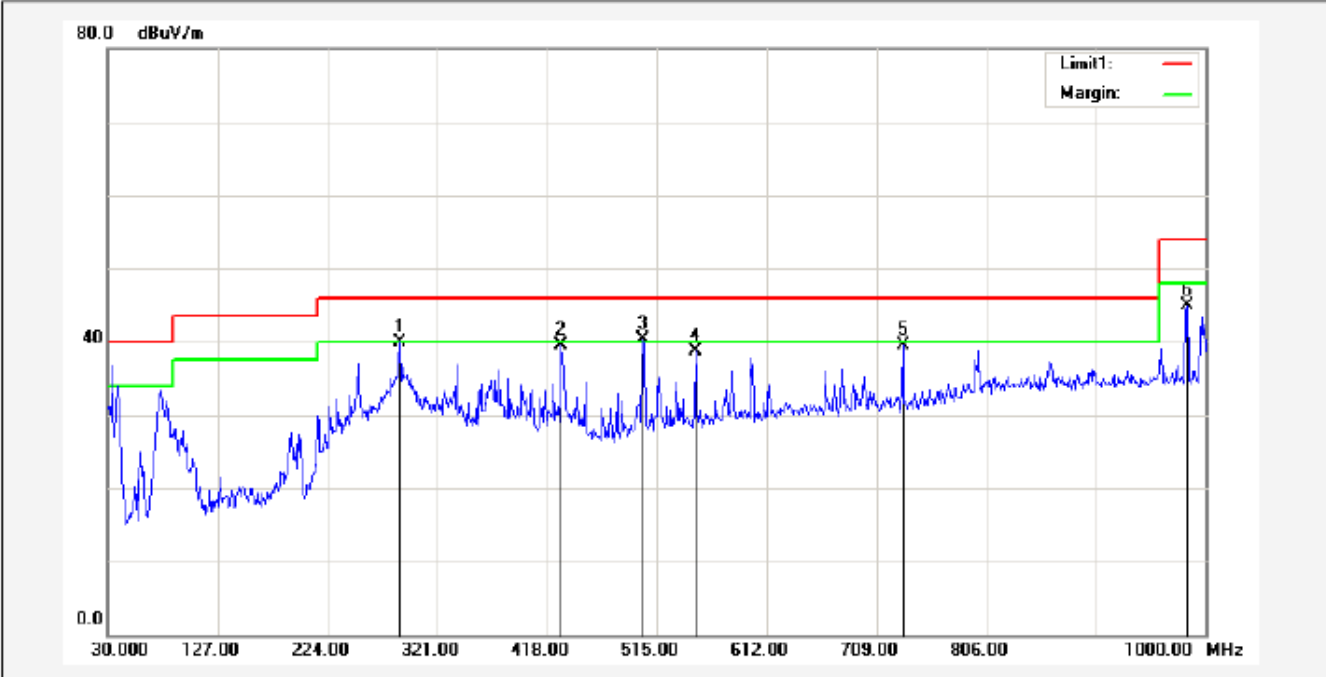

No.	Frequency (MHz)	Reading (dBuV)	Correction factor(dB/m)	Result (dBuV/m)	Limit (dBuV/m)	Margin (dB)	Degree (deg.)	Height (cm)	Remark
1	288.0200	52.15	-12.16	39.99	46.00	-6.01			peak
2	430.6100	46.70	-7.26	39.44	46.00	-6.56			peak
3*	502.3900	45.53	-5.18	40.35	46.00	-5.65			peak
4	548.9500	42.09	-3.44	38.65	46.00	-7.35			peak
5	732.2800	40.27	-0.73	39.54	46.00	-6.46			peak
6	983.5100	42.70	2.16	44.86	54.00	-9.14			peak

RESULT: PASS

- Note:** 1. Factor=Antenna Factor + Cable loss, Margin=Measurement-Limit.
 2. The “Factor” value can be calculated automatically by software of measurement system.

**RADIATED EMISSION ABOVE 1GHZ
 FOR BR/EDR BLUETOOTH**

RADIATED EMISSION TEST- (ABOVE 1GHZ)-LOW CHANNEL-HORIZONTAL

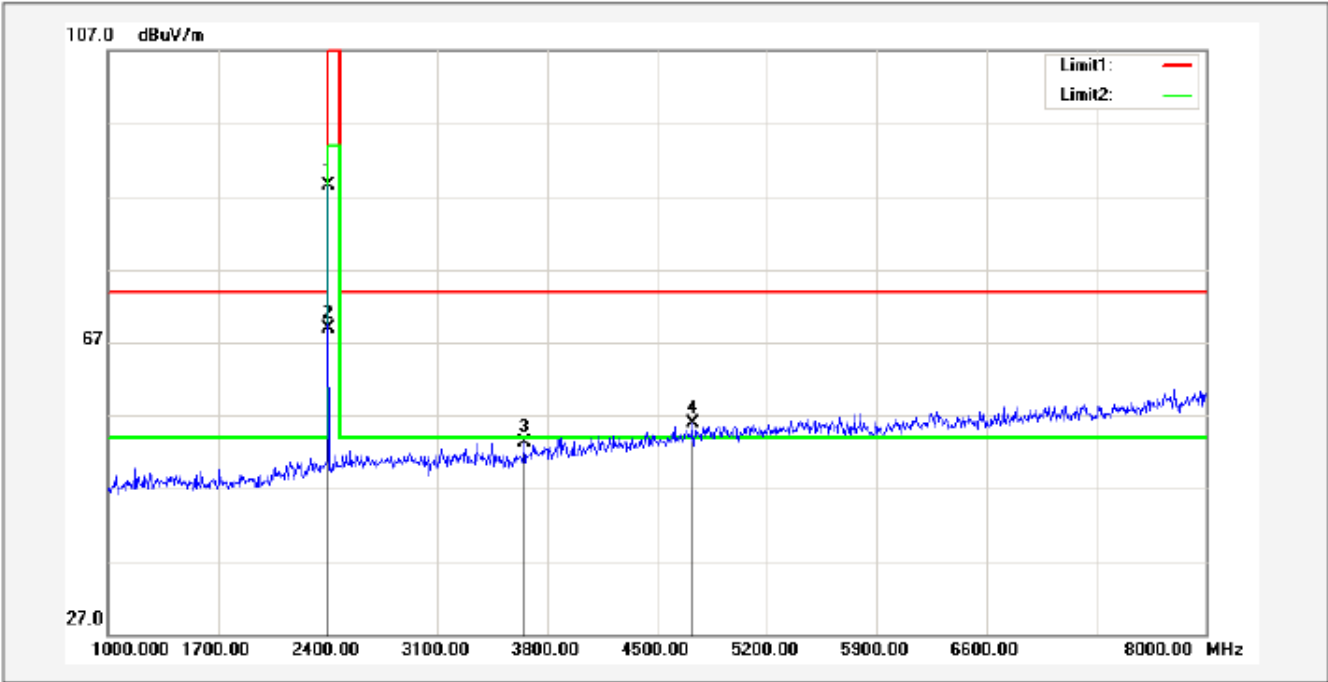

No.	Frequency (MHz)	Reading (dBuV)	Correction factor(dB/m)	Result (dBuV/m)	Limit (dBuV/m)	Margin (dB)	Degree (deg.)	Height (cm)	Remark
1X	2402.000	91.37	-2.81	88.56	114.00	-25.44			peak
2*	2402.000	71.71	-2.81	68.90	94.00	-25.10			AVG
3	3653.000	53.10	0.13	53.23	74.00	-20.77			peak
4	4724.000	51.88	4.08	55.96	74.00	-18.04			peak

RESULT: PASS

RADIATED EMISSION TEST- (ABOVE 1GHZ)-LOW CHANNEL- VERTICAL

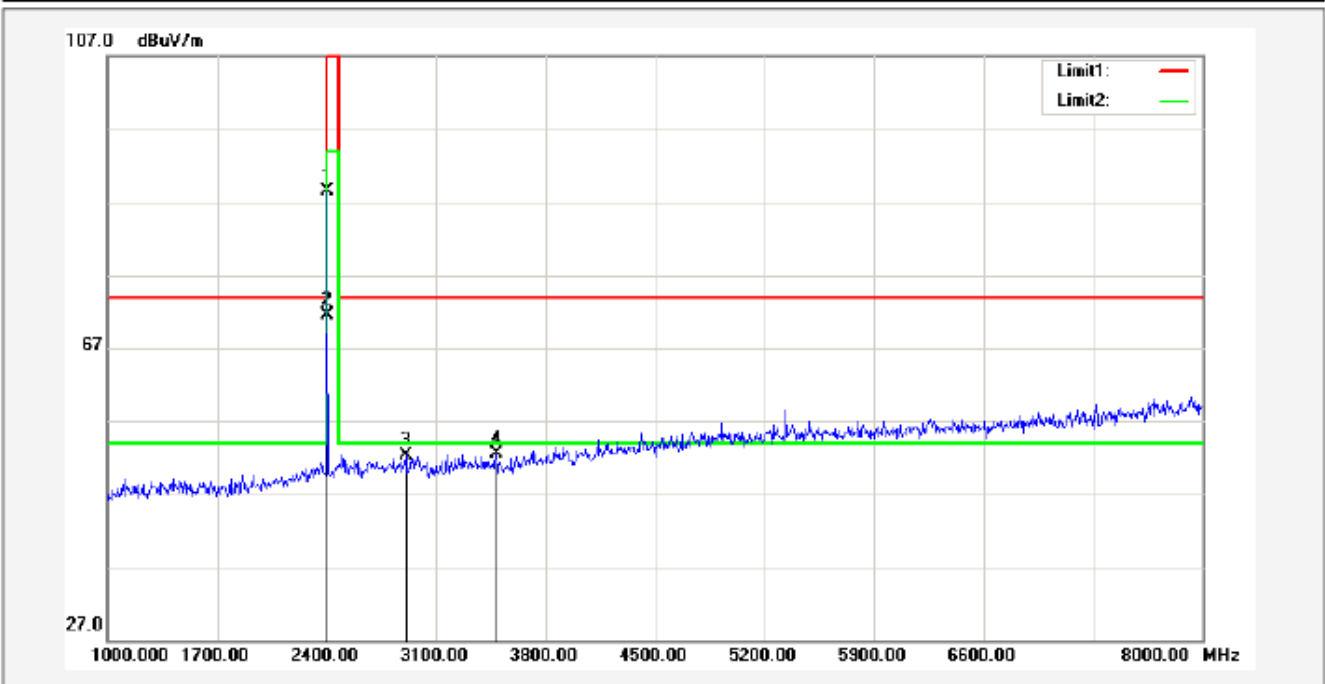

No.	Frequency (MHz)	Reading (dBuV)	Correction factor(dB/m)	Result (dBuV/m)	Limit (dBuV/m)	Margin (dB)	Degree (deg.)	Height (cm)	Remark
1X	2402.000	91.28	-2.81	88.47	114.00	-25.53			peak
2*	2402.000	74.21	-2.81	71.40	94.00	-22.60			AVG
3	2904.000	53.88	-1.53	52.35	74.00	-21.65			peak
4	3485.000	52.98	-0.55	52.43	74.00	-21.57			peak

RESULT: PASS

RADIATED EMISSION TEST- (ABOVE 1GHZ)-MIDDLE CHANNEL-HORIZONTAL

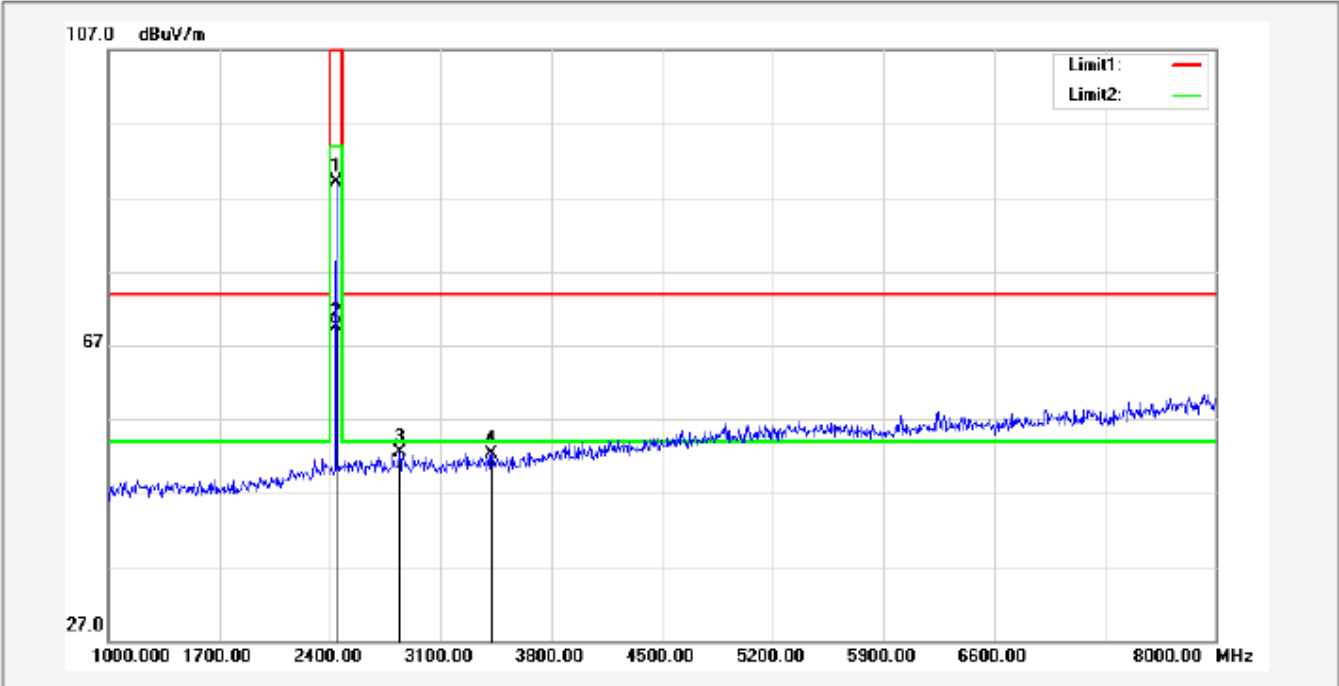

No.	Frequency (MHz)	Reading (dBuV)	Correction factor(dB/m)	Result (dBuV/m)	Limit (dBuV/m)	Margin (dB)	Degree (deg.)	Height (cm)	Remark
1	2441.000	91.62	-2.58	89.04	114.00	-24.96			peak
2	2441.000	72.08	-2.58	69.50	94.00	-24.50			AVG
3*	2841.000	54.16	-1.65	52.51	74.00	-21.49			peak
4	3422.000	52.87	-0.65	52.22	74.00	-21.78			peak

RESULT: PASS

RADIATED EMISSION TEST- (ABOVE 1GHZ)-MIDDLE CHANNEL- VERTICAL

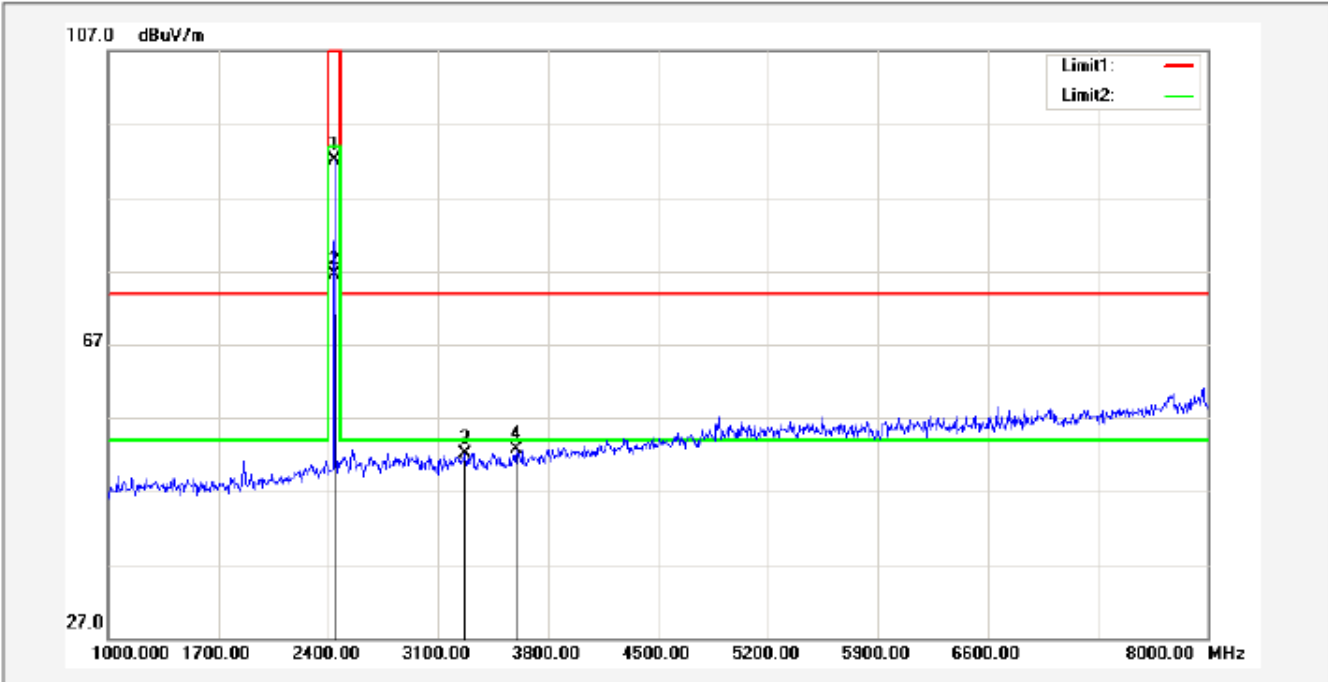

No.	Frequency (MHz)	Reading (dBuV)	Correction factor(dB/m)	Result (dBuV/m)	Limit (dBuV/m)	Margin (dB)	Degree (deg.)	Height (cm)	Remark
1	2441.000	94.74	-2.58	92.16	114.00	-21.84			peak
2*	2441.000	79.08	-2.58	76.50	94.00	-17.50			AVG
3	3268.000	53.11	-0.91	52.20	74.00	-21.80			peak
4	3597.000	52.77	-0.11	52.66	74.00	-21.34			peak

RESULT: PASS

RADIATED EMISSION TEST- (ABOVE 1GHZ)-HIGH CHANNEL-HORIZONTAL

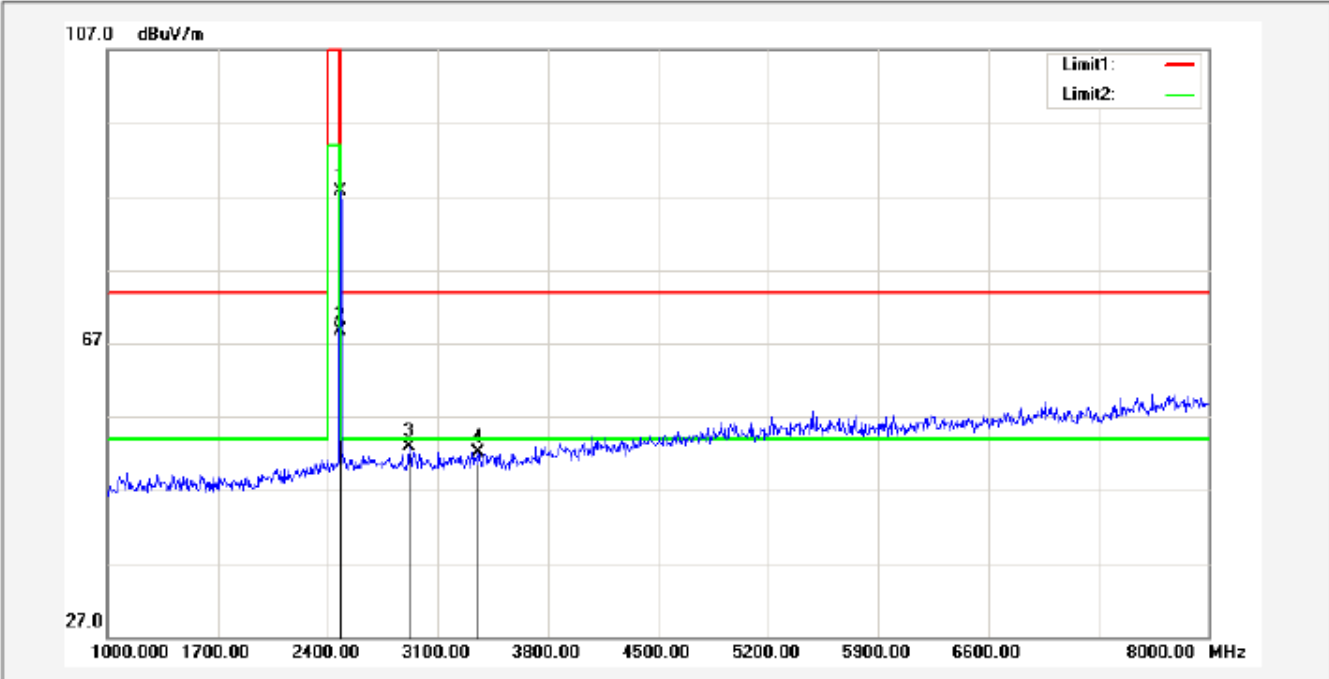

No.	Frequency (MHz)	Reading (dBuV)	Correction factor(dB/m)	Result (dBuV/m)	Limit (dBuV/m)	Margin (dB)	Degree (deg.)	Height (cm)	Remark
1	2480.000	90.03	-2.39	87.64	114.00	-26.36			peak
2	2480.000	71.09	-2.39	68.70	94.00	-25.30			AVG
3*	2918.000	54.35	-1.51	52.84	74.00	-21.16			peak
4	3352.000	52.82	-0.77	52.05	74.00	-21.95			peak

RESULT: PASS

RADIATED EMISSION TEST- (ABOVE 1GHZ)-HIGH CHANNEL- VERTICAL

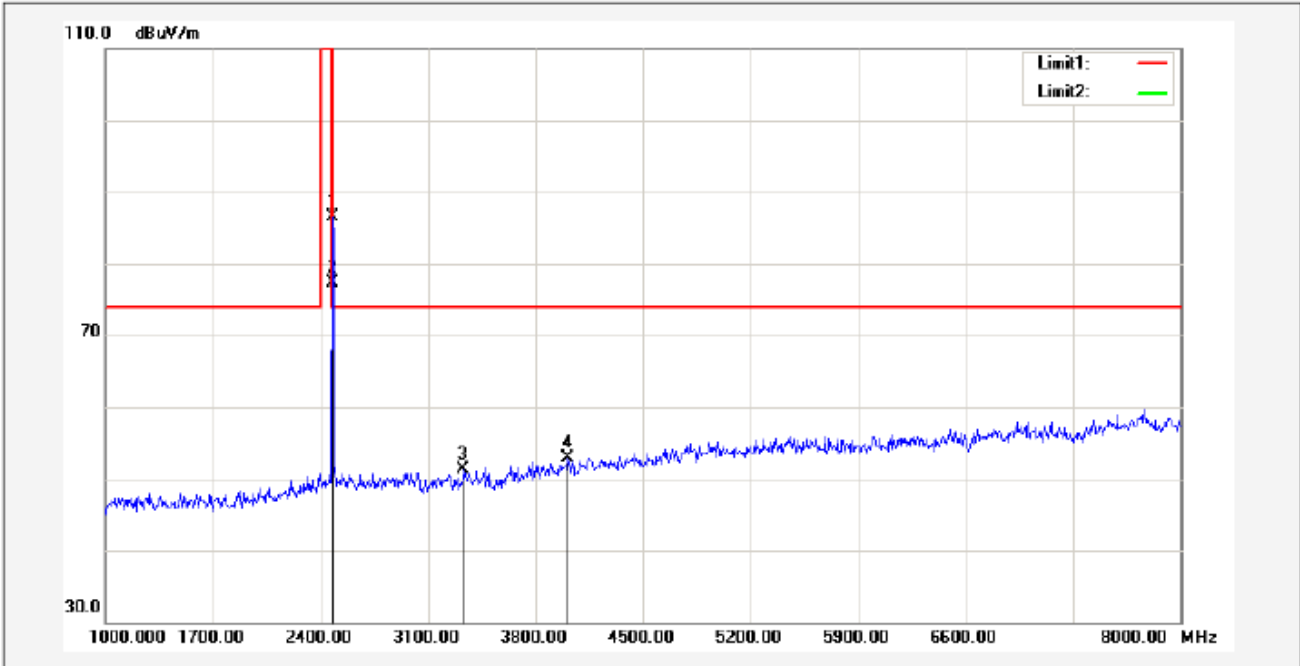

No.	Frequency (MHz)	Reading (dBuV)	Correction factor(dB/m)	Result (dBuV/m)	Limit (dBuV/m)	Margin (dB)	Degree (deg.)	Height (cm)	Remark
1	2480.000	88.97	-2.39	87.77	114.00	-26.23			peak
2*	2480.000	79.69	-2.39	69.02	94.00	-24.98			AVG
3	3331.000	52.12	-0.80	51.32	74.00	-22.68			peak
4	4010.000	51.30	1.63	52.93	74.00	-21.07			peak

RESULT: PASS

Note: 6~25GHz at least have 20dB margin. No recording in the test report.
 Factor=Antenna Factor + Cable loss - Amplifier gain, Margin=Measurement-Limit.
 The "Factor" value can be calculated automatically by software of measurement system.

Field strength of the fundamental signal**Peak value**

Frequency	Reading Level	Factor	Measurement	Limit	Over	Antenna
(MHz)	(dBuv)	(dB/m)	(dBuv/m)	(dBuv/m)	(dB)	Polarization
2402	91.37	-2.81	88.56	114	-25.44	Horizontal
2402	91.28	-2.81	88.47	114	-25.53	Vertical
2441	91.62	-2.58	89.04	114	-24.96	Horizontal
2441	94.74	-2.58	92.16	114	-21.84	Vertical
2480	90.03	-2.39	87.64	114	-26.36	Horizontal
2480	88.97	-2.39	87.77	114	-26.23	Vertical

Average value

Frequency	Reading Level	Factor	Measurement	Limit	Over	Antenna
(MHz)	(dBuv)	(dB/m)	(dBuv/m)	(dBuv/m)	(dB)	Polarization
2402	71.71	-2.81	68.90	94	-25.10	Horizontal
2402	74.21	-2.81	71.40	94	-22.60	Vertical
2441	72.08	-2.58	69.50	94	-24.50	Horizontal
2441	79.08	-2.58	76.50	94	-17.50	Vertical
2480	71.09	-2.39	68.70	94	-25.30	Horizontal
2480	79.69	-2.39	69.02	94	-24.98	Vertical

FOR BLE

RADIATED EMISSION TEST- (ABOVE 1GHZ)-LOW CHANNEL-HORIZONTAL

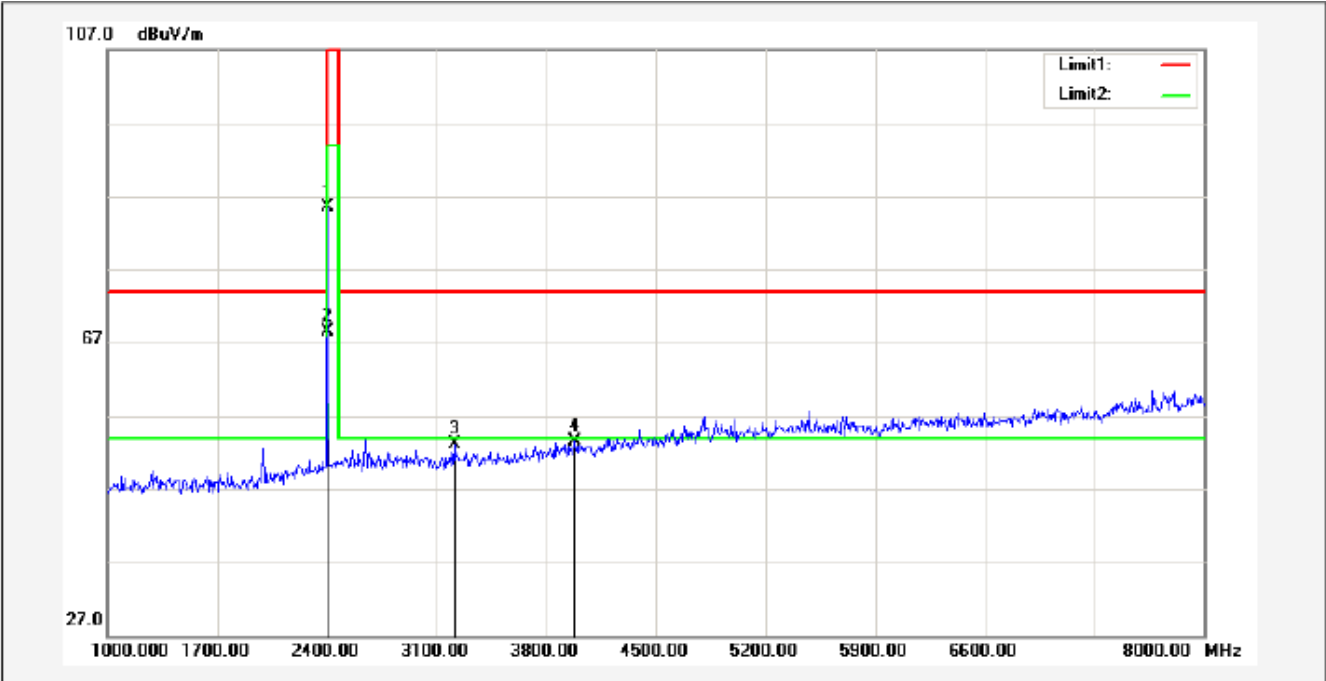

No.	Frequency (MHz)	Reading (dBuV)	Correction factor(dB/m)	Result (dBuV/m)	Limit (dBuV/m)	Margin (dB)	Degree (deg.)	Height (cm)	Remark
1X	2402.000	88.34	-2.81	85.53	114.00	-28.47			peak
2*	2402.000	71.31	-2.81	68.39	94.00	-25.61			AVG
3	3212.000	54.19	-1.00	53.19	74.00	-20.81			peak
4	3982.000	51.91	1.51	53.42	74.00	-20.58			peak

RESULT: PASS

RADIATED EMISSION TEST- (ABOVE 1GHZ)-LOW CHANNEL- VERTICAL

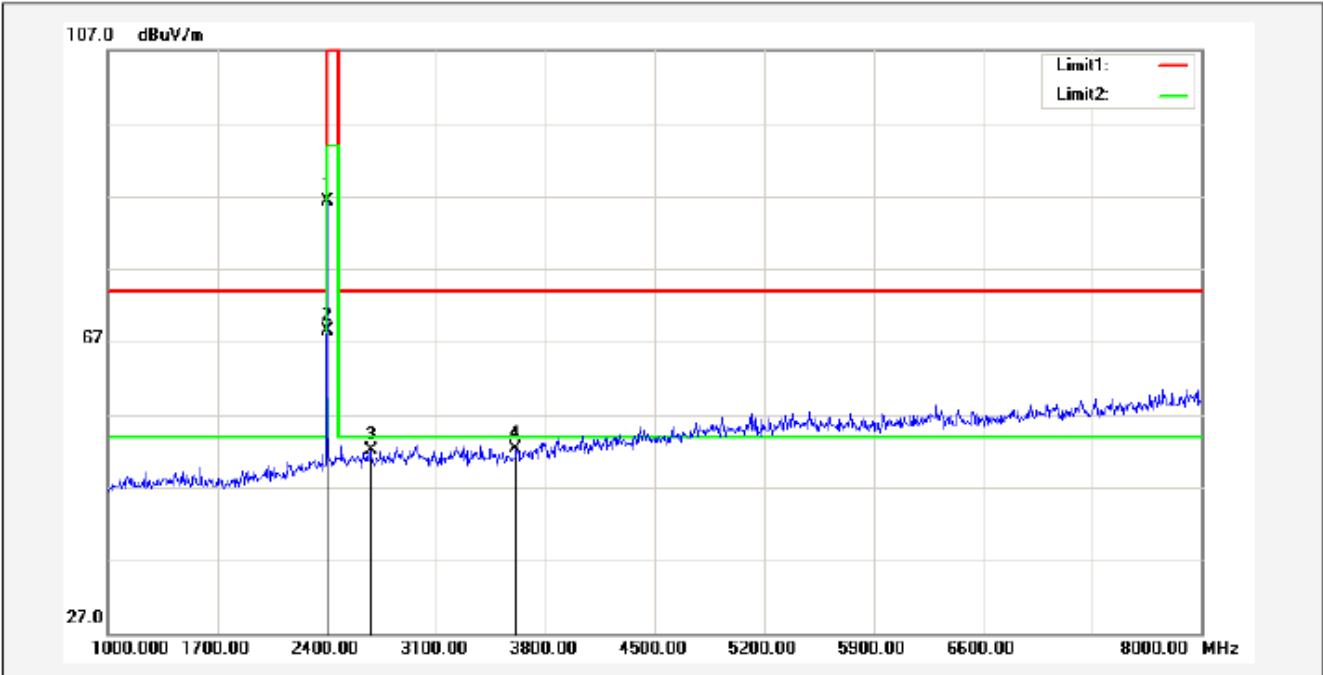

No.	Frequency (MHz)	Reading (dBuV)	Correction factor(dB/m)	Result (dBuV/m)	Limit (dBuV/m)	Margin (dB)	Degree (deg.)	Height (cm)	Remark
1X	2402.000	89.06	-2.81	86.25	114.00	-27.75			peak
2*	2402.000	71.31	-2.81	68.50	94.00	-25.50			AVG
3	2680.000	54.01	-1.94	52.07	74.00	-21.93			peak
4	3611.000	52.35	-0.05	52.30	74.00	-21.70			peak

RESULT: PASS

RADIATED EMISSION TEST- (ABOVE 1GHZ)-MIDDLE CHANNEL-HORIZONTAL

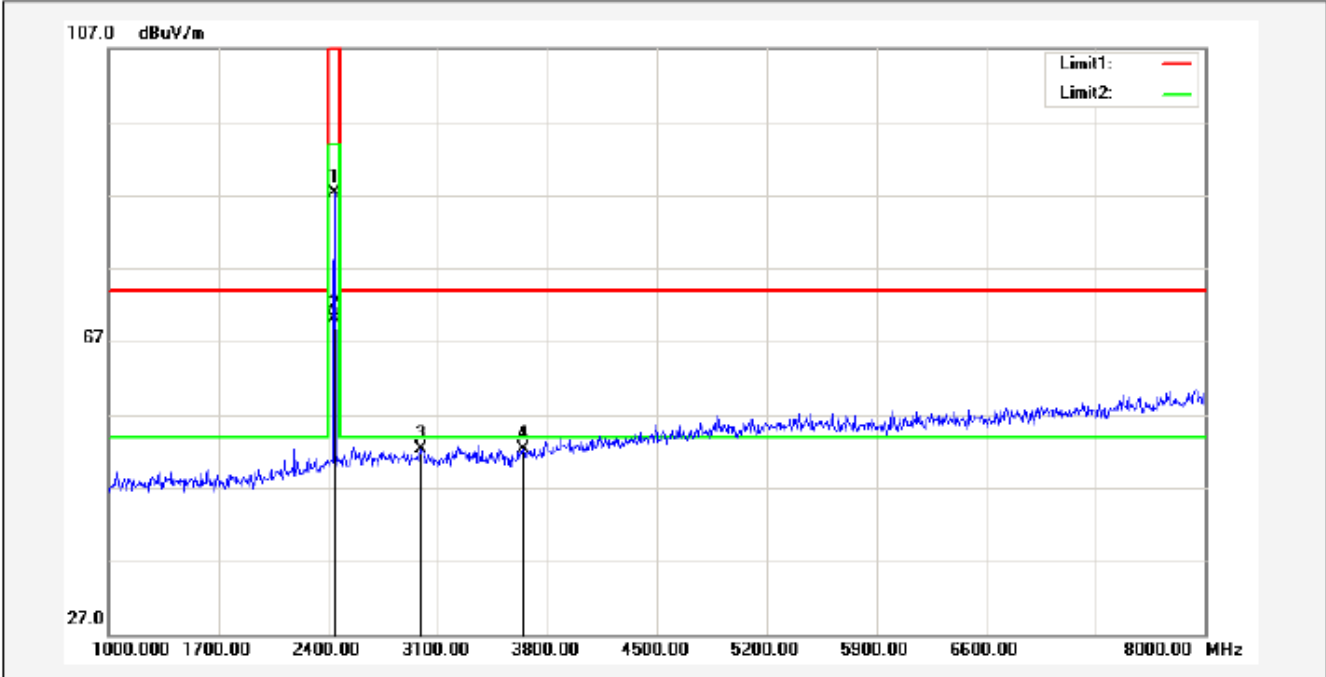

No.	Frequency (MHz)	Reading (dBuV)	Correction factor(dB/m)	Result (dBuV/m)	Limit (dBuV/m)	Margin (dB)	Degree (deg.)	Height (cm)	Remark
1	2440.000	89.87	-2.58	87.29	114.00	-26.71			peak
2	2440.000	72.78	-2.58	70.20	94.00	-23.80			AVG
3	2988.000	53.75	-1.38	52.37	74.00	-21.63			peak
4*	3646.000	52.28	0.10	52.38	74.00	-21.62			peak

RESULT: PASS

RADIATED EMISSION TEST- (ABOVE 1GHZ)-MIDDLE CHANNEL- VERTICAL

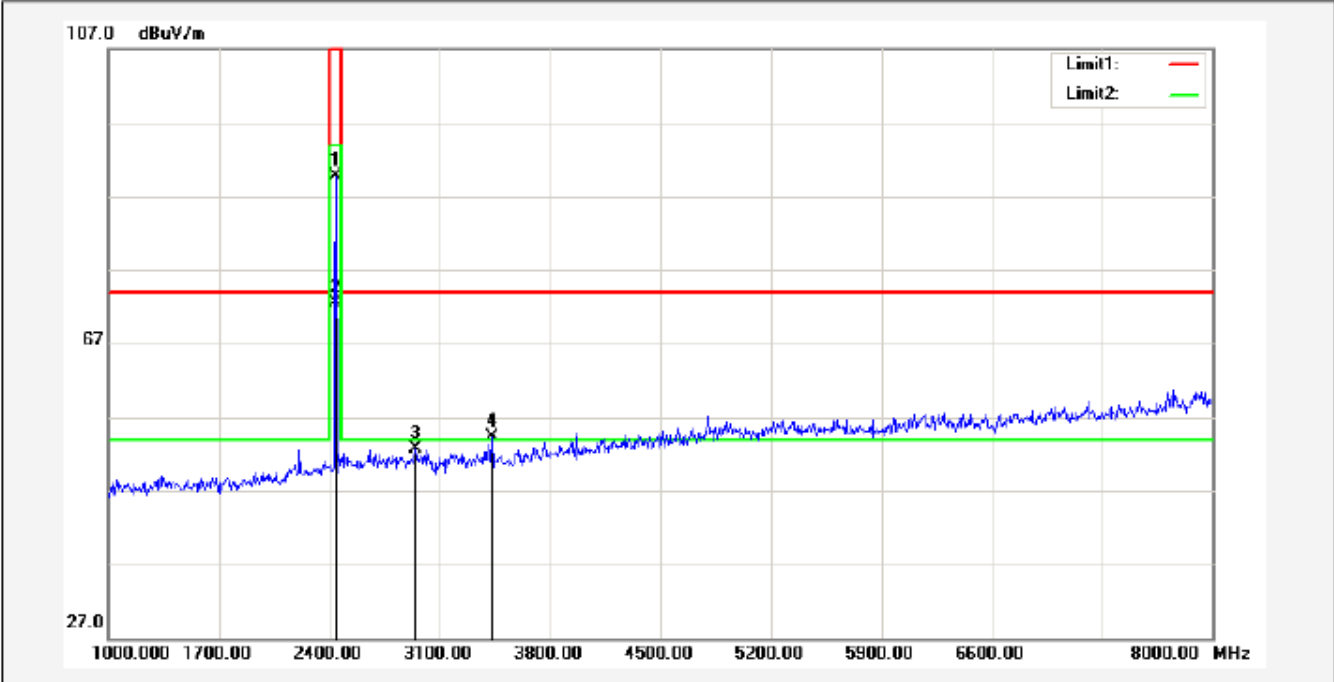

No.	Frequency (MHz)	Reading (dBuV)	Correction factor(dB/m)	Result (dBuV/m)	Limit (dBuV/m)	Margin (dB)	Degree (deg.)	Height (cm)	Remark
1	2440.000	92.36	-2.58	89.78	114.00	-24.22			peak
2	2440.000	75.08	-2.58	72.50	94.00	-21.50			AVG
3	2946.000	54.07	-1.46	52.61	74.00	-21.39			peak
4*	3429.000	54.93	-0.64	54.29	74.00	-19.71			peak

RESULT: PASS

RADIATED EMISSION TEST- (ABOVE 1GHZ)-HIGH CHANNEL-HORIZONTAL

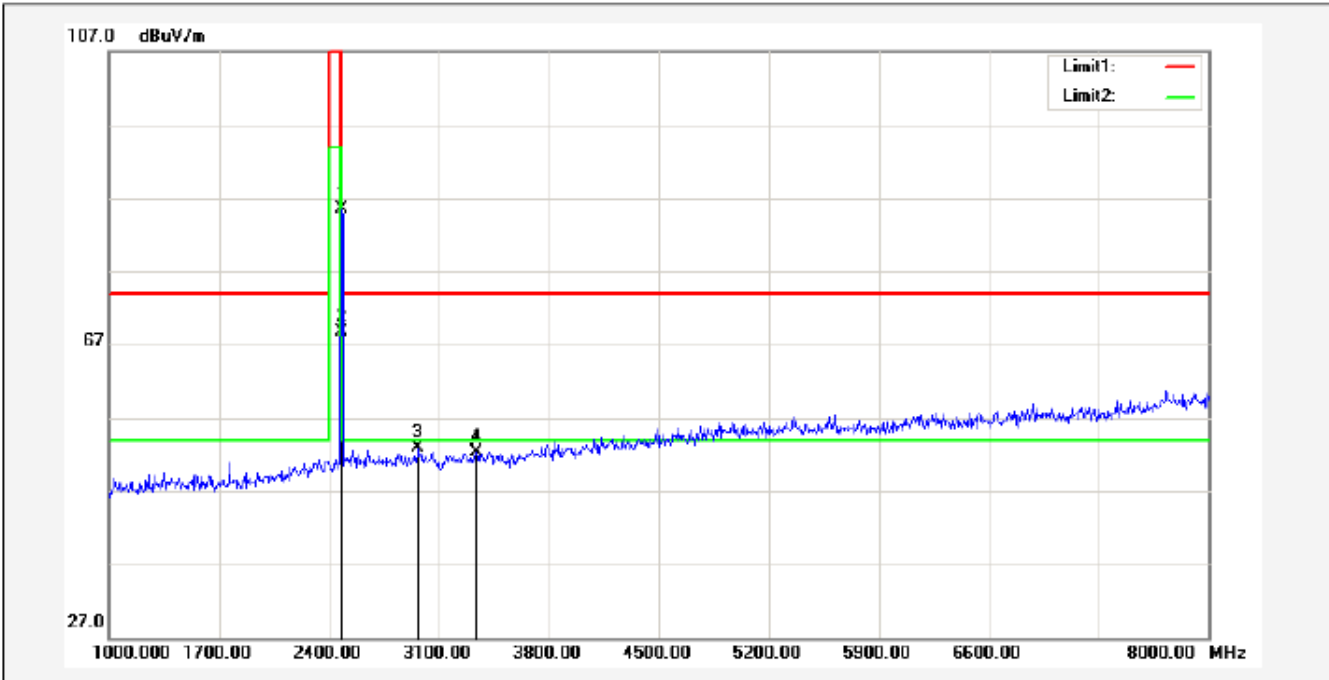

No.	Frequency (MHz)	Reading (dBuV)	Correction factor(dB/m)	Result (dBuV/m)	Limit (dBuV/m)	Margin (dB)	Degree (deg.)	Height (cm)	Remark
1	2480.000	87.87	-2.39	85.48	114.00	-28.52			peak
2	2480.000	71.09	-2.39	68.70	94.00	-25.30			AVG
3*	2967.000	54.29	-1.42	52.87	74.00	-21.13			peak
4	3338.000	53.07	-0.79	52.28	74.00	-21.72			peak

RESULT: PASS

RADIATED EMISSION TEST- (ABOVE 1GHZ)-HIGH CHANNEL- VERTICAL

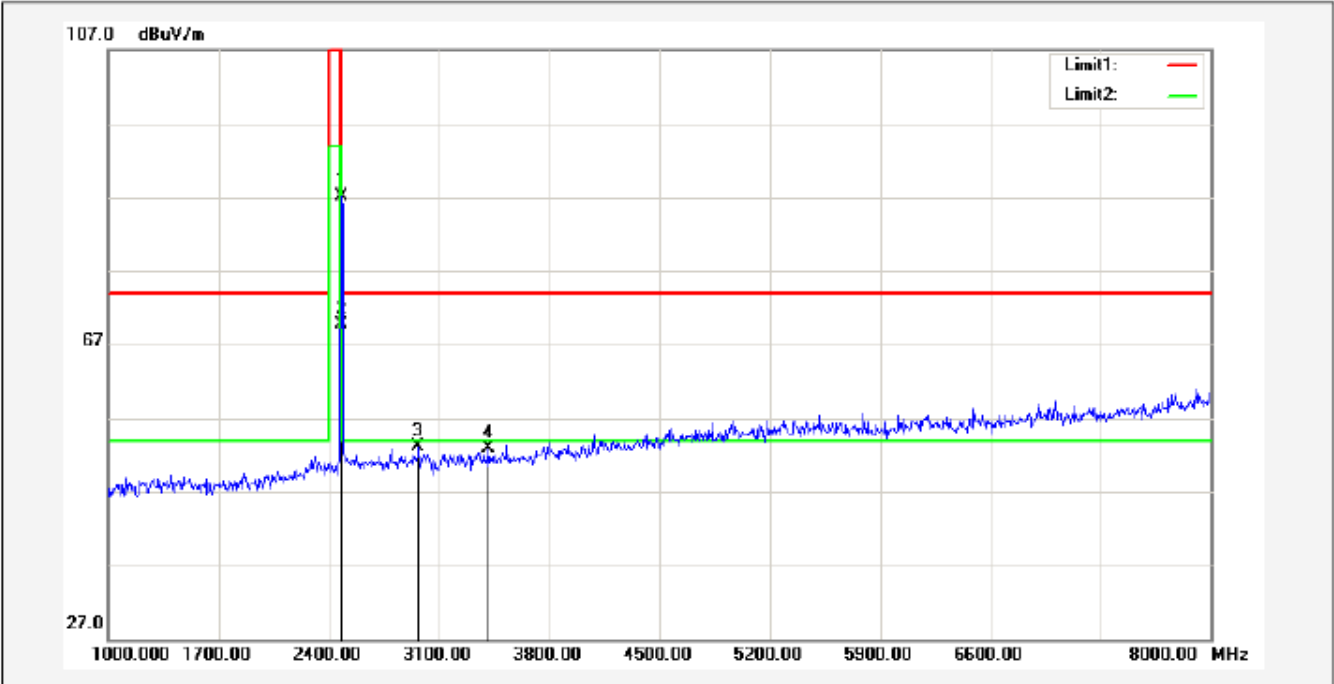

No.	Frequency (MHz)	Reading (dBuV)	Correction factor(dB/m)	Result (dBuV/m)	Limit (dBuV/m)	Margin (dB)	Degree (deg.)	Height (cm)	Remark
1	2480.000	89.46	-2.39	87.07	114.00	-26.93			peak
2	2480.000	72.12	-2.39	69.73	94.00	-24.27			AVG
3*	2967.000	54.52	-1.42	53.10	74.00	-20.90			peak
4	3415.000	53.50	-0.66	52.84	74.00	-21.16			peak

RESULT: PASS

Note: 6~25GHz at least have 20dB margin. No recording in the test report.
 Factor=Antenna Factor + Cable loss - Amplifier gain, Margin=Measurement-Limit.
 The "Factor" value can be calculated automatically by software of measurement system.

Field strength of the fundamental signal

Peak value

Frequency	Reading Level	Factor	Measurement	Limit	Over	Antenna
(MHz)	(dBuv)	(dB/m)	(dBuv/m)	(dBuv/m)	(dB)	Polarization
2402	88.34	-2.81	85.53	114	-28.47	Horizontal
2402	89.06	-2.81	86.25	114	-27.75	Vertical
2440	89.87	-2.58	87.29	114	-26.71	Horizontal
2440	92.36	-2.58	89.78	114	-24.22	Vertical
2480	87.87	-2.39	85.48	114	-28.52	Horizontal
2480	89.46	-2.39	87.07	114	-26.93	Vertical

Average value

Frequency	Reading Level	Factor	Measurement	Limit	Over	Antenna
(MHz)	(dBuv)	(dB/m)	(dBuv/m)	(dBuv/m)	(dB)	Polarization
2402	71.31	-2.81	85.53	94	-28.47	Horizontal
2402	71.31	-2.81	68.50	94	-25.50	Vertical
2440	72.78	-2.58	70.20	94	-23.80	Horizontal
2440	75.08	-2.58	72.50	94	-21.50	Vertical
2480	71.09	-2.39	68.70	94	-25.30	Horizontal
2480	72.12	-2.39	69.73	94	-24.27	Vertical

9. BAND EDGE EMISSION

9.1. MEASUREMENT PROCEDURE

1The EUT operates at hopping-off test mode. The lowest or highest channels are tested to verify the largest transmission and spurious emissions power at the continuous transmission mode.

2Max hold the trace of the setp 1,and the EUT operates at hopping-on test mode to verify the largest spurious emissions power.

3Set the spectrum analyzer in the following setting in order to capture the lower and upper band-edges of the emission: (a) PEAK: RBW=VBW=1.5MHz / Sweep=AUTO

(b) AVERAGE: RBW=1.5 MHz ; VBW=1/on time(1KHz) / Sweep=AUTO

9.2 TEST SETUP

RADIATED EMISSION TEST SETUP

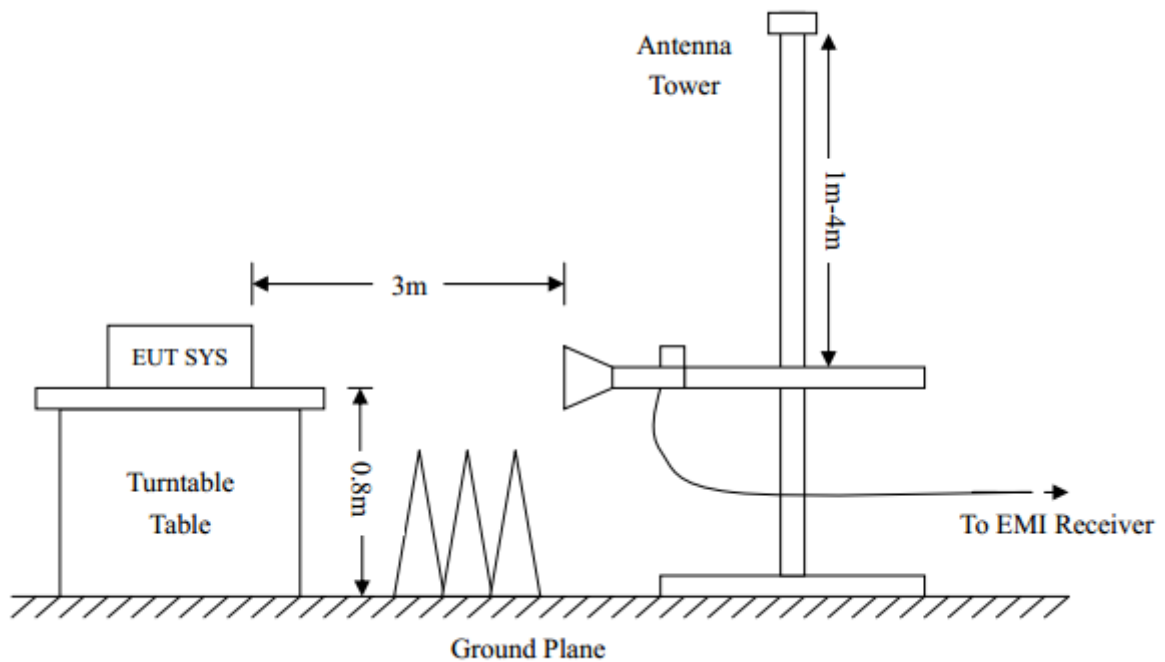

CONDUCTED TEST SETUP

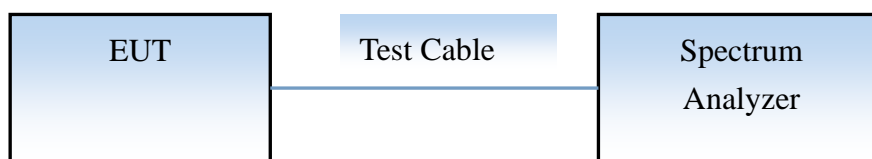

9.3 RADIATED TEST RESULT
(Worst modulation: GFSK)
FOR BR/EDR BLEUTOOTH

TEST PLOT OF BAND EDGE FOR LOW CHANNEL-Horizontal

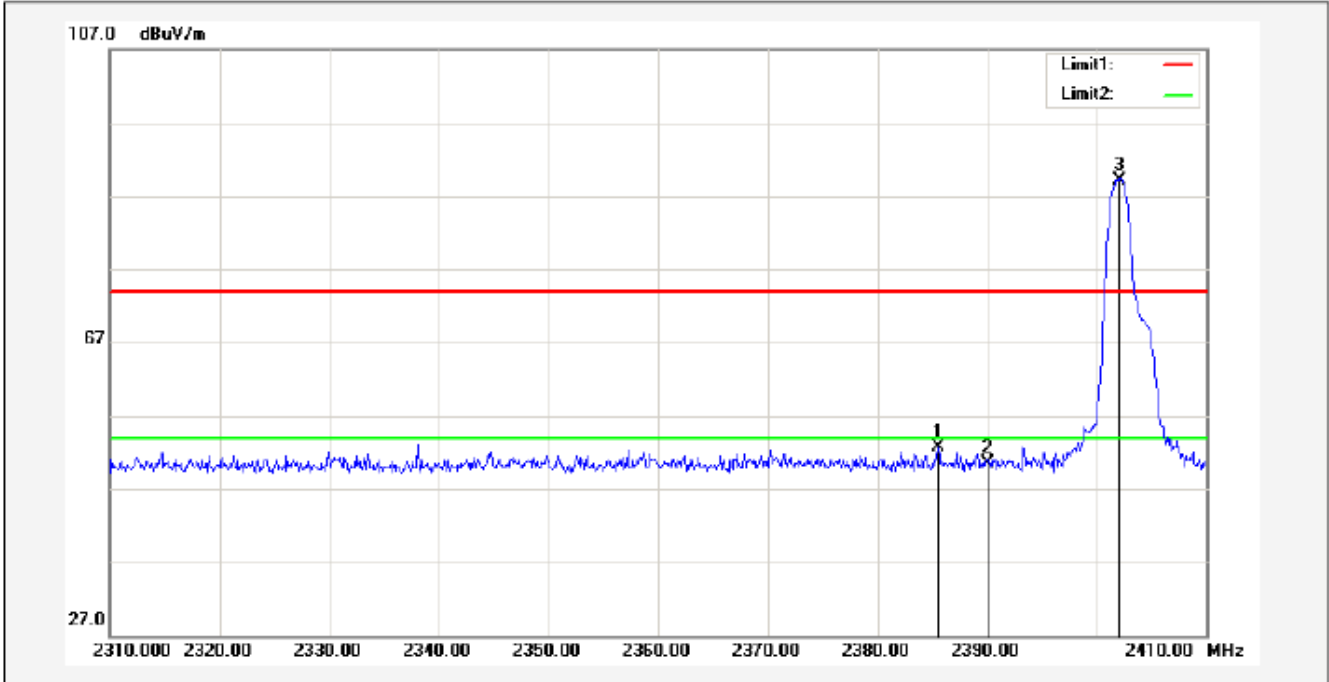

No.	Frequency (MHz)	Reading (dBuV)	Correction factor(dB/m)	Result (dBuV/m)	Limit (dBuV/m)	Margin (dB)	Degree (deg.)	Height (cm)	Remark
1	2385.500	55.52	-2.89	52.63	74.00	-21.37			peak
2	2390.000	53.35	-2.86	50.49	74.00	-23.51			peak
3*	2402.000	91.97	-2.80	89.17	74.00	15.17			peak

TEST PLOT OF BAND EDGE FOR LOW CHANNEL –Vertical

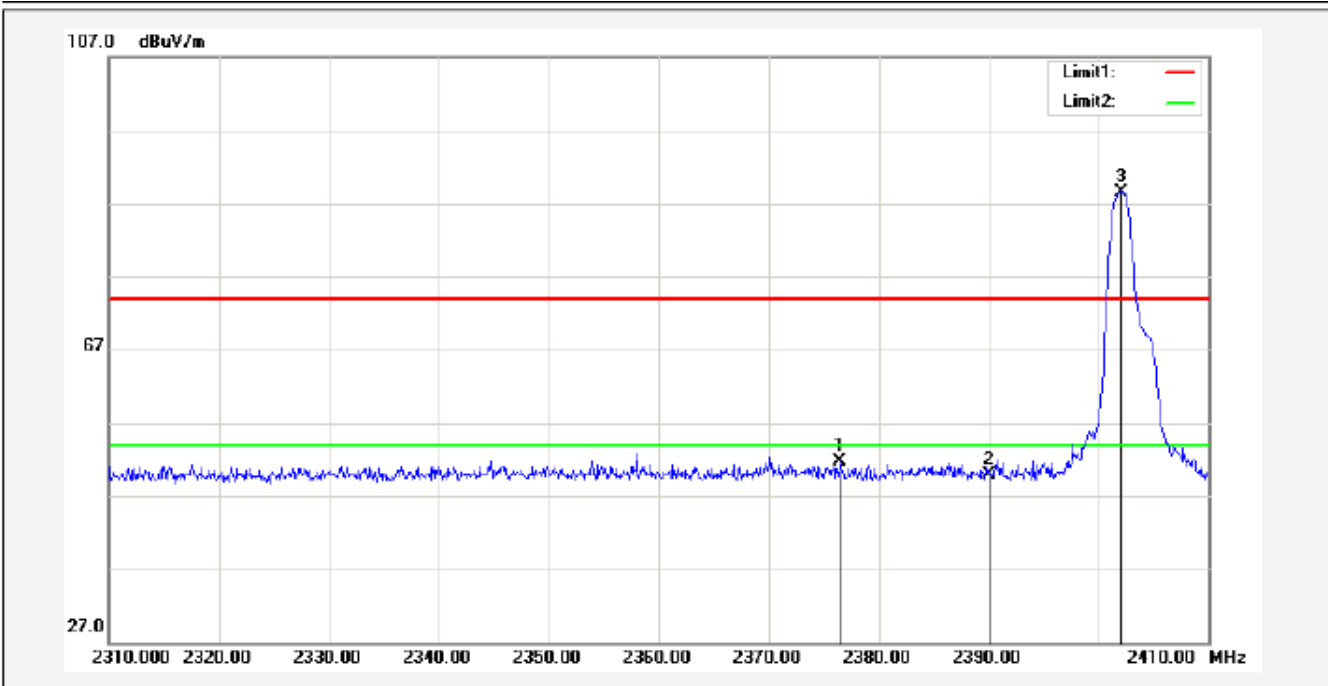

No.	Frequency (MHz)	Reading (dBuV)	Correction factor(dB/m)	Result (dBuV/m)	Limit (dBuV/m)	Margin (dB)	Degree (deg.)	Height (cm)	Remark
1	2376.500	54.72	-2.94	51.78	74.00	-22.22			peak
2	2390.000	52.82	-2.86	49.96	74.00	-24.04			peak
3*	2402.000	91.26	-2.80	88.46	74.00	14.46			peak

TEST PLOT OF BAND EDGE FOR HIGH CHANNEL -Horizontal

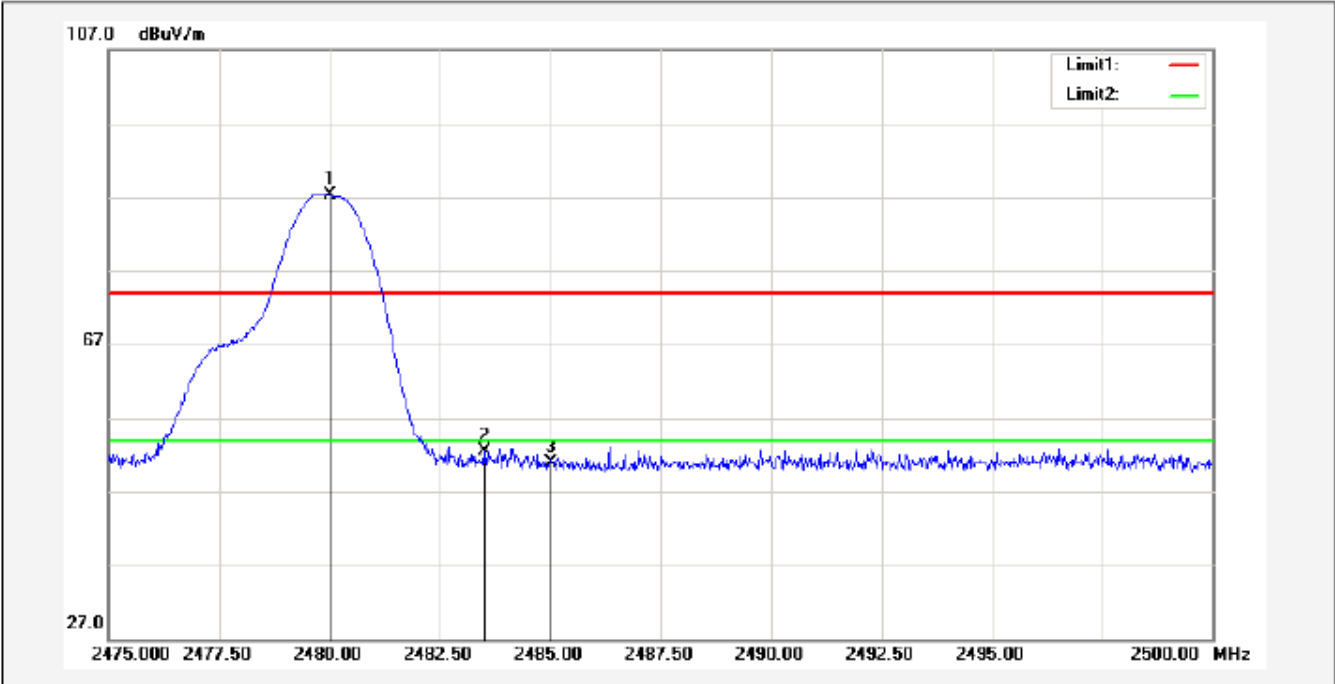

No.	Frequency (MHz)	Reading (dBuV)	Correction factor(dB/m)	Result (dBuV/m)	Limit (dBuV/m)	Margin (dB)	Degree (deg.)	Height (cm)	Remark
1*	2480.000	89.59	-2.37	87.22	74.00	13.22			peak
2	2483.500	54.85	-2.35	52.50	74.00	-21.50			peak
3	2485.000	53.19	-2.34	50.85	74.00	-23.15			peak

TEST PLOT OF BAND EDGE FOR HIGH CHANNEL-Vertical

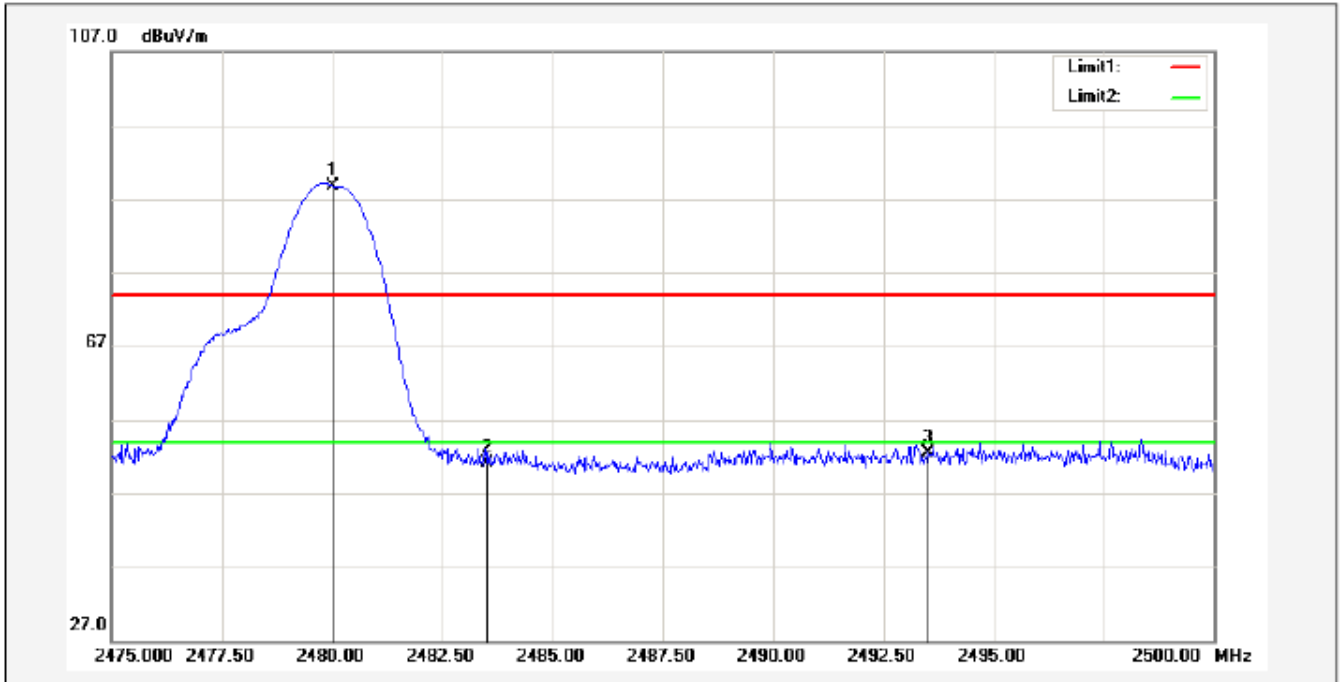

No.	Frequency (MHz)	Reading (dBuV)	Correction factor(dB/m)	Result (dBuV/m)	Limit (dBuV/m)	Margin (dB)	Degree (deg.)	Height (cm)	Remark
1*	2480.000	91.10	-2.37	88.73	74.00	14.73			peak
2	2483.500	53.49	-2.35	51.14	74.00	-22.86			peak
3	2493.500	54.76	-2.30	52.46	74.00	-21.54			peak

RESULT: PASS

Note: The other modes radiation emission have enough 20dB margin.

Factor=Antenna Factor + Cable loss - Amplifier gain, Over=Measure-Limit.

The "Factor" value can be calculated automatically by software of measurement system.

FOR BLE

TEST PLOT OF BAND EDGE FOR LOW CHANNEL-Horizontal

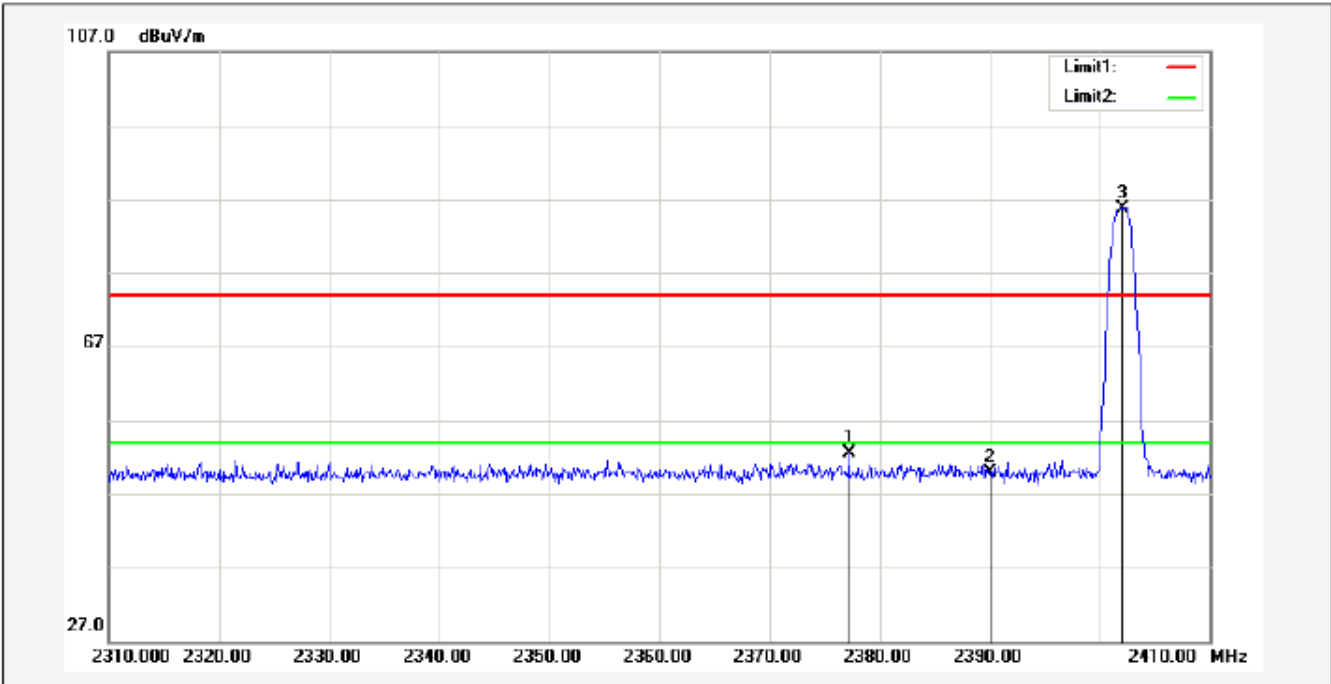

No.	Frequency (MHz)	Reading (dBuV)	Correction factor(dB/m)	Result (dBuV/m)	Limit (dBuV/m)	Margin (dB)	Degree (deg.)	Height (cm)	Remark
1	2377.200	55.39	-2.93	52.46	74.00	-21.54			peak
2	2390.000	52.78	-2.86	49.92	74.00	-24.08			peak
3*	2402.000	88.55	-2.80	85.75	74.00	11.75			peak

TEST PLOT OF BAND EDGE FOR LOW CHANNEL –Vertical

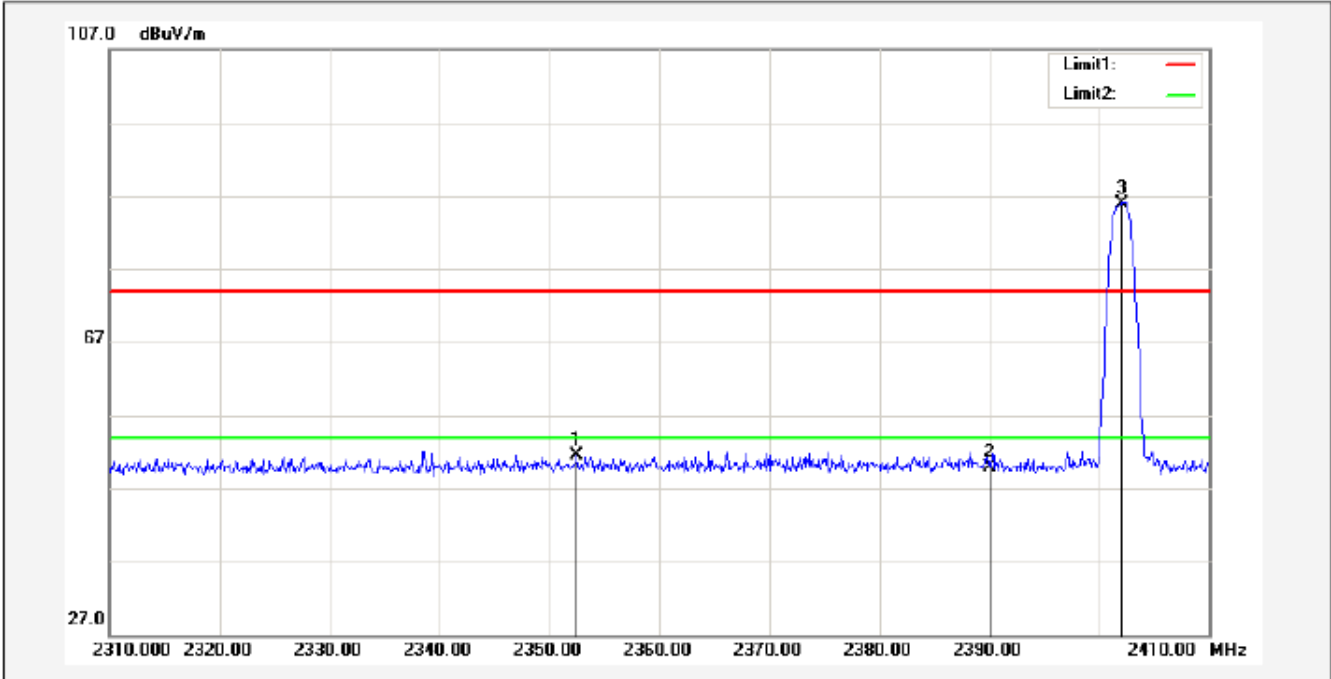

No.	Frequency (MHz)	Reading (dBuV)	Correction factor(dB/m)	Result (dBuV/m)	Limit (dBuV/m)	Margin (dB)	Degree (deg.)	Height (cm)	Remark
1	2352.500	54.52	-3.07	51.45	74.00	-22.55			peak
2	2390.000	52.77	-2.86	49.91	74.00	-24.09			peak
3*	2402.000	88.78	-2.80	85.98	74.00	11.98			peak

TEST PLOT OF BAND EDGE FOR HIGH CHANNEL -Horizontal

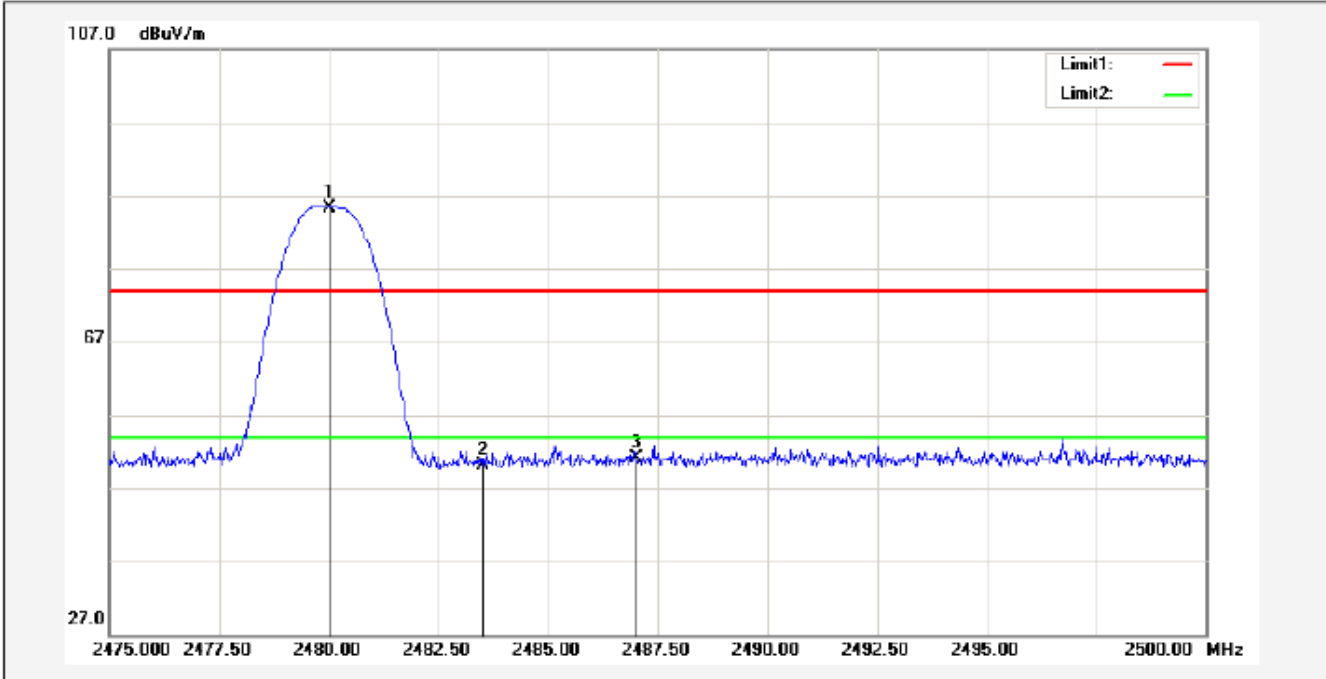

No.	Frequency (MHz)	Reading (dBuV)	Correction factor(dB/m)	Result (dBuV/m)	Limit (dBuV/m)	Margin (dB)	Degree (deg.)	Height (cm)	Remark
1*	2480.000	87.73	-2.37	85.36	74.00	11.36			peak
2	2483.500	52.44	-2.35	50.09	74.00	-23.91			peak
3	2487.000	53.45	-2.33	51.12	74.00	-22.88			peak

TEST PLOT OF BAND EDGE FOR HIGH CHANNEL-Vertical

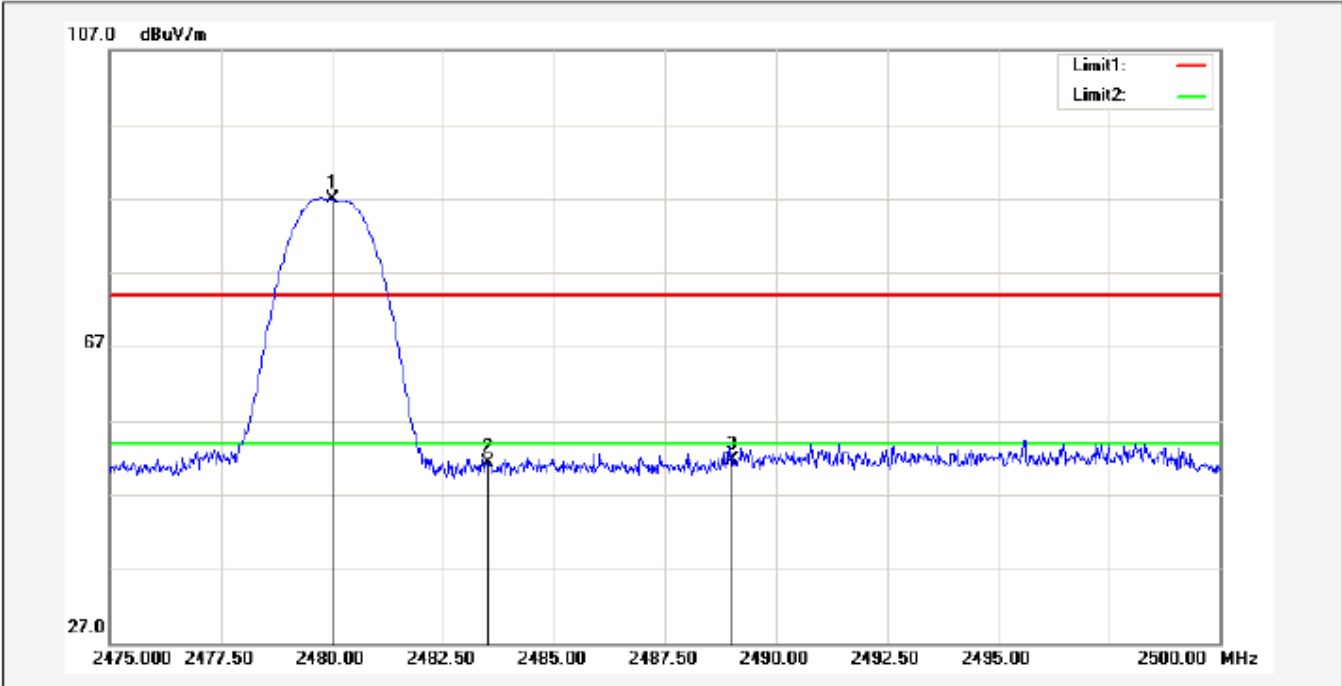

No.	Frequency (MHz)	Reading (dBuV)	Correction factor(dB/m)	Result (dBuV/m)	Limit (dBuV/m)	Margin (dB)	Degree (deg.)	Height (cm)	Remark
1*	2480.000	89.27	-2.37	86.90	74.00	12.90			peak
2	2483.500	53.59	-2.35	51.24	74.00	-22.76			peak
3	2489.000	54.09	-2.32	51.77	74.00	-22.23			peak

RESULT: PASS

Note: The other modes radiation emission have enough 20dB margin.

Factor=Antenna Factor + Cable loss - Amplifier gain, Over=Measure-Limit.

The "Factor" value can be calculated automatically by software of measurement system.

10. 20DB BANDWIDTH

10.1. MEASUREMENT PROCEDURE

1. Connect EUT RF output port to the Spectrum Analyzer through an RF attenuator
2. Set the EUT Work on the top, the middle and the bottom operation frequency individually.
3. Set Span = approximately 2 to 3 times the 20 dB bandwidth, centered on a hopping channel
 $RBW \geq 1\%$ of the 20 dB bandwidth, $VBW \geq RBW$; Sweep = auto; Detector function = peak
4. Set SPA Trace 1 Max hold, then View.

10.2. TEST SET-UP

(BLOCK DIAGRAM OF CONFIGURATION)

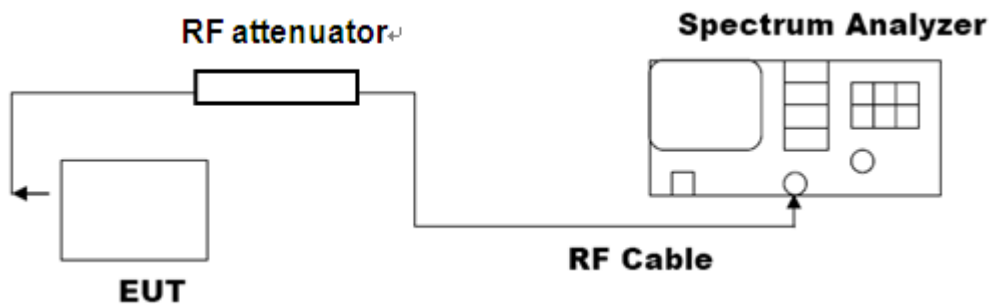

10.3. LIMITS AND MEASUREMENT RESULTS

FOR BR/EDR BLUETOOTH

BLUETOOTH 1MBPS LIMITS AND MEASUREMENT RESULT			
Applicable Limits	Measurement Result		
	Test Data (MHz)		Criteria
N/A	Low Channel	0.902	PASS
	Middle Channel	0.911	PASS
	High Channel	0.911	PASS

TEST PLOT OF BANDWIDTH FOR LOW CHANNEL

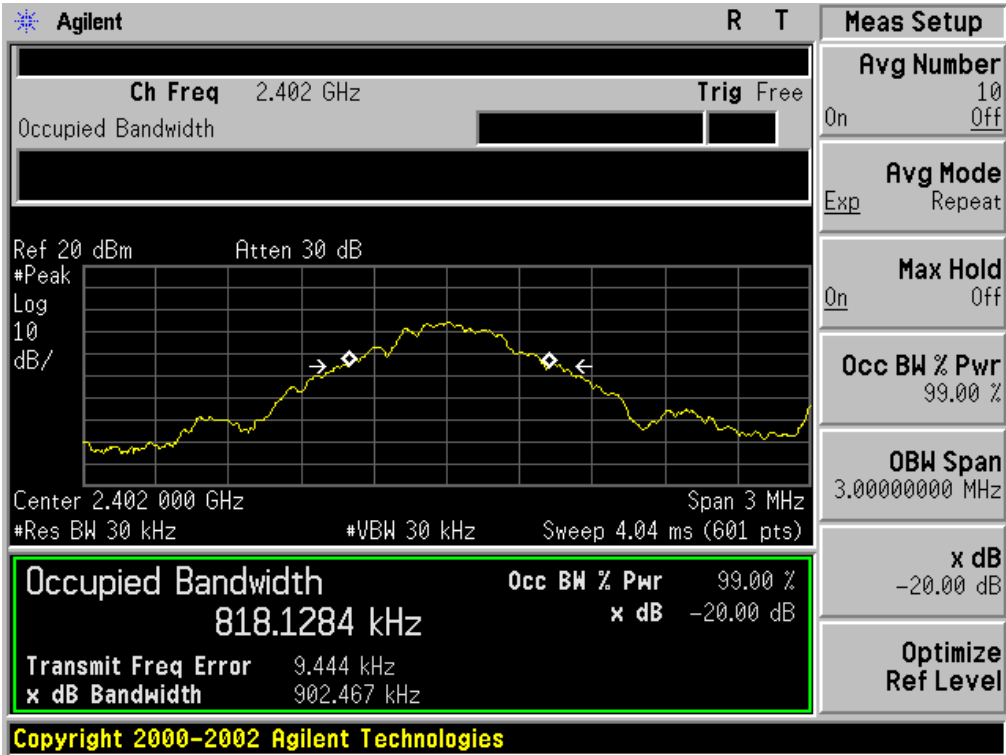

TEST PLOT OF BANDWIDTH FOR MIDDLE CHANNEL



TEST PLOT OF BANDWIDTH FOR HIGH CHANNEL

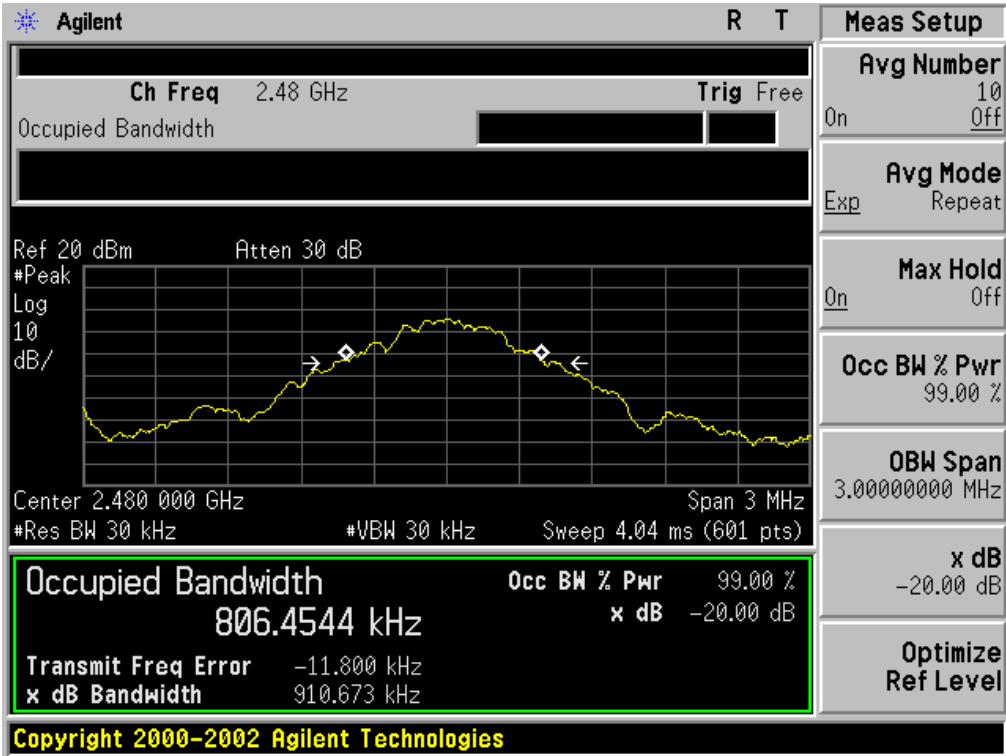

BLUETOOTH 2Mbps LIMITS AND MEASUREMENT RESULT			
Applicable Limits	Measurement Result		
	Test Data (MHz)		Criteria
N/A	Low Channel	1.256	PASS
	Middle Channel	1.262	PASS
	High Channel	1.258	PASS

TEST PLOT OF BANDWIDTH FOR LOW CHANNEL

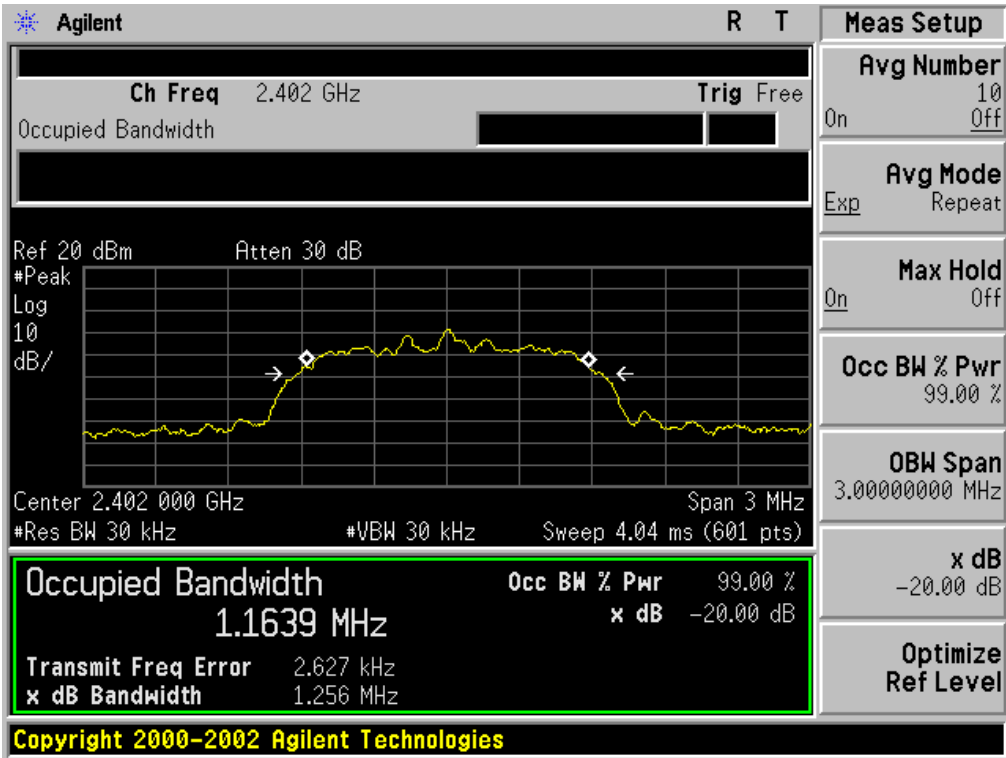

TEST PLOT OF BANDWIDTH FOR MIDDLE CHANNEL

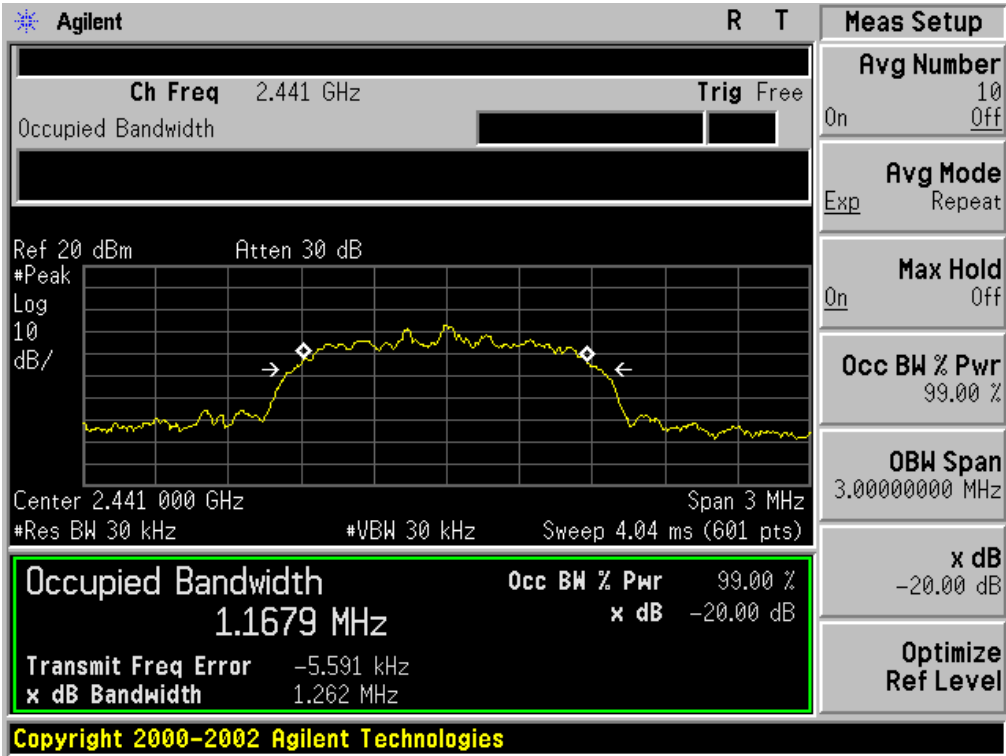

TEST PLOT OF BANDWIDTH FOR HIGH CHANNEL

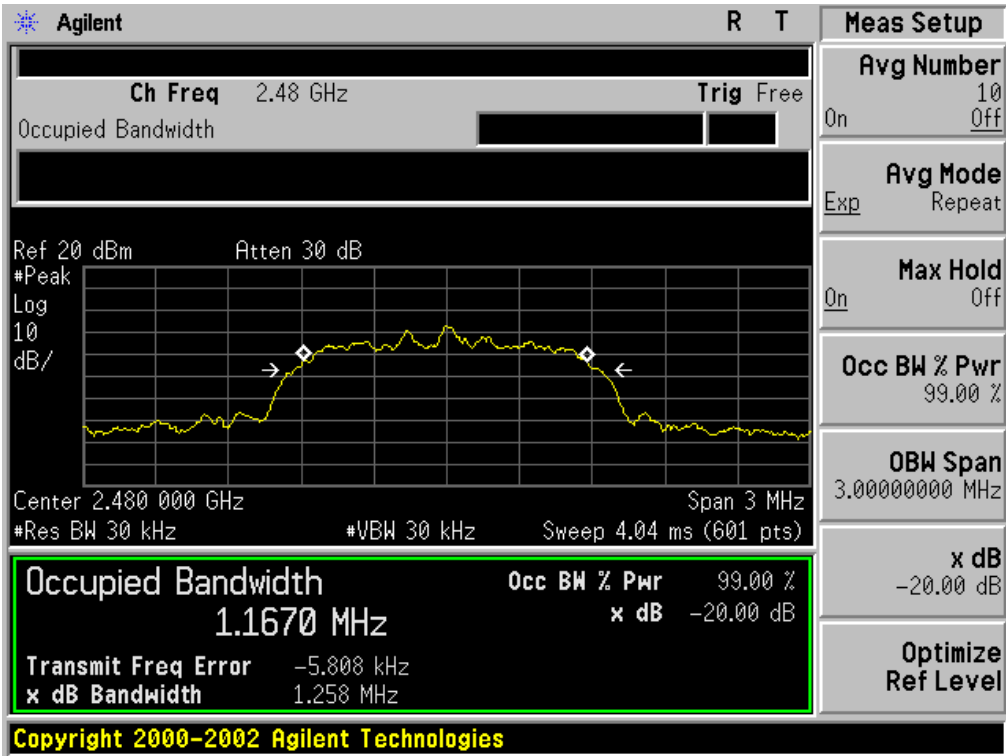

BLUETOOTH 3MBPS LIMITS AND MEASUREMENT RESULT			
Applicable Limits	Measurement Result		
	Test Data (MHz)		Criteria
N/A	Low Channel	1.262	PASS
	Middle Channel	1.256	PASS
	High Channel	1.261	PASS

TEST PLOT OF BANDWIDTH FOR LOW CHANNEL

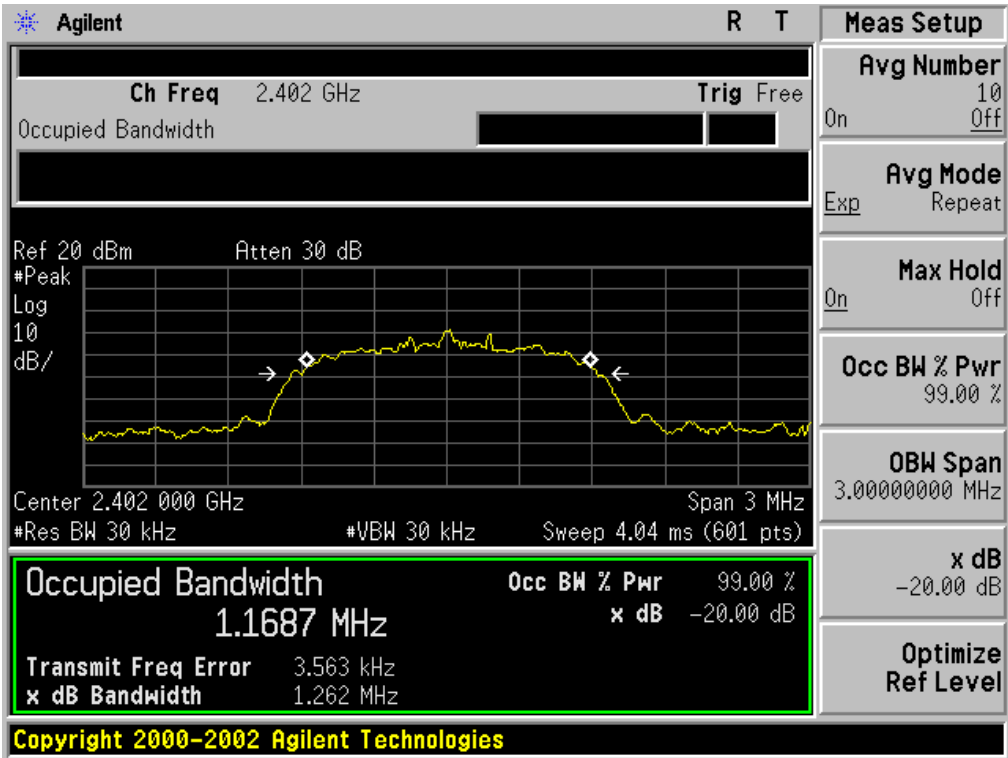

TEST PLOT OF BANDWIDTH FOR MIDDLE CHANNEL

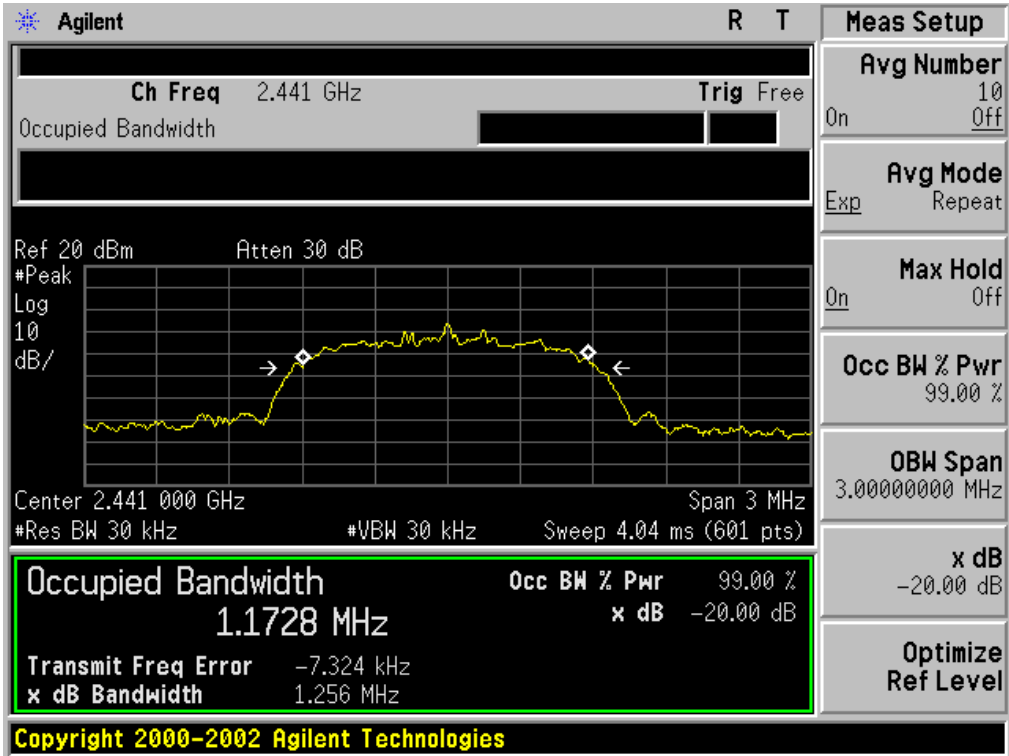

TEST PLOT OF BANDWIDTH FOR HIGH CHANNEL

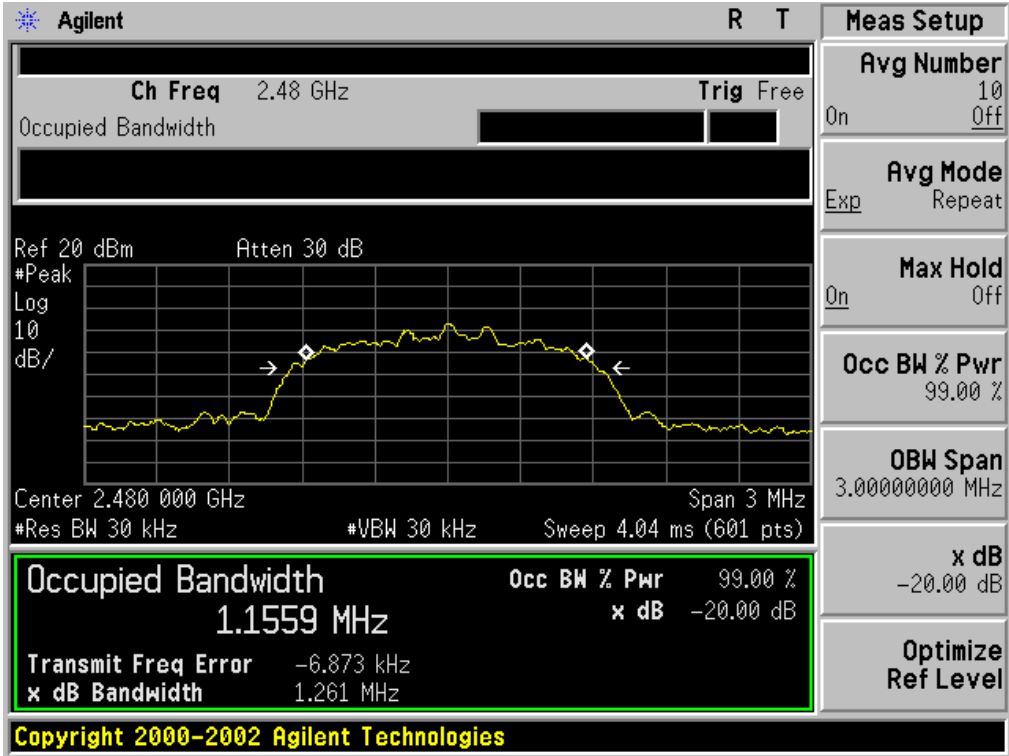

FOR BLE

BLUETOOTH 1MBPS LIMITS AND MEASUREMENT RESULT			
Applicable Limits	Measurement Result		
	Test Data (MHz)		Criteria
N/A	Low Channel	1.206	PASS
	Middle Channel	1.201	PASS
	High Channel	1.205	PASS

TEST PLOT OF BANDWIDTH FOR LOW CHANNEL

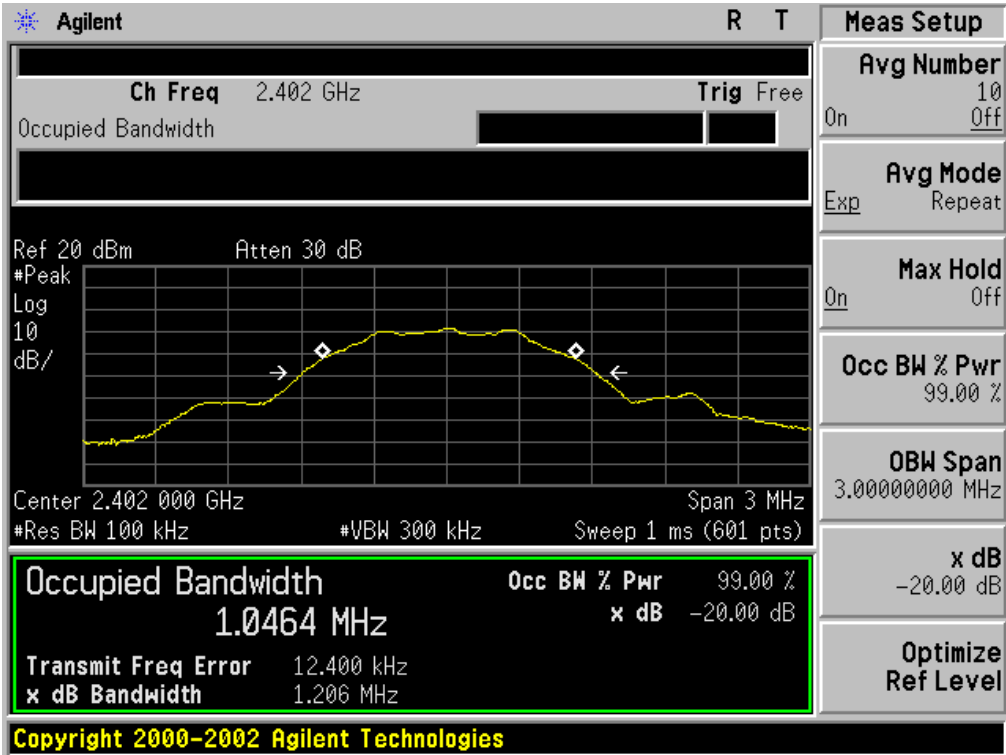

TEST PLOT OF BANDWIDTH FOR MIDDLE CHANNEL

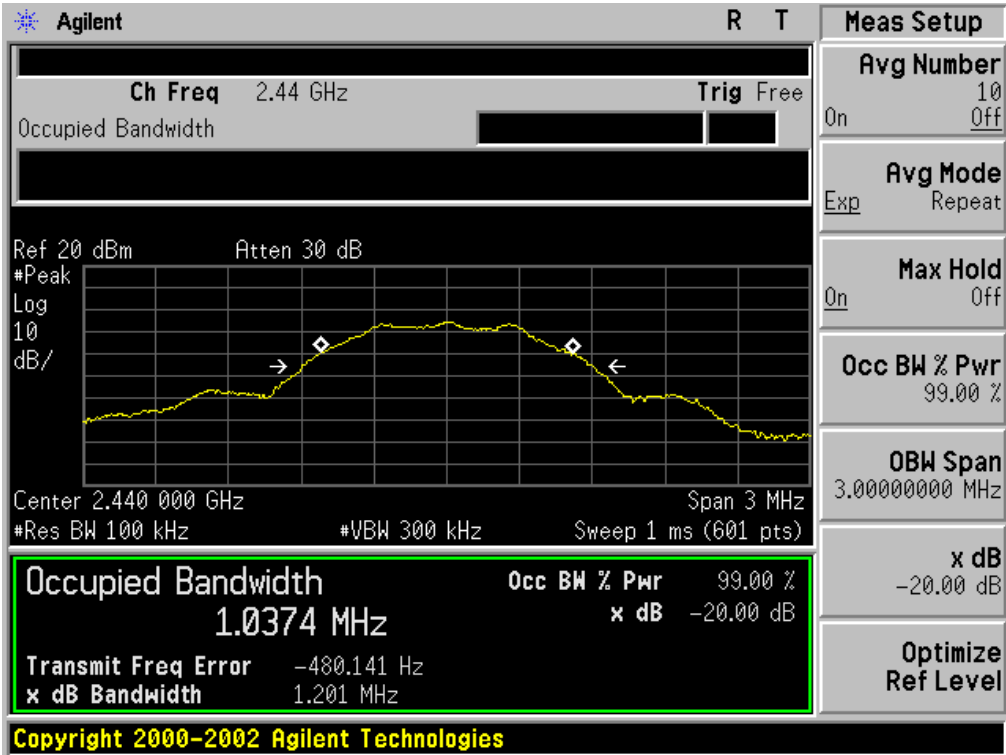

TEST PLOT OF BANDWIDTH FOR HIGH CHANNEL

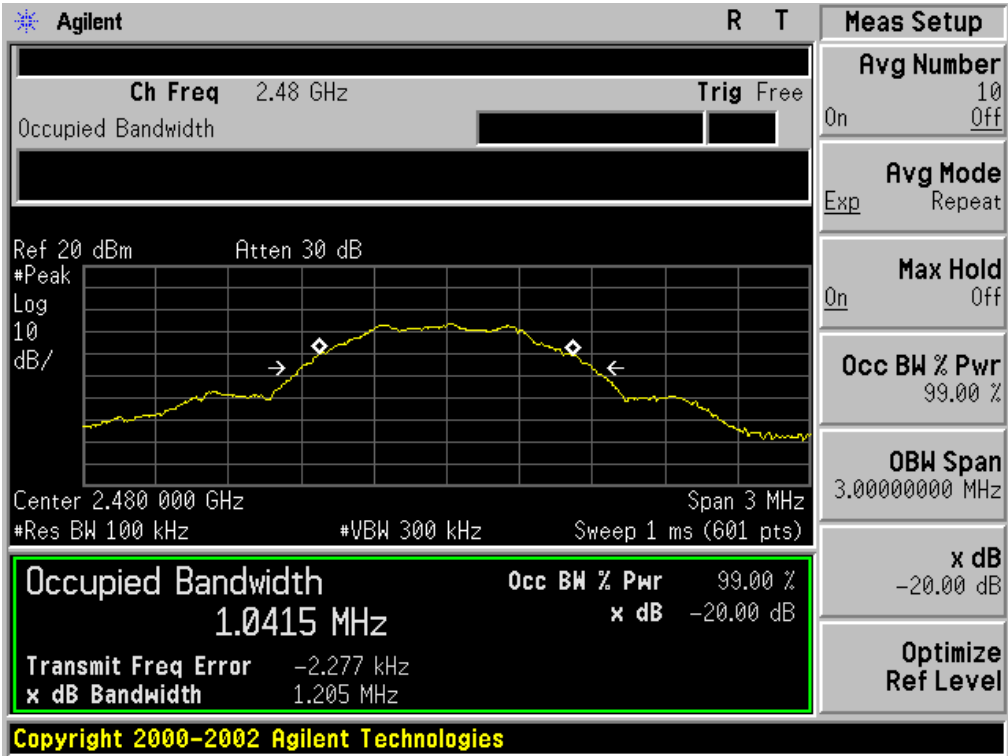

11. FCC LINE CONDUCTED EMISSION TEST

11.1. LIMITS OF LINE CONDUCTED EMISSION TEST

Frequency	Maximum RF Line Voltage	
	Q.P.(dBuV)	Average(dBuV)
150kHz~500kHz	66-56	56-46
500kHz~5MHz	56	46
5MHz~30MHz	60	50

Note:

1. The lower limit shall apply at the transition frequency.
2. The limit decreases linearly with the logarithm of the frequency in the range 0.15 MHz to 0.50 MHz.

11.2. BLOCK DIAGRAM OF LINE CONDUCTED EMISSION TEST

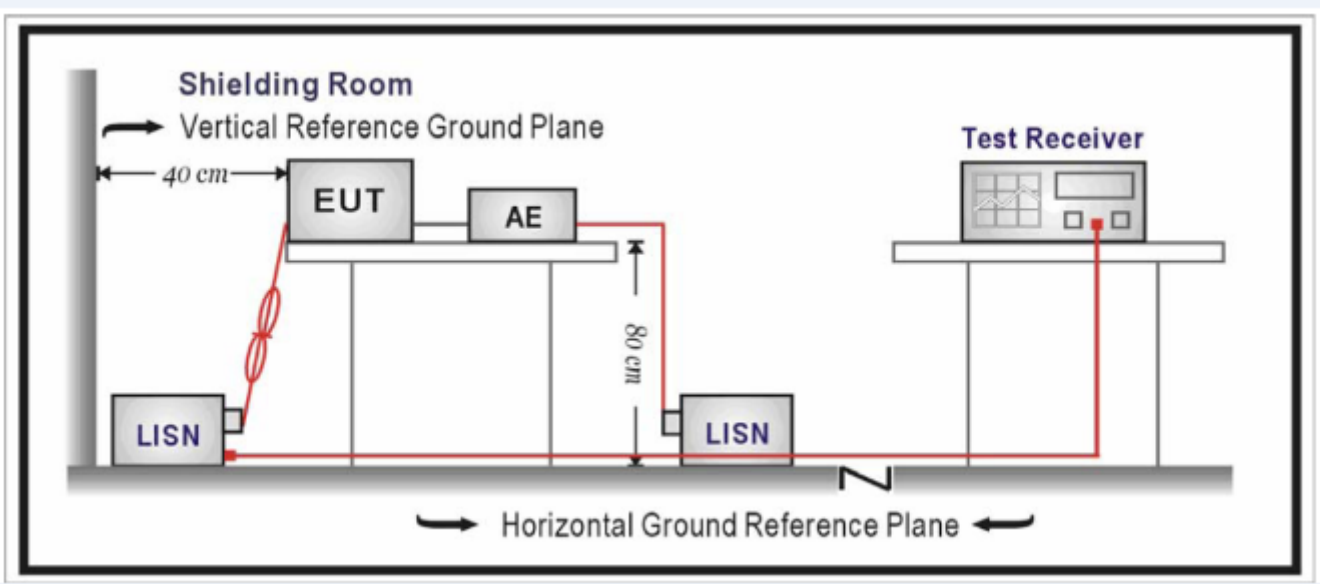

11.3. PRELIMINARY PROCEDURE OF LINE CONDUCTED EMISSION TEST

1. The equipment was set up as per the test configuration to simulate typical actual usage per the user's manual. When the EUT is a tabletop system, a wooden table with a height of 0.8 meters is used and is placed on the ground plane as per ANSI C63.4 (see Test Facility for the dimensions of the ground plane used). When the EUT is a floor-standing equipment, it is placed on the ground plane which has a 3-12 mm non-conductive covering to insulate the EUT from the ground plane.
2. Support equipment, if needed, was placed as per ANSI C63.4.
3. All I/O cables were positioned to simulate typical actual usage as per ANSI C63.4.
4. All support equipments received AC120V/60Hz power from a LISN, if any.
5. The EUT received DC charging voltage by PC which received 120V/60Hz power by a LISN..
6. The test program was started. Emissions were measured on each current carrying line of the EUT using a spectrum Analyzer / Receiver connected to the LISN powering the EUT. The LISN has two monitoring points: Line 1 (Hot Side) and Line 2 (Neutral Side). Two scans were taken: one with Line 1 connected to Analyzer / Receiver and Line 2 connected to a 50 ohm load; the second scan had Line 1 connected to a 50 ohm load and Line 2 connected to the Analyzer / Receiver.
7. Analyzer / Receiver scanned from 150 kHz to 30MHz for emissions in each of the test modes.
8. During the above scans, the emissions were maximized by cable manipulation.
9. The test mode(s) were scanned during the preliminary test.

Then, the EUT configuration and cable configuration of the above highest emission level were recorded for reference of final testing.

11.4. FINAL PROCEDURE OF LINE CONDUCTED EMISSION TEST

- EUT and support equipment was set up on the test bench as per step 2 of the preliminary test.
2. A scan was taken on both power lines, Line 1 and Line 2, recording at least the six highest emissions. Emission frequency and amplitude were recorded into a computer in which correction factors were used to calculate the emission level and compare reading to the applicable limit. If EUT emission level was less -2dB to the A.V. limit in Peak mode, then the emission signal was re-checked using Q.P and Average detector.
3. The test data of the worst case condition(s) was reported on the Summary Data page.

11.5. TEST RESULT OF LINE CONDUCTED EMISSION TEST

N/A

APPENDIX A: PHOTOGRAPHS OF TEST SETUP
FCC RADIATED EMISSION TEST SETUP

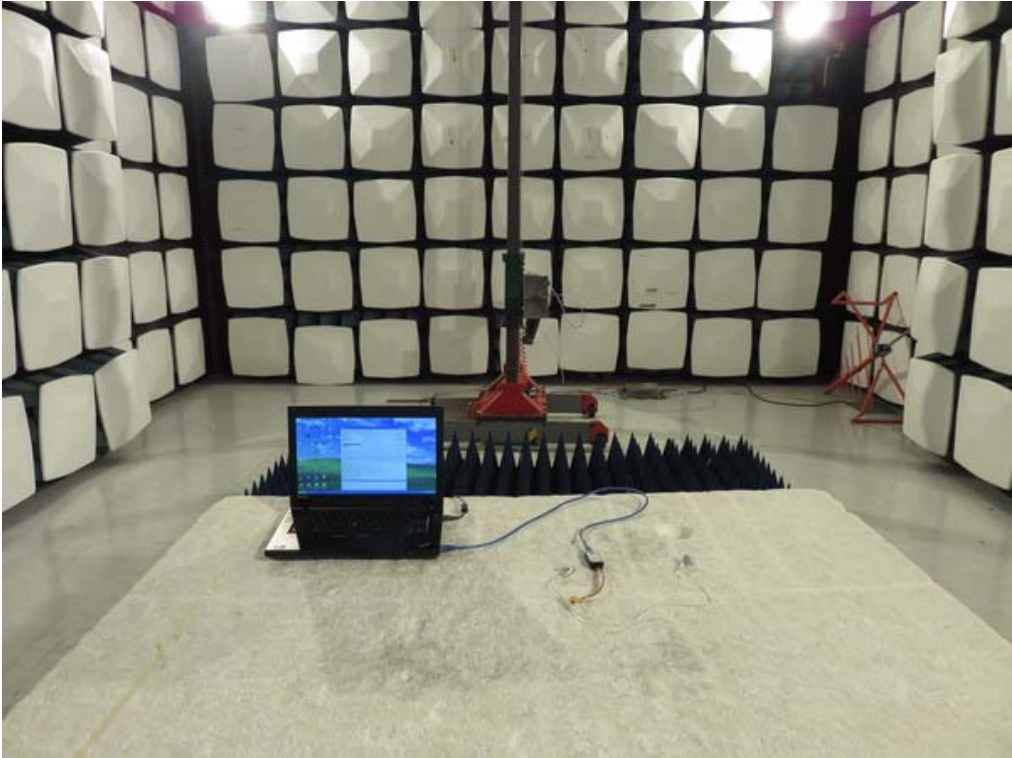

APPENDIX B: PHOTOGRAPHS OF EUT
TOP VIEW OF EUT



BOTTOM VIEW OF EUT



FRONT VIEW OF EUT



BACK VIEW OF EUT



LEFT VIEW OF EUT



RIGHT VIEW OF EUT



VIEW OF EUT (PORT)



OPEN VIEW OF EUT



INTERNAL VIEW OF EUT-1

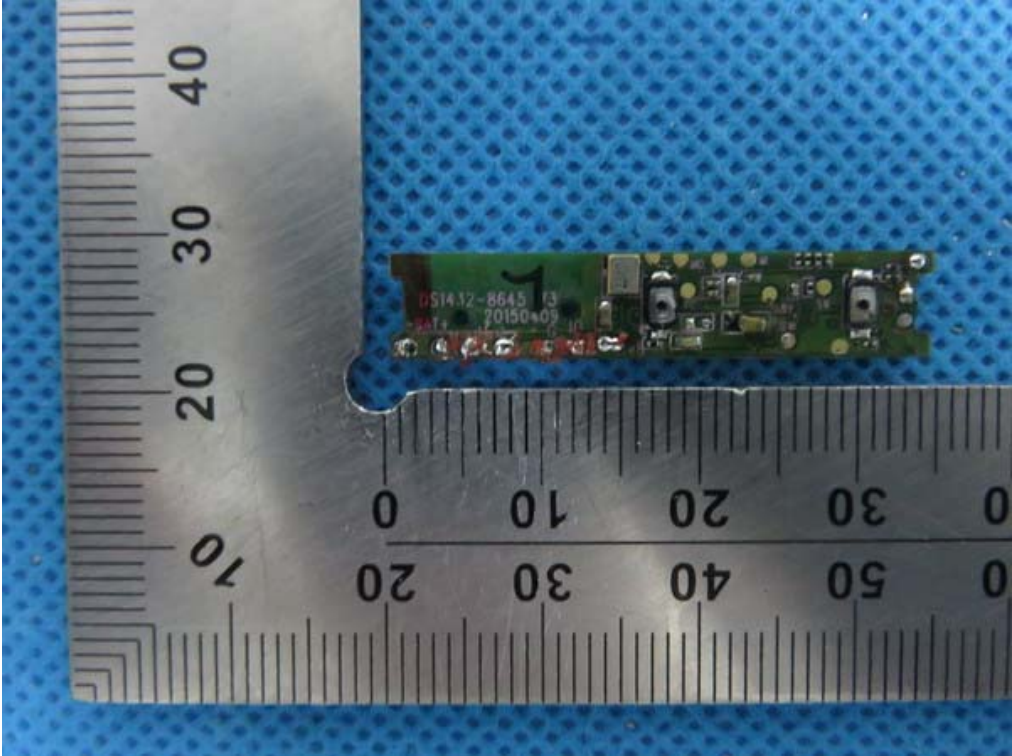

INTERNAL VIEW OF EUT-2

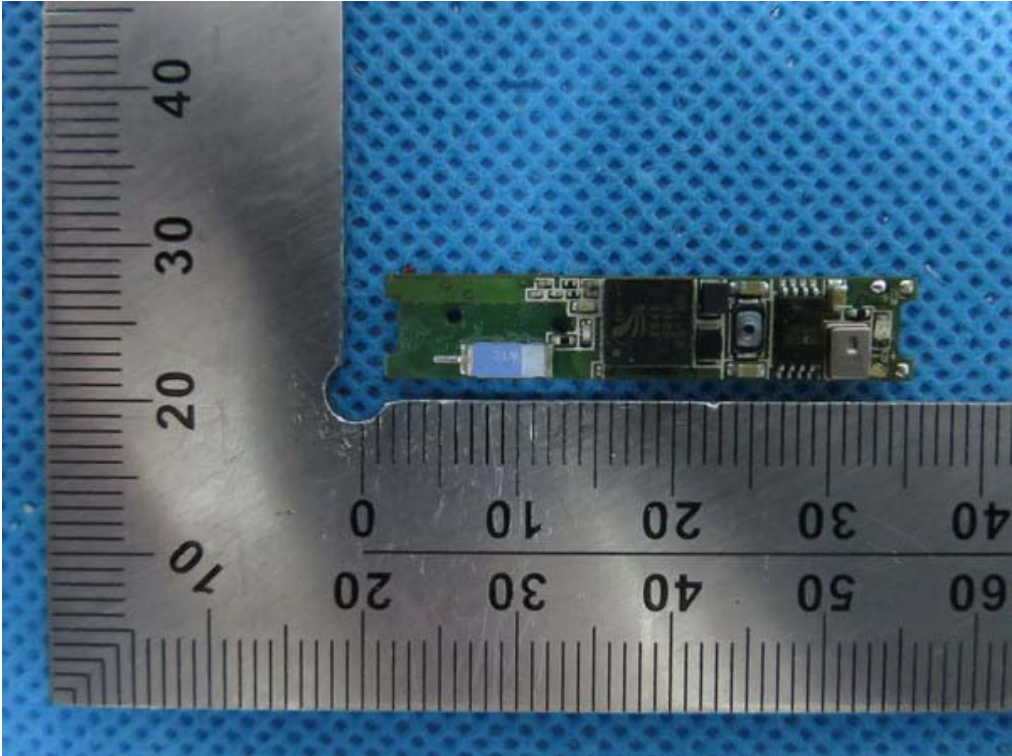

INTERNAL VIEW OF EUT-3

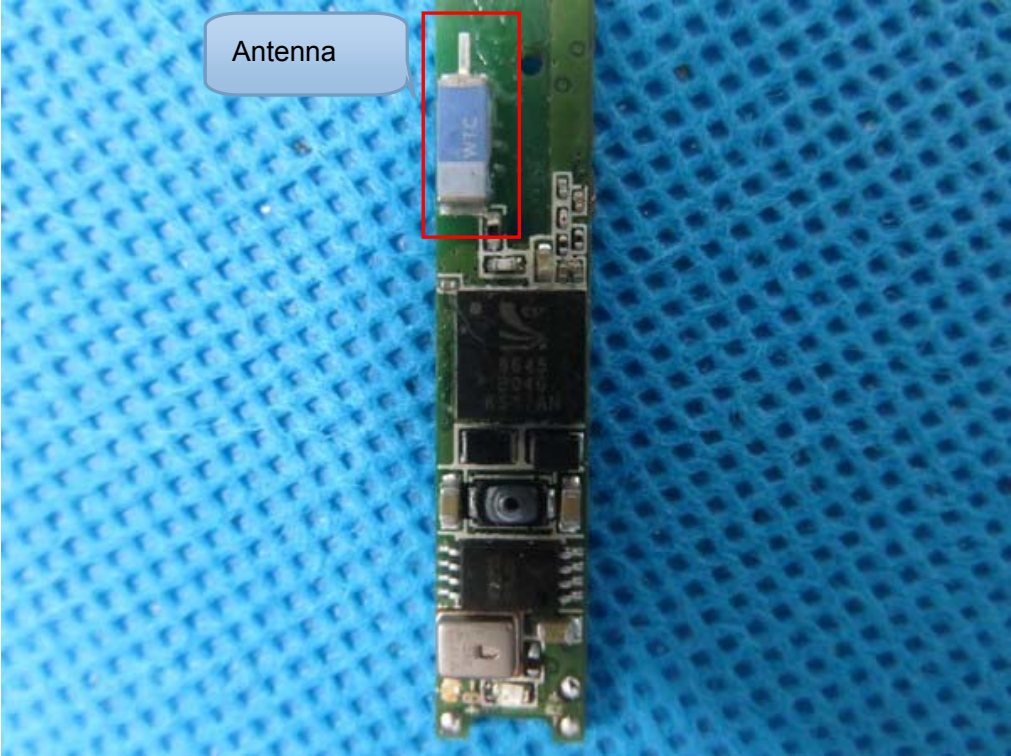

INTERNAL VIEW OF EUT-4

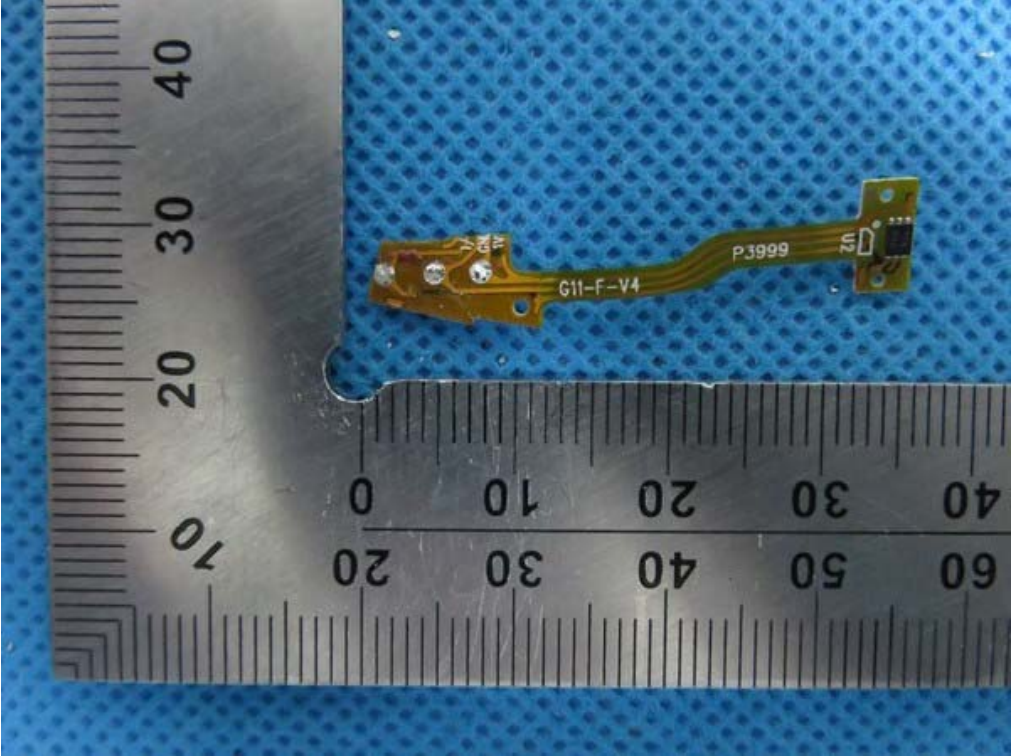

INTERNAL VIEW OF EUT-5

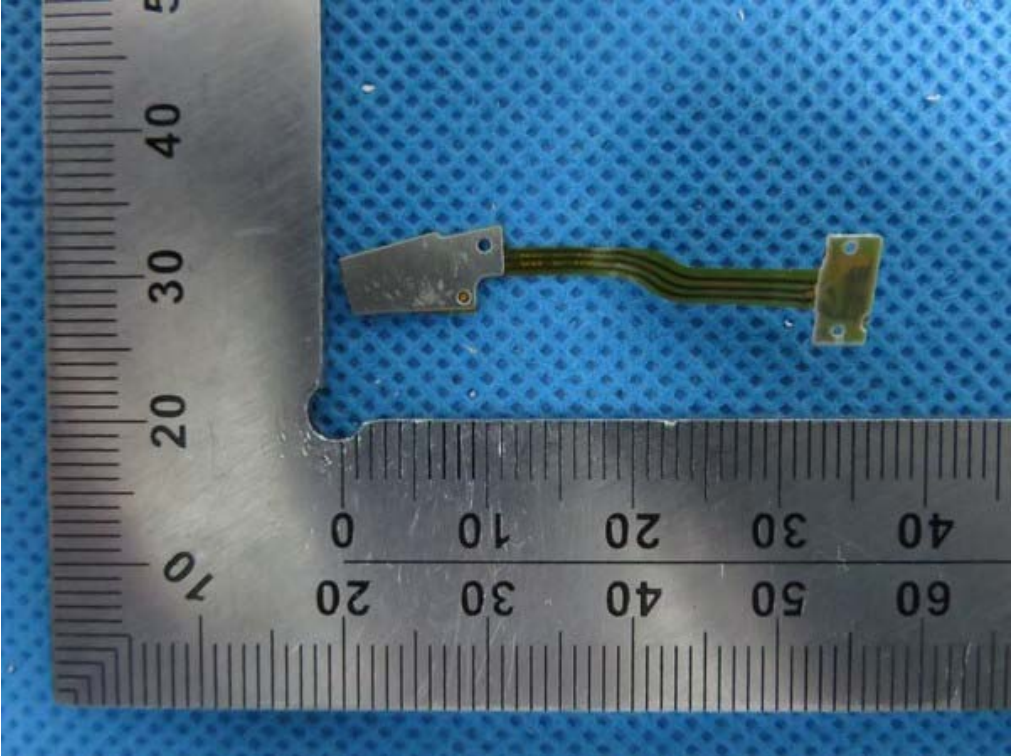

INTERNAL VIEW OF EUT-6

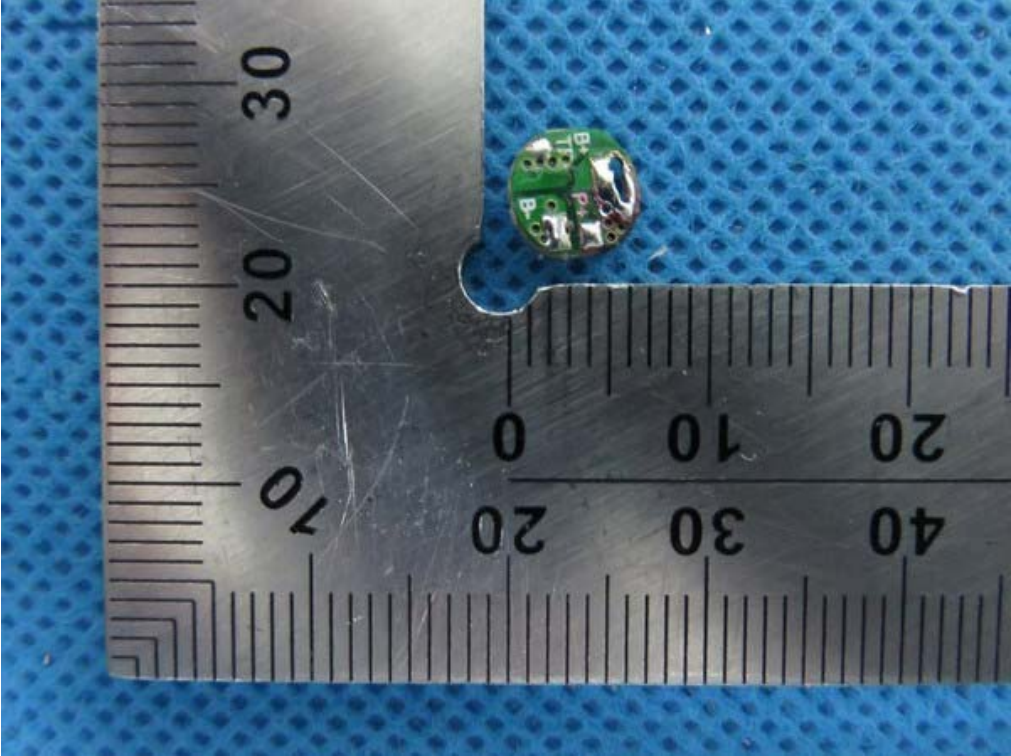

INTERNAL VIEW OF EUT-7

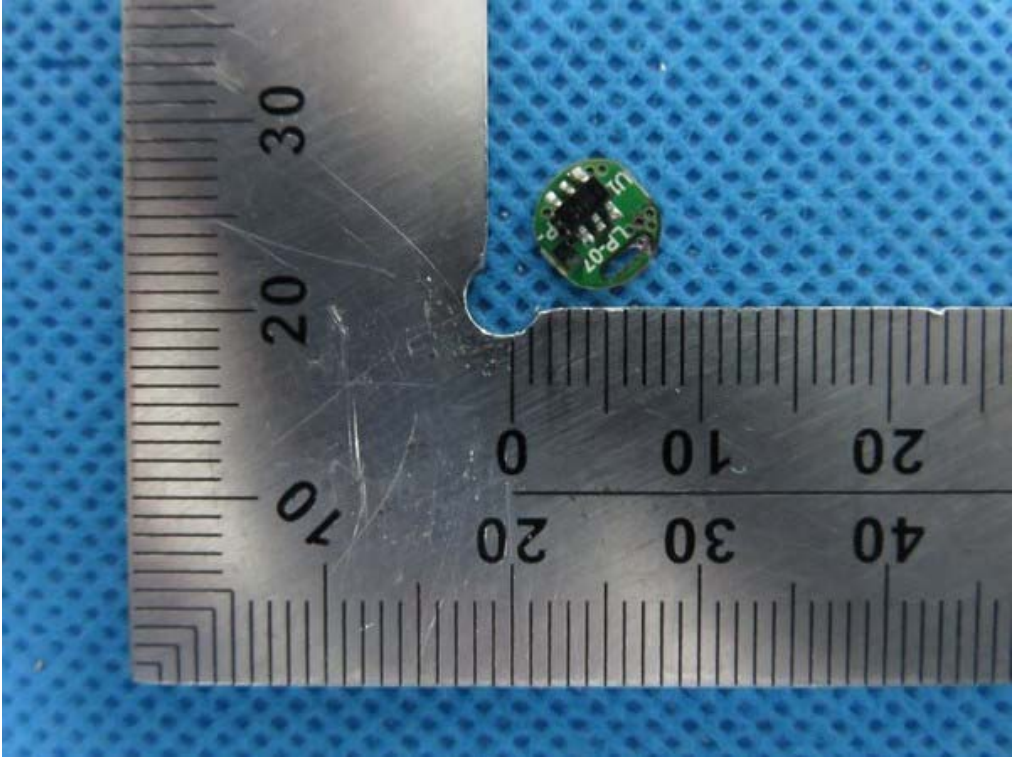

INTERNAL VIEW OF EUT-8

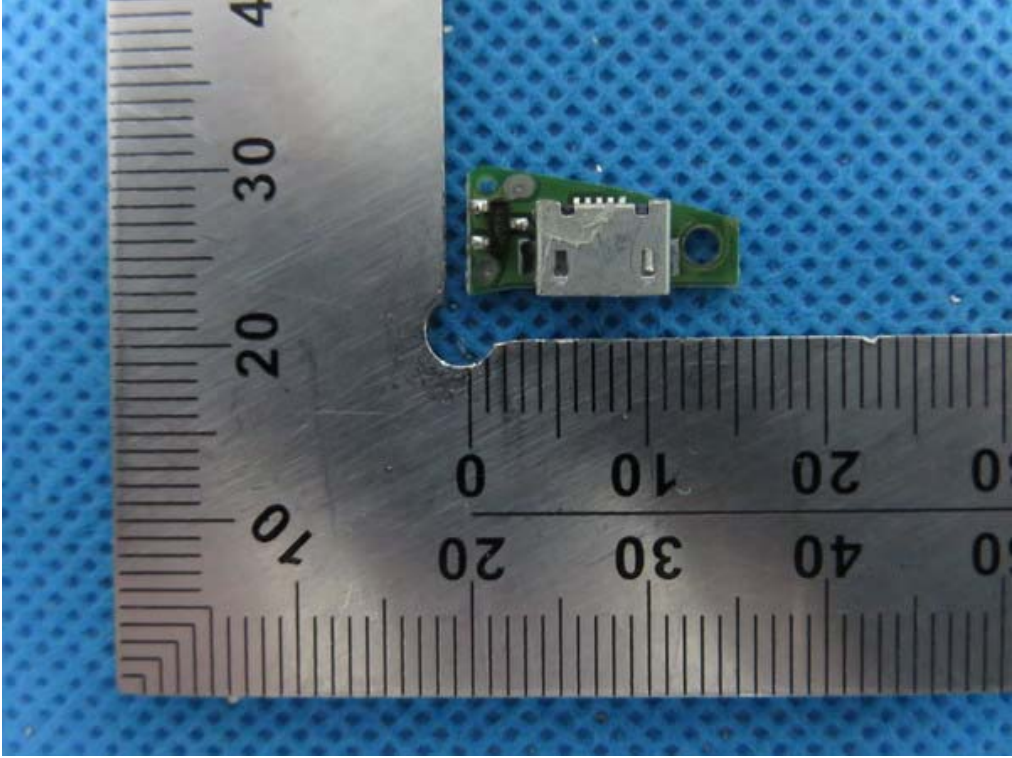

INTERNAL VIEW OF EUT-9

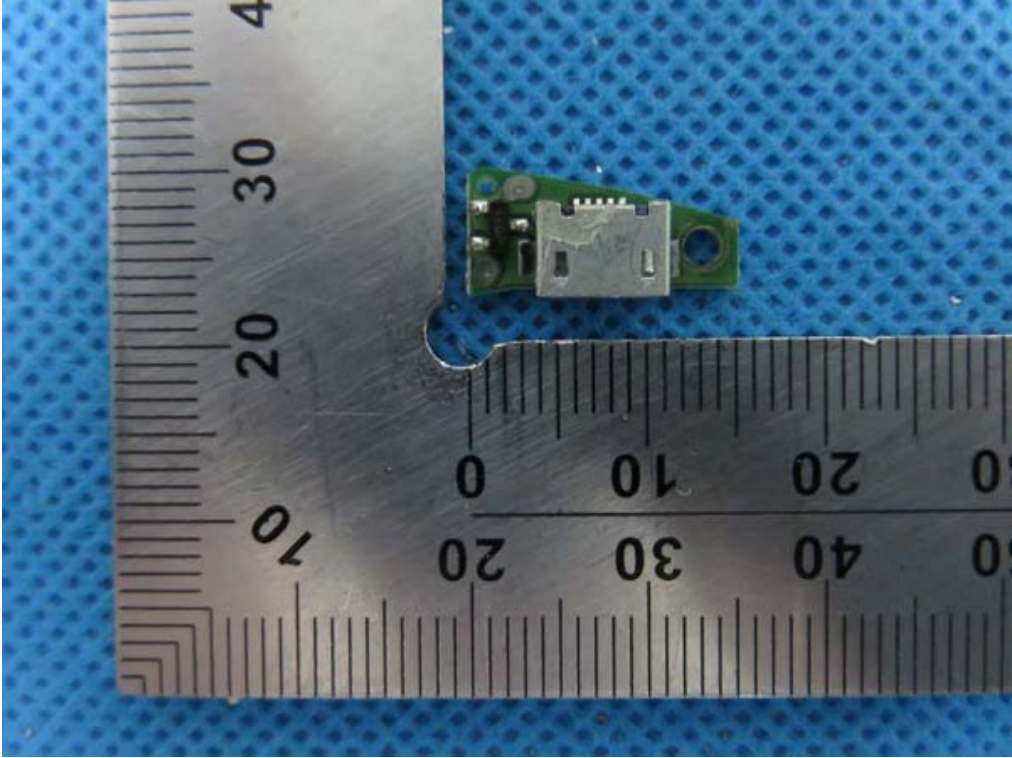

INTERNAL VIEW OF EUT-10

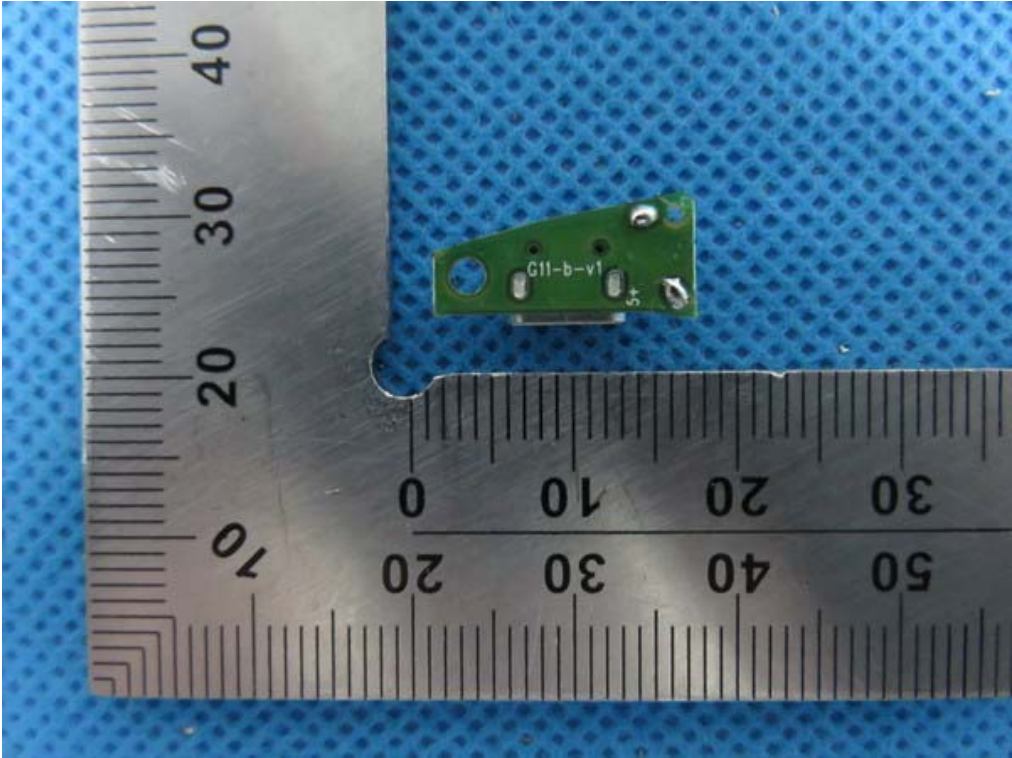

-----END OF REPORT-----