

# Test Report of FCC CFR 47 Part 15 Subpart C

On Behalf of

## Shenzhen Sande Dacom Electronics Co., Ltd

Building E, East District No.8, Shangxue Technology Park, Bantian, ShenZhen, China

Product Name:	<b>Sporty Stereo Bluetooth Headset</b>
Model/Type No.:	<b>G23S, UCOMX G01S, C100, OXOQO G19, VOTEC</b>
FCC ID:	<b>WTD-G23S</b>
Prepared By:	<b>Shenzhen Hongcai Testing Technology Co., Ltd.</b> 1st-3rd Floor, Building C, Shuanghuan Xin Yi Dai Hi-Tech Industrial Park, No.8 Baoqing Road, Baolong Industrial Zone, Longgang District, Shenzhen, Guangdong, China Tel: +86-755-86337020 Fax: +86-755-86337028
Report Number:	HCT16IR232E
Tested Date:	October 10~17, 2016
Issued Date:	October 31, 2016
Tested By:	Jerry Zhao/ <i>Jerry Zhao</i>

Reviewed By:

*Owen Yang*

Approved By:

*Tony Wu*

Owen.Yang

EMC Technical Supervisor

Tony Wu

EMC Technical Manager

**TABLE OF CONTENTS**

**1. GENERAL INFORMATION .....4**

1.1 PRODUCT DESCRIPTION FOR EQUIPMENT UNDER TEST (EUT) ..... 4

1.2 RELATED SUBMITTAL(S) / GRANT (S) AND TEST METHODOLOGY ..... 5

1.3 TEST FACILITY ..... 5

**2. SYSTEM TEST CONFIGURATION ..... 6**

2.1 EUT CONFIGURATION ..... 6

2.2 EUT EXERCISE ..... 6

2.3 GENERAL TEST PROCEDURES ..... 6

2.4 MEASUREMENT UNCERTAINTY ..... 6

2.5 MEASURE RESULTS EXPLANATION EXAMPLE ..... 7

2.6 TEST EQUIPMENT LIST AND DETAILS ..... 8

**3. SUMMARY OF TEST RESULTS ..... 8**

**4. TEST OF AC POWER LINE CONDUCTED EMISSION..... 9**

4.1 APPLICABLE STANDARD ..... 9

4.2 TEST SETUP DIAGRAM ..... 9

4.3 TEST RESULT ..... 9

**5. TEST OF HOPPING CHANNEL BANDWIDTH ..... 12**

5.1 APPLICABLE STANDARD ..... 12

5.2 EUT SETUP ..... 12

5.3 TEST EQUIPMENT LIST AND DETAILS ..... 12

5.4 TEST PROCEDURE ..... 12

5.5 TEST RESULT ..... 12

**6. TEST OF HOPPING CHANNEL SEPARATION..... 18**

6.1 APPLICABLE STANDARD ..... 18

6.2 EUT SETUP ..... 18

6.3 TEST EQUIPMENT LIST AND DETAILS ..... 18

6.4 TEST PROCEDURE ..... 18

6.5 TEST RESULT ..... 18

**7. TEST OF NUMBER OF HOPPING FREQUENCY ..... 25**

7.1 APPLICABLE STANDARD ..... 25

7.2 EUT SETUP ..... 25

7.3 TEST EQUIPMENT LIST AND DETAILS ..... 25

7.4 TEST PROCEDURE ..... 25

7.5 TEST RESULT ..... 25

**8. TEST OF DWELL TIME OF EACH FREQUENCY ..... 28**

8.1 APPLICABLE STANDARD ..... 28

8.2 EUT SETUP ..... 28

8.3 TEST EQUIPMENT LIST AND DETAILS ..... 28

8.4 TEST PROCEDURE ..... 28

8.5 TEST RESULT ..... 28

**9. TEST OF MAXIMUM PEAK OUTPUT POWER ..... 45**

9.1 APPLICABLE STANDARD ..... 45

9.2 EUT SETUP ..... 45

9.3 TEST EQUIPMENT LIST AND DETAILS ..... 45

9.4 TEST PROCEDURE ..... 45

9.5 TEST RESULT ..... 45

**10. TEST OF BAND EDGES EMISSION ..... 51**

10.1 APPLICABLE STANDARD ..... 51

10.2 EUT SETUP ..... 51

10.3 TEST EQUIPMENT LIST AND DETAILS ..... 51

10.4 TEST PROCEDURE ..... 51

10.5 TEST RESULT ..... 52

**11. TEST OF SPURIOUS RADIATED EMISSION .....58**  
11.1 APPLICABLE STANDARD ..... 58  
11.2 EUT SETUP ..... 58  
11.3 TEST EQUIPMENT LIST AND DETAILS ..... 59  
11.4 TEST PROCEDURE ..... 59  
11.5 TEST RESULT ..... 60

**12. ANTENNA REQUIREMENT ..... 75**  
12.1 STANDARD APPLICABLE ..... 75  
12.2 ANTENNA CONNECTED CONSTRUCTION ..... 75

**13 .RADIO FREQUENCY EXPOSURE ..... 76**  
13.1 APPLICABLE STANDARD ..... 76  
13.2 LIMIT ..... 76  
13.3 RF EXPOSURE ..... 77  
13.4 CONCLUSION ..... 78



# 1. GENERAL INFORMATION

## 1.1 Product Description for Equipment Under Test (EUT)

### Client Information

Applicant:	<b>Shenzhen Sande Dacom Electronics Co., Ltd</b>
Address of applicant:	Building E, East District No.8, Shangxue Technology Park, Bantian, ShenZhen, China
Manufacturer :	<b>Shenzhen Sande Dacom Electronics Co., Ltd</b>
Address of manufacturer:	Building E, East District No.8, Shangxue Technology Park, Bantian, ShenZhen, China

### General Description of E.U.T

Items	Description
EUT Description:	Sporty Stereo Bluetooth Headset
Model No.:	G23S
Supplementary Model:	UCOMX G01S, C100, OXOQO G19, VOTEC
BT Version	BT4.1
Frequency Band:	2402~2480MHz
Number of Channels:	79 for BR/EDR
Type of Modulation:	GFSK, Pi/4 DQPSK, 8-DPSK
Antenna Gain	2 dBi
Antenna Type:	Internal Antenna
Rated Voltage:	Input: DC 5V/1A from micro USB

Remark: \* The test data gathered are from the production sample provided by the manufacturer.  
 \* Supplementary models have the same base board circuit, the appearance is different.

## 1.2 Related Submittal(s) / Grant (s) and Test Methodology

FCC Rules Part 15.247: Frequency Hopping, Direct Spread Spectrum and Hybrid Systems that are in operation within the bands of 902-928 MHz, 2400-2483.5 MHz, and 5725-5850 MHz.

ANSI C63.10-2013: American National Standard for Testing Unlicensed Wireless Devices.

DA 00-705: Filing and Measurement Guidelines for Frequency Hopping Spread Spectrum Systems

## 1.3 Test Facility

All measurement required was performed at laboratory of Shenzhen CTL Testing Technology Co., Ltd. Floor 1-A, Baisha Technology Park, No. 3011, Shahexi Road, Nanshan, Shenzhen 518055 China. There is one 3m semi-anechoic chamber and two line conducted labs for final test. The Test Sites meet the requirements in documents ANSI C63.4 and CISPR 22/EN 55022 requirements.

FCC – Registration No.: 970318

Shenzhen CTL Testing Technology Co., Ltd. EMC Laboratory has been registered and fully described in a report filed with the (FCC) Federal Communications Commission. The acceptance letter from the FCC is maintained in our files. Registration 970318, December, 2013.

IC Registration No.: 9618B

The 3m alternate test site of Shenzhen CTL Testing Technology Co., Ltd. EMC Laboratory has been registered by Certification and Engineer Bureau of Industry Canada for the performance of with Registration No.: 9618B on November 13, 2013.

HONGCAI TESTING

## 2. SYSTEM TEST CONFIGURATION

### 2.1 EUT Configuration

The EUT configuration for testing is installed on RF field strength measurement to meet the Commissions requirement and operating in a manner that intends to maximize its emission characteristics in a continuous normal application.

### 2.2 EUT Exercise

The calibrated antennas used to sample the radiated field strength are mounted on a non-conductive, motorized antenna mast 3 or 10 meters from the leading edge of the turntable.

### 2.3 General Test Procedures

**Conducted Emissions:** The EUT is placed on the table, which is 0.8 m above ground plane According to the requirements in ANSI C63.10-2013 Conducted emissions from the EUT measured in the frequency range between 0.15 MHz and 30MHz using CISPR Quasi-Peak detector mode.

**Radiated Emissions:** The EUT is a placed on as turntable, which is 0.8 m above ground plane. The turntable shall rotate 360 degrees to determine the position of maximum emission level. EUT is set 3m away from the receiving antenna, which varied from 1m to 4m to find out the highest emission. And also, each emission was to be maximized by changing the polarization of receiving antenna both horizontal and vertical. In order to find out the maximum emissions, exploratory radiated emission measurements were made according to the requirements in ANSI C63.10-2013.

### 2.4 Measurement Uncertainty

The data and results referenced in this document are true and accurate. The reader is cautioned that there may be errors within the calibration limits of the equipment and facilities. The measurement uncertainty was calculated for all measurements listed in this test report acc. to CISPR 16 - 4 "Specification for radio disturbance and immunity measuring apparatus and methods – Part 4: Uncertainty in EMC Measurements" and is documented in the Shenzhen CTL Testing Technology Co., Ltd. quality system acc. to DIN EN ISO/IEC 17025. Furthermore, component and process variability of devices similar to that tested may result in additional deviation. The manufacturer has the sole responsibility of continued compliance of the device.

Where relevant, the following measurement uncertainty levels have been estimated for tests performed on the apparatus:

Parameter	Uncertainty
Transmitter power conducted	+/- 0.57 dB
Transmitter power Radiated	+/- 2.20 dB
Conducted spurious emission 9KHz-40 GHz	+/- 2.20 dB
Power Line Conducted Emission	+/- 3.20 dB
Radiated Emission	+/- 4.32 dB

Note: This uncertainty represents an expanded uncertainty expressed at approximately the 95% confidence level using a coverage factor of k=2.



## 2.5 Measure Results Explanation Example

For all conducted test items:

The offset level is set in the spectrum analyzer to compensate the RF cable loss and attenuator factor between EUT conducted output port and spectrum analyzer. With the offset compensation, the spectrum analyzer reading level is exactly the EUT RF output level.

The spectrum analyzer offset is derived from RF cable loss and attenuator factor.  
 $\text{Offset} = \text{RF cable loss} + \text{attenuator factor}$

Note: Using a temporary antenna connector for the EUT when the conducted measurements are performed.

Equipment	Manufacturer	Model No.	Frequency range(GHz)	Attenuation values(dBm)
Line	Zhenjiang south electronic	RG316	1-12	0.08
Connector	Zhenjiang south electronic	SMA-K/N-J	1-12	0.01

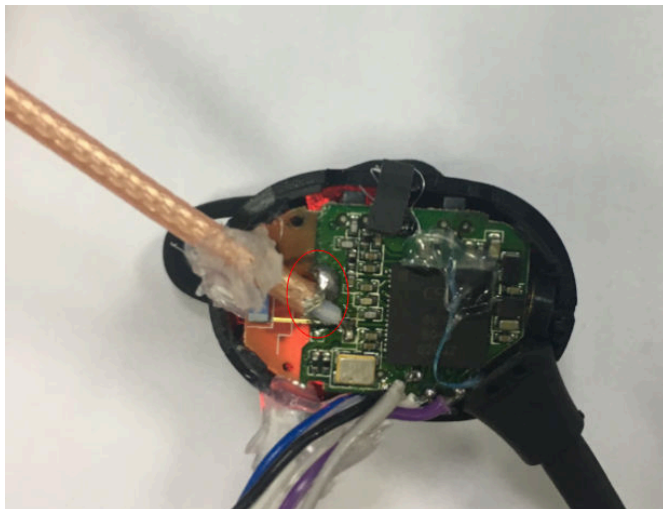
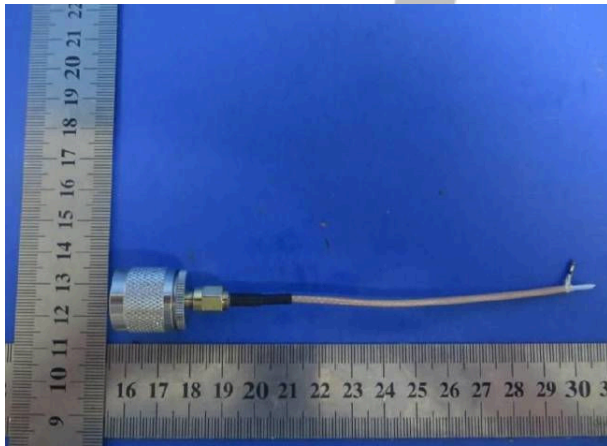

## 2.6 Test Equipment List and Details

Test equipments list of Shenzhen CTL Testing Technology Co., Ltd.

No.	Instrument no.	Equipment	Manufacturer	Model No.	S/N	Last Calculator	Due Calculator
1	BCT-EMC001	EMI Test Receiver	R&S	ESCI	100687	2016-7-25	2017-7-24
2	BCT-EMC002	EMI Test Receiver	R&S	ESPI	100097	2015-11-1	2016-10-31
3	BCT-EMC003	Amplifier	HP	8447D	1937A02492	2016-7-25	2017-7-24
4	BCT-EMC018	TRILOG Broadband Test-Antenna	SCHWARZBECK	VULB9163	9163-324	2016-7-25	2017-7-24
5	BCT-EMC021	Triple-Loop Antenna	EVERFINE	LLA-2	711002	2015-11-1	2016-10-31
6	BCT-EMC026	RF POWER AMPLIFIER	FRANKONIA	FLL-75	1020A1109	2016-7-25	2017-7-24
7	BCT-EMC029	6DB Attenuator	FRANKONIA	N/A	1001698	2016-7-25	2017-7-24
8	BCT-EMC032	10dB attenuator	ELECTRO-METRICS	EM-7600	836	2016-7-25	2017-7-24
9	BCT-EMC036	Spectrum Analyzer	R&S	FSP	100397	2015-11-1	2016-10-31
10	BCT-EMC037	Broadband preamplifier	SCHWARZBECK	BBV9718	9718-182	2016-7-25	2017-7-24
11	BCT-EMC039	Horn Antenna	SCHWARZBECK	BBHA 9120D	0437	2016-7-25	2017-7-24
12	BCT-EMC038	Horn Antenna	SCHWARZBECK	BBHA9170	0483	2016-7-25	2017-7-24

## 3. SUMMARY OF TEST RESULTS

FCC Rules	Description of Test	Result
FCC §15.207	AC Power Line Conducted Emission	Pass
FCC §15.247(a)(1)	Hopping Channel Bandwidth	Pass
FCC §15.247(a)(1)	Hopping Channel Separation	Pass
FCC §15.247(a)(1)	Number of Hopping Frequency Used	Pass
FCC §15.247(a)(1)(iii)	Dwell Time of Each Frequency	Pass
FCC §15.247(b)(1)	Maximum Peak Output Power	Pass
FCC §15.247(d)	Band Edges Emission	Pass
FCC §15.247(d)	Spurious Radiated Emission	Pass
FCC §15.203/15.247(b)/(c)	Antenna Requirement	Pass



## 4. TEST OF AC POWER LINE CONDUCTED EMISSION

### 4.1 Applicable Standard

Refer to FCC §15.207.

For a Low-power Radio-frequency Device is designed to be connected to the AC power line, the radio frequency voltage that is conducted back onto the AC power line on any frequency or frequencies within the band 150 kHz to 30 MHz shall not exceed below limits table.

Frequency Range (MHz)	Limits ( dBuV)	
	Quasi-Peak	Average
0.150~0.500	66~56	56~46
0.500~5.000	56	46
5.000~30.00	60	50

### 4.2 Test Setup Diagram

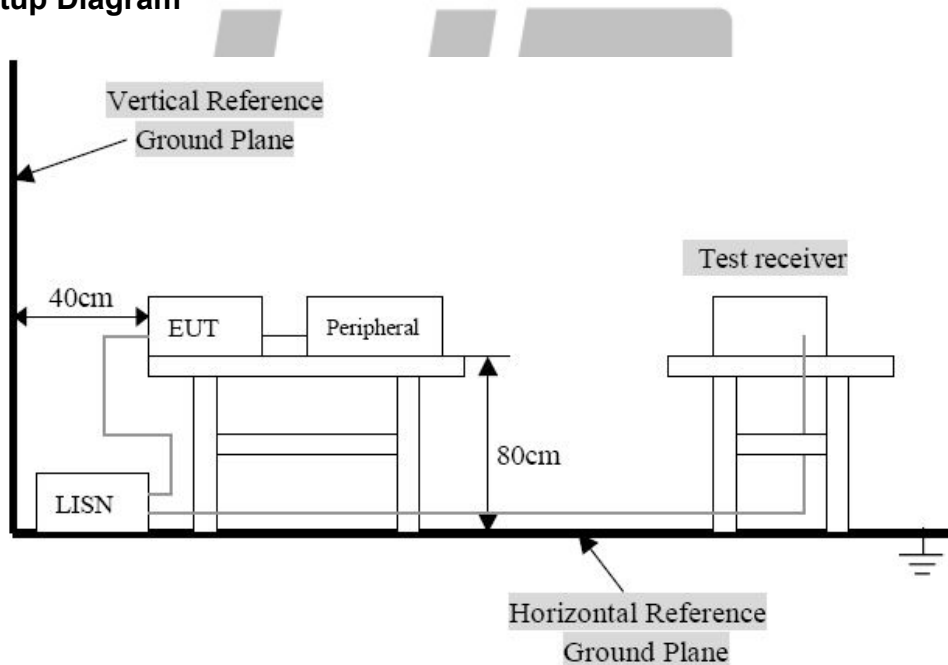

Remark: The EUT was connected to a 120 VAC/ 60Hz power source.

### 4.3 Test Result

Temperature ( °C ) : 23~25	EUT: Sporty Stereo Bluetooth Headset
Humidity (%RH) : 45~58	M/N: G23S
Barometric Pressure ( mbar ) : 950~1000	Operation Condition: Tx Mode

**Conducted Emission:**

EUT: Sporty Stereo Bluetooth Headset  
 M/N: G23S  
 Operating Condition: Tx Mode  
 Test Site: Shielded Room  
 Operator: Yang  
 Test Specification: DC 5V/1A from micro USB  
 Comment: L Line

**SCAN TABLE: "Voltage (150K-30M) FIN"**  
 Short Description: 150K-30M Voltage

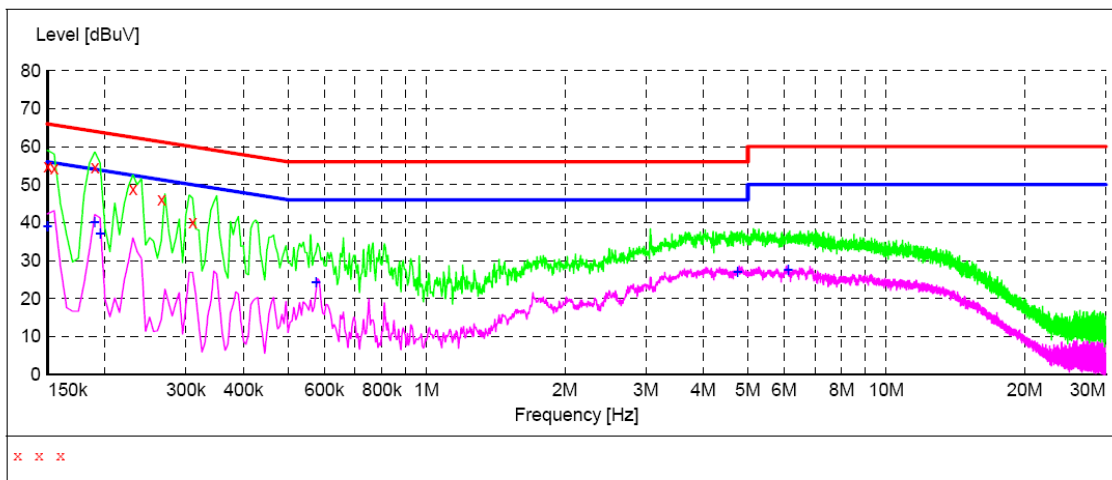

**MEASUREMENT RESULT :**

Frequency MHz	Level dBuV	Transd dB	Limit dBuV	Margin dB	Detector	Line	PE
0.150000	54.70	15.4	66	11.3	QP	L1	GND
0.155000	54.30	15.4	66	11.4	QP	L1	GND
0.190000	54.50	15.0	64	9.5	QP	L1	GND
0.230000	48.90	14.3	62	13.5	QP	L1	GND
0.265000	46.10	13.0	61	15.2	QP	L1	GND
0.310000	40.00	11.0	60	20.0	QP	L1	GND

**MEASUREMENT RESULT :**

Frequency MHz	Level dBuV	Transd dB	Limit dBuV	Margin dB	Detector	Line	PE
0.150000	39.00	15.4	56	17.0	AV	L1	GND
0.190000	40.00	15.0	54	14.0	AV	L1	GND
0.195000	37.10	15.0	54	16.7	AV	L1	GND
0.575000	24.30	10.4	46	21.7	AV	L1	GND
4.755000	27.10	13.4	46	18.9	AV	L1	GND
6.120000	27.40	12.6	50	22.6	AV	L1	GND

**Conducted Emission:**

EUT: Sporty Stereo Bluetooth Headset  
M/N: G23S  
Operating Condition: Tx Mode  
Test Site: Shielded Room  
Operator: Yang  
Test Specification: DC 5V/1A from micro USB  
Comment: N Line

**SCAN TABLE: "Voltage (150K-30M) FIN"**

Short Description: 150K-30M Voltage

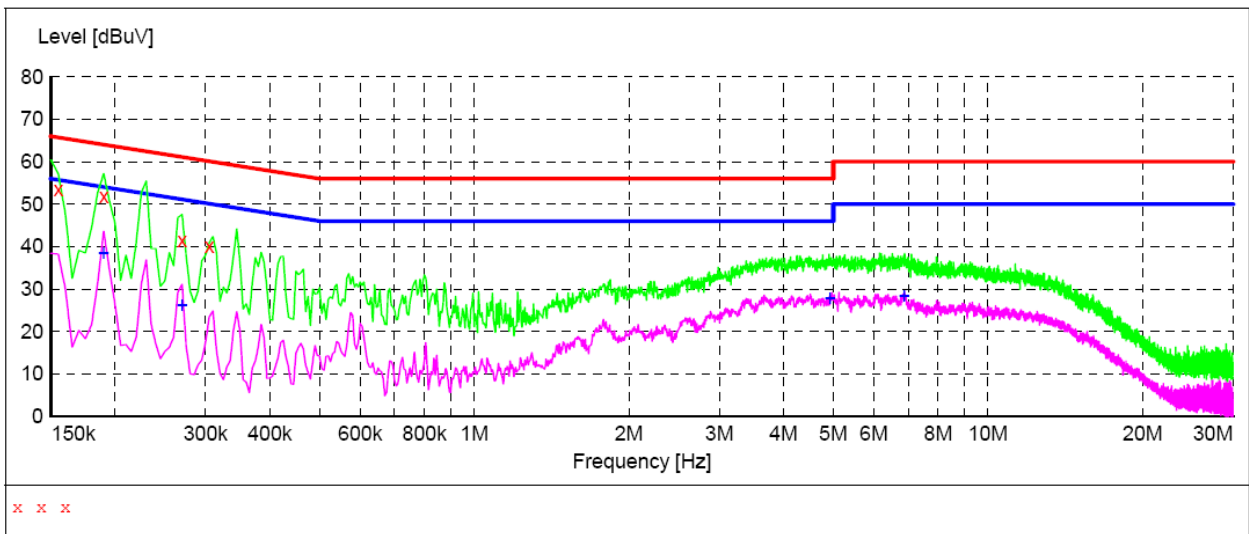

**MEASUREMENT RESULT:**

Frequency MHz	Level dBuV	Transd dB	Limit dBuV	Margin dB	Detector	Line	PE
0.155000	53.40	15.4	66	12.3	QP	N	GND
0.190000	51.70	15.0	64	12.3	QP	N	GND
0.270000	41.50	12.7	61	19.6	QP	N	GND
0.305000	40.00	11.0	60	20.1	QP	N	GND

**MEASUREMENT RESULT:**

Frequency MHz	Level dBuV	Transd dB	Limit dBuV	Margin dB	Detector	Line	PE
0.190000	38.40	15.0	54	15.6	AV	N	GND
0.270000	26.30	12.7	51	24.8	AV	N	GND
4.925000	27.80	13.5	46	18.2	AV	N	GND
6.875000	28.40	13.4	50	21.6	AV	N	GND

## 5. Test of Hopping Channel Bandwidth

### 5.1 Applicable Standard

Section 15.247(a)(1): Frequency hopping systems shall have hopping channel carrier frequencies separated by a minimum of 25 kHz or the 20 dB bandwidth of the hopping channel, whichever is greater.

### 5.2 EUT Setup

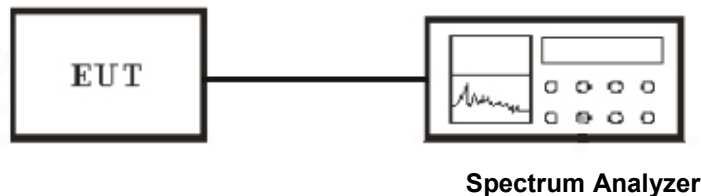

### 5.3 Test Equipment List and Details

See section 2.5.

### 5.4 Test Procedure

1. The transmitter output was connected to the spectrum analyzer through an attenuator.
2. Use the following spectrum analyzer settings:  
 Span = approximately 2 to 3 times the 20 dB bandwidth, centered on a hopping channel  
 RBW  $\geq$  1% of the 20 dB bandwidth, VBW  $\geq$  RBW  
 Sweep = auto  
 Detector function = peak  
 Trace = max hold
3. The spectrum width with level higher than 20dB below the peak level.
4. Repeat above 1~3 points for the middle and highest channel of the EUT.

### 5.5 Test Result

Temperature ( °C ) : 22~23	EUT: Sparty Stereo Bluetooth Headset
Humidity (%RH) : 50~54	M/N: G23S
Barometric Pressure ( mbar ) : 950~1000	Operation Condition: Tx Mode

**BR 1M**

Modulation Type	Channel No.	Frequency (MHz)	20dB Bandwidth (kHz)
GFSK	Low	2402.00	940
GFSK	Middle	2441.00	924
GFSK	High	2480.00	960

**EDR 2M**

Modulation Type	Channel No.	Frequency (MHz)	20dB Bandwidth (kHz)
Pi/4 DQPSK	Low	2402.00	1292
Pi/4 DQPSK	Middle	2441.00	1280
Pi/4 DQPSK	High	2480.00	1300

**EDR 3M**

Modulation Type	Channel No.	Frequency (MHz)	20dB Bandwidth (kHz)
8-DPSK	Low	2402.00	1204
8-DPSK	Middle	2441.00	1204
8-DPSK	High	2480.00	1204

**BR 1M  
Channel Low**



### Channel Middle

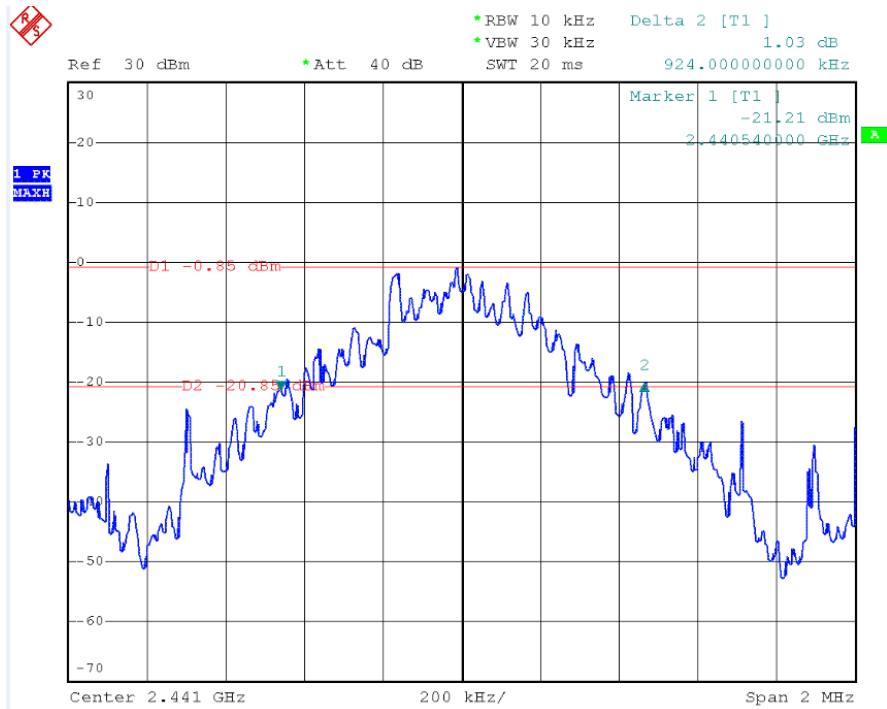

### Channel High

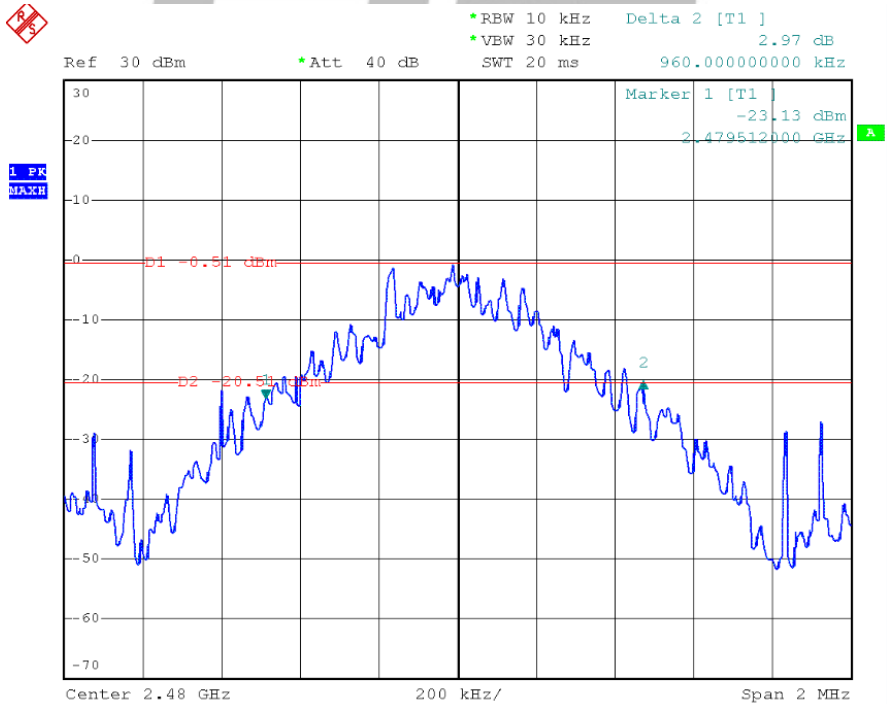



### EDR 2M Channel Low

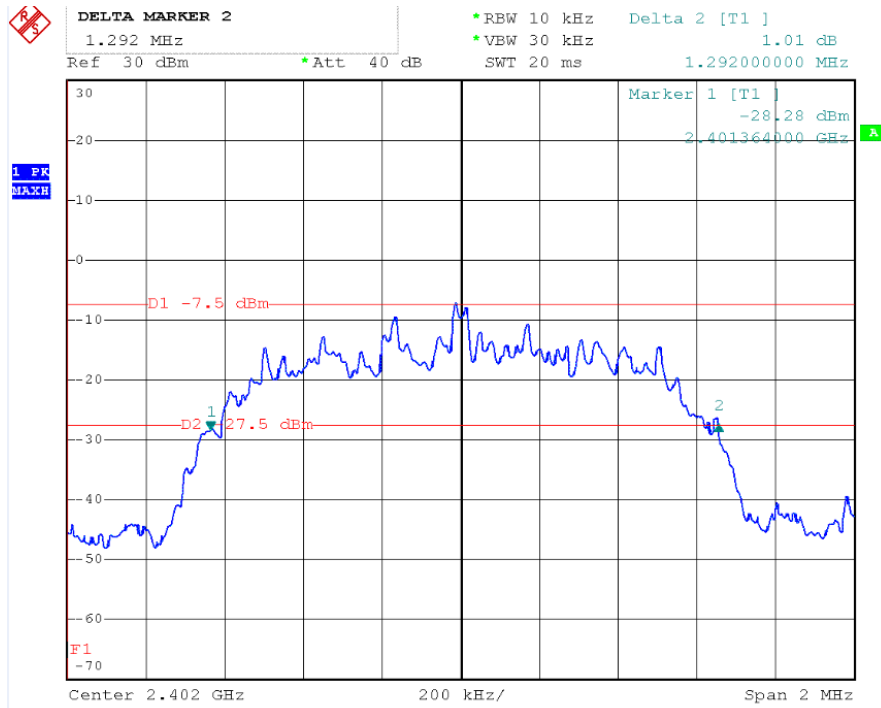

### Channel Middle

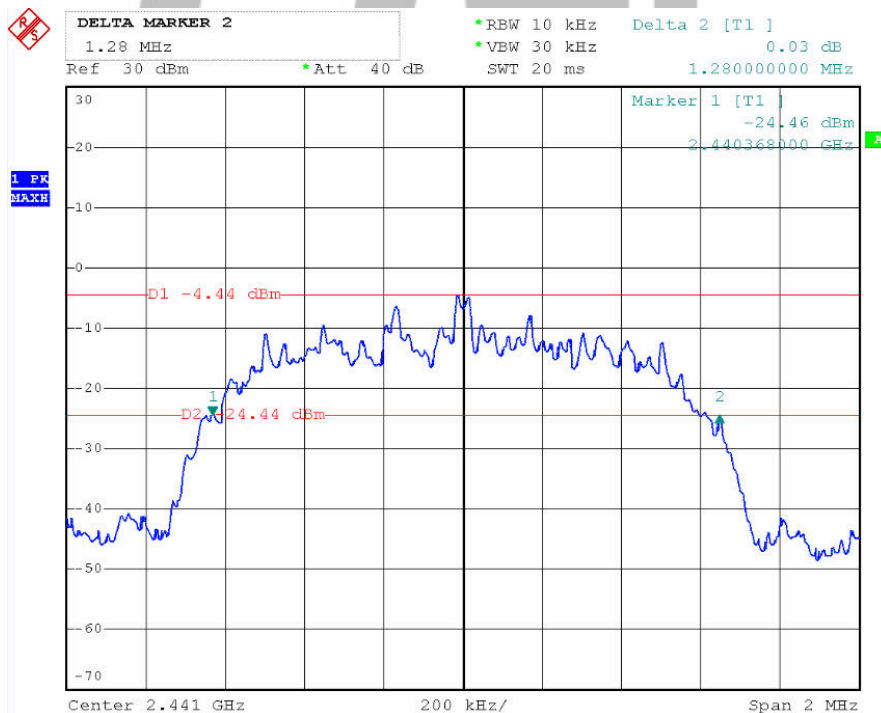

### Channel High

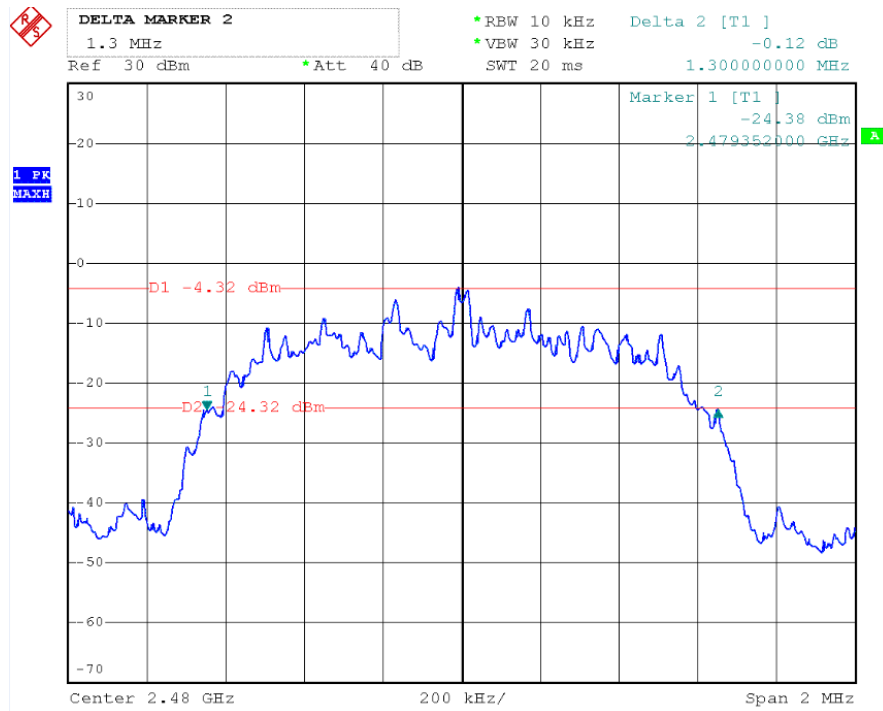

### EDR 3M Channel Low

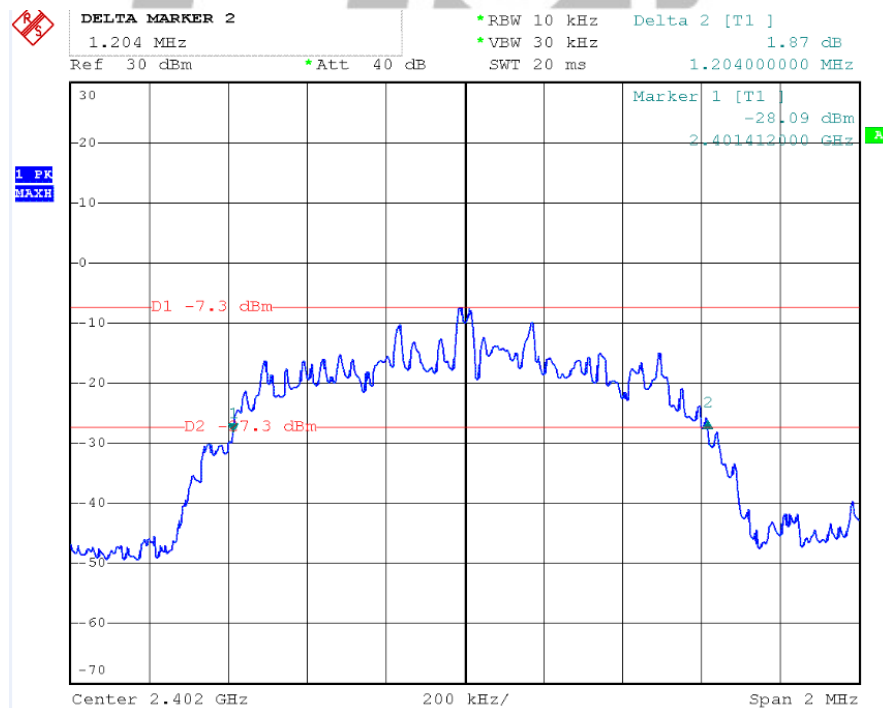

### Channel Middle

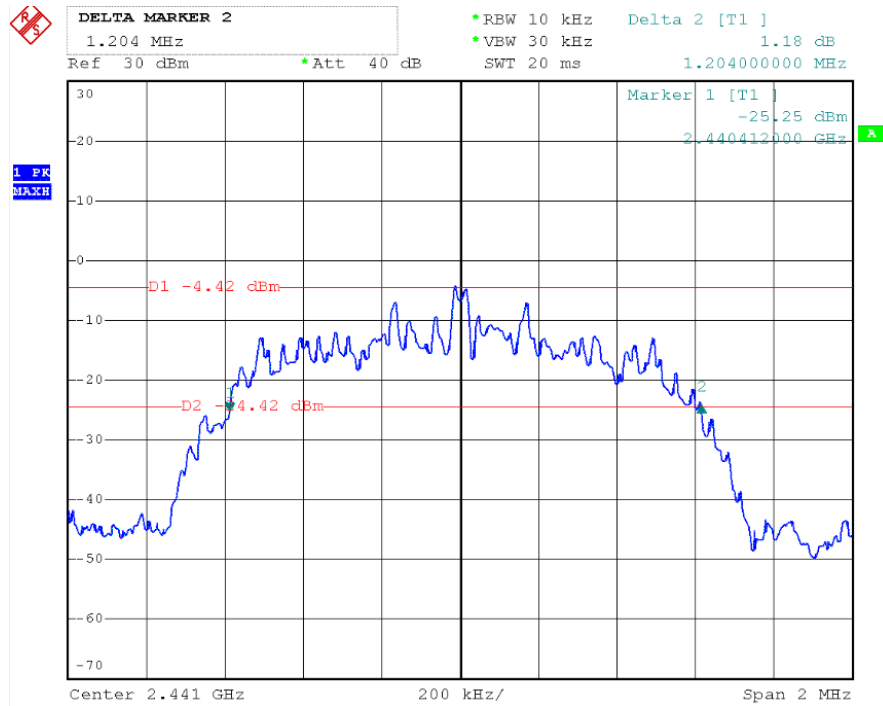

### Channel High

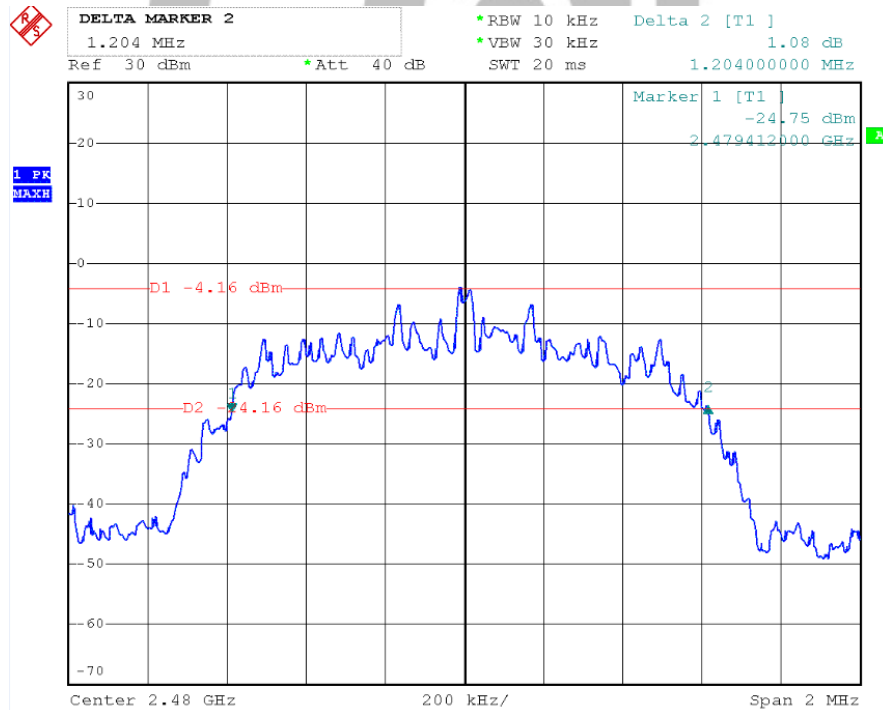

## 6. Test of Hopping Channel Separation

### 6.1 Applicable Standard

Section 15.247(a)(1): Frequency hopping systems shall have hopping channel carrier frequencies separated by a minimum of 25 kHz or the 20 dB bandwidth of the hopping channel, whichever is greater.

### 6.2 EUT Setup

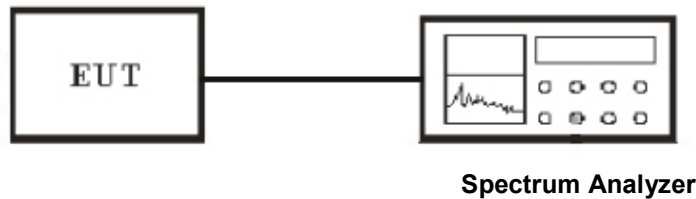

### 6.3 Test Equipment List and Details

See section 2.5.

### 6.4 Test Procedure

1. The transmitter output was connected to the spectrum analyzer through an attenuator.
2. Set RBW of spectrum analyzer to 30KHz and VBW to 100KHz.
3. Set Detector to Peak, Trace to Max Hold and Sweep Time is Auto.
4. The Hopping Channel Separation is defined as the separation between 2 neighboring hopping frequencies.
5. Repeat above 1~3 points for the middle and highest channel of the EUT.

### 6.5 Test Result

Temperature ( °C ) : 22~23	EUT: Sporty Stereo Bluetooth Headset
Humidity (%RH) : 50~54	M/N: G23S
Barometric Pressure ( mbar ) : 950~1000	Operation Condition: Tx Mode

**BR 1M**

Modulation Type	Frequency (MHz)	Channel Separation (MHz)	Min. Limit (kHz)
GFSK	2402~2403	1.000	>25
GFSK	2441~2442	1.000	>25
GFSK	2479~2480	1.000	>25

**EDR 2M**

Modulation Type	Frequency (MHz)	Channel Separation (MHz)	Min. Limit (kHz)
Pi/4 DQPSK	2402~2403	1.008	>25
Pi/4 DQPSK	2441~2442	1.000	>25
Pi/4 DQPSK	2479~2480	1.000	>25

**EDR 3M**

Modulation Type	Frequency (MHz)	Channel Separation (MHz)	Min. Limit (kHz)
8-DPSK	2402~2403	1.008	>25
8-DPSK	2441~2442	1.000	>25
8-DPSK	2479~2480	1.000	>25

HONGCAI TESTING

### BR 1M Channel Low

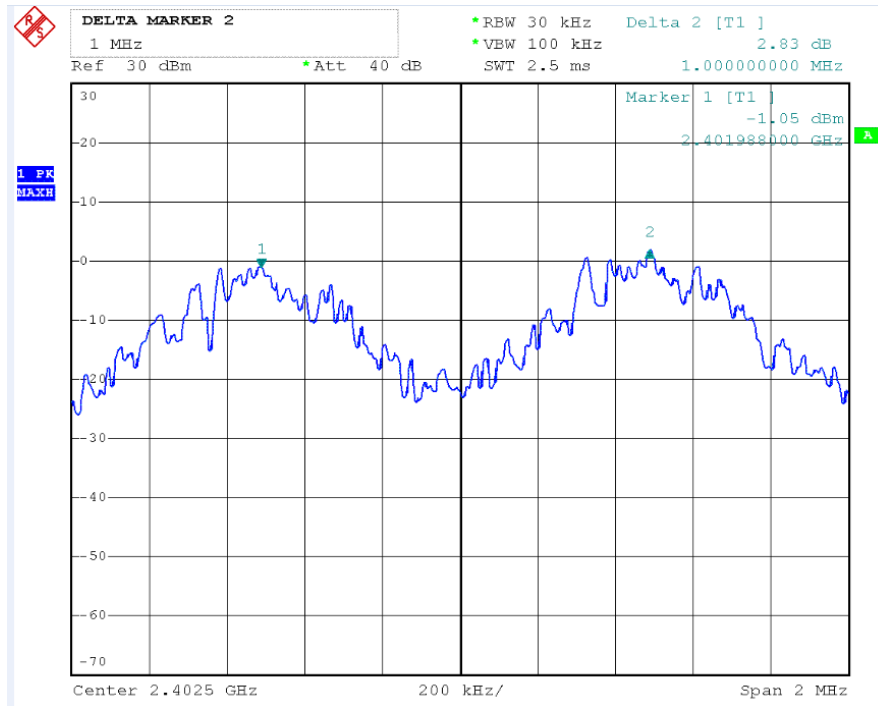

### Channel Middle

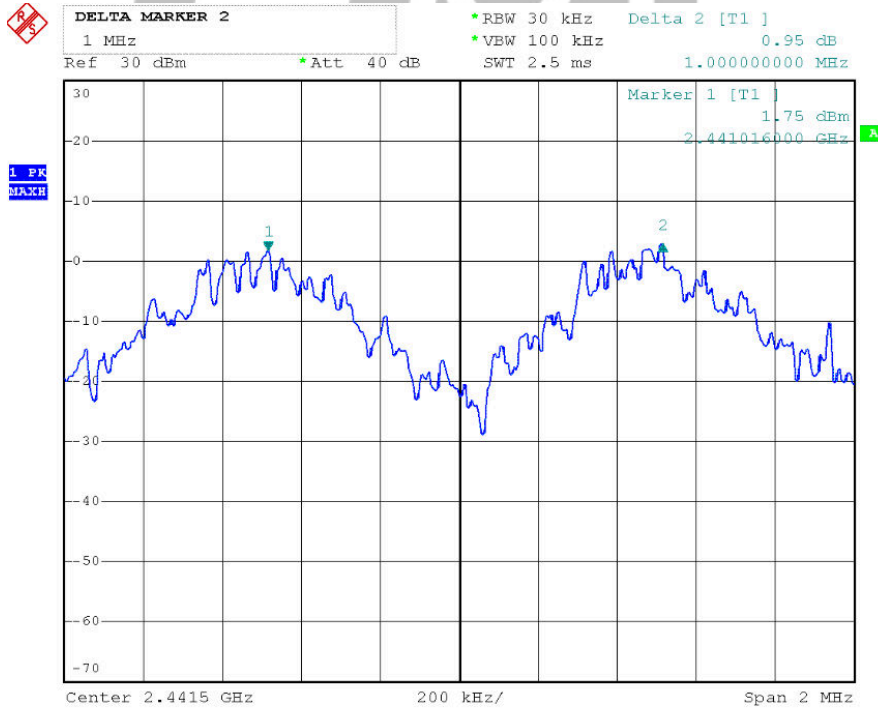



### Channel High

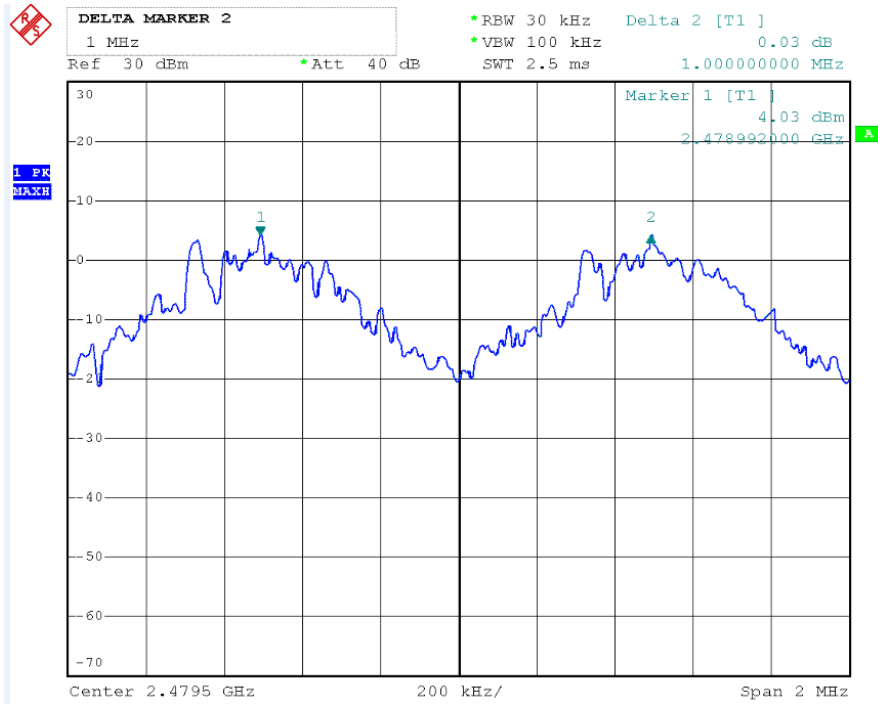

### EDR 2M Channel Low

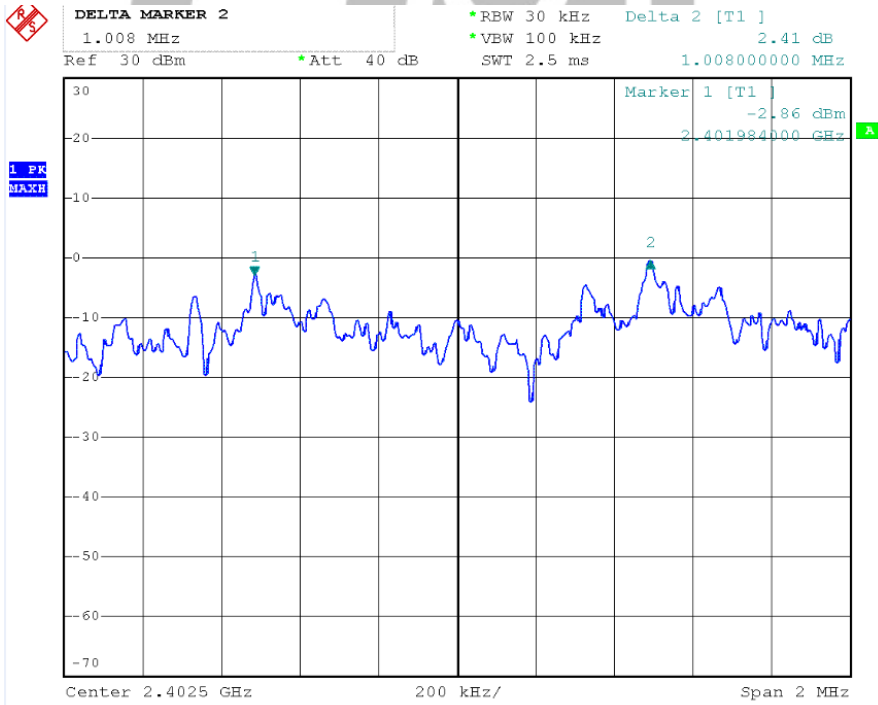

### Channel Middle

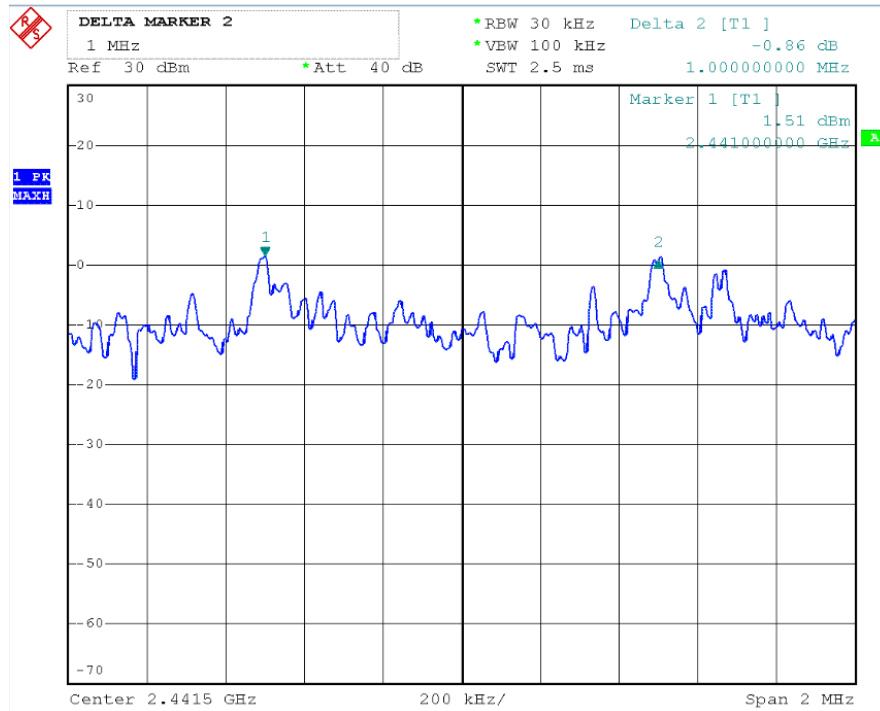

### Channel High

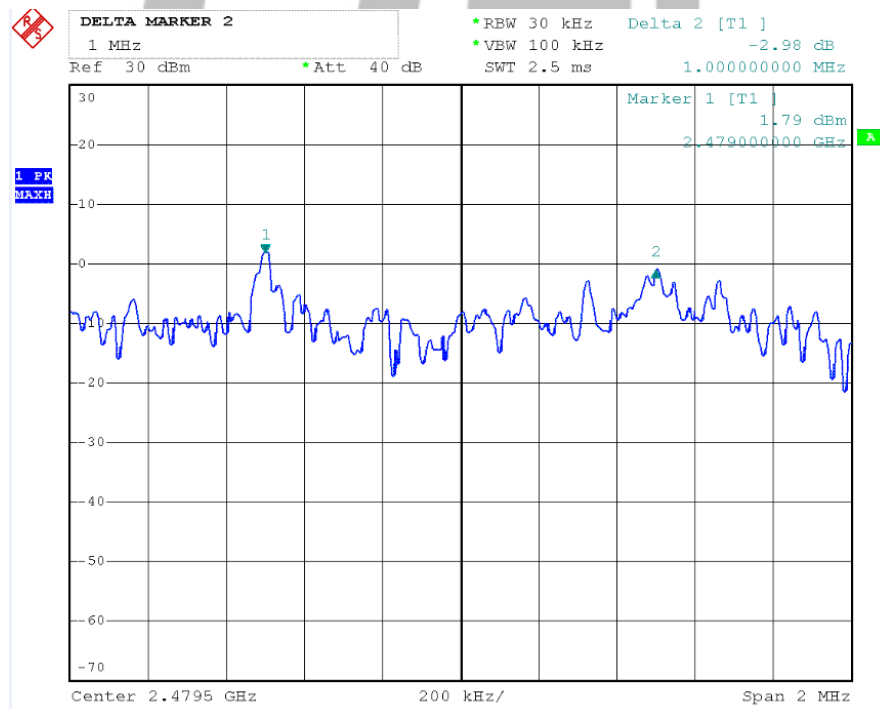

### EDR 3M Channel Low

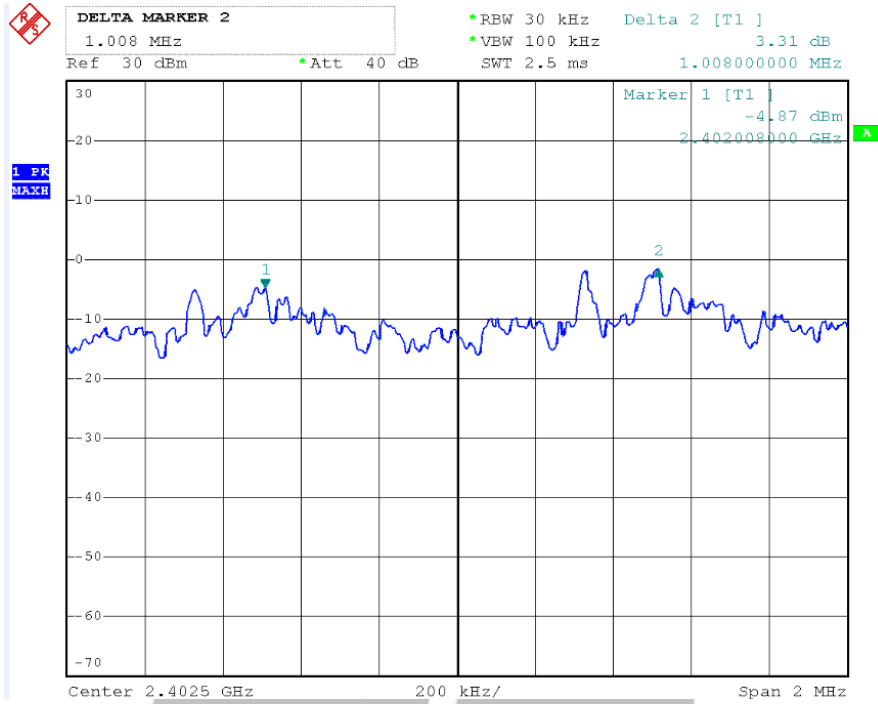

### Channel Middle

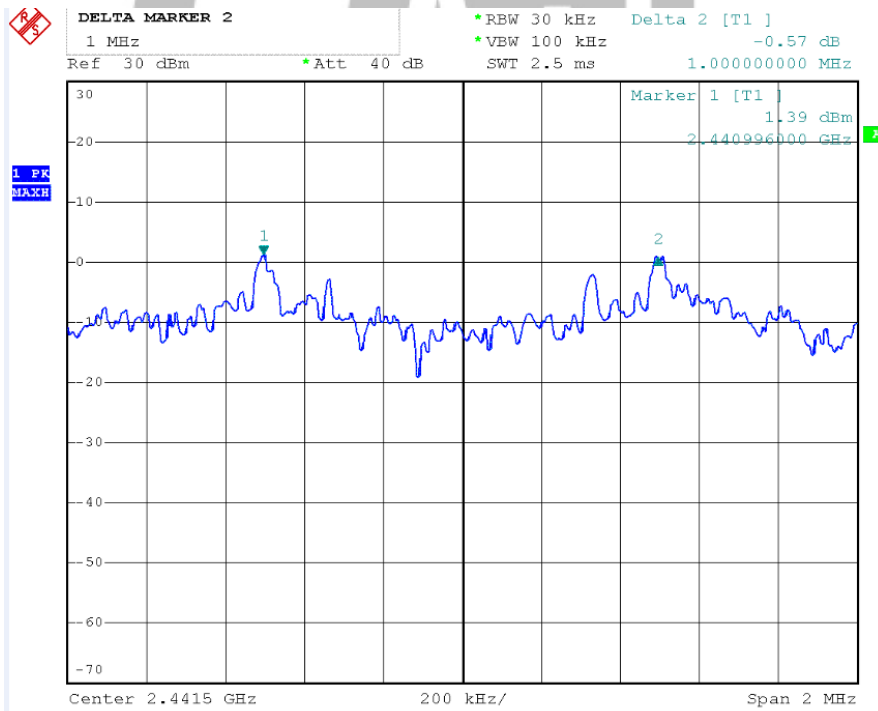

### Channel High

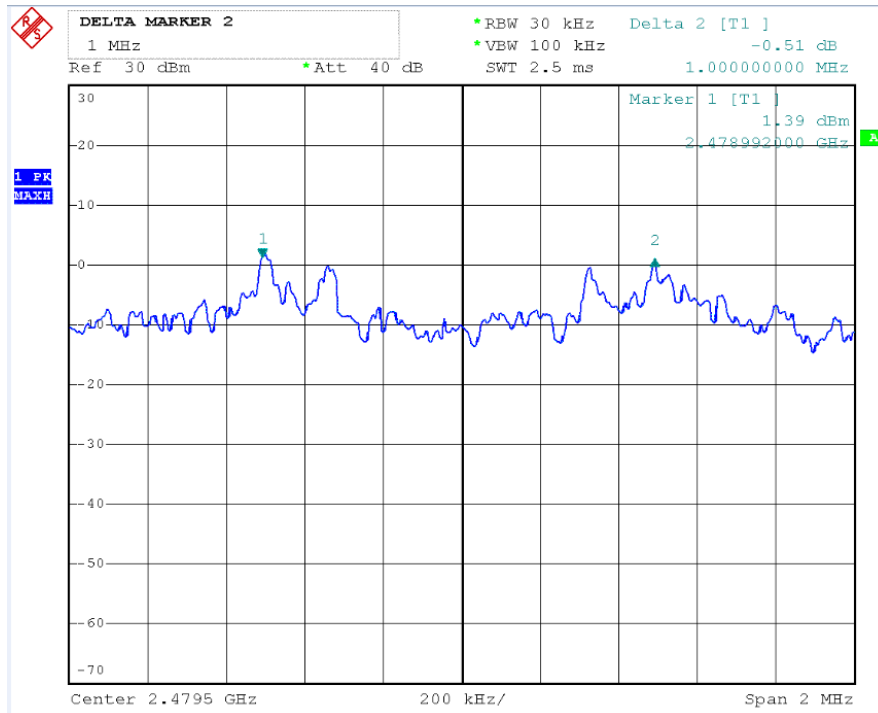

## 7. Test of Number of Hopping Frequency

### 7.1 Applicable Standard

Section 15.247(a)(1)(iii): For frequency hopping systems operating in the 2400-2483.5 MHz band employing at least 15 non-overlapping hopping channels. Frequency hopping system which use fewer than 75 hopping frequencies may employ intelligent hopping techniques to avoid interference to other transmissions. Frequency hopping system may avoid or suppress transmissions on a particular hopping frequency provided that a minimum of 15 non-overlapping channels are used.

### 7.2 EUT Setup



### 7.3 Test Equipment List and Details

See section 2.5.

### 7.4 Test Procedure

1. The transmitter output was connected to the spectrum analyzer through an attenuator.
2. Set RBW of spectrum analyzer to 100KHz and VBW to 100KHz.
3. Set Detector to Peak, Trace to Max Hold and Sweep Time is Auto.
4. Observe frequency hopping in 2400MHz~2483.5MHz, there are at least 32 non-overlapping channels.
5. Repeat above 1~3 points for the middle and highest channel of the EUT.

### 7.5 Test Result

Temperature ( °C ) : 22~23	EUT: Sporty Stereo Bluetooth Headset
Humidity (%RH) : 50~54	M/N: G23S
Barometric Pressure ( mbar ) : 950~1000	Operation Condition: Tx Mode

Modulation Type	Frequency (MHz)	Number of Hopping Channels	Min. Limit
GFSK	2402~2480	79	≥ 15
Pi/4 DQPSK	2402~2480	79	≥ 15
8-DPSK	2402~2480	79	≥ 15

**BR-1M**

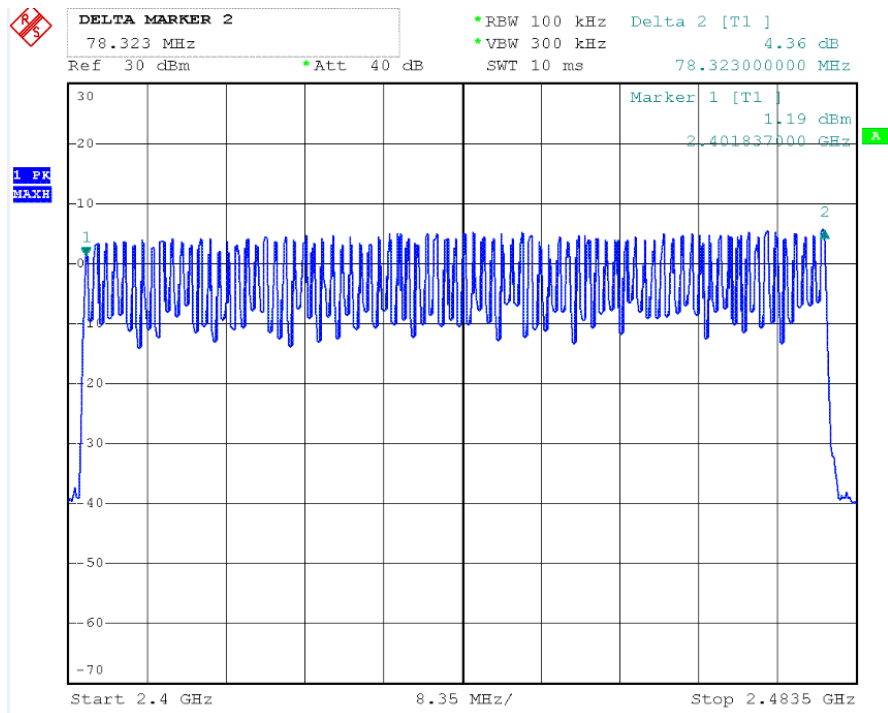

**EDR-2M**

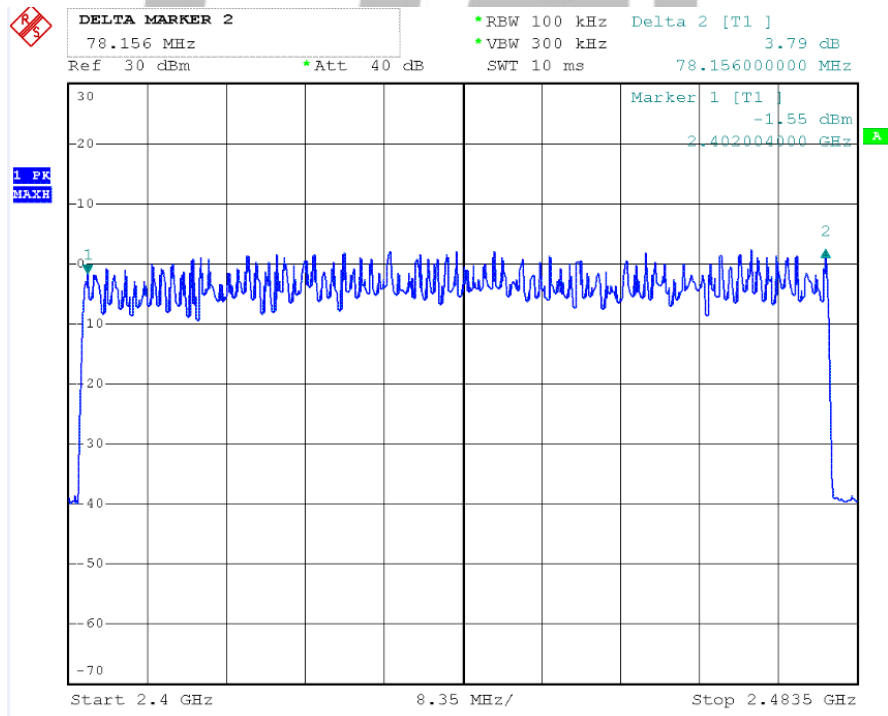



**EDR-3M**

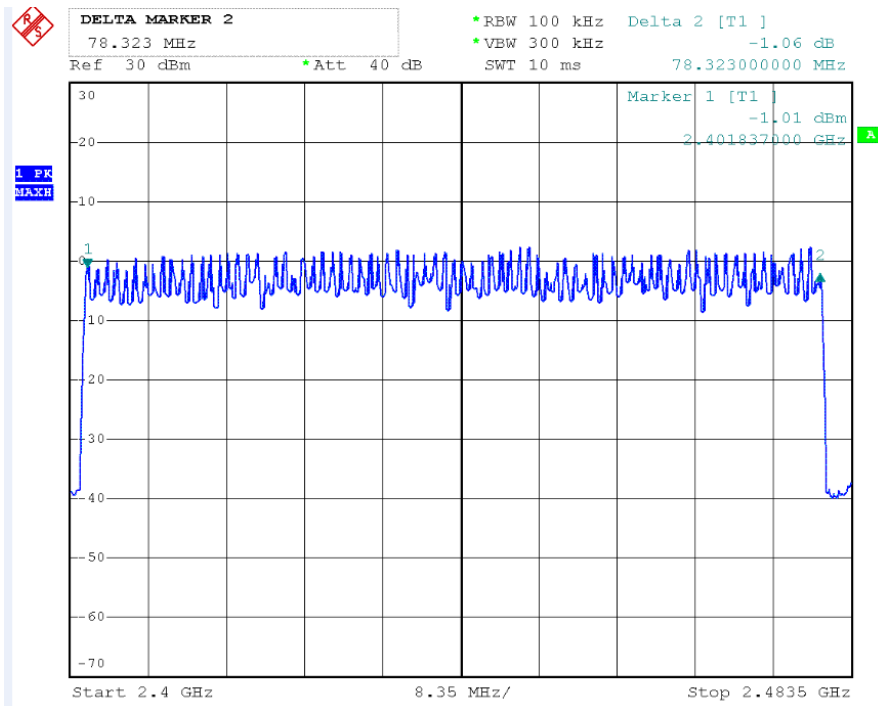

## 8. Test of Dwell Time of Each Frequency

### 8.1 Applicable Standard

Section 15.247(a)(1)(iii): For frequency hopping systems operating in the 2400-2483.5 MHz band The average time of occupancy on any channel shall not be greater than 0.4 seconds within a period of 0.4seconds multiplied by the number of hopping channels employed.

### 8.2 EUT Setup

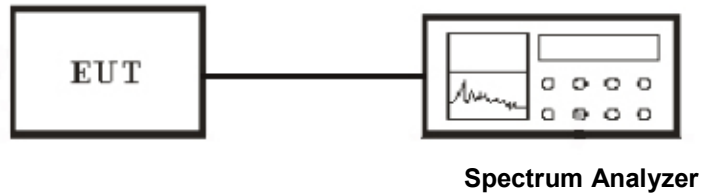

### 8.3 Test Equipment List and Details

See section 2.5.

### 8.4 Test Procedure

1. The transmitter output was connected to the spectrum analyzer through an attenuator.
2. Set RBW of spectrum analyzer to 1000kHz and VBW to 1000kHz.
3. Set Detector to Peak, Trace to Max Hold and Sweep Time is more than once pulse time.
4. Set the center frequency on any frequency would be measure and set the frequency span to zero span.
5. Measure the maximum time duration of one single pulse.

### 8.5 Test Result

Temperature ( °C ) : 22~23	EUT: Sparty Stereo Bluetooth Headset
Humidity (%RH) : 50~54	M/N: G23S
Barometric Pressure ( mbar ) : 950~1000	Operation Condition: Tx Mode

DH1

Dwell time=  $t^*(1.6/2/79)*31.6$

DH3

Dwell time=  $t^*(1.6/4/79)*31.6$

DH5

Dwell time=  $t^*(1.6/6/79)*31.6$

**BR 1M  
Low Channel**

Modulation Type		Reading (ms)	Dwell Time (ms)	Limit (ms)
GFSK	DH1	0.380	121.60	400
GFSK	DH3	1.620	265.60	400
GFSK	DH5	2.900	309.33	400

**Middle Channel**

Modulation Type		Reading (ms)	Dwell Time (ms)	Limit (ms)
GFSK	DH1	0.380	121.60	400
GFSK	DH3	1.620	259.20	400
GFSK	DH5	2.900	309.33	400

**High Channel**

Modulation Type		Reading (ms)	Dwell Time (ms)	Limit (ms)
GFSK	DH1	0.380	121.60	400
GFSK	DH3	1.620	259.20	400
GFSK	DH5	2.900	309.33	400

**EDR 2M  
Low Channel**

Modulation Type		Reading (ms)	Dwell Time (ms)	Limit (ms)
Pi/4 DQPSK	2DH1	0.390	124.80	400
Pi/4 DQPSK	2DH3	1.630	260.80	400
Pi/4 DQPSK	2DH5	2.900	309.33	400

**Middle Channel**

Modulation Type		Reading (ms)	Dwell Time (ms)	Limit (ms)
Pi/4 DQPSK	2DH1	0.395	126.40	400
Pi/4 DQPSK	2DH3	1.630	260.80	400
Pi/4 DQPSK	2DH5	2.900	309.33	400

**High Channel**

Modulation Type		Reading (ms)	Dwell Time (ms)	Limit (ms)
Pi/4 DQPSK	2DH1	0.395	126.40	400
Pi/4 DQPSK	2DH3	1.630	260.80	400
Pi/4 DQPSK	2DH5	2.900	309.33	400

**EDR 3M  
Low Channel**

Modulation Type		Reading (ms)	Dwell Time (ms)	Limit (ms)
8-DPSK	3DH1	0.380	128.00	400
8-DPSK	3DH3	1.640	262.40	400
8-DPSK	3DH5	2.890	308.26	400

**Middle Channel**

Modulation Type		Reading (ms)	Dwell Time (ms)	Limit (ms)
8-DPSK	3DH1	0.385	128.00	400
8-DPSK	3DH3	1.640	262.40	400
8-DPSK	3DH5	2.900	309.33	400

**High Channel**

Modulation Type		Reading (ms)	Dwell Time (ms)	Limit (ms)
8-DPSK	3DH1	0.385	129.60	400
8-DPSK	3DH3	1.650	264.00	400
8-DPSK	3DH5	2.890	308.26	400

HONGCAI TESTING

**BR-DH1  
Channel Low**

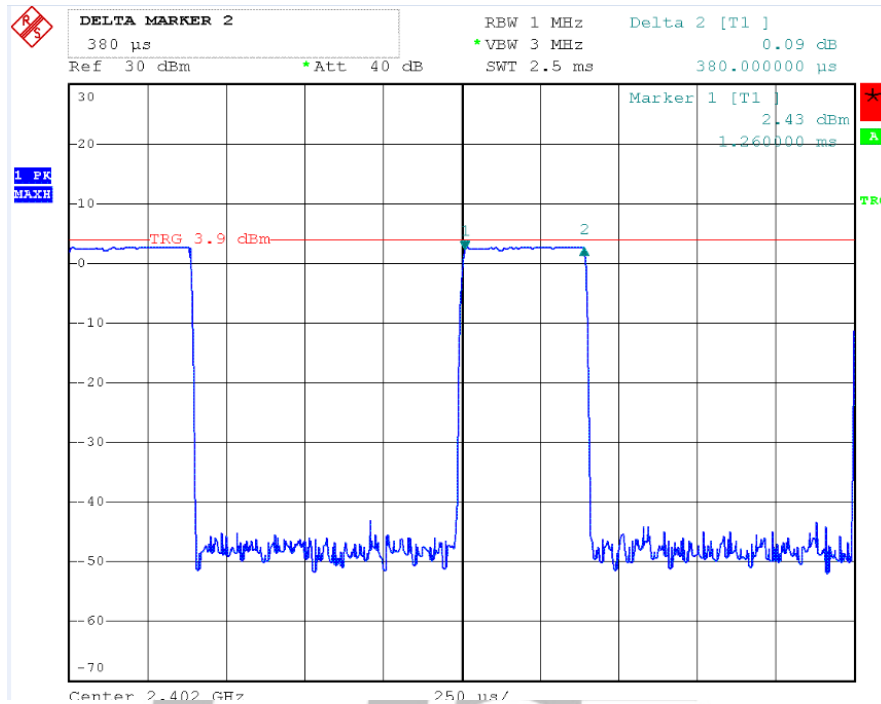

**Channel Middle**

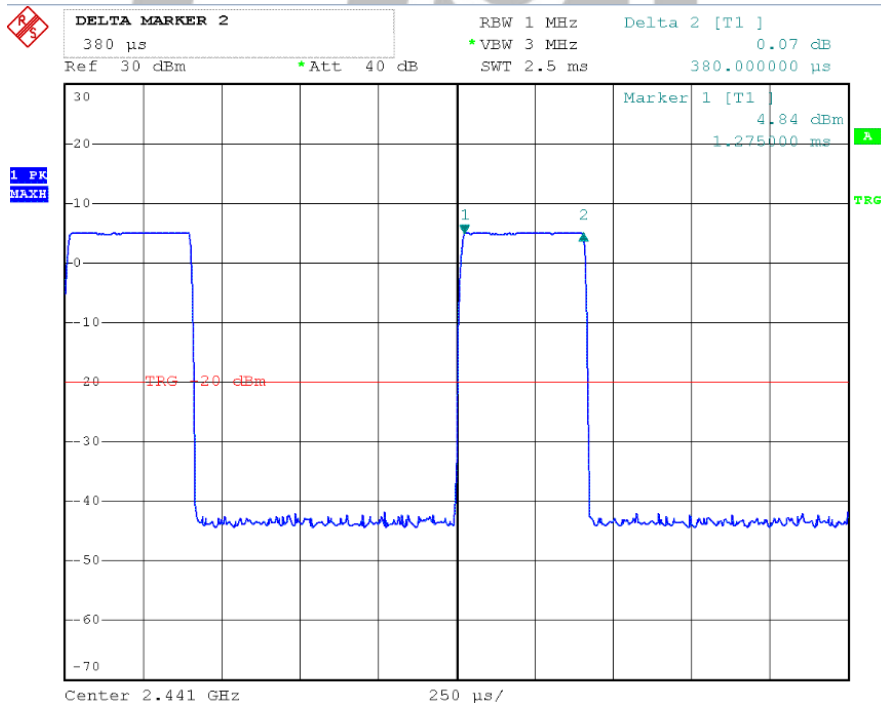

### Channel High

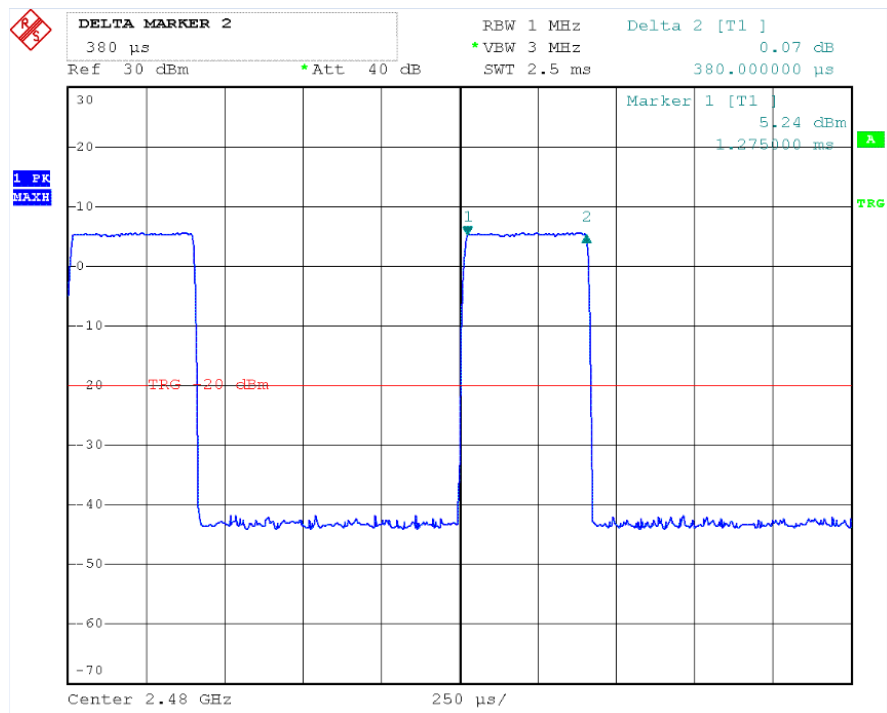

### DH3 Channel Low

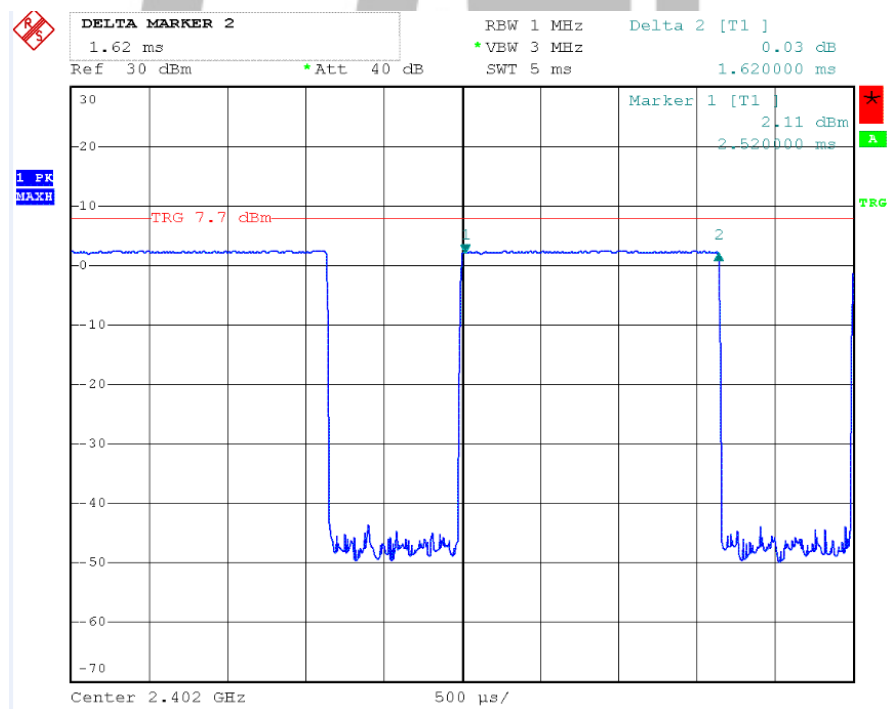



### Channel Middle

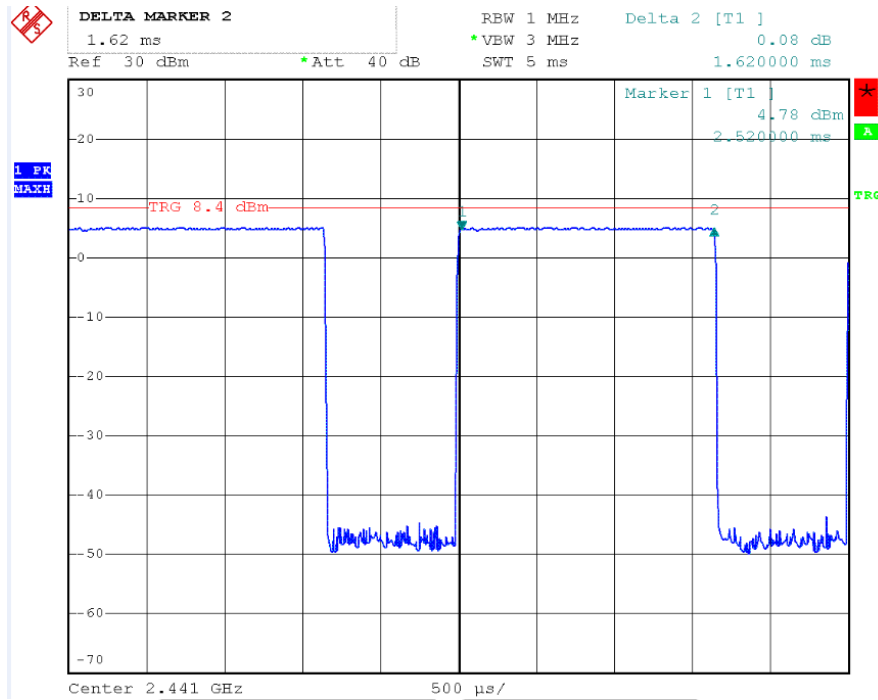

### Channel High

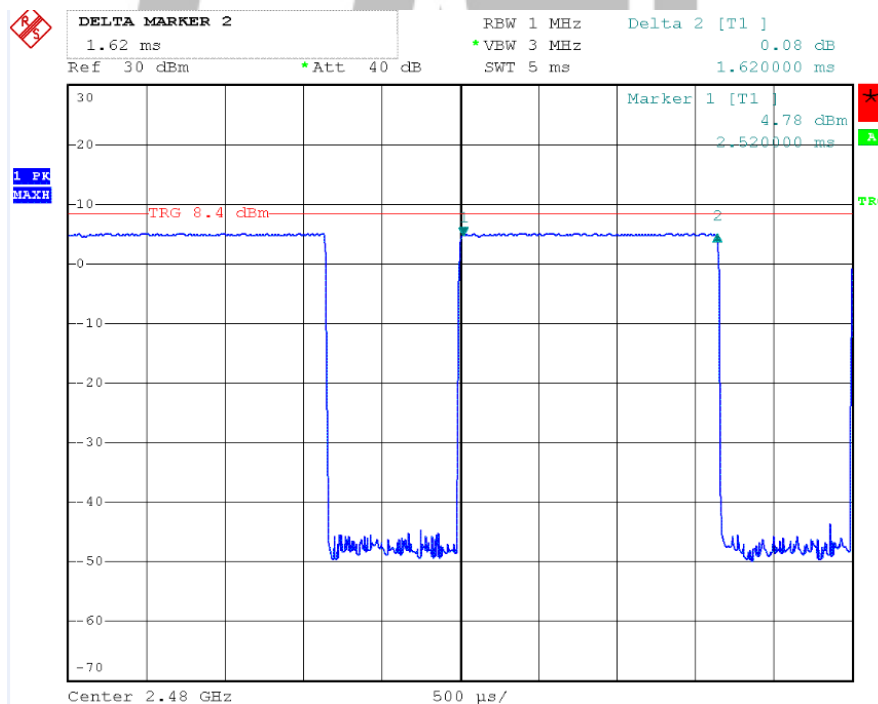

### DH5 Channel Low

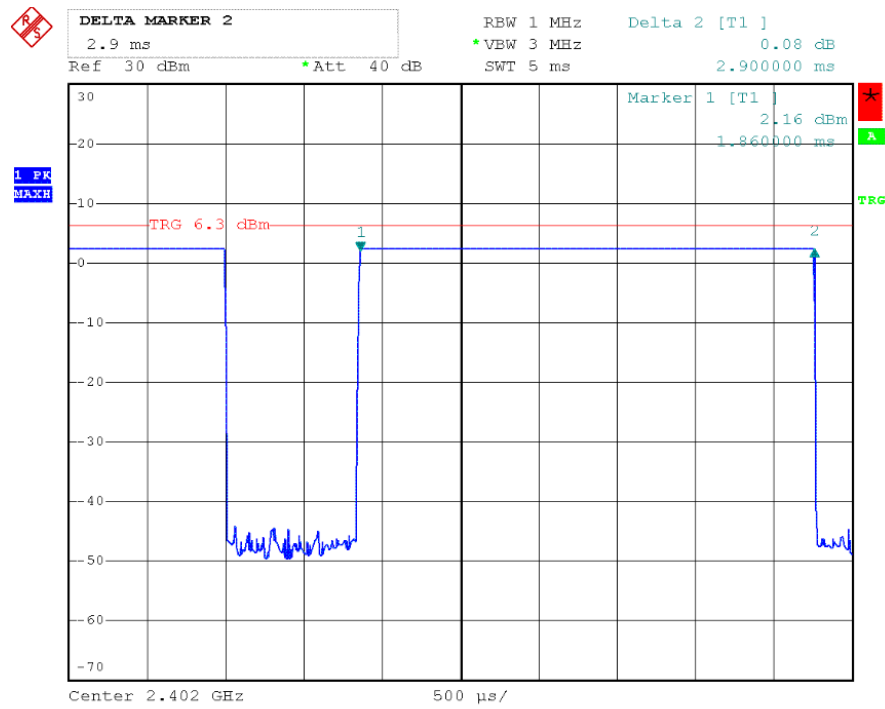

### Channel Middle

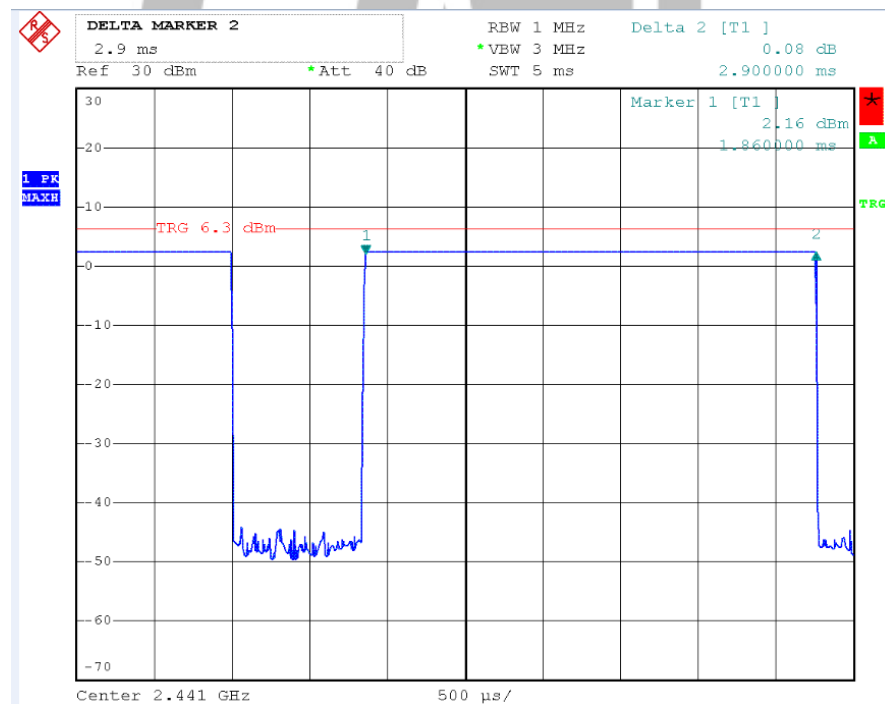

### Channel High

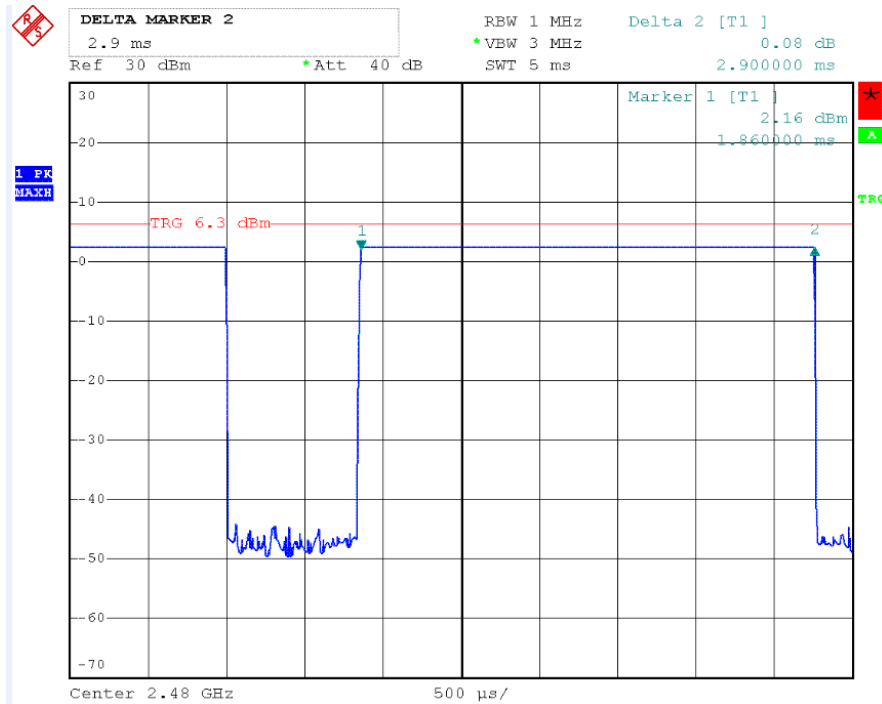

### EDR 2M 2DH1 Channel Low

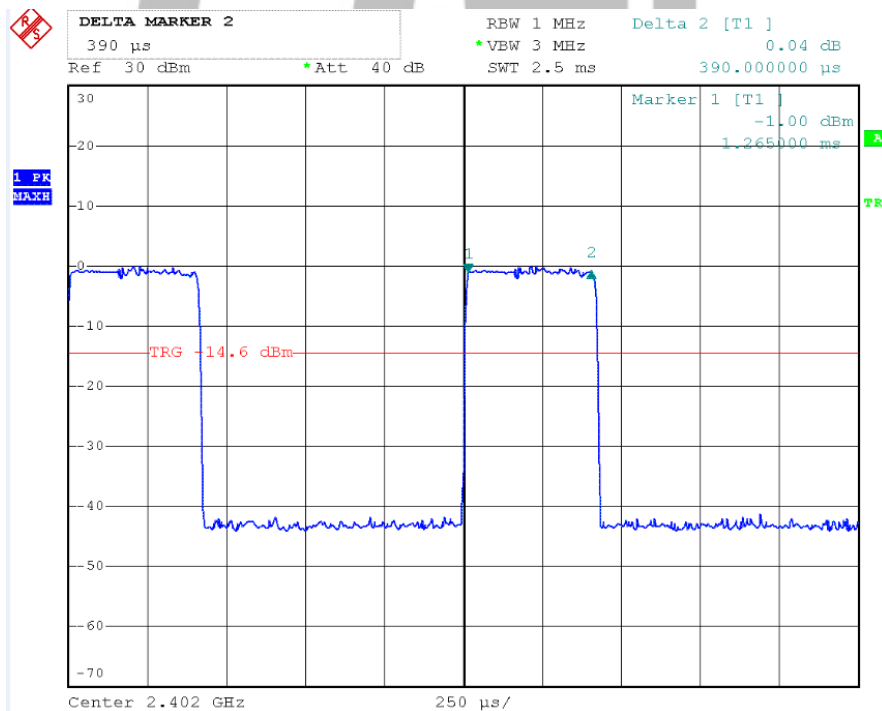

### Channel Middle

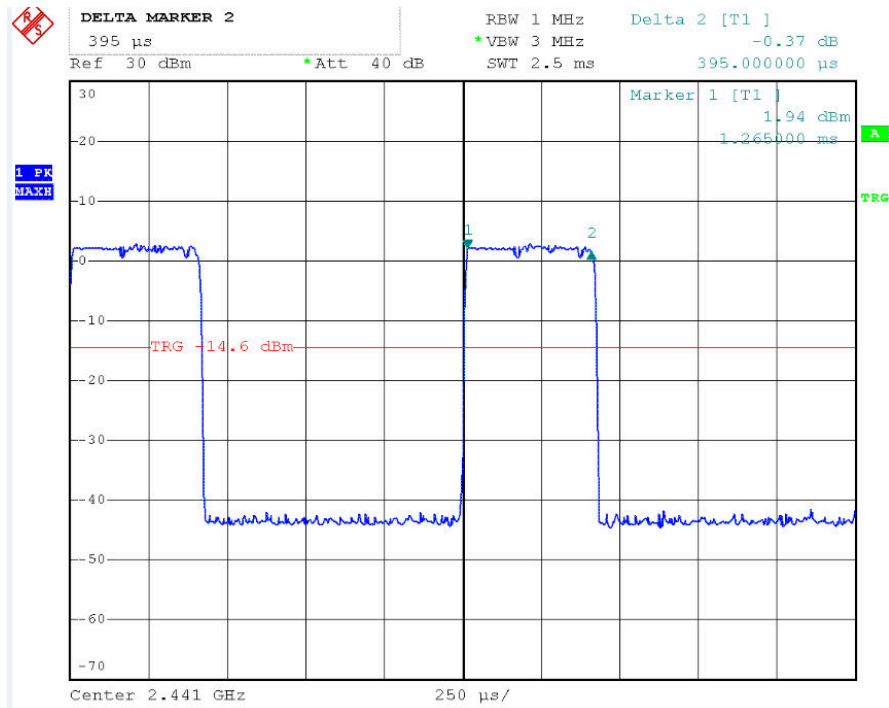

### Channel High

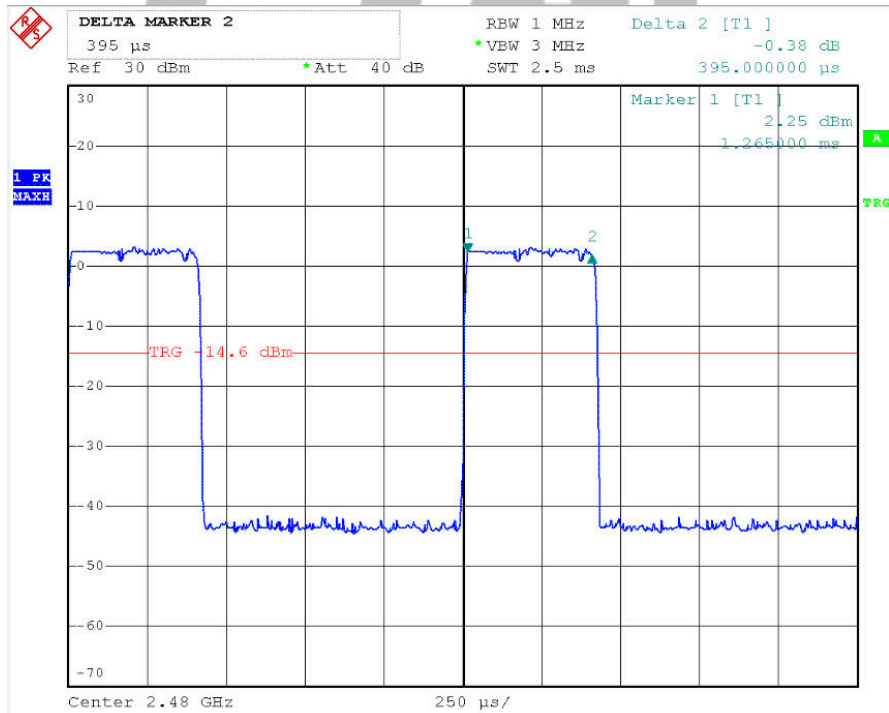

### EDR 2M 2DH3 Channel Low

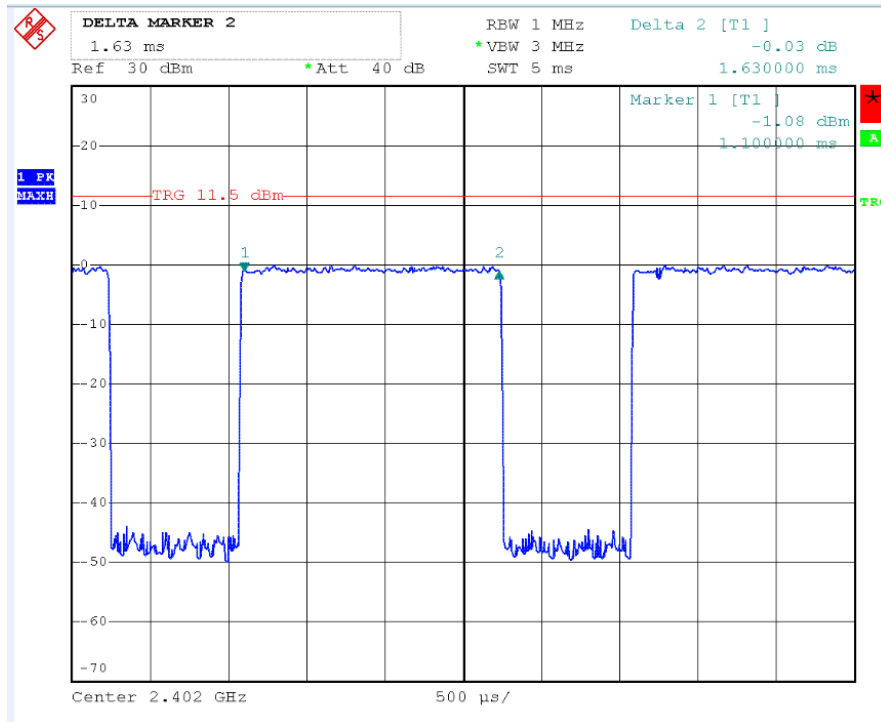

### Channel Middle

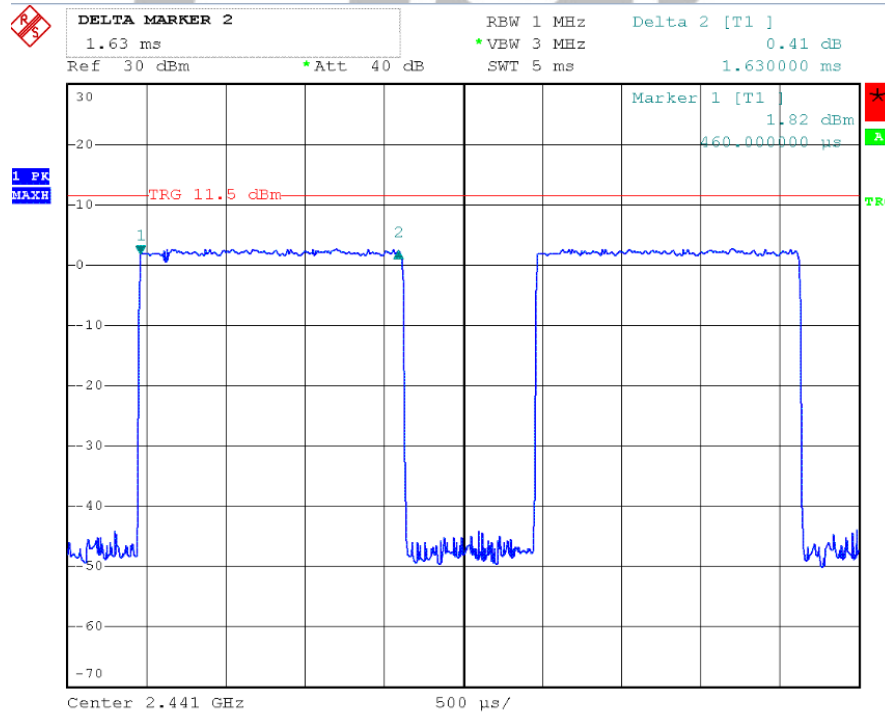

### Channel High

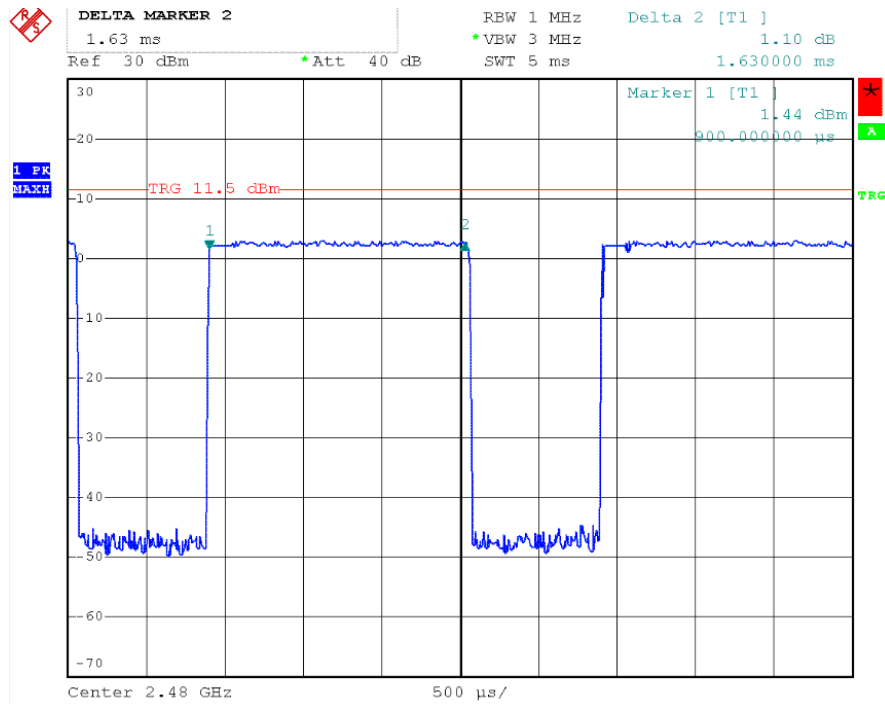

### EDR 2M 2DH5 Channel Low

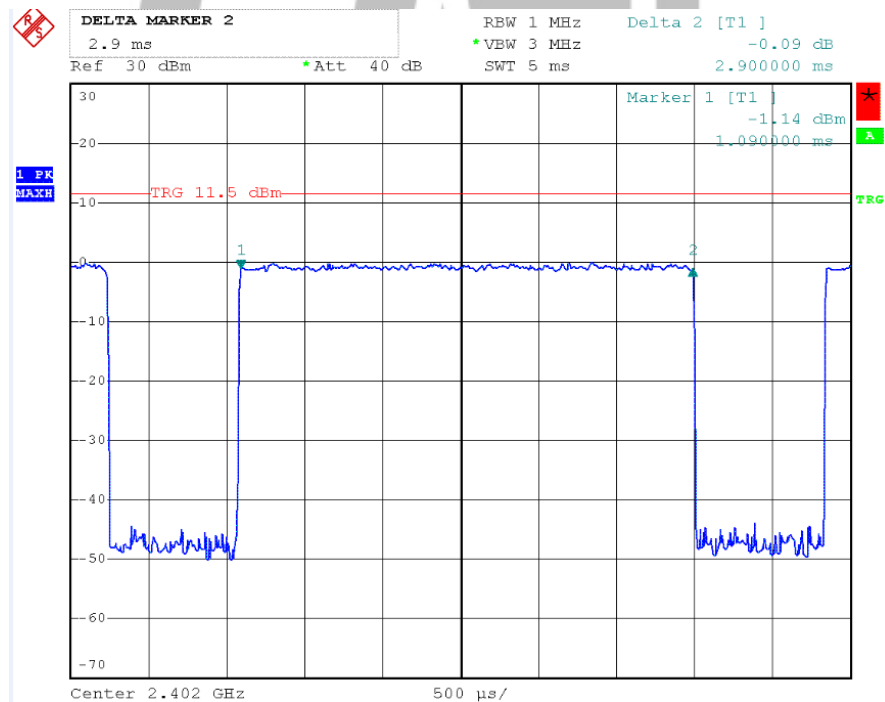

### Channel Middle

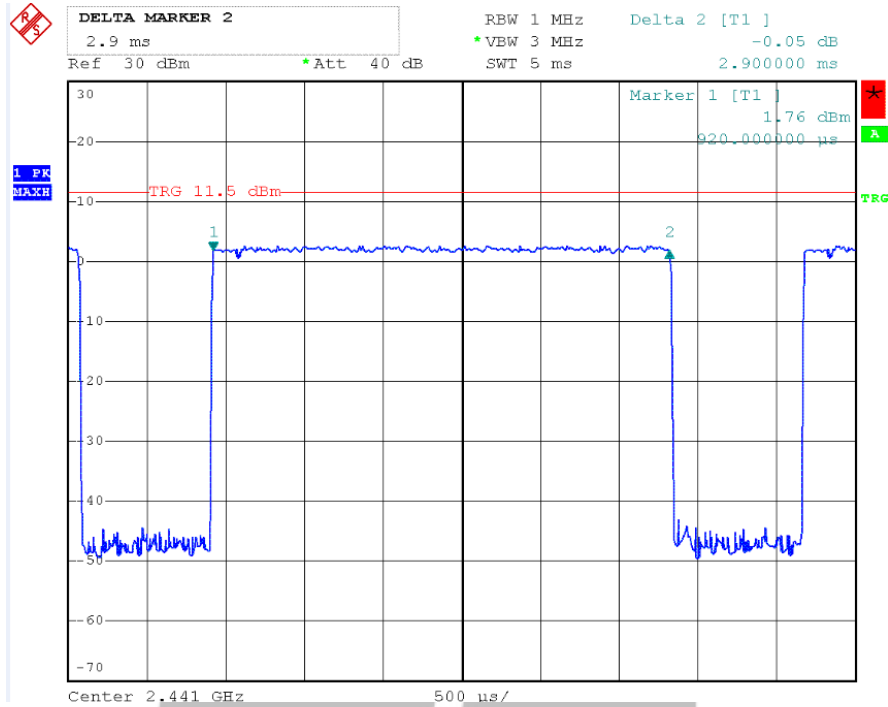

### Channel High

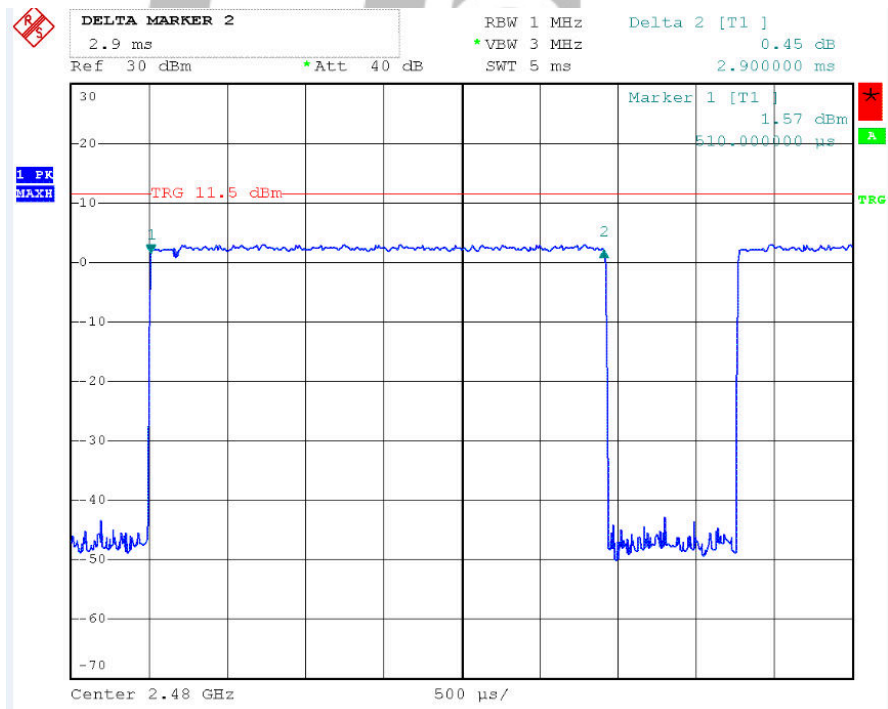

### EDR 3M 3DH1 Channel Low

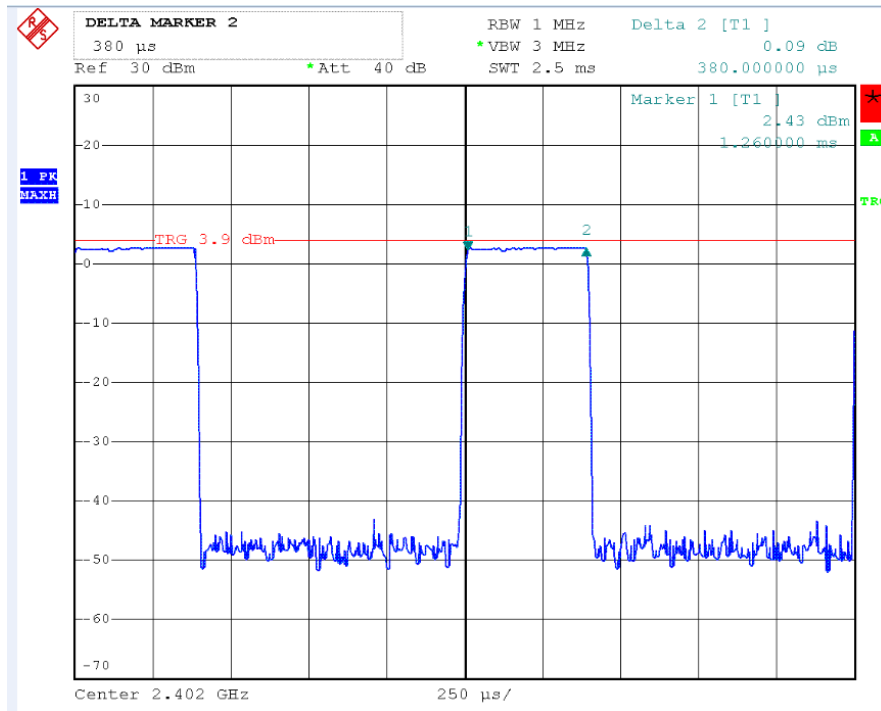

### Channel Middle

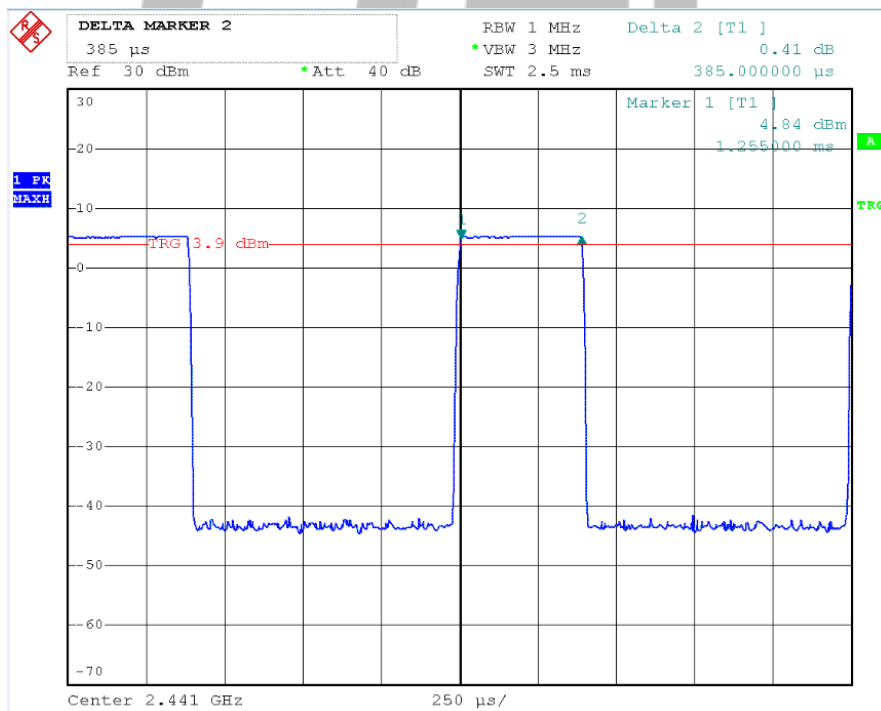



### Channel High

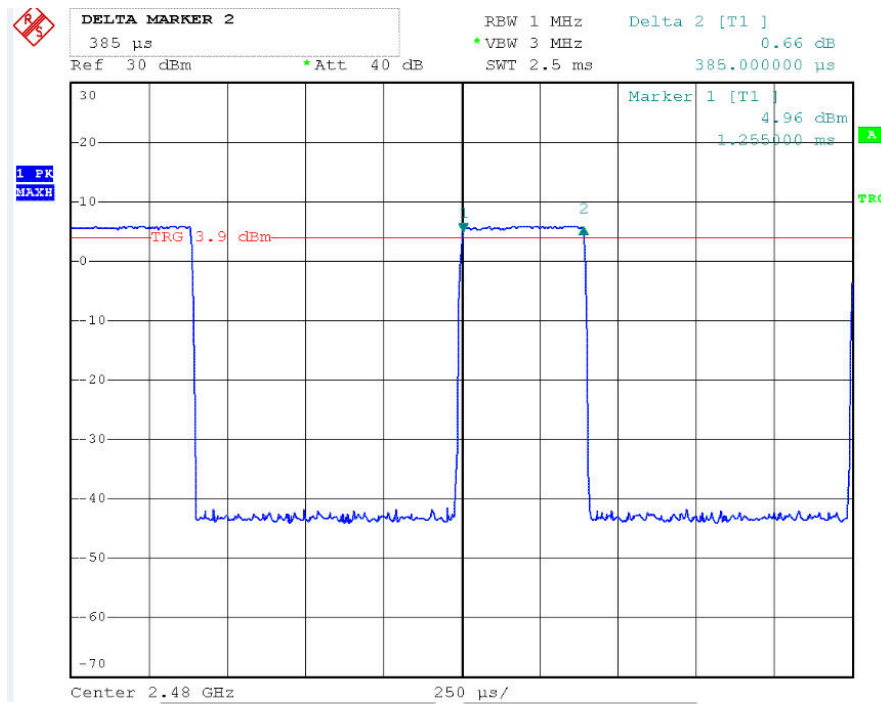

### EDR 3M 3DH3 Channel Low

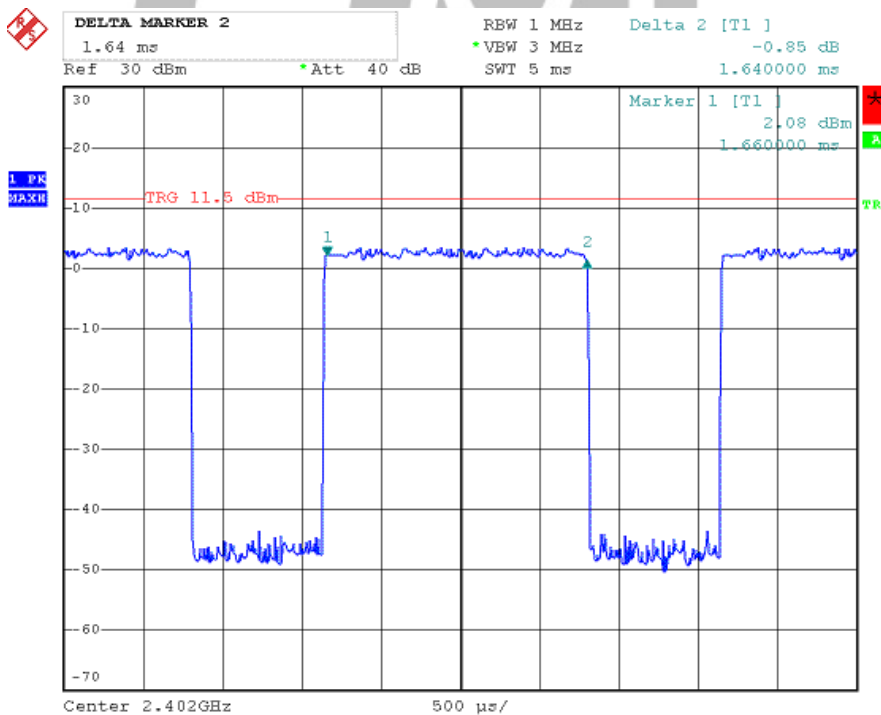

### Channel Middle

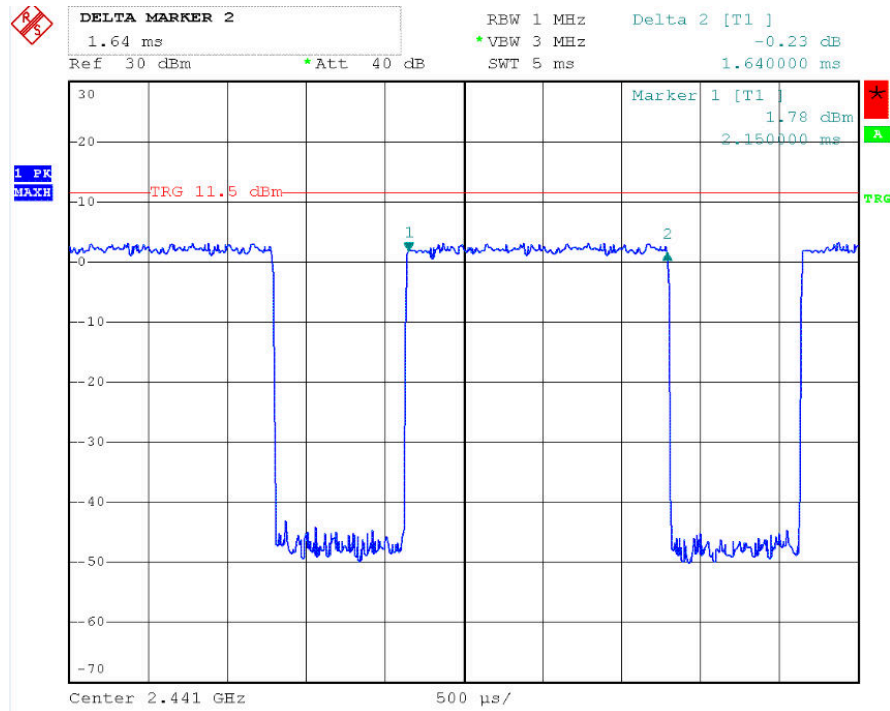

### Channel High

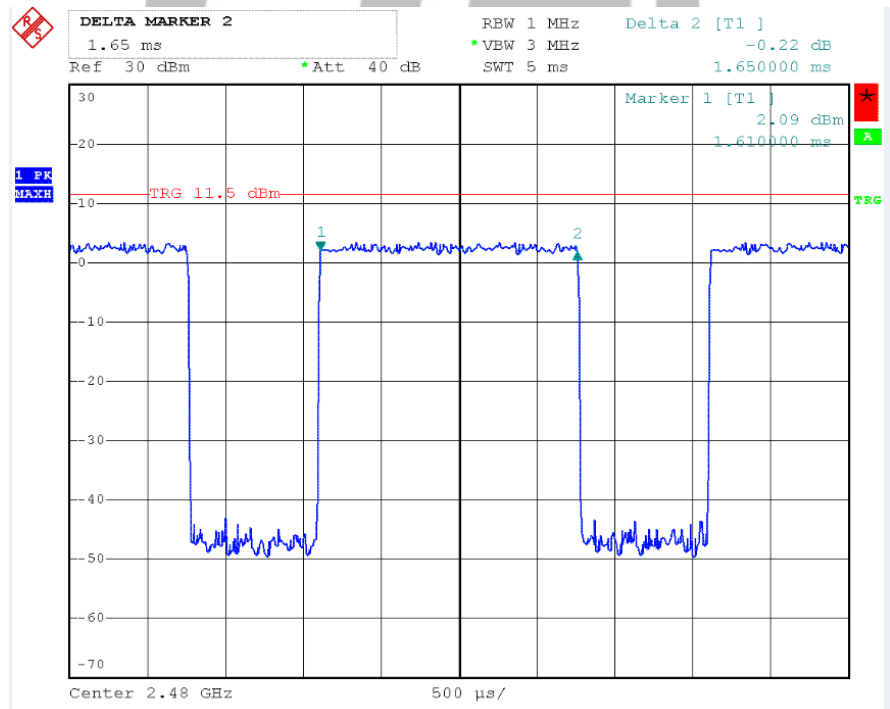

### EDR 3M 3DH5 Channel Low

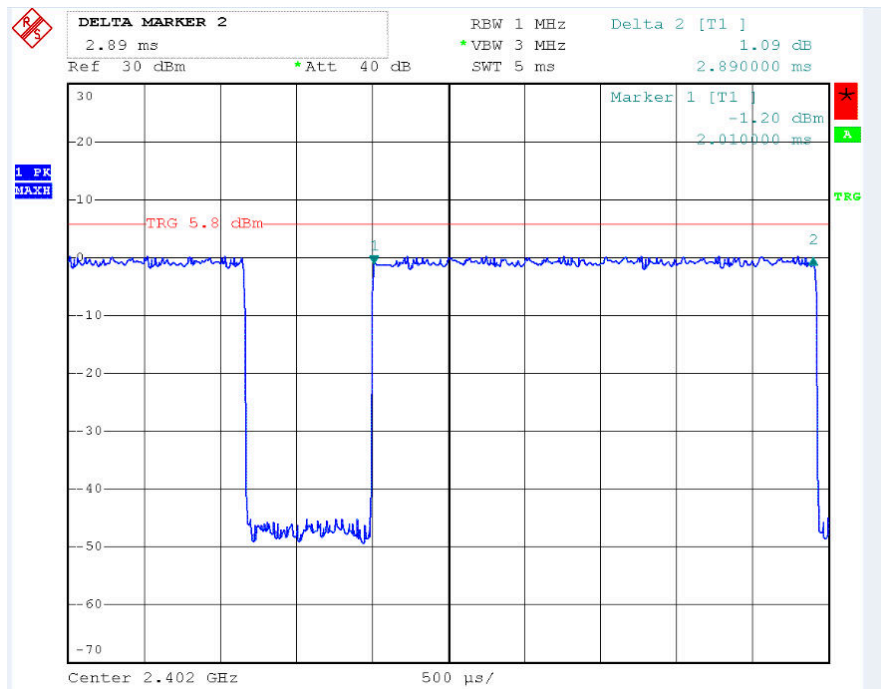

### Channel Middle

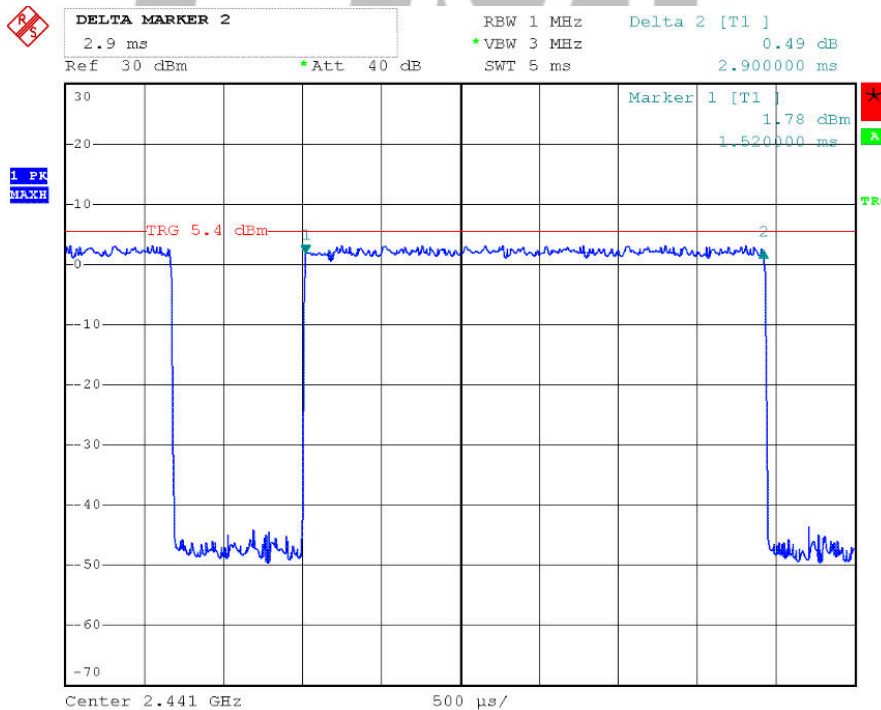

**Channel High**

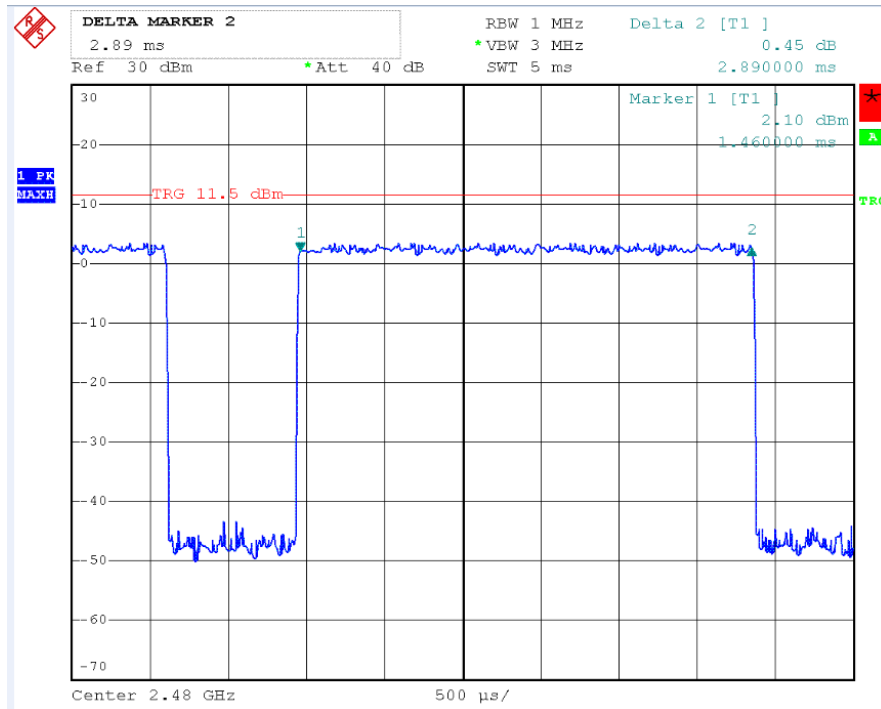

## 9. Test of Maximum Peak Output Power

### 9.1 Applicable Standard

Section 15.247(b)(1): For frequency hopping systems operating in the 2400-2483.5 MHz band employing at least 75 non-overlapping hopping channels and The maximum peak output power shall not exceed 1 watt. For all other frequency hopping systems in this frequency band, The maximum peak output power shall not exceed 0.125 watt.

### 9.2 EUT Setup

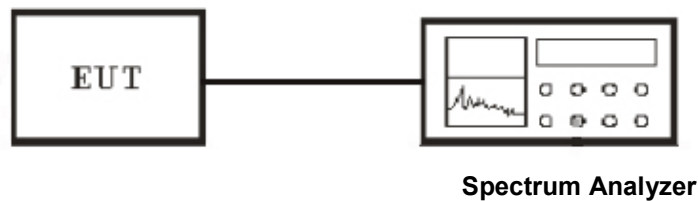

### 9.3 Test Equipment List and Details

See section 2.5.

### 9.4 Test Procedure

1. The transmitter output was connected to the peak power meter and recorded the peak value.
2. Peak power meter parameter set to auto attenuator and filter is the same as.
3. Repeated the 1 for the middle and highest channel of the EUT.

### 9.5 Test Result

Temperature ( °C ) : 22~23	EUT: Sporty Stereo Bluetooth Headset
Humidity (%RH) : 50~54	M/N: G23S
Barometric Pressure ( mbar ) : 950~1000	Operation Condition: Tx Mode

**BR 1M**

Modulation Type	Channel No.	Frequency (MHz)	Output Power (dBm)	Limits (dBm)	Result
GFSK	Low	2402.00	2.35	21	PASS
GFSK	Middle	2441.00	5.03	21	PASS
GFSK	High	2480.00	5.39	21	PASS

**EDR 2M**

Modulation Type	Channel No.	Frequency (MHz)	Output Power (dBm)	Limits (dBm)	Result
Pi/4 DQPSK	Low	2402.00	-0.21	21	PASS
Pi/4 DQPSK	Middle	2441.00	2.70	21	PASS
Pi/4 DQPSK	High	2480.00	3.04	21	PASS

**EDR 3M**

Modulation Type	Channel No.	Frequency (MHz)	Output Power (dBm)	Limits (dBm)	Result
8-DPSK	Low	2402.00	0.06	21	PASS
8-DPSK	Middle	2441.00	2.85	21	PASS
8-DPSK	High	2480.00	3.22	21	PASS

**BR 1M  
Channel Low**

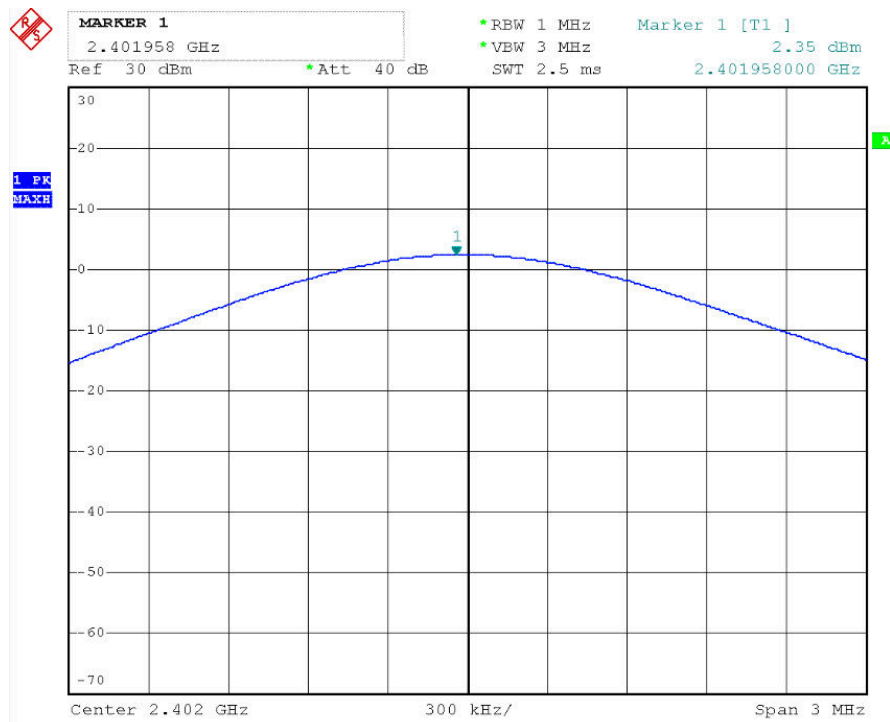

### Channel Middle

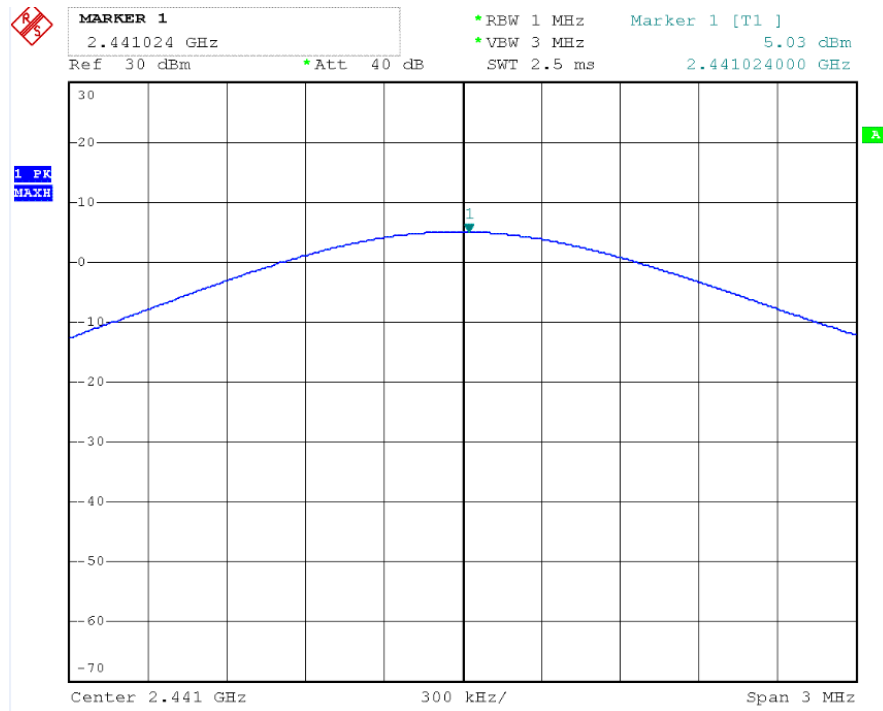

### Channel High

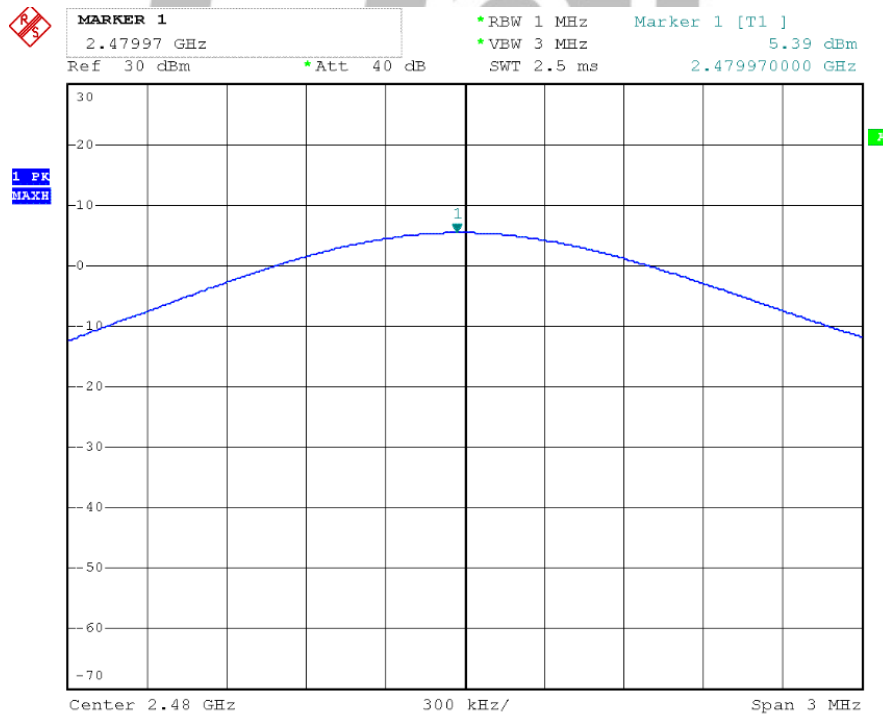

### EDR 2M Channel Low

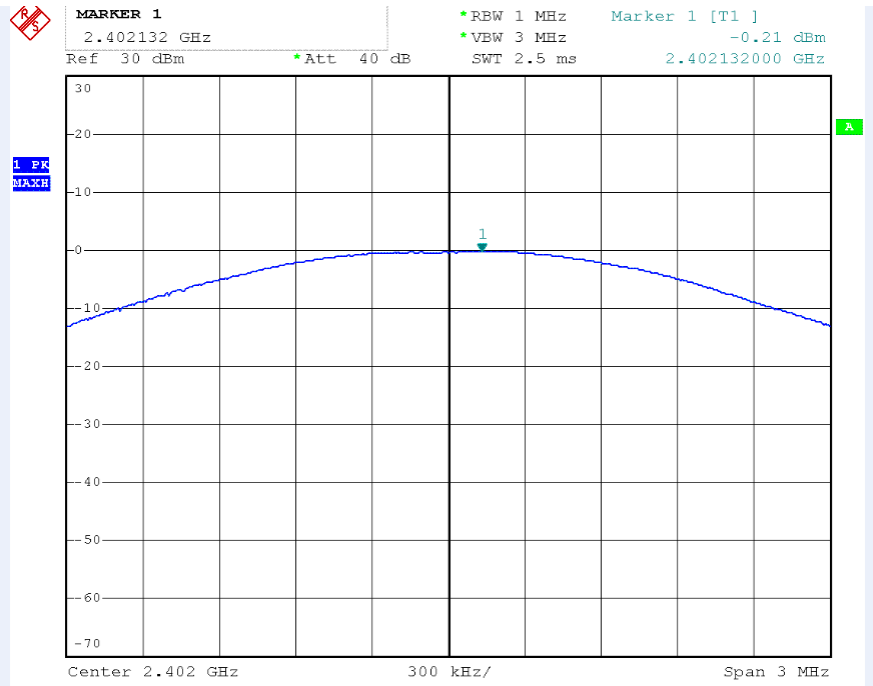

### Channel Middle

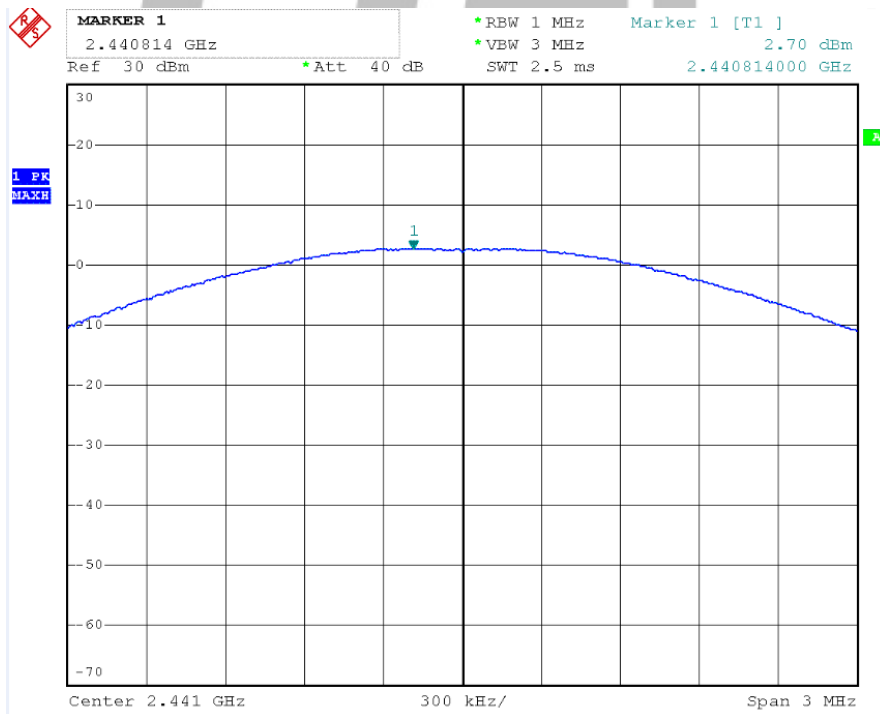



### Channel High

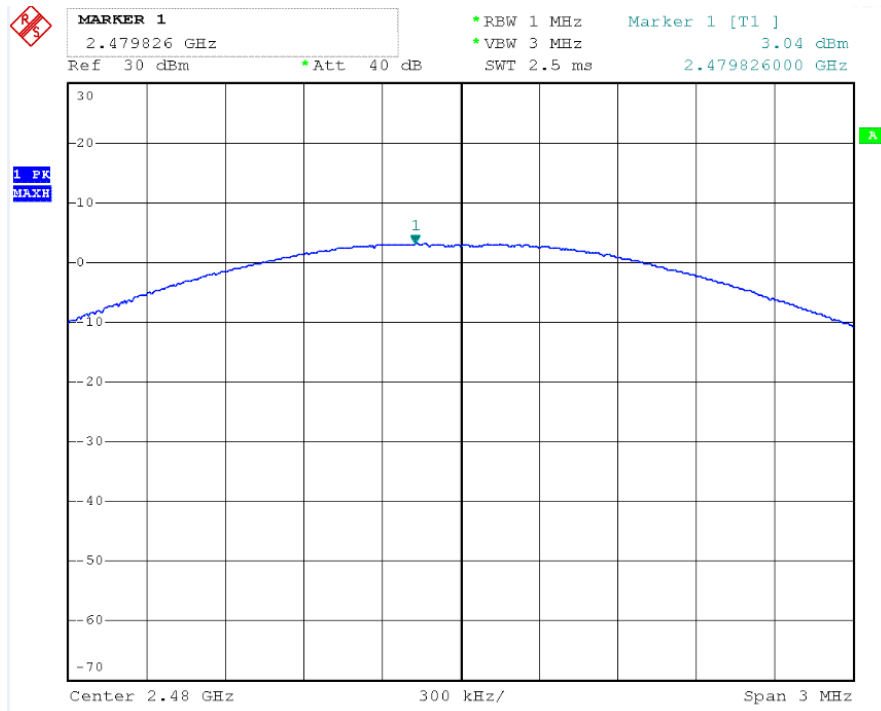

### EDR 3M Channel Low

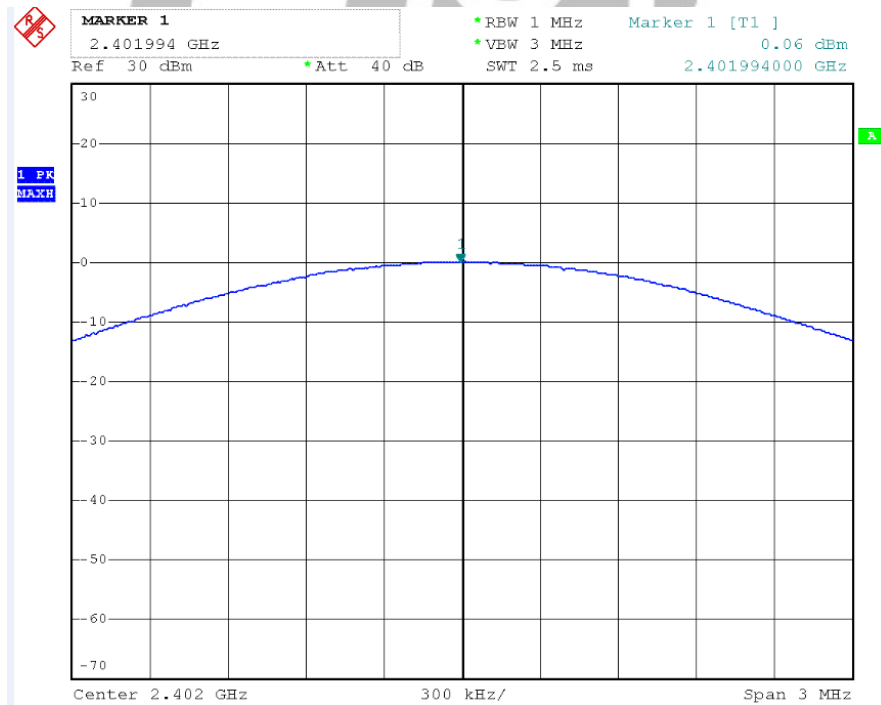

### Channel Middle

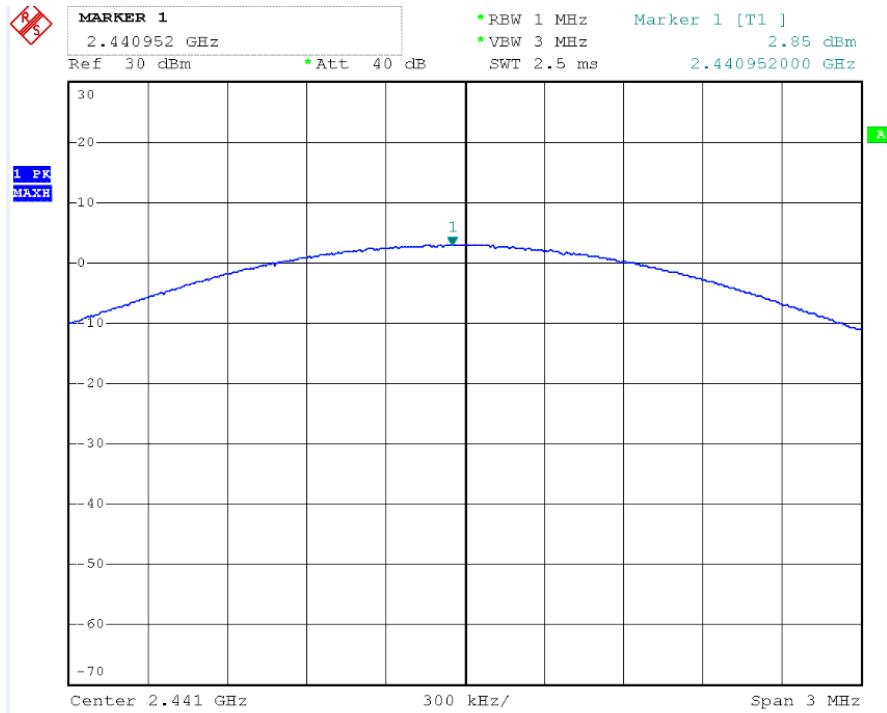

### Channel High

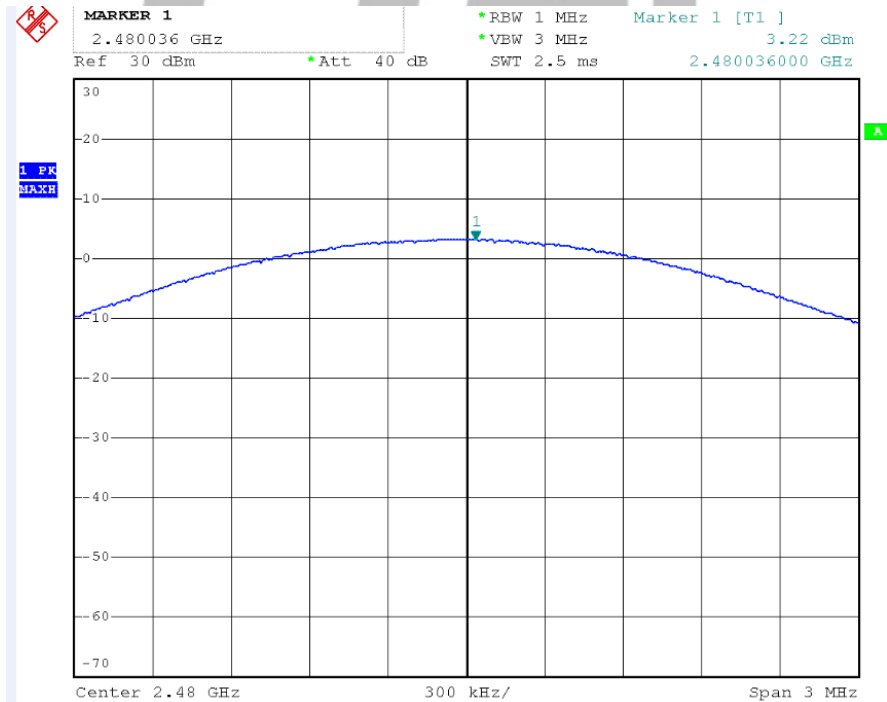

## 10. Test of Band Edges Emission

### 10.1 Applicable Standard

Section 15.247(d): In any 100 kHz bandwidth outside the frequency band in which the spread spectrum or digitally modulated intentional radiator is operating, the radio frequency power that is produced by the intentional radiator shall be at least 20 dB below that in the 100 kHz bandwidth within the band that contains the highest level of the desired power, based on either an RF conducted or a radiated measurement. In addition, radiated emissions that fall in the restricted bands, as defined in Section 15.205, must also comply with the radiated emission limits specified in Section 15.209.

### 10.2 EUT Setup

Radiated Measurement Setup

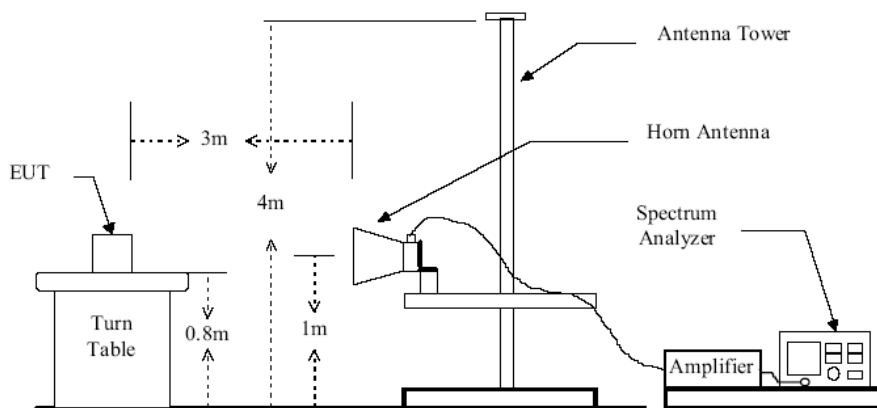
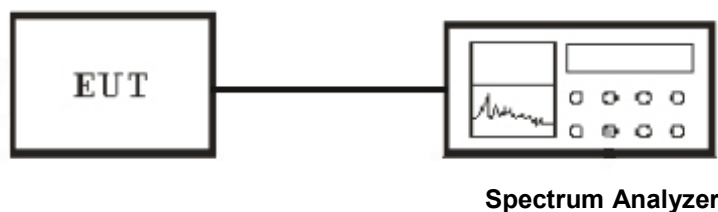

Figure 2 : Frequencies measured above 1 GHz configuration

HONGCAI TESTING

Conducted Measurement Setup



### 10.3 Test Equipment List and Details

See section 2.5.

### 10.4 Test Procedure

Conducted Measurement

1. The transmitter is set to the lowest channel.
2. The transmitter output was connected to the spectrum analyzer via a cable .

3. Set both RBW and VBW of spectrum analyzer to 100KHz with convenient frequency span including 100MHz bandwidth from lower band edge. Then detector set to peak and max hold this trace.
4. The lowest band edges emission was measured and recorded.
5. The transmitter set to the highest channel and repeated 2~4.

#### Radiated Measurement

1. Configure the EUT according to ANSI C63.4-2003
2. The turntable was rotated by 360 degrees to determine the position of the highest radiation.
3. The height of the broadband receiving antenna was varied between one meter and four meters above ground to find the maximum emission field strength of both horizontal and vertical polarization.
4. For band edge emission, the antenna tower was scan (from 1 M to 4 M) and then the turn table was rotated (from 0 degree to 360 degrees) to find the maximum reading.
5. For band edge emission, use 1MHz VBW and 1MHz RBW for reading under AV and use 1MHz VBW and 1MHz RBW for reading under PK.

### 10.5 Test Result

Temperature ( °C ) : 22~23	EUT: Sparty Stereo Bluetooth Headset
Humidity (%RH) : 50~54	M/N: G23S
Barometric Pressure ( mbar ) : 950~1000	Operation Condition: Tx Mode

#### Radiated Test Result

##### Worst Case BR 1M

Frequency (MHz)	Antenna Polarization	Emission Read Value (dBμV/m)	Emission Level (dBμV/m)	Margin (dB)	Limits (dBμV/m)	Det.
2389.5	H	30.23	60.13	-13.87	74	PK
2389.5	H	17.21	47.11	-6.89	54	AV
2389.5	V	32.49	62.29	-11.71	74	PK
2389.5	V	17.32	47.22	-6.78	54	AV
2483.7	H	31.66	61.54	-12.46	74	PK
2483.7	H	17.90	47.80	-6.20	54	AV
2483.7	V	32.58	62.46	-11.54	74	PK
2483.7	V	18.20	48.10	-5.9	54	AV

**Worst Case EDR 2M**

Frequency (MHz)	Antenna Polarization	Emission Read Value (dBμV/m)	Emission Level (dBμV/m)	Margin (dB)	Limits (dBμV/m)	Det.
2389.4	H	31.32	61.22	-12.78	74	PK
2389.4	H	16.12	46.02	-7.98	54	AV
2389.4	V	32.68	62.48	-11.52	74	PK
2389.4	V	17.12	47.02	-6.98	54	AV
2483.7	H	31.54	61.42	-12.58	74	PK
2483.7	H	18.22	48.12	-5.88	54	AV
2483.7	V	33.85	63.73	-10.27	74	PK
2483.7	V	18.44	48.34	-5.66	54	AV

**Worst Case EDR 3M**

Frequency (MHz)	Antenna Polarization	Emission Read Value (dBμV/m)	Emission Level (dBμV/m)	Margin (dB)	Limits (dBμV/m)	Det.
2389.5	H	31.52	61.42	-12.58	74	PK
2389.5	H	19.21	49.11	-4.89	54	AV
2389.5	V	33.69	63.49	-11.52	74	PK
2389.5	V	18.22	48.12	-5.88	54	AV
2483.6	H	31.78	61.42	-10.51	74	PK
2483.6	H	18.23	48.13	-5.87	54	AV
2483.6	V	33.38	63.26	-10.27	74	PK
2483.6	V	18.65	48.55	-5.45	54	AV

- Note: 1. Emission Level = Emission Read Value + Correction Factor  
 2. Correction Factor) = Antenna Factor + Cable Loss- amplifier gain  
 3. The other emission levels were very low against the limit.  
 4. Margin value = Emission Level – Limit value

### Conducted Test Result BR 1M Low Channel

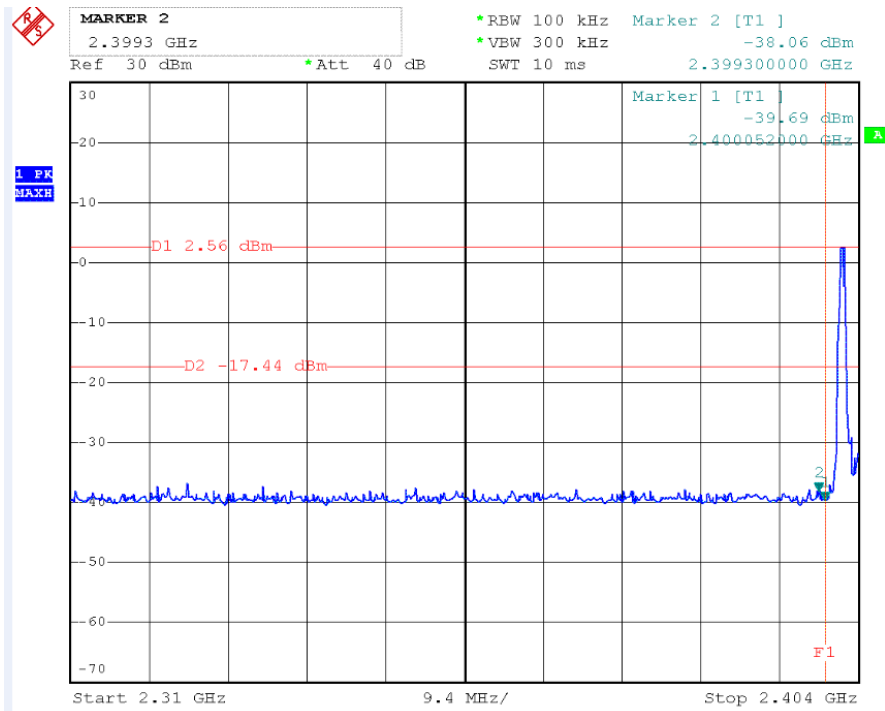

### High Channel

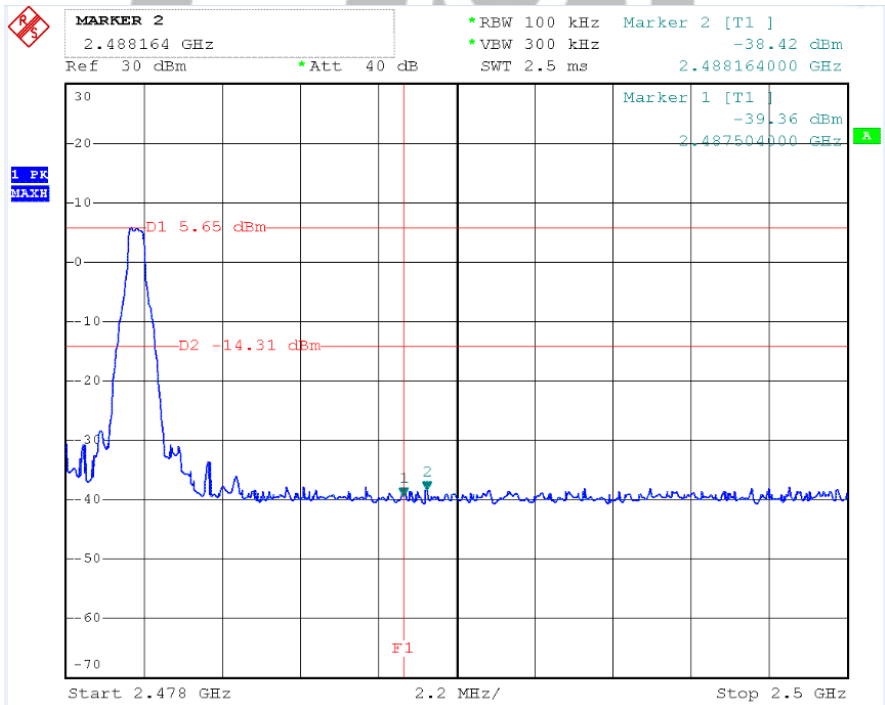

### EDR 2M Low Channel

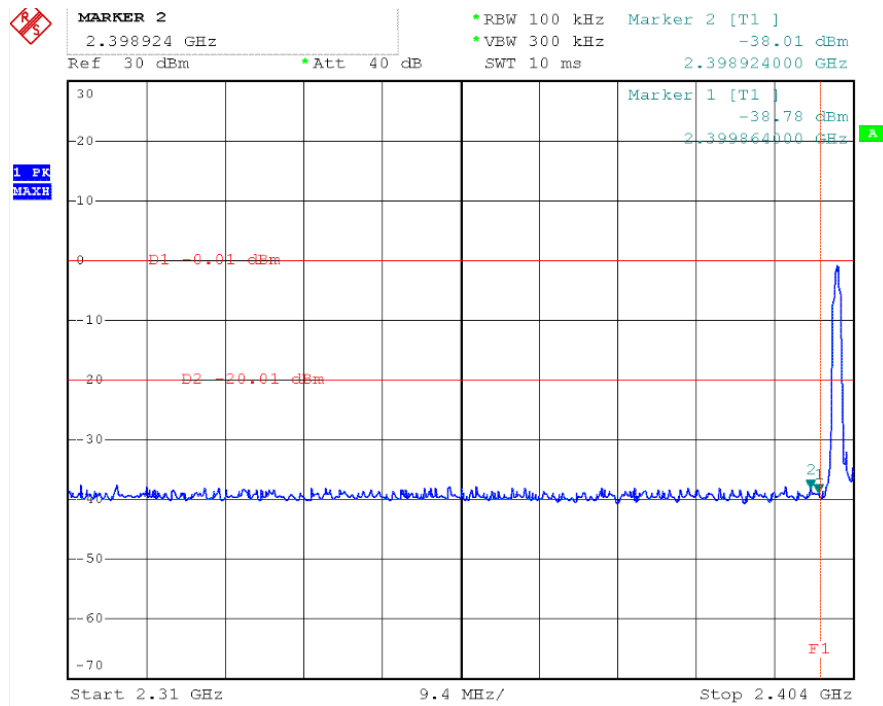

### High Channel

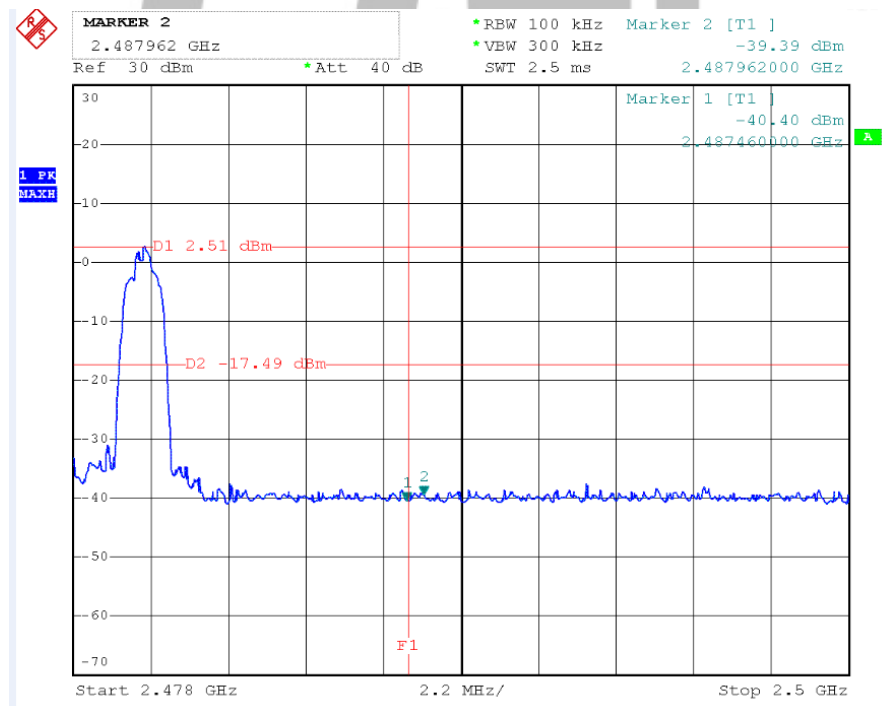

### EDR 3M Low Channel

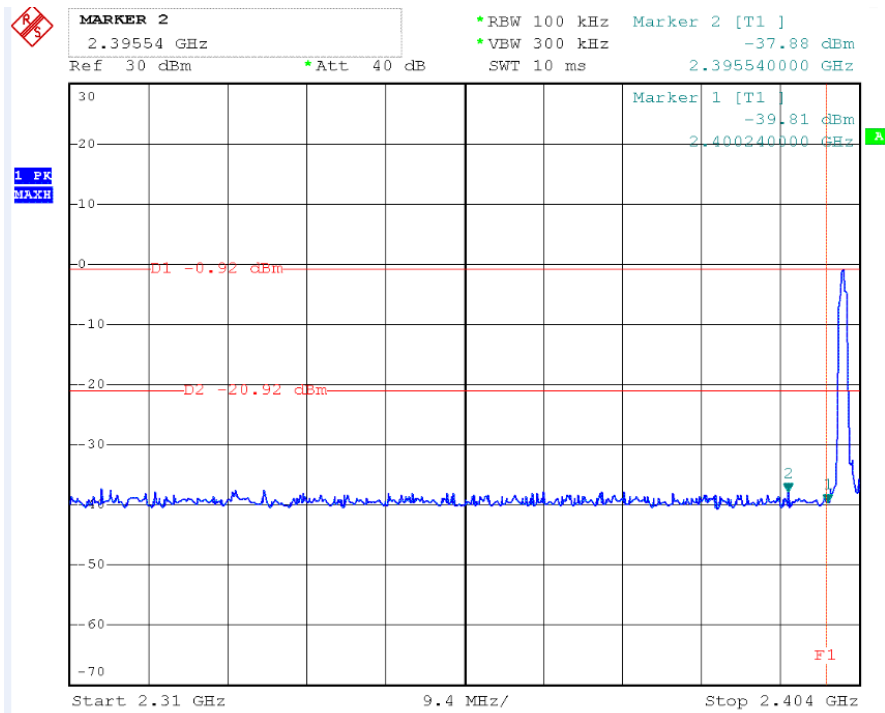

### High Channel

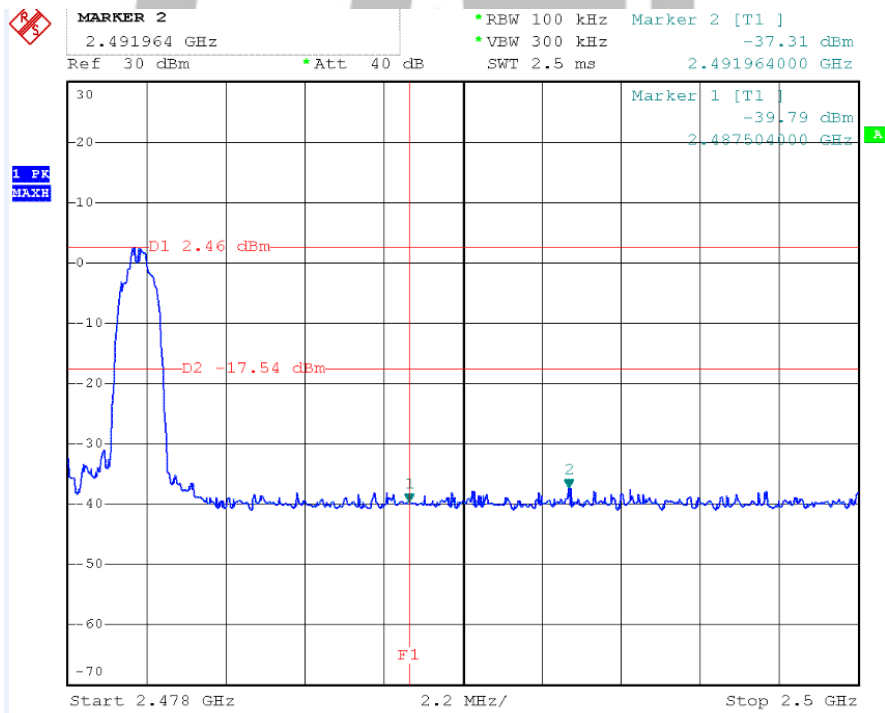



### Hopping Mode Worst case EDR 2M Low

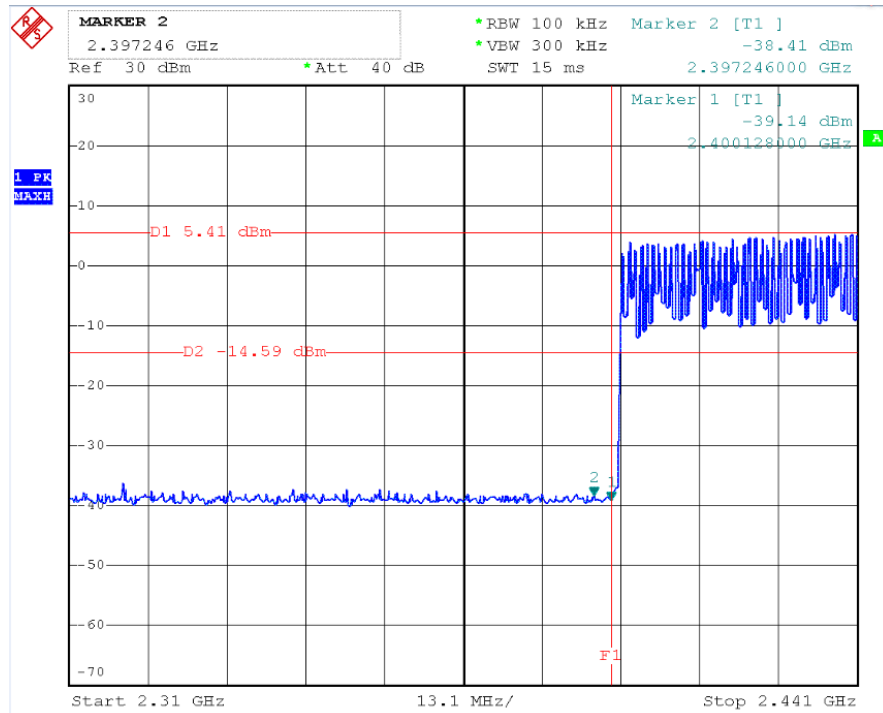

### High

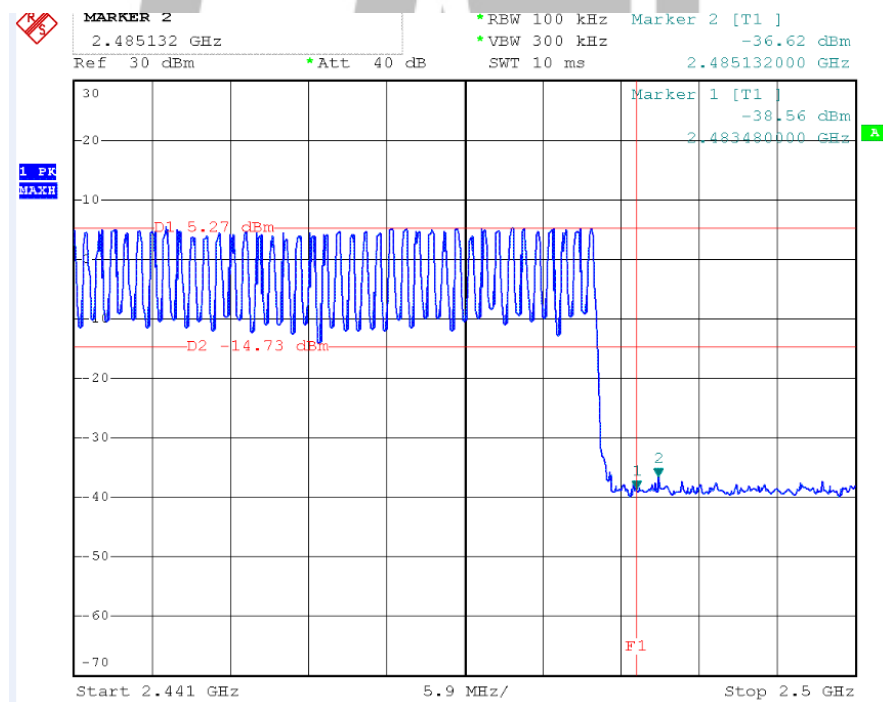

# 11. Test of Spurious Radiated Emission

## 11.1 Applicable Standard

Section 15.247(d): In any 100 kHz bandwidth outside the frequency band in which the spread spectrum or digitally modulated intentional radiator is operating, the radio frequency power that is produced by the intentional radiator shall be at least 20 dB below that in the 100 kHz bandwidth within the band that contains the highest level of the desired power, based on either an RF conducted or a radiated measurement. In addition, radiated emissions that fall in the restricted bands, as defined in Section 15.205, must also comply with the radiated emission limits specified in Section 15.209.

## 11.2 EUT Setup

### Conducted Measurement Setup



### Radiated Measurement Setup

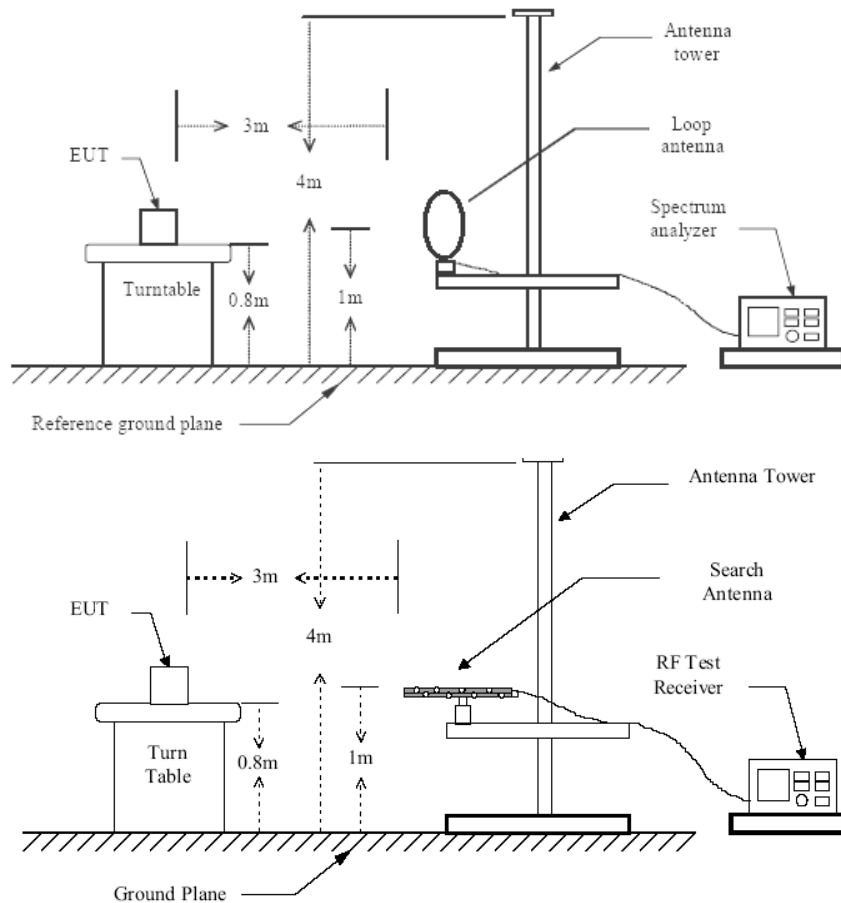

Figure 1 : Frequencies measured below 1 GHz configuration

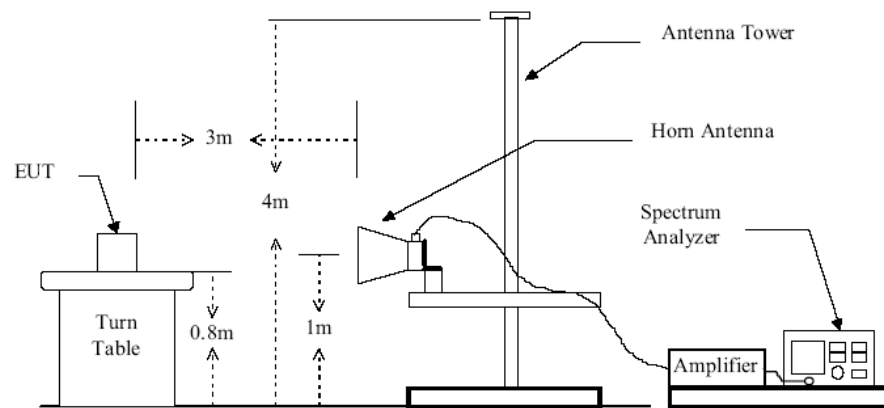

Figure 2 : Frequencies measured above 1 GHz configuration

### 11.3 Test Equipment List and Details

See section 2.5.

### 11.4 Test Procedure

#### Conducted Measurement

1. For emission above 1GHz to 26G,conducted measurement method is used.
2. The transmitter is set to the lowest channel.
3. The transmitter output was connected to the spectrum analyzer via a cable and cable loss is used as the offset of the spectrum analyzer.
4. Set RBW to 1 MHz and VBW to 3 MHz, Then detector set to peak and max hold this trace.
5. The lowest band edges emission was measured and recorded.
6. The transmitter set to the highest channel and repeated 2~4.

#### Radiated Measurement

1. Configure the EUT according to ANSI C63.4-2003
2. The EUT was placed on the top of the turntable 0.8 meter above ground.
3. Receiving antenna mounted on the top of a height-variable antenna tower was placed 3 meters far away from the turntable. When the frequency spectrum measured started from 9 kHz to 30 MHz, a loop antenna is used. When the frequency spectrum measured started from 30 MHz to 1000 MHz and above 1000 MHz, a broadband receiving antenna and the horn antenna are used.
4. Power on the EUT and all the supporting units.
5. The turntable was rotated by 360 degrees to determine the position of the highest radiation.
6. The height of the broadband receiving antenna was varied between one meter and four meters above ground to find the maximum emission field strength of both horizontal and vertical polarization.
7. For each suspected emission, the antenna tower was scanned (from 1 M to 4 M) and then the turntable was rotated (from 0 degree to 360 degrees) to find the maximum reading.

8. According to the characteristic of the EUT crystals, the range of frequencies was investigated from 9KHz to 30MHz, 30MHz to 1GHz and 1GHz to 26GHz.

9. For emission below 1GHz, Set the test-receiver system to Peak or CISPR quasi-peak Detect Function with specified bandwidth under Maximum Hold Mode.

10. For emission above 1GHz, Set the RBW=1MHz,VBW=3MHz for Peak Detector while the RBW=1MHz, VBW=10Hz for Average Detector, Readings are both peak and average values.

11. The pre-test have done for the EUT in three axes and found the worst emission at position shown in test setup photos. The worst case data is recorded in the report. All emission not reported are much lower than the prescribed limits.

### 11.5 Test Result

Temperature ( °C ) : 22~23	EUT: Sporty Stereo Bluetooth Headset
Humidity (%RH) : 50~54	M/N: G23S
Barometric Pressure ( mbar ) : 950~1000	Operation Condition: TX Mode

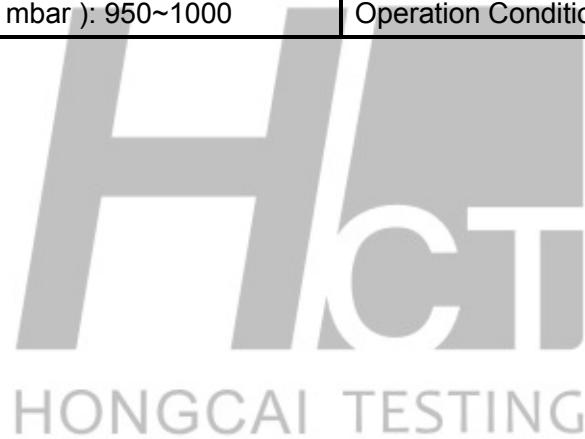

The worst Spurious Emission Data BDR Mode Below 1GHz Channel Low:

EUT: Sporty Stereo Bluetooth Headset  
M/N: G23S  
Operating Condition: TX Mode  
Test Site: 3m CHAMBER  
Operator: Chen  
Test Specification: DC 5V/1A from micro USB  
Comment: Polarization: Horizontal

**SWEEP TABLE: "test (30M-1G)"**

Short Description:		Field Strength			
Start	Stop	Detector	Meas. Time	IF Bandw.	Transducer
30.0 MHz	1.0 GHz	MaxPeak	Coupled	100 kHz	9163-2015

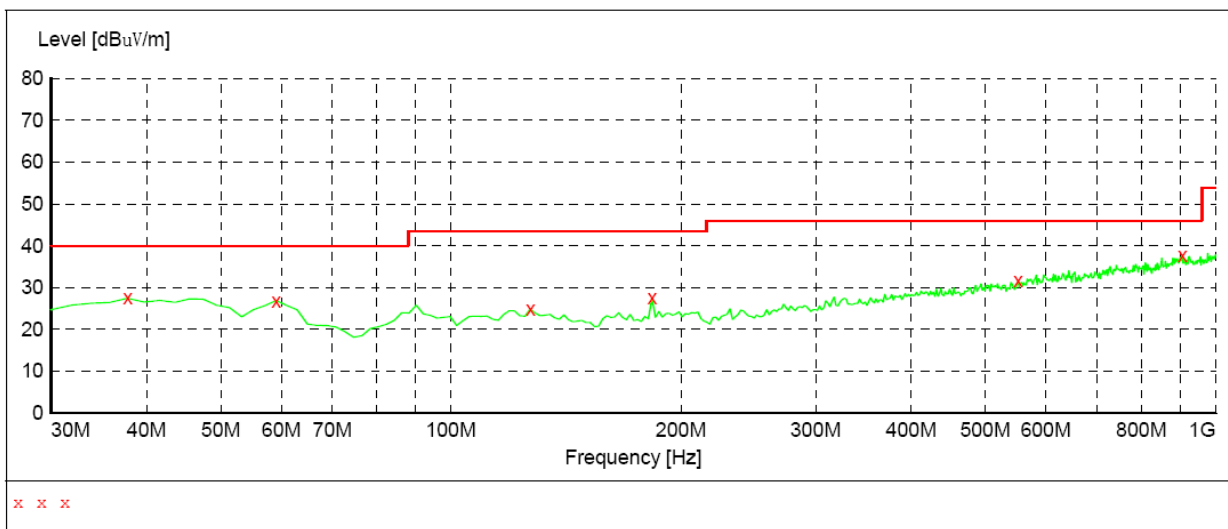

**MEASUREMENT RESULT:**

Frequency MHz	Level dBuV/m	Transd dB	Limit dBuV/m	Margin dB	Det.	Height cm	Azimuth deg	Polarization
37.760000	27.50	13.7	40.0	12.5	QP	300.0	0.00	HORIZONTAL
59.100000	26.90	15.7	40.0	13.1	QP	100.0	0.00	HORIZONTAL
127.000000	24.90	12.9	43.5	18.6	QP	300.0	0.00	HORIZONTAL
183.260000	27.50	12.7	43.5	16.0	QP	100.0	0.00	HORIZONTAL
551.860000	31.60	20.5	46.0	14.4	QP	100.0	0.00	HORIZONTAL
904.940000	37.70	25.8	46.0	8.3	QP	100.0	0.00	HORIZONTAL

The worst Spurious Emission Data BDR Mode Below 1GHz Channel Low:

EUT: Sporty Stereo Bluetooth Headset  
M/N: G23S  
Operating Condition: TX Mode  
Test Site: 3m CHAMBER  
Operator: Chen  
Test Specification: DC 5V/1A from micro USB  
Comment: Polarization: Vertical

**SWEEP TABLE: "test (30M-1G)"**

Start Frequency	Stop Frequency	Detector	Meas. Time	IF Bandw.	Field Strength Transducer
30.0 MHz	1.0 GHz	MaxPeak	Coupled	100 kHz	9163-2015

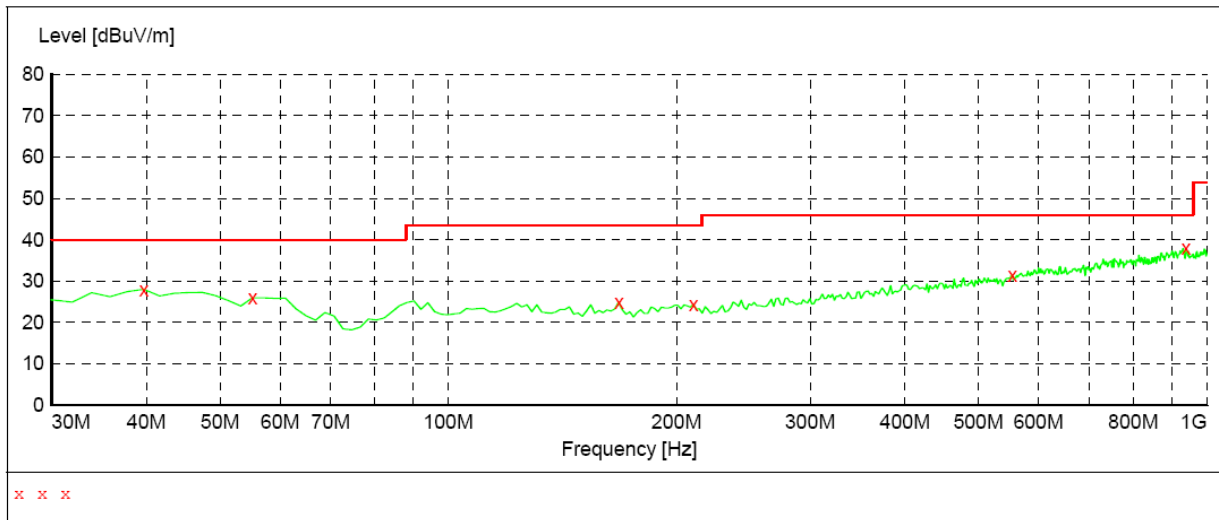

**MEASUREMENT RESULT:**

Frequency MHz	Level dBuV/m	Transd dB	Limit dBuV/m	Margin dB	Det.	Height cm	Azimuth deg	Polarization
39.700000	28.00	15.7	40.0	12.0	QP	100.0	0.00	VERTICAL
55.220000	26.00	15.1	40.0	14.0	QP	100.0	0.00	VERTICAL
167.740000	24.90	12.7	43.5	18.6	QP	100.0	0.00	VERTICAL
210.420000	24.40	14.0	43.5	19.1	QP	100.0	0.00	VERTICAL
553.800000	31.40	20.4	46.0	14.6	QP	100.0	0.00	VERTICAL
937.920000	37.90	25.4	46.0	8.1	QP	100.0	0.00	VERTICAL

The worst Spurious Emission Data BDR Mode Below 1GHz Channel Middle:

EUT: Sporty Stereo Bluetooth Headset  
M/N: G23S  
Operating Condition: TX Mode  
Test Site: 3m CHAMBER  
Operator: Chen  
Test Specification: DC 5V/1A from micro USB  
Comment: Polarization: Horizontal

**SWEEP TABLE: "test (30M-1G)"**

Short Description:		Field Strength			
Start	Stop	Detector	Meas. Time	IF Bandw.	Transducer
30.0 MHz	1.0 GHz	MaxPeak	Coupled	100 kHz	9163-2015

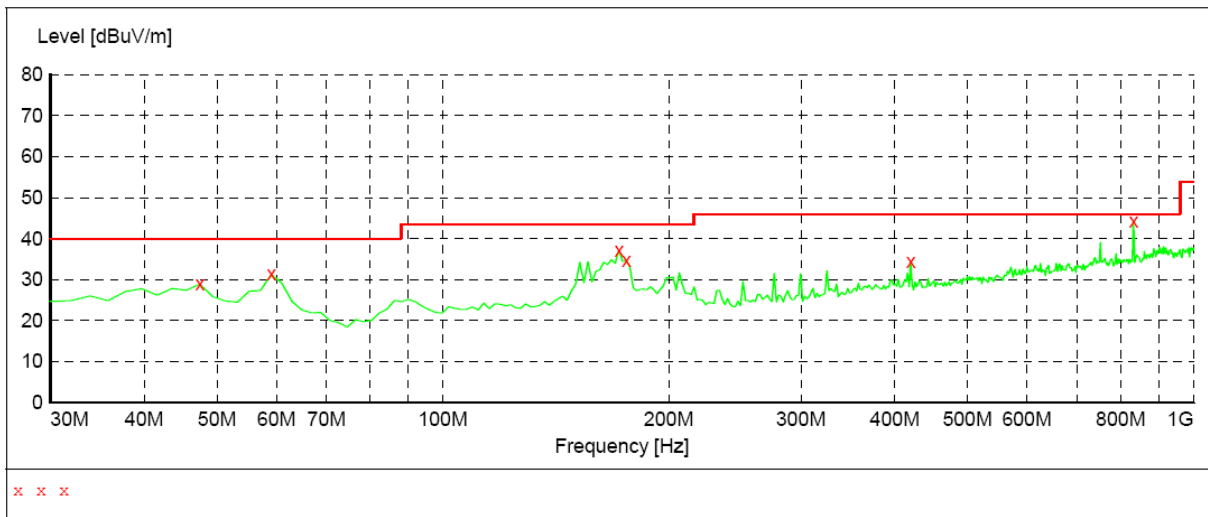

**MEASUREMENT RESULT:**

Frequency MHz	Level dBuV/m	Transd dB	Limit dBuV/m	Margin dB	Det.	Height cm	Azimuth deg	Polarization
47.460000	28.90	16.7	40.0	11.1	QP	300.0	0.00	HORIZONTAL
59.100000	31.30	15.7	40.0	8.7	QP	300.0	0.00	HORIZONTAL
171.620000	37.20	12.5	43.5	6.3	QP	300.0	0.00	HORIZONTAL
175.500000	34.60	12.4	43.5	8.9	QP	100.0	0.00	HORIZONTAL
419.940000	34.40	18.2	46.0	11.6	QP	100.0	0.00	HORIZONTAL
831.220000	44.20	24.1	46.0	1.8	QP	100.0	0.00	HORIZONTAL

The worst Spurious Emission Data BDR Mode Below 1GHz Channel Middle:

EUT: Sporty Stereo Bluetooth Headset  
M/N: G23S  
Operating Condition: TX Mode  
Test Site: 3m CHAMBER  
Operator: Chen  
Test Specification: DC 5V/1A from micro USB  
Comment: Polarization: Vertical

**SWEEP TABLE: "test (30M-1G)"**

Short Description:		Field Strength			
Start	Stop	Detector	Meas. Time	IF Bandw.	Transducer
Frequency	Frequency				
30.0 MHz	1.0 GHz	MaxPeak	Coupled	100 kHz	9163-2015

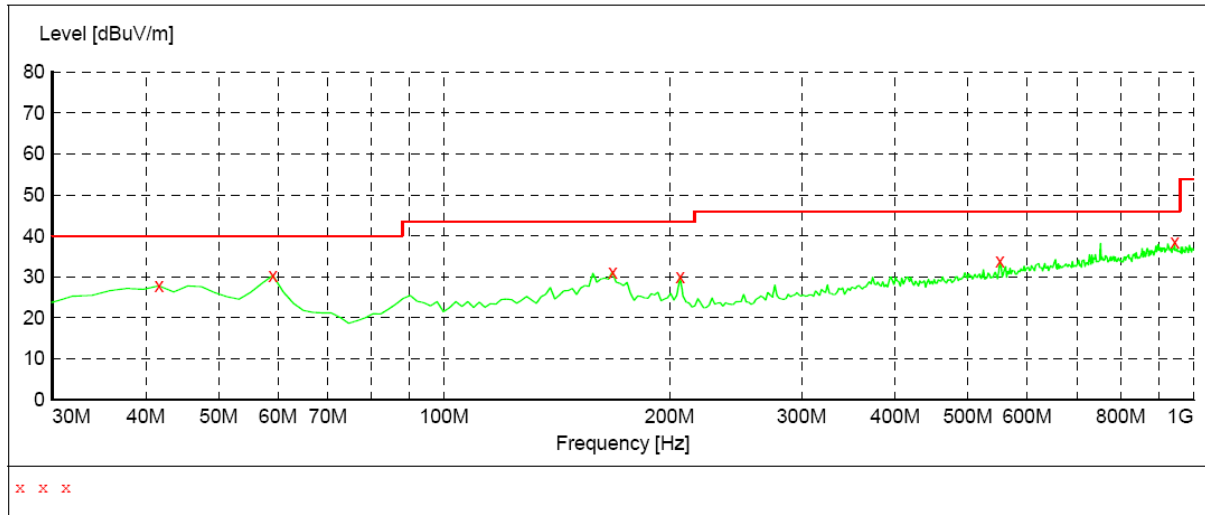

**MEASUREMENT RESULT:**

Frequency MHz	Level dBuV/m	Transd dB	Limit dBuV/m	Margin dB	Det.	Height cm	Azimuth deg	Polarization
41.640000	27.80	15.4	40.0	12.2	QP	100.0	0.00	VERTICAL
59.100000	30.30	15.7	40.0	9.7	QP	100.0	0.00	VERTICAL
167.740000	31.20	12.7	43.5	12.3	QP	100.0	0.00	VERTICAL
206.540000	30.00	14.1	43.5	13.5	QP	100.0	0.00	VERTICAL
551.860000	33.80	20.5	46.0	12.2	QP	100.0	0.00	VERTICAL
943.740000	38.40	25.3	46.0	7.6	QP	100.0	0.00	VERTICAL



The worst Spurious Emission Data BDR Mode Below 1GHz Channel High:

EUT: Sporty Stereo Bluetooth Headset  
M/N: G23S  
Operating Condition: TX Mode  
Test Site: 3m CHAMBER  
Operator: Chen  
Test Specification: DC 5V/1A from micro USB  
Comment: Polarization: Horizontal

**SWEEP TABLE: "test (30M-1G) "**

Short Description:		Field Strength			
Start	Stop	Detector	Meas. Time	IF Bandw.	Transducer
30.0 MHz	1.0 GHz	MaxPeak	Coupled	100 kHz	9163-2015

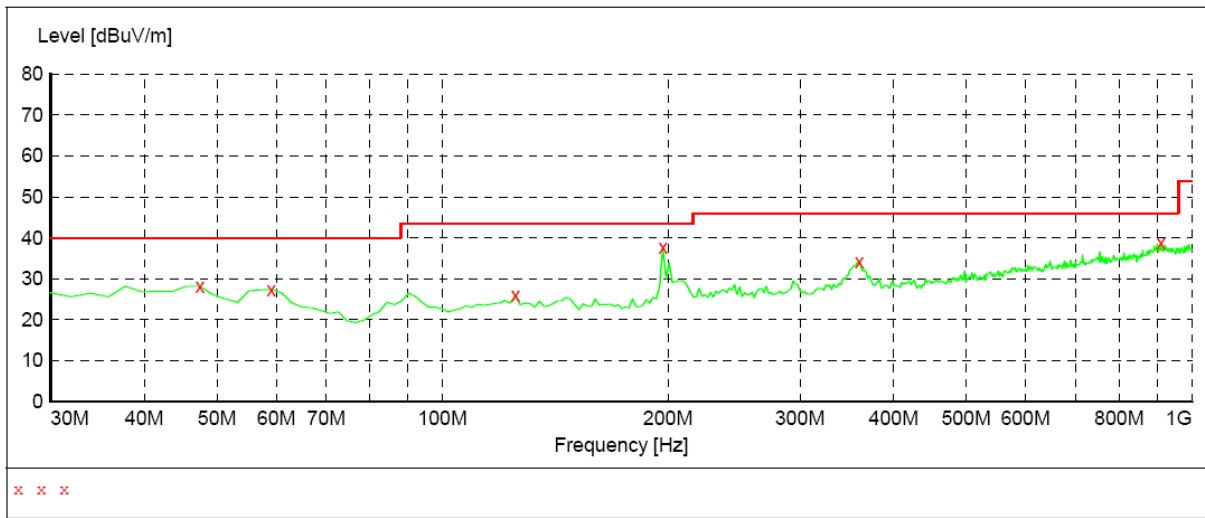

**MEASUREMENT RESULT:**

Frequency MHz	Level dBuV/m	Transd dB	Limit dBuV/m	Margin dB	Det.	Height cm	Azimuth deg	Polarization
47.460000	28.20	16.7	40.0	11.8	QP	100.0	0.00	HORIZONTAL
59.100000	27.40	15.7	40.0	12.6	QP	300.0	0.00	HORIZONTAL
125.060000	25.90	13.0	43.5	17.6	QP	100.0	0.00	HORIZONTAL
196.840000	37.70	13.8	43.5	5.8	QP	100.0	0.00	HORIZONTAL
359.800000	34.20	16.6	46.0	11.8	QP	100.0	0.00	HORIZONTAL
908.820000	38.80	25.8	46.0	7.2	QP	300.0	0.00	HORIZONTAL

The worst Spurious Emission Data BDR Mode Below 1GHz Channel High:

EUT: Sporty Stereo Bluetooth Headset  
 M/N: G23S  
 Operating Condition: TX Mode  
 Test Site: 3m CHAMBER  
 Operator: Chen  
 Test Specification: DC 5V/1A from micro USB  
 Comment: Polarization: Vertical

**SWEEP TABLE: "test (30M-1G)"**

Short Description:		Field Strength			
Start	Stop	Detector	Meas. Time	IF Bandw.	Transducer
Frequency	Frequency				
30.0 MHz	1.0 GHz	MaxPeak	Coupled	100 kHz	9163-2015

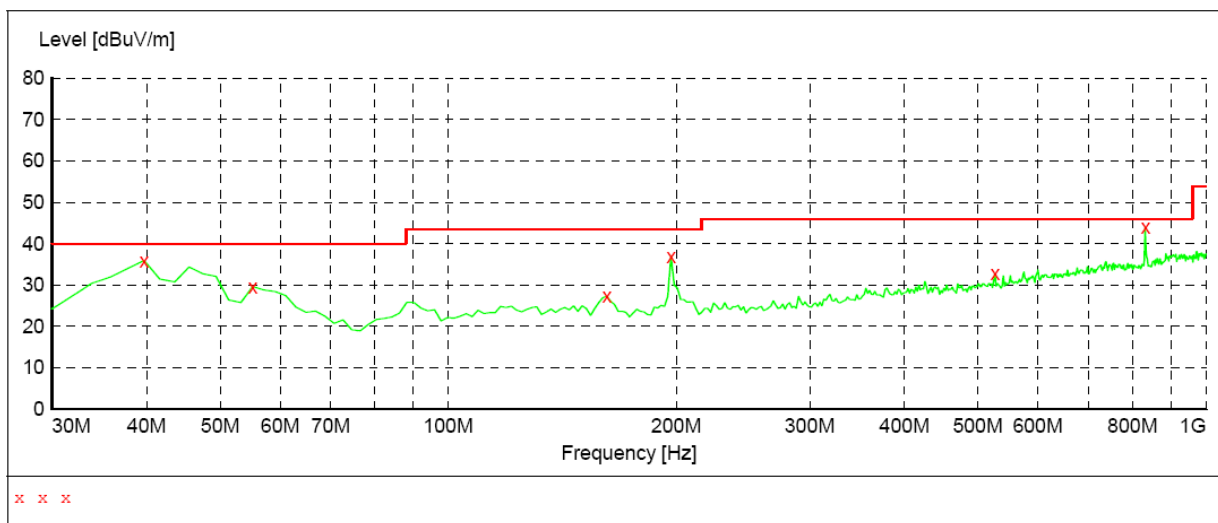

**MEASUREMENT RESULT:**

Frequency MHz	Level dBuV/m	Transd dB	Limit dBuV/m	Margin dB	Det.	Height cm	Azimuth deg	Polarization
39.700000	35.90	15.7	40.0	4.1	QP	100.0	0.00	VERTICAL
55.220000	29.60	15.1	40.0	10.4	QP	100.0	0.00	VERTICAL
161.920000	27.30	12.9	43.5	16.2	QP	100.0	0.00	VERTICAL
196.840000	37.00	13.8	43.5	6.5	QP	100.0	0.00	VERTICAL
526.640000	32.70	19.7	46.0	13.3	QP	100.0	0.00	VERTICAL
831.220000	44.00	24.1	46.0	2.0	QP	100.0	0.00	VERTICAL

The worst Spurious Emission Data BDR Mode Above 1GHz

Channel Low

Channel Low (2402MHz)								
Maximum Frequency (MHz)	Polarity and Level					Limit (dB $\mu$ V/m)	Margin (dB $\mu$ V/m)	Mark (P/Q/A)
	Polarity	Height (m)	Reading dB $\mu$ V	Transd	Result dB $\mu$ V/m			
2402	H	1	98.52	-7.15	91.37	N/A	N/A	P
			90.36	-7.15	83.21	N/A	N/A	A
2402	V	1	105.33	-7.15	98.18	N/A	N/A	P
			96.37	-7.15	89.22	N/A	N/A	A
4804	H	1	41.38	1.07	42.45	74	-31.55	P
			31.25	1.07	32.32	54	-21.68	A
4804	V	1	42.83	1.07	43.9	74	-30.1	P
			32.45	1.07	33.52	54	-20.48	A
7206	H	1	40.59	7.38	47.97	74	-26.03	P
			31.85	7.38	39.23	54	-14.77	A
7206	V	1	43.58	7.38	50.96	74	-23.04	P
			32.33	7.38	39.71	54	-14.29	A
9608	H	1	40.89	10.29	51.18	74	-22.82	P
			30.67	10.29	40.96	54	-13.04	A
9608	V	1	42.59	7.38	49.97	74	-24.03	P
			32.85	7.38	40.23	54	-13.77	A
12023.31	H	1	41.58	14.01	55.59	74	-18.41	P
			31.33	14.01	45.34	54	-8.66	A
12023.33	V	1	42.85	14.01	56.86	74	-17.14	P
			32.58	14.01	46.59	54	-7.41	A
25220.37	----	----	----	----	----	----	----	----

Remark: 1. Transd.=Antenna Factor+Cable Loss-Pre-amplifier  
 Margin = Level-Limit  
 Mark: P means Peak Value, Q means Quasi Peak Value, A means Average Value  
 2. Data of measurement within this frequency range shown “-” in the table above means the reading of emissions are attenuated more than 20dB below the permissible limits or the field strength is too small to be measured.  
 3. Spectrum analyzer setting P(Peak): RBW=1MHz, VBW=1MHz, A(Average): RBW=1MHz, VBW=10Hz.  
 4. The test limit distance is 3m limit

Channel Mid

Channel Middle (2441MHz)								
Maximum Frequency (MHz)	Polarity and Level					Limit (dB $\mu$ V/m)	Margin (dB $\mu$ V/m)	Mark (P/Q/A)
	Polarity	Height (m)	Reading dB $\mu$ V	Transd	Result dB $\mu$ V/m			
2441	H	1	99.54	-6.37	93.17	N/A	N/A	P
			91.37	-6.37	85	N/A	N/A	A
2441	V	1	104.35	-6.37	97.98	N/A	N/A	P
			95.88	-6.37	89.51	N/A	N/A	A
4882	H	1	40.25	1.07	41.32	74	-32.68	P
			30.84	1.07	31.91	54	-22.09	A
4882	V	1	42.54	1.07	43.61	74	-30.39	P
			32.33	1.07	33.4	54	-20.6	A
7323	H	1	41.39	7.49	48.88	74	-25.12	P
			31.54	7.49	39.03	54	-14.97	A
7323	V	1	43.58	7.49	51.07	74	-22.93	P
			32.28	7.49	39.77	54	-14.23	A
9764	H	1	41.24	10.47	51.71	74	-22.29	P
			30.36	10.47	40.83	54	-13.17	A
9764	V	1	42.78	10.47	53.25	74	-20.75	P
			32.84	10.47	43.31	54	-10.69	A
12168.22	H	1	41.15	14.1	55.25	74	-18.75	P
			30.75	14.1	44.85	54	-9.15	A
12168.22	V	1	43.64	14.1	57.74	74	-16.26	P
			31.38	14.1	45.48	54	-8.52	A
25380.37	----	----	----	----	----	----	----	----

Remark: 1. Transd.=Antenna Factor+Cable Loss-Pre-amplifier  
Margin = Level-Limit  
Mark: P means Peak Value, Q means Quasi Peak Value, A means Average Value  
2. Data of measurement within this frequency range shown “-” in the table above means the reading of emissions are attenuated more than 20dB below the permissible limits or the field strength is too small to be measured.  
3. Spectrum analyzer setting P(Peak): RBW=1MHz, VBW=1MHz, A(Average): RBW=1MHz, VBW=10Hz.  
4. The test limit distance is 3m limit

Channel High

Channel High (2480MHz)								
Maximum Frequency (MHz)	Polarity and Level					Limit (dB $\mu$ V/m)	Margin (dB $\mu$ V/m)	Mark (P/Q/A)
	Polarity	Height (m)	Reading dB $\mu$ V	Transd	Result dB $\mu$ V/m			
2480	H	1	98.54	-6.05	92.49	N/A	N/A	P
			90.75	-6.05	84.7	N/A	N/A	A
2480	V	1	102.88	-6.05	96.83	N/A	N/A	P
			93.45	-6.05	87.4	N/A	N/A	A
4960	H	1	40.59	1.07	41.66	74	-32.34	P
			31.25	1.07	32.32	54	-21.68	A
4960	V	1	43.45	1.07	44.52	74	-29.48	P
			32.57	1.07	33.64	54	-20.36	A
7440	H	1	40.85	7.61	48.46	74	-25.54	P
			30.84	7.61	38.45	54	-15.55	A
7440	V	1	42.58	7.61	50.19	74	-23.81	P
			32.79	7.61	40.4	54	-13.6	A
9920	H	1	41.38	10.65	52.03	74	-21.97	P
			31.94	10.65	42.59	54	-11.41	A
9920	V	1	43.85	10.65	54.5	74	-19.5	P
			32.97	10.65	43.62	54	-10.38	A
12361.67	H	1	41.58	14.19	55.77	74	-18.23	P
			31.78	14.19	45.97	54	-8.03	A
12361.67	V	1	42.89	14.19	57.08	74	-16.92	P
			32.74	14.19	46.93	54	-7.07	A
25380.37	----	----	----	----	----	----	----	----

Remark: 1. Transd.=Antenna Factor+Cable Loss-Pre-amplifier  
 Margin = Level-Limit  
 Mark: P means Peak Value, Q means Quasi Peak Value, A means Average Value  
 2. Data of measurement within this frequency range shown “-” in the table above means the reading of emissions are attenuated more than 20dB below the permissible limits or the field strength is too small to be measured.  
 3. Spectrum analyzer setting P(Peak): RBW=1MHz, VBW=1MHz, A(Average): RBW=1MHz, VBW=10Hz.  
 4. The test limit distance is 3m limit

The worst Spurious Emission Data BDR Mode Below 30 MHz

Frequency (MHz)	Read Level (dBuV)	Antenna Factor (dB/m)	Cable Loss (dB)	Emission Levels (dBuV/m)	Limit (dBµV/m)	Margin (dB)	Detector Mode
5.45	21.68	8.23	1.03	28.88	67	-38.12	QP
14.78	21.54	9.07	1.19	29.42	49.5	-20.08	QP
22.31	22.37	9.25	1.08	30.54	49.5	-18.96	QP
23.34	22.23	8.43	1.66	29	49.5	-20.5	QP

Note:

1. The pre-test have done for the EUT in three axes and found the worst emission at position shown in test setup photos. The worst case data is recorded in the report.
2. Emission level (dBuV/m) =Raw Value (dBuV) + Correction Factor (dB/m)
3. Correction Factor (dB/m) = Antenna Factor (dB/m) + Cable Factor (dB)
4. The other emission levels were very low against the limit.
5. Margin value = Emission level.- Limit value

**Conducted Spurious Emission  
BR 1M  
Channel Low**

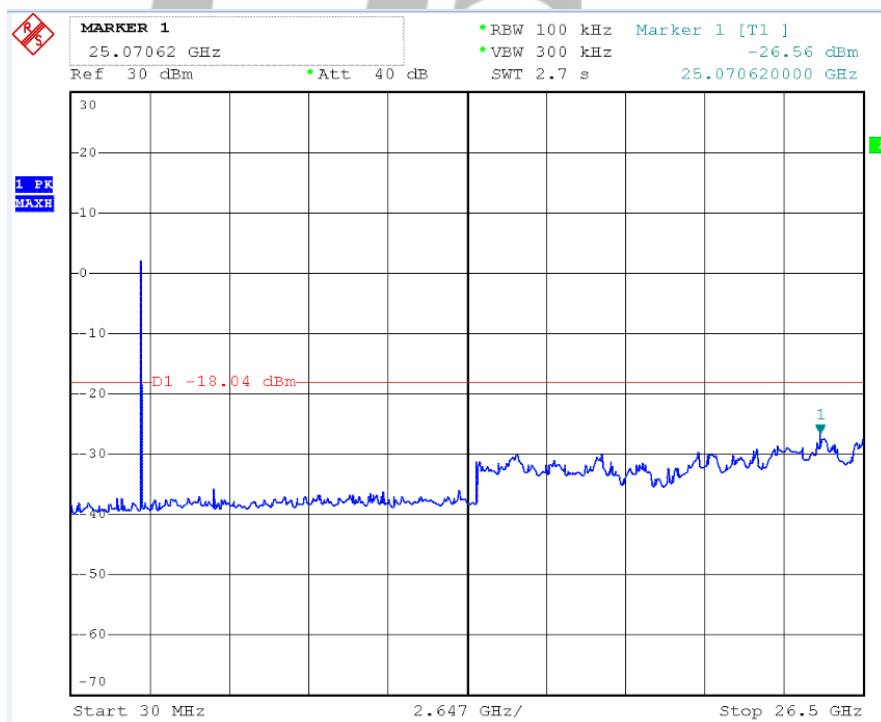

### Channel Mid

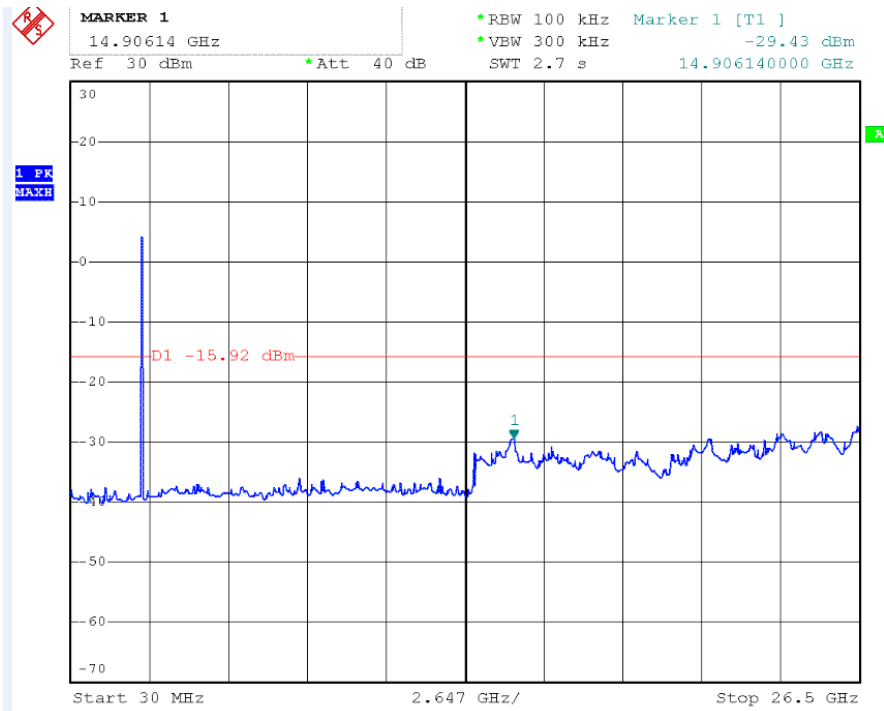

### Channel High

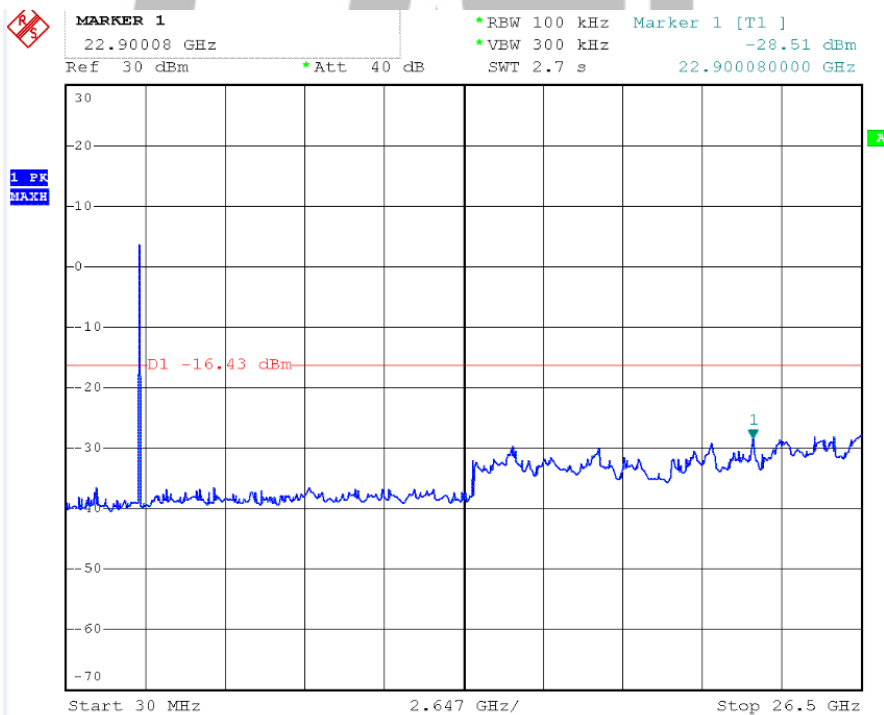

**BDR 2M  
Channel Low**

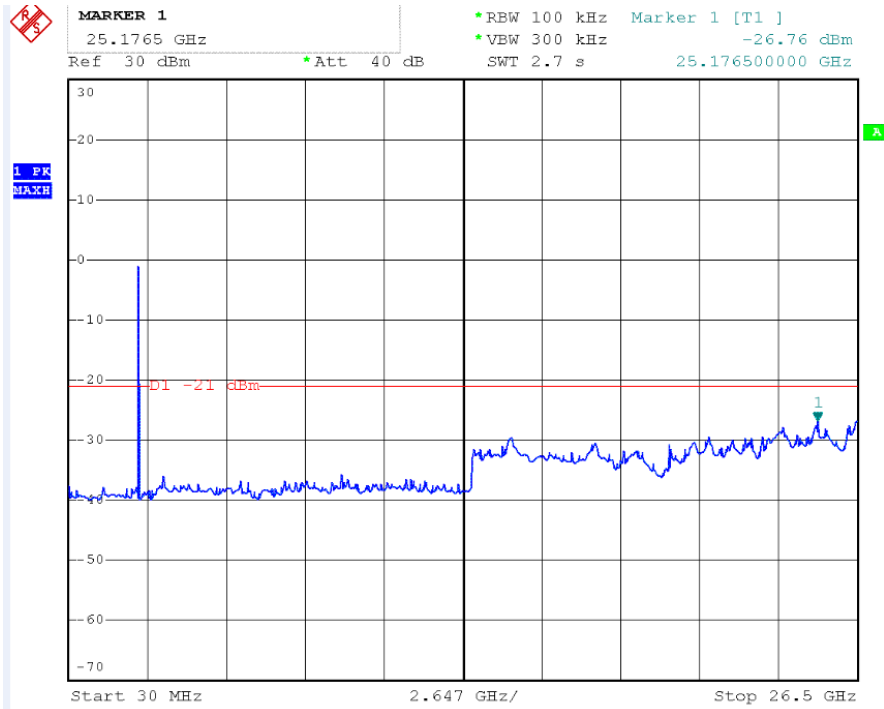

**Channel Middle**

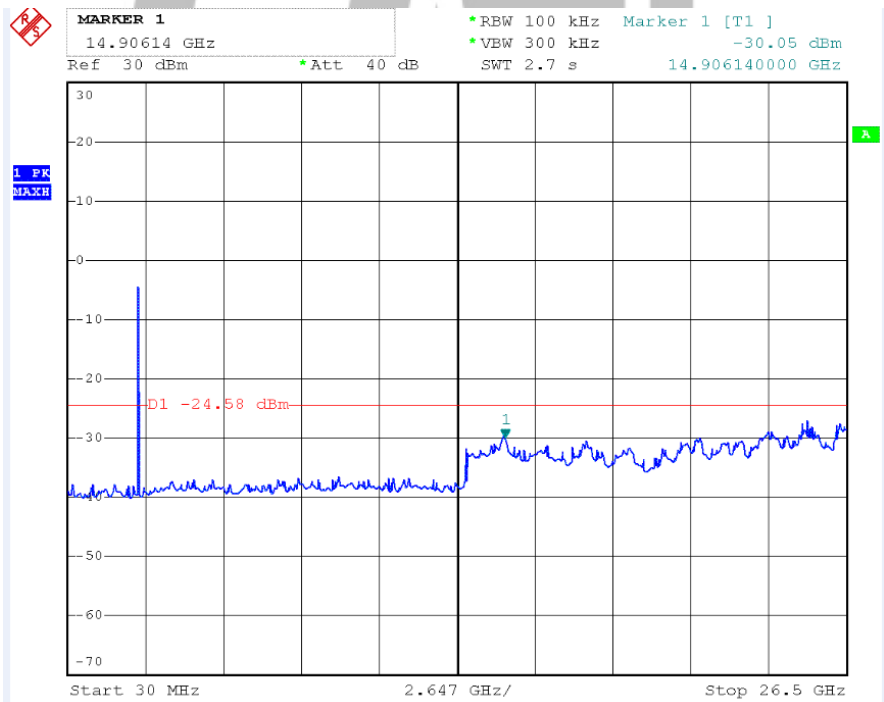



### Channel High

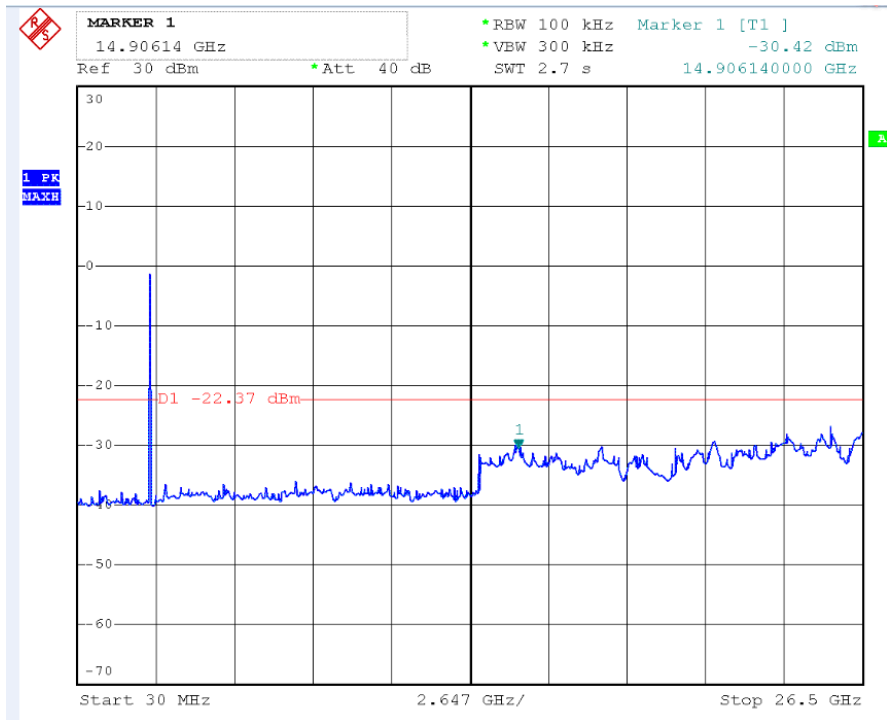

### BDR 3M Channel Low

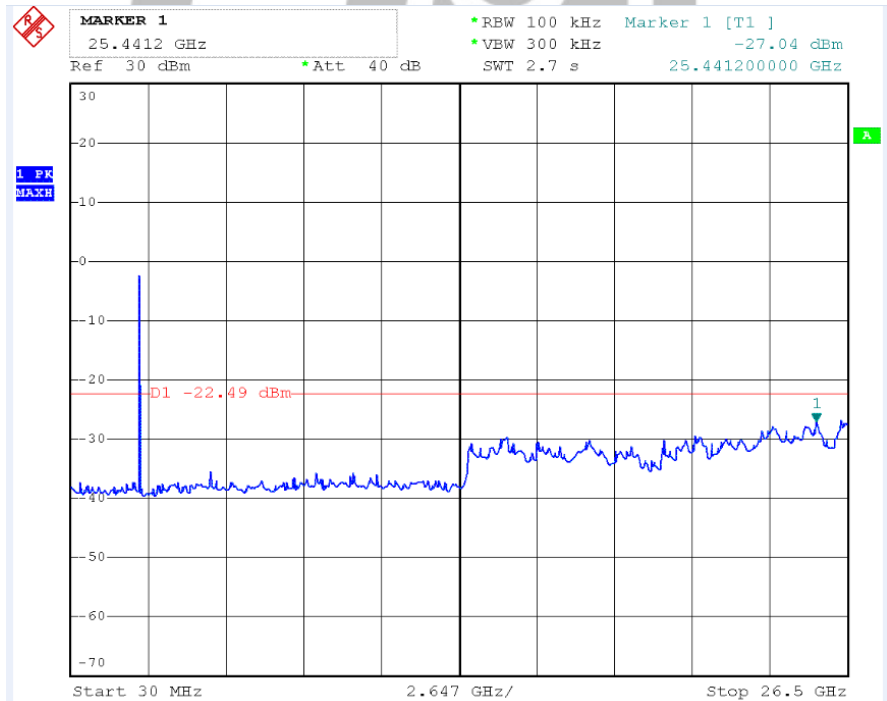

### Channel Middle

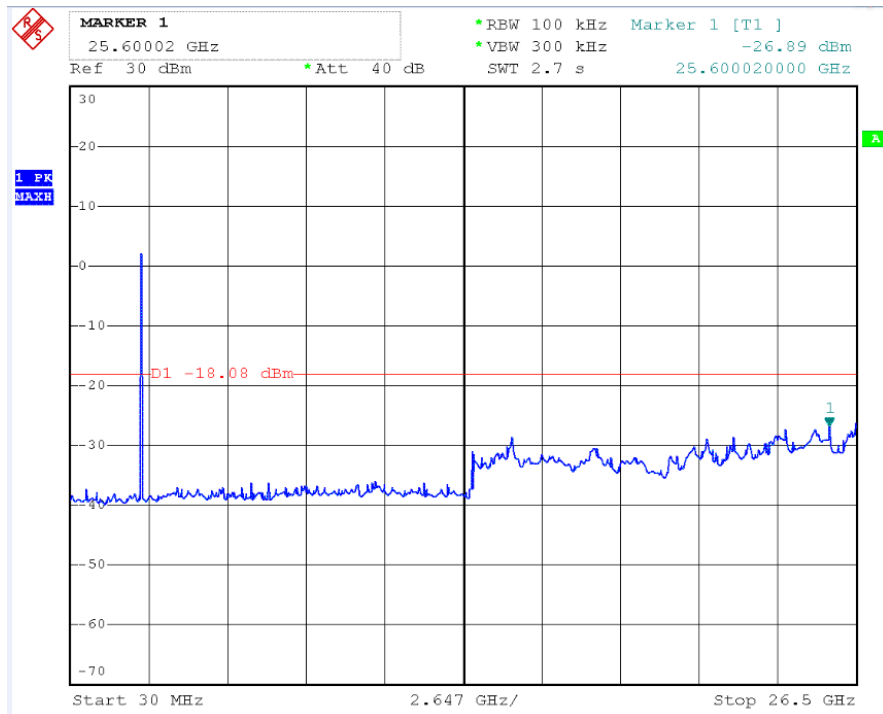

### Channel High

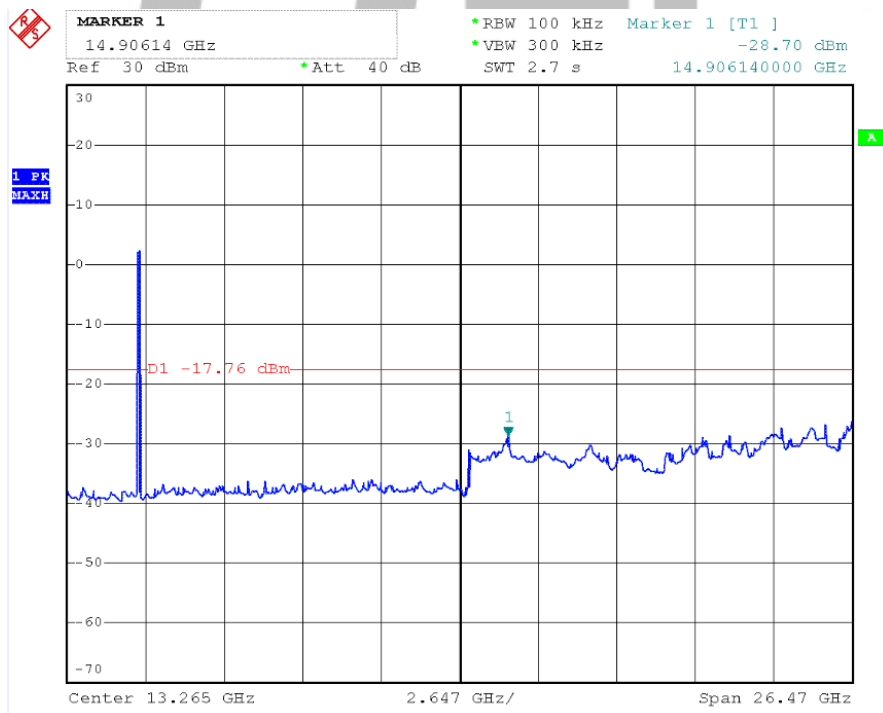

## 12. ANTENNA REQUIREMENT

### 12.1 Standard Applicable

Section 15.203:

An intentional radiator shall be designed to ensure that no antenna other than that furnished by the responsible party shall be used with the device. The use of a permanently attached antenna or of an antenna that uses a unique coupling to the intentional radiator shall be considered sufficient to comply with the provisions of this Section. The manufacturer may design the unit so that a broken antenna can be replaced by the user, but the use of a standard antenna jack or electrical connector is prohibited.

Section 15.247(b)/(c):

If transmitting antennas of directional gain greater than 6 dBi are used, the peak output power from the intentional radiator shall be reduced by the amount in dB that the directional gain of the antenna exceeds 6 dBi.

If the intentional radiator is used exclusively for fixed, point-to-point operations may employ transmitting antennas with directional gain greater than 6 dBi provided the maximum peak output power of the intentional radiator is reduced by 1 dB for every 3 dB that the directional gain of the antenna exceeds 6 dBi.

### 12.2 Antenna Connected Construction

The antenna is designed with permanent attachment and no consideration of replacement. The antenna used in this product is complied with Standard. The maximum Gain of the antenna lower than 6.0dBi and have the definite antenna Specification.

## 13 .Radio Frequency Exposure

### 13.1 Applicable Standard

According to §1.1307(b)(1), systems operating under the provisions of this section shall be operated in a manner that ensures that the public is not exposed to radio frequency energy level in excess of the Commission's guidelines.

According to §RSS-102, Devices that have a radiating element normally operating at separation distances greater than 20 cm between the user and the device shall undergo an RF exposure evaluation. SAR evaluation may be performed in lieu of an RF exposure evaluation for devices operating below 6 GHz with a separation distance of greater than 20 cm between the user and the device.

According to §1.1310, KDB447498 and §2.1093 RF exposure is required.

OET Bulletin 65 Supplement C [June 2001]: Evaluating Compliance with FCC Guidelines for Human Exposure to Radio frequency Electromagnetic Fields

KDB447498 D01 General RF Exposure Guidance v06: RF Exposure Procedures and Equipment Authorization Policies for Mobile and Portable Devices

### 13.2 Limit

According to KDB447498 D01 General RF Exposure Guidance v06 Section 4.3.1 Standalone SAR test exclusion considerations: "Unless specifically required by the published RF exposure KDB procedures, standalone 1-g head or body and 10-g extremity SAR evaluation for general population exposure conditions, by measurement or numerical simulation, is not required when the corresponding SAR Test Exclusion Threshold condition(s), listed below, is (are) satisfied. These test exclusion conditions are based on source-based time-averaged maximum conducted output power of the RF channel requiring evaluation, adjusted for tune-up tolerance, and the minimum test separation distance required for the exposure conditions.28 The minimum test separation distance defined in 4.1 f) is determined by the smallest distance from the antenna and radiating structures or outer surface of the device, according to the host form factor, exposure conditions and platform requirements, to any part of the body or extremity of a user or bystander. To qualify for SAR test exclusion, the test separation distances applied must be fully explained and justified, typically in the SAR measurement or SAR analysis report, by the operating configurations and exposure conditions of the transmitter and applicable host platform requirements, according to the required published RF exposure KDB procedures. When no other RF exposure testing or reporting are required, a statement of justification and compliance must be included in the equipment approval, in lieu of the SAR report, to qualify for SAR test exclusion. When required, the device specific conditions described in the other published RF exposure KDB procedures must be satisfied before applying these SAR test exclusion provisions; for example, handheld PTT two-way radios, handsets, laptops and tablets, etc.29 "

1) The 1-g and 10-g SAR test exclusion thresholds for 100 MHz to 6 GHz at test separation distances  $\leq 50$ mm are determined by:

$[(\text{max. power of channel, including tune-up tolerance, mW})/(\text{min. test separation distance, mm})] \cdot [\sqrt{f(\text{GHz})}] \leq 3.0$  for 1-g SAR and  $\leq 7.5$  for 10-g extremity SAR,30 where

- $f(\text{GHz})$  is the RF channel transmit frequency in GHz
- Power and distance are rounded to the nearest mW and mm before calculation31
- The result is rounded to one decimal place for comparison
- The values 3.0 and 7.5 are referred to as numeric thresholds in step b) below

The test exclusions are applicable only when the minimum test separation distance is  $\leq 50$  mm and for transmission frequencies between 100 MHz and 6 GHz. When the minimum test separation distance is  $< 5$ mm, a distance of 5 mm according to 5) in section 4.1 is applied to determine SAR test exclusion. According to KDB447498 D01 General RF Exposure Guidance v06 Appendix A: SAR Test

Exclusion .Thresholds for 100 MHz-6 GHz and  $\leq 50$  mm, Approximate SAR Test Exclusion Power Thresholds at Selected Frequencies and Test Separation Distances are illustrated in the following Table.

MHz	5	10	15	20	25	mm
150	39	77	116	155	194	<i>SAR Test Exclusion Threshold (mW)</i>
300	27	55	82	110	137	
450	22	45	67	89	112	
835	16	33	49	66	82	
900	16	32	47	63	79	
1500	12	24	37	49	61	
1900	11	22	33	44	54	
2450	10	19	29	38	48	
3600	8	16	24	32	40	
5200	7	13	20	26	33	
MHz	30	35	40	45	50	
150	232	271	310	349	387	<i>SAR Test Exclusion Threshold (mW)</i>
300	164	192	219	246	274	
450	134	157	179	201	224	
835	98	115	131	148	164	
900	95	111	126	142	158	
1500	73	86	98	110	122	
1900	65	76	87	98	109	
2450	57	67	77	86	96	
3600	47	55	63	71	79	
5200	39	46	53	59	66	
5400	39	45	52	58	65	
5800	37	44	50	56	62	

**TEST RESULTS**  
**BR1M:**

Test Frequency (MHz)	Output Power (dBm)	Output Power including Power Drift (dBm)	Output Power including Power Drift (mW)	Separation Distance (mm)	Evaluated SAR test exclusion	SAR test exclusion thresholds	Verdict
2402	2.35	2.38	1.72	5	0.53	3	PASS
2441	5.03	5.06	3.20	5	1.00	3	PASS
2480	5.39	5.42	3.48	5	1.10	3	PASS

**EDR2M:**

Test Frequency (MHz)	Output Power (dBm)	Output Power including Power Drift (dBm)	Output Power including Power Drift (mW)	Separation Distance (mm)	Evaluated SAR test exclusion	SAR test exclusion thresholds	Verdict
2402	-0.21	-0.18	0.96	5	0.30	3	PASS
2441	2.70	2.73	1.87	5	0.58	3	PASS
2480	3.04	3.07	2.03	5	0.64	3	PASS

**EDR3M:**

Test Frequency (MHz)	Output Power (dBm)	Output Power including Power Drift (dBm)	Output Power including Power Drift (mW)	Separation Distance (mm)	Evaluated SAR test exclusion	SAR test exclusion thresholds	Verdict
2402	0.06	0.09	1.02	5	0.32	3	PASS
2441	2.85	2.88	1.94	5	0.61	3	PASS
2480	3.22	3.25	2.11	5	0.66	3	PASS

**13.4 Conclusion**

The measurement results comply with the FCC Limit per 47 CFR 2.1093 for the uncontrolled RF Exposure and SAR Exclusion Threshold per KDB447498 D01 General RF Exposure Guidance v06.