



# FCC RADIO TEST REPORT

Applicant : Datto, Inc.  
Address : 101 Merritt 7, Norwalk, CT 06851 USA  
Equipment : WiFi Access Point  
Model No. : A60  
Trade Name :   
FCC ID : WT8OMA60

**I HEREBY CERTIFY THAT :**

The sample was received on Jul. 25, 2017 and the testing was carried out on Jul. 26, 2017 at CerpPASS Technology Corp. The test result refers exclusively to the test presented test model / sample. Without written approval of CerpPASS Technology Corp., the test report shall not be reproduced except in full.

Approved by:

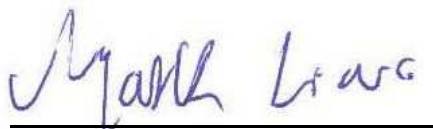

Mark Liao / Assistant Manager

Tested by:

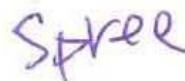

Spree Yei / Engineer

Laboratory Accreditation:

CerpPASS Technology Corporation Test Laboratory





## CONTENTS

- 1. Summary of Test Procedure and Test Results ..... 5
  - 1.1. Applicable Standards ..... 5
- 2. Test Configuration of Equipment under Test ..... 6
  - 2.1. Feature of Equipment under Test..... 6
  - 2.2. Carrier Frequency of Channels ..... 6
  - 2.3. Test Mode and Test Software ..... 7
  - 2.4. Description of Test System..... 7
  - 2.5. General Information of Test..... 8
  - 2.6. Measurement Uncertainty ..... 8
- 3. Test Equipment and Ancillaries Used for Tests ..... 9
- 4. Antenna Requirements ..... 10
  - 4.1. Standard Applicable ..... 10
  - 4.2. Antenna Construction and Directional Gain..... 10
- 5. Test of AC Power Line Conducted Emission ..... 11
  - 5.1. Test Limit ..... 11
  - 5.2. Test Procedures ..... 11
  - 5.3. Typical Test Setup ..... 12
  - 5.4. Test Result and Data ..... 13
  - 5.5. Test Photographs ..... 15
- 6. Test of Spurious Emission (Radiated) ..... 16
  - 6.1. Test Limit ..... 16
  - 6.2. Test Procedures ..... 16
  - 6.3. Typical Test Setup ..... 17
  - 6.4. Test Result and Data (9kHz ~ 30MHz)..... 18
  - 6.5. Test Result and Data (30MHz ~ 1GHz)..... 18
  - 6.6. Test Result and Data (1GHz ~ 40GHz)..... 20
  - 6.7. Restricted Bands of Operation ..... 38
  - 6.8. Test Photographs (30MHz ~ 1GHz) ..... 39
  - 6.9. Test Photographs (1GHz ~ 40GHz) ..... 40
- 7. On Time, Duty Cycle and Measurement methods ..... 41
  - 7.1. Test Limit ..... 41
  - 7.2. Test Procedure ..... 41
  - 7.3. Test Setup Layout ..... 41
  - 7.4. Test Result and Data ..... 41
  - 7.5. Measurement Methods ..... 41
- 8. 26dB Bandwidth ..... 43
  - 8.1. Test Limit ..... 43
  - 8.2. Test Procedure ..... 43
  - 8.3. Test Setup Layout ..... 43
  - 8.4. Test Result and Data ..... 43
- 9. Average Power..... 50
  - 9.1. Test Limit ..... 50
  - 9.2. Test Procedure ..... 50
  - 9.3. Test Setup Layout ..... 50



- 9.4. Test Result and Data ..... 51
- 10. PPSD ..... 53
  - 10.1. Test Limit ..... 53
  - 10.2. Test Procedure ..... 55
  - 10.3. Test Setup Layout ..... 55
  - 10.4. Test Result and Data ..... 55
- 11. Frequency Stability ..... 62
  - 11.1. Test Procedure ..... 62
  - 11.2. Test Setup Layout ..... 62
  - 11.3. Test Result and Data ..... 63
- 12. Automatically Discontinue Transmission ..... 64
  - 12.1. Limit of Automatically Discontinue Transmission ..... 64
  - 12.2. Test Result of Automatically Discontinue Transmission ..... 64
- 13. Radio Frequency Exposure ..... 65
  - 13.1. Applicable Standards ..... 65
  - 13.2. EUT Specification ..... 65
  - 13.3. Test Results ..... 65
  - 13.4. Calculation ..... 66
  - 13.5. Maximum Permissible Exposure ..... 67





# 1. Summary of Test Procedure and Test Results

## 1.1. Applicable Standards

ANSI C63.4:2014

ANSI C63.10:2013

FCC Rules and Regulations Part 15 Subpart E §15.407

First R&O 14-30

KDB662911

KDB789033

KDB644545

FCC Rule	Description of Test	Result
15.203	. Antenna Requirement	Pass
15.207(a)	. AC Power Line Conducted Emission	Pass
15.407(b) 15.209	. Radiated Spurious Emission	Pass
15.407(a)	. 26 dB Occupied Bandwidth	Pass
15.407 (a) & (a)(3)	. Average Power	Pass
15.407(a)	. Output and PPSD	Pass



## 2. Test Configuration of Equipment under Test

### 2.1. Feature of Equipment under Test

Modulation Type	DSSS, OFDM
Frequency Range	802.11b/g/n: 2412-2462MHz 802.11a/an/ac: 5150-5250MHz, 5725-5850MHz
Data Rate	802.11b: 1, 2, 5.5, 11Mbps 802.11g: 6, 9, 12, 18, 24, 36, 48, 54Mbps 802.11n: MCS0 – MCS23, HT20/40 802.11a: 6, 9, 12, 18, 24, 36, 48, 54Mbps 802.11ac: MCS0 – MCS9, VHT 20/40/80)
Antenna Type	PIFA Antenna
Antenna Gain	802.11b/g/n: Antenna 1: 3.0 dBi Antenna 2: 4.6 dBi Antenna 3: 3.3 dBi 802.11a/an/ac: Antenna 1: 5.1 dBi Antenna 2: 4.7 dBi Antenna 3: 4.8 dBi

### 2.2. Carrier Frequency of Channels

Band: 5150MHz-5250MHz

802.11a, 802.11an HT 20, 802.11ac VHT20

Channel	Frequency(MHz)	Channel	Frequency(MHz)
<b>*36</b>	<b>5180</b>	<b>*44</b>	<b>5220</b>
40	5200	<b>*48</b>	<b>5240</b>

802.11an HT 40, 802.11ac VHT40

Channel	Frequency(MHz)	Channel	Frequency(MHz)
<b>*38</b>	<b>5190</b>	<b>*46</b>	<b>5230</b>

802.11ac VHT80

Channel	Frequency(MHz)
<b>*42</b>	<b>5210</b>

Note: Channels remarked \* are selected to perform test.



### 2.3. Test Mode and Test Software

- During testing, the interface cables and equipment positions were varied according to ANSI C63.4.
- The complete test system included remote workstation and EUT for RF test. The remote workstation included Notebook.
- An executive program, "ART2-GUI" under WIN 7 was executed to transmit and receive data via WLAN.
- The following test modes were performed for the test:

Test Mode	Operating Description
1	802.11a (6Mbps)
2	802.11an HT20 (6.5Mbps)
3	802.11an HT40 (13.5Mbps)
4	802.11ac VHT20 (6.5Mbps)
5	802.11ac VHT40 (13.5Mbps)
6	802.11ac VHT80 (29.3Mbps)

For conduction test, caused "Test Mode 1" generated the worst case, it was reported as the final data.

For radiation test (below 1GHz), caused "Test Mode 1" generated the worst case, it was reported as the final data.

For radiation test (above 1GHz), caused "Test Mode 1,4,5,6" generated the worst case, they were reported as the final data.

### 2.4. Description of Test System

Device	Manufacturer	Model No.	Description
Remote workstation			
Notebook	DELL	Latitude E6430	Power Cable, Unshielding, 1.8m

Use Cable:

Cable	Quantity	Description
Notebook	1	Unshielding, 1.2m
Notebook	1	Unshielding, 15.0m

**2.5. General Information of Test**

Test Site	<b>Cerpass Technology Corporation Test Laboratory</b> Address: No.10, Ln. 2, Lianfu St., Luzhu Dist., Taoyuan City 33848, Taiwan (R.O.C.) Tel:+886-3-3226-888 Fax:+886-3-3226-881 Address: No.68-1, Shihbachongsi, Shihding Township, New Taipei City 223, Taiwan, R.O.C. Tel: +886-2-2663-8582	
	FCC	TW1079, TW1061, 390316, 228391, 641184
	IC	4934E-1, 4934E-2
	VCCI	T-2205 for Telecommunication Test C-4663 for Conducted emission test R-4218, R-4399 for Radiated emission test G-812, G-813 for radiated disturbance above 1GHz
Frequency Range Investigated:	Conducted: from 150kHz to 30 MHz Radiation: from 30 MHz to 40,000MHz	
Test Distance:	The test distance of radiated emission from antenna to EUT is 3 M.	

**2.6. Measurement Uncertainty**

Measurement Item	Measurement Frequency	Polarization	Uncertainty
Conducted Emission	9 kHz ~ 30 MHz	Line / Neutral	±2.9076 dB
Radiated Emission	9 kHz ~ 25,000 MHz	Vertical / Horizontal	±0.948 dB
Spurious Emission (Conducted)	-	-	±4.011 dB
Maximum Peak and Average Output Power	-	-	±0.322 dB
Power Spectral Density	-	-	±0.322 dB
Bandwidth	-	-	74.224Hz





### 3. Test Equipment and Ancillaries Used for Tests

Instrument	Manufacturer	Model No.	Serial No.	Calibration Date	Valid Date
EMI Receiver	R&S	ESCI3	100443	2017/03/07	2018/03/06
LISN	Schwarzbeck	NSLK 8127	8127-740	2016/08/30	2017/08/29
LISN	Schwarzbeck	NSLK 8127	8127-516	2016/09/06	2017/09/05
Pulse Limiter	R&S	ESH3-Z2	101934	2017/02/14	2018/02/13
Bilog Antenna	Schwarzbeck	VULB9168	369	2017/03/15	2018/03/14
Active Loop Antenna	EMCO	6507	40855	2017/05/15	2018/05/14
Horn Antenna	EMCO	3115	31601	2016/09/05	2017/09/04
Horn Antenna	EMCO	3116	31970	2017/03/29	2018/03/28
EXA Signal Analyzer	KEYSIGHT	N9010A	MY54200207	2017/03/17	2018/03/16
Preamplifier	EM	EM330	60660	2017/02/25	2018/02/24
Preamplifier	EMC INSTRUMENTS	EMC051845SE	980333	2016/09/13	2017/09/12
Preamplifier	Agilent	8449B	3008A01954	2017/02/09	2018/02/08
Preamplifier	EMC INSTRUMENTS	EMC184045	980065	2016/11/04	2017/11/03
MXG MW Analog Signal Generator	KEYSIGHT	N5183A	MY50142931	2017/03/17	2018/03/16
Spectrum Analyzer	R&S	FSP40	100219	2016/09/01	2017/08/31
BLUETOOTH TESTER	R&S	CBT	101133	2017/03/10	2018/03/09
Attenuator	KEYSIGHT	8491B	MY39250703	2017/03/07	2018/03/06
Rotary Attenuator	Agilent	8495B	MY42146680	2017/03/13	2018/03/12
Temp & Humi chamber	T-MACHINE	TMJ-9712	T-12-040111	2016/09/05	2017/09/04
Series Power Meter	Anritsu	ML2495A	1224005	2017/03/01	2018/02/28
Power Sensor	Anritsu	MA2411B	1207295	2017/03/01	2018/02/28
Cable	HUBER SUHNER	SUCOFLEX 102	28422/2	2017/02/25	2018/02/24
Cable	HUBER SUHNER	SUCOFLEX 102	28418/2	2017/02/25	2018/02/24
Software	Farad	Ez-EMC	ver.ct3a1	N/A	N/A
Software	AUDIX	E3	V8.2014-8-6	N/A	N/A
Software	Keysight	N7607B Signal Studio	v2.0.0.1	N/A	N/A
Software	Keysight	Inservice MonitorUtility	N/A	N/A	N/A



## 4. Antenna Requirements

### 4.1. Standard Applicable

For intentional device, according to FCC 47 CFR Section 15.203, an intentional radiator shall be designed to ensure that no antenna other than that furnished by the responsible party shall be used with the device.

And according to FCC 47 CFR Section 15.407 (a), if transmitting antennas of directional gain greater than 6dBi are used, the power shall be reduced by the amount in dB that the directional gain of the antenna exceeds 6dBi.

### 4.2. Antenna Construction and Directional Gain

Antenna Type	Antenna Gain
PIFA Antenna	Antenna 1: 5.1 dBi
	Antenna 2: 4.7 dBi
	Antenna 3: 4.8 dBi

For Power directional gain=  $G_{ant} = 5.1$  dBi

For PSD directional gain =  $10 \log[(10^{G1/20} + 10^{G2/20} + \dots + 10^{GN/20})^2 / NANT]$   
= 9.64 (dBi)



## 5. Test of AC Power Line Conducted Emission

### 5.1. Test Limit

Conducted Emissions were measured from 150 kHz to 30 MHz with a bandwidth of 9 KHz, according to the methods defined in ANSI C63.4-2014. The EUT was placed on a nonmetallic stand in a shielded room 0.8 meters above the ground plane. The interface cables and equipment positioning were varied within limits of reasonable applications to determine the position produced maximum conducted emissions.

Frequency (MHz)	Quasi Peak (dB $\mu$ V)	Average (dB $\mu$ V)
0.15 – 0.5	66-56*	56-46*
0.5 – 5.0	56	46
5.0 – 30.0	60	50

\*Decreases with the logarithm of the frequency.

### 5.2. Test Procedures

- The EUT was placed 0.4 meter from the conducting wall of the shielding room was kept at least 80 centimeters from any other grounded conducting surface.
- Connect EUT to the power mains through a line impedance stabilization network (LISN).
- All the support units are connecting to the other LISN.
- The LISN provides 50 ohm coupling impedance for the measuring instrument.
- The FCC states that a 50 ohm, 50 micro-Henry LISN should be used.
- Both sides of AC line were checked for maximum conducted interference.
- The frequency range from 150 kHz to 30 MHz was searched.
- Set the test-receiver system to Peak Detect Function and Specified Bandwidth with Maximum Hold Mode.



### 5.3. Typical Test Setup

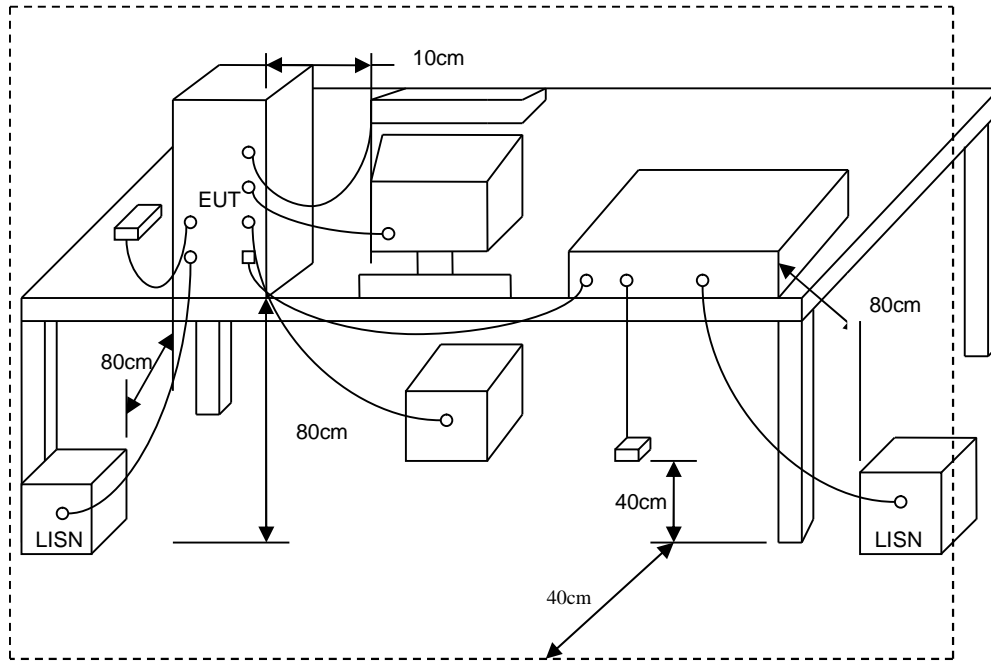



5.4. Test Result and Data

Power	: PoE	Pol/Phase	: LINE
Test Mode	: Mode 1	Temperature	: 20 °C
Test date	: Jul. 26, 2017	Humidity	: 62 %

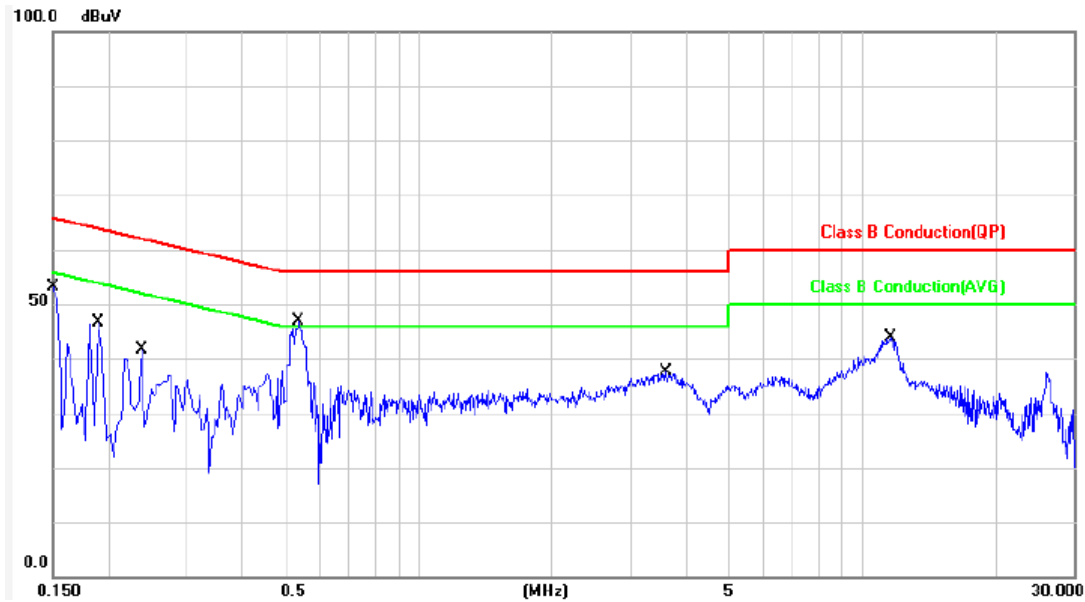

No.	Frequency (MHz)	Factor (dB)	Reading (dBuV)	Level (dBuV)	Limit (dBuV)	Margin (dB)	Detector	P/F
1	0.1500	9.91	18.47	28.38	65.99	-37.61	QP	P
2	0.1500	9.91	10.23	20.14	55.99	-35.85	AVG	P
3	0.1900	9.91	34.12	44.03	64.03	-20.00	QP	P
4	0.1900	9.91	17.61	27.52	54.03	-26.51	AVG	P
5	0.2380	9.91	27.88	37.79	62.16	-24.37	QP	P
6	0.2380	9.91	17.62	27.53	52.16	-24.63	AVG	P
7	0.5380	9.93	36.10	46.03	56.00	-9.97	QP	P
8	0.5380	9.93	31.01	40.94	46.00	-5.06	AVG	P
9	3.6220	10.12	24.29	34.41	56.00	-21.59	QP	P
10	3.6220	10.12	19.63	29.75	46.00	-16.25	AVG	P
11	11.6379	10.38	30.02	40.40	60.00	-19.60	QP	P
12	11.6379	10.38	25.41	35.79	50.00	-14.21	AVG	P

Note: Level = Reading + Factor  
 Margin = Level – Limit  
 Factor = (LISN, ISN, PLC or current probe) Factor + Cable Loss+ Attenuator



Power	: PoE	Pol/Phase	: NEUTRAL
Test Mode	: Mode 1	Temperature	: 20 °C
Test date	: Jul. 26, 2017	Humidity	: 62 %

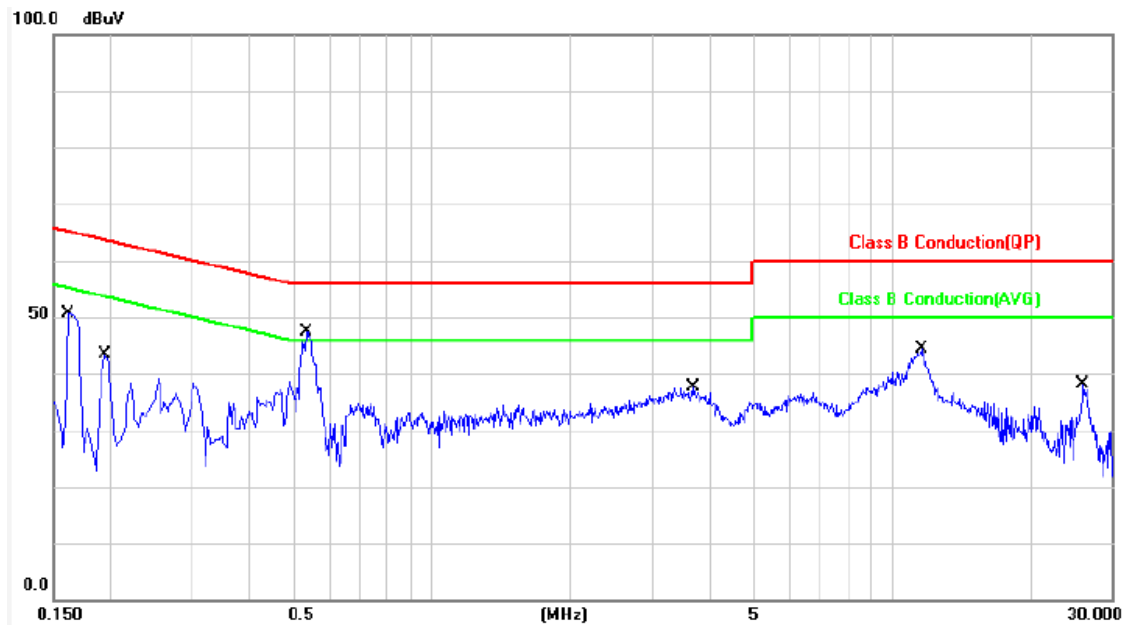

No.	Frequency (MHz)	Factor (dB)	Reading (dBuV)	Level (dBuV)	Limit (dBuV)	Margin (dB)	Detector	P/F
1	0.1620	9.88	39.19	49.07	65.36	-16.29	QP	P
2	0.1620	9.88	21.36	31.24	55.36	-24.12	AVG	P
3	0.1940	9.88	32.69	42.57	63.86	-21.29	QP	P
4	0.1940	9.88	16.77	26.65	53.86	-27.21	AVG	P
5	0.5340	9.89	36.28	46.17	56.00	-9.83	QP	P
6	0.5340	9.89	31.23	41.12	46.00	-4.88	AVG	P
7	3.6900	10.06	24.16	34.22	56.00	-21.78	QP	P
8	3.6900	10.06	19.43	29.49	46.00	-16.51	AVG	P
9	11.6140	10.36	30.00	40.36	60.00	-19.64	QP	P
10	11.6140	10.36	25.34	35.70	50.00	-14.30	AVG	P
11	26.0940	10.77	21.76	32.53	60.00	-27.47	QP	P
12	26.0940	10.77	14.35	25.12	50.00	-24.88	AVG	P

Note: Level = Reading + Factor  
Margin = Level – Limit  
Factor = (LISN, ISN, PLC or current probe) Factor + Cable Loss+ Attenuator



## 6. Test of Spurious Emission (Radiated)

### 6.1. Test Limit

Undesirable emission limits. Except as shown in paragraph (b)(7) of this section, the maximum emissions outside of the frequency bands of operation shall be attenuated in accordance with the following limits:

- (1) For transmitters operating in the 5.15-5.25 GHz band: All emissions outside of the 5.15-5.35 GHz band shall not exceed an e.i.r.p. of  $-27$  dBm/MHz.
- (2) For transmitters operating in the 5.25-5.35 GHz band: All emissions outside of the 5.15-5.35 GHz band shall not exceed an e.i.r.p. of  $-27$  dBm/MHz.
- (3) For transmitters operating in the 5.47-5.725 GHz band: All emissions outside of the 5.47-5.725 GHz band shall not exceed an e.i.r.p. of  $-27$  dBm/MHz.
- (4) For transmitters operating in the 5.725-5.85 GHz band:
  - (i) All emissions shall be limited to a level of  $-27$  dBm/MHz at 75 MHz or more above or below the band edge increasing linearly to 10 dBm/MHz at 25 MHz above or below the band edge, and from 25MHz above or below the band edge increasing linearly to a level of 15.6 dBm/MHz at 5 MHz above or below the band edge, and from 5 MHz above or below the band edge increasing linearly to a level of 27dBm/MHz at the band edge.
- (5) The emission measurements shall be performed using a minimum resolution bandwidth of 1 MHz. A lower resolution bandwidth may be employed near the band edge, when necessary, provided the measured energy is integrated to show the total power over 1 MHz.
- (6) Unwanted emissions below 1 GHz must comply with the general field strength limits set forth in §15.209. Further, any U-NII devices using an AC power line are required to comply also with the conducted limits set forth in §15.207.
- (7) The provisions of §15.205 apply to intentional radiators operating under this section.
- (8) When measuring the emission limits, the nominal carrier frequency shall be adjusted as close to the upper and lower frequency band edges as the design of the equipment permits.

### 6.2. Test Procedures

- a. The EUT was placed on a rotatable table top 0.8 meter above ground.
- b. The EUT was set 3 meters from the interference receiving antenna which was mounted on the top of a variable height antenna tower.
- c. The table was rotated 360 degrees to determine the position of the highest radiation.
- d. The antenna is a broadband antenna and its height is varied between one meter and four meters above ground to find the maximum value of the field strength both horizontal polarization and vertical polarization of the antenna are set to make the measurement.
- e. For each suspected emission the EUT was arranged to its worst case and then tune the antenna tower (from 1 M to 4 M) and turn table (from 0 degree to 360 degrees) to find the maximum reading.
- f. Set the test-receiver system to Peak or CISPR quasi-peak Detect Function and specified bandwidth with Maximum Hold Mode.
- g. If the emission level of the EUT in peak mode was 3 dB lower than the limit specified, then testing will be stopped and peak values of EUT will be reported, otherwise, the emissions which do not have 3 dB margin will be repeated one by one using the quasi-peak method and reported.
- h. For testing above 1GHz, the emission level of the EUT in peak mode was 20dB lower than average limit (that means the emission level in peak mode also complies with the limit in average mode), then testing will be stopped and peak values of EUT will be reported, otherwise, the emissions will be measured in average mode again and reported.
- i. "Cone of radiation" has been considered to be 3dB bandwidth of the measurement antenna.



### 6.3. Typical Test Setup

Below 30MHz test setup

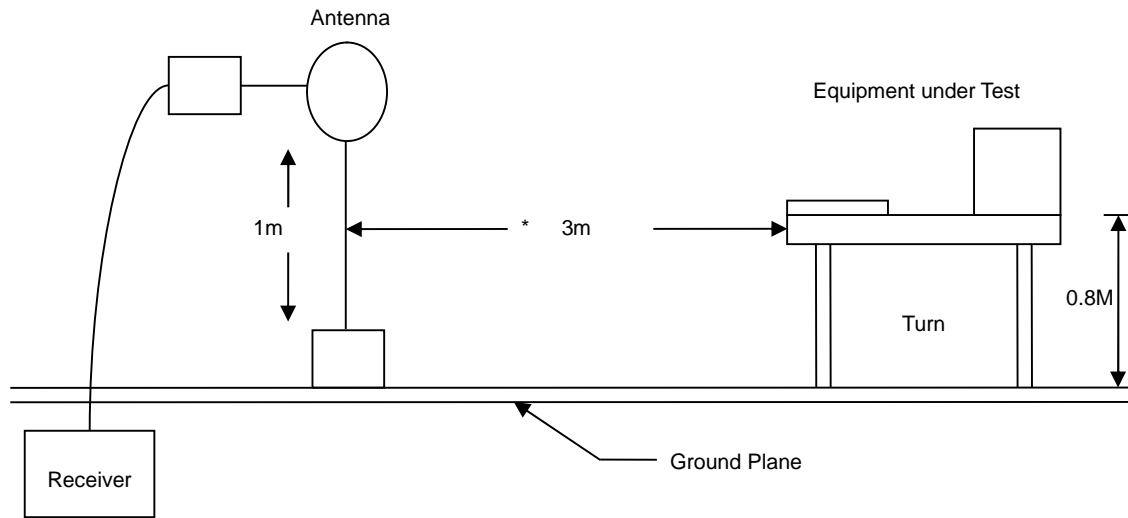

30MHz- 1GHz Test Setup

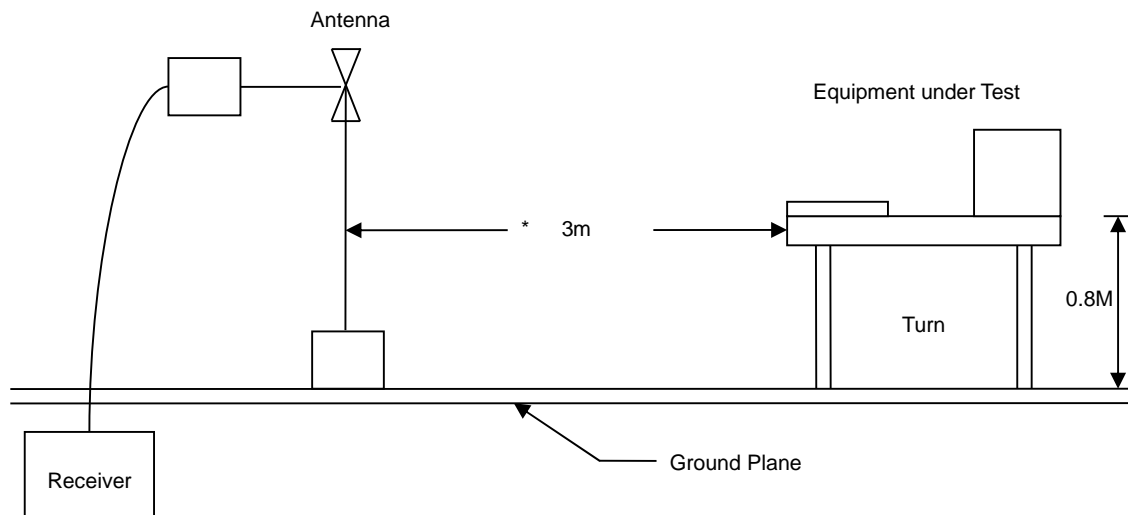

Above 1GHz Test Setup

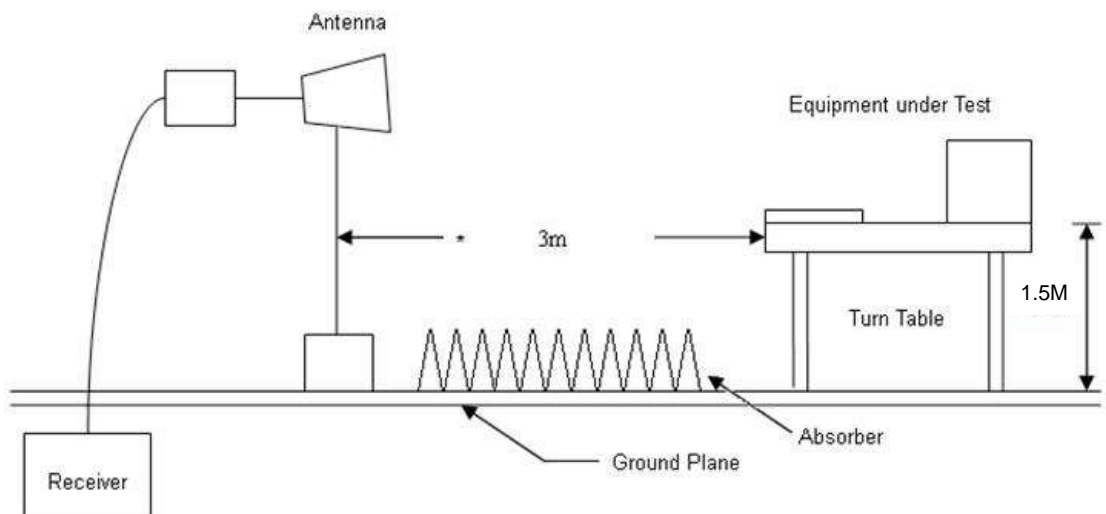





### 6.4. Test Result and Data (9kHz ~ 30MHz)

The 9kHz - 30MHz spurious emission is under limit 20dB more.

### 6.5. Test Result and Data (30MHz ~ 1GHz)

Power	: PoE	Pol/Phase	: VERTICAL
Test Mode	: Mode 1	Temperature	: 25 °C
Test Date	: Jul. 26, 2017	Humidity	: 60 %

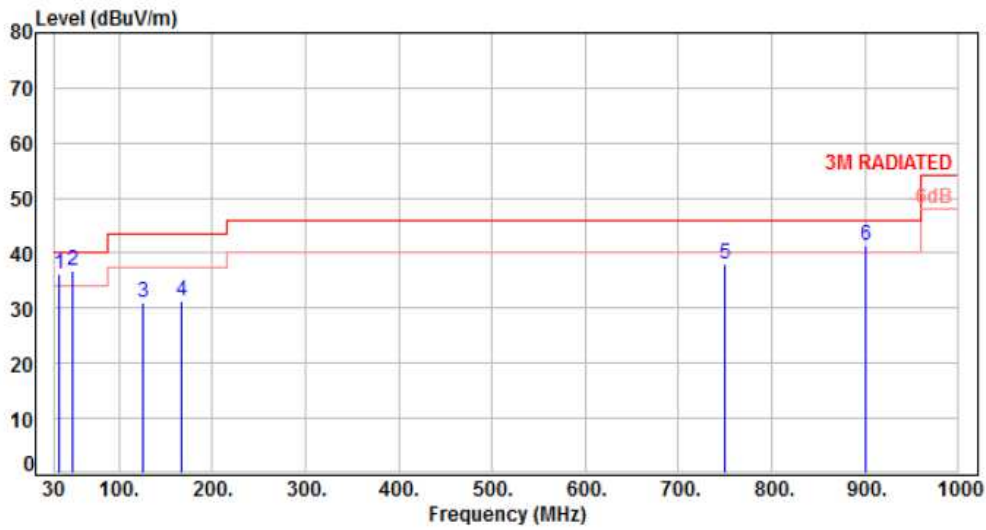

No.	Frequency (MHz)	Factor (dB)	Reading (dBuV)	Level (dBuV)	Limit (dBuV)	Margin (dB)	Detector	Height (cm)	Azimuth (deg)	P/F
1	35.82	-10.67	46.80	36.13	40.00	-3.87	QP	100	178	P
2	49.40	-9.53	46.38	36.85	40.00	-3.15	Peak	100	0	P
3	125.06	-11.45	42.44	30.99	43.50	-12.51	Peak	100	0	P
4	167.74	-10.00	41.48	31.48	43.50	-12.02	Peak	100	0	P
5	749.74	0.44	37.67	38.11	46.00	-7.89	Peak	100	0	P
6	901.06	2.37	38.99	41.36	46.00	-4.64	Peak	100	0	P

Note: Level=Reading+Factor  
 Margin=Level-Limit  
 Factor=Antenna Factor + cable loss - Amplifier Factor



Power	: PoE	Pol/Phase	: HORIZONTAL
Test Mode	: Mode 1	Temperature	: 25 °C
Test Date	: Jul. 26, 2017	Humidity	: 60 %

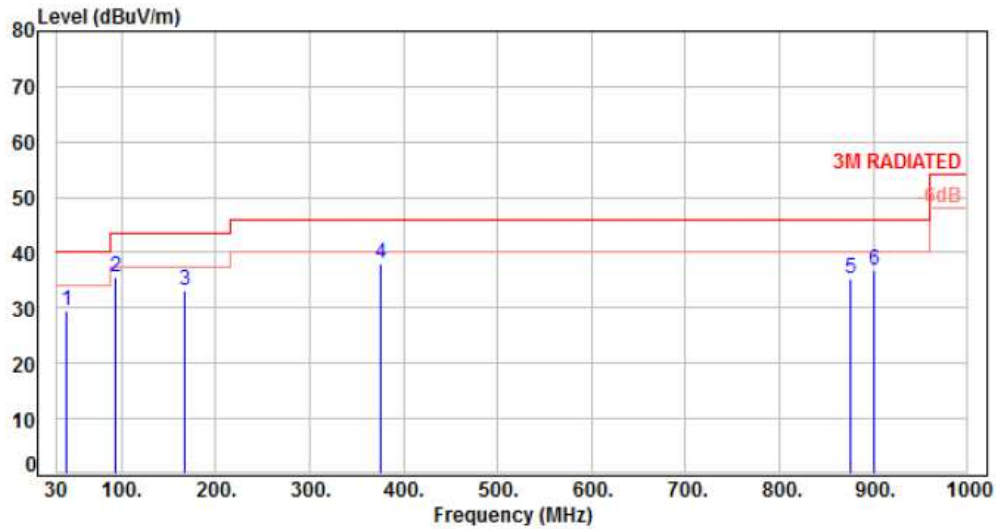

No.	Frequency (MHz)	Factor (dB)	Reading (dBuV)	Level (dBuV)	Limit (dBuV)	Margin (dB)	Detector	Height (cm)	Azimuth (deg)	P/F
1	41.64	-9.80	39.37	29.57	40.00	-10.43	Peak	100	0	P
2	94.02	-15.59	51.18	35.59	43.50	-7.91	Peak	100	0	P
3	167.74	-10.00	43.01	33.01	43.50	-10.49	Peak	100	0	P
4	375.32	-6.92	44.89	37.97	46.00	-8.03	Peak	100	0	P
5	875.84	2.17	33.03	35.20	46.00	-10.80	Peak	100	0	P
6	901.06	2.37	34.40	36.77	46.00	-9.23	Peak	100	0	P

Note: Level=Reading+Factor  
Margin=Level-Limit  
Factor=Antenna Factor + cable loss - Amplifier Factor



### 6.6. Test Result and Data (1GHz ~ 40GHz)

Power	: PoE	Pol/Phase	: VERTICAL
Test Mode	: Mode 1, CH36	Temperature	: 25°C
Test Date	: Jul. 25, 2017	Humidity	: 60%

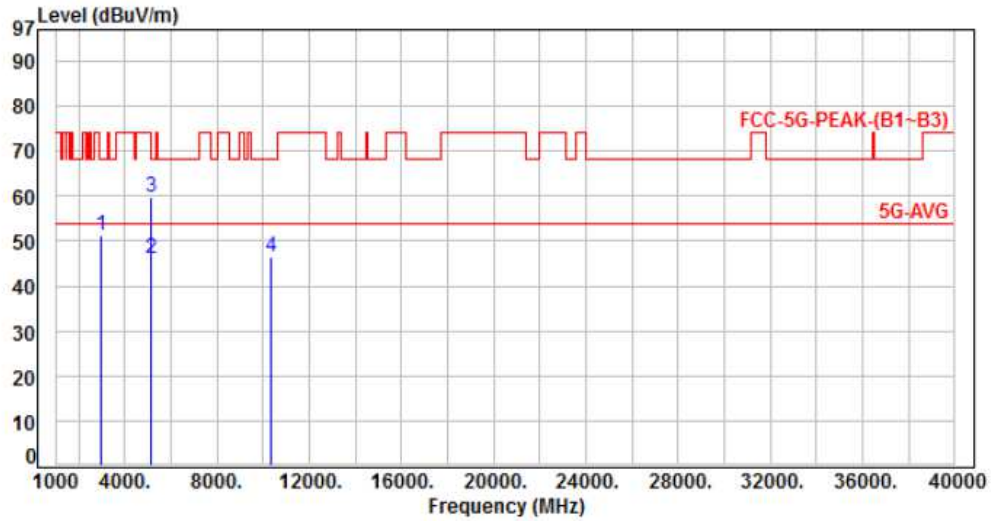

No.	Frequency (MHz)	Factor (dB)	Reading (dBuV)	Level (dBuV)	Limit (dBuV)	Margin (dB)	Detector	Height (cm)	Azimuth (deg)	P/F
1	3000.00	-16.73	67.94	51.21	68.20	-16.99	Peak	156	219	P
2	5150.00	-12.71	58.65	45.94	54.00	-8.06	Average	188	323	P
3	5150.00	-12.71	72.35	59.64	74.00	-14.36	Peak	188	323	P
4	10360.00	-7.44	53.87	46.43	68.20	-21.77	Peak	128	158	P

Note: Level=Reading+Factor  
Margin=Level-Limit  
Factor=Antenna Factor + cable loss - Amplifier Factor



Power	: PoE	Pol/Phase	: HORIZONTAL
Test Mode	: Mode 1, CH36	Temperature	: 25°C
Test Date	: Jul. 25, 2017	Humidity	: 60%

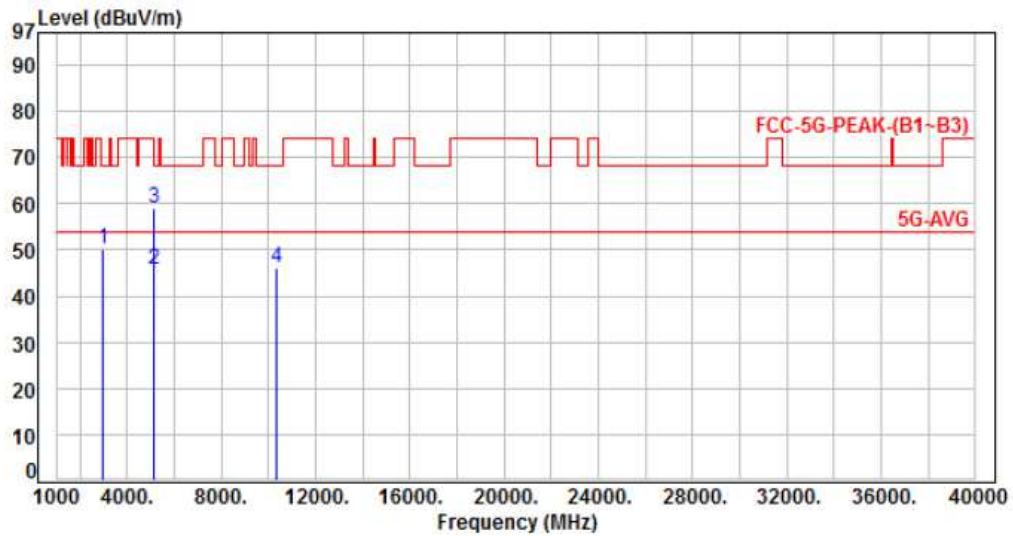

No.	Frequency (MHz)	Factor (dB)	Reading (dBuV)	Level (dBuV)	Limit (dBuV)	Margin (dB)	Detector	Height (cm)	Azimuth (deg)	P/F
1	3000.00	-16.73	66.78	50.05	68.20	-18.15	Peak	198	296	P
2	5150.00	-12.71	58.45	45.74	54.00	-8.26	Average	276	317	P
3	5150.00	-12.71	71.88	59.17	74.00	-14.83	Peak	276	317	P
4	10360.00	-7.44	53.44	46.00	68.20	-22.20	Peak	256	318	P

Note: Level=Reading+Factor  
Margin=Level-Limit  
Factor=Antenna Factor + cable loss - Amplifier Factor



Power	: PoE	Pol/Phase	: VERTICAL
Test Mode	: Mode 1, CH44	Temperature	: 25°C
Test Date	: Jul. 25, 2017	Humidity	: 60%

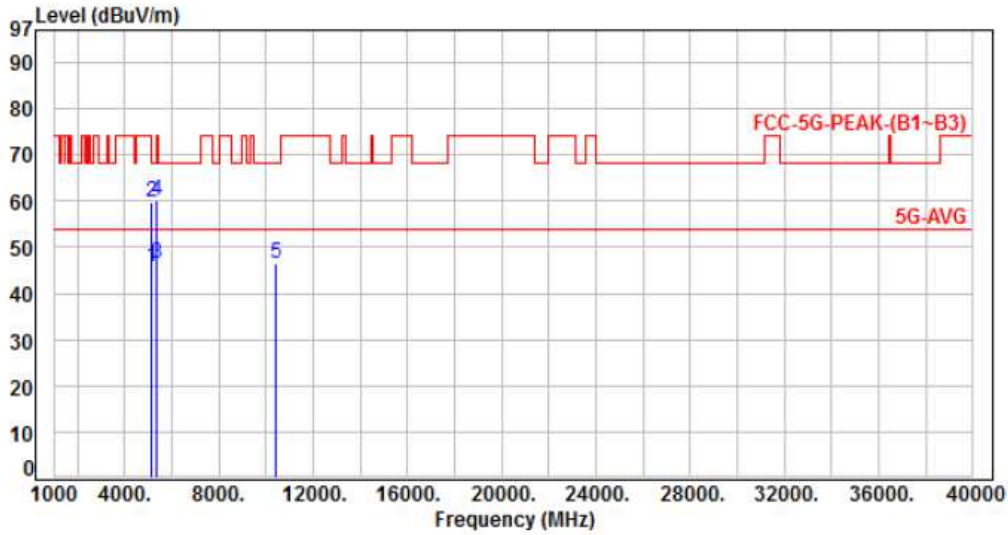

No.	Frequency (MHz)	Factor (dB)	Reading (dBuV)	Level (dBuV)	Limit (dBuV)	Margin (dB)	Detector	Height (cm)	Azimuth (deg)	P/F
1	5150.00	-12.71	58.62	45.91	54.00	-8.09	Average	197	333	P
2	5150.00	-12.71	72.49	59.78	74.00	-14.22	Peak	197	333	P
3	5350.00	-12.32	58.81	46.49	54.00	-7.51	Average	197	333	P
4	5350.00	-12.32	72.47	60.15	74.00	-13.85	Peak	197	333	P
5	10440.00	-7.43	53.91	46.48	68.20	-21.72	Peak	266	160	P

Note: Level=Reading+Factor  
 Margin=Level-Limit  
 Factor=Antenna Factor + cable loss - Amplifier Factor



Power	: PoE	Pol/Phase	: HORIZONTAL
Test Mode	: Mode 1, CH44	Temperature	: 25°C
Test Date	: Jul. 25, 2017	Humidity	: 60%

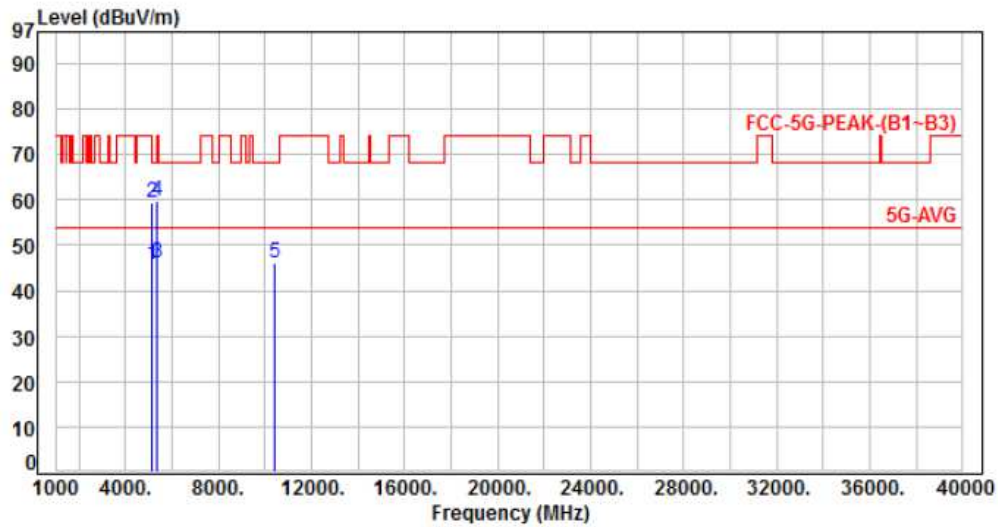

No.	Frequency (MHz)	Factor (dB)	Reading (dBuV)	Level (dBuV)	Limit (dBuV)	Margin (dB)	Detector	Height (cm)	Azimuth (deg)	P/F
1	5150.00	-12.71	58.49	45.78	54.00	-8.22	Average	296	282	P
2	5150.00	-12.71	71.99	59.28	74.00	-14.72	Peak	296	282	P
3	5350.00	-12.32	58.35	46.03	54.00	-7.97	Average	296	282	P
4	5350.00	-12.32	72.02	59.70	74.00	-14.30	Peak	296	282	P
5	10440.00	-7.43	53.37	45.94	68.20	-22.26	Peak	102	313	P

Note: Level=Reading+Factor  
Margin=Level-Limit  
Factor=Antenna Factor + cable loss - Amplifier Factor





Power	:	PoE	Pol/Phase	:	VERTICAL
Test Mode	:	Mode 1, CH48	Temperature	:	25°C
Test Date	:	Jul. 25, 2017	Humidity	:	60%

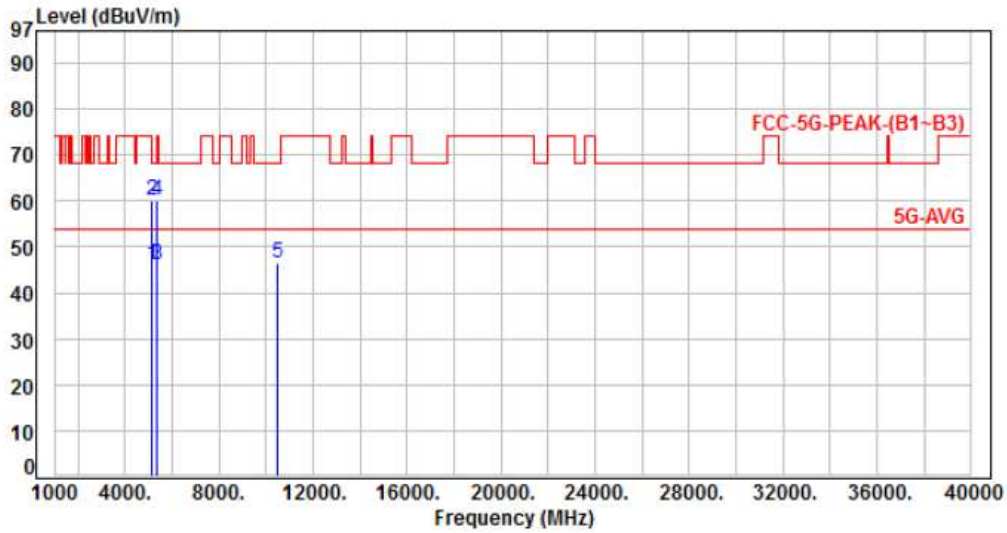

No.	Frequency (MHz)	Factor (dB)	Reading (dBuV)	Level (dBuV)	Limit (dBuV)	Margin (dB)	Detector	Height (cm)	Azimuth (deg)	P/F
1	5150.00	-12.71	58.78	46.07	54.00	-7.93	Average	192	346	P
2	5150.00	-12.71	72.72	60.01	74.00	-13.99	Peak	192	346	P
3	5350.00	-12.32	58.54	46.22	54.00	-7.78	Average	192	346	P
4	5350.00	-12.32	72.60	60.28	74.00	-13.72	Peak	192	346	P
5	10480.00	-7.42	53.83	46.41	68.20	-21.79	Peak	115	159	P

Note: Level=Reading+Factor  
Margin=Level-Limit  
Factor=Antenna Factor + cable loss - Amplifier Factor



Power	: PoE	Pol/Phase	: HORIZONTAL
Test Mode	: Mode 1, CH48	Temperature	: 25°C
Test Date	: Jul. 25, 2017	Humidity	: 60%

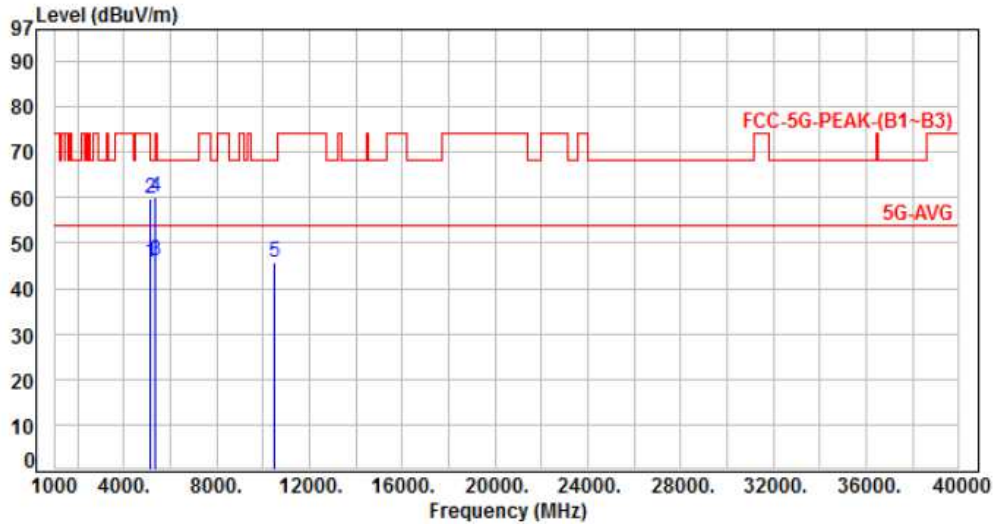

No.	Frequency (MHz)	Factor (dB)	Reading (dBuV)	Level (dBuV)	Limit (dBuV)	Margin (dB)	Detector	Height (cm)	Azimuth (deg)	P/F
1	5150.00	-12.71	58.33	45.62	54.00	-8.38	Average	276	277	P
2	5150.00	-12.71	72.49	59.78	74.00	-14.22	Peak	276	277	P
3	5350.00	-12.32	58.24	45.92	54.00	-8.08	Average	276	277	P
4	5350.00	-12.32	72.33	60.01	74.00	-13.99	Peak	276	277	P
5	10480.00	-7.42	53.24	45.82	68.20	-22.38	Peak	101	214	P

Note: Level=Reading+Factor  
 Margin=Level-Limit  
 Factor=Antenna Factor + cable loss - Amplifier Factor





Power	: PoE	Pol/Phase	: VERTICAL
Test Mode	: Mode 4, CH36	Temperature	: 25°C
Test Date	: Jul. 25, 2017	Humidity	: 60%

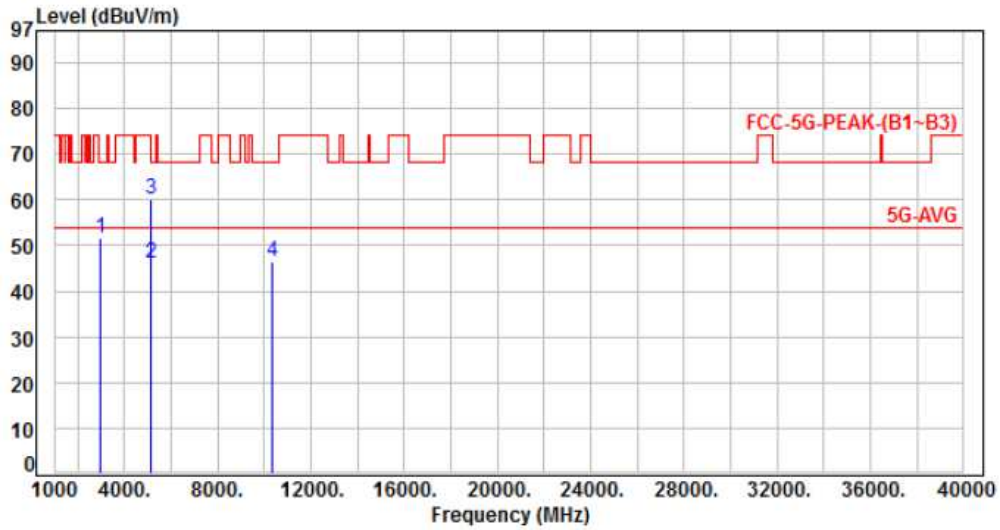

No.	Frequency (MHz)	Factor (dB)	Reading (dBuV)	Level (dBuV)	Limit (dBuV)	Margin (dB)	Detector	Height (cm)	Azimuth (deg)	P/F
1	3000.00	-16.73	68.48	51.75	68.20	-16.45	Peak	159	224	P
2	5150.00	-12.71	58.70	45.99	54.00	-8.01	Average	189	347	P
3	5150.00	-12.71	72.79	60.08	74.00	-13.92	Peak	189	347	P
4	10360.00	-7.44	53.78	46.34	68.20	-21.86	Peak	130	163	P

Note: Level=Reading+Factor  
Margin=Level-Limit  
Factor=Antenna Factor + cable loss - Amplifier Factor



Power	: PoE	Pol/Phase	: HORIZONTAL
Test Mode	: Mode 4, CH36	Temperature	: 25°C
Test Date	: Jul. 25, 2017	Humidity	: 60%

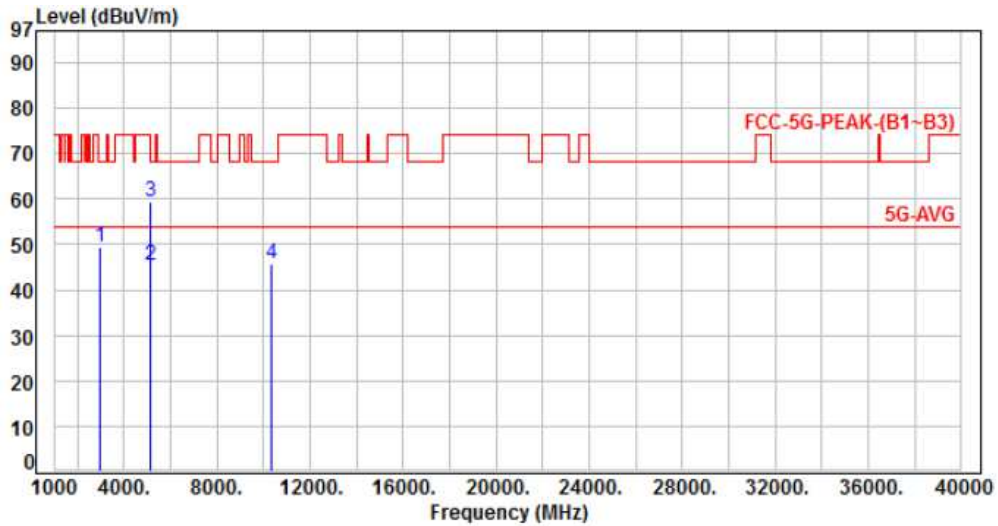

No.	Frequency (MHz)	Factor (dB)	Reading (dBuV)	Level (dBuV)	Limit (dBuV)	Margin (dB)	Detector	Height (cm)	Azimuth (deg)	P/F
1	3000.00	-16.73	66.03	49.30	68.20	-18.90	Peak	182	291	P
2	5150.00	-12.71	58.22	45.51	54.00	-8.49	Average	261	332	P
3	5150.00	-12.71	71.97	59.26	74.00	-14.74	Peak	261	332	P
4	10360.00	-7.44	53.29	45.85	68.20	-22.35	Peak	251	308	P

Note: Level=Reading+Factor  
Margin=Level-Limit  
Factor=Antenna Factor + cable loss - Amplifier Factor



Power	: PoE	Pol/Phase	: VERTICAL
Test Mode	: Mode 4, CH44	Temperature	: 25°C
Test Date	: Jul. 25, 2017	Humidity	: 60%

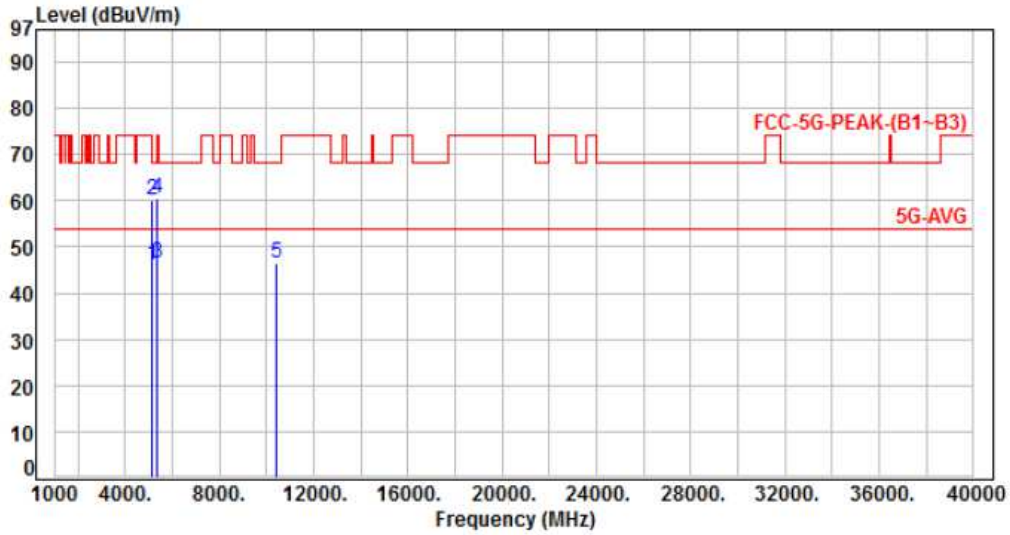

No.	Frequency (MHz)	Factor (dB)	Reading (dBuV)	Level (dBuV)	Limit (dBuV)	Margin (dB)	Detector	Height (cm)	Azimuth (deg)	P/F
1	5150.00	-12.71	58.78	46.07	54.00	-7.93	Average	199	25	P
2	5150.00	-12.71	72.85	60.14	74.00	-13.86	Peak	199	25	P
3	5350.00	-12.32	58.63	46.31	54.00	-7.69	Average	199	25	P
4	5350.00	-12.32	72.74	60.42	74.00	-13.58	Peak	199	25	P
5	10440.00	-7.43	53.93	46.50	68.20	-21.70	Peak	248	192	P

Note: Level=Reading+Factor  
 Margin=Level-Limit  
 Factor=Antenna Factor + cable loss - Amplifier Factor



Power	: PoE	Pol/Phase	: HORIZONTAL
Test Mode	: Mode 4, CH44	Temperature	: 25°C
Test Date	: Jul. 25, 2017	Humidity	: 60%

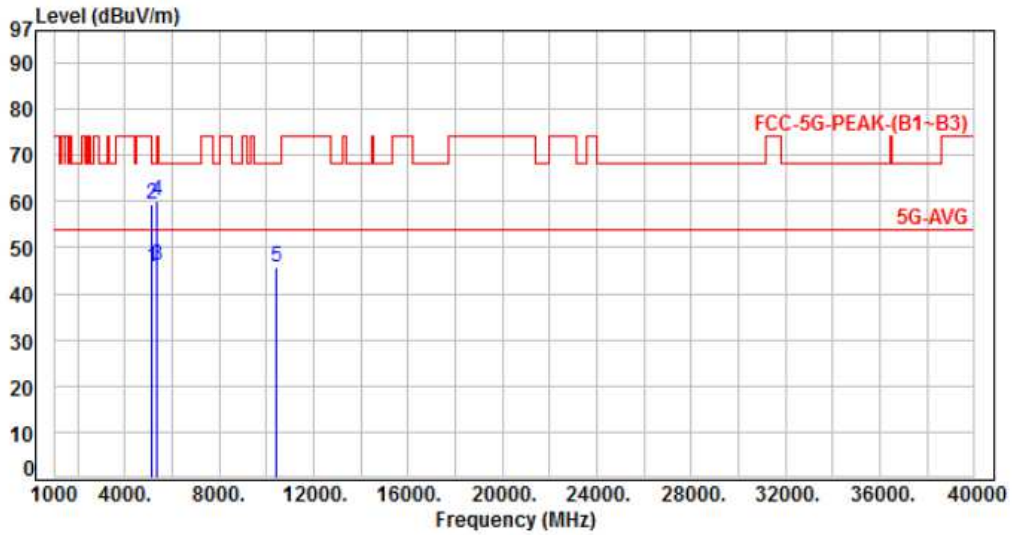

No.	Frequency (MHz)	Factor (dB)	Reading (dBuV)	Level (dBuV)	Limit (dBuV)	Margin (dB)	Detector	Height (cm)	Azimuth (deg)	P/F
1	5150.00	-12.71	58.33	45.62	54.00	-8.38	Average	300	312	P
2	5150.00	-12.71	72.17	59.46	74.00	-14.54	Peak	300	312	P
3	5350.00	-12.32	58.27	45.95	54.00	-8.05	Average	300	312	P
4	5350.00	-12.32	72.36	60.04	74.00	-13.96	Peak	300	312	P
5	10440.00	-7.43	53.16	45.73	68.20	-22.47	Peak	124	325	P

Note: Level=Reading+Factor  
 Margin=Level-Limit  
 Factor=Antenna Factor + cable loss - Amplifier Factor



Power	: PoE	Pol/Phase	: VERTICAL
Test Mode	: Mode 4, CH48	Temperature	: 25°C
Test Date	: Jul. 25, 2017	Humidity	: 60%

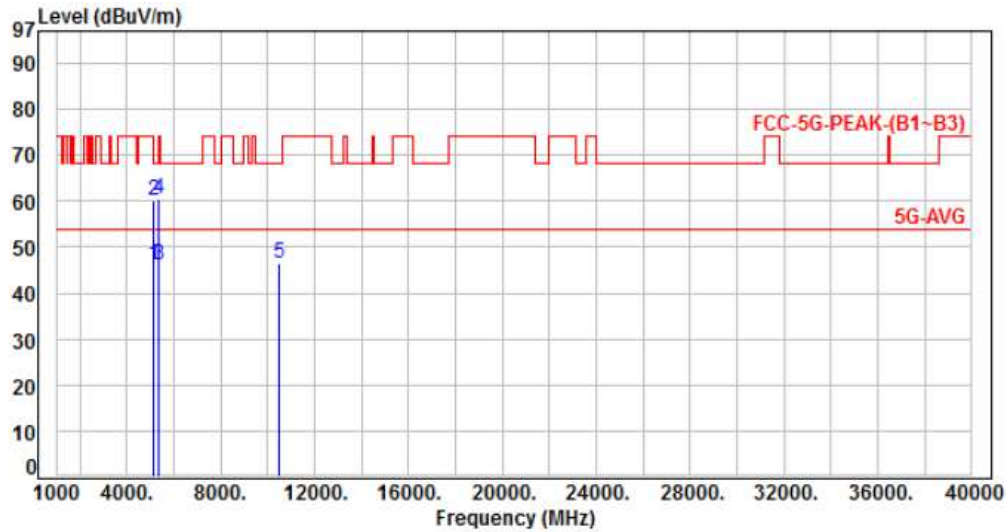

No.	Frequency (MHz)	Factor (dB)	Reading (dBuV)	Level (dBuV)	Limit (dBuV)	Margin (dB)	Detector	Height (cm)	Azimuth (deg)	P/F
1	5150.00	-12.71	58.65	45.94	54.00	-8.06	Average	195	336	P
2	5150.00	-12.71	72.81	60.10	74.00	-13.90	Peak	195	336	P
3	5350.00	-12.32	58.51	46.19	54.00	-7.81	Average	195	336	P
4	5350.00	-12.32	72.65	60.33	74.00	-13.67	Peak	195	336	P
5	10480.00	-7.42	53.92	46.50	68.20	-21.70	Peak	123	162	P

Note: Level=Reading+Factor  
 Margin=Level-Limit  
 Factor=Antenna Factor + cable loss - Amplifier Factor



Power	: PoE	Pol/Phase	: HORIZONTAL
Test Mode	: Mode 4, CH48	Temperature	: 25°C
Test Date	: Jul. 25, 2017	Humidity	: 60%

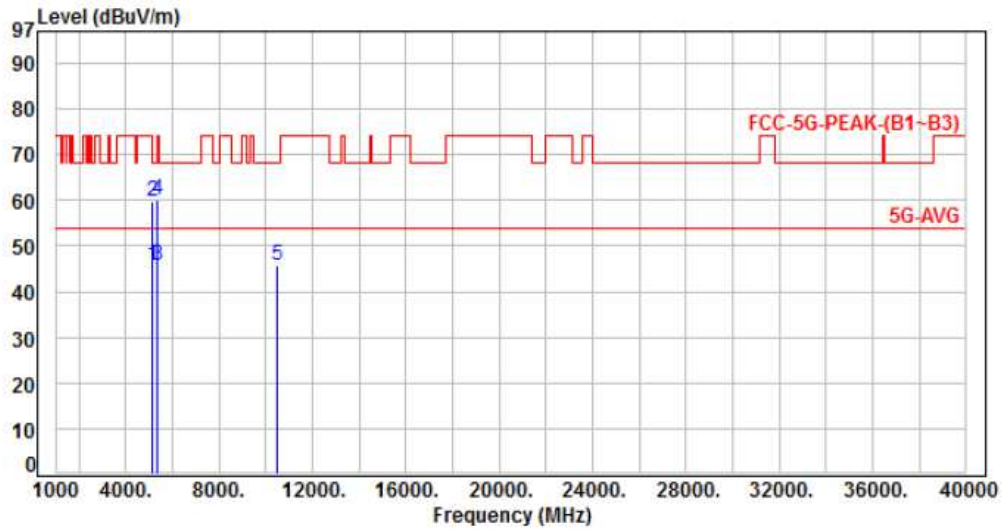

No.	Frequency (MHz)	Factor (dB)	Reading (dBuV)	Level (dBuV)	Limit (dBuV)	Margin (dB)	Detector	Height (cm)	Azimuth (deg)	P/F
1	5150.00	-12.71	58.38	45.67	54.00	-8.33	Average	288	264	P
2	5150.00	-12.71	72.33	59.62	74.00	-14.38	Peak	288	264	P
3	5350.00	-12.32	58.15	45.83	54.00	-8.17	Average	288	264	P
4	5350.00	-12.32	72.45	60.13	74.00	-13.87	Peak	288	264	P
5	10480.00	-7.42	53.18	45.76	68.20	-22.44	Peak	100	226	P

Note: Level=Reading+Factor  
 Margin=Level-Limit  
 Factor=Antenna Factor + cable loss - Amplifier Factor





Power	: PoE	Pol/Phase	: VERTICAL
Test Mode	: Mode 5, CH38	Temperature	: 25°C
Test Date	: Jul. 25, 2017	Humidity	: 60%

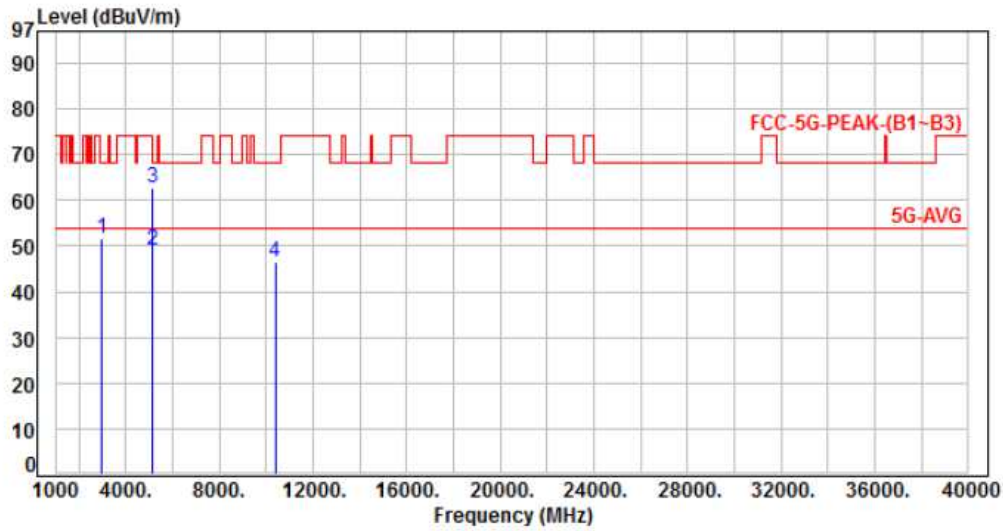

No.	Frequency (MHz)	Factor (dB)	Reading (dBuV)	Level (dBuV)	Limit (dBuV)	Margin (dB)	Detector	Height (cm)	Azimuth (deg)	P/F
1	3000.00	-16.73	68.21	51.48	68.20	-16.72	Peak	158	220	P
2	5150.00	-12.71	61.90	49.19	54.00	-4.81	Average	151	336	P
3	5150.00	-12.71	75.29	62.58	74.00	-11.42	Peak	151	336	P
4	10380.00	-7.43	53.73	46.30	68.20	-21.90	Peak	125	331	P

Note: Level=Reading+Factor  
Margin=Level-Limit  
Factor=Antenna Factor + cable loss - Amplifier Factor



Power	: PoE	Pol/Phase	: HORIZONTAL
Test Mode	: Mode 5, CH38	Temperature	: 25°C
Test Date	: Jul. 25, 2017	Humidity	: 60%

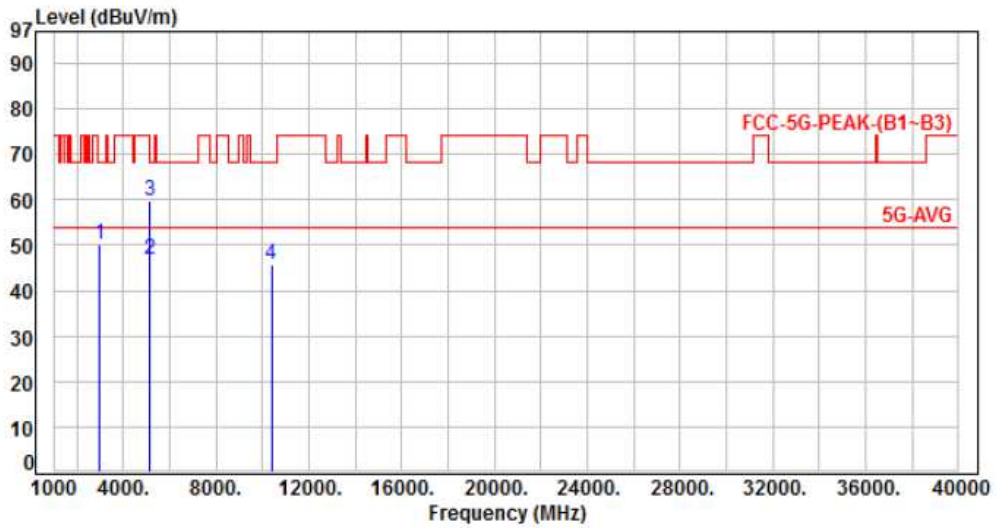

No.	Frequency (MHz)	Factor (dB)	Reading (dBuV)	Level (dBuV)	Limit (dBuV)	Margin (dB)	Detector	Height (cm)	Azimuth (deg)	P/F
1	3000.00	-16.73	66.77	50.04	68.20	-18.16	Peak	102	298	P
2	5150.00	-12.71	59.49	46.78	54.00	-7.22	Average	191	309	P
3	5150.00	-12.71	72.49	59.78	74.00	-14.22	Peak	191	309	P
4	10380.00	-7.43	53.26	45.83	68.20	-22.37	Peak	136	313	P

Note: Level=Reading+Factor  
 Margin=Level-Limit  
 Factor=Antenna Factor + cable loss - Amplifier Factor





Power	: PoE	Pol/Phase	: VERTICAL
Test Mode	: Mode 5, CH46	Temperature	: 25°C
Test Date	: Jul. 25, 2017	Humidity	: 60%

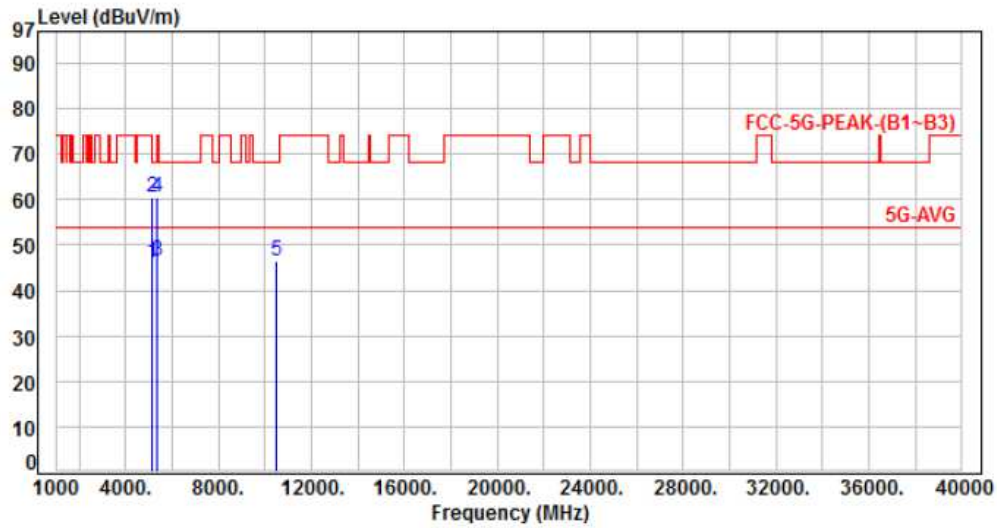

No.	Frequency (MHz)	Factor (dB)	Reading (dBuV)	Level (dBuV)	Limit (dBuV)	Margin (dB)	Detector	Height (cm)	Azimuth (deg)	P/F
1	5150.00	-12.71	58.97	46.26	54.00	-7.74	Average	196	360	P
2	5150.00	-12.71	73.04	60.33	74.00	-13.67	Peak	196	360	P
3	5350.00	-12.32	58.63	46.31	54.00	-7.69	Average	196	360	P
4	5350.00	-12.32	72.76	60.44	74.00	-13.56	Peak	196	360	P
5	10460.00	-7.42	53.88	46.46	68.20	-21.74	Peak	198	318	P

Note: Level=Reading+Factor  
Margin=Level-Limit  
Factor=Antenna Factor + cable loss - Amplifier Factor



Power	: PoE	Pol/Phase	: HORIZONTAL
Test Mode	: Mode 5, CH46	Temperature	: 25°C
Test Date	: Jul. 25, 2017	Humidity	: 60%

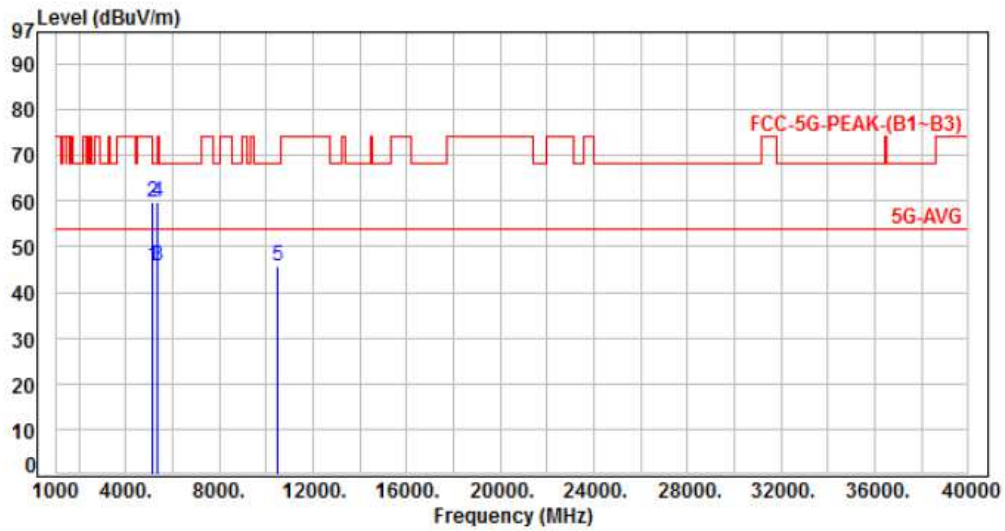

No.	Frequency (MHz)	Factor (dB)	Reading (dBuV)	Level (dBuV)	Limit (dBuV)	Margin (dB)	Detector	Height (cm)	Azimuth (deg)	P/F
1	5150.00	-12.71	58.29	45.58	54.00	-8.42	Average	276	318	P
2	5150.00	-12.71	72.37	59.66	74.00	-14.34	Peak	276	318	P
3	5350.00	-12.32	58.17	45.85	54.00	-8.15	Average	276	318	P
4	5350.00	-12.32	72.13	59.81	74.00	-14.19	Peak	276	318	P
5	10460.00	-7.42	53.31	45.89	68.20	-22.31	Peak	288	324	P

Note: Level=Reading+Factor  
Margin=Level-Limit  
Factor=Antenna Factor + cable loss - Amplifier Factor



Power	: PoE	Pol/Phase	: VERTICAL
Test Mode	: Mode 6, CH42	Temperature	: 25°C
Test Date	: Jul. 25, 2017	Humidity	: 60%

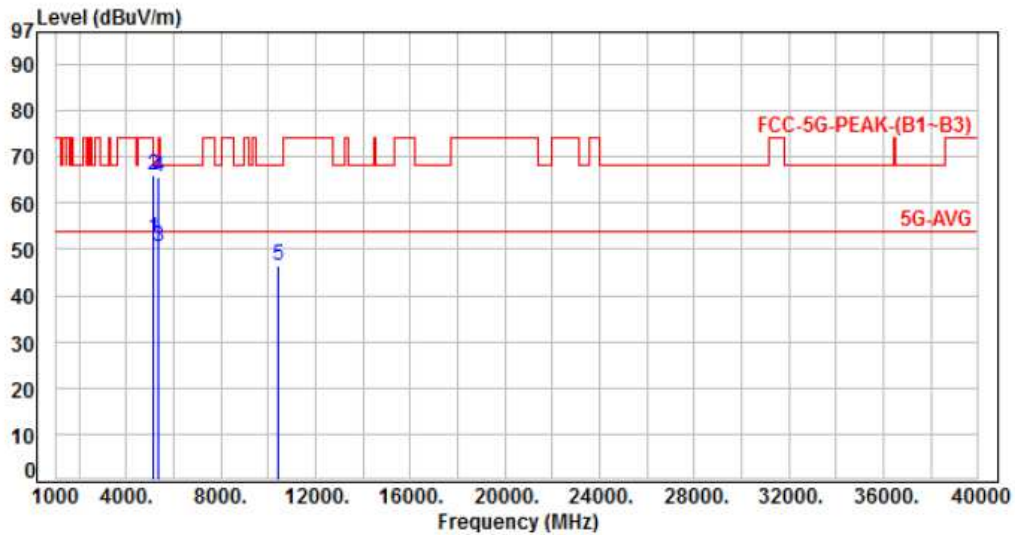

No.	Frequency (MHz)	Factor (dB)	Reading (dBuV)	Level (dBuV)	Limit (dBuV)	Margin (dB)	Detector	Height (cm)	Azimuth (deg)	P/F
1	5150.00	-12.71	65.26	52.55	54.00	-1.45	Average	204	352	P
2	5150.00	-12.71	78.90	66.19	74.00	-7.81	Peak	204	352	P
3	5350.00	-12.32	62.85	50.53	54.00	-3.47	Average	204	352	P
4	5350.00	-12.32	78.13	65.81	74.00	-8.19	Peak	204	352	P
5	10420.00	-7.44	53.79	46.35	68.20	-21.85	Peak	137	353	P

Note: Level=Reading+Factor  
 Margin=Level-Limit  
 Factor=Antenna Factor + cable loss - Amplifier Factor



Power	: PoE	Pol/Phase	: HORIZONTAL
Test Mode	: Mode 6, CH42	Temperature	: 25°C
Test Date	: Jul. 25, 2017	Humidity	: 60%

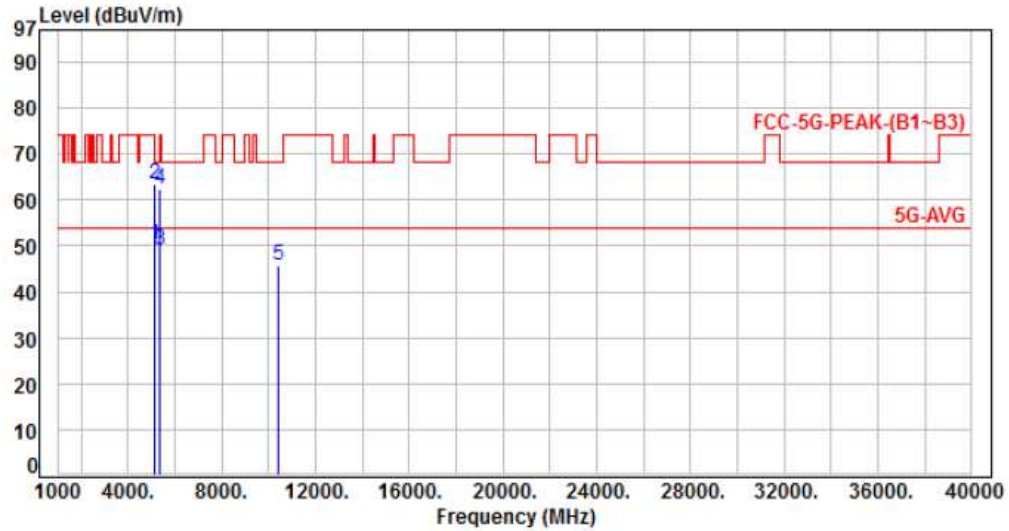

No.	Frequency (MHz)	Factor (dB)	Reading (dBuV)	Level (dBuV)	Limit (dBuV)	Margin (dB)	Detector	Height (cm)	Azimuth (deg)	P/F
1	5150.00	-12.71	62.79	50.08	54.00	-3.92	Average	312	268	P
2	5150.00	-12.71	76.32	63.61	74.00	-10.39	Peak	312	268	P
3	5350.00	-12.32	61.25	48.93	54.00	-5.07	Average	312	268	P
4	5350.00	-12.32	74.78	62.46	74.00	-11.54	Peak	312	268	P
5	10420.00	-7.44	53.28	45.84	68.20	-22.36	Peak	100	298	P

Note: Level=Reading+Factor  
 Margin=Level-Limit  
 Factor=Antenna Factor + cable loss - Amplifier Factor



### 6.7. Restricted Bands of Operation

Only spurious emissions are permitted in any of the frequency bands listed below:

MHz	MHz	MHz	GHz
0.09000 – 0.11000	16.42000 – 16.42300	399.9 – 410.0	4.500 – 5.150
0.49500 – 0.505**	16.69475 – 16.69525	608.0 – 614.0	5.350 – 5.460
2.17350 – 2.19050	16.80425 – 16.80475	960.0 – 1240.0	7.250 – 7.750
4.12500 – 4.12800	25.50000 – 25.67000	1300.0 – 1427.0	8.025 – 8.500
4.17725 – 4.17775	37.50000 – 38.25000	1435.0 – 1626.5	9.000 – 9.200
4.20725 – 4.20775	73.00000 – 74.60000	1645.5 – 1646.5	9.300 – 9.500
6.21500 – 6.21800	74.80000 – 75.20000	1660.0 – 1710.0	10.600 – 12.700
6.26775 – 6.26825	108.00000 – 121.94000	1718.8 – 1722.2	13.250 – 13.400
6.31175 – 6.31225	123.00000 – 138.00000	2200.0 – 2300.0	14.470 – 14.500
8.29100 – 8.29400	149.90000 – 150.05000	2310.0 – 2390.0	15.350 – 16.200
8.36200 – 8.36600	156.52475 – 156.52525	2483.5 – 2500.0	17.700 – 21.400
8.37625 – 8.38675	156.70000 – 156.90000	2655.0 – 2900.0	22.010 – 23.120
8.41425 – 8.41475	162.01250 – 167.17000	3260.0 – 3267.0	23.600 – 24.000
12.29000 – 12.29300	167.72000 – 173.20000	3332.0 – 3339.0	31.200 – 31.800
12.51975 – 12.52025	240.00000 – 285.00000	3345.8 – 3358.0	36.430 – 36.500
12.57675 – 12.57725	322.00000 – 335.40000	3600.0 – 4400.0	Above 38.6
13.36000 – 13.41000			

\*\* : Until February 1, 1999, this restricted band shall be 0.490-0.510 MHz



## 7. On Time, Duty Cycle and Measurement methods

### 7.1. Test Limit

None; for reporting purposes only.

### 7.2. Test Procedure

KDB 789033 Zero-Span Spectrum Analyzer Method.

### 7.3. Test Setup Layout

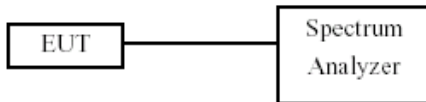

### 7.4. Test Result and Data

Temperature: 25°C

Humidity: 60%

Test Date: Jul. 25, 2017

Modulation Type	On Time (msec)	Period Time (msec)	Duty Cycle (%)	1/T Minimum VBW(Hz)	Duty Cycle correction Factor (dB)
802.11a	2.05	2.10	97.62%	487.80	0.10
802.11ac VHT20	1.92	1.97	97.46%	520.83	0.11
802.11ac VHT40	0.85	1.00	85.00%	1176.47	0.71
802.11ac VHT80	0.47	0.52	90.00%	2136.75	0.46

### 7.5. Measurement Methods

26 dB and 6dB Emission BW	KDB 789033 D02 v01, Section C
99% Occupied BW	KDB 789033 D02 v01, Section D
Conducted Output Power	KDB 789033 D02 v01, Section E.2.d and E.3.b (Method PM-G)
Power Spectral Density	KDB 789033 D02 v01, Section F
Unwanted emissions in restricted bands	KDB 789033 D02 v01, Sections G and H
Unwanted emissions in non-restricted bands	KDB 789033 D02 v01, Sections G and H



Modulation Standard: 802.11a (6Mbps)

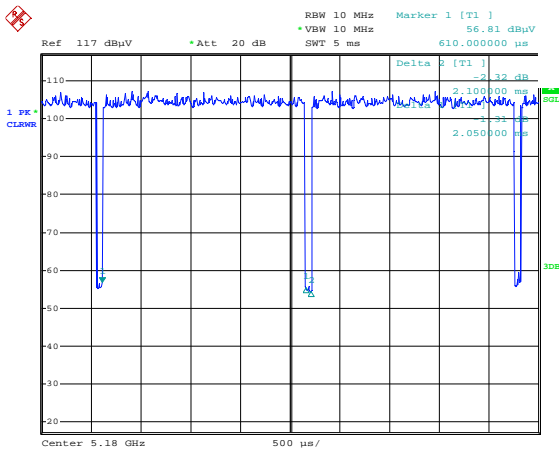

Modulation Standard: 802.11ac, VHT20 (6.5Mbps)

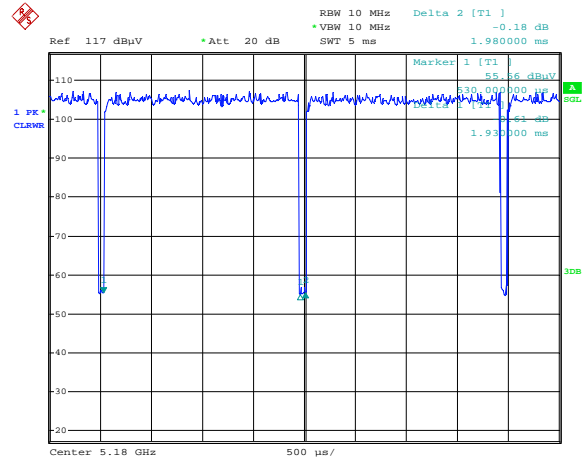

Modulation Standard: 802.11ac, VHT40 (13.5Mbps)

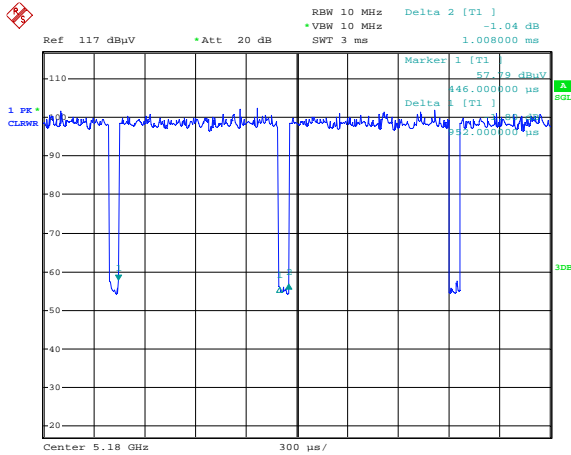

Modulation Standard: 802.11ac, VHT80 (29.3Mbps)

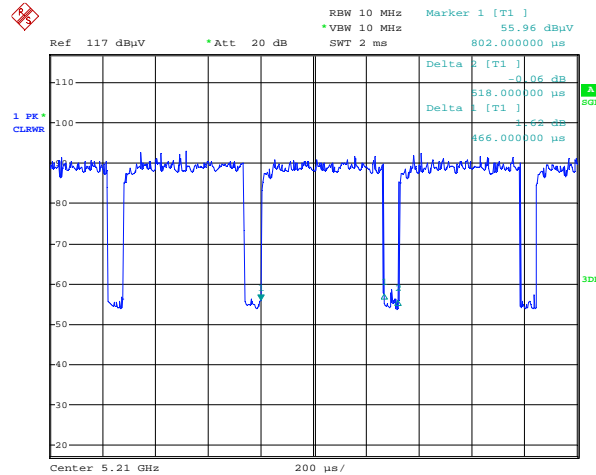



## 8. 26dB Bandwidth

### 8.1. Test Limit

None; for reporting purposes only.

### 8.2. Test Procedure

Reference to 789033 D02 General UNII Test Procedures New Rules v01: The transmitter output is connected to a spectrum analyzer with the RBW = approximately 1% of the emission bandwidth, the VBW >= 3 x RBW, peak detector and max hold.

### 8.3. Test Setup Layout

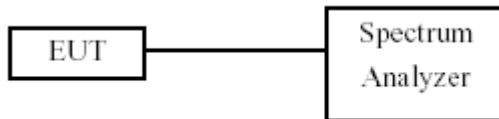

### 8.4. Test Result and Data

Temperature: 25°C

Humidity: 60%

Test Date: Jul. 25, 2017

#### In the 5.2G Band

Modulation Type	Channel	Frequency (MHz)	26dB Bandwidth (MHz)		
			ANT 1	ANT 2	ANT 3
802.11a	36	5180	22.40	21.90	22.10
	44	5220	22.30	22.20	22.20
	48	5240	22.40	22.20	22.60
802.11ac VHT20	36	5180	22.80	23.20	23.50
	44	5220	23.10	23.10	23.30
	48	5240	23.20	22.80	22.80
802.11ac VHT40	38	5190	45.80	44.60	45.40
	46	5230	45.80	45.00	45.80
802.11ac VHT80	42	5210	87.36	86.72	86.72





Antenna 1  
Modulation Standard: 802.11a (6Mbps)  
CH36

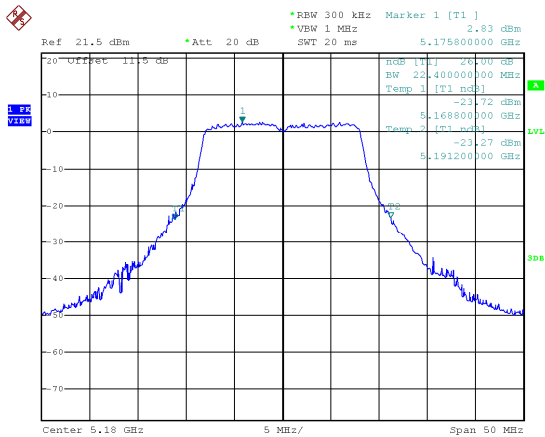

Modulation Standard: 802.11ac, VHT20 (6.5Mbps)  
CH36

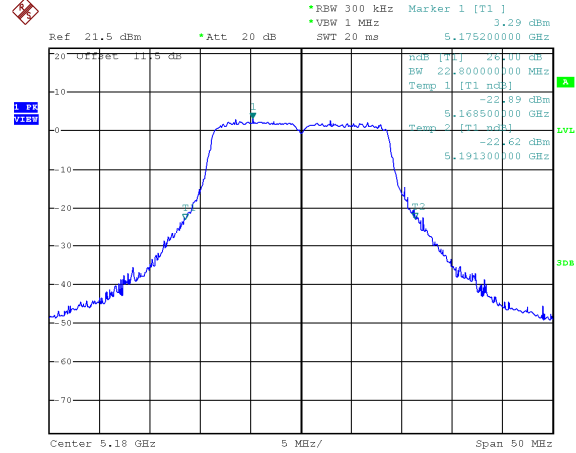

CH44

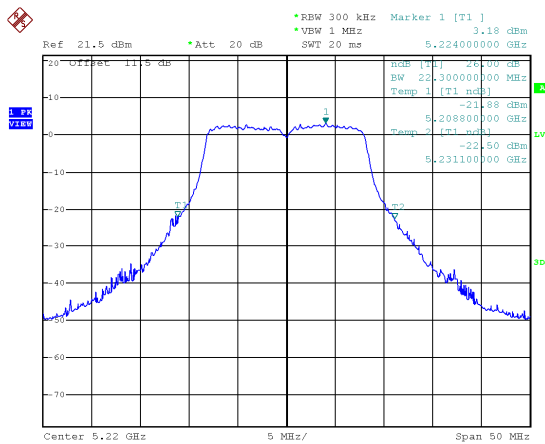

CH44

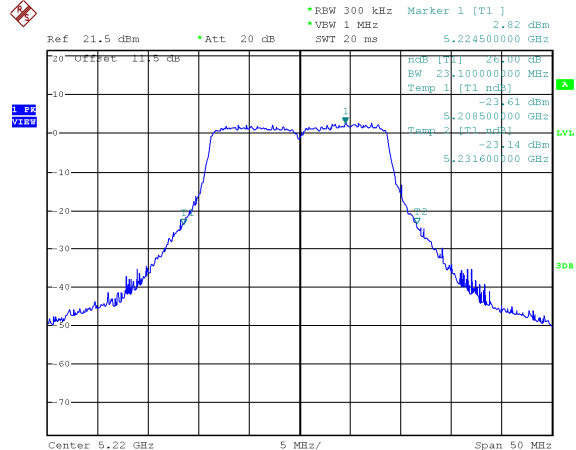

CH48

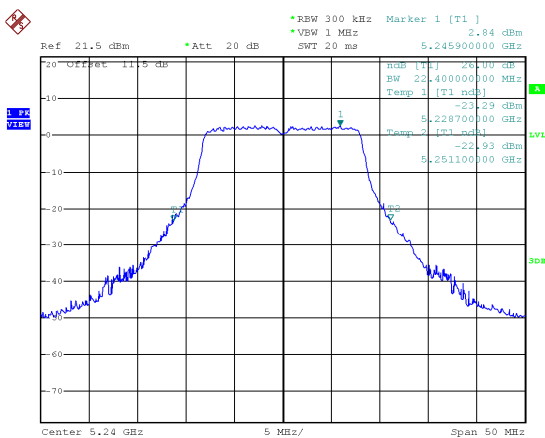

CH48

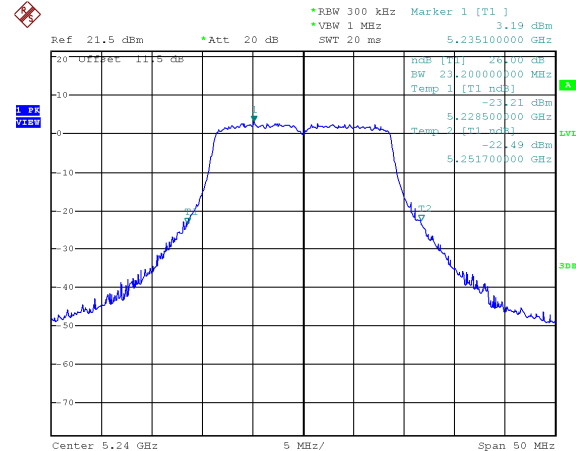



Antenna 1

Modulation Standard: 802.11ac, VHT40 (13.5Mbps) CH38

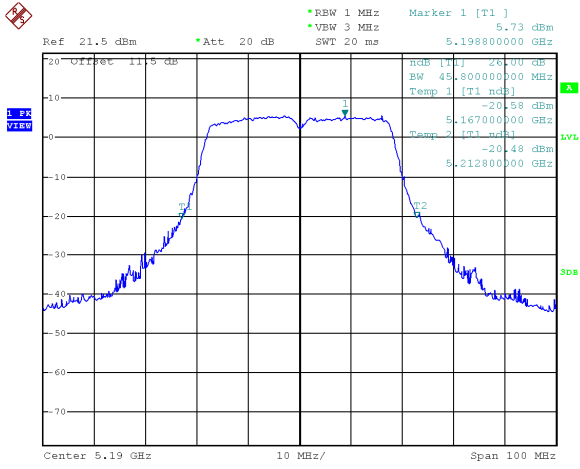

Modulation Standard: 802.11ac, VHT80 (29.3Mbps) CH42

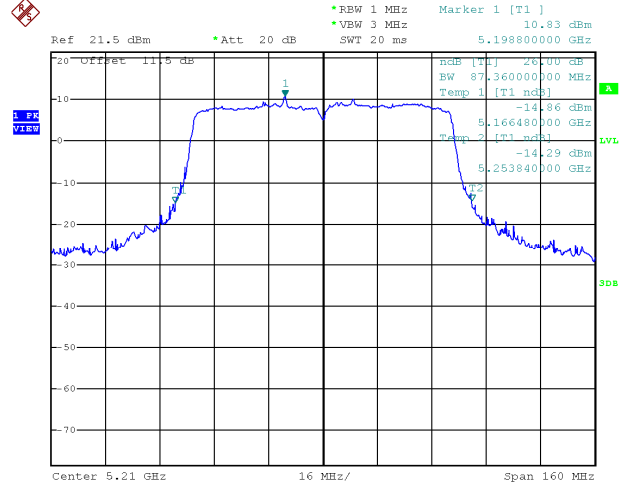

CH46

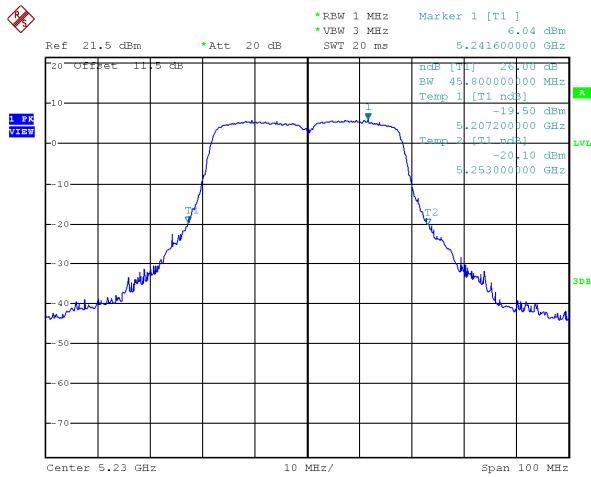



Antenna 2  
Modulation Standard: 802.11a (6Mbps)  
CH36

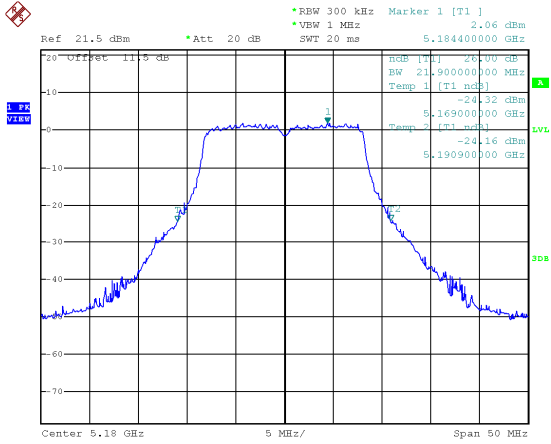

Modulation Standard: 802.11ac, VHT20 (6.5Mbps)  
CH36

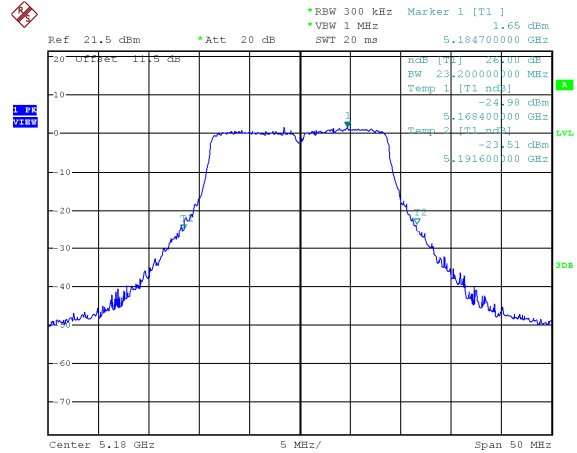

CH44

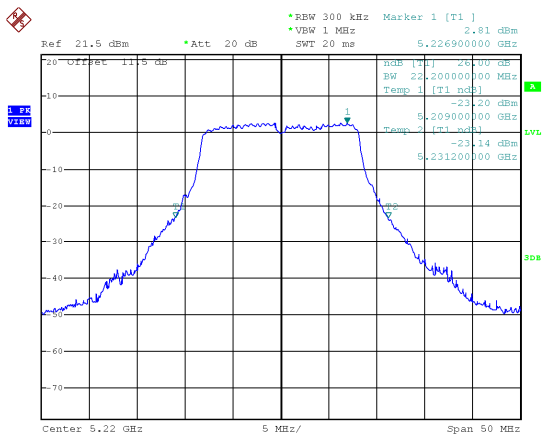

CH44

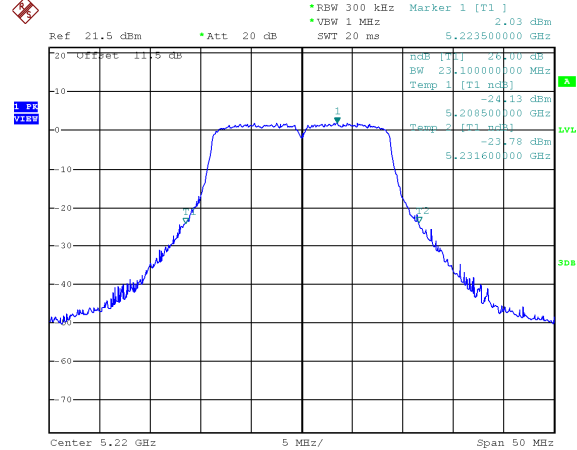

CH48

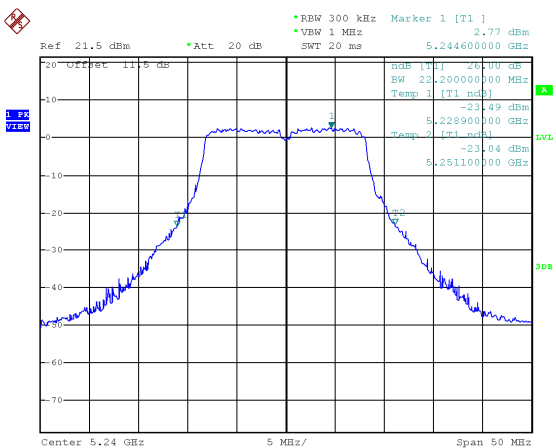

CH48

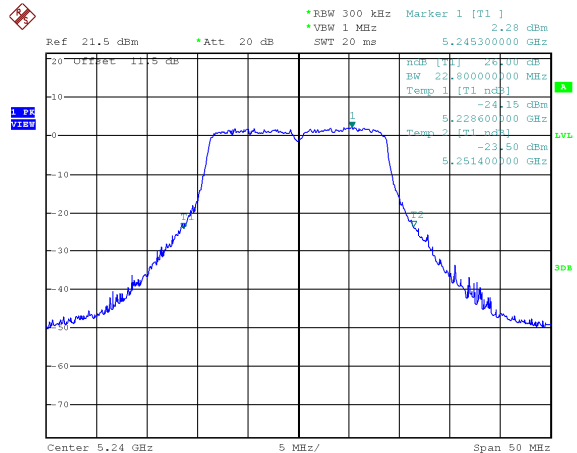



Antenna 2

Modulation Standard: 802.11ac, VHT40 (13.5Mbps) CH38

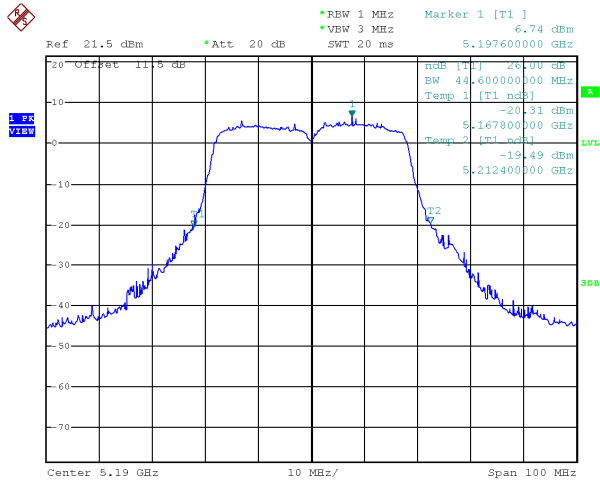

Modulation Standard: 802.11ac, VHT80 (29.3Mbps) CH42

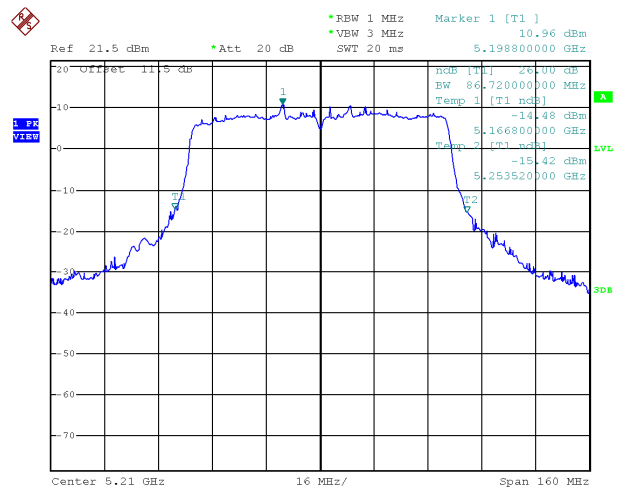

CH46

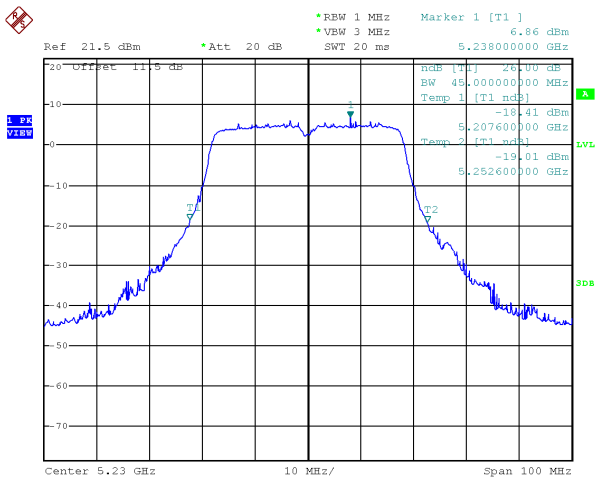



Antenna 3  
Modulation Standard: 802.11a (6Mbps)  
CH36

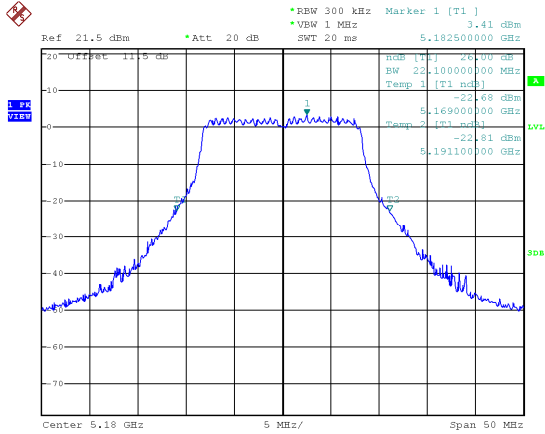

Modulation Standard: 802.11ac, VHT20 (6.5Mbps)  
CH36

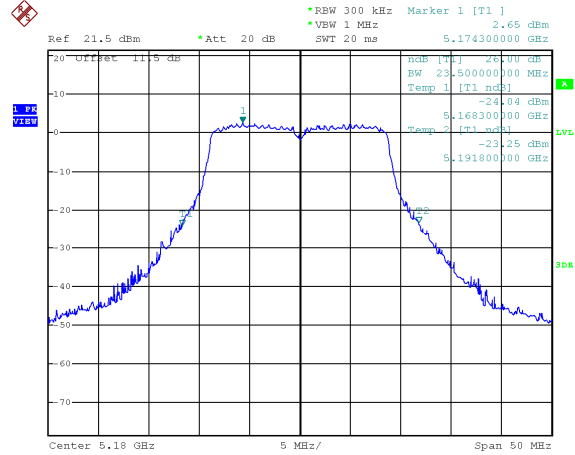

CH44

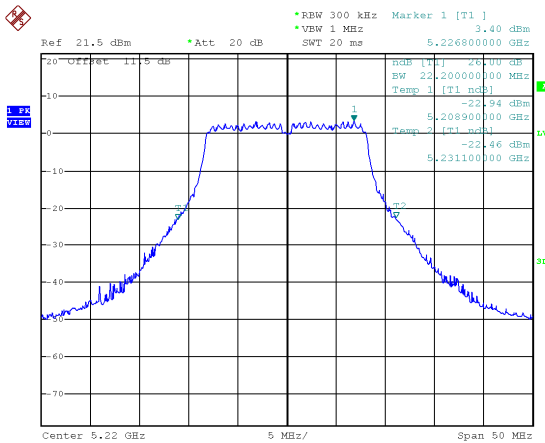

CH44

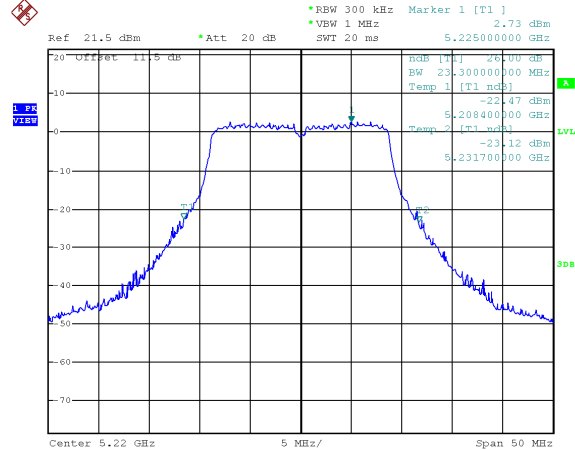

CH48

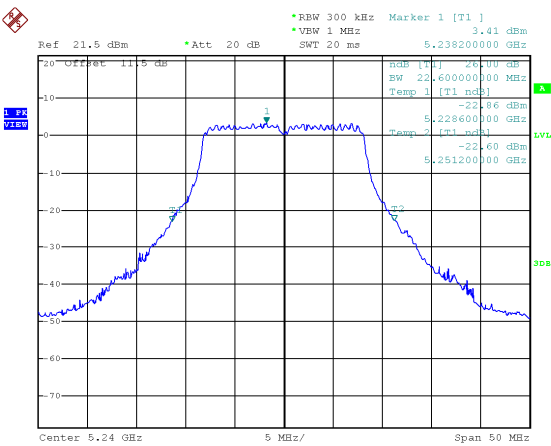

CH48

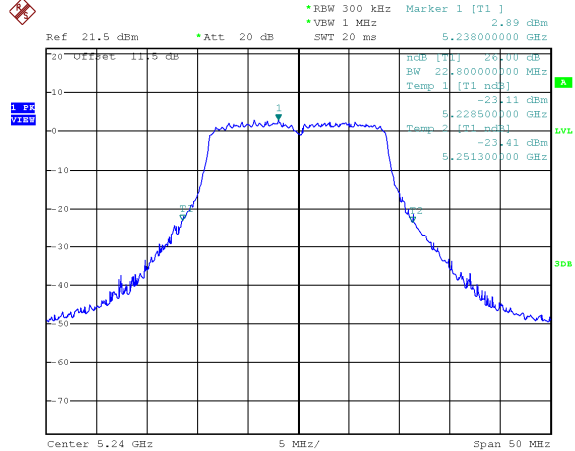



Antenna 3

Modulation Standard: 802.11ac, VHT40 (13.5Mbps) CH38

Modulation Standard: 802.11ac, VHT80 (29.3Mbps) CH42

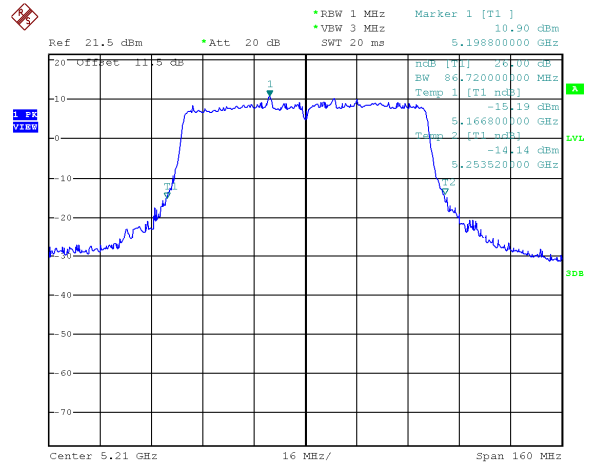
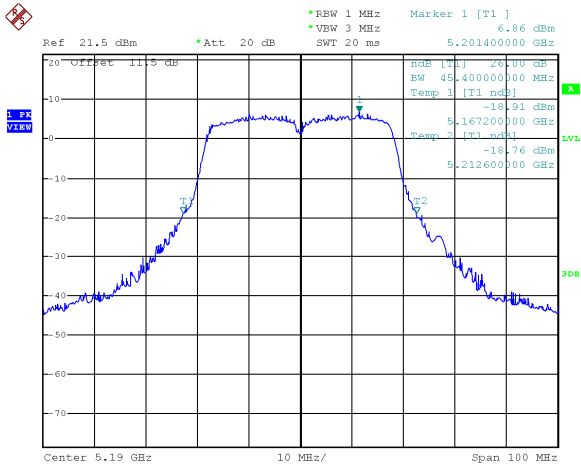

CH46

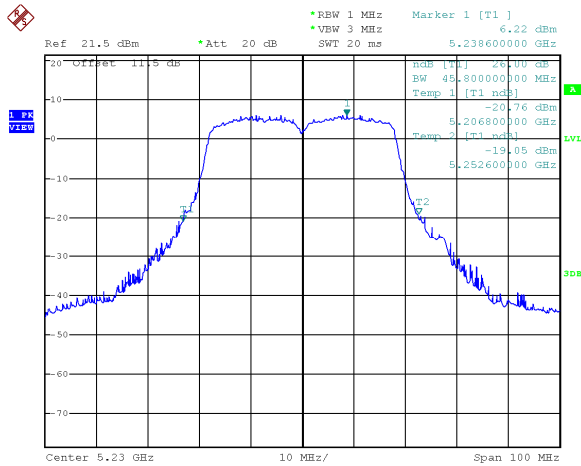



## 9. Average Power

### 9.1. Test Limit

For an outdoor access point operating in the band 5.15-5.25 GHz, the maximum conducted output power over the frequency band of operation shall not exceed 1 W provided the maximum antenna gain does not exceed 6 dBi. If transmitting antennas of directional gain greater than 6 dBi are used, both the maximum conducted output power and the maximum power spectral density shall be reduced by the amount in dB that the directional gain of the antenna exceeds 6 dBi. The maximum e.i.r.p. at any elevation angle above 30 degrees as measured from the horizon must not exceed 125 mW (21 dBm).

### 9.2. Test Procedure

The transmitter output is connected to a power meter.

The cable assembly insertion loss of 11 dB (including 10 dB pad and 1 dB cable) was entered as an offset in the power meter to allow for direct reading of power.

### 9.3. Test Setup Layout

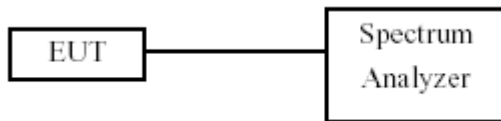

**9.4. Test Result and Data**

Temperature: 25°C

Humidity: 60%

Test Date: Jul. 25, 2017

**In the 5.2G Band**

Modulation Type	Channel	Frequency (MHz)	Avg Power Output (dBm)			Total Power (dBm)	Total Power (mW)	Power Limit (dBm)
			ANT 1	ANT 2	ANT 3			
802.11a	36	5180	11.52	10.68	11.61	16.06	40.37	30.00
	44	5220	11.50	11.00	11.18	16.00	39.84	30.00
	48	5240	11.40	11.01	11.13	15.95	39.39	30.00
802.11an HT20	36	5180	11.57	10.49	10.98	15.81	38.08	30.00
	44	5220	11.41	10.87	11.01	15.87	38.67	30.00
	48	5240	11.42	11.06	11.02	15.94	39.28	30.00
802.11an HT40	38	5190	10.69	9.78	10.33	15.05	32.02	30.00
	46	5230	11.65	10.94	11.25	16.06	40.37	30.00
802.11ac VHT20	36	5180	11.63	10.56	11.04	15.87	38.64	30.00
	44	5220	11.48	10.91	11.04	15.92	39.10	30.00
	48	5240	11.43	11.08	11.12	15.98	39.66	30.00
802.11ac VHT40	38	5190	10.79	9.83	10.57	15.19	33.01	30.00
	46	5230	11.61	10.91	11.36	16.07	40.50	30.00
802.11ac VHT80	42	5210	10.06	9.69	10.02	14.70	29.50	30.00

**In the 5.2G Band**

Modulation Type	Channel	Freq. (MHz)	N <sub>SS</sub>	N <sub>TX</sub>	Measured value of each antenna port (dBm)		Gain above 30° (dB)	E.I.R.P Power above 30° (dBm)	Total E.I.R.P above 30° (dBm)	E.I.R.P Limit (dBm)
					ANT 1	ANT 2				
802.11a	36	5180	1	3	ANT 1	11.52	5.1	16.62	20.94	21
					ANT 2	10.68				
					ANT 3	11.61				
802.11a	44	5220	1	3	ANT 1	11.5	5.1	16.6	20.88	21
					ANT 2	11				
					ANT 3	11.18				
802.11a	48	5240	1	3	ANT 1	11.4	5.1	16.5	20.83	21
					ANT 2	11.01				
					ANT 3	11.13				





Modulation Type	Channel	Freq. (MHz)	N <sub>SS</sub>	N <sub>TX</sub>	Measured value of each antenna port (dBm)		Gain above 30° (dB)	E.I.R.P Power above 30° (dBm)	Total E.I.R.P above 30° (dBm)	E.I.R.P Limit (dBm)		
					ANT 1	ANT 2						
802.11n HT20	36	5180	1	3	ANT 1	11.57	5.1	16.67	20.69	21		
					ANT 2	10.49					4.7	15.19
					ANT 3	10.98						
802.11n HT20	44	5220	1	3	ANT 1	11.41	5.1	16.51	20.75	21		
					ANT 2	10.87					4.7	15.57
					ANT 3	11.01						
802.11n HT20	48	5240	1	3	ANT 1	11.42	5.1	16.52	20.82	21		
					ANT 2	11.06					4.7	15.76
					ANT 3	11.02						
802.11n HT40	38	5190	1	3	ANT 1	10.69	5.1	15.79	19.94	21		
					ANT 2	9.78					4.7	14.48
					ANT 3	10.33						
802.11n HT40	46	5230	1	3	ANT 1	11.65	5.1	16.75	20.94	21		
					ANT 2	10.94					4.7	15.64
					ANT 3	11.25						
802.11ac VHT20	36	5180	1	3	ANT 1	11.63	5.1	16.73	20.76	21		
					ANT 2	10.56					4.7	15.26
					ANT 3	11.04						
802.11ac VHT20	44	5220	1	3	ANT 1	11.48	5.1	16.58	20.80	21		
					ANT 2	10.91					4.7	15.61
					ANT 3	11.04						
802.11ac VHT20	48	5240	1	3	ANT 1	11.43	5.1	16.53	20.86	21		
					ANT 2	11.08					4.7	15.78
					ANT 3	11.12						
802.11ac VHT40	38	5190	1	3	ANT 1	10.79	5.1	15.89	20.07	21		
					ANT 2	9.83					4.7	14.53
					ANT 3	10.57						
802.11ac VHT40	46	5230	1	3	ANT 1	11.61	5.1	16.71	20.95	21		
					ANT 2	10.91					4.7	15.61
					ANT 3	11.36						
802.11ac VHT80	42	5210	1	3	ANT 1	10.06	5.1	15.16	19.57	21		
					ANT 2	9.69					4.7	14.39
					ANT 3	10.02						



## 10. PPSD

### 10.1. Test Limit

**Output Power:**

Frequency Band		Limit
<input checked="" type="checkbox"/>	5.15~5.25GHz	
Operating Mode		
<input checked="" type="checkbox"/>	Outdoor access point	The maximum conducted output power over the frequency band of operation shall not exceed 1 W (30dBm) provided the maximum antenna gain does not exceed 6 dBi. If transmitting antennas of directional gain greater than 6 dBi are used, both the maximum conducted output power and the maximum power spectral density shall be reduced by the amount in dB that the directional gain of the antenna exceeds 6 dBi. The maximum e.i.r.p. at any elevation angle above 30degrees as measured from the horizon must not exceed125 mW (21 dBm).
<input checked="" type="checkbox"/>	Indoor access point	The maximum conducted output power over the frequency band of operation shall not exceed 1 W (30dBm) provided the maximum antenna gain does not exceed 6 dBi. If transmitting antennas of directional gain greater than 6 dBi are used, both the maximum conducted output power and the maximum power spectral density shall be reduced by the amount in dB that the directional gain of the antenna exceeds 6 dBi.
<input type="checkbox"/>	Fixed point-to-point access points	The maximum conducted output power over the frequency band of operation shall not exceed 1 W (30dBm). Fixed point-to-point U-NII devices may employ antennas with directional gain up to 23 dBi without any corresponding reduction in the maximum conducted output power or maximum power spectral density. For fixed point-to-point transmitters that employ a directional antenna gain greater than 23 dBi, a 1 dB reduction in maximum conducted output power and maximum power spectral density is required for each 1 dB of antenna gain in excess of 23 dBi.
<input type="checkbox"/>	Mobile and portable client devices	The maximum conducted output power over the frequency band of operation shall not exceed 250 mW (24dBm) provided the maximum antenna gain does not exceed 6 dBi. If transmitting antennas of directional gain greater than 6 dBi are used, both the maximum conducted output power and the maximum power spectral density shall be reduced by the amount in dB that the directional gain of the antenna exceeds 6 dBi.



Frequency Band		Limit
<input type="checkbox"/>	5.25-5.35 GHz	The maximum conducted output power over the frequency bands of operation shall not exceed the lesser of 250 mW (24dBm) or 11 dBm 10 log B, where B is the 26 dB emission bandwidth in megahertz. If transmitting antennas of directional gain greater than 6 dBi are used, both the maximum conducted output power and the maximum power spectral density shall be reduced by the amount in dB that the directional gain of the antenna exceeds 6 dBi.
<input type="checkbox"/>	5.470-5.725 GHz	
<input checked="" type="checkbox"/>	5.725~5.85 GHz	The maximum conducted output power over the frequency band of operation shall not exceed 1 W (30dBm). If transmitting antennas of directional gain greater than 6 dBi are used, both the maximum conducted output power and the maximum power spectral density shall be reduced by the amount in dB that the directional gain of the antenna exceeds 6 dBi. However, fixed point-to-point U-NII devices operating in this band may employ transmitting antennas with directional gain greater than 6 dBi without any corresponding reduction in transmitter conducted power.

**PSD:**

Frequency Band		Limit	
<input checked="" type="checkbox"/>	5.15~5.25GHz		
	Operating Mode		
	<input checked="" type="checkbox"/> Outdoor access point		17 dBm/MHz
	<input checked="" type="checkbox"/> Indoor access point		17 dBm/MHz
	<input type="checkbox"/> Fixed point-to-point access points		17 dBm/MHz
<input type="checkbox"/> Mobile and portable client devices	11 dBm/MHz		
<input type="checkbox"/>	5.725~5.85 GHz	11 dBm/MHz	
<input type="checkbox"/>	5.470-5.725 GHz	11 dBm/MHz	
<input checked="" type="checkbox"/>	5.725~5.85 GHz	30 dBm/500kHz	



### 10.2. Test Procedure

As an alternative to FCC KDB-789033, the EUT maximum conducted output power was Measured with an average power meter employing a video bandwidth greater than 6dB BW of the emission under test. Maximum conducted output power was read directly from the meter across all data rates, and across three channels within each sub-band. Special care was used to make sure that the EUT was transmitting in continuous mode. This method exceeds the limitations of FCC KDB-789033, and provides more accurate measurements.

802.11an (BW ≤ 40MHz) Maximum conducted output power using KDB 789033 section E)3)b) Method PM-G (Measurement using a gated RF average power meter)

Note: the power meter have a video bandwidth that is greater than or equal to the measurement bandwidth, (Anritsu/ MA2411B video bandwidth: 65MHz)

802.11ac (BW=80MHz) Maximum conducted output power using KDB 789033 section E)2)b) Method SA-1 (trace averaging with the EUT transmitting at full power throughout each sweep).

When transmitted signals consist of two or more non-contiguous spectrum segments (e.g., 80+80 MHz mode) or when a single spectrum segment of a transmission crosses the boundary between two adjacent U-NII bands, KDB 644545 D01 section F) procedure is used for measurements.

### 10.3. Test Setup Layout

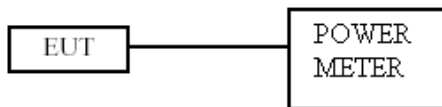

### 10.4. Test Result and Data

Temperature: 25°C

Humidity: 60%

Test Date: Jul. 25, 2017

#### In the 5.2G Band

Modulation Type	CH	Freq. (MHz)	Meas PPSD (dBm/MHz)			Sum chain (dBm)	Duty Cycle CF(dB)	Total Corr'd PPSD (dBm/MHz)	PPSD Limit (dBm/MHz)
			ANT 1	ANT 2	ANT 3				
802.11a	36	5180	-0.59	-1.63	-0.79	3.79	0.10	3.90	13.36
	44	5220	-0.51	-1.11	-0.49	4.08	0.10	4.18	13.36
	48	5240	-0.63	-0.85	-0.99	3.95	0.10	4.06	13.36
802.11ac VHT20	36	5180	-0.94	-1.96	-1.14	3.45	0.11	3.56	13.36
	44	5220	-0.92	-1.23	-1.24	3.64	0.11	3.76	13.36
	48	5240	-1.05	-1.52	-1.21	3.52	0.11	3.63	13.36
802.11ac VHT40	38	5190	-3.84	-4.83	-4.30	0.47	0.71	1.17	13.36
	46	5230	-4.03	-3.97	-3.88	0.81	0.71	1.52	13.36
802.11ac VHT80	42	5210	-7.39	-7.81	-7.59	-2.82	0.46	-2.36	13.36



5.2G Band

Antenna 1

Modulation Standard: 802.11a (6Mbps)  
CH36

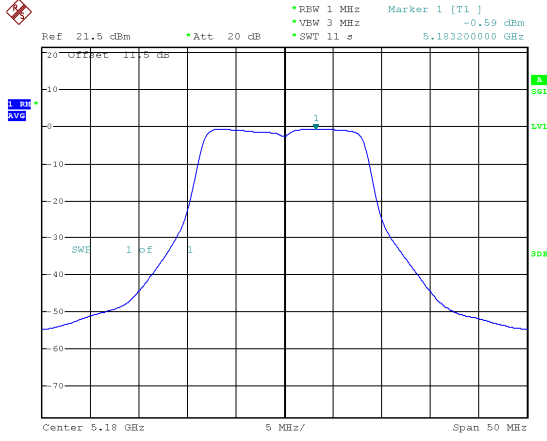

Modulation Standard: 802.11ac, VHT20 (6.5Mbps)  
CH36

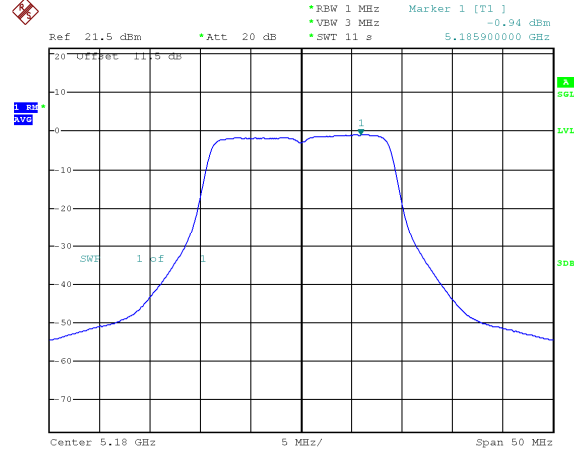

CH44

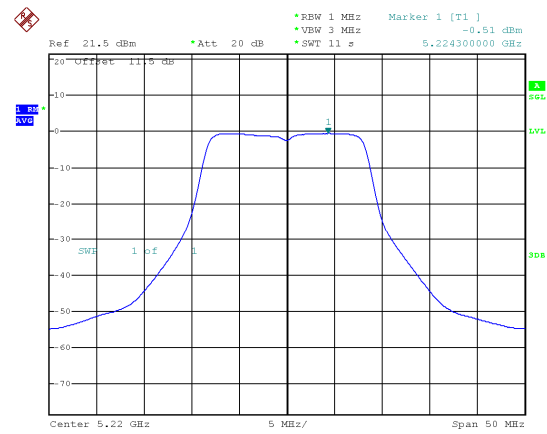

CH44

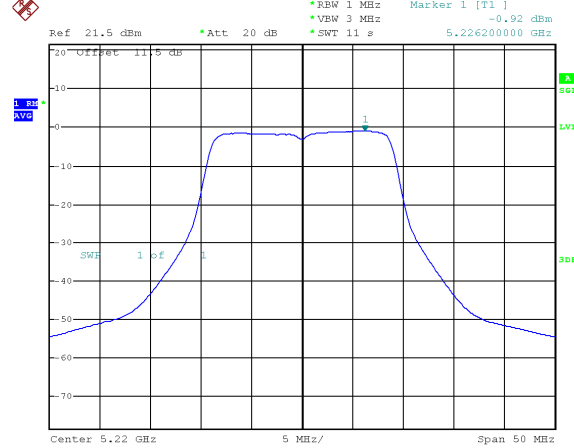

CH48

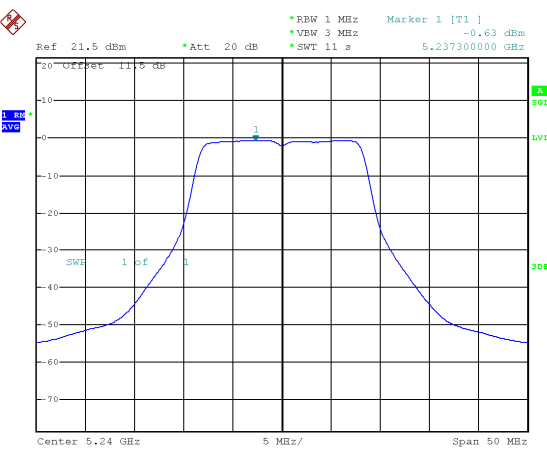

CH48

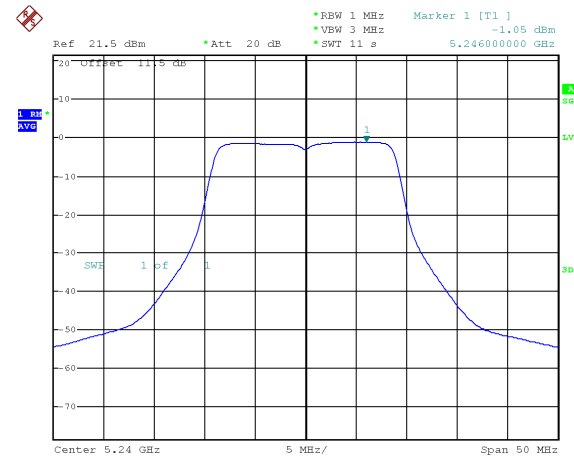



Antenna 1

Modulation Standard: 802.11ac, VHT40 (13.5Mbps)  
CH38

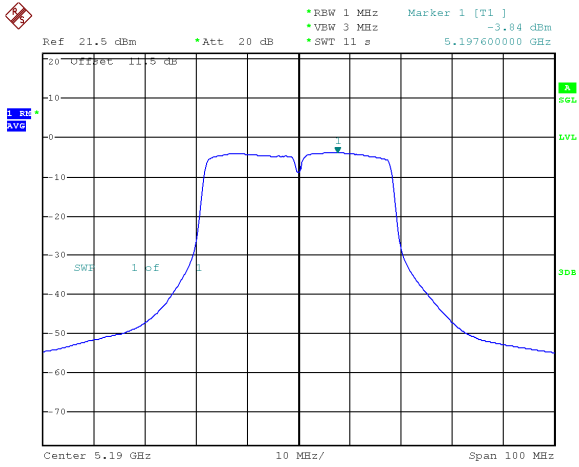

Modulation Standard: 802.11ac, VHT80 (29.3Mbps)  
CH42

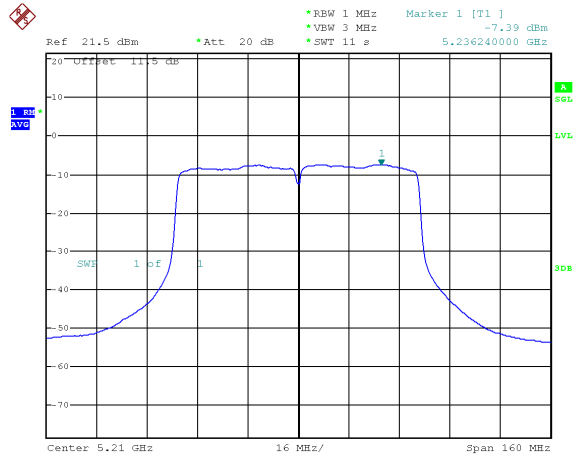

CH46

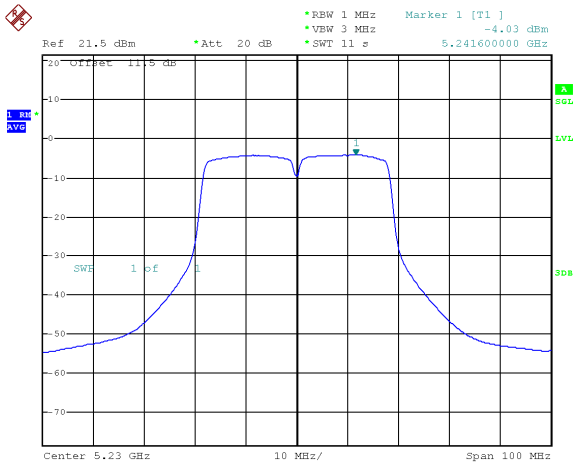



Antenna 2  
Modulation Standard: 802.11a (6Mbps)  
CH36

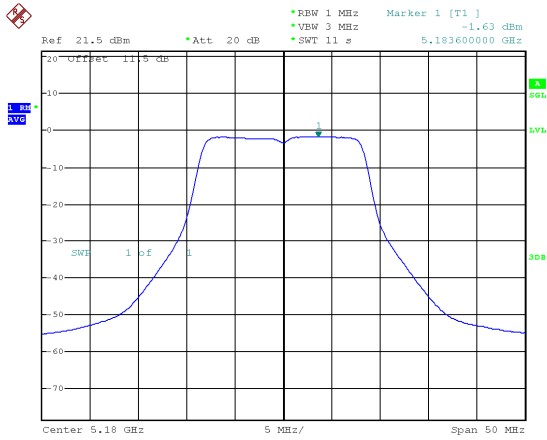

Modulation Standard: 802.11ac, VHT20 (6.5Mbps)  
CH36

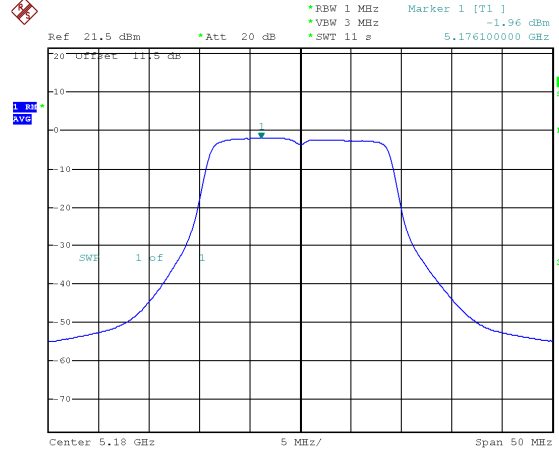

CH44

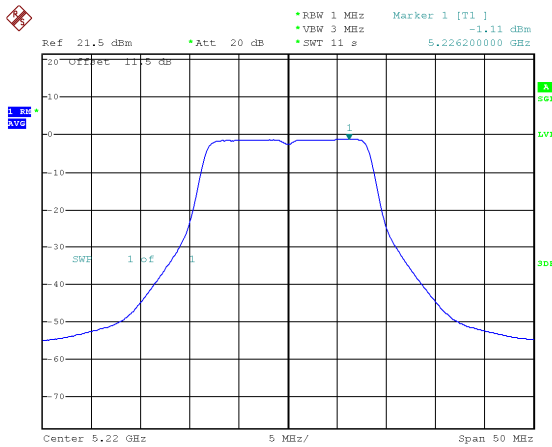

CH44

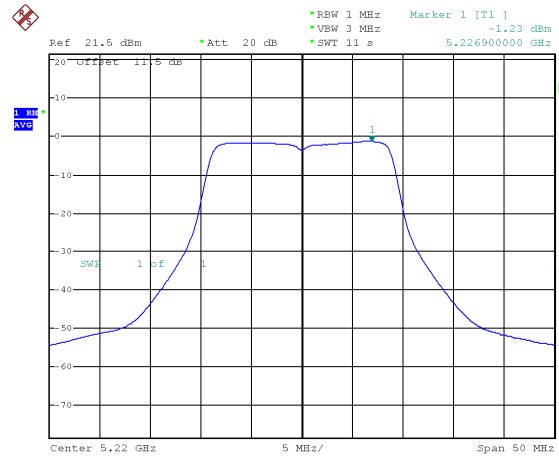

CH48

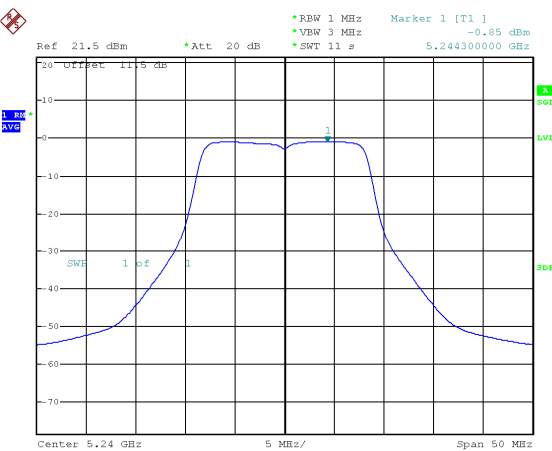

CH48

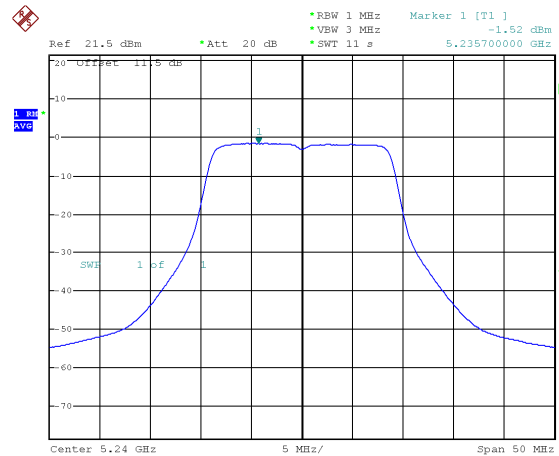



Antenna 2

Modulation Standard: 802.11ac, VHT40 (13.5Mbps)  
CH38

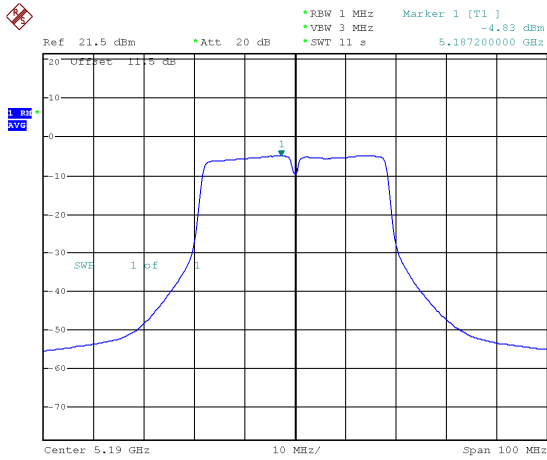

Modulation Standard: 802.11ac, VHT80 (29.3Mbps)  
CH42

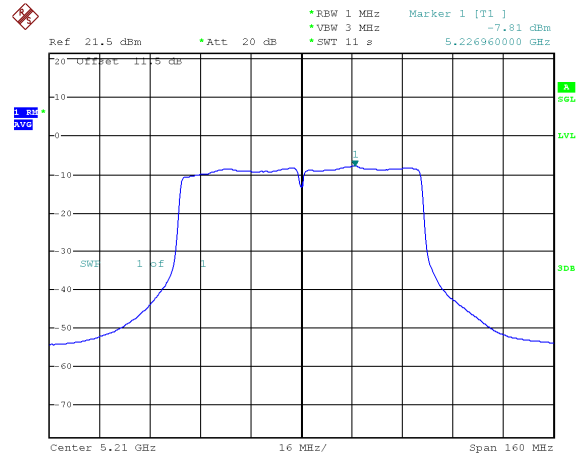

CH46

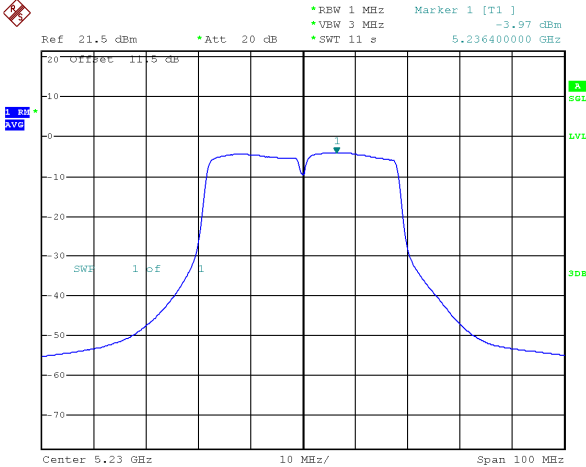





Antenna 3  
Modulation Standard: 802.11a (6Mbps)  
CH36

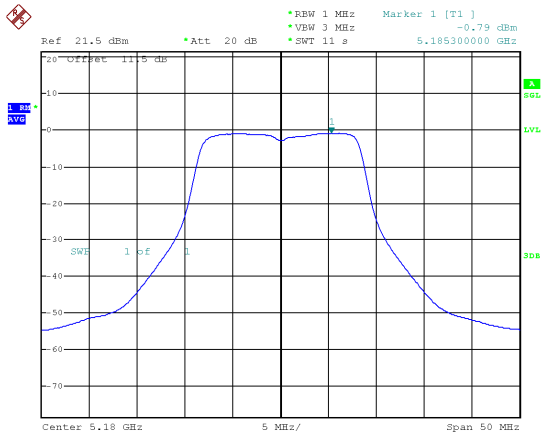

Modulation Standard: 802.11ac, VHT20 (6.5Mbps)  
CH36

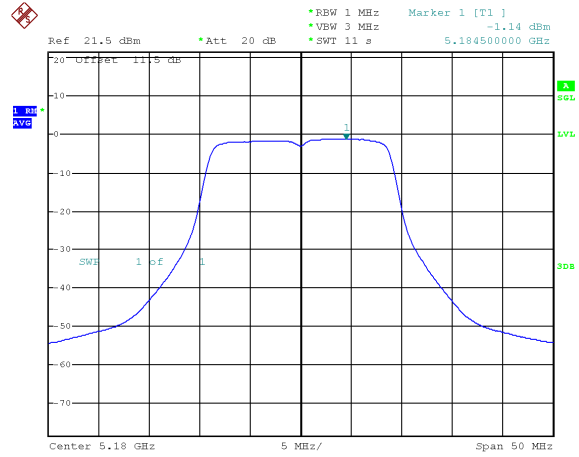

CH44

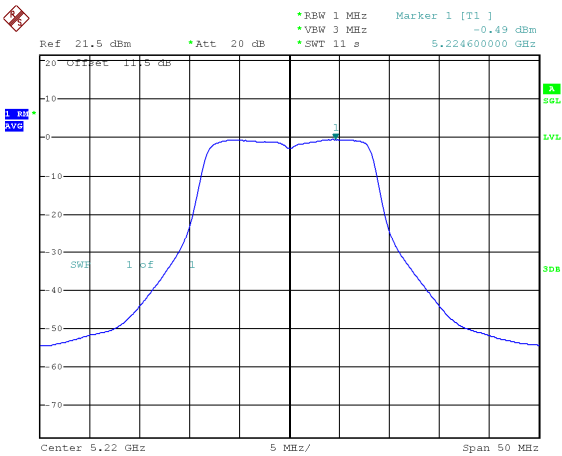

CH44

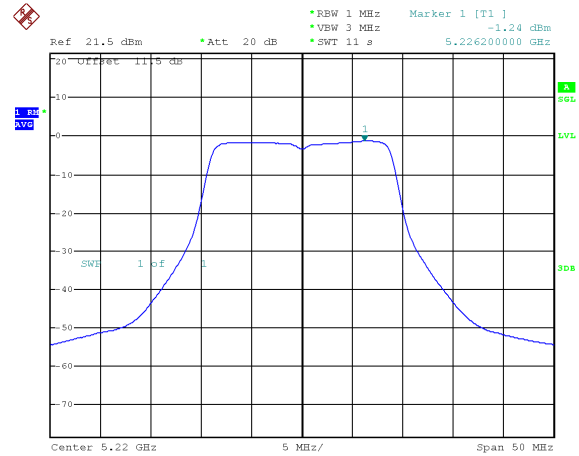

CH48

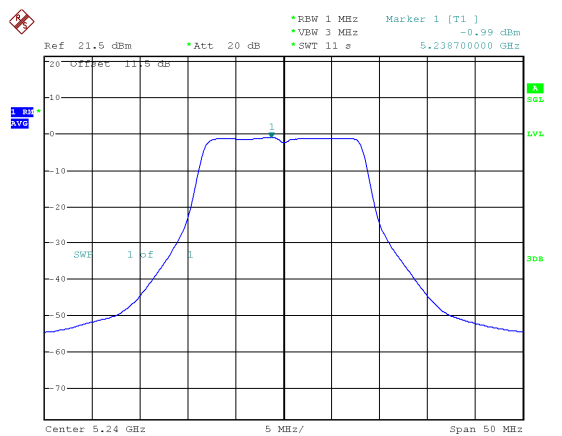

CH48

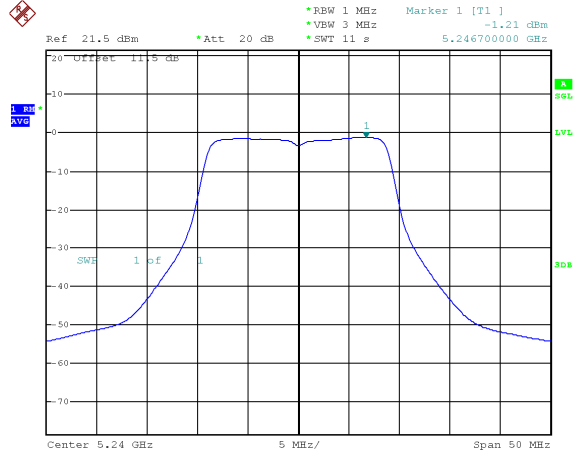



Antenna 3

Modulation Standard: 802.11ac, VHT40 (13.5Mbps)  
CH38

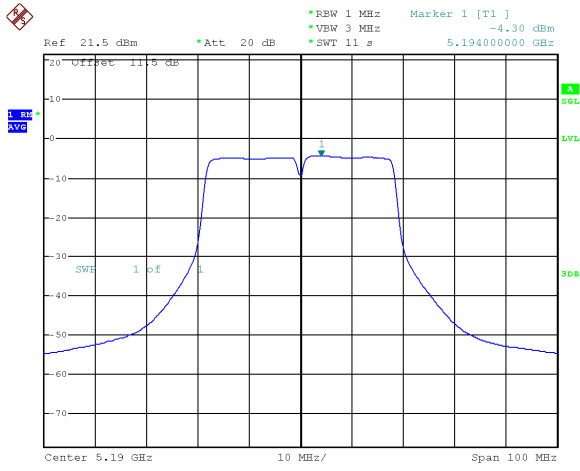

Modulation Standard: 802.11ac, VHT80 (29.3Mbps)  
CH42

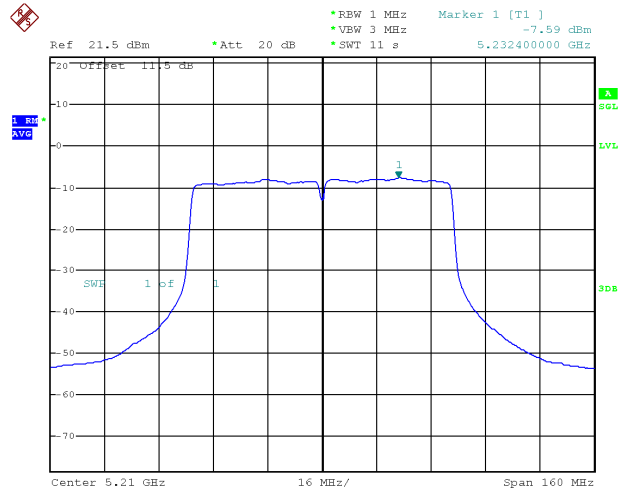

CH46

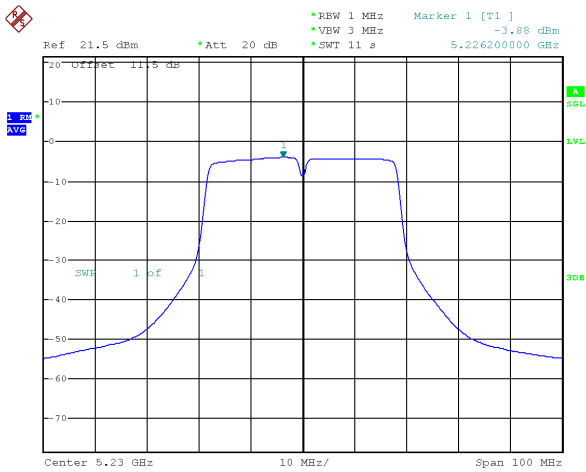



## 11. Frequency Stability

### 11.1. Test Procedure

1. The EUT was placed inside the Temperature and Humidity chamber.
2. The transmitter output was connected to spectrum analyzer.
3. Turn the EUT on and couple its output to a spectrum analyzer.
4. Turn the EUT off and set the chamber to the highest temperature specified.
5. Allow sufficient time (approximately 30 min) for the temperature of the chamber to stabilize, turn the EUT on and measure the operating frequency after 2, 5, and 10 minutes.
6. Repeat step 2 and 3 with the temperature chamber set to the lowest temperature.
7. The test chamber was allowed to stabilize at +20 degree C for a minimum of 30 minutes. The supply voltage was then adjusted on the EUT from 85% to 115% and the frequency record.

### 11.2. Test Setup Layout

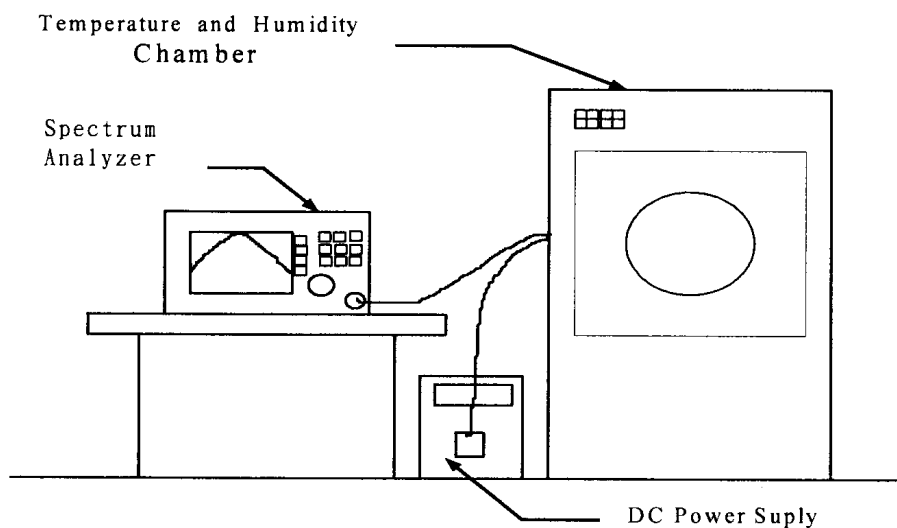



11.3. Test Result and Data

Temperature: 25°C

Humidity: 60%

Test Date: Jul. 25, 2017

Operating frequency: 5180 MHz							
Temp	Power supply	2 minute		5 minute		10 minute	
(°C)	(V)	(MHz)	(%)	(MHz)	(%)	(MHz)	(%)
55	102	5179.9905	-0.000481	5179.6964	0.001403	5179.9106	-0.001597
	120	5179.1772	-0.001203	5179.0394	0.000337	5179.5705	0.000163
	138	5179.5429	-0.001561	5179.6522	0.001756	5179.2216	-0.000046
40	102	5179.5595	0.001481	5179.8270	-0.000948	5179.4093	-0.001416
	120	5179.4599	-0.000680	5179.0546	-0.001192	5179.8926	0.001637
	138	5179.8581	0.001754	5179.7115	-0.001283	5179.5289	0.001601
30	102	5179.3769	-0.001727	5179.6699	-0.000284	5179.0823	-0.000188
	120	5179.9169	0.000306	5179.6403	0.001731	5179.9184	0.001637
	138	5179.0564	0.000173	5179.0924	0.001075	5179.3792	-0.000941
20	102	5179.4268	0.001816	5179.7717	0.000973	5179.9101	-0.000066
	120	5179.9354	-0.001325	5179.8947	-0.000732	5179.6562	0.000186
	138	5179.7828	0.001584	5179.0535	0.000054	5179.9636	-0.000842
10	102	5179.9391	-0.001654	5179.7599	-0.000792	5179.1767	0.001216
	120	5179.8723	-0.000234	5179.0996	-0.000293	5179.8226	0.001901
	138	5179.7792	0.000333	5179.4824	0.001927	5179.6730	0.000409
0	102	5179.2982	-0.000227	5179.4101	-0.001176	5179.0718	-0.000354
	120	5179.4308	-0.000935	5179.9450	-0.000917	5179.6967	0.001168
	138	5179.4532	0.001318	5179.1615	-0.001487	5179.3222	0.000872
-10	102	5179.3832	0.001163	5179.1097	0.001518	5179.8043	0.000421
	120	5179.2259	0.000804	5179.2812	-0.001029	5179.6869	-0.001350
	138	5179.7606	0.001900	5179.1119	-0.000454	5179.7414	-0.000328
-20	102	5179.4970	-0.000985	5179.6696	0.000122	5179.3358	0.000189
	120	5179.4398	0.001856	5179.5995	0.000623	5179.4248	0.000491
	138	5179.8862	0.000030	5179.7869	-0.000528	5179.7340	0.000055
-30	102	5179.5837	-0.000892	5179.9724	-0.001602	5179.7676	0.001182
	120	5179.9357	-0.000447	5179.1066	-0.000222	5179.7421	-0.001196
	138	5179.3405	-0.001184	5179.2267	-0.000422	5179.9182	0.001191

Limit:

Manufacturers of U-NII devices are responsible for ensuring frequency stability such that an emission is maintained within the band of operation under all conditions of normal operation as specified in the users manual.



## **12. Automatically Discontinue Transmission**

### **12.1.Limit of Automatically Discontinue Transmission**

The device shall automatically discontinue transmission in case of either absence of information to transmit or operational failure. These provisions are not intended to preclude the transmission of control or signaling information or the use of repetitive codes used by certain digital technologies to complete frame or burst intervals. Applicants shall include in their application for equipment authorization to describe how this requirement is met.

### **12.2.Test Result of Automatically Discontinue Transmission**

While the EUT is not transmitting any information, the EUT can automatically discontinue transmission and become standby mode for power saving. The EUT can detect the controlling signal of ACK message transmitting from remote device and verify whether it shall resend or discontinue transmission.



### 13. Radio Frequency Exposure

#### 13.1. Applicable Standards

The measurements shown in this test report were made in accordance with the procedures given in FCC Part 2 (Section 2.1091)  
KDB 447498

#### 13.2. EUT Specification

<b>Frequency band (Operating)</b>	<input type="checkbox"/> WLAN: 2412MHz ~ 2462MHz <input checked="" type="checkbox"/> WLAN: 5150MHz ~ 5250MHz <input type="checkbox"/> WLAN: 5250MHz ~ 5350MHz <input type="checkbox"/> WLAN: 5470MHz ~ 5725MHz <input type="checkbox"/> WLAN: 5725MHz ~ 5850MHz <input type="checkbox"/> Bluetooth: 2402MHz ~ 2480MHz
<b>Device category</b>	<input type="checkbox"/> Portable (<20cm separation) <input checked="" type="checkbox"/> Mobile (>20cm separation)
<b>Exposure classification</b>	<input type="checkbox"/> Occupational/Controlled exposure (S = 5mW/cm <sup>2</sup> ) <input checked="" type="checkbox"/> General Population/Uncontrolled exposure (S=1mW/cm <sup>2</sup> )
<b>Antenna diversity</b>	<input type="checkbox"/> Single antenna <input checked="" type="checkbox"/> Multiple antennas <input type="checkbox"/> Tx diversity <input type="checkbox"/> Rx diversity <input checked="" type="checkbox"/> Tx/Rx diversity
<b>Evaluation applied</b>	<input checked="" type="checkbox"/> MPE Evaluation* <input type="checkbox"/> SAR Evaluation <input type="checkbox"/> N/A

**Remark:**

1. The maximum output power is 16.07dBm (0.0261mW) at 5230MHz (with numeric 5.1 antenna gain.)
2. DTS device is not subject to routine RF evaluation; MPE estimate is used to justify the compliance.
3. For mobile or fixed location transmitters, no SAR consideration applied. The maximum power density is 1.0 mW/cm<sup>2</sup> even if the calculation indicates that the power density would be larger.

#### 13.3. Test Results

No non-compliance noted.



### 13.4. Calculation

Given  $E = \frac{\sqrt{30 \times P \times G}}{d}$  &  $S = \frac{E^2}{3770}$

Where E = Field strength in Volts / meter

P = Power in Watts

G = Numeric antenna gain

d = Distance in meters

S = Power density in milliwatts / square centimeter

Combining equations and re-arranging the terms to express the distance as a function of the remaining variables yields:

$$S = \frac{30 \times P \times G}{3770d^2}$$

Changing to units of mW and cm, using:

P (mW) = P (W) / 1000 and

d (cm) = d(m) / 100

Yields

$$S = \frac{30 \times (P/1000) \times G}{3770 \times (d/100)^2} = 0.0796 \times \frac{P \times G}{d^2} \quad \text{Equation 1}$$

Where d = Distance in cm

P = Power in mW

G = Numeric antenna gain

S = Power density in mW / cm<sup>2</sup>

**13.5. Maximum Permissible Exposure**

Max. output power	Band: 5150MHz ~ 5250MHz 802.11a: 16.06dBm (0.0260mW) 802.11an VHT20: 15.94dBm (0.0253mW) 802.11an VHT40: 16.06dBm (0.0260mW) 802.11ac VHT20: 15.98dBm (0.0255mW) 802.11ac VHT40: 16.07dBm (0.0261mW) 802.11ac VHT80: 14.70dBm (0.0190mW)
Antenna gain (Max)	5.1dBi

**Maximum Permissible Exposure**

Modulation Mode	Frequency band (MHz)	Max. Conducted output power (dBm)	Antenna gain (dBi)	Distance (cm)	Power density (mW/cm <sup>2</sup> )	Limit (mW/cm <sup>2</sup> )
802.11a	5150-5250	16.06	5.1	20	0.0260	1
802.11an HT20	5150-5250	15.94	5.1	20	0.0253	1
802.11an HT40	5150-5250	16.06	5.1	20	0.0260	1
802.11ac VHT20	5150-5250	15.98	5.1	20	0.0255	1
802.11ac VHT40	5150-5250	16.07	5.1	20	0.0261	1
802.11ac VHT80	5150-5250	14.70	5.1	20	0.0190	1

**Maximum Permissible Exposure (Co-location)**

Modulation Mode	Frequency band (MHz)	Max. Conducted output power (dBm)	Antenna Gain(dBi)	Distance (cm)	Power Density (mW/cm <sup>2</sup> )
2.4G 11n HT20	2412-2462	29.66	4.6	20	0.5306
5G 11ac VHT20	5725-5850	28.50	5.1	20	0.4562
Co-location Total					0.9868
Maximum Permissible Exposure Limit					1