

RF Test Report

Applicant : Datto, Inc.

Product Type : WiFi Access Point

Trade Name : Open Mesh, Inc.
Datto, Inc.

Model Number : A42, AP42

Applicable Standard : FCC 47 CFR PART 15 SUBPART E
ANSI C63.10:2013

Receive Date : Apr. 12, 2018

Test Period : Apr. 14 ~ Apr. 20, 2018

Issue Date : Apr. 30, 2018

Issue by

A Test Lab Techno Corp.
No. 140-1, Changan Street, Bade District,
Taoyuan City 33465, Taiwan (R.O.C)
Tel : +86-3-2710188 / Fax : +86-3-2710190



Taiwan Accreditation Foundation accreditation number: 1330
Test Firm MRA designation number: TW0010

Note: This report shall not be reproduced except in full, without the written approval of A Test Lab Techno Corp. This document may be altered or revised by A Test Lab Techno Corp. personnel only, and shall be noted in the revision section of the document. The client should not use it to claim product endorsement by TAF, or any government agencies. The test results in the report only apply to the tested sample.



Revision History

Rev.	Issue Date	Revisions	Revised By
00	Apr. 30, 2018	Initial Issue	Tobey Cheng

Verification of Compliance

Issued Date: Apr. 30, 2018

Applicant : Datto, Inc.
Product Type : WiFi Access Point
Trade Name : Open Mesh, Inc.
Datto, Inc.
Model Number : A42, AP42
FCC ID : WT8OMA42
EUT Rated Voltage : DC 48V-54V, 0.6A
DC 18-24V, 1.34-1A
Test Voltage : 120 Vac / 60 Hz
Applicable Standard : FCC 47 CFR PART 15 SUBPART E
ANSI C63.10:2013
Test Result : Complied

Performing Lab. : A Test Lab Techno Corp.
No. 140-1, Changan Street, Bade District,
Taoyuan City 33465, Taiwan (R.O.C)
Tel : +86-3-2710188 / Fax : +86-3-2710190
Taiwan Accreditation Foundation accreditation number: 1330
<http://www.atl-lab.com.tw/e-index.htm>



A Test Lab Techno Corp. tested the above equipment in accordance with the requirements set forth in the above standards. All indications of Pass/Fail in this report are opinions expressed by A Test Lab Techno Corp. based on interpretations and/or observations of test results. Measurement Uncertainties were not taken into account and are published for informational purposes only. The test results show that the equipment tested is capable of demonstrating compliance with the requirements as documented in this report.

Approved By : Fly Lu Reviewed By : Eric Ou Yang
(Manager) (Fly Lu) (Testing Engineer) (Eric Ou Yang)



TABLE OF CONTENTS

1	General Information.....	5
1.1.	Summary of Test Result.....	5
1.2.	Measurement Uncertainty.....	5
2	EUT Description.....	6
3	Test Methodology.....	8
3.1.	Mode of Operation.....	8
3.2.	EUT Exercise Software.....	17
3.3.	Configuration of Test System Details.....	17
3.4.	Test Instruments.....	19
3.5.	Test Site Environment.....	20
4	Measurement Procedure.....	21
4.1.	AC Power Conducted Emission Measurement.....	21
4.2.	Transmitter Radiated Emissions Measurement.....	23
4.3.	Maximum Conducted Output Power and Transmit power control Measurement.....	27
4.4.	26dB RF Bandwidth.....	28
4.5.	Maximum Power Spectral Density Measurement.....	29
4.6.	Frequency Stability Measurement.....	31
4.7.	Automatically discontinue transmission.....	32
4.8.	Antenna Requirement.....	32
5	Test Results.....	34
5.1.	AC Power Conducted Emission Measurement.....	34
5.2.	Transmitter Radiated Emissions Measurement.....	36
5.3.	Maximum Conducted Output Power and Transmit power control Measurement.....	190
5.4.	26dB RF Bandwidth.....	200
5.5.	Maximum Power Spectral Density Measurement.....	227
5.6.	Frequency Stability Measurement.....	258



1 General Information

1.1. Summary of Test Result

Standard	Item	Result	Remark
15.407(b)(6) 15.207	AC Power Conducted Emission	PASS	---
15.407(b) 15.205 / 15.209	Transmitter Radiated Emissions	PASS	---
15.407(a)	Maximum Conducted Output Power	PASS	---
15.407(a)	26dB RF Bandwidth	Reference	---
15.407(e)	6dB RF Bandwidth	PASS	---
15.407(a)	Maximum Power Spectral Density	PASS	---
15.407(g)	Frequency Stability	PASS	---
15.407(c)	Automatically discontinue transmission	PASS	---
15.407(a) 15.203	Antenna Requirement	PASS	---

The test results of this report relate only to the tested sample(s) identified in this report. Manufacturer or whom it may concern should recognize the pass or fail of the test result.

1.2. Measurement Uncertainty

Test Item	Frequency Range	Uncertainty (dB)
Conducted Emission	9kHz ~ 150KHz	2.7
	150kHz ~ 30MHz	2.7
Radiated Emission	9kHz ~ 30MHz	1.7
	30MHz ~ 1000MHz	5.7
	1000MHz ~ 18000MHz	5.5
	18000MHz ~ 26500MHz	4.8
	26500MHz ~ 40000MHz	4.8
Conducted Output Power		+0.27 dB / -0.28 dB
RF Bandwidth		4.96%
Power Spectral Density		+0.71 dB / -0.77 dB
Frequency Stability		+ 2.212 x 10 ⁻⁷ % / - 2.170 x 10 ⁻⁷
Duty Cycle		1.06%
Time Occupancy		1.40%



2 EUT Description

Applicant	Datto, Inc. 101 Merritt 7 Norwalk, CT 06851, United States				
Manufacturer	Datto, Inc. 101 Merritt 7 Norwalk, CT 06851, United States				
Product Type	WiFi Access Point				
Trade Name	Open Mesh, Inc. Datto, Inc.				
Model Number	A42, AP42				
Trade Name / Model Number Different Description	Those trade names & model numbers differ from each other in selling region. (A42 for Open Mesh apply, AP42 for Datto apply)				
FCC ID	WT8OMA42				
Operate Frequency	Frequency Band		Frequency Range (MHz)	Number of Channels	
	IEEE 802.11a	U-NII Band II-A	5260 – 5320	4	
		U-NII Band II-C	5500 – 5700	8	
	IEEE 802.11n 5GHz 20 MHz / IEEE 802.11ac 20 MHz	U-NII Band II-A	5260 – 5320	4	
		U-NII Band II-C	5500 – 5700	8	
	IEEE 802.11n 5GHz 40 MHz / IEEE 802.11ac 40 MHz	U-NII Band II-A	5270 – 5310	2	
		U-NII Band II-C	5510 – 5670	3	
	IEEE 802.11ac 80 MHz	U-NII Band II-A	5290	1	
U-NII Band II-C		5530	1		
Modulation Type	OFDM				
Antenna information	Antenna	Model	Type	Frequency Band	Max. Gain (dBi)
	ANT-0	6525A0046300	PIFA antenna	U-NII Band II-A	3.10
				U-NII Band II-C	4.70
	ANT-1	6525A0045300	PIFA antenna	U-NII Band II-A	4.50
U-NII Band II-C				4.70	
Antenna Delivery	Reference section 3.1				
Frequency Stability Specification	± 20 ppm				
Operate Temp. Range	0 ~ +40 °C				



Frequency Band		RF Output Power (W)
IEEE 802.11a	U-NII Band II-A	0.117
	U-NII Band II-C	0.087
IEEE 802.11ac 20 MHz	U-NII Band II-A	0.120
	U-NII Band II-C	0.085
IEEE 802.11ac 40 MHz	U-NII Band II-A	0.209
	U-NII Band II-C	0.136
IEEE 802.11ac 80 MHz	U-NII Band II-A	0.104
	U-NII Band II-C	0.095

Beamforming on

Frequency Band		RF Output Power (W)
IEEE 802.11ac 20 MHz	U-NII Band II-A	0.059
	U-NII Band II-C	0.040
IEEE 802.11ac 40 MHz	U-NII Band II-A	0.103
	U-NII Band II-C	0.067
IEEE 802.11ac 80 MHz	U-NII Band II-A	0.051
	U-NII Band II-C	0.044

Equipment Type		
Outdoor access point	point-to-point	---
	point-to-multipoint	V
Indoor access point		V
Fixed point-to-point access points		---
Client devices		---



3 Test Methodology

3.1. Mode of Operation

Decision of Test ATL has verified the construction and function in typical operation. All the test modes were carried out with the EUT in normal operation, which was shown in this test report and defined as:

Test Mode
Mode 1: Transmit mode
Mode 2: IEEE 802.11a Continuous TX mode
Mode 3: IEEE 802.11ac 20MHz Continuous TX mode
Mode 4: IEEE 802.11ac 40MHz Continuous TX mode
Mode 5: IEEE 802.11ac 80MHz Continuous TX mode

Software used to control the EUT for staying in continuous transmitting mode was programmed.

After verification, all tests were carried out with the worst case test modes as shown below except radiated spurious emission below 1GHz and power line conducted emissions below 30MHz, which worst case was in normal link mode only.

Test Mode	ANT-0	ANT-1	ANT-0+1
Mode 2	V	V	V
Mode 3	V	V	V
Mode 4	V	V	V
Mode 5	V	V	V

Test Mode	Antenna Delivery	Data Rate	Band	Test Channel
Mode 2	2TX (CDD)	6M	U-NII Band II-A	52, 56, 60, 64
			U-NII Band II-C	100, 104, 108, 112, 116, 132, 136, 140
Mode 3	2TX (CDD/MIMO/Beamforming on)	13M	U-NII Band II-A	52, 56, 60, 64
			U-NII Band II-C	100, 104, 108, 112, 116, 132, 136, 140
Mode 4	2TX (CDD/MIMO/Beamforming on)	27M	U-NII Band II-A	54, 62
			U-NII Band II-C	102, 110, 134
Mode 5	2TX (CDD/MIMO/Beamforming on)	58.6	U-NII Band II-A	58
			U-NII Band II-C	106



Duty cycle

Test Mode	Frequency (MHz)	on time (ms)	on+off time (ms)	Duty cycle	Duty Factor (dB)	1/T Minimum VBW (kHz)
Mode 2	5260.0	2.060	2.110	0.976	0.104	0.485
Mode 3	5260.0	5.010	5.055	0.991	0.039	0.010
Mode 4	5270.0	2.445	2.490	0.982	0.079	0.010
Mode 5	5290.0	1.170	1.215	0.963	0.164	0.855

Beamforming on

Test Mode	Frequency (MHz)	on time (ms)	on+off time (ms)	Duty cycle	Duty Factor (dB)	1/T Minimum VBW (kHz)
Mode 3	5260.0	5.010	5.055	0.991	0.039	0.010
Mode 4	5270.0	2.445	2.490	0.982	0.079	0.010
Mode 5	5290.0	1.170	1.215	0.963	0.164	0.855

Duty Cycle Graphs





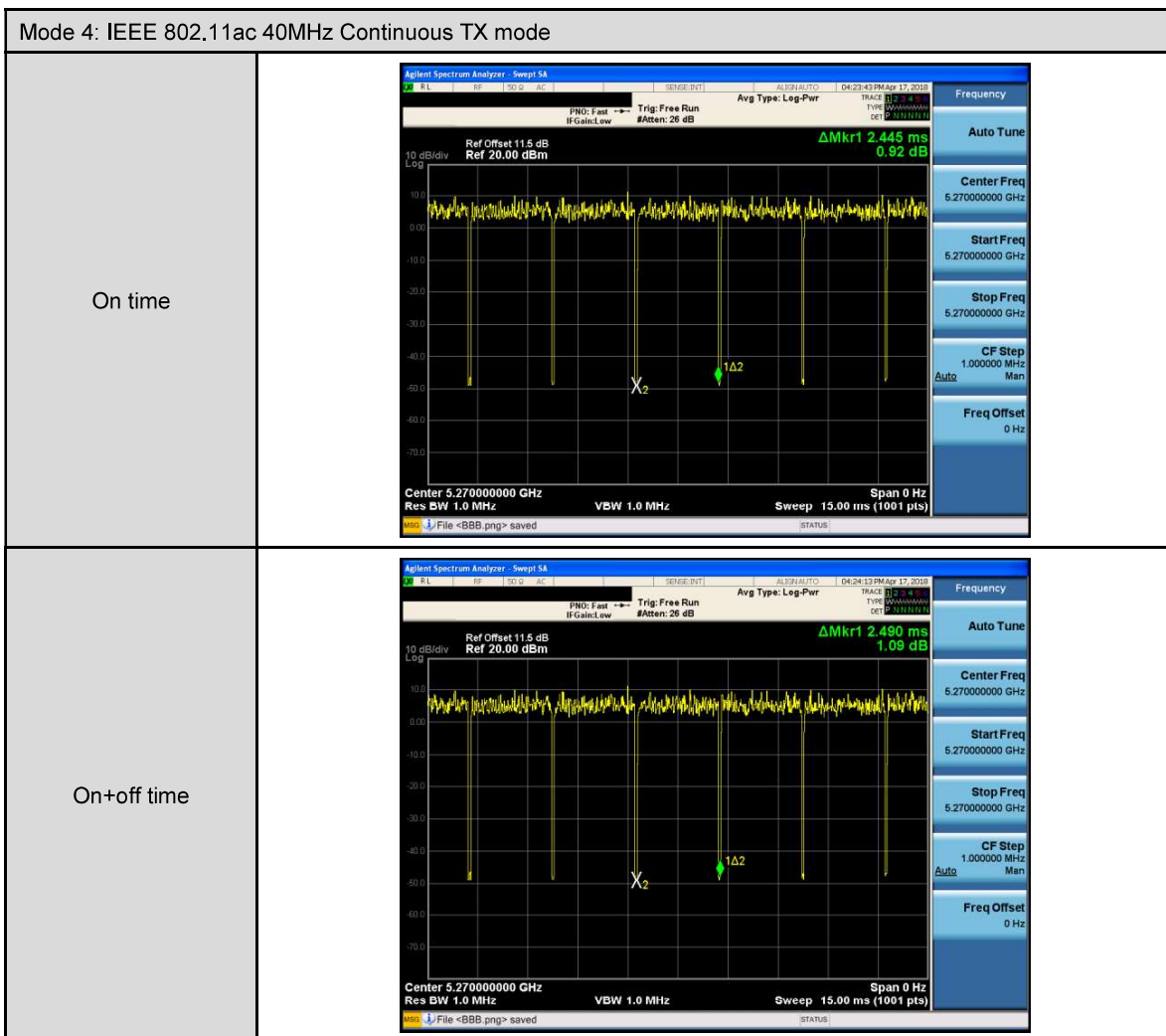





Beamforming on

Mode 3: IEEE 802.11ac 20MHz Continuous TX mode

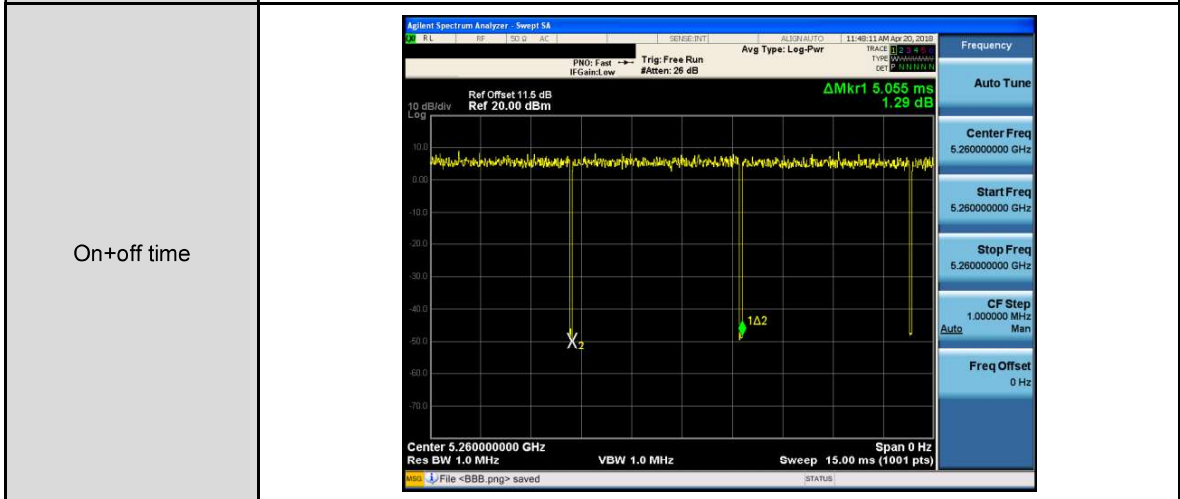
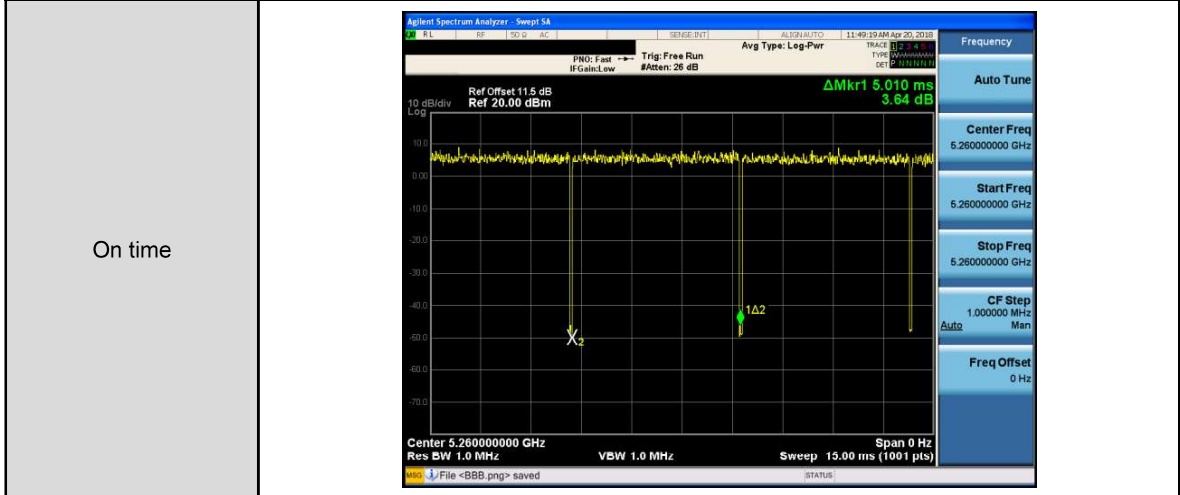

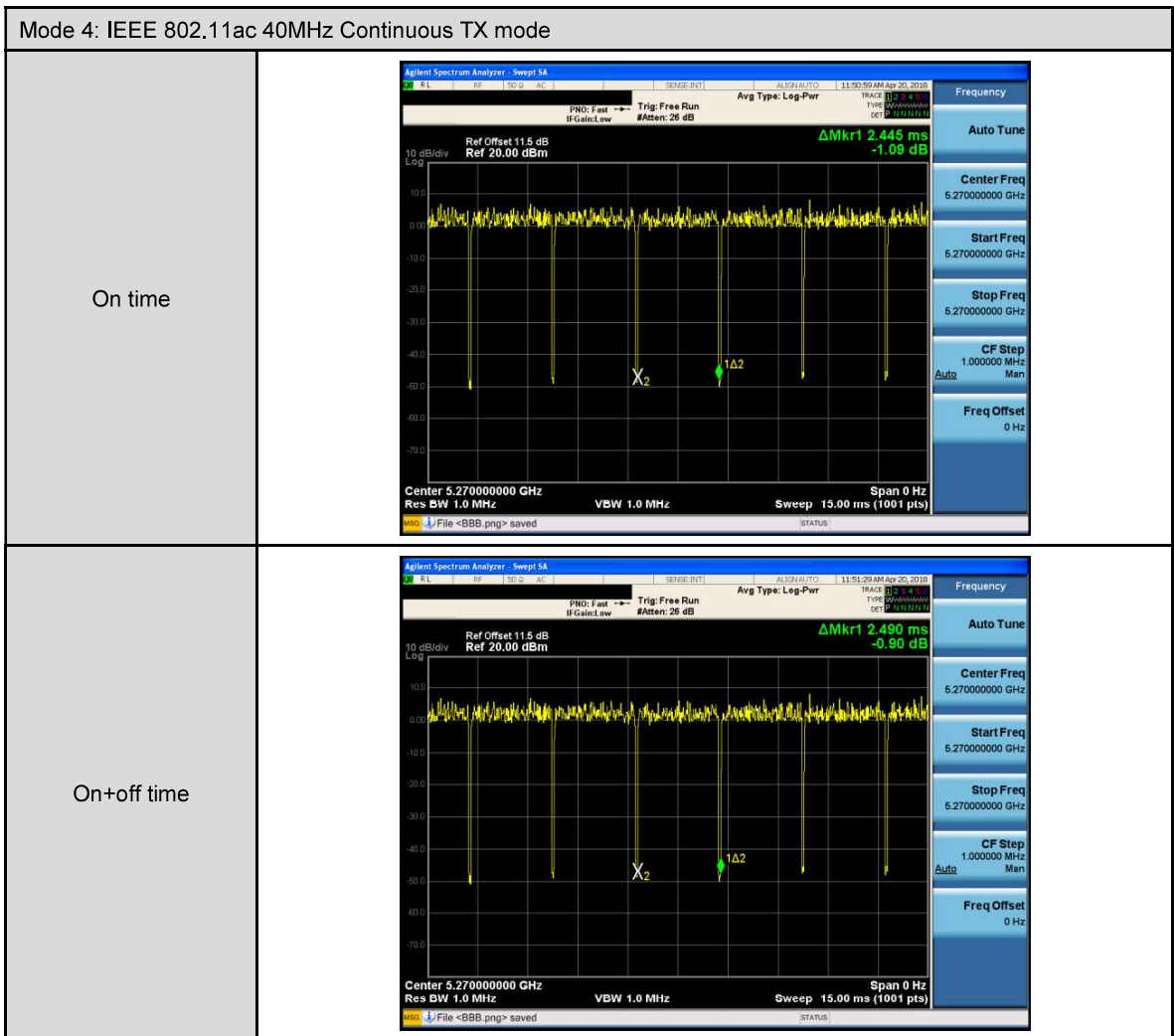



3.2. EUT Exercise Software

The EUT is operated in the engineering mode to fix the TX frequency for the purposes of measurement. According to its specifications, the EUT must comply with the requirements of Section 15.407 under the FCC Rules Part 15 Subpart E.

1.	Setup the EUT shown on "Configuration of Test System Details"
2.	Turn on the power of all equipment.
3.	Turn on TX function.
4.	EUT run test program.

Measurement Software	
1	EZ-EMC Ver. ATL-03A1-1
2	EZ-EMC Ver ATL-ITC-3A1-1

3.3. Configuration of Test System Details

Conducted Emission

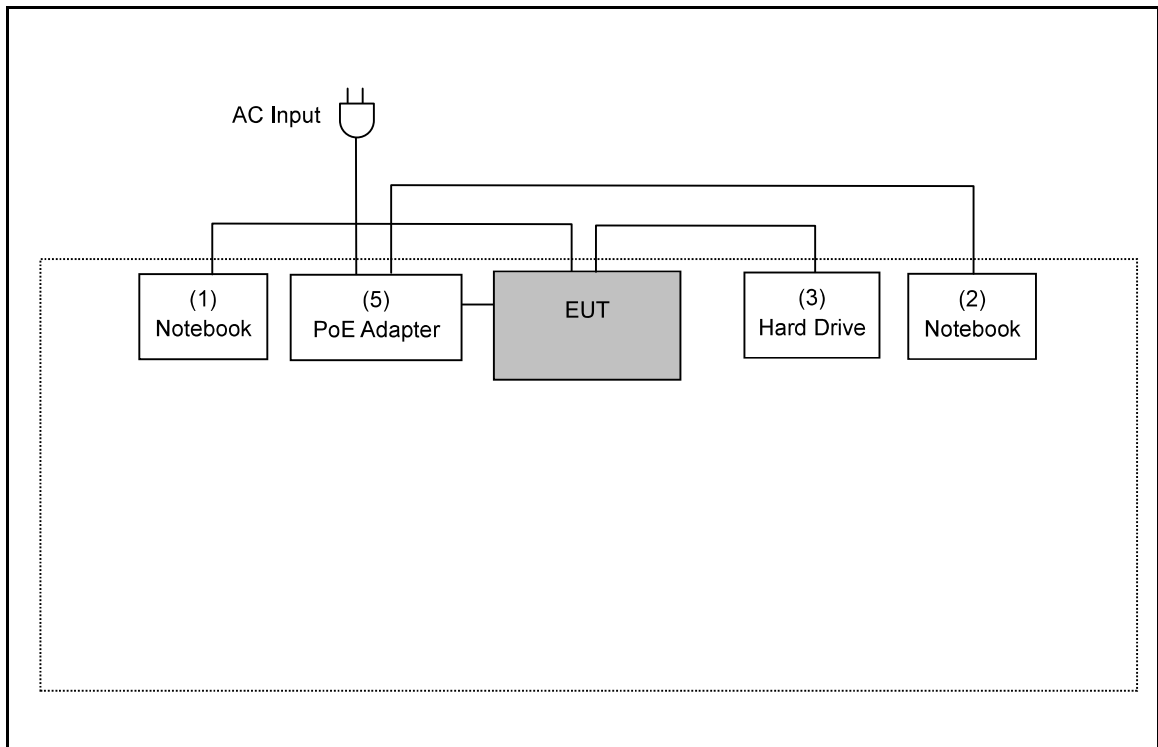

Radiated Emission

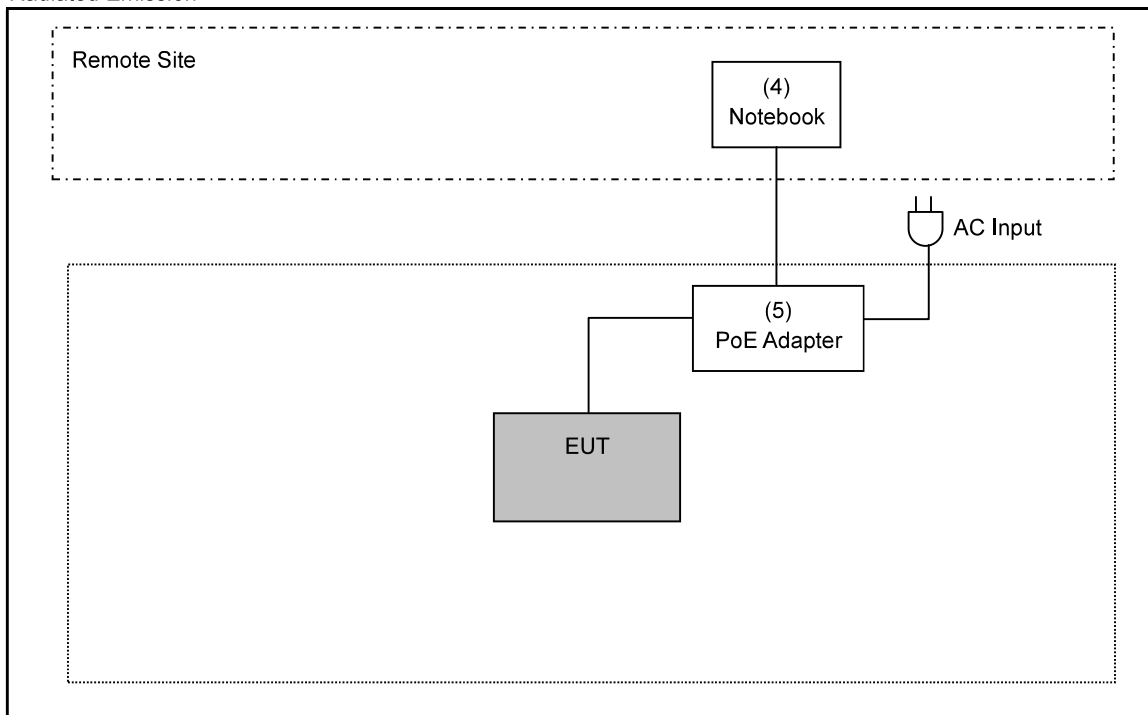

Devices Description					
	Product	Manufacturer	Model Number	Serial Number	Power Cord
(1)	Notebook	DELL	LATITUDE E6440	5HZBD72	Non-Shielded, 1.5m
(2)	Notebook	DELL	LATITUDE E6440	48GBD72	Non-Shielded, 0.8m
(3)	Hard Drive	WD	My Passport	WXN1E32LVECU	Non-Shielded, 1.0m
(4)	Notebook	DELL	LATITUDE E6440	5HZBD72	Non-Shielded, 0.8m
(5)	PoE Adapter	EnGenius	EPA5006GP	---	Non-Shielded, 0.5m



3.4. Test Instruments

For Conducted Emission
 Test Period: Apr. 20, 2018

Equipment	Manufacturer	Model Number	Serial Number	Cal. Date	Cal. Period
Test Receiver	R&S	ESCI	100367	05/18/2017	1 year
LISN	R&S	ENV216	101040	03/23/2018	1 year
LISN	R&S	ENV216	101041	04/11/2018	1 year

For Radiated Emissions
 Test Period: Apr. 14, 2018

Equipment	Manufacturer	Model Number	Serial Number	Cal. Date	Cal. Period
Spectrum Analyzer (10Hz~44GHz)	Keysight	N9010A	MY52221312	01/15/2018	1 year
Pre Amplifier (1~26.5GHz)	Agilent	8449B	3008A02237	10/16/2017	1 year
Pre Amplifier (100KHz~1.3GHz)	Agilent	8447D	2944A11119	01/10/2018	1 year
Pre Amplifier (26.5~40GHz)	EMCI	EMC2654045	980028	08/29/2017	1 year
Pre Amplifier (1~26.5GHz)	EMCI	EMC012645SE	980289	01/17/2018	1 year
Broadband Antenna	Schwarzbeck	VULB9168	416	10/26/2017	1 year
Horn Antenna (1~18GHz)	SCHWARZBECK MESS-ELEKTRONIK	BBHA9120D	9120D-550	06/20/2017	1 year
Horn Antenna (18~40GHz)	ETS	3116	86467	09/19/2017	1 year

For Conducted
 Test Period: Apr. 17 ~ Apr. 20, 2018

Equipment	Manufacturer	Model Number	Serial Number	Cal. Date	Cal. Period
Power Sensor	Anritsu	MA2411B	1126022	08/28/2017	1 year
Power Meter	Anritsu	ML2495A	1135009	08/28/2017	1 year
Spectrum Analyzer (20Hz~26.5GHz)	Agilent	N9020A	US47520902	09/21/2017	1 year

Note: N.C.R. = No Calibration Request.



3.5. Test Site Environment

Items	Required (IEC 60068-1)	Actual
Temperature (°C)	15-35	26
Humidity (%RH)	25-75	60
Barometric pressure (mbar)	860-1060	950

4 Measurement Procedure

4.1. AC Power Conducted Emission Measurement

■ Limit

Frequency (MHz)	Quasi-peak	Average
0.15 - 0.5	66 to 56	56 to 46
0.50 - 5.0	56	46
5.0 - 30.0	60	50

■ Test Setup

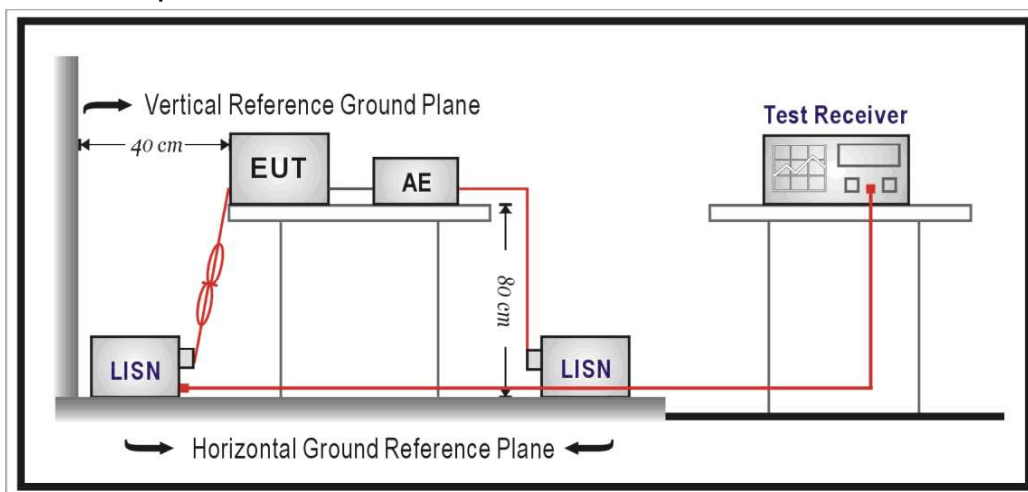

■ Test Procedure

The EUT and simulators are connected to the main power through a line impedance stabilization network (L.I.S.N.). This provides a $50\Omega // 50\mu\text{H}$ coupling impedance for the measuring equipment. The peripheral devices are also connected to the main power through a LISN that provides a $50\Omega // 50\mu\text{H}$ coupling impedance with 50ohm termination.

Tabletop device shall be placed on a non-conducting platform, of nominal size 1 m by 1.5 m, raised 80 cm above the reference ground plane. The wall of screened room shall be located 40cm to the rear of the EUT. Other surfaces of tabletop or floor standing EUT shall be at least 80cm from any other ground conducting surface including one or more LISNs. For floor-standing device shall be placed under the EUT with a 12mm insulating material.

Conducted emissions were investigated over the frequency range from 0.15 MHz to 30 MHz using a resolution bandwidth of 9 kHz. The equipment under test (EUT) shall be meet the limits in section 4.1, as applicable, including the average limit and the quasi-peak limit when using respectively, an average detector and quasi-peak detector measured in accordance with the methods described of related standard. When all of peak value were complied with quasi-peak and average limit from 150kHz to 30MHz then quasi-peak and average measurement was unnecessary.

The AMN shall be placed 0,8 m from the boundary of the unit under test and bonded to a ground reference plane for AMNs mounted on top of the ground reference plane. This distance is between the closest points of the AMN and the EUT. All other units of the EUT and associated equipment shall be at least 0,8 m from the AMN. If the mains power cable is longer than 1m then the cable shall be folded back and forth at the centre of the lead to form a bundle no longer than 0.4m. All of interconnecting cables that hang closer than 40cm to the ground plane shall be folded back and forth in the center forming a bundle 30 cm to 40 cm long. All of EUT and AE shall be separate place more than 0.1m. All 50Ω ports of the LISN shall be resistively terminated into 50Ω loads when not connected to the measuring instrument.

If the reading of the measuring receiver shows fluctuations close to the limit, the reading shall be observed for at least 15 s at each measurement frequency; the higher reading shall be recorded with the exception of any brief isolated high reading which shall be ignored.



4.2. Transmitter Radiated Emissions Measurement

■ Limit

(1)Undesirable emission limits. Except as shown in paragraph (b)(7) of this section, the maximum emissions outside of the frequency bands of operation shall be attenuated in accordance with the following limits:

(a)For transmitters operating in the 5.15-5.25 GHz band: All emissions outside of the 5.15-5.35 GHz band shall not exceed an e.i.r.p. of -27 dBm/MHz.

(b)For transmitters operating in the 5.25-5.35 GHz band: All emissions outside of the 5.15-5.35 GHz band shall not exceed an e.i.r.p. of -27 dBm/MHz.

(c)For transmitters operating in the 5.47-5.725 GHz band: All emissions outside of the 5.47-5.725 GHz band shall not exceed an e.i.r.p. of -27 dBm/MHz.

(d)For transmitters operating in the 5.725-5.85 GHz band:

(i)All emissions shall be limited to a level of -27 dBm/MHz at 75 MHz or more above or below the band edge increasing linearly to 10 dBm/MHz at 25 MHz above or below the band edge, and from 25 MHz above or below the band edge increasing linearly to a level of 15.6 dBm/MHz at 5 MHz above or below the band edge, and from 5 MHz above or below the band edge increasing linearly to a level of 27 dBm/MHz at the band edge.

(2)Limits of Radiated Emission Measurement

Emissions radiated outside of the specified bands, shall be according to the general radiated limits in 15.209 as following:

Frequency Range (MHz)	Field Strength (microvolts/meter)	Measurement Distance (meters)
0.009 ~ 0.490	2400/F(kHz)	300
0.490 ~ 1.705	24000/F(kHz)	30
1.705 ~ 30.0	30	30
30 ~ 88	10	3
88 ~ 216	150	3
216 ~ 960	200	3
Above 960	500	3

- Note:
1. The lower limit shall apply at the transition frequencies.
 2. Emission level (dBuV/m) = 20 log Emission level (uV/m).
 3. As shown in 15.35(b), for frequencies above 1000MHz, the field strength limits are based on average detector, however, the peak field strength of any emission shall not exceed the maximum permitted average limits, specified above by more than 20dB under any condition of modulation.

■ Setup

9kHz ~ 30MHz

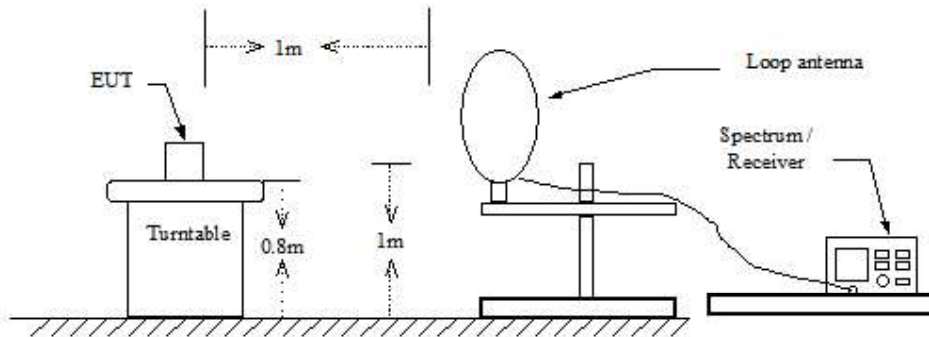

30MHz ~ 1GHz

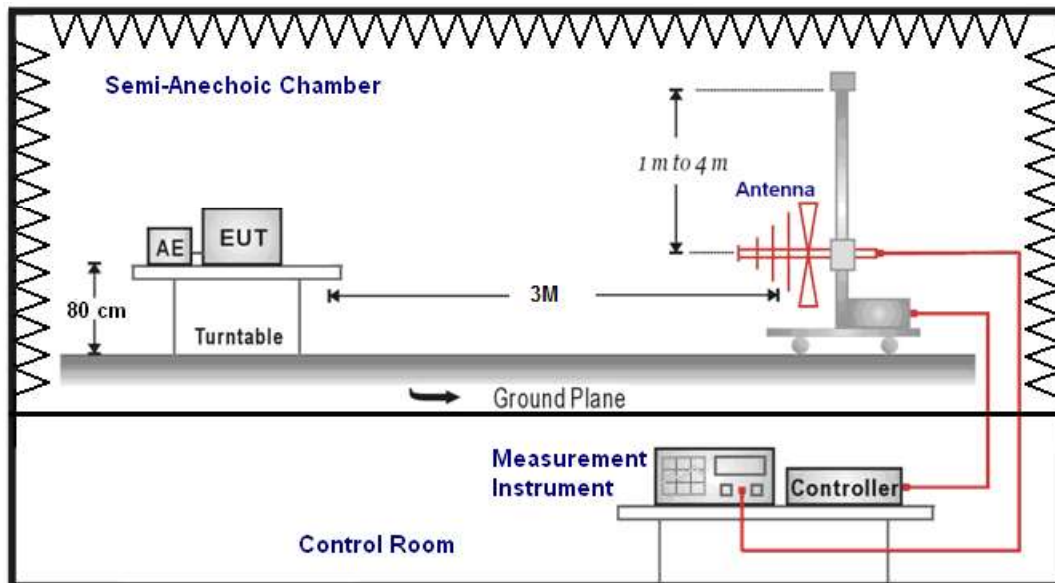

Above 1GHz

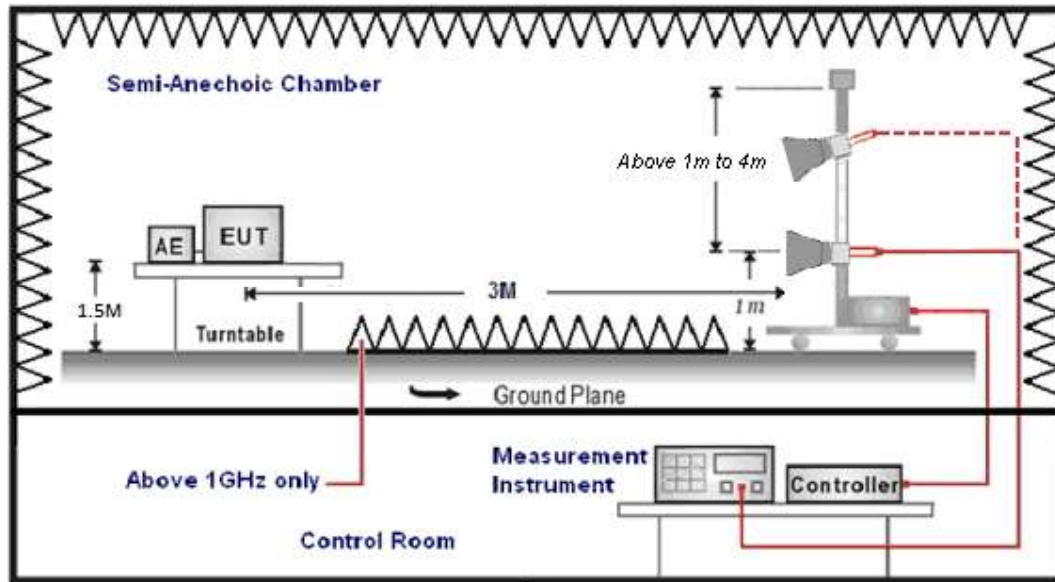

■ Test Procedure

Final radiation measurements were made on a three-meter, Semi Anechoic Chamber. The EUT system was placed on a nonconductive turntable which is 0.8 or 1.5 meters height (below 1GHz use 0.8m turntable / above 1GHz use 1.5m turntable), top surface 1.0 x 1.5 meter. The spectrum was examined from 250 MHz to 2.5 GHz in order to cover the whole spectrum below 10th harmonic which could generate from the EUT. During the test, EUT was set to transmit continuously & Measurements spectrum range from 9 kHz to 40 GHz is investigated.

For measurements below 1 GHz the resolution bandwidth is set to 100 kHz for peak detection measurements or 120 kHz for quasi-peak detection measurements. Peak detection is used unless otherwise noted as quasi-peak.

For restricted measurements above 1 GHz the resolution bandwidth is set to 1 MHz, and then the video bandwidth is set to 3 MHz for peak measurements and 10 Hz for average measurements when Duty cycle > 0.98 / 1/T for average measurements when Duty cycle < 0.98.

For out of band measurements above 1 GHz the resolution bandwidth is set to 1 MHz, and then the video bandwidth is set to 3 MHz for peak measurements.

A nonconductive material surrounded the EUT to supporting the EUT for standing on three orthogonal planes. At each condition, the EUT was rotated 360 degrees, and the antenna was raised and lowered from one to four meters to find the maximum emission levels. Measurements were taken using both horizontal and vertical antenna polarization.

SCHWARZBECK MESS-ELEKTRONIK Trilog-Broadband Antenna at 3 Meter and the ETS-Lindgren Double-Ridged Waveguide Horn antenna Schwarzbeck Mess-Elektronik Broadband Horn Antenna was used in frequencies 1 – 40 GHz at a distance of 3 meter. The antenna at an angle toward the source of the emission. All test results were extrapolated to equivalent signal at 3 meters utilizing an inverse linear distance extrapolation Factor (20dB/decade).



For testing above 1GHz, the emission level of the EUT in peak mode was 20dB lower than average limit (that means the emission level in peak mode also complies with the limit in average mode), then testing will be stopped and peak values of EUT will be reported, otherwise, the emissions will be measured in average mode again and reported.

Appropriate preamplifiers were used for improving sensitivity and precautions were taken to avoid overloading or desensitizing the spectrum analyzer. No post – detector video filters were used in the test.

The spectrum analyzer's 6 dB bandwidth was set to 1 MHz, and the analyzer was operated in the peak detection mode, for frequencies both below and up 1 GHz. The average levels were obtained by subtracting the duty cycle correction factor from the peak readings.

The following procedures were used to convert the emission levels measured in decibels referenced to 1 microvolt (dBuV) into field intensity in micro volts pre meter (uV/m).

The actual field intensity in decibels referenced to 1 microvolt in to field intensity in micro volts per meter (dBuV/m).

The actual field intensity in referenced to 1 microvolt per meter (dBuV/m) is determined by algebraically adding the measured reading in dBuV, the antenna factor (dB), and cable loss (dB) and Subtracting the gain of preamplifier (dB) is auto calculate in spectrum analyzer.

$$(1) \text{ Amplitude (dBuV/m) = FI (dBuV) + AF (dBuV) + CL (dBuV) - Gain (dB)}$$

FI= Reading of the field intensity.

AF= Antenna factor.

CL= Cable loss.

P.S Amplitude is auto calculate in spectrum analyzer.

$$(2) \text{ Actual Amplitude (dBuV/m) = Amplitude (dBuV) - Dis(dB)}$$

The FCC specified emission limits were calculated according the EUT operating frequency and by following linear interpolation equations:

(a) For fundamental frequency : Transmitter Output < +30dBm

(b) For spurious frequency : Spurious emission limits = fundamental emission limit /10

Measuring Instruments and setting

The following table is the setting of spectrum analyzer and receiver.

Spectrum Parameter	Setting
Attenuation	Auto
Start Frequency	1000MHz
Stop Frequency	40GHz
RBW/VBW(Emission in restricted band)	1MHz / 3MHz for Peak 1MHz / (1/T) for Average
RBW/VBW(Emission in non-restricted band)	1MHz / 3MHz for Peak

4.3. Maximum Conducted Output Power and Transmit power control Measurement

■ **Limit**

Conducted Output Power

Frequency Range (MHz)	FCC Limit
5.250 ~ 5.350 GHz	The lesser of 250mW (24dBm) or 11dBm + 10log (B)
5.470 ~ 5.725 GHz	The lesser of 250mW (24dBm) or 11dBm + 10log (B)

According FCC KDB 662911 D01 v02r01 – for power measurements on IEEE802.11 devices,

- * MIMO / Beamforming on mode : Directional Gain = $10 \cdot \log\{[10^{(G1/20)} + 10^{(G2/20)} + \dots + 10^{(Gn/20)}]^2 / NANT\}$
= 6.84 dBi > 6dBi (5.250 ~ 5.350 GHz)
- * MIMO / Beamforming on mode : Directional Gain = $10 \cdot \log\{[10^{(G1/20)} + 10^{(G2/20)} + \dots + 10^{(Gn/20)}]^2 / NANT\}$
= 7.71 dBi > 6dBi (5.470 ~ 5.725 GHz)

IEEE 802.11ac 20 MHz / IEEE 802.11ac 40 MHz / IEEE 802.11ac 80 MHz

MIMO / Beamforming on mode power limit shall be reduced = 23.43 – 0.84 = 22.59 dBm (5.250 ~ 5.350 GHz)

MIMO / Beamforming on mode power limit shall be reduced = 23.46 – 1.71 = 21.75 dBm (5.470 ~ 5.725 GHz)

■ **Test Setup**

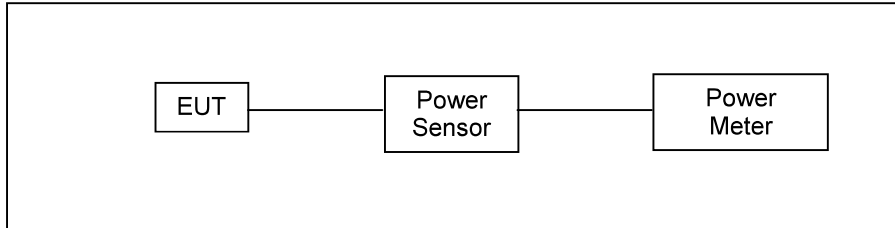

■ **Test Procedure**

The test is performed in accordance with KDB789033: D02 General UNII Test Procedures New Rules v02r01, Guidelines for Compliance Testing of Unlicensed National Information Infrastructure (U-NII) Devices

Section (E) Maximum Conducted Output Power

3. Measurement using a Power Meter (PM)

b) Method PM-G (Measurement using a gated RF average power meter)

4.4. 26dB RF Bandwidth

■ **Limit**

N/A

■ **Test Setup**

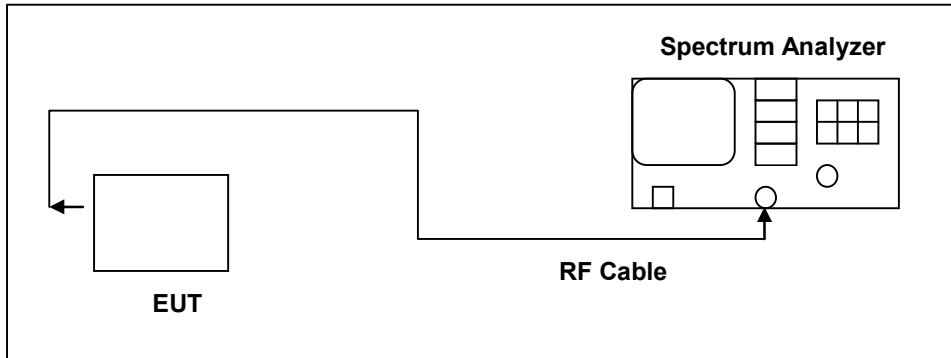

■ **Test Procedure**

The test is performed in accordance with KDB789033: D02 General UNII Test Procedures New Rules v02r01, Guidelines for Compliance Testing of Unlicensed National Information Infrastructure (U-NII) Devices - Part 15, Subpart E.

Spectrum Parameter	Setting
Attenuation	Auto
Span Frequency	>26dB Bandwidth
RBW	Approximately 1% of the emission bandwidth
VBW	VBW > RBW
Detector	Peak
Trace	Max Hold
Sweep Time	Auto

4.5. Maximum Power Spectral Density Measurement

■ **Limit**

Conducted power spectral density

Frequency Range	FCC Limit
5.250 ~ 5.350 GHz	11 dBm/MHz
5.470 ~ 5.725 GHz	11 dBm/MHz

According FCC KDB 662911 D01 v02r01 – for power measurements on IEEE802.11 devices,

- * CDD / MIMO / Beamforming on mode : Directional Gain
 $= 10 \cdot \log\{[10^{(G1/20)} + 10^{(G2/20)} + \dots + 10^{(Gn/20)}]^2 / NANT\} = 6.84 \text{ dBi} > 6\text{dBi} \text{ (5.250 ~ 5.350 GHz)}$
- * CDD / MIMO / Beamforming on mode : Directional Gain
 $= 10 \cdot \log\{[10^{(G1/20)} + 10^{(G2/20)} + \dots + 10^{(Gn/20)}]^2 / NANT\} = 7.71 \text{ dBi} > 6\text{dBi} \text{ (5.470 ~ 5.725 GHz)}$

IEEE 802.11a / IEEE 802.11ac 20 MHz / IEEE 802.11ac 40 MHz / IEEE 802.11ac 80 MHz

CDD mode power limit shall be reduced = $11 - 0.84 = 10.16 \text{ dBm/MHz}$ (5.250 ~ 5.350 GHz)

CDD mode power limit shall be reduced = $11 - 1.71 = 9.29 \text{ dBm/MHz}$ (5.470 ~ 5.725 GHz)

IEEE 802.11ac 20 MHz / IEEE 802.11ac 40 MHz / IEEE 802.11ac 80 MHz

MIMO / Beamforming on mode power limit shall be reduced = $11 - 0.84 = 10.16 \text{ dBm/MHz}$ (5.250 ~ 5.350 GHz)

MIMO / Beamforming on mode power limit shall be reduced = $11 - 1.71 = 9.29 \text{ dBm/MHz}$ (5.470 ~ 5.725 GHz)

■ **Test Setup**

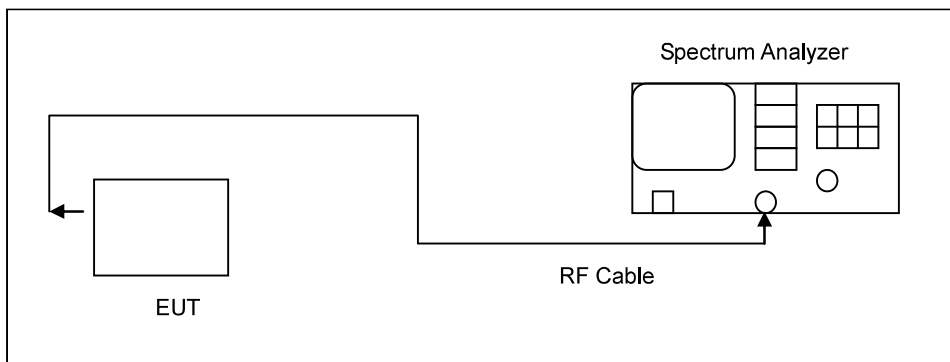



■ **Test Procedure**

The test is performed in accordance with KDB789033: D02 General UNII Test Procedures New Rules v02r01, Guidelines for Compliance Testing of Unlicensed National Information Infrastructure (U-NII) Devices - Part 15, Subpart E.

Spectrum Parameter	Setting
Attenuation	Auto
Span Frequency	Encompass the entire emissions bandwidth (EBW) of the signal
RBW	1 MHz (5725 ~ 5850MHz use 100 kHz)
VBW	3 MHz (5725 ~ 5850MHz use 300 kHz)
Detector	RMS
Trace	AVERAGE
Sweep Time	Auto
Trace Average	100 times
Note: If measurement bandwidth of Maximum PSD is specified in 500 kHz, add $10\log(500\text{kHz}/100\text{kHz})$ to the measured result.	

4.6. Frequency Stability Measurement

■ Limit

Manufacturers of U-NII devices are responsible for ensuring frequency stability such that an emission is maintained within the band of operation under all conditions of normal operation as specified in the users manual.

■ Test Setup

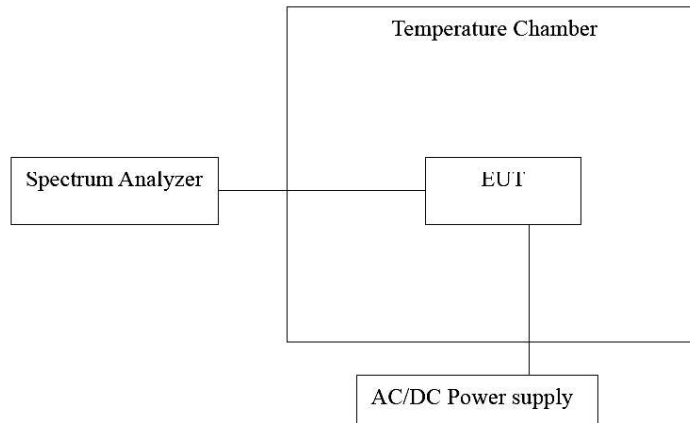

■ Test Procedure

1. The EUT was placed inside the environmental test chamber and powered by nominal AC/DC voltage.
2. Turn the EUT on and couple its output to a spectrum analyzer.
3. Turn the EUT off and set the chamber to the highest temperature specified.
4. Allow sufficient time (approximately 30 min) for the temperature of the chamber to stabilize.
5. Repeat step 2 and 3 with the temperature chamber set to the lowest temperature.
6. The test chamber was allowed to stabilize at +20 degree C for a minimum of 30 minutes. The supply voltage was then adjusted on the EUT from 85% to 115% and the frequency record.



4.7. Automatically discontinue transmission

The device shall automatically discontinue transmission in case of either absence of information to transmit or operational failure. These provisions are not intended to preclude the transmission of control or signalling information or the use of repetitive codes used by certain digital technologies to complete frame or burst intervals. Applicants shall include in their application for equipment authorization a description of how this requirement is met.

- **Declare**

While the EUT is not transmitting any information, the EUT can automatically discontinue transmission and become standby mode for power saving.

4.8. Antenna Requirement

- **Requirement**

For intentional device, according to 15.203, an intentional radiator shall be designed to ensure that no antenna other than that furnished by the responsible party shall be used with the device.

And According to 15.407 (a), if transmitting antennas of directional gain greater than 6 dBi are used, the power shall be reduced by the amount in dB that the directional gain of the antenna exceeds 6dBi.

- **Antenna Connector Construction**

See section 2 – antenna information.



■ **Directional Gain Calculated**

For Maximum Conducted Output Power

$$\text{Directional Gain} = 10 \cdot \log\{[10^{(G1/20)} + 10^{(G2/20)} + \dots + 10^{(Gn/20)}]^2 / NANT\}$$

MIMO / Beamforming on mode		
Operate Freq. Band		Directional Gain (dBi)
IEEE 802.11ac 20MHz	U-NII Band II-A	6.84
	U-NII Band II-C	7.71
IEEE 802.11ac 40MHz	U-NII Band II-A	6.84
	U-NII Band II-C	7.71
IEEE 802.11ac 80MHz	U-NII Band II-A	6.84
	U-NII Band II-C	7.71

For Maximum Power Spectral Density

$$10 \cdot \log\{[10^{(G1/20)} + 10^{(G2/20)} + \dots + 10^{(Gn/20)}]^2 / NANT\}$$

CDD mode		
Operate Freq. Band		Directional Gain (dBi)
IEEE 802.11a	U-NII Band II-A	6.84
	U-NII Band II-C	7.71
IEEE 802.11ac 20MHz	U-NII Band II-A	6.84
	U-NII Band II-C	7.71
IEEE 802.11ac 40MHz	U-NII Band II-A	6.84
	U-NII Band II-C	7.71
IEEE 802.11ac 80MHz	U-NII Band II-A	6.84
	U-NII Band II-C	7.71
MIMO / Beamforming on mode		
Operate Freq. Band		Directional Gain (dBi)
IEEE 802.11ac 20MHz	U-NII Band II-A	6.84
	U-NII Band II-C	7.71
IEEE 802.11ac 40MHz	U-NII Band II-A	6.84
	U-NII Band II-C	7.71
IEEE 802.11ac 80MHz	U-NII Band II-A	6.84
	U-NII Band II-C	7.71



5 Test Results

5.1. AC Power Conducted Emission Measurement

Standard:	FCC Part 15.407	Line:	L1
Test item:	Conducted Emission	Power:	AC 120V/60Hz
Test Mode:	Mode 1	Temp.(°C)/Hum.(%RH):	26(°C)/60%RH
Description:			

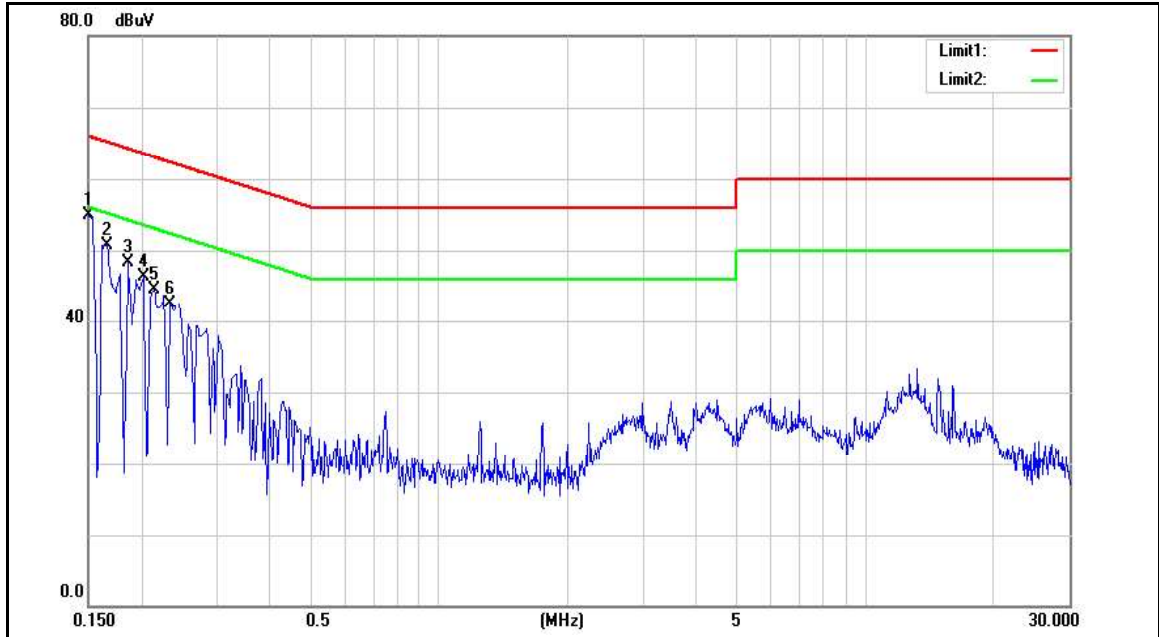

No.	Frequency (MHz)	QP reading (dBuV)	AVG reading (dBuV)	Correction factor (dB)	QP result (dBuV)	AVG result (dBuV)	QP limit (dBuV)	AVG limit (dBuV)	QP margin (dB)	AVG margin (dB)	Remark
1	0.1500	42.43	23.48	9.53	51.96	33.01	66.00	56.00	-14.04	-22.99	Pass
2	0.1660	38.82	20.11	9.54	48.36	29.65	65.16	55.16	-16.80	-25.51	Pass
3	0.1860	36.14	17.71	9.53	45.67	27.24	64.21	54.21	-18.54	-26.97	Pass
4	0.2020	34.57	16.72	9.53	44.10	26.25	63.53	53.53	-19.43	-27.28	Pass
5	0.2140	33.41	17.24	9.53	42.94	26.77	63.05	53.05	-20.11	-26.28	Pass
6	0.2340	31.26	14.49	9.53	40.79	24.02	62.31	52.31	-21.52	-28.29	Pass

Note: 1. Result = Correction factor + Reading

2. Correction factor = Antenna Factor + Cable loss – Pre-Amplifier gain.



Standard:	FCC Part 15.407	Line:	N
Test item:	Conducted Emission	Power:	AC 120V/60Hz
Test Mode:	Mode 1	Temp.(°C)/Hum.(%RH):	26(°C)/60%RH
Description:			



No.	Frequency (MHz)	QP reading (dBuV)	AVG reading (dBuV)	Correction factor (dB)	QP result (dBuV)	AVG result (dBuV)	QP limit (dBuV)	AVG limit (dBuV)	QP margin (dB)	AVG margin (dB)	Remark
1	0.1580	41.42	24.95	9.63	51.05	34.58	65.57	55.57	-14.52	-20.99	Pass
2	0.1700	38.24	20.56	9.63	47.87	30.19	64.96	54.96	-17.09	-24.77	Pass
3	0.1820	36.76	19.75	9.63	46.39	29.38	64.39	54.39	-18.00	-25.01	Pass
4	0.1940	35.44	18.92	9.63	45.07	28.55	63.86	53.86	-18.79	-25.31	Pass
5	0.2060	33.91	16.49	9.63	43.54	26.12	63.37	53.37	-19.83	-27.25	Pass
6	0.2180	33.42	17.95	9.63	43.05	27.58	62.89	52.89	-19.84	-25.31	Pass

Note: 1. Result = Correction factor + Reading
 2. Correction factor = Antenna Factor + Cable loss – Pre-Amplifier gain.



5.2. Transmitter Radiated Emissions Measurement

Below 1GHz

Standard:	FCC Part 15.407	Test Distance:	3m				
Test item:	Harmonic	Power:	AC 120V/60Hz				
Test Mode:	Mode 1	Temp.(°C)/Hum.(%RH):	26(°C)/60%RH				
Internal Antenna							
Frequency (MHz)	Reading (dBuV)	Correct Factor (dB/m)	Result (dBuV/m)	Limit (dBuV/m)	Margin (dB)	Remark	Ant.Polar. H / V
143.4900	42.77	-5.99	36.78	43.50	-6.72	QP	H
259.8900	34.66	-5.27	29.39	46.00	-16.61	QP	H
390.8400	36.03	-1.99	34.04	46.00	-11.96	QP	H
515.9700	35.57	0.44	36.01	46.00	-9.99	QP	H
710.9400	29.84	4.53	34.37	46.00	-11.63	QP	H
876.8100	29.11	7.62	36.73	46.00	-9.27	QP	H
120.2100	45.82	-8.29	37.53	43.50	-5.97	QP	V
143.4900	37.47	-5.99	31.48	43.50	-12.02	QP	V
401.5100	32.88	-1.74	31.14	46.00	-14.86	QP	V
519.8500	35.82	0.51	36.33	46.00	-9.67	QP	V
729.3700	29.19	5.01	34.20	46.00	-11.80	QP	V
790.4800	29.17	6.11	35.28	46.00	-10.72	QP	V

Note:1.Result (dBuV/m) = Correct Factor (dB/m) + Reading(dBuV).

2.Correction factor (dB/m) = Antenna Factor (dB/m) + Cable loss (dB) – Pre-Amplifier gain (dB).

3. When the peak results are less than average limit, so not need to evaluate the average.



Above 1GHz

Standard:	FCC Part 15.407	Test Distance:	3m
Test item:	Harmonic	Power:	AC 120V/60Hz
Frequency:	5260MHz	Temp.(°C)/Hum.(%RH):	26(°C)/60%RH
Mode:	Mode 2		
Ant.Polar.:	Horizontal		

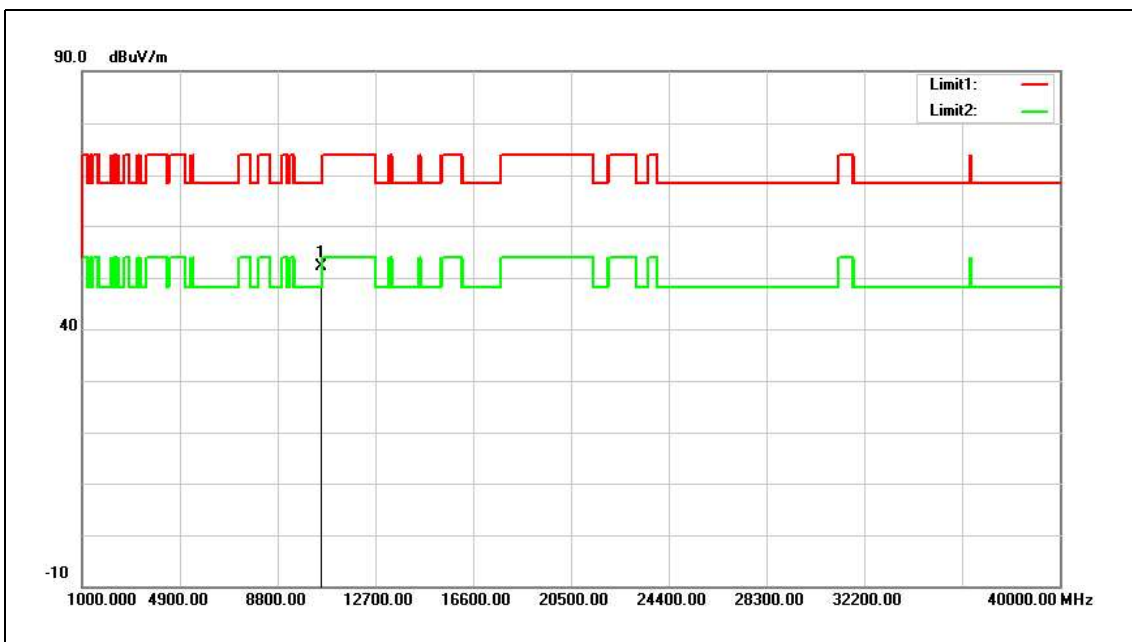

No.	Frequency (MHz)	Reading (dBuV)	Correct Factor (dB/m)	Result (dBuV/m)	Limit (dBuV/m)	Margin (dB)	Remark
1	10520.000	34.54	17.51	52.05	68.20	-16.15	peak

Note:1.Result (dBuV/m) = Correct Factor (dB/m) + Reading(dBuV).

2.Correction factor (dB/m) = Antenna Factor (dB/m) + Cable loss (dB) – Pre-Amplifier gain (dB).

3. When the peak results are less than average limit, so not need to evaluate the average.



Standard:	FCC Part 15.407	Test Distance:	3m
Test item:	Harmonic	Power:	AC 120V/60Hz
Frequency:	5260MHz	Temp.(°C)/Hum.(%RH):	26(°C)/60%RH
Mode:	Mode 2		
Ant.Polar.:	Vertical		

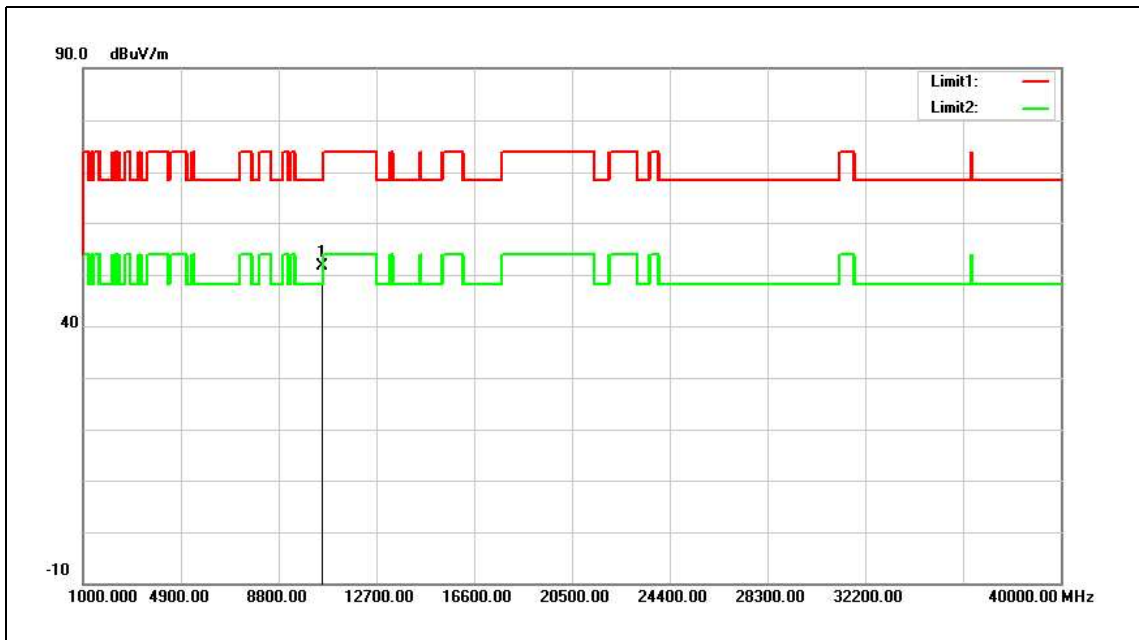

No.	Frequency (MHz)	Reading (dBuV)	Correct Factor (dB/m)	Result (dBuV/m)	Limit (dBuV/m)	Margin (dB)	Remark
1	10520.000	34.12	17.51	51.63	68.20	-16.57	peak

Note:1.Result (dBuV/m) = Correct Factor (dB/m) + Reading(dBuV).

2.Correction factor (dB/m) = Antenna Factor (dB/m) + Cable loss (dB) – Pre-Amplifier gain (dB).

3. When the peak results are less than average limit, so not need to evaluate the average.



Standard:	FCC Part 15.407	Test Distance:	3m
Test item:	Harmonic	Power:	AC 120V/60Hz
Frequency:	5280MHz	Temp.(°C)/Hum.(%RH):	26(°C)/60%RH
Mode:	Mode 2		
Ant.Polar.:	Horizontal		

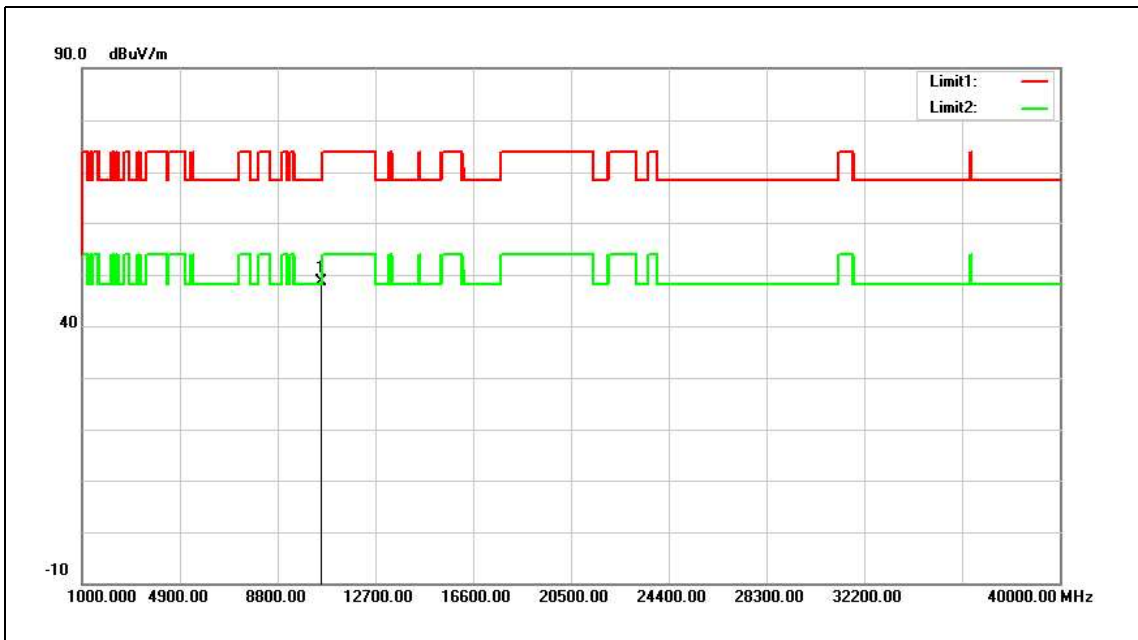

No.	Frequency (MHz)	Reading (dBuV)	Correct Factor (dB/m)	Result (dBuV/m)	Limit (dBuV/m)	Margin (dB)	Remark
1	10560.000	31.14	17.60	48.74	68.20	-19.46	peak

Note:1.Result (dBuV/m) = Correct Factor (dB/m) + Reading(dBuV).

2.Correction factor (dB/m) = Antenna Factor (dB/m) + Cable loss (dB) – Pre-Amplifier gain (dB).

3. When the peak results are less than average limit, so not need to evaluate the average.



Standard:	FCC Part 15.407	Test Distance:	3m
Test item:	Harmonic	Power:	AC 120V/60Hz
Frequency:	5280MHz	Temp.(°C)/Hum.(%RH):	26(°C)/60%RH
Mode:	Mode 2		
Ant.Polar.:	Vertical		

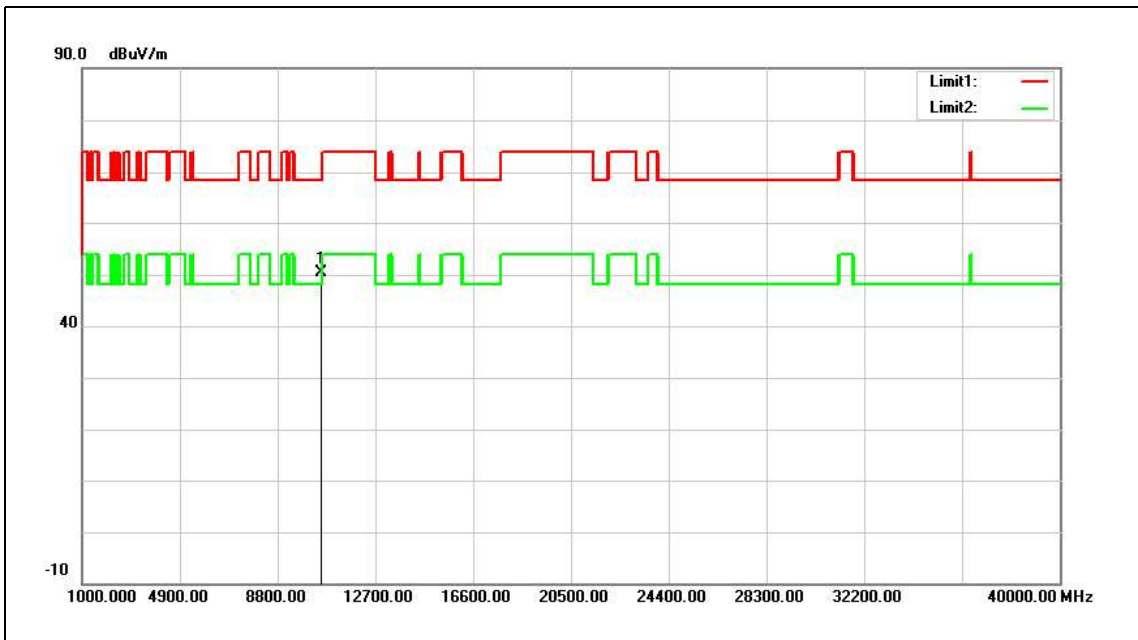

No.	Frequency (MHz)	Reading (dBuV)	Correct Factor (dB/m)	Result (dBuV/m)	Limit (dBuV/m)	Margin (dB)	Remark
1	10560.000	32.71	17.60	50.31	68.20	-17.89	peak

Note:1.Result (dBuV/m) = Correct Factor (dB/m) + Reading(dBuV).

2.Correction factor (dB/m) = Antenna Factor (dB/m) + Cable loss (dB) – Pre-Amplifier gain (dB).

3. When the peak results are less than average limit, so not need to evaluate the average.



Standard:	FCC Part 15.407	Test Distance:	3m
Test item:	Harmonic	Power:	AC 120V/60Hz
Frequency:	5320MHz	Temp.(°C)/Hum.(%RH):	26(°C)/60%RH
Mode:	Mode 2		
Ant.Polar.:	Horizontal		

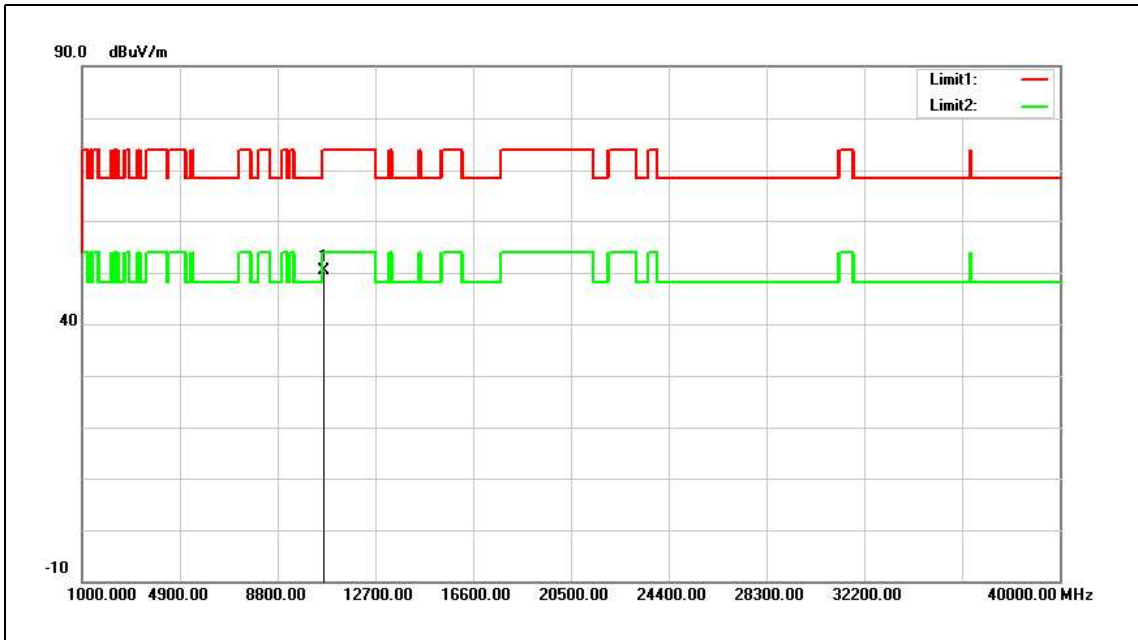

No.	Frequency (MHz)	Reading (dBuV)	Correct Factor (dB/m)	Result (dBuV/m)	Limit (dBuV/m)	Margin (dB)	Remark
1	10640.000	32.55	17.82	50.37	74.00	-23.63	peak

Note:1.Result (dBuV/m) = Correct Factor (dB/m) + Reading(dBuV).

2.Correction factor (dB/m) = Antenna Factor (dB/m) + Cable loss (dB) – Pre-Amplifier gain (dB).

3. When the peak results are less than average limit, so not need to evaluate the average.



Standard:	FCC Part 15.407	Test Distance:	3m
Test item:	Harmonic	Power:	AC 120V/60Hz
Frequency:	5320MHz	Temp.(°C)/Hum.(%RH):	26(°C)/60%RH
Mode:	Mode 2		
Ant.Polar.:	Vertical		

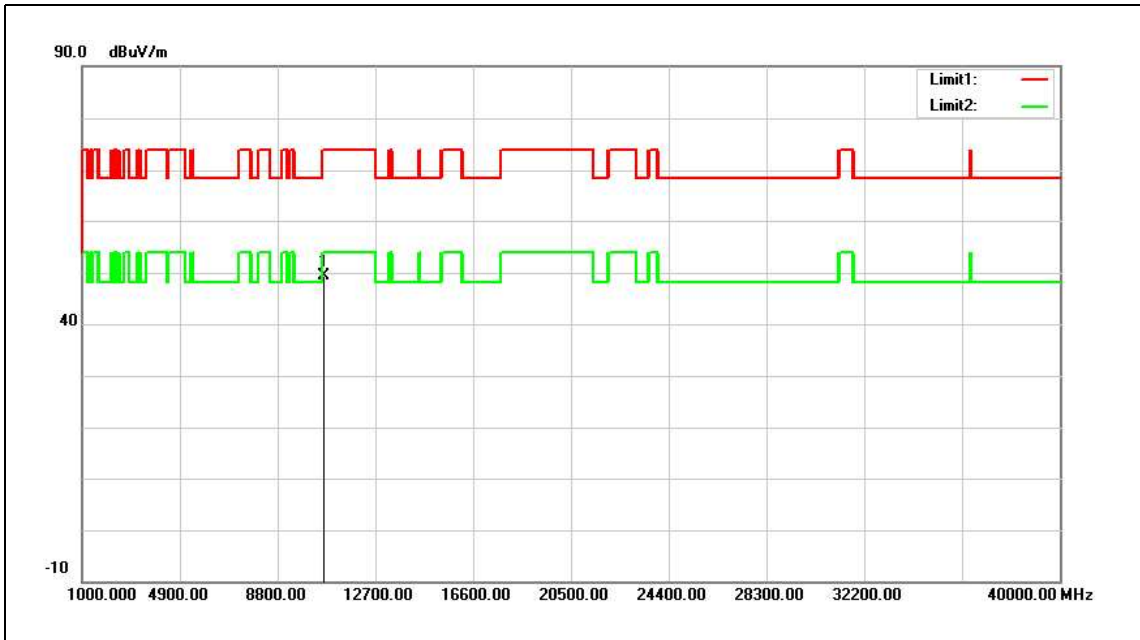

No.	Frequency (MHz)	Reading (dBuV)	Correct Factor (dB/m)	Result (dBuV/m)	Limit (dBuV/m)	Margin (dB)	Remark
1	10640.000	31.47	17.82	49.29	74.00	-24.71	peak

Note:1.Result (dBuV/m) = Correct Factor (dB/m) + Reading(dBuV).

2.Correction factor (dB/m) = Antenna Factor (dB/m) + Cable loss (dB) – Pre-Amplifier gain (dB).

3. When the peak results are less than average limit, so not need to evaluate the average.



Standard:	FCC Part 15.407	Test Distance:	3m
Test item:	Harmonic	Power:	AC 120V/60Hz
Frequency:	5500MHz	Temp.(°C)/Hum.(%RH):	26(°C)/60%RH
Mode:	Mode 2		
Ant.Polar.:	Horizontal		

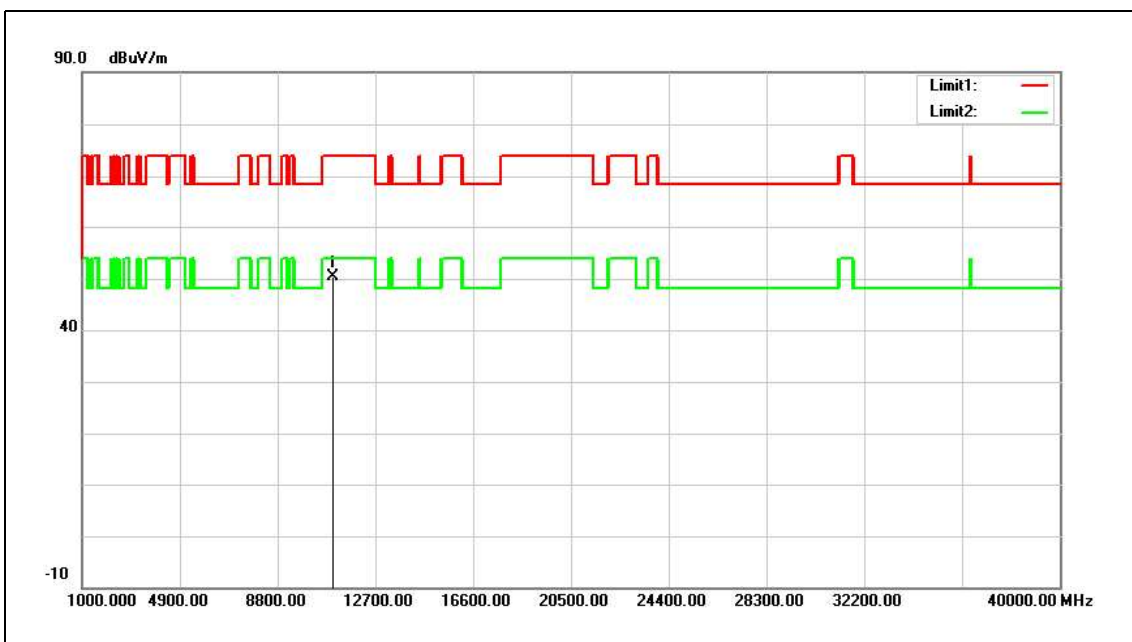

No.	Frequency (MHz)	Reading (dBuV)	Correct Factor (dB/m)	Result (dBuV/m)	Limit (dBuV/m)	Margin (dB)	Remark
1	11000.000	31.74	18.74	50.48	74.00	-23.52	peak

Note:1.Result (dBuV/m) = Correct Factor (dB/m) + Reading(dBuV).

2.Correction factor (dB/m) = Antenna Factor (dB/m) + Cable loss (dB) – Pre-Amplifier gain (dB).

3. When the peak results are less than average limit, so not need to evaluate the average.



Standard:	FCC Part 15.407	Test Distance:	3m
Test item:	Harmonic	Power:	AC 120V/60Hz
Frequency:	5500MHz	Temp.(°C)/Hum.(%RH):	26(°C)/60%RH
Mode:	Mode 2		
Ant.Polar.:	Vertical		

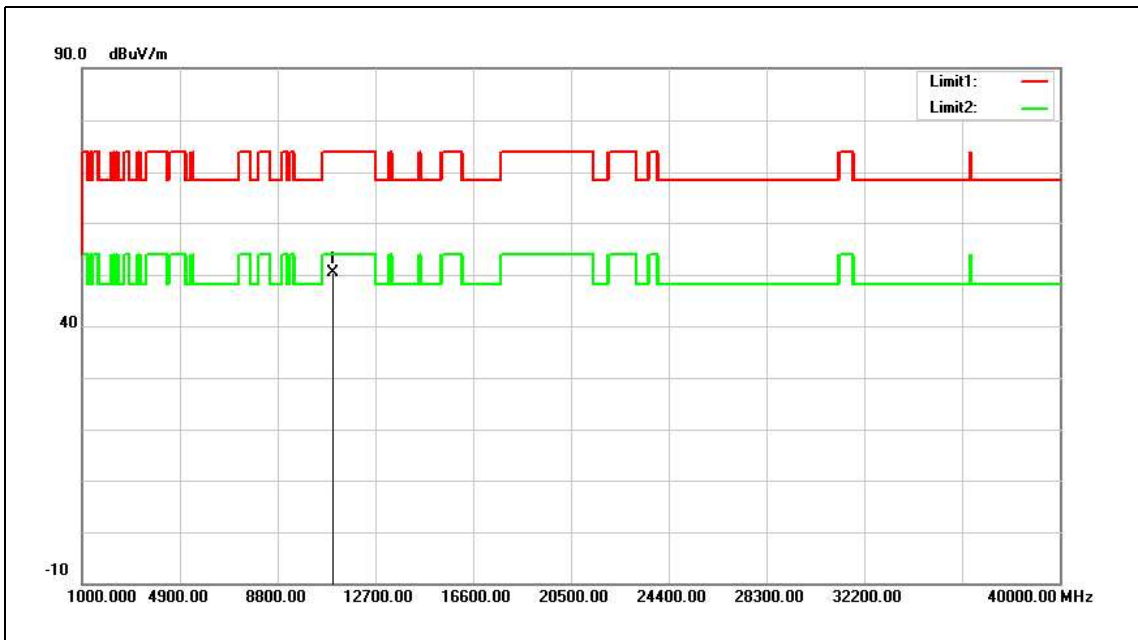

No.	Frequency (MHz)	Reading (dBuV)	Correct Factor (dB/m)	Result (dBuV/m)	Limit (dBuV/m)	Margin (dB)	Remark
1	11000.000	31.66	18.74	50.40	74.00	-23.60	peak

Note:1.Result (dBuV/m) = Correct Factor (dB/m) + Reading(dBuV).

2.Correction factor (dB/m) = Antenna Factor (dB/m) + Cable loss (dB) – Pre-Amplifier gain (dB).

3. When the peak results are less than average limit, so not need to evaluate the average.



Standard:	FCC Part 15.407	Test Distance:	3m
Test item:	Harmonic	Power:	AC 120V/60Hz
Frequency:	5560MHz	Temp.(°C)/Hum.(%RH):	26(°C)/60%RH
Mode:	Mode 2		
Ant.Polar.:	Horizontal		

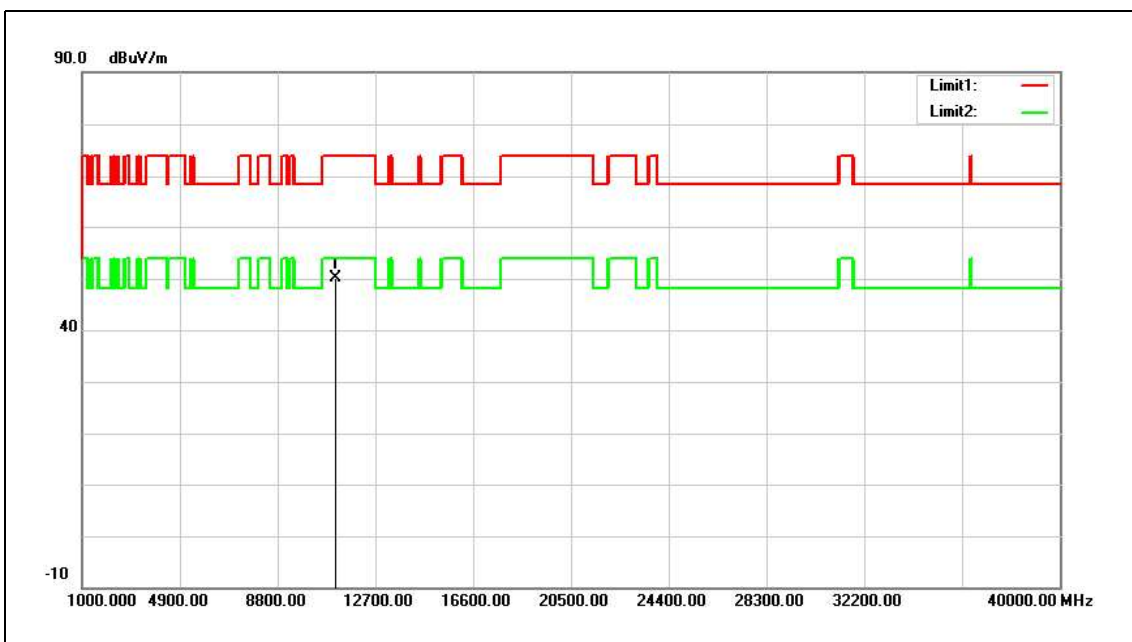

No.	Frequency (MHz)	Reading (dBuV)	Correct Factor (dB/m)	Result (dBuV/m)	Limit (dBuV/m)	Margin (dB)	Remark
1	11120.000	31.33	18.80	50.13	74.00	-23.87	peak

Note:1.Result (dBuV/m) = Correct Factor (dB/m) + Reading(dBuV).

2.Correction factor (dB/m) = Antenna Factor (dB/m) + Cable loss (dB) – Pre-Amplifier gain (dB).

3. When the peak results are less than average limit, so not need to evaluate the average.



Standard:	FCC Part 15.407	Test Distance:	3m
Test item:	Harmonic	Power:	AC 120V/60Hz
Frequency:	5560MHz	Temp.(°C)/Hum.(%RH):	26(°C)/60%RH
Mode:	Mode 2		
Ant.Polar.:	Vertical		

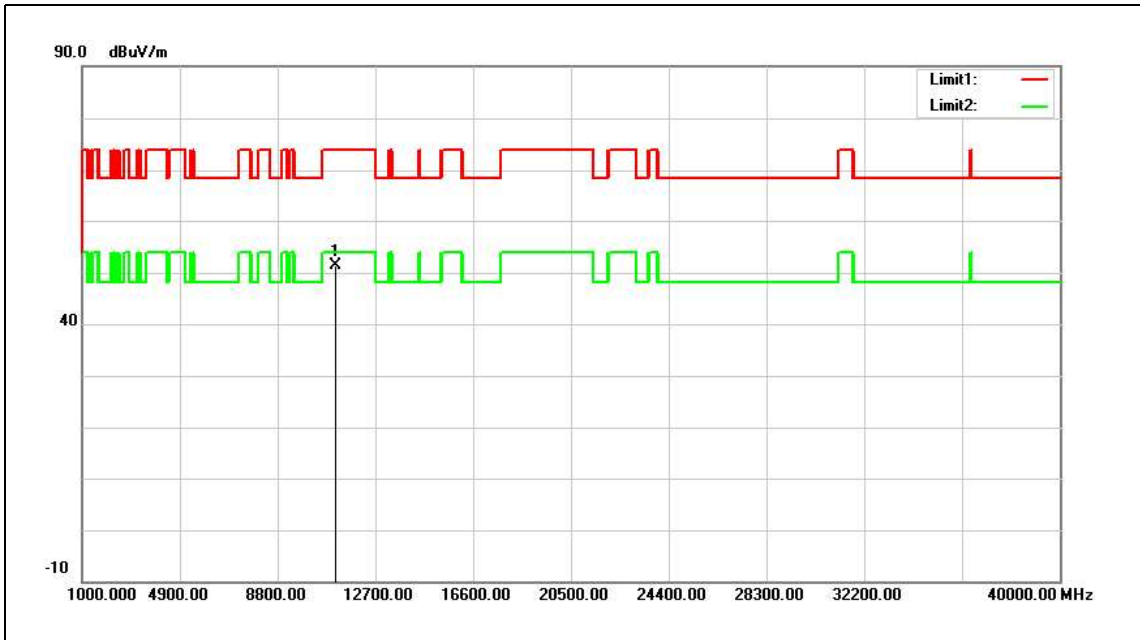

No.	Frequency (MHz)	Reading (dBuV)	Correct Factor (dB/m)	Result (dBuV/m)	Limit (dBuV/m)	Margin (dB)	Remark
1	11120.000	32.63	18.80	51.43	74.00	-22.57	peak

Note:1.Result (dBuV/m) = Correct Factor (dB/m) + Reading(dBuV).

2.Correction factor (dB/m) = Antenna Factor (dB/m) + Cable loss (dB) – Pre-Amplifier gain (dB).

3. When the peak results are less than average limit, so not need to evaluate the average.



Standard:	FCC Part 15.407	Test Distance:	3m
Test item:	Harmonic	Power:	AC 120V/60Hz
Frequency:	5700MHz	Temp.(°C)/Hum.(%RH):	26(°C)/60%RH
Mode:	Mode 2		
Ant.Polar.:	Horizontal		

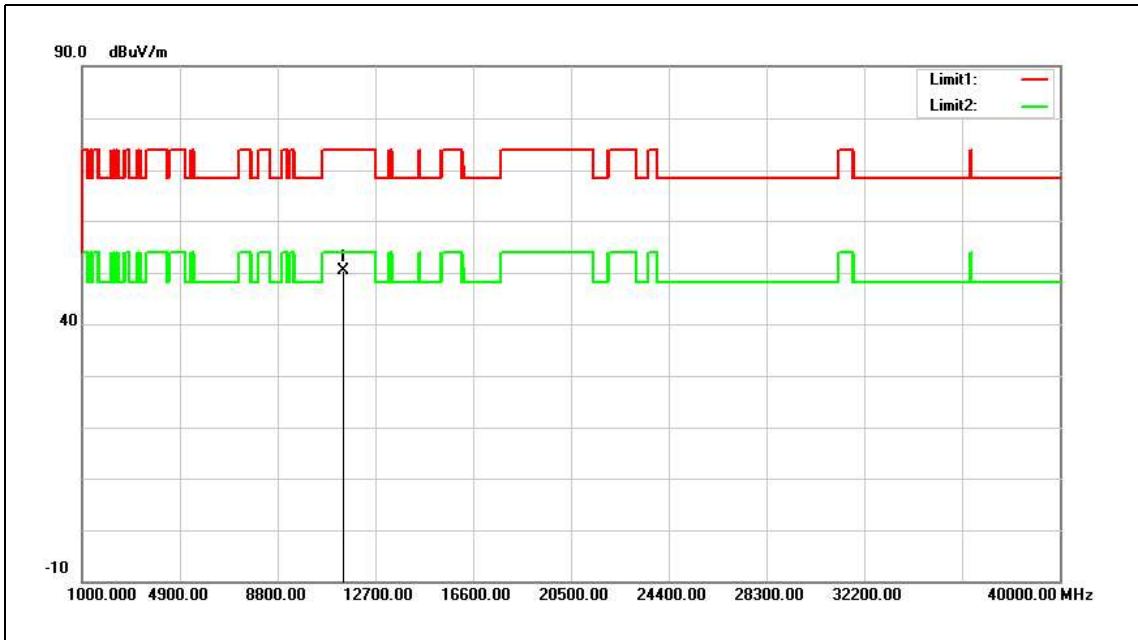

No.	Frequency (MHz)	Reading (dBuV)	Correct Factor (dB/m)	Result (dBuV/m)	Limit (dBuV/m)	Margin (dB)	Remark
1	11400.000	31.40	18.96	50.36	74.00	-23.64	peak

Note:1.Result (dBuV/m) = Correct Factor (dB/m) + Reading(dBuV).

2.Correction factor (dB/m) = Antenna Factor (dB/m) + Cable loss (dB) – Pre-Amplifier gain (dB).

3. When the peak results are less than average limit, so not need to evaluate the average.



Standard:	FCC Part 15.407	Test Distance:	3m
Test item:	Harmonic	Power:	AC 120V/60Hz
Frequency:	5700MHz	Temp.(°C)/Hum.(%RH):	26(°C)/60%RH
Mode:	Mode 2		
Ant.Polar.:	Vertical		

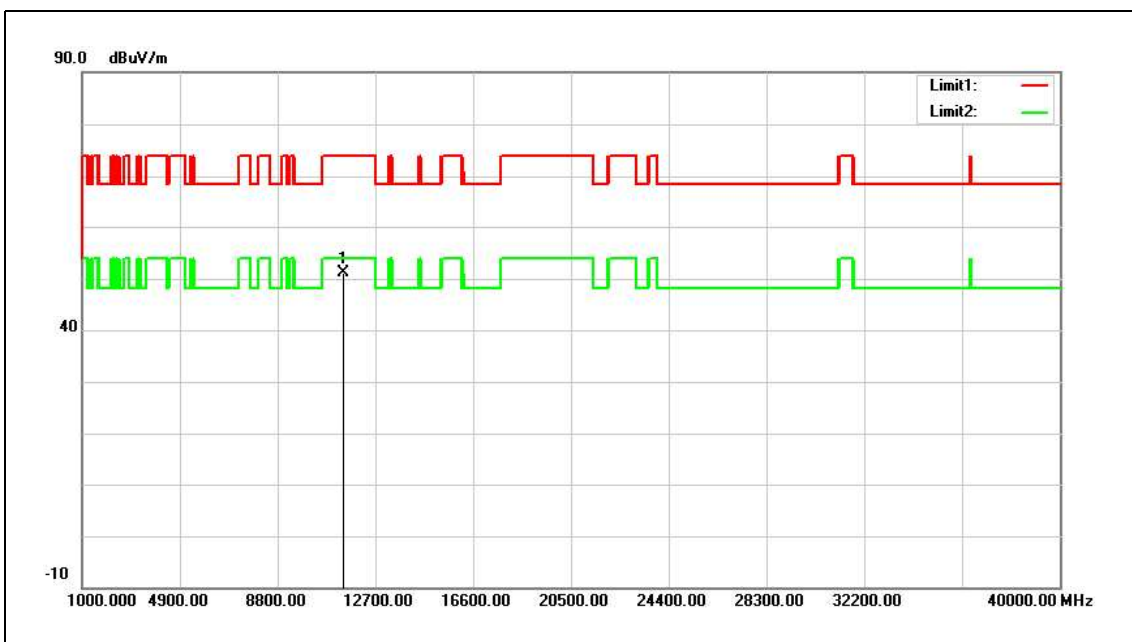

No.	Frequency (MHz)	Reading (dBuV)	Correct Factor (dB/m)	Result (dBuV/m)	Limit (dBuV/m)	Margin (dB)	Remark
1	11400.000	32.09	18.96	51.05	74.00	-22.95	peak

Note:1.Result (dBuV/m) = Correct Factor (dB/m) + Reading(dBuV).

2.Correction factor (dB/m) = Antenna Factor (dB/m) + Cable loss (dB) – Pre-Amplifier gain (dB).

3. When the peak results are less than average limit, so not need to evaluate the average.



Standard:	FCC Part 15.407	Test Distance:	3m
Test item:	Harmonic	Power:	AC 120V/60Hz
Frequency:	5260MHz	Temp.(°C)/Hum.(%RH):	26(°C)/60%RH
Mode:	Mode 3		
Ant.Polar.:	Horizontal		

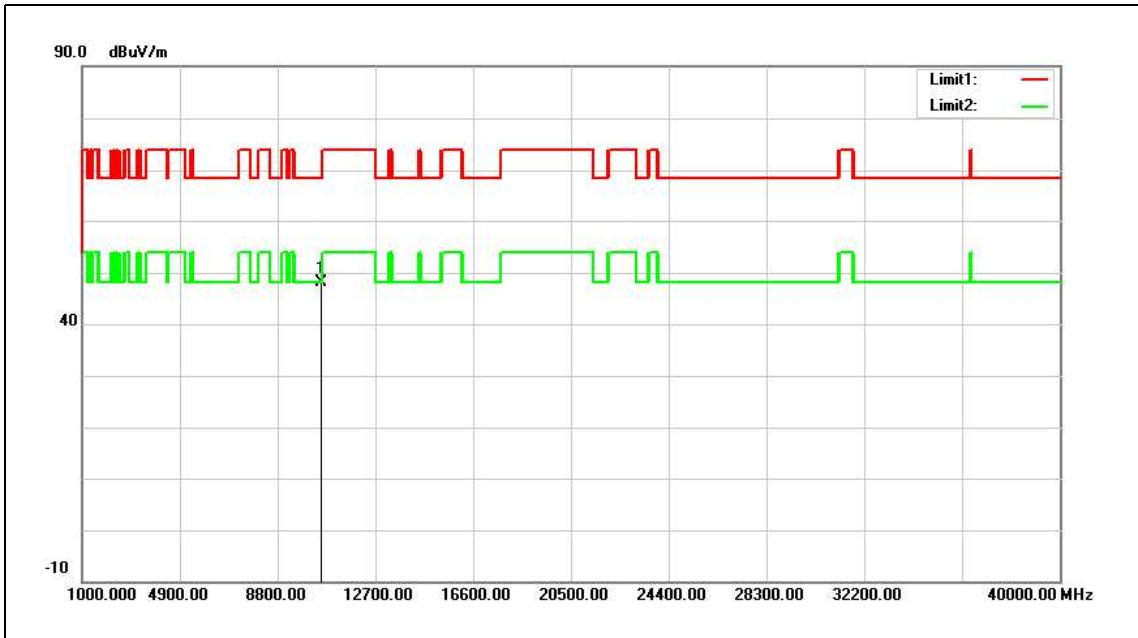

No.	Frequency (MHz)	Reading (dBuV)	Correct Factor (dB/m)	Result (dBuV/m)	Limit (dBuV/m)	Margin (dB)	Remark
1	10520.000	30.68	17.51	48.19	68.20	-20.01	peak

Note:1.Result (dBuV/m) = Correct Factor (dB/m) + Reading(dBuV).

2.Correction factor (dB/m) = Antenna Factor (dB/m) + Cable loss (dB) – Pre-Amplifier gain (dB).

3. When the peak results are less than average limit, so not need to evaluate the average.



Standard:	FCC Part 15.407	Test Distance:	3m
Test item:	Harmonic	Power:	AC 120V/60Hz
Frequency:	5260MHz	Temp.(°C)/Hum.(%RH):	26(°C)/60%RH
Mode:	Mode 3		
Ant.Polar.:	Vertical		

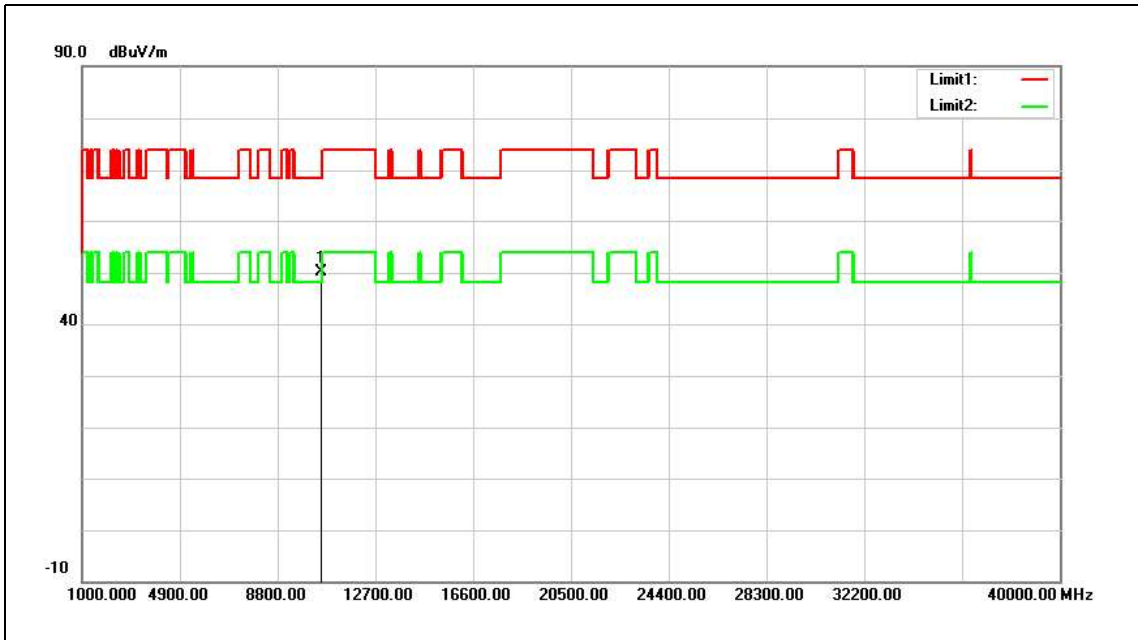

No.	Frequency (MHz)	Reading (dBuV)	Correct Factor (dB/m)	Result (dBuV/m)	Limit (dBuV/m)	Margin (dB)	Remark
1	10520.000	32.54	17.51	50.05	68.20	-18.15	peak

Note:1.Result (dBuV/m) = Correct Factor (dB/m) + Reading(dBuV).

2.Correction factor (dB/m) = Antenna Factor (dB/m) + Cable loss (dB) – Pre-Amplifier gain (dB).

3. When the peak results are less than average limit, so not need to evaluate the average.



Standard:	FCC Part 15.407	Test Distance:	3m
Test item:	Harmonic	Power:	AC 120V/60Hz
Frequency:	5280MHz	Temp.(°C)/Hum.(%RH):	26(°C)/60%RH
Mode:	Mode 3		
Ant.Polar.:	Horizontal		

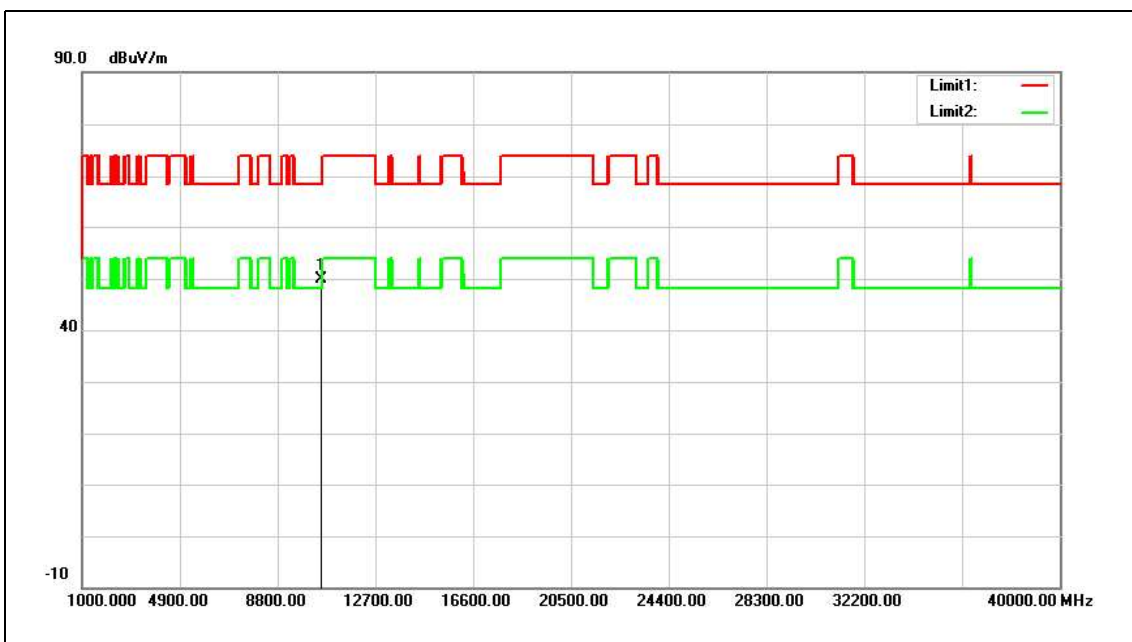

No.	Frequency (MHz)	Reading (dBuV)	Correct Factor (dB/m)	Result (dBuV/m)	Limit (dBuV/m)	Margin (dB)	Remark
1	10560.000	32.31	17.60	49.91	68.20	-18.29	peak

Note:1.Result (dBuV/m) = Correct Factor (dB/m) + Reading(dBuV).

2.Correction factor (dB/m) = Antenna Factor (dB/m) + Cable loss (dB) – Pre-Amplifier gain (dB).

3. When the peak results are less than average limit, so not need to evaluate the average.



Standard:	FCC Part 15.407	Test Distance:	3m
Test item:	Harmonic	Power:	AC 120V/60Hz
Frequency:	5280MHz	Temp.(°C)/Hum.(%RH):	26(°C)/60%RH
Mode:	Mode 3		
Ant.Polar.:	Vertical		

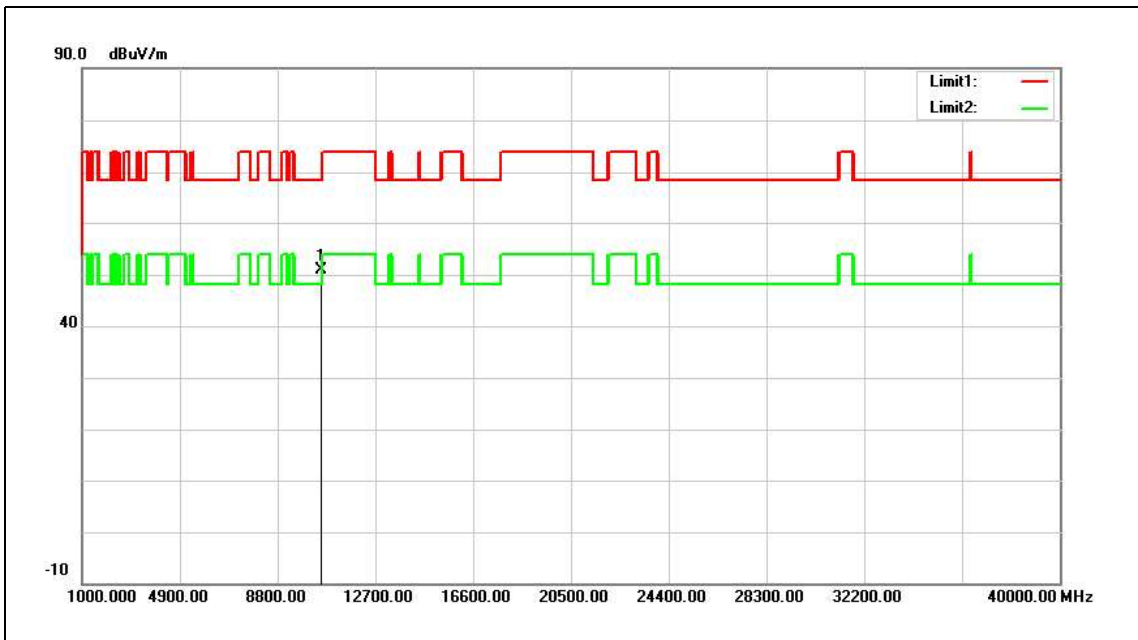

No.	Frequency (MHz)	Reading (dBuV)	Correct Factor (dB/m)	Result (dBuV/m)	Limit (dBuV/m)	Margin (dB)	Remark
1	10560.000	33.28	17.60	50.88	68.20	-17.32	peak

Note:1.Result (dBuV/m) = Correct Factor (dB/m) + Reading(dBuV).

2.Correction factor (dB/m) = Antenna Factor (dB/m) + Cable loss (dB) – Pre-Amplifier gain (dB).

3. When the peak results are less than average limit, so not need to evaluate the average.



Standard:	FCC Part 15.407	Test Distance:	3m
Test item:	Harmonic	Power:	AC 120V/60Hz
Frequency:	5320MHz	Temp.(°C)/Hum.(%RH):	26(°C)/60%RH
Mode:	Mode 3		
Ant.Polar.:	Horizontal		

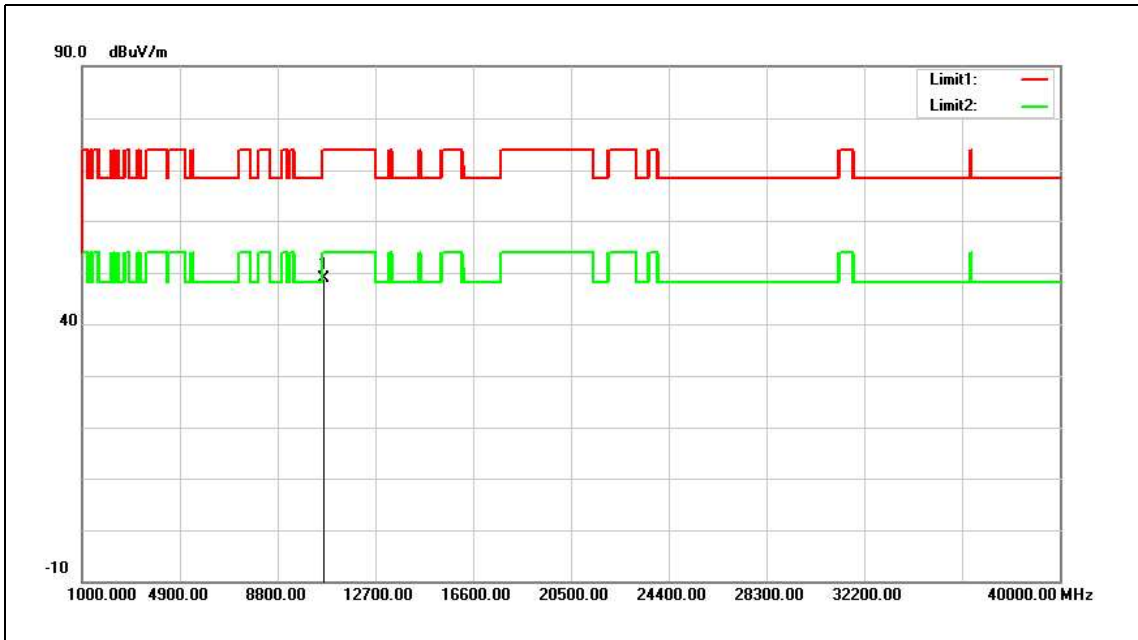

No.	Frequency (MHz)	Reading (dBuV)	Correct Factor (dB/m)	Result (dBuV/m)	Limit (dBuV/m)	Margin (dB)	Remark
1	10640.000	31.17	17.82	48.99	74.00	-25.01	peak

Note:1.Result (dBuV/m) = Correct Factor (dB/m) + Reading(dBuV).

2.Correction factor (dB/m) = Antenna Factor (dB/m) + Cable loss (dB) – Pre-Amplifier gain (dB).

3. When the peak results are less than average limit, so not need to evaluate the average.



Standard:	FCC Part 15.407	Test Distance:	3m
Test item:	Harmonic	Power:	AC 120V/60Hz
Frequency:	5320MHz	Temp.(°C)/Hum.(%RH):	26(°C)/60%RH
Mode:	Mode 3		
Ant.Polar.:	Vertical		

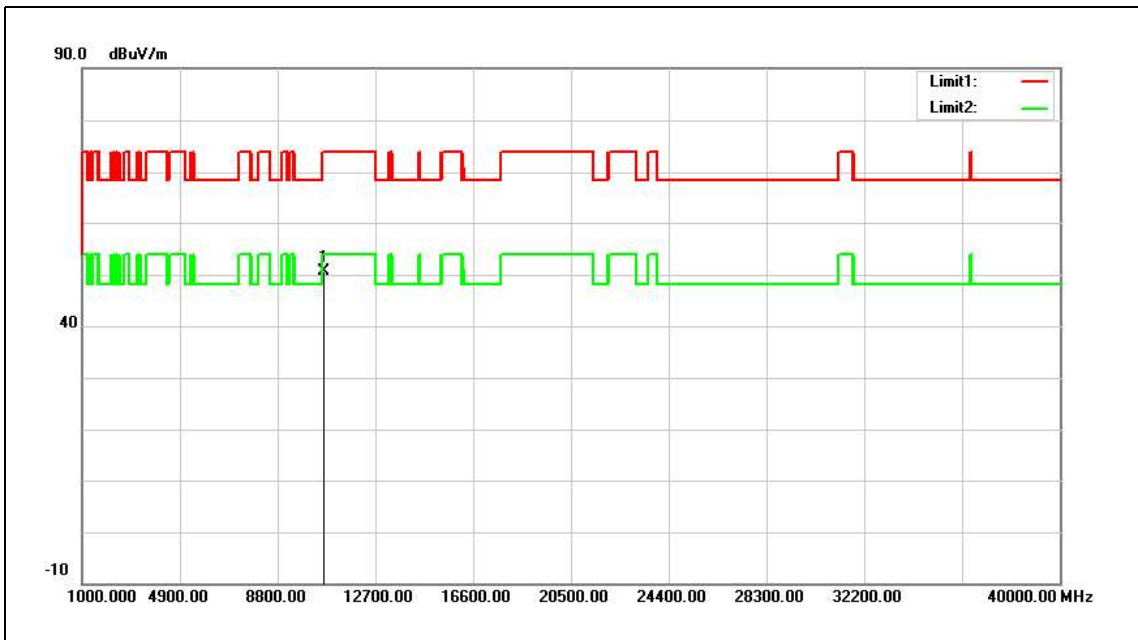

No.	Frequency (MHz)	Reading (dBuV)	Correct Factor (dB/m)	Result (dBuV/m)	Limit (dBuV/m)	Margin (dB)	Remark
1	10640.000	32.70	17.82	50.52	74.00	-23.48	peak

Note:1.Result (dBuV/m) = Correct Factor (dB/m) + Reading(dBuV).

2.Correction factor (dB/m) = Antenna Factor (dB/m) + Cable loss (dB) – Pre-Amplifier gain (dB).

3. When the peak results are less than average limit, so not need to evaluate the average.



Standard:	FCC Part 15.407	Test Distance:	3m
Test item:	Harmonic	Power:	AC 120V/60Hz
Frequency:	5500MHz	Temp.(°C)/Hum.(%RH):	26(°C)/60%RH
Mode:	Mode 3		
Ant.Polar.:	Horizontal		

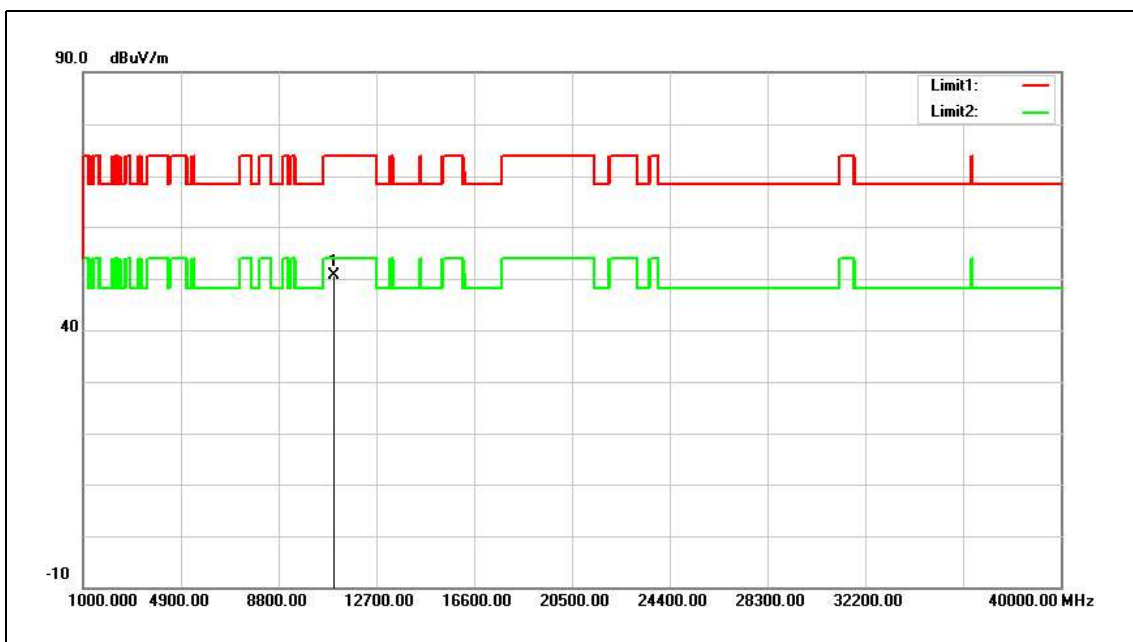

No.	Frequency (MHz)	Reading (dBuV)	Correct Factor (dB/m)	Result (dBuV/m)	Limit (dBuV/m)	Margin (dB)	Remark
1	11000.000	31.89	18.74	50.63	74.00	-23.37	peak

Note:1.Result (dBuV/m) = Correct Factor (dB/m) + Reading(dBuV).

2.Correction factor (dB/m) = Antenna Factor (dB/m) + Cable loss (dB) – Pre-Amplifier gain (dB).

3. When the peak results are less than average limit, so not need to evaluate the average.