



FCC RADIO TEST REPORT

Applicant : Datto, Inc.
Address : 101 Merritt 7, Norwalk, CT 06851 USA
Equipment : WiFi Access Point
Model No. : A40
Trade Name : 
FCC ID : WT8OMA40

I HEREBY CERTIFY THAT :

The sample was received on Jul. 20, 2017 and the testing was carried out on Jul. 27, 2017 at CerpPASS Technology Corp. The test result refers exclusively to the test presented test model / sample. Without written approval of CerpPASS Technology Corp., the test report shall not be reproduced except in full.

Approved by:

Mark Liao / Assistant Manager

Tested by:

Spree Yei / Engineer

Laboratory Accreditation:

CerpPASS Technology Corporation Test Laboratory





CONTENTS

- 1. Summary of Test Procedure and Test Results 5
 - 1.1. Applicable Standards 5
- 2. Test Configuration of Equipment under Test 6
 - 2.1. Feature of Equipment under Test..... 6
 - 2.2. Carrier Frequency of Channels 6
 - 2.3. Test Mode and Test Software 7
 - 2.4. Description of Test System..... 7
 - 2.5. General Information of Test..... 8
 - 2.6. Measurement Uncertainty 8
- 3. Test Equipment and Ancillaries Used for Tests 9
- 4. Antenna Requirements 10
 - 4.1. Standard Applicable 10
 - 4.2. Antenna Construction and Directional Gain..... 10
- 5. Test of AC Power Line Conducted Emission 11
 - 5.1. Test Limit 11
 - 5.2. Test Procedures 11
 - 5.3. Typical Test Setup 12
 - 5.4. Test Result and Data 13
 - 5.5. Test Photographs 15
- 6. Test of Spurious Emission (Radiated) 16
 - 6.1. Test Limit 16
 - 6.2. Test Procedures 16
 - 6.3. Typical Test Setup 17
 - 6.4. Test Result and Data (9kHz ~ 30MHz)..... 18
 - 6.5. Test Result and Data (30MHz ~ 1GHz)..... 18
 - 6.6. Test Result and Data (1GHz ~ 40GHz)..... 20
 - 6.7. Restricted Bands of Operation 38
 - 6.8. Test Photographs (30MHz ~ 1GHz) 39
 - 6.9. Test Photographs (1GHz ~ 40GHz) 40
- 7. On Time, Duty Cycle and Measurement methods 41
 - 7.1. Test Limit 41
 - 7.2. Test Procedure 41
 - 7.3. Test Setup Layout 41
 - 7.4. Test Result and Data 41
 - 7.5. Measurement Methods 41
- 8. 26dB Bandwidth 43
 - 8.1. Test Limit 43
 - 8.2. Test Procedure 43
 - 8.3. Test Setup Layout 43
 - 8.4. Test Result and Data 43
- 9. Average Power..... 48
 - 9.1. Test Limit 48
 - 9.2. Test Procedure 48
 - 9.3. Test Setup Layout 48



- 9.4. Test Result and Data 49
- 10. PPSD 51
 - 10.1. Test Limit 51
 - 10.2. Test Procedure 53
 - 10.3. Test Setup Layout 53
 - 10.4. Test Result and Data 53
- 11. Frequency Stability 58
 - 11.1. Test Procedure 58
 - 11.2. Test Setup Layout 58
 - 11.3. Test Result and Data 59
- 12. Automatically Discontinue Transmission 60
 - 12.1. Limit of Automatically Discontinue Transmission 60
 - 12.2. Test Result of Automatically Discontinue Transmission 60
- 13. Radio Frequency Exposure 61
 - 13.1. Applicable Standards 61
 - 13.2. EUT Specification 61
 - 13.3. Test Results 61
 - 13.4. Calculation 62
 - 13.5. Maximum Permissible Exposure 63



History of this test report

Report No.	Issue Date	Description
TEFE1610202	Dec. 19, 2016	Original
TEFE1706330	Jul. 31, 2017	This test report was to request a Class II Change, as follow: 1. additional outdoor use



1. Summary of Test Procedure and Test Results

1.1. Applicable Standards

ANSI C63.4:2014

ANSI C63.10:2013

FCC Rules and Regulations Part 15 Subpart E §15.407

First R&O 14-30

KDB662911

KDB789033

KDB644545

FCC Rule	Description of Test	Result
15.203	. Antenna Requirement	Pass
15.207(a)	. AC Power Line Conducted Emission	Pass
15.407(b) 15.209	. Radiated Spurious Emission	Pass
15.407(a)	. 26 dB Occupied Bandwidth	Pass
15.407 (a) & (a)(3)	. Average Power	Pass
15.407(a)	. PPSD	Pass



2. Test Configuration of Equipment under Test

2.1. Feature of Equipment under Test

Modulation Type	DSSS, OFDM
Frequency Range	802.11b/g/n: 2412-2462MHz 802.11a/an/ac: 5150-5250MHz, 5725-5850MHz
Data Rate	802.11b: 1, 2, 5.5, 11Mbps 802.11g: 6, 9, 12, 18, 24, 36, 48, 54Mbps 802.11n: MCS0 – MCS15, HT20/40 802.11a: 6, 9, 12, 18, 24, 36, 48, 54Mbps 802.11ac: MCS0 – MCS9, VHT 20/40/80)
Antenna Type	PIFA Antenna
Antenna Gain	802.11b/g/n: Antenna 1: 4.6 dBi Antenna 2: 3.3 dBi 802.11a/an/ac: Antenna 1: 4.7 dBi Antenna 2: 4.8 dBi

2.2. Carrier Frequency of Channels

Band: 5150MHz-5250MHz

802.11a, 802.11an HT 20, 802.11ac VHT20

Channel	Frequency(MHz)	Channel	Frequency(MHz)
*36	5180	*44	5220
40	5200	*48	5240

802.11an HT 40, 802.11ac VHT40

Channel	Frequency(MHz)	Channel	Frequency(MHz)
*38	5190	*46	5230

802.11ac VHT80

Channel	Frequency(MHz)
*42	5210

Note: Channels remarked * are selected to perform test.



2.3. Test Mode and Test Software

- a. During testing, the interface cables and equipment positions were varied according to ANSI C63.4.
- b. The complete test system included remote workstation and EUT for RF test. The remote workstation included Notebook.
- c. An executive program, "ART2-GUI" under WIN 7 was executed to transmit and receive data via WLAN.
- d. The following test modes were performed for the test:

Test Mode	Operating Description
1	802.11a (6Mbps)
2	802.11an HT20 (6.5Mbps)
3	802.11an HT40 (13.5Mbps)
4	802.11ac VHT20 (6.5Mbps)
5	802.11ac VHT40 (13.5Mbps)
6	802.11ac VHT80 (29.3Mbps)

For conduction test, caused "Test Mode 1" generated the worst case, it was reported as the final data.

For radiation test (below 1GHz), caused "Test Mode 1" generated the worst case, it was reported as the final data.

For radiation test (above 1GHz), caused "Test Mode 1,4,5,6" generated the worst case, they were reported as the final data.

2.4. Description of Test System

Device	Manufacturer	Model No.	Description
Remote workstation			
Notebook	DELL	Latitude E6430	Power Cable, Unshielding, 1.8m

Use Cable:

Cable	Quantity	Description
Notebook	1	Unshielding, 1.2m
Notebook	1	Unshielding, 15.0m

**2.5. General Information of Test**

Test Site	Cerpass Technology Corporation Test Laboratory Address: No.10, Ln. 2, Lianfu St., Luzhu Dist., Taoyuan City 33848, Taiwan (R.O.C.) Tel:+886-3-3226-888 Fax:+886-3-3226-881 Address: No.68-1, Shihbachongsi, Shihding Township, New Taipei City 223, Taiwan, R.O.C. Tel: +886-2-2663-8582	
	FCC	TW1079, TW1061, 390316, 228391, 641184
	IC	4934E-1, 4934E-2
	VCCI	T-2205 for Telecommunication Test C-4663 for Conducted emission test R-4218, R-4399 for Radiated emission test G-812, G-813 for radiated disturbance above 1GHz
Frequency Range Investigated:	Conducted: from 150kHz to 30 MHz Radiation: from 30 MHz to 40,000MHz	
Test Distance:	The test distance of radiated emission from antenna to EUT is 3 M.	

2.6. Measurement Uncertainty

Measurement Item	Measurement Frequency	Polarization	Uncertainty
Conducted Emission	9 kHz ~ 30 MHz	Line / Neutral	±2.9076 dB
Radiated Emission	9 kHz ~ 25,000 MHz	Vertical / Horizontal	±0.948 dB
Spurious Emission (Conducted)	-	-	±4.011 dB
Maximum Peak and Average Output Power	-	-	±0.322 dB
Power Spectral Density	-	-	±0.322 dB
Bandwidth	-	-	74.224Hz



3. Test Equipment and Ancillaries Used for Tests

Instrument	Manufacturer	Model No.	Serial No.	Calibration Date	Valid Date
EMI Receiver	R&S	ESCI3	100443	2017/03/07	2018/03/06
LISN	Schwarzbeck	NSLK 8127	8127-740	2016/08/30	2017/08/29
LISN	Schwarzbeck	NSLK 8127	8127-516	2016/09/06	2017/09/05
Pulse Limiter	R&S	ESH3-Z2	101934	2017/02/14	2018/02/13
Bilog Antenna	Schwarzbeck	VULB9168	369	2017/03/15	2018/03/14
Active Loop Antenna	EMCO	6507	40855	2017/05/15	2018/05/14
Horn Antenna	EMCO	3115	31601	2016/09/05	2017/09/04
Horn Antenna	EMCO	3116	31970	2017/03/29	2018/03/28
EXA Signal Analyzer	KEYSIGHT	N9010A	MY54200207	2017/03/17	2018/03/16
Preamplifier	EM	EM330	60660	2017/02/25	2018/02/24
Preamplifier	EMC INSTRUMENTS	EMC051845SE	980333	2016/09/13	2017/09/12
Preamplifier	Agilent	8449B	3008A01954	2017/02/09	2018/02/08
Preamplifier	EMC INSTRUMENTS	EMC184045	980065	2016/11/04	2017/11/03
MXG MW Analog Signal Generator	KEYSIGHT	N5183A	MY50142931	2017/03/17	2018/03/16
Spectrum Analyzer	R&S	FSP40	100219	2016/09/01	2017/08/31
BLUETOOTH TESTER	R&S	CBT	101133	2017/03/10	2018/03/09
Attenuator	KEYSIGHT	8491B	MY39250703	2017/03/07	2018/03/06
Rotary Attenuator	Agilent	8495B	MY42146680	2017/03/13	2018/03/12
Temp & Humi chamber	T-MACHINE	TMJ-9712	T-12-040111	2016/09/05	2017/09/04
Series Power Meter	Anritsu	ML2495A	1224005	2017/03/01	2018/02/28
Power Sensor	Anritsu	MA2411B	1207295	2017/03/01	2018/02/28
Cable	HUBER SUHNER	SUCOFLEX 102	28422/2	2017/02/25	2018/02/24
Cable	HUBER SUHNER	SUCOFLEX 102	28418/2	2017/02/25	2018/02/24
Software	Farad	Ez-EMC	ver.ct3a1	N/A	N/A
Software	AUDIX	E3	V8.2014-8-6	N/A	N/A
Software	Keysight	N7607B Signal Studio	v2.0.0.1	N/A	N/A
Software	Keysight	Inservice MonitorUtility	N/A	N/A	N/A



4. Antenna Requirements

4.1. Standard Applicable

For intentional device, according to FCC 47 CFR Section 15.203, an intentional radiator shall be designed to ensure that no antenna other than that furnished by the responsible party shall be used with the device.

And according to FCC 47 CFR Section 15.407 (a), if transmitting antennas of directional gain greater than 6dBi are used, the power shall be reduced by the amount in dB that the directional gain of the antenna exceeds 6dBi.

4.2. Antenna Construction and Directional Gain

Antenna Type	Antenna Gain
PIFA Antenna	Antenna 1: 4.7 dBi
	Antenna 2: 4.8 dBi

For Power directional gain= G_{ant} = 4.80 dBi

For PSD directional gain = $10 \log[(10^{G1/20} + 10^{G2/20} + \dots + 10^{GN/20})^2 / NANT]$
= 7.76 (dBi)



5. Test of AC Power Line Conducted Emission

5.1. Test Limit

Conducted Emissions were measured from 150 kHz to 30 MHz with a bandwidth of 9 KHz, according to the methods defined in ANSI C63.4-2014. The EUT was placed on a nonmetallic stand in a shielded room 0.8 meters above the ground plane. The interface cables and equipment positioning were varied within limits of reasonable applications to determine the position produced maximum conducted emissions.

Frequency (MHz)	Quasi Peak (dB μ V)	Average (dB μ V)
0.15 – 0.5	66-56*	56-46*
0.5 – 5.0	56	46
5.0 – 30.0	60	50

*Decreases with the logarithm of the frequency.

5.2. Test Procedures

- The EUT was placed 0.4 meter from the conducting wall of the shielding room was kept at least 80 centimeters from any other grounded conducting surface.
- Connect EUT to the power mains through a line impedance stabilization network (LISN).
- All the support units are connecting to the other LISN.
- The LISN provides 50 ohm coupling impedance for the measuring instrument.
- The FCC states that a 50 ohm, 50 micro-Henry LISN should be used.
- Both sides of AC line were checked for maximum conducted interference.
- The frequency range from 150 kHz to 30 MHz was searched.
- Set the test-receiver system to Peak Detect Function and Specified Bandwidth with Maximum Hold Mode.



5.3. Typical Test Setup

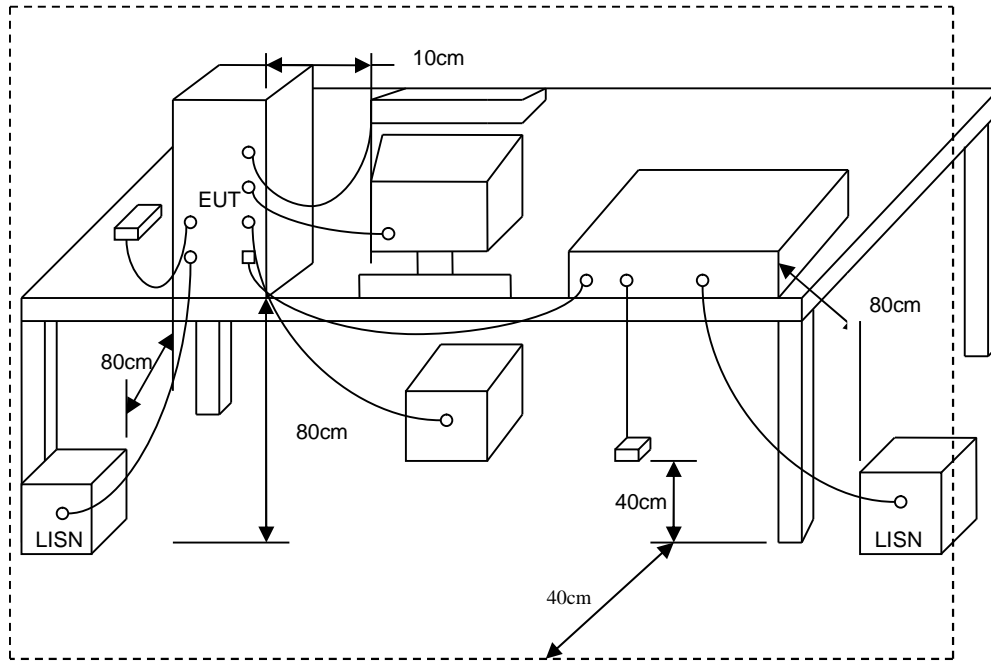



5.4. Test Result and Data

Power	: PoE	Pol/Phase	: LINE
Test Mode	: Mode 1	Temperature	: 20 °C
Test date	: Jul. 26, 2017	Humidity	: 62 %

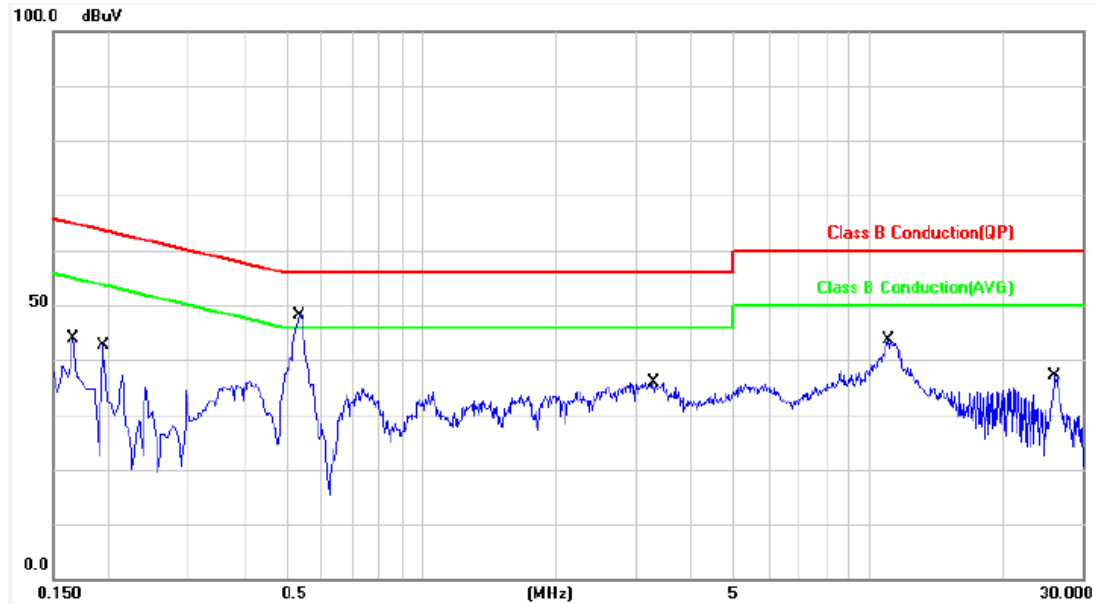

No.	Frequency (MHz)	Factor (dB)	Reading (dBuV)	Level (dBuV)	Limit (dBuV)	Margin (dB)	Detector	P/F
1	0.1660	9.91	33.76	43.67	65.15	-21.48	QP	P
2	0.1660	9.91	19.91	29.82	55.15	-25.33	AVG	P
3	0.1940	9.91	30.09	40.00	63.86	-23.86	QP	P
4	0.1940	9.91	17.21	27.12	53.86	-26.74	AVG	P
5	0.5340	9.93	36.77	46.70	56.00	-9.30	QP	P
6	0.5340	9.93	31.75	41.68	46.00	-4.32	AVG	P
7	3.2940	10.11	22.57	32.68	56.00	-23.32	QP	P
8	3.2940	10.11	17.49	27.60	46.00	-18.40	AVG	P
9	11.0739	10.37	28.85	39.22	60.00	-20.78	QP	P
10	11.0739	10.37	23.60	33.97	50.00	-16.03	AVG	P
11	26.0580	10.75	22.13	32.88	60.00	-27.12	QP	P
12	26.0580	10.75	14.13	24.88	50.00	-25.12	AVG	P

Note: Level = Reading + Factor
 Margin = Level – Limit
 Factor = (LISN, ISN, PLC or current probe) Factor + Cable Loss+ Attenuator



Power	: PoE	Pol/Phase	: NEUTRAL
Test Mode	: Mode 1	Temperature	: 20 °C
Test date	: Jul. 26, 2017	Humidity	: 62 %

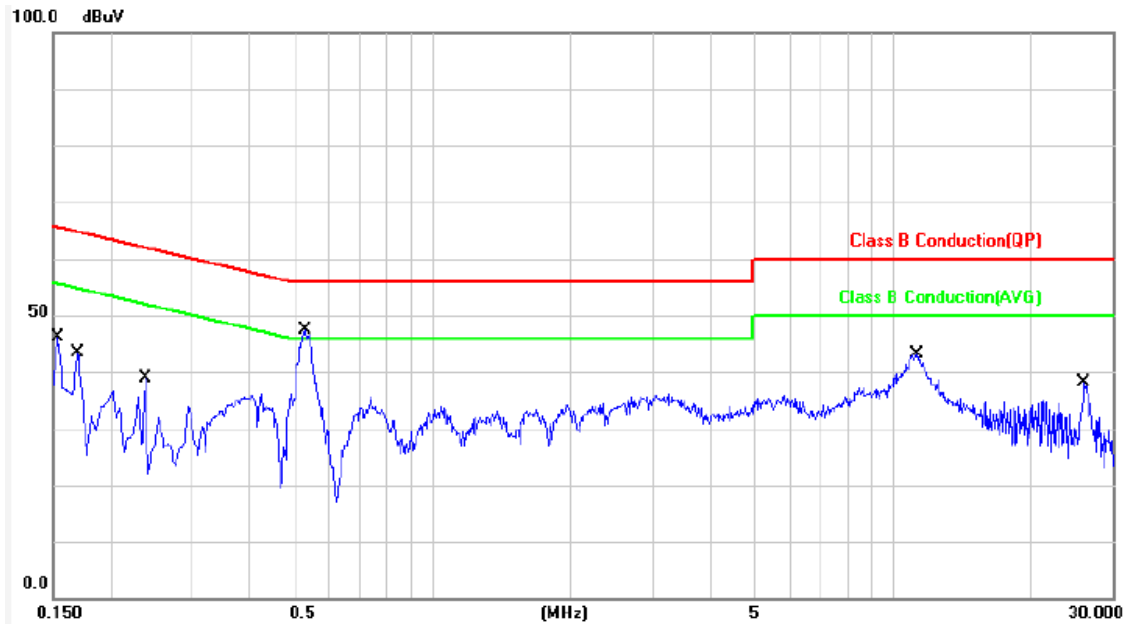

No.	Frequency (MHz)	Factor (dB)	Reading (dBuV)	Level (dBuV)	Limit (dBuV)	Margin (dB)	Detector	P/F
1	0.1539	9.88	36.52	46.40	65.78	-19.38	QP	P
2	0.1539	9.88	23.25	33.13	55.78	-22.65	AVG	P
3	0.1700	9.88	34.10	43.98	64.96	-20.98	QP	P
4	0.1700	9.88	19.94	29.82	54.96	-25.14	AVG	P
5	0.2380	9.88	23.86	33.74	62.16	-28.42	QP	P
6	0.2380	9.88	11.49	21.37	52.16	-30.79	AVG	P
7	0.5299	9.89	36.58	46.47	56.00	-9.53	QP	P
8	0.5299	9.89	31.81	41.70	46.00	-4.30	AVG	P
9	11.2820	10.36	29.13	39.49	60.00	-20.51	QP	P
10	11.2820	10.36	24.02	34.38	50.00	-15.62	AVG	P
11	26.0459	10.77	22.02	32.79	60.00	-27.21	QP	P
12	26.0459	10.77	13.78	24.55	50.00	-25.45	AVG	P

Note: Level = Reading + Factor
 Margin = Level – Limit
 Factor = (LISN, ISN, PLC or current probe) Factor + Cable Loss+ Attenuator



6. Test of Spurious Emission (Radiated)

6.1. Test Limit

Undesirable emission limits. Except as shown in paragraph (b)(7) of this section, the maximum emissions outside of the frequency bands of operation shall be attenuated in accordance with the following limits:

- (1) For transmitters operating in the 5.15-5.25 GHz band: All emissions outside of the 5.15-5.35 GHz band shall not exceed an e.i.r.p. of -27 dBm/MHz.
- (2) For transmitters operating in the 5.25-5.35 GHz band: All emissions outside of the 5.15-5.35 GHz band shall not exceed an e.i.r.p. of -27 dBm/MHz.
- (3) For transmitters operating in the 5.47-5.725 GHz band: All emissions outside of the 5.47-5.725 GHz band shall not exceed an e.i.r.p. of -27 dBm/MHz.
- (4) For transmitters operating in the 5.725-5.85 GHz band:
 - (i) All emissions shall be limited to a level of -27 dBm/MHz at 75 MHz or more above or below the band edge increasing linearly to 10 dBm/MHz at 25 MHz above or below the band edge, and from 25MHz above or below the band edge increasing linearly to a level of 15.6 dBm/MHz at 5 MHz above or below the band edge, and from 5 MHz above or below the band edge increasing linearly to a level of 27dBm/MHz at the band edge.
- (5) The emission measurements shall be performed using a minimum resolution bandwidth of 1 MHz. A lower resolution bandwidth may be employed near the band edge, when necessary, provided the measured energy is integrated to show the total power over 1 MHz.
- (6) Unwanted emissions below 1 GHz must comply with the general field strength limits set forth in §15.209. Further, any U-NII devices using an AC power line are required to comply also with the conducted limits set forth in §15.207.
- (7) The provisions of §15.205 apply to intentional radiators operating under this section.
- (8) When measuring the emission limits, the nominal carrier frequency shall be adjusted as close to the upper and lower frequency band edges as the design of the equipment permits.

6.2. Test Procedures

- a. The EUT was placed on a rotatable table top 0.8 meter above ground.
- b. The EUT was set 3 meters from the interference receiving antenna which was mounted on the top of a variable height antenna tower.
- c. The table was rotated 360 degrees to determine the position of the highest radiation.
- d. The antenna is a broadband antenna and its height is varied between one meter and four meters above ground to find the maximum value of the field strength both horizontal polarization and vertical polarization of the antenna are set to make the measurement.
- e. For each suspected emission the EUT was arranged to its worst case and then tune the antenna tower (from 1 M to 4 M) and turn table (from 0 degree to 360 degrees) to find the maximum reading.
- f. Set the test-receiver system to Peak or CISPR quasi-peak Detect Function and specified bandwidth with Maximum Hold Mode.
- g. If the emission level of the EUT in peak mode was 3 dB lower than the limit specified, then testing will be stopped and peak values of EUT will be reported, otherwise, the emissions which do not have 3 dB margin will be repeated one by one using the quasi-peak method and reported.
- h. For testing above 1GHz, the emission level of the EUT in peak mode was 20dB lower than average limit (that means the emission level in peak mode also complies with the limit in average mode), then testing will be stopped and peak values of EUT will be reported, otherwise, the emissions will be measured in average mode again and reported.
- i. "Cone of radiation" has been considered to be 3dB bandwidth of the measurement antenna.



6.3. Typical Test Setup

Below 30MHz test setup

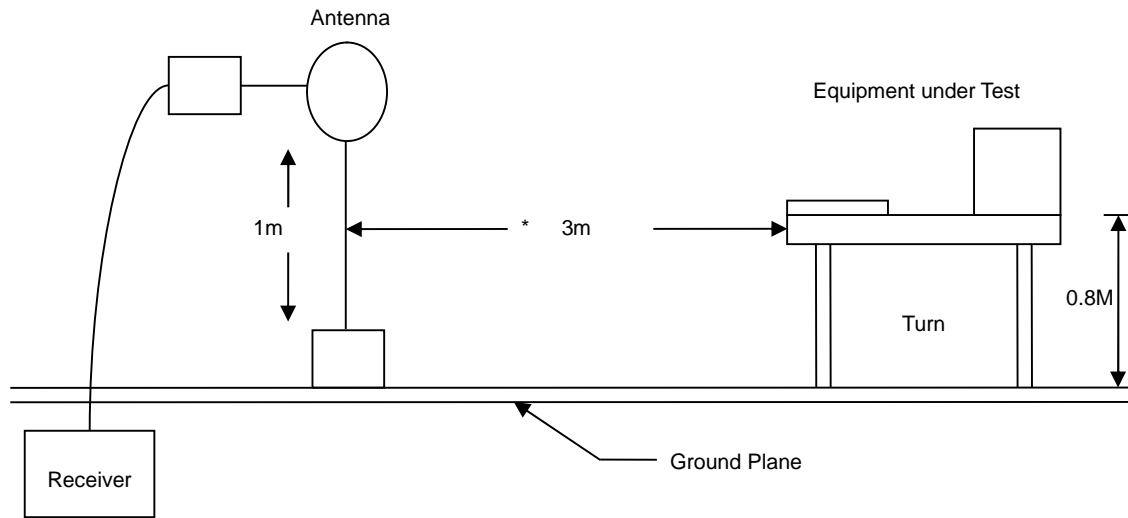

30MHz- 1GHz Test Setup

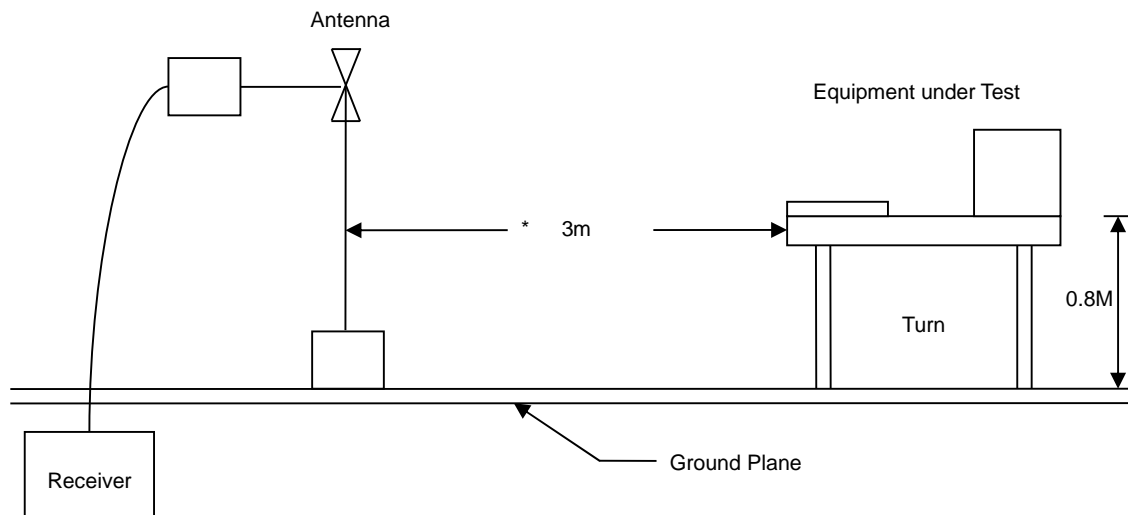

Above 1GHz Test Setup

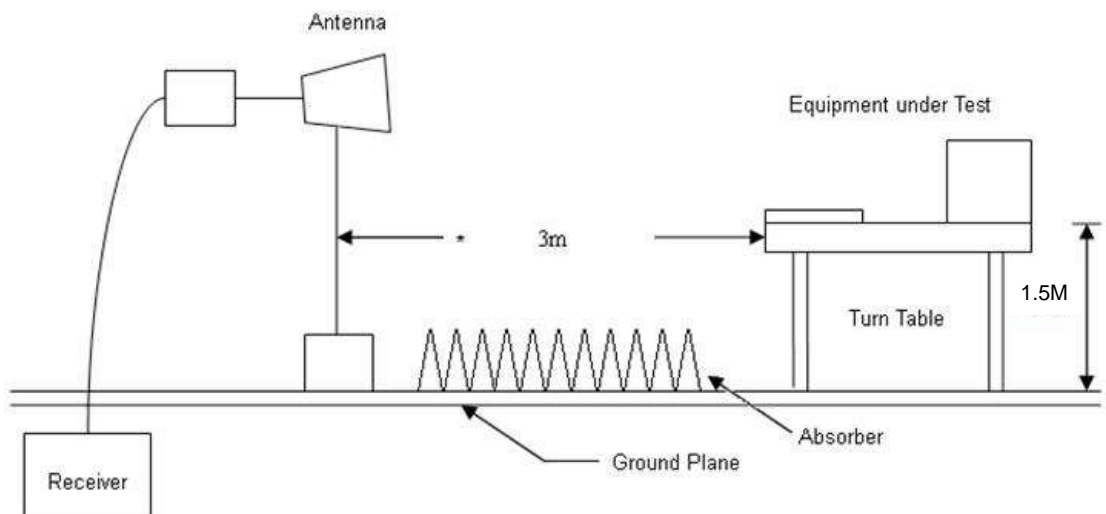



6.4. Test Result and Data (9kHz ~ 30MHz)

The 9kHz - 30MHz spurious emission is under limit 20dB more.

6.5. Test Result and Data (30MHz ~ 1GHz)

Power	: PoE	Pol/Phase	: VERTICAL
Test Mode	: Mode 1	Temperature	: 25 °C
Test Date	: Jul. 26, 2017	Humidity	: 60 %

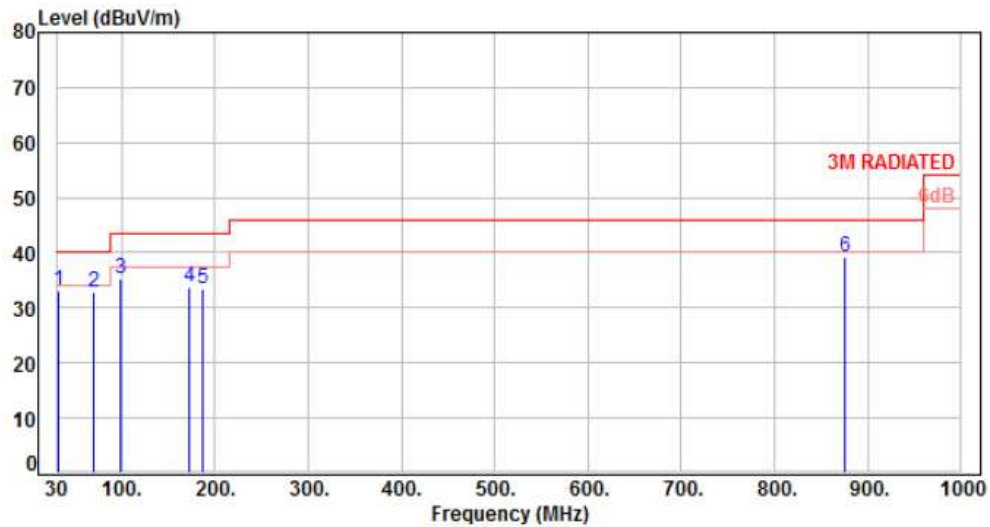

No.	Frequency (MHz)	Factor (dB)	Reading (dBuV)	Level (dBuV)	Limit (dBuV)	Margin (dB)	Detector	Height (cm)	Azimuth (deg)	P/F
1	31.94	-10.76	43.86	33.10	40.00	-6.90	QP	100	189	P
2	70.74	-12.16	45.14	32.98	40.00	-7.02	QP	100	184	P
3	97.90	-15.05	50.27	35.22	43.50	-8.28	Peak	100	0	P
4	171.62	-10.27	44.10	33.83	43.50	-9.67	Peak	100	0	P
5	187.14	-11.85	45.43	33.58	43.50	-9.92	Peak	100	0	P
6	875.84	2.17	36.95	39.12	46.00	-6.88	Peak	100	0	P

Note: Level=Reading+Factor
Margin=Level-Limit
Factor=Antenna Factor + cable loss - Amplifier Factor



Power	: PoE	Pol/Phase	: HORIZONTAL
Test Mode	: Mode 1	Temperature	: 25 °C
Test Date	: Jul. 26, 2017	Humidity	: 60 %

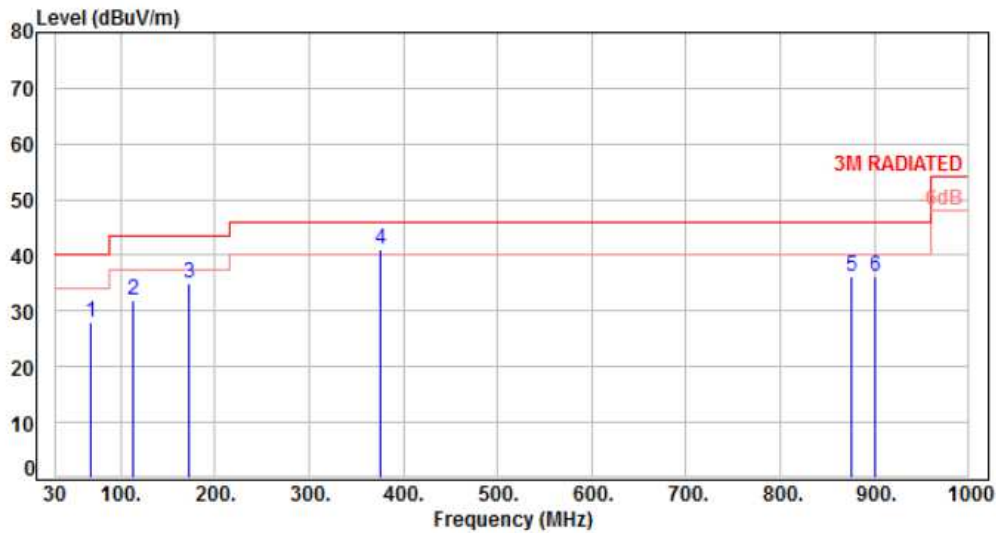

No.	Frequency (MHz)	Factor (dB)	Reading (dBuV)	Level (dBuV)	Limit (dBuV)	Margin (dB)	Detector	Height (cm)	Azimuth (deg)	P/F
1	68.80	-11.82	39.84	28.02	40.00	-11.98	Peak	100	0	P
2	113.42	-12.57	44.43	31.86	43.50	-11.64	Peak	100	0	P
3	171.62	-10.27	45.34	35.07	43.50	-8.43	Peak	100	0	P
4	375.32	-6.92	47.84	40.92	46.00	-5.08	Peak	100	0	P
5	875.84	2.17	33.91	36.08	46.00	-9.92	Peak	100	0	P
6	901.06	2.37	33.83	36.20	46.00	-9.80	Peak	100	0	P

Note: Level=Reading+Factor
Margin=Level-Limit
Factor=Antenna Factor + cable loss - Amplifier Factor



6.6. Test Result and Data (1GHz ~ 40GHz)

Power	: PoE	Pol/Phase	: VERTICAL
Test Mode	: Mode 1, CH36	Temperature	: 25°C
Test Date	: Jul. 20, 2017	Humidity	: 60%

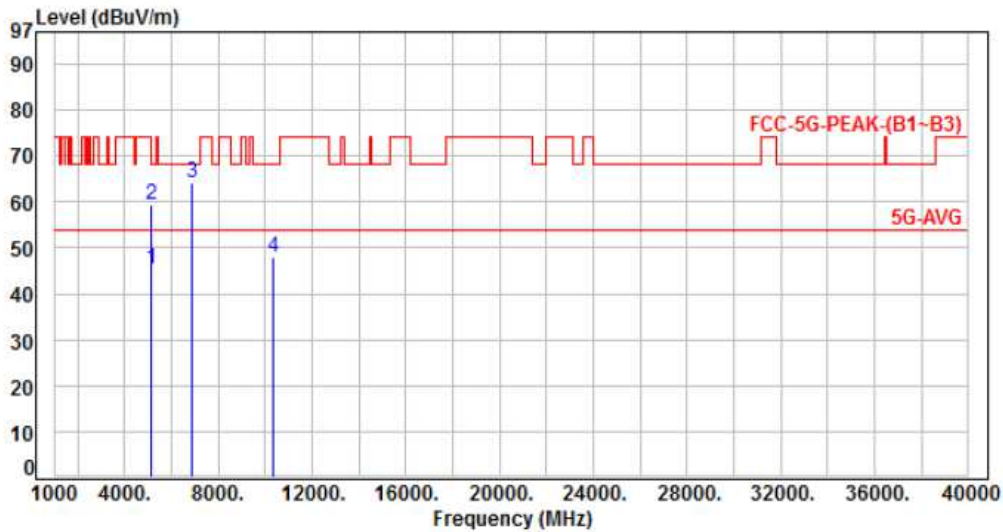

No.	Frequency (MHz)	Factor (dB)	Reading (dBuV)	Level (dBuV)	Limit (dBuV)	Margin (dB)	Detector	Height (cm)	Azimuth (deg)	P/F
1	5150.00	-12.71	57.93	45.22	54.00	-8.78	Average	222	308	P
2	5150.00	-12.71	71.93	59.22	74.00	-14.78	Peak	222	308	P
3	6906.00	-11.14	75.35	64.21	68.20	-3.99	Peak	203	12	P
4	10360.00	-7.44	55.57	48.13	68.20	-20.07	Peak	125	156	P

Note: Level=Reading+Factor
Margin=Level-Limit
Factor=Antenna Factor + cable loss - Amplifier Factor



Power	: PoE	Pol/Phase	: HORIZONTAL
Test Mode	: Mode 1, CH36	Temperature	: 25°C
Test Date	: Jul. 20, 2017	Humidity	: 60%

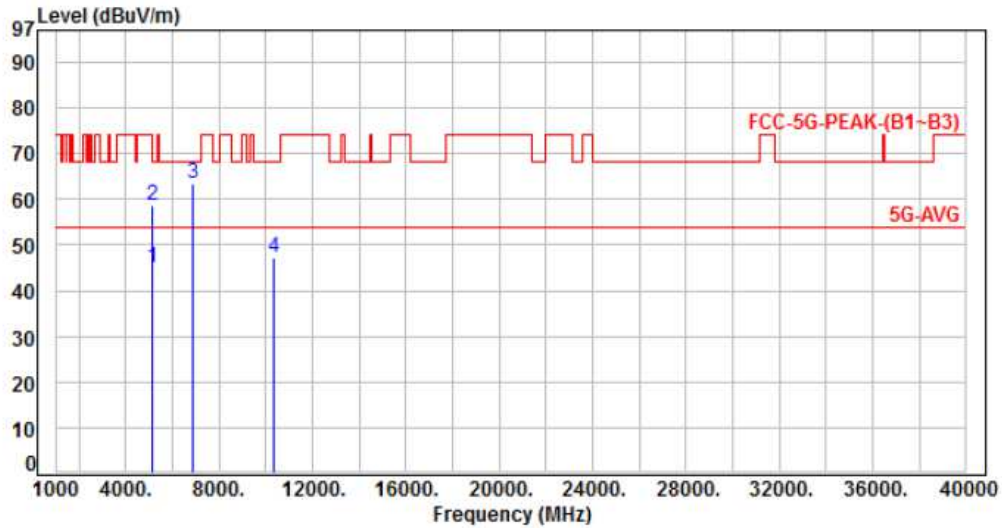

No.	Frequency (MHz)	Factor (dB)	Reading (dBuV)	Level (dBuV)	Limit (dBuV)	Margin (dB)	Detector	Height (cm)	Azimuth (deg)	P/F
1	5150.00	-12.71	57.70	44.99	54.00	-9.01	Average	225	358	P
2	5150.00	-12.71	71.51	58.80	74.00	-15.20	Peak	225	358	P
3	6906.00	-11.14	74.75	63.61	68.20	-4.59	Peak	136	345	P
4	10360.00	-7.44	54.60	47.16	68.20	-21.04	Peak	155	49	P

Note: Level=Reading+Factor
Margin=Level-Limit
Factor=Antenna Factor + cable loss - Amplifier Factor



Power	: PoE	Pol/Phase	: VERTICAL
Test Mode	: Mode 1, CH44	Temperature	: 25°C
Test Date	: Jul. 20, 2017	Humidity	: 60%

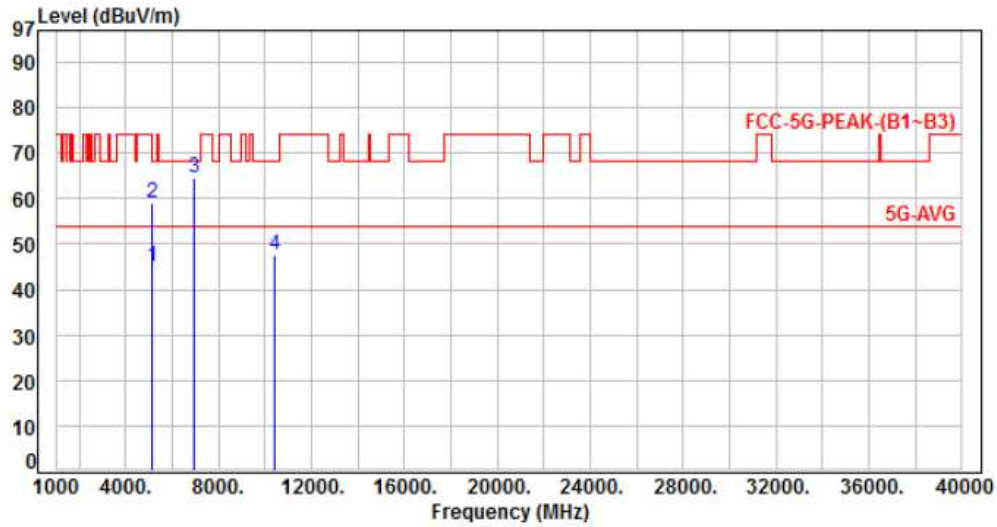

No.	Frequency (MHz)	Factor (dB)	Reading (dBuV)	Level (dBuV)	Limit (dBuV)	Margin (dB)	Detector	Height (cm)	Azimuth (deg)	P/F
1	5150.00	-12.71	57.86	45.15	54.00	-8.85	Average	248	317	P
2	5150.00	-12.71	71.77	59.06	74.00	-14.94	Peak	248	317	P
3	6960.00	-11.03	75.66	64.63	68.20	-3.57	Peak	202	11	P
4	10440.00	-7.43	54.92	47.49	68.20	-20.71	Peak	212	337	P

Note: Level=Reading+Factor
 Margin=Level-Limit
 Factor=Antenna Factor + cable loss - Amplifier Factor



Power	: PoE	Pol/Phase	: HORIZONTAL
Test Mode	: Mode 1, CH44	Temperature	: 25°C
Test Date	: Jul. 20, 2017	Humidity	: 60%

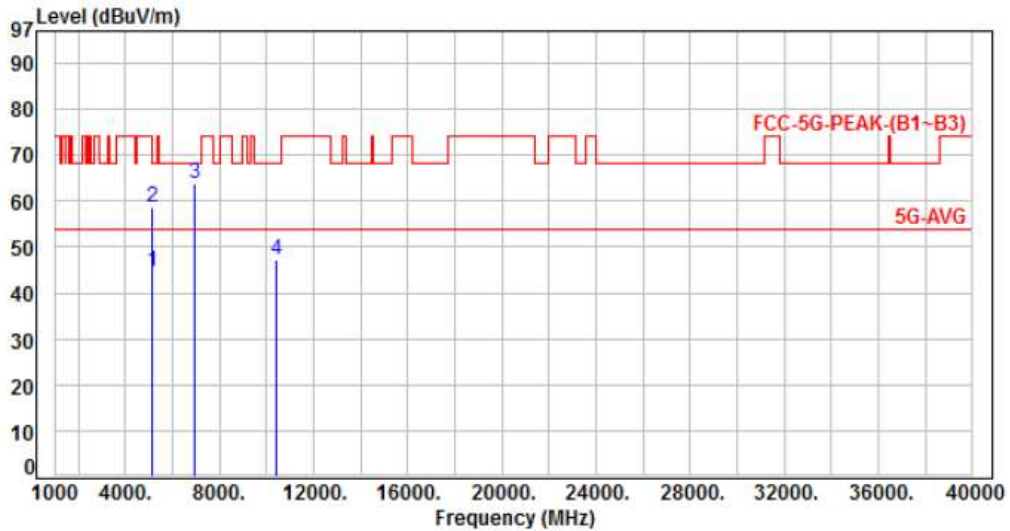

No.	Frequency (MHz)	Factor (dB)	Reading (dBuV)	Level (dBuV)	Limit (dBuV)	Margin (dB)	Detector	Height (cm)	Azimuth (deg)	P/F
1	5150.00	-12.71	57.43	44.72	54.00	-9.28	Average	169	83	P
2	5150.00	-12.71	71.33	58.62	74.00	-15.38	Peak	169	83	P
3	6960.00	-11.03	74.94	63.91	68.20	-4.29	Peak	138	344	P
4	10440.00	-7.43	54.54	47.11	68.20	-21.09	Peak	168	102	P

Note: Level=Reading+Factor
 Margin=Level-Limit
 Factor=Antenna Factor + cable loss - Amplifier Factor



Power	:	PoE	Pol/Phase	:	VERTICAL
Test Mode	:	Mode 1, CH48	Temperature	:	25°C
Test Date	:	Jul. 20, 2017	Humidity	:	60%

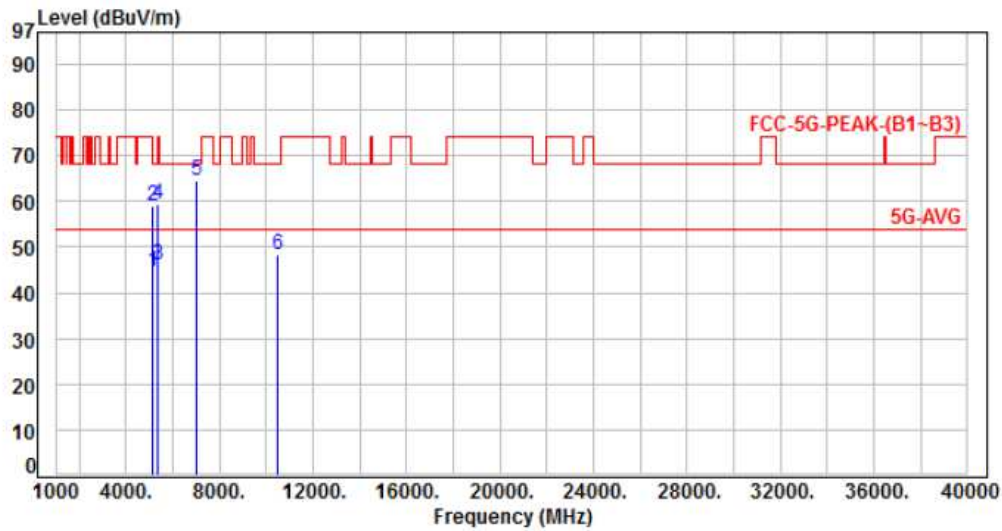

No.	Frequency (MHz)	Factor (dB)	Reading (dBuV)	Level (dBuV)	Limit (dBuV)	Margin (dB)	Detector	Height (cm)	Azimuth (deg)	P/F
1	5150.00	-12.71	57.20	44.49	54.00	-9.51	Average	127	325	P
2	5150.00	-12.71	71.77	59.06	74.00	-14.94	Peak	127	325	P
3	5350.00	-12.32	58.24	45.92	54.00	-8.08	Average	129	302	P
4	5350.00	-12.32	71.67	59.35	74.00	-14.65	Peak	129	302	P
5	6986.66	-10.98	75.68	64.70	68.20	-3.50	Peak	200	16	P
6	10480.00	-7.42	55.73	48.31	68.20	-19.89	Peak	139	298	P

Note: Level=Reading+Factor
 Margin=Level-Limit
 Factor=Antenna Factor + cable loss - Amplifier Factor



Power	: PoE	Pol/Phase	: HORIZONTAL
Test Mode	: Mode 1, CH48	Temperature	: 25°C
Test Date	: Jul. 20, 2017	Humidity	: 60%

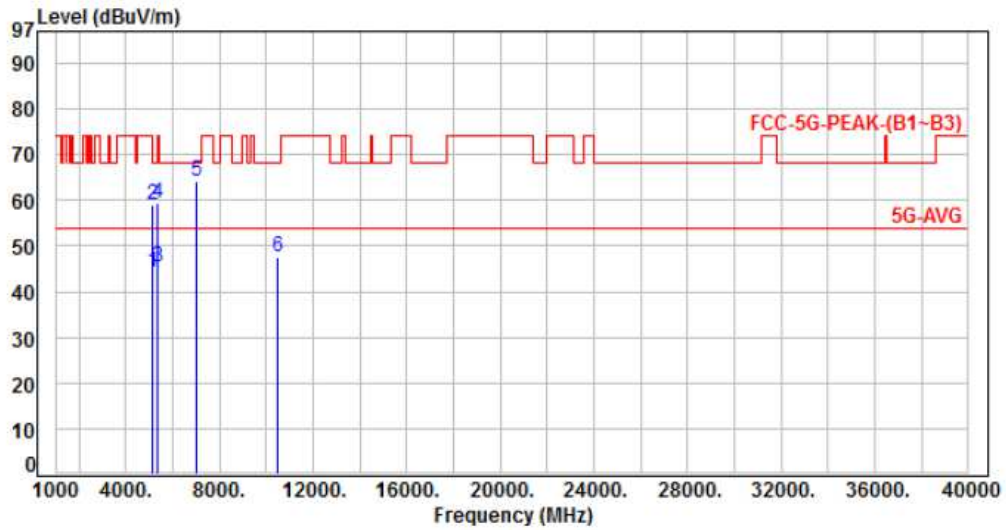

No.	Frequency (MHz)	Factor (dB)	Reading (dBuV)	Level (dBuV)	Limit (dBuV)	Margin (dB)	Detector	Height (cm)	Azimuth (deg)	P/F
1	5150.00	-12.71	57.13	44.42	54.00	-9.58	Average	269	255	P
2	5150.00	-12.71	71.54	58.83	74.00	-15.17	Peak	269	255	P
3	5350.00	-12.32	57.67	45.35	54.00	-8.65	Average	248	232	P
4	5350.00	-12.32	71.86	59.54	74.00	-14.46	Peak	248	232	P
5	6986.66	-10.98	75.08	64.10	68.20	-4.10	Peak	129	341	P
6	10480.00	-7.42	55.09	47.67	68.20	-20.53	Peak	278	136	P

Note: Level=Reading+Factor
 Margin=Level-Limit
 Factor=Antenna Factor + cable loss - Amplifier Factor



Power	: PoE	Pol/Phase	: VERTICAL
Test Mode	: Mode 4, CH36	Temperature	: 25°C
Test Date	: Jul. 20, 2017	Humidity	: 60%

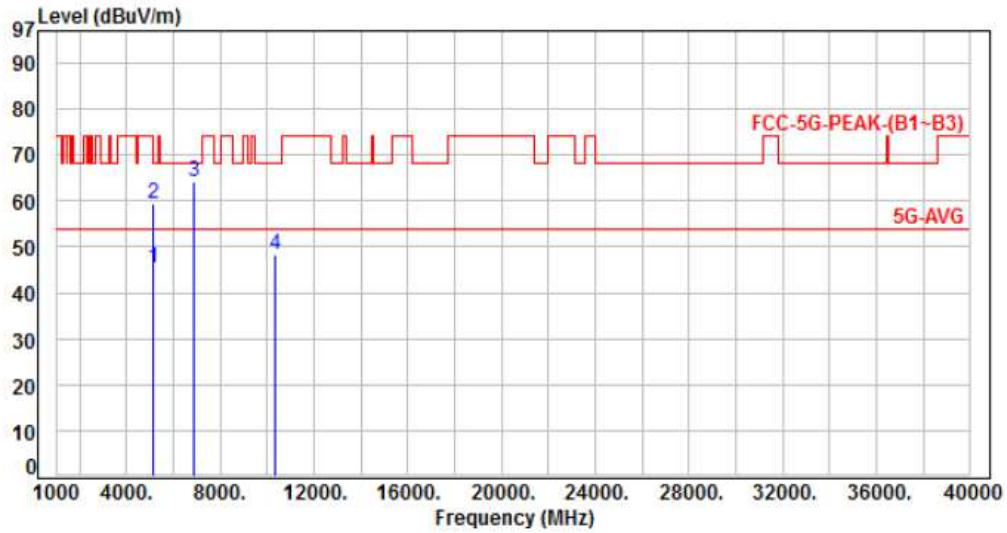

No.	Frequency (MHz)	Factor (dB)	Reading (dBuV)	Level (dBuV)	Limit (dBuV)	Margin (dB)	Detector	Height (cm)	Azimuth (deg)	P/F
1	5150.00	-12.71	58.11	45.40	54.00	-8.60	Average	218	312	P
2	5150.00	-12.71	71.99	59.28	74.00	-14.72	Peak	218	312	P
3	6906.00	-11.14	75.47	64.33	68.20	-3.87	Peak	202	11	P
4	10360.00	-7.44	55.78	48.34	68.20	-19.86	Peak	129	163	P

Note: Level=Reading+Factor
 Margin=Level-Limit
 Factor=Antenna Factor + cable loss - Amplifier Factor



Power	: PoE	Pol/Phase	: HORIZONTAL
Test Mode	: Mode 4, CH36	Temperature	: 25°C
Test Date	: Jul. 20, 2017	Humidity	: 60%

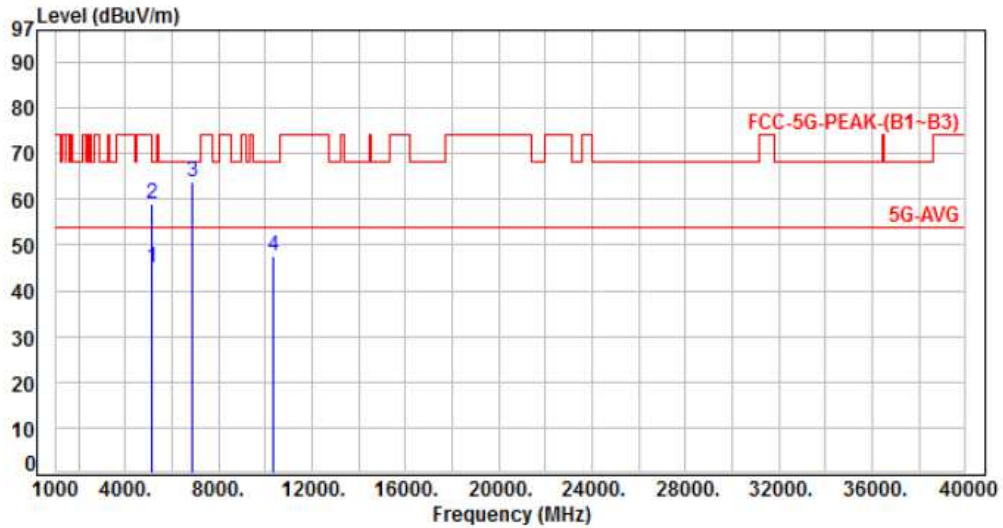

No.	Frequency (MHz)	Factor (dB)	Reading (dBuV)	Level (dBuV)	Limit (dBuV)	Margin (dB)	Detector	Height (cm)	Azimuth (deg)	P/F
1	5150.00	-12.71	57.86	45.15	54.00	-8.85	Average	224	351	P
2	5150.00	-12.71	71.72	59.01	74.00	-14.99	Peak	224	351	P
3	6906.00	-11.14	74.92	63.78	68.20	-4.42	Peak	144	339	P
4	10360.00	-7.44	54.85	47.41	68.20	-20.79	Peak	154	52	P

Note: Level=Reading+Factor
Margin=Level-Limit
Factor=Antenna Factor + cable loss - Amplifier Factor



Power	: PoE	Pol/Phase	: VERTICAL
Test Mode	: Mode 4, CH44	Temperature	: 25°C
Test Date	: Jul. 20, 2017	Humidity	: 60%

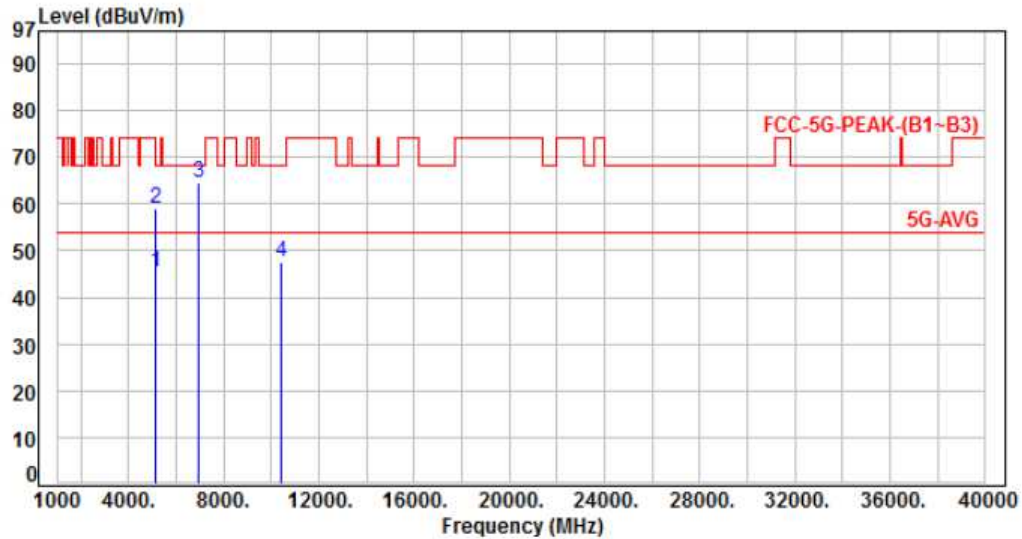

No.	Frequency (MHz)	Factor (dB)	Reading (dBuV)	Level (dBuV)	Limit (dBuV)	Margin (dB)	Detector	Height (cm)	Azimuth (deg)	P/F
1	5150.00	-12.71	57.97	45.26	54.00	-8.74	Average	246	312	P
2	5150.00	-12.71	71.86	59.15	74.00	-14.85	Peak	246	312	P
3	6960.00	-11.03	75.49	64.46	68.20	-3.74	Peak	204	13	P
4	10440.00	-7.43	55.12	47.69	68.20	-20.51	Peak	213	335	P

Note: Level=Reading+Factor
 Margin=Level-Limit
 Factor=Antenna Factor + cable loss - Amplifier Factor



Power	: PoE	Pol/Phase	: HORIZONTAL
Test Mode	: Mode 4, CH44	Temperature	: 25°C
Test Date	: Jul. 20, 2017	Humidity	: 60%

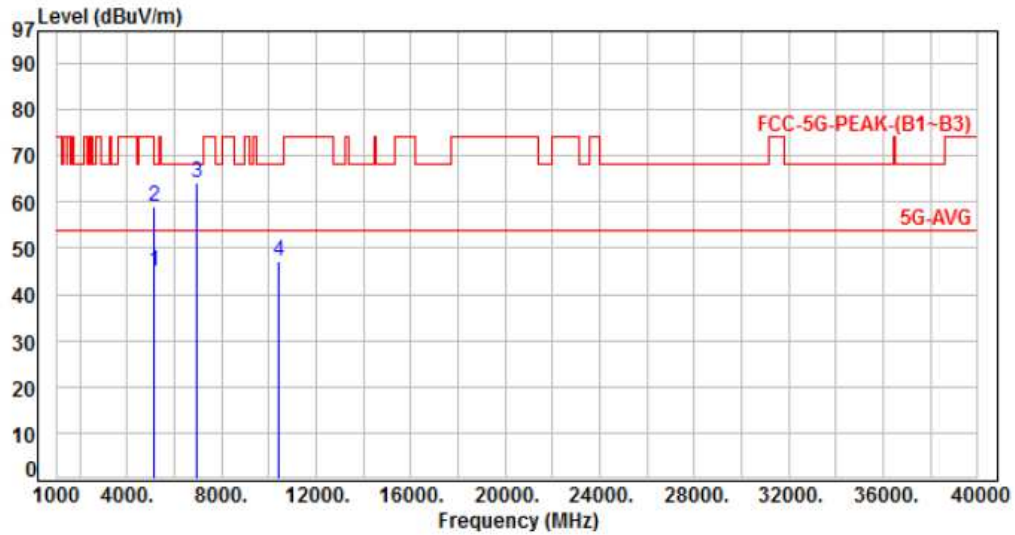

No.	Frequency (MHz)	Factor (dB)	Reading (dBuV)	Level (dBuV)	Limit (dBuV)	Margin (dB)	Detector	Height (cm)	Azimuth (deg)	P/F
1	5150.00	-12.71	57.68	44.97	54.00	-9.03	Average	172	86	P
2	5150.00	-12.71	71.76	59.05	74.00	-14.95	Peak	172	86	P
3	6960.00	-11.03	75.31	64.28	68.20	-3.92	Peak	136	343	P
4	10440.00	-7.43	54.77	47.34	68.20	-20.86	Peak	163	112	P

Note: Level=Reading+Factor
Margin=Level-Limit
Factor=Antenna Factor + cable loss - Amplifier Factor



Power	: PoE	Pol/Phase	: VERTICAL
Test Mode	: Mode 4, CH48	Temperature	: 25°C
Test Date	: Jul. 20, 2017	Humidity	: 60%

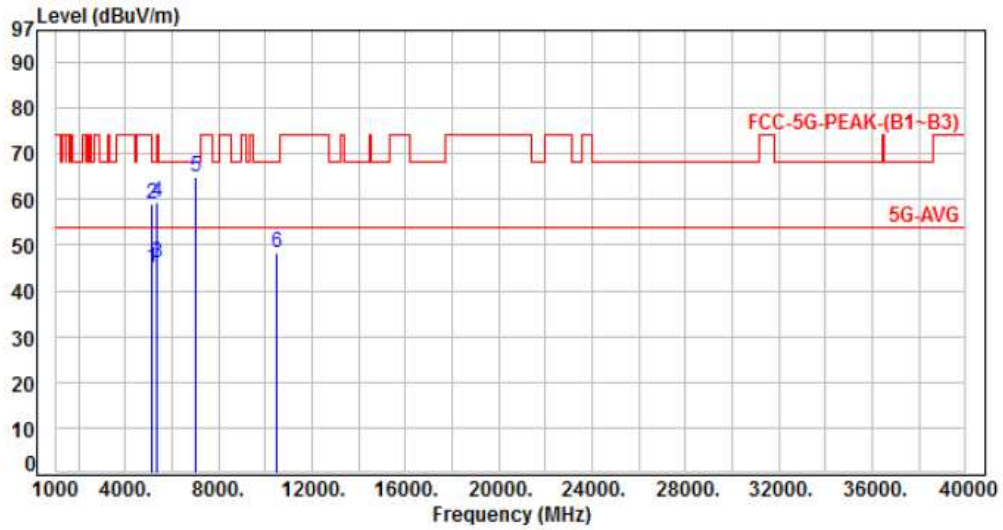

No.	Frequency (MHz)	Factor (dB)	Reading (dBuV)	Level (dBuV)	Limit (dBuV)	Margin (dB)	Detector	Height (cm)	Azimuth (deg)	P/F
1	5150.00	-12.71	57.62	44.91	54.00	-9.09	Average	126	331	P
2	5150.00	-12.71	71.88	59.17	74.00	-14.83	Peak	126	331	P
3	5350.00	-12.32	58.56	46.24	54.00	-7.76	Average	135	318	P
4	5350.00	-12.32	71.83	59.51	74.00	-14.49	Peak	135	318	P
5	6986.66	-10.98	75.92	64.94	68.20	-3.26	Peak	198	15	P
6	10480.00	-7.42	55.91	48.49	68.20	-19.71	Peak	142	299	P

Note: Level=Reading+Factor
Margin=Level-Limit
Factor=Antenna Factor + cable loss - Amplifier Factor



Power	: PoE	Pol/Phase	: HORIZONTAL
Test Mode	: Mode 4, CH48	Temperature	: 25°C
Test Date	: Jul. 20, 2017	Humidity	: 60%

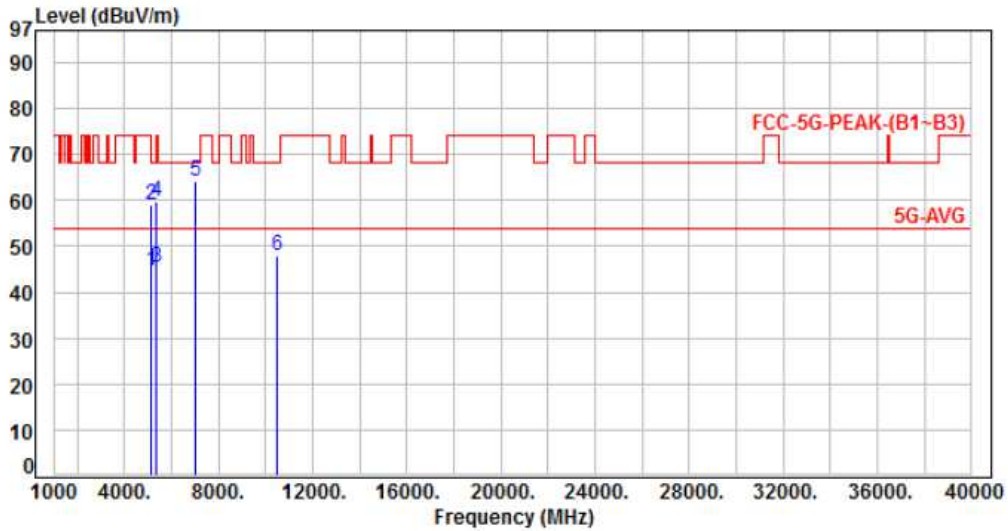

No.	Frequency (MHz)	Factor (dB)	Reading (dBuV)	Level (dBuV)	Limit (dBuV)	Margin (dB)	Detector	Height (cm)	Azimuth (deg)	P/F
1	5150.00	-12.71	57.40	44.69	54.00	-9.31	Average	276	248	P
2	5150.00	-12.71	71.79	59.08	74.00	-14.92	Peak	276	248	P
3	5350.00	-12.32	57.81	45.49	54.00	-8.51	Average	244	219	P
4	5350.00	-12.32	72.24	59.92	74.00	-14.08	Peak	244	219	P
5	6986.66	-10.98	75.28	64.30	68.20	-3.90	Peak	126	338	P
6	10480.00	-7.42	55.37	47.95	68.20	-20.25	Peak	275	134	P

Note: Level=Reading+Factor
 Margin=Level-Limit
 Factor=Antenna Factor + cable loss - Amplifier Factor



Power	: PoE	Pol/Phase	: VERTICAL
Test Mode	: Mode 5, CH38	Temperature	: 25°C
Test Date	: Jul. 20, 2017	Humidity	: 60%

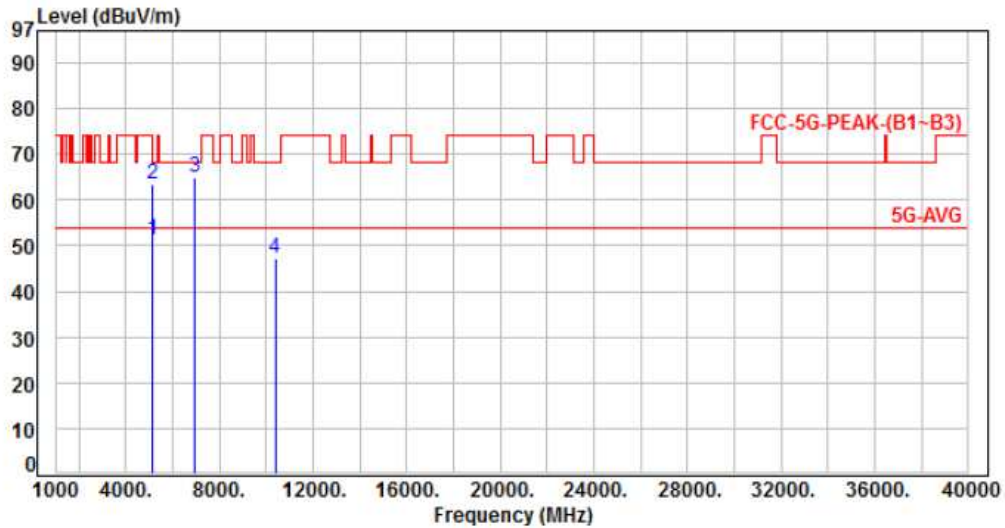

No.	Frequency (MHz)	Factor (dB)	Reading (dBuV)	Level (dBuV)	Limit (dBuV)	Margin (dB)	Detector	Height (cm)	Azimuth (deg)	P/F
1	5150.00	-12.71	63.87	51.16	54.00	-2.84	Average	104	324	P
2	5150.00	-12.71	76.32	63.61	74.00	-10.39	Peak	104	324	P
3	6920.00	-11.11	76.07	64.96	68.20	-3.24	Peak	203	12	P
4	10380.00	-7.43	54.70	47.27	68.20	-20.93	Peak	212	288	P

Note: Level=Reading+Factor
 Margin=Level-Limit
 Factor=Antenna Factor + cable loss - Amplifier Factor



Power	: PoE	Pol/Phase	: HORIZONTAL
Test Mode	: Mode 5, CH38	Temperature	: 25°C
Test Date	: Jul. 20, 2017	Humidity	: 60%

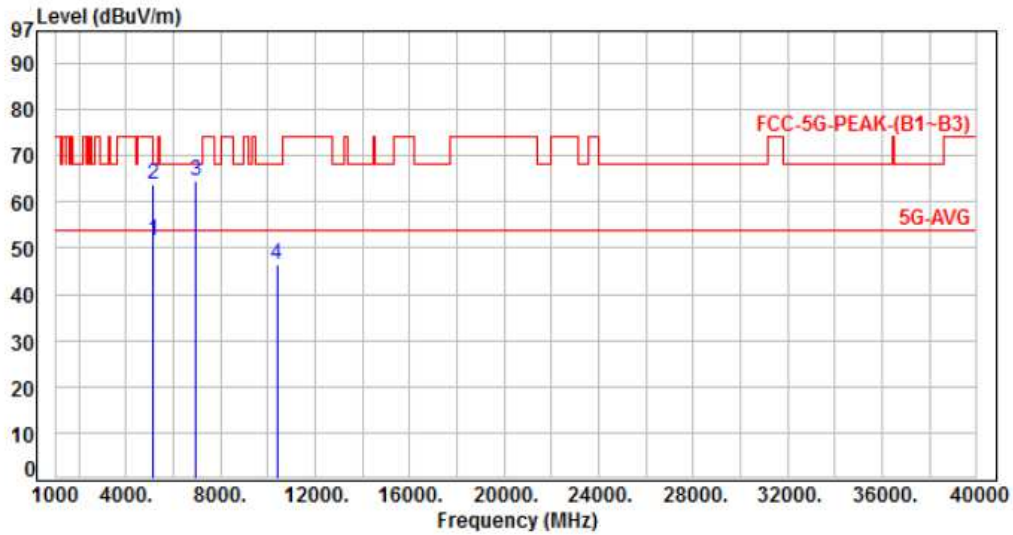

No.	Frequency (MHz)	Factor (dB)	Reading (dBuV)	Level (dBuV)	Limit (dBuV)	Margin (dB)	Detector	Height (cm)	Azimuth (deg)	P/F
1	5150.00	-12.71	64.52	51.81	54.00	-2.19	Average	359	348	P
2	5150.00	-12.71	76.67	63.96	74.00	-10.04	Peak	359	348	P
3	6920.00	-11.11	75.59	64.48	68.20	-3.72	Peak	124	326	P
4	10380.00	-7.43	53.88	46.45	68.20	-21.75	Peak	182	341	P

Note: Level=Reading+Factor
 Margin=Level-Limit
 Factor=Antenna Factor + cable loss - Amplifier Factor



Power	: PoE	Pol/Phase	: VERTICAL
Test Mode	: Mode 5, CH46	Temperature	: 25°C
Test Date	: Jul. 20, 2017	Humidity	: 60%

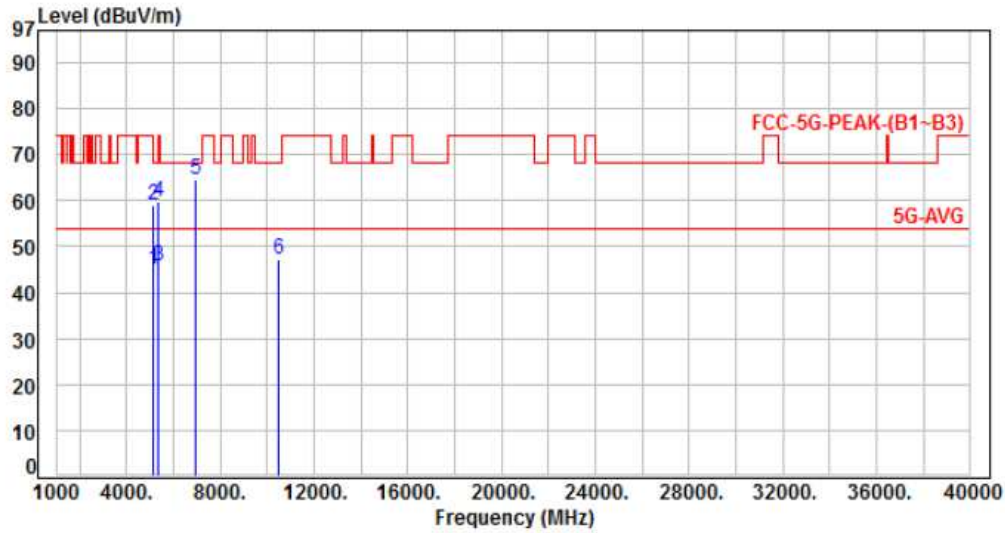

No.	Frequency (MHz)	Factor (dB)	Reading (dBuV)	Level (dBuV)	Limit (dBuV)	Margin (dB)	Detector	Height (cm)	Azimuth (deg)	P/F
1	5150.00	-12.71	57.87	45.16	54.00	-8.84	Average	208	249	P
2	5150.00	-12.71	71.79	59.08	74.00	-14.92	Peak	208	249	P
3	5350.00	-12.32	58.24	45.92	54.00	-8.08	Average	216	255	P
4	5350.00	-12.32	72.02	59.70	74.00	-14.30	Peak	216	255	P
5	6973.33	-11.00	75.62	64.62	68.20	-3.58	Peak	216	24	P
6	10460.00	-7.42	54.60	47.18	68.20	-21.02	Peak	198	212	P

Note: Level=Reading+Factor
 Margin=Level-Limit
 Factor=Antenna Factor + cable loss - Amplifier Factor



Power	: PoE	Pol/Phase	: HORIZONTAL
Test Mode	: Mode 5, CH46	Temperature	: 25°C
Test Date	: Jul. 20, 2017	Humidity	: 60%

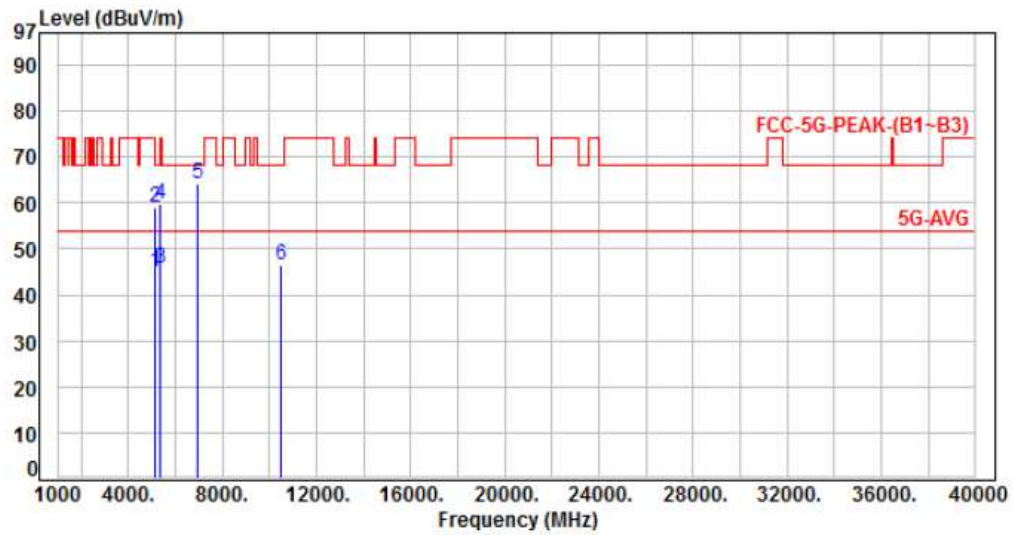

No.	Frequency (MHz)	Factor (dB)	Reading (dBuV)	Level (dBuV)	Limit (dBuV)	Margin (dB)	Detector	Height (cm)	Azimuth (deg)	P/F
1	5150.00	-12.71	57.69	44.98	54.00	-9.02	Average	168	354	P
2	5150.00	-12.71	71.78	59.07	74.00	-14.93	Peak	168	354	P
3	5350.00	-12.32	58.02	45.70	54.00	-8.30	Average	159	351	P
4	5350.00	-12.32	71.88	59.56	74.00	-14.44	Peak	159	351	P
5	6973.33	-11.00	75.22	64.22	68.20	-3.98	Peak	127	329	P
6	10460.00	-7.42	53.86	46.44	68.20	-21.76	Peak	100	289	P

Note: Level=Reading+Factor
 Margin=Level-Limit
 Factor=Antenna Factor + cable loss - Amplifier Factor



Power	: PoE	Pol/Phase	: VERTICAL
Test Mode	: Mode 6, CH42	Temperature	: 25°C
Test Date	: Jul. 20, 2017	Humidity	: 60%

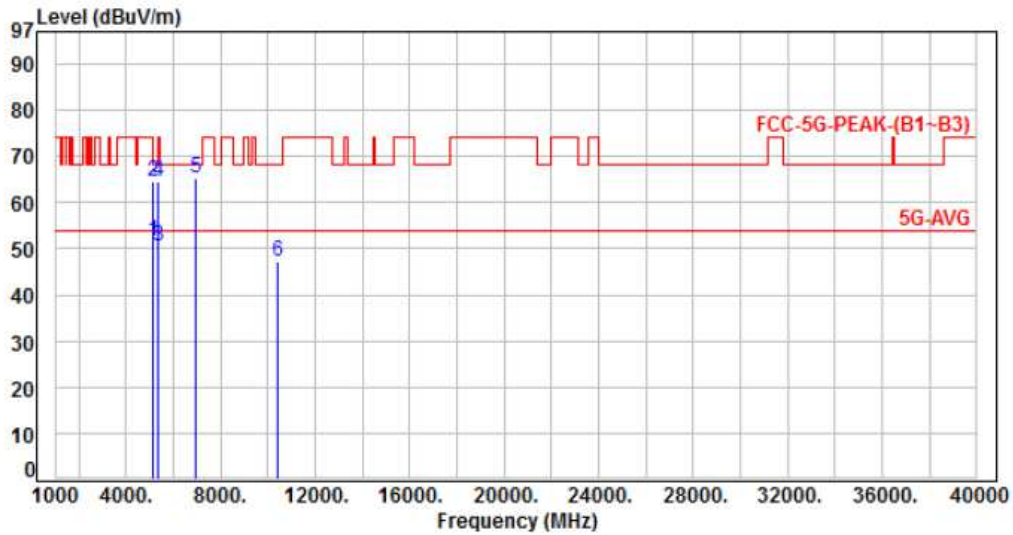

No.	Frequency (MHz)	Factor (dB)	Reading (dBuV)	Level (dBuV)	Limit (dBuV)	Margin (dB)	Detector	Height (cm)	Azimuth (deg)	P/F
1	5150.00	-12.71	64.36	51.65	54.00	-2.35	Average	100	316	P
2	5150.00	-12.71	77.39	64.68	74.00	-9.32	Peak	100	316	P
3	5350.00	-12.32	62.72	50.40	54.00	-3.60	Average	137	288	P
4	5350.00	-12.32	76.89	64.57	74.00	-9.43	Peak	137	288	P
5	6946.66	-11.06	76.45	65.39	68.20	-2.81	Peak	266	231	P
6	10420.00	-7.44	54.77	47.33	68.20	-20.87	Peak	102	322	P

Note: Level=Reading+Factor
 Margin=Level-Limit
 Factor=Antenna Factor + cable loss - Amplifier Factor



Power	: PoE	Pol/Phase	: HORIZONTAL
Test Mode	: Mode 6, CH42	Temperature	: 25°C
Test Date	: Jul. 20, 2017	Humidity	: 60%

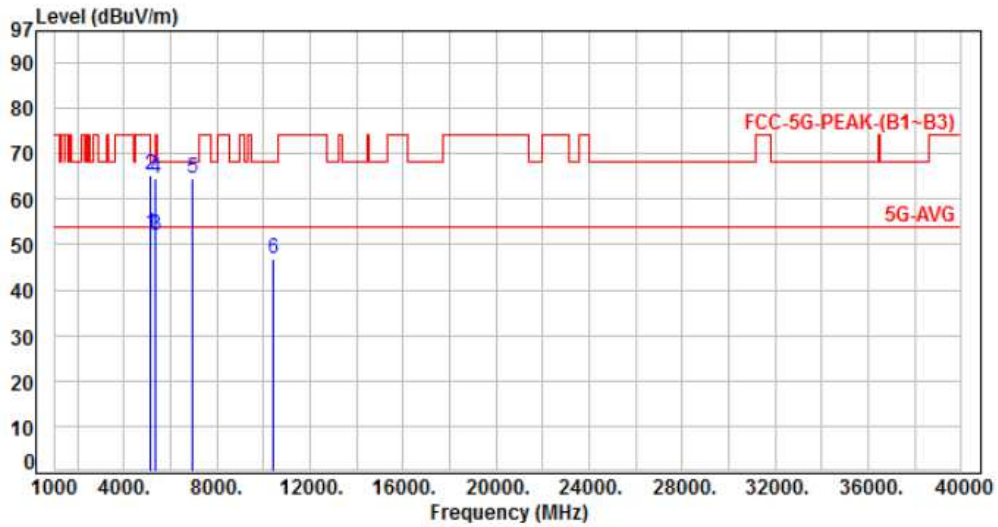

No.	Frequency (MHz)	Factor (dB)	Reading (dBuV)	Level (dBuV)	Limit (dBuV)	Margin (dB)	Detector	Height (cm)	Azimuth (deg)	P/F
1	5150.00	-12.71	65.17	52.46	54.00	-1.54	Average	204	358	P
2	5150.00	-12.71	77.97	65.26	74.00	-8.74	Peak	204	358	P
3	5350.00	-12.32	64.18	51.86	54.00	-2.14	Average	200	347	P
4	5350.00	-12.32	76.85	64.53	74.00	-9.47	Peak	200	347	P
5	6946.66	-11.06	75.70	64.64	68.20	-3.56	Peak	367	30	P
6	10420.00	-7.44	54.17	46.73	68.20	-21.47	Peak	193	82	P

Note: Level=Reading+Factor
Margin=Level-Limit
Factor=Antenna Factor + cable loss - Amplifier Factor



6.7. Restricted Bands of Operation

Only spurious emissions are permitted in any of the frequency bands listed below:

MHz	MHz	MHz	GHz
0.09000 – 0.11000	16.42000 – 16.42300	399.9 – 410.0	4.500 – 5.150
0.49500 – 0.505**	16.69475 – 16.69525	608.0 – 614.0	5.350 – 5.460
2.17350 – 2.19050	16.80425 – 16.80475	960.0 – 1240.0	7.250 – 7.750
4.12500 – 4.12800	25.50000 – 25.67000	1300.0 – 1427.0	8.025 – 8.500
4.17725 – 4.17775	37.50000 – 38.25000	1435.0 – 1626.5	9.000 – 9.200
4.20725 – 4.20775	73.00000 – 74.60000	1645.5 – 1646.5	9.300 – 9.500
6.21500 – 6.21800	74.80000 – 75.20000	1660.0 – 1710.0	10.600 – 12.700
6.26775 – 6.26825	108.00000 – 121.94000	1718.8 – 1722.2	13.250 – 13.400
6.31175 – 6.31225	123.00000 – 138.00000	2200.0 – 2300.0	14.470 – 14.500
8.29100 – 8.29400	149.90000 – 150.05000	2310.0 – 2390.0	15.350 – 16.200
8.36200 – 8.36600	156.52475 – 156.52525	2483.5 – 2500.0	17.700 – 21.400
8.37625 – 8.38675	156.70000 – 156.90000	2655.0 – 2900.0	22.010 – 23.120
8.41425 – 8.41475	162.01250 – 167.17000	3260.0 – 3267.0	23.600 – 24.000
12.29000 – 12.29300	167.72000 – 173.20000	3332.0 – 3339.0	31.200 – 31.800
12.51975 – 12.52025	240.00000 – 285.00000	3345.8 – 3358.0	36.430 – 36.500
12.57675 – 12.57725	322.00000 – 335.40000	3600.0 – 4400.0	Above 38.6
13.36000 – 13.41000			

** : Until February 1, 1999, this restricted band shall be 0.490-0.510 MHz



7. On Time, Duty Cycle and Measurement methods

7.1. Test Limit

None; for reporting purposes only.

7.2. Test Procedure

KDB 789033 Zero-Span Spectrum Analyzer Method.

7.3. Test Setup Layout

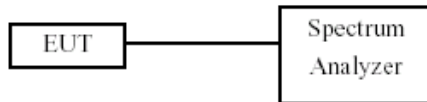

7.4. Test Result and Data

Temperature: 22°C

Humidity: 67%

Test Date: Jul. 27, 2017

Modulation Type	On Time (msec)	Period Time (msec)	Duty Cycle (%)	1/T Minimum VBW(Hz)	Duty Cycle correction Factor (dB)
802.11a	2.05	2.10	97.62%	487.80	0.10
802.11ac VHT20	1.93	1.98	97.47%	518.13	0.11
802.11ac VHT40	0.85	1.01	84.52%	1173.71	0.73
802.11ac VHT80	0.47	0.80	58.10%	2145.92	2.36

7.5. Measurement Methods

26 dB and 6dB Emission BW	KDB 789033 D02 v01, Section C
99% Occupied BW	KDB 789033 D02 v01, Section D
Conducted Output Power	KDB 789033 D02 v01, Section E.2.d and E.3.b (Method PM-G)
Power Spectral Density	KDB 789033 D02 v01, Section F
Unwanted emissions in restricted bands	KDB 789033 D02 v01, Sections G and H
Unwanted emissions in non-restricted bands	KDB 789033 D02 v01, Sections G and H



Modulation Standard: 802.11a (6Mbps)

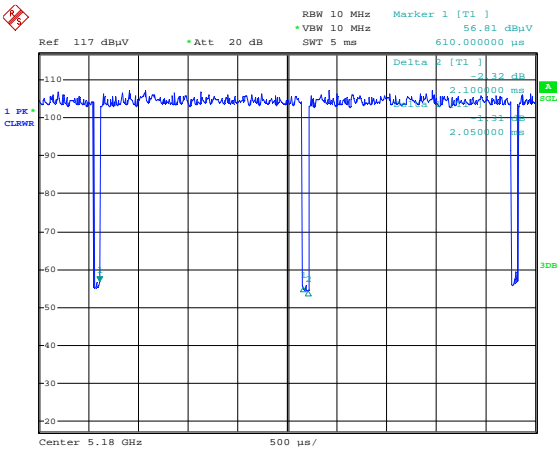

Modulation Standard: 802.11ac, VHT20 (6.5Mbps)

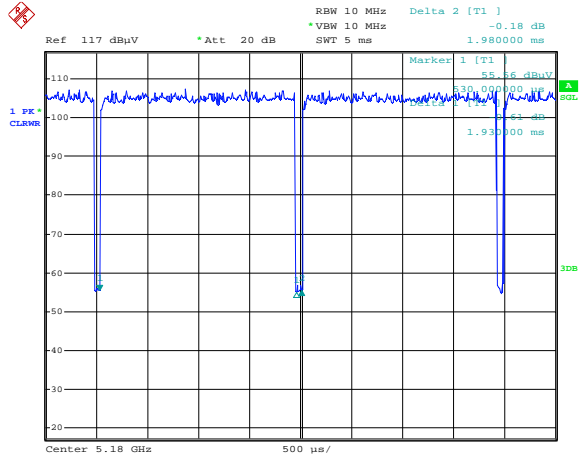

Modulation Standard: 802.11ac, VHT40 (13.5Mbps)

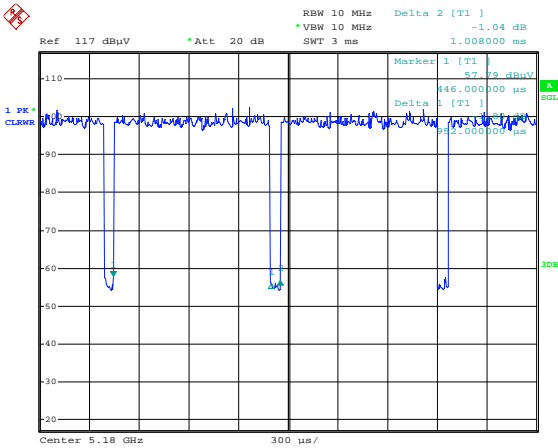

Modulation Standard: 802.11ac, VHT80 (29.3Mbps)

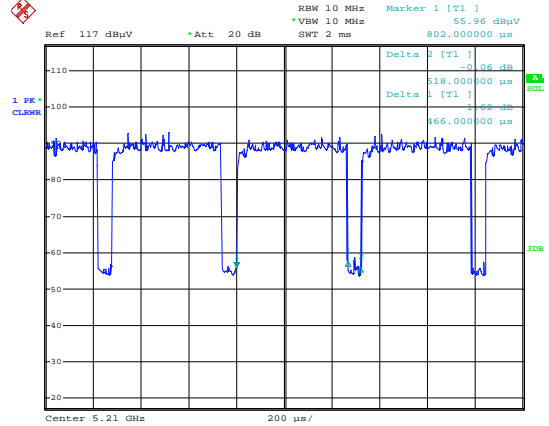



8. 26dB Bandwidth

8.1. Test Limit

None; for reporting purposes only.

8.2. Test Procedure

Reference to 789033 D02 General UNII Test Procedures New Rules v01: The transmitter output is connected to a spectrum analyzer with the RBW = approximately 1% of the emission bandwidth, the VBW >= 3 x RBW, peak detector and max hold.

8.3. Test Setup Layout

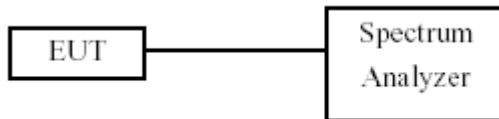

8.4. Test Result and Data

Temperature: 22°C

Humidity: 67%

Test Date: Jul. 27, 2017

In the 5.2G Band

Modulation Type	Channel	Frequency (MHz)	26dB Bandwidth (MHz)	
			ANT 1	ANT 2
802.11a	36	5180	22.20	21.90
	44	5220	21.70	21.80
	48	5240	22.50	22.00
802.11ac VHT20	36	5180	23.20	23.20
	44	5220	23.00	23.20
	48	5240	22.80	23.20
802.11ac VHT40	38	5190	46.60	46.00
	46	5230	46.80	45.60
802.11ac VHT80	42	5210	88.32	88.00



Antenna 1
Modulation Standard: 802.11a (6Mbps)
CH36

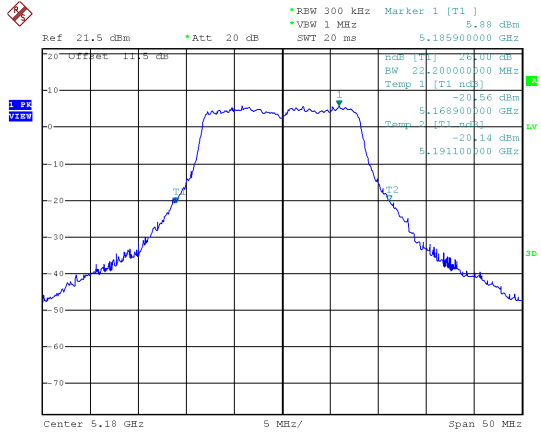

Modulation Standard: 802.11ac, VHT20 (6.5Mbps)
CH36

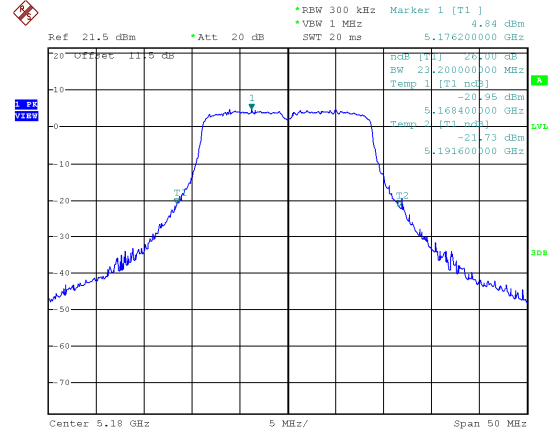

CH44

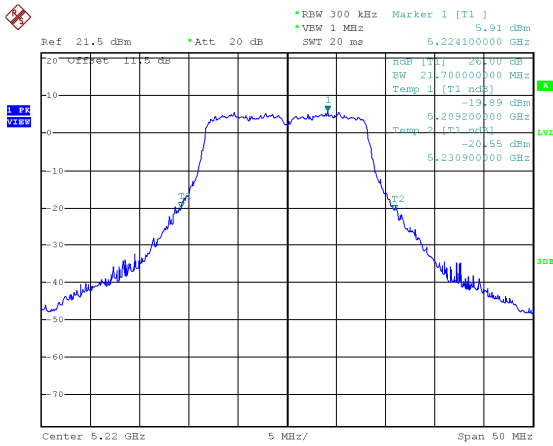

CH44

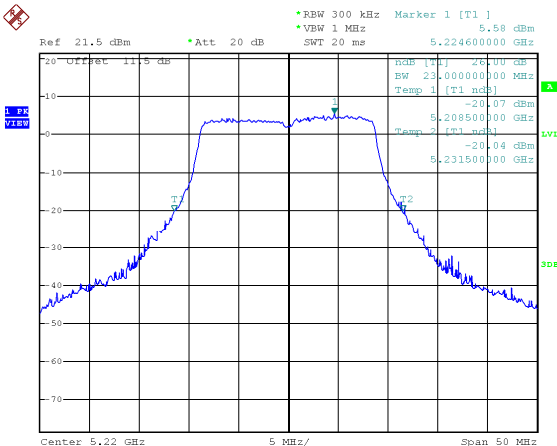

CH48

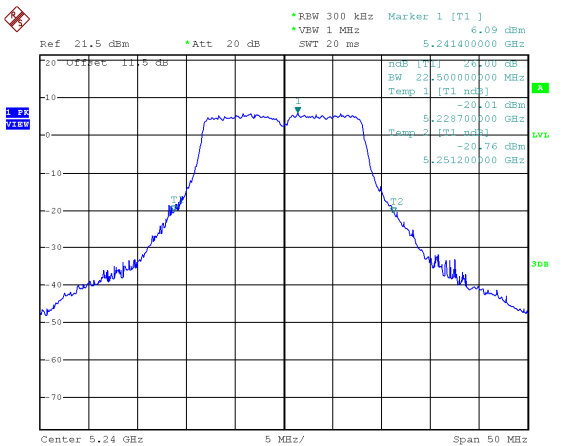

CH48

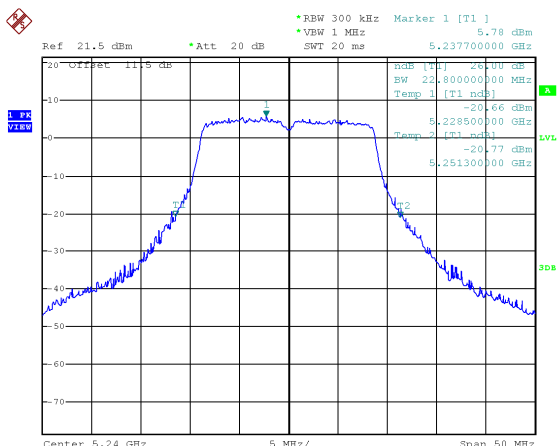



Antenna 1

Modulation Standard: 802.11ac, VHT40 (13.5Mbps) CH38

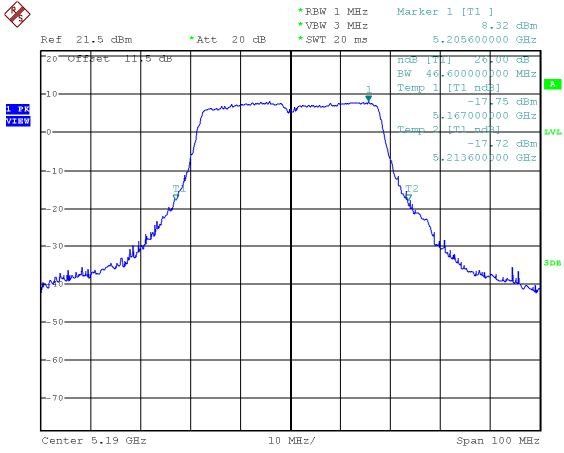

Modulation Standard: 802.11ac, VHT80 (29.3Mbps) CH42

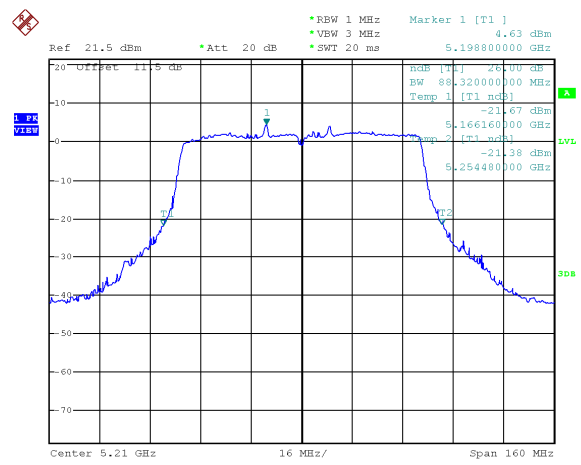

CH46

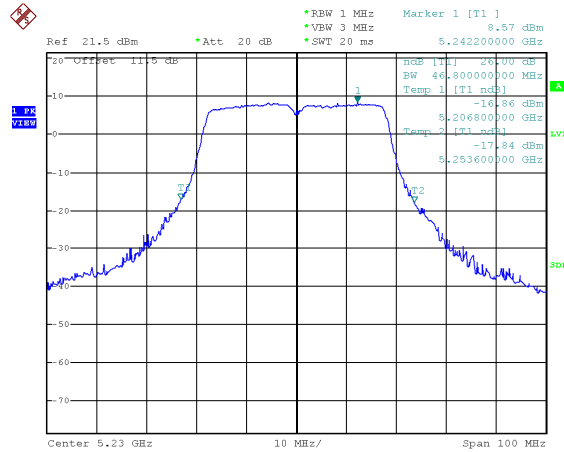



Antenna 2
Modulation Standard: 802.11a (6Mbps)
CH36

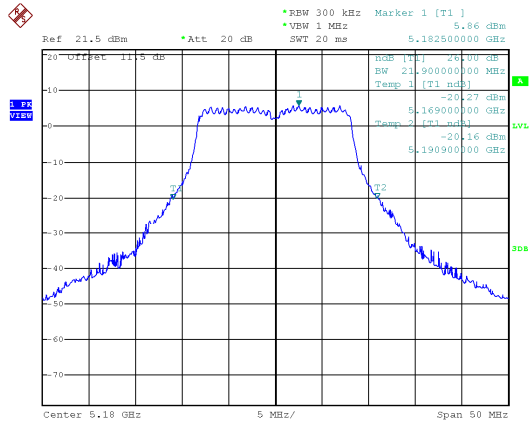

Modulation Standard: 802.11ac, VHT20 (6.5Mbps)
CH36

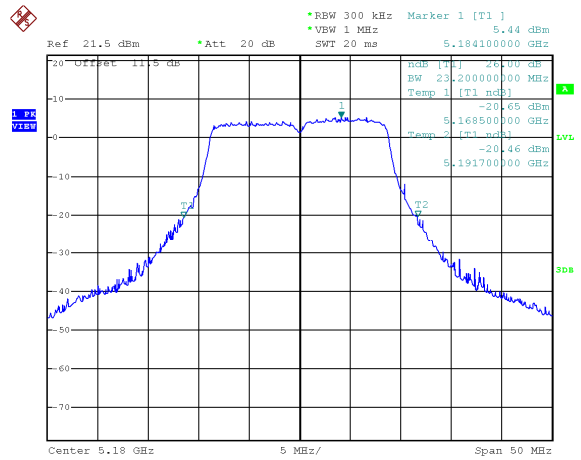

CH44

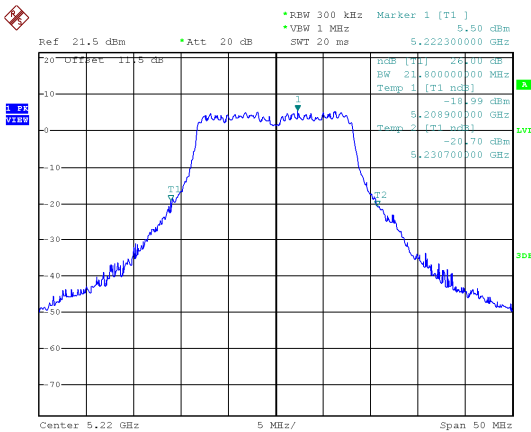

CH44

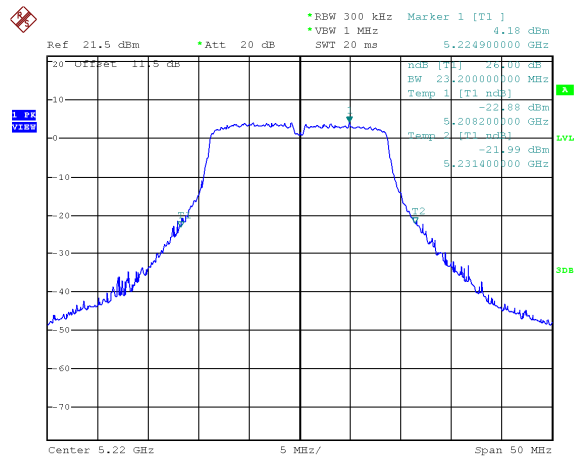

CH48

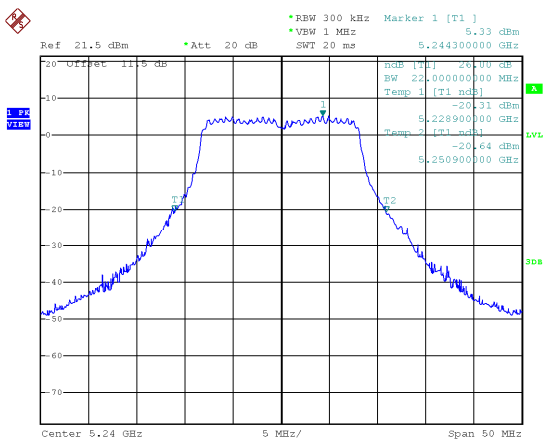

CH48

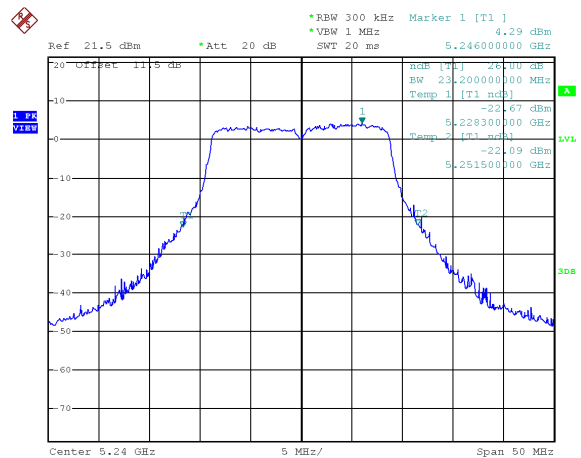



Antenna 2

Modulation Standard: 802.11ac, VHT40 (13.5Mbps) CH38

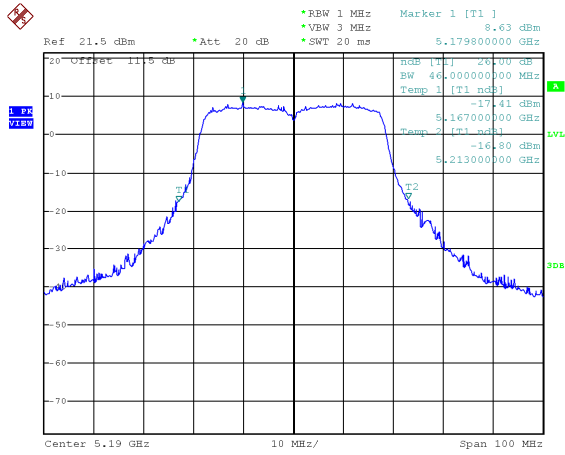

Modulation Standard: 802.11ac, VHT80 (29.3Mbps) CH42

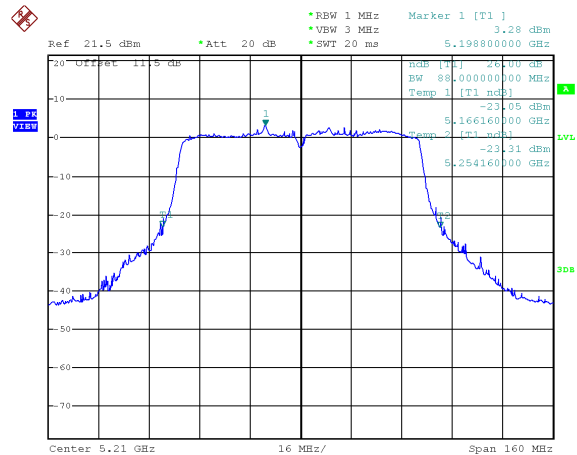

CH46

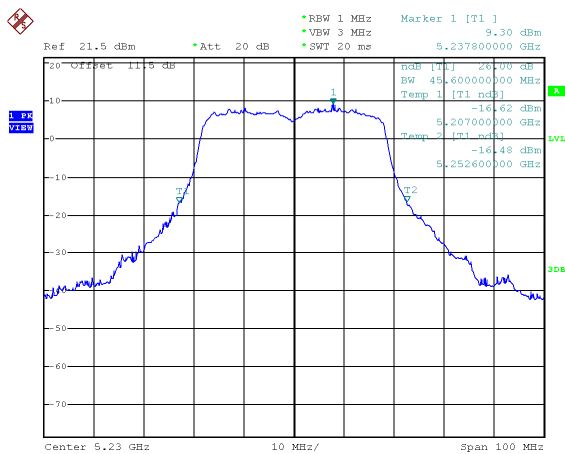



9. Average Power

9.1. Test Limit

For an outdoor access point operating in the band 5.15-5.25 GHz, the maximum conducted output power over the frequency band of operation shall not exceed 1 W provided the maximum antenna gain does not exceed 6 dBi. If transmitting antennas of directional gain greater than 6 dBi are used, both the maximum conducted output power and the maximum power spectral density shall be reduced by the amount in dB that the directional gain of the antenna exceeds 6 dBi. The maximum e.i.r.p. at any elevation angle above 30 degrees as measured from the horizon must not exceed 125 mW (21 dBm).

9.2. Test Procedure

The transmitter output is connected to a power meter.

The cable assembly insertion loss of 11 dB (including 10 dB pad and 1 dB cable) was entered as an offset in the power meter to allow for direct reading of power.

9.3. Test Setup Layout

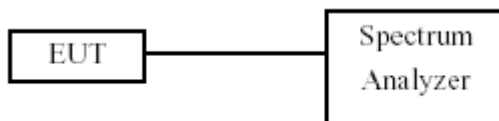



9.4. Test Result and Data

Temperature: 22°C

Humidity: 67%

Test Date: Jul. 27, 2017

In the 5.2G Band

Modulation Type	Channel	Frequency (MHz)	Avg Power Output (dBm)		Total Power (dBm)	Total Power (mW)	Power Limit (dBm)
			ANT 1	ANT 2			
802.11a	36	5180	13.25	13.18	16.23	41.93	30.00
	44	5220	13.55	12.58	16.10	40.76	30.00
	48	5240	13.88	12.41	16.22	41.85	30.00
802.11an HT20	36	5180	13.22	13.02	16.13	41.03	30.00
	44	5220	13.48	12.16	15.88	38.73	30.00
	48	5240	13.75	12.21	16.06	40.35	30.00
802.11an HT40	38	5190	13.07	12.01	15.58	36.16	30.00
	46	5230	13.68	12.49	16.14	41.08	30.00
802.11ac VHT20	36	5180	13.24	13.1	16.18	41.50	30.00
	44	5220	13.53	12.4	16.01	39.92	30.00
	48	5240	13.86	12.36	16.18	41.54	30.00
802.11ac VHT40	38	5190	13.15	12.01	15.63	36.54	30.00
	46	5230	13.76	12.53	16.20	41.67	30.00
802.11ac VHT80	42	5210	12.68	12.15	15.43	34.94	30.00



In the 5.2G Band

Modulation Type	Channel	Freq. (MHz)	N _{SS}	N _{TX}	Measured value of each antenna port (dBm)		Gain above 30° (dB)	E.I.R.P Power above 30° (dBm)	Total E.I.R.P above 30° (dBm)	E.I.R.P Limit (dBm)
					ANT 1	ANT 2				
802.11a	36	5180	1	2	ANT 1	13.25	4.7	17.95	20.98	21
					ANT 2	13.18	4.8	17.98		
802.11a	44	5220	1	2	ANT 1	13.55	4.7	18.25	20.85	21
					ANT 2	12.58	4.8	17.38		
802.11a	48	5240	1	2	ANT 1	13.88	4.7	18.58	20.96	21
					ANT 2	12.41	4.8	17.21		
802.11n HT20	36	5180	1	2	ANT 1	13.22	4.7	17.92	20.88	21
					ANT 2	13.02	4.8	17.82		
802.11n HT20	44	5220	1	2	ANT 1	13.48	4.7	18.18	20.62	21
					ANT 2	12.16	4.8	16.96		
802.11n HT20	48	5240	1	2	ANT 1	13.75	4.7	18.45	20.80	21
					ANT 2	12.21	4.8	17.01		
802.11n HT40	38	5190	1	2	ANT 1	13.07	4.7	17.77	20.33	21
					ANT 2	12.01	4.8	16.81		
802.11n HT40	46	5230	1	2	ANT 1	13.68	4.7	18.38	20.88	21
					ANT 2	12.49	4.8	17.29		
802.11ac VHT20	36	5180	1	2	ANT 1	13.24	4.7	17.94	20.93	21
					ANT 2	13.1	4.8	17.9		
802.11ac VHT20	44	5220	1	2	ANT 1	13.53	4.7	18.23	20.76	21
					ANT 2	12.4	4.8	17.2		
802.11ac VHT20	48	5240	1	2	ANT 1	13.86	4.7	18.56	20.93	21
					ANT 2	12.36	4.8	17.16		
802.11ac VHT40	38	5190	1	2	ANT 1	13.15	4.7	17.85	20.37	21
					ANT 2	12.01	4.8	16.81		
802.11ac VHT40	46	5230	1	2	ANT 1	13.76	4.7	18.46	20.94	21
					ANT 2	12.53	4.8	17.33		
802.11ac VHT80	42	5210	1	2	ANT 1	12.68	4.7	17.38	20.18	21
					ANT 2	12.15	4.8	16.95		



10. PPSD

10.1. Test Limit

Output Power:

Frequency Band		Limit
<input checked="" type="checkbox"/>	5.15~5.25GHz	
Operating Mode		
<input checked="" type="checkbox"/>	Outdoor access point	The maximum conducted output power over the frequency band of operation shall not exceed 1 W (30dBm) provided the maximum antenna gain does not exceed 6 dBi. If transmitting antennas of directional gain greater than 6 dBi are used, both the maximum conducted output power and the maximum power spectral density shall be reduced by the amount in dB that the directional gain of the antenna exceeds 6 dBi. The maximum e.i.r.p. at any elevation angle above 30degrees as measured from the horizon must not exceed125 mW (21 dBm).
<input checked="" type="checkbox"/>	Indoor access point	The maximum conducted output power over the frequency band of operation shall not exceed 1 W (30dBm) provided the maximum antenna gain does not exceed 6 dBi. If transmitting antennas of directional gain greater than 6 dBi are used, both the maximum conducted output power and the maximum power spectral density shall be reduced by the amount in dB that the directional gain of the antenna exceeds 6 dBi.
<input type="checkbox"/>	Fixed point-to-point access points	The maximum conducted output power over the frequency band of operation shall not exceed 1 W (30dBm). Fixed point-to-point U-NII devices may employ antennas with directional gain up to 23 dBi without any corresponding reduction in the maximum conducted output power or maximum power spectral density. For fixed point-to-point transmitters that employ a directional antenna gain greater than 23 dBi, a 1 dB reduction in maximum conducted output power and maximum power spectral density is required for each 1 dB of antenna gain in excess of 23 dBi.
<input type="checkbox"/>	Mobile and portable client devices	The maximum conducted output power over the frequency band of operation shall not exceed 250 mW (24dBm) provided the maximum antenna gain does not exceed 6 dBi. If transmitting antennas of directional gain greater than 6 dBi are used, both the maximum conducted output power and the maximum power spectral density shall be reduced by the amount in dB that the directional gain of the antenna exceeds 6 dBi.



Frequency Band		Limit
<input type="checkbox"/>	5.25-5.35 GHz	The maximum conducted output power over the frequency bands of operation shall not exceed the lesser of 250 mW (24dBm) or 11 dBm 10 log B, where B is the 26 dB emission bandwidth in megahertz. If transmitting antennas of directional gain greater than 6 dBi are used, both the maximum conducted output power and the maximum power spectral density shall be reduced by the amount in dB that the directional gain of the antenna exceeds 6 dBi.
<input type="checkbox"/>	5.470-5.725 GHz	
<input checked="" type="checkbox"/>	5.725~5.85 GHz	The maximum conducted output power over the frequency band of operation shall not exceed 1 W (30dBm). If transmitting antennas of directional gain greater than 6 dBi are used, both the maximum conducted output power and the maximum power spectral density shall be reduced by the amount in dB that the directional gain of the antenna exceeds 6 dBi. However, fixed point-to-point U-NII devices operating in this band may employ transmitting antennas with directional gain greater than 6 dBi without any corresponding reduction in transmitter conducted power.

PSD:

Frequency Band		Limit	
<input checked="" type="checkbox"/>	5.15~5.25GHz		
	Operating Mode		
	<input checked="" type="checkbox"/> Outdoor access point		17 dBm/MHz
	<input checked="" type="checkbox"/> Indoor access point		17 dBm/MHz
	<input type="checkbox"/> Fixed point-to-point access points		17 dBm/MHz
<input type="checkbox"/> Mobile and portable client devices	11 dBm/MHz		
<input type="checkbox"/>	5.725~5.85 GHz	11 dBm/MHz	
<input type="checkbox"/>	5.470-5.725 GHz	11 dBm/MHz	
<input checked="" type="checkbox"/>	5.725~5.85 GHz	30 dBm/500kHz	



10.2. Test Procedure

As an alternative to FCC KDB-789033, the EUT maximum conducted output power was Measured with an average power meter employing a video bandwidth greater than 6dB BW of the emission under test. Maximum conducted output power was read directly from the meter across all data rates, and across three channels within each sub-band. Special care was used to make sure that the EUT was transmitting in continuous mode. This method exceeds the limitations of FCC KDB-789033, and provides more accurate measurements.

802.11an (BW≤40MHz) Maximum conducted output power using KDB 789033 section E)3)b) Method PM-G (Measurement using a gated RF average power meter)

Note: the power meter have a video bandwidth that is greater than or equal to the measurement bandwidth, (Anritsu/ MA2411B video bandwidth: 65MHz)

802.11ac (BW=80MHz) Maximum conducted output power using KDB 789033 section E)2)b) Method SA-1 (trace averaging with the EUT transmitting at full power throughout each sweep).

When transmitted signals consist of two or more non-contiguous spectrum segments (e.g., 80+80 MHz mode) or when a single spectrum segment of a transmission crosses the boundary between two adjacent U-NII bands, KDB 644545 D01 section F) procedure is used for measurements.

10.3. Test Setup Layout

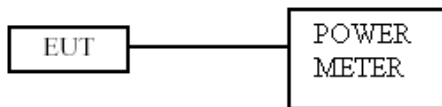

10.4. Test Result and Data

Temperature: 22°C

Humidity: 67%

Test Date: Jul. 27, 2017

In the 5.2G Band

Modulation Type	CH	Freq. (MHz)	Meas PPSD (dBm/MHz)		Sum chain (dBm)	Duty Cycle CF(dB)	Total Corr'd PPSD (dBm/MHz)	PPSD Limit (dBm/MHz)
			ANT 1	ANT 2				
802.11a	36	5180	2.02	1.34	4.70	0.10	4.80	15.24
	44	5220	2.15	1.16	4.69	0.10	4.79	15.24
	48	5240	2.45	1.10	4.84	0.10	4.94	15.24
802.11ac VHT20	36	5180	1.78	0.82	4.34	0.11	4.45	15.24
	44	5220	1.87	0.57	4.28	0.11	4.39	15.24
	48	5240	2.09	0.81	4.51	0.11	4.62	15.24
802.11ac VHT40	38	5190	-1.22	-1.89	1.47	0.73	2.20	15.24
	46	5230	-1.13	-2.33	1.32	0.73	2.05	15.24
802.11ac VHT80	42	5210	-5.85	-6.79	-3.28	2.36	-0.92	15.24



5.2G Band

Antenna 1

Modulation Standard: 802.11a (6Mbps)
CH36

Modulation Standard: 802.11ac, VHT20 (6.5Mbps)
CH36

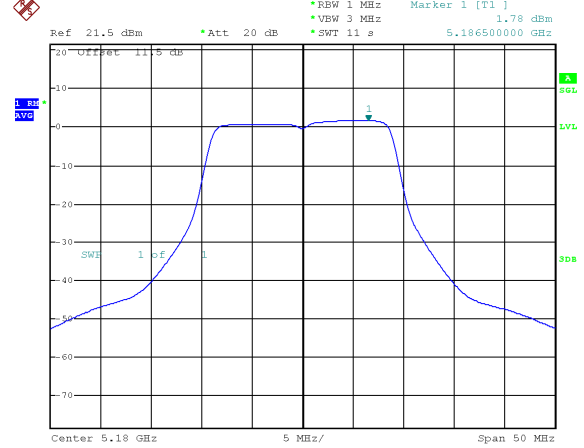
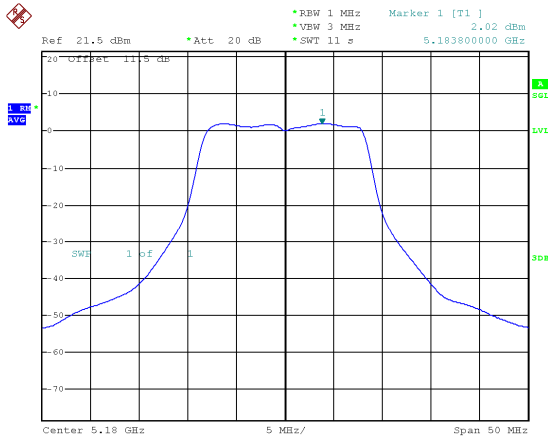

CH44

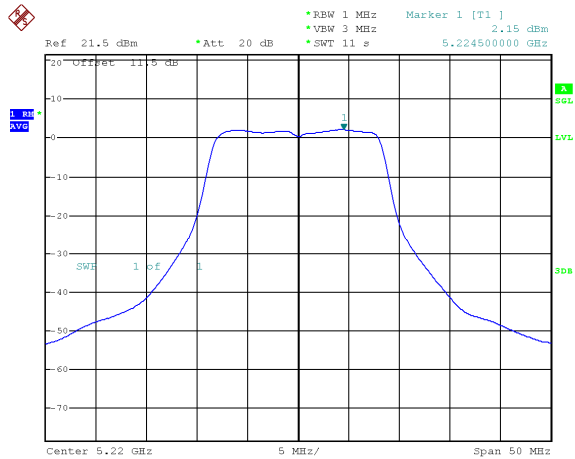

CH44

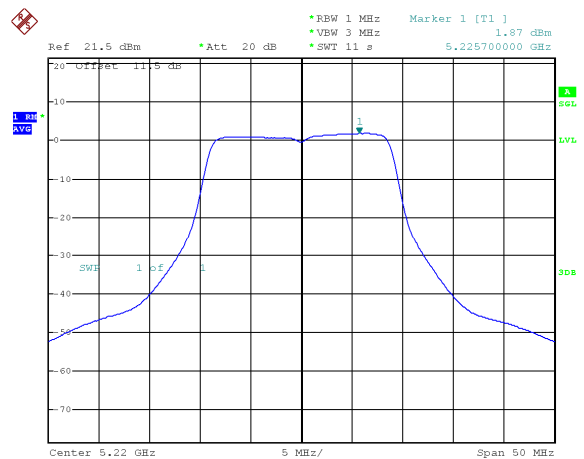

CH48

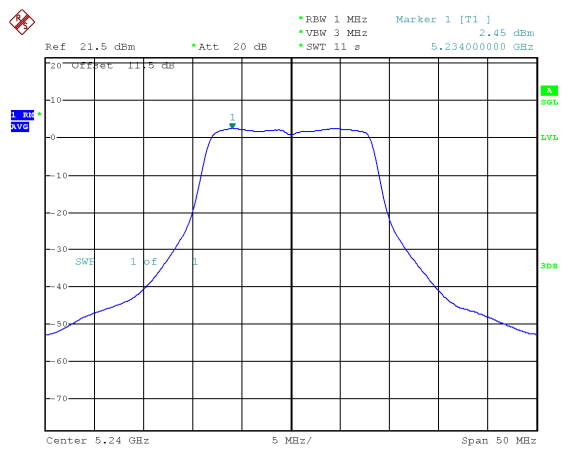

CH48

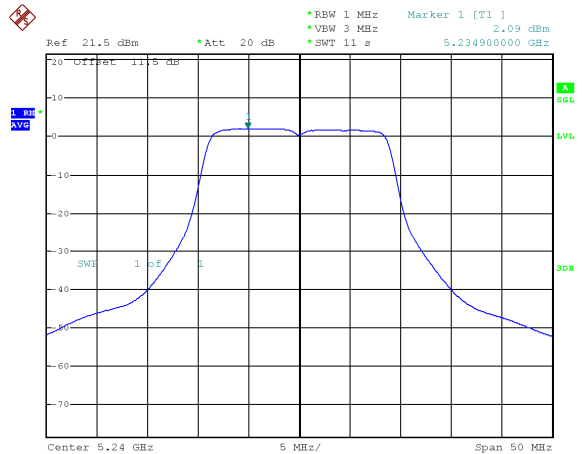



Antenna 1

Modulation Standard: 802.11ac, VHT40 (13.5Mbps)
CH38

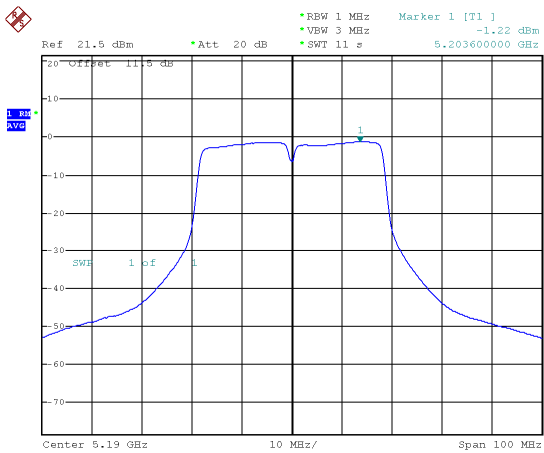

Modulation Standard: 802.11ac, VHT80 (29.3Mbps)
CH42

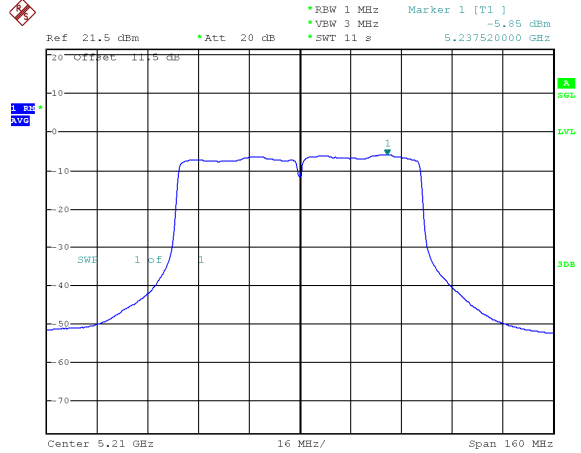

CH46

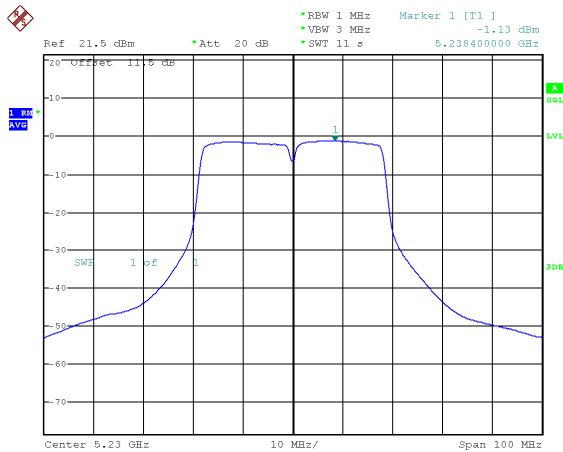



Antenna 2
Modulation Standard: 802.11a (6Mbps)
CH36

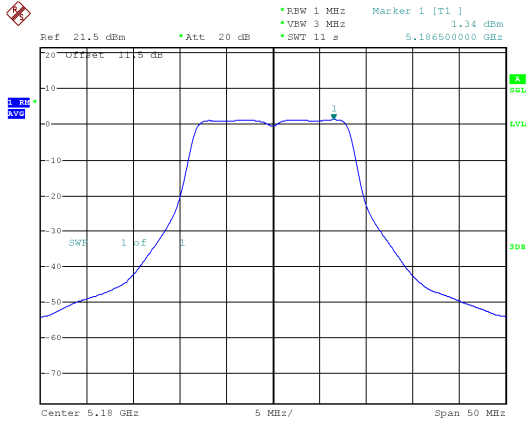

Modulation Standard: 802.11ac, VHT20 (6.5Mbps)
CH36

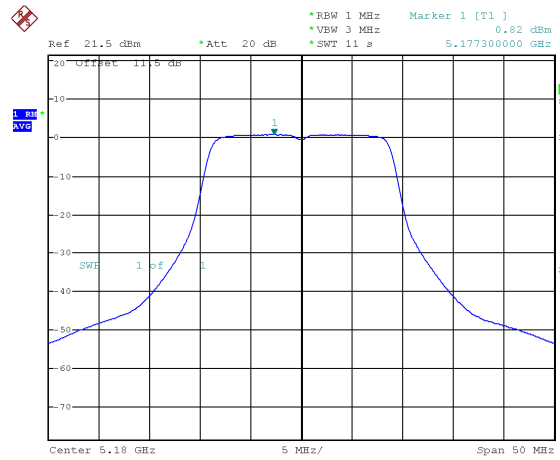

CH44

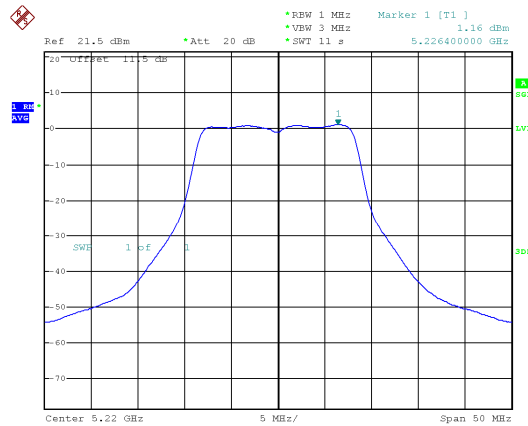

CH44

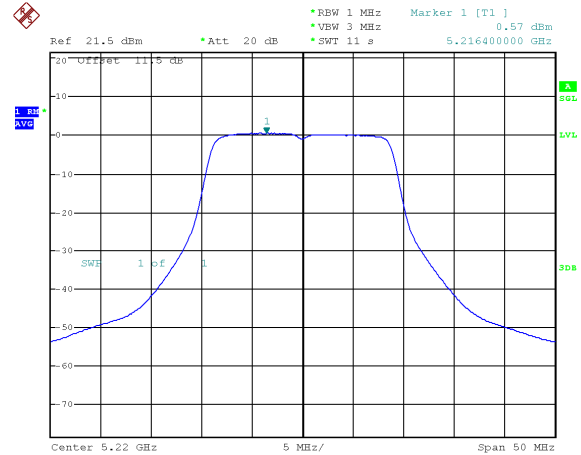

CH48

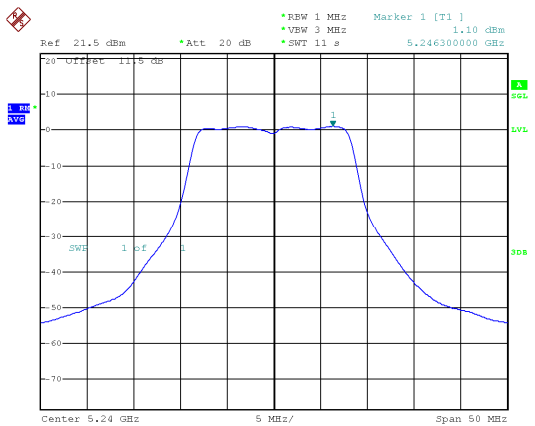

CH48

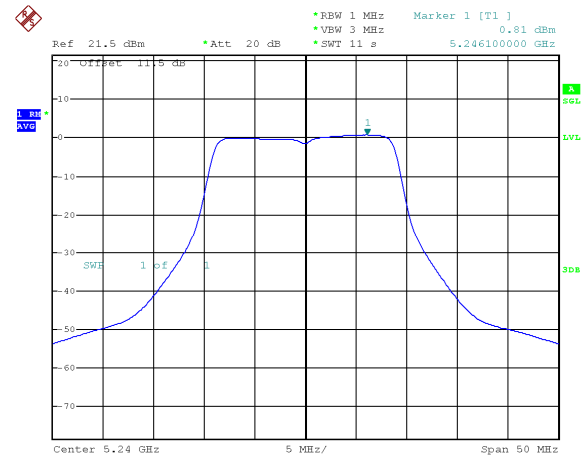



Antenna 2

Modulation Standard: 802.11ac, VHT40 (13.5Mbps)
CH38

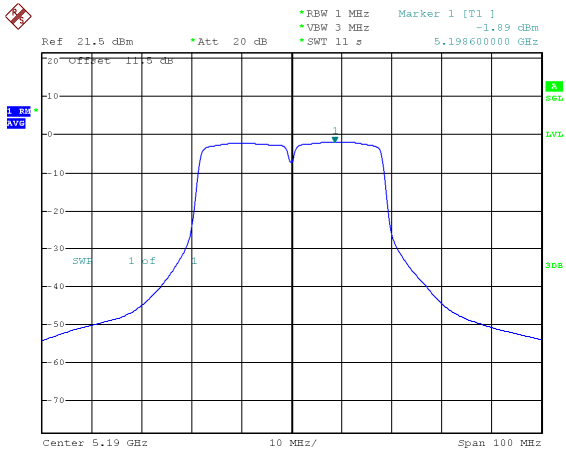

Modulation Standard: 802.11ac, VHT80 (29.3Mbps)
CH42

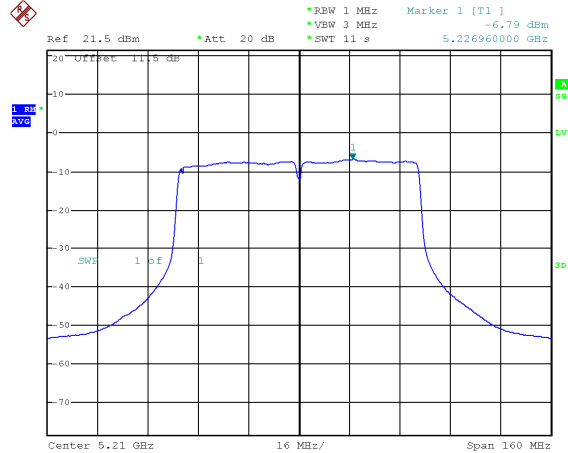

CH46

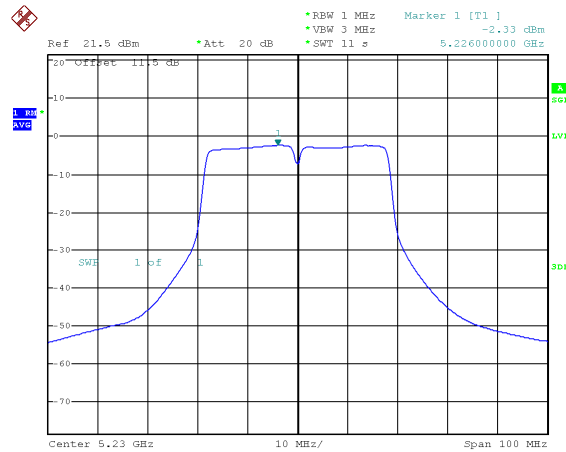



11. Frequency Stability

11.1. Test Procedure

1. The EUT was placed inside the Temperature and Humidity chamber.
2. The transmitter output was connected to spectrum analyzer.
3. Turn the EUT on and couple its output to a spectrum analyzer.
4. Turn the EUT off and set the chamber to the highest temperature specified.
5. Allow sufficient time (approximately 30 min) for the temperature of the chamber to stabilize, turn the EUT on and measure the operating frequency after 2, 5, and 10 minutes.
6. Repeat step 2 and 3 with the temperature chamber set to the lowest temperature.
7. The test chamber was allowed to stabilize at +20 degree C for a minimum of 30 minutes. The supply voltage was then adjusted on the EUT from 85% to 115% and the frequency record.

11.2. Test Setup Layout

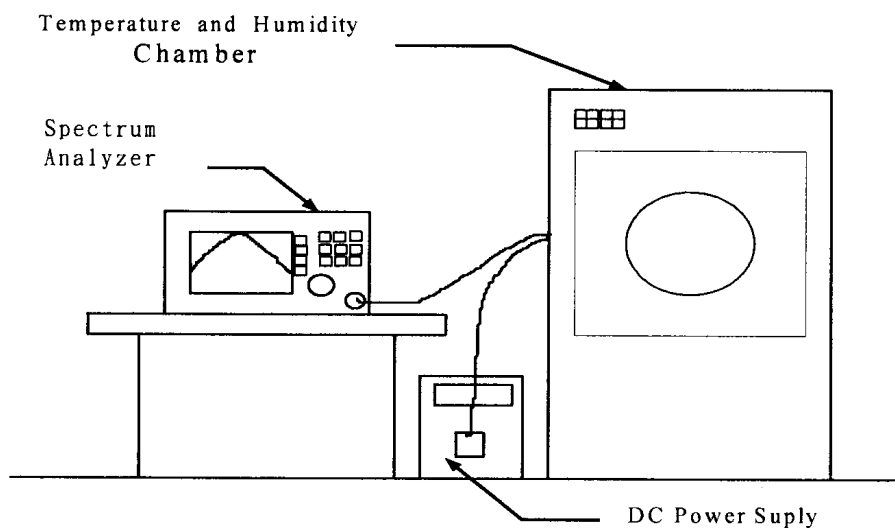



11.3. Test Result and Data

Temperature: 22°C

Humidity: 67%

Test Date: Jul. 27, 2017

Operating frequency: 5180 MHz							
Temp	Power supply	2 minute		5 minute		10 minute	
(°C)	(V)	(MHz)	(%)	(MHz)	(%)	(MHz)	(%)
50	102	5179.7112	-0.001223	5179.3383	-0.001674	5179.8859	0.000079
	120	5179.9205	-0.000196	5179.4947	-0.001921	5179.0601	0.001215
	138	5179.4713	-0.001757	5179.8630	0.001365	5179.9189	-0.000648
40	102	5179.4123	-0.001421	5179.2355	-0.000957	5179.7676	0.000423
	120	5179.1434	-0.000539	5179.2923	0.001233	5179.5962	0.001188
	138	5179.7385	-0.001838	5179.2830	-0.000819	5179.8073	-0.001698
30	102	5179.5950	0.001017	5179.4929	0.001140	5179.5005	-0.000242
	120	5179.6956	-0.001311	5179.1193	0.001881	5179.0057	-0.001197
	138	5179.6183	0.000546	5179.0298	0.001027	5179.7629	-0.000398
20	102	5179.9727	0.001752	5179.6132	-0.000619	5179.8501	0.001162
	120	5179.3163	0.000083	5179.9192	0.001686	5179.6812	-0.001910
	138	5179.6036	-0.000260	5179.8474	-0.001595	5179.0266	0.000245
10	102	5179.5014	0.001252	5179.6683	-0.000394	5179.1328	-0.000023
	120	5179.6950	0.000534	5179.5254	0.000973	5179.7057	-0.001427
	138	5179.0293	0.000175	5179.7742	0.000051	5179.7548	-0.001449
0	102	5179.8077	-0.001611	5179.8012	-0.001055	5179.8409	0.000249
	120	5179.6455	0.000704	5179.5171	-0.001914	5179.0755	-0.000125
	138	5179.3411	0.001110	5179.6699	0.001725	5179.2622	0.000878
-10	102	5179.1108	-0.000363	5179.3885	-0.000984	5179.8071	-0.001772
	120	5179.0388	0.000566	5179.8673	0.000837	5179.6104	-0.000036
	138	5179.4972	0.001018	5179.6155	-0.001053	5179.7703	-0.000384
-20	102	5179.2849	-0.001664	5179.9431	-0.000981	5179.0057	-0.000912
	120	5179.7663	-0.000131	5179.1458	0.001342	5179.6837	0.001117
	138	5179.2543	0.001153	5179.9323	0.000664	5179.6749	-0.000303
-30	102	5179.3399	0.000923	5179.8155	0.000575	5179.4787	0.000305
	120	5179.6201	-0.000690	5179.0740	-0.000666	5179.7160	-0.000390
	138	5179.9267	0.001380	5179.1826	-0.000342	5179.8740	0.001357

Limit:

Manufacturers of U-NII devices are responsible for ensuring frequency stability such that an emission is maintained within the band of operation under all conditions of normal operation as specified in the users manual.



12. Automatically Discontinue Transmission

12.1.Limit of Automatically Discontinue Transmission

The device shall automatically discontinue transmission in case of either absence of information to transmit or operational failure. These provisions are not intended to preclude the transmission of control or signaling information or the use of repetitive codes used by certain digital technologies to complete frame or burst intervals. Applicants shall include in their application for equipment authorization to describe how this requirement is met.

12.2.Test Result of Automatically Discontinue Transmission

While the EUT is not transmitting any information, the EUT can automatically discontinue transmission and become standby mode for power saving. The EUT can detect the controlling signal of ACK message transmitting from remote device and verify whether it shall resend or discontinue transmission.



13. Radio Frequency Exposure

13.1.Applicable Standards

The measurements shown in this test report were made in accordance with the procedures given in FCC Part 2 (Section 2.1091)
KDB 447498

13.2.EUT Specification

Frequency band (Operating)	<input type="checkbox"/> WLAN: 2412MHz ~ 2462MHz <input checked="" type="checkbox"/> WLAN: 5150MHz ~ 5250MHz <input type="checkbox"/> WLAN: 5250MHz ~ 5350MHz <input type="checkbox"/> WLAN: 5470MHz ~ 5725MHz <input type="checkbox"/> WLAN: 5725MHz ~ 5850MHz <input type="checkbox"/> Bluetooth: 2402MHz ~ 2480MHz
Device category	<input type="checkbox"/> Portable (<20cm separation) <input checked="" type="checkbox"/> Mobile (>20cm separation)
Exposure classification	<input type="checkbox"/> Occupational/Controlled exposure (S = 5mW/cm ²) <input checked="" type="checkbox"/> General Population/Uncontrolled exposure (S=1mW/cm ²)
Antenna diversity	<input type="checkbox"/> Single antenna <input checked="" type="checkbox"/> Multiple antennas <input type="checkbox"/> Tx diversity <input type="checkbox"/> Rx diversity <input checked="" type="checkbox"/> Tx/Rx diversity
Evaluation applied	<input checked="" type="checkbox"/> MPE Evaluation* <input type="checkbox"/> SAR Evaluation <input type="checkbox"/> N/A

Remark:

1. The maximum output power is 16.23dBm (0.0252mW) at 5180MHz (with numeric 4.8 antenna gain.)
2. DTS device is not subject to routine RF evaluation; MPE estimate is used to justify the compliance.
3. For mobile or fixed location transmitters, no SAR consideration applied. The maximum power density is 1.0 mW/cm² even if the calculation indicates that the power density would be larger.

13.3.Test Results

No non-compliance noted.



13.4.Calculation

Given $E = \frac{\sqrt{30 \times P \times G}}{d}$ & $S = \frac{E^2}{3770}$

Where E = Field strength in Volts / meter

P = Power in Watts

G = Numeric antenna gain

d = Distance in meters

S = Power density in milliwatts / square centimeter

Combining equations and re-arranging the terms to express the distance as a function of the remaining variables yields:

$$S = \frac{30 \times P \times G}{3770d^2}$$

Changing to units of mW and cm, using:

P (mW) = P (W) / 1000 and

d (cm) = d(m) / 100

Yields

$$S = \frac{30 \times (P/1000) \times G}{3770 \times (d/100)^2} = 0.0796 \times \frac{P \times G}{d^2} \quad \text{Equation 1}$$

Where d = Distance in cm

P = Power in mW

G = Numeric antenna gain

S = Power density in mW / cm²



13.5. Maximum Permissible Exposure

Max. output power	Band: 5150MHz ~ 5250MHz 802.11a: 16.23dBm (0.0252mW) 802.11an VHT20: 16.13dBm (0.0247mW) 802.11an VHT40: 16.14dBm (0.0247mW) 802.11ac VHT20: 16.18dBm (0.0250mW) 802.11ac VHT40: 16.20dBm (0.0250mW) 802.11ac VHT80: 15.43dBm (0.0210mW)
Antenna gain (Max)	4.8dBi

Maximum Permissible Exposure

Modulation Mode	Frequency band (MHz)	Max. Conducted output power (dBm)	Antenna gain (dBi)	Distance (cm)	Power density (mW/cm ²)	Limit (mW/cm ²)
802.11a	5150-5250	16.23	4.8	20	0.0252	1
802.11an HT20	5150-5250	16.13	4.8	20	0.0247	1
802.11an HT40	5150-5250	16.14	4.8	20	0.0247	1
802.11ac VHT20	5150-5250	16.18	4.8	20	0.0250	1
802.11ac VHT40	5150-5250	16.20	4.8	20	0.0250	1
802.11ac VHT80	5150-5250	15.43	4.8	20	0.0210	1

Maximum Permissible Exposure (Co-location)

Modulation Mode	Frequency band (MHz)	Max. Conducted output power (dBm)	Antenna Gain(dBi)	Distance (cm)	Power Density (mW/cm ²)
2.4G 11g	2412-2462	28.73	4.6	20	0.4283
5G 11a	5725-5850	25.99	4.8	20	0.2385
Co-location Total					0.6668
Maximum Permissible Exposure Limit					1