



FCC RADIO TEST REPORT

Applicant : Open Mesh, Inc.
Address : 5 Centerpointe Drive, Suite 400, Lake Oswego,
Oregon, United States, 97035
Equipment : WiFi Access Point
Model No. : A40
Trade Name : 
FCC ID : WT8OMA40

I HEREBY CERTIFY THAT :

The sample was received on Nov. 26, 2016 and the testing was carried out on Dec. 15, 2016 at CerpPASS Technology Corp. The test result refers exclusively to the test presented test model / sample. Without written approval of CerpPASS Technology Corp., the test report shall not be reproduced except in full.

Approved by:



Mark Liao / Assistant Manager

Tested by:

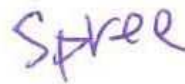

Spree Yei / Engineer

Laboratory Accreditation:

CerpPASS Technology Corporation Test Laboratory





CONTENTS

- 1. Summary of Test Procedure and Test Results 5
 - 1.1. Applicable Standards 5
- 2. Test Configuration of Equipment under Test 6
 - 2.1. Feature of Equipment under Test..... 6
 - 2.2. Carrier Frequency of Channels 6
 - 2.3. Test Mode and Test Software 7
 - 2.4. Description of Test System..... 7
 - 2.5. General Information of Test..... 8
 - 2.6. Measurement Uncertainty 8
- 3. Test Equipment and Ancillaries Used for Tests 9
- 4. Antenna Requirements 10
 - 4.1. Standard Applicable 10
 - 4.2. Antenna Construction and Directional Gain..... 10
- 5. Test of AC Power Line Conducted Emission 11
 - 5.1. Test Limit 11
 - 5.2. Test Procedures 11
 - 5.3. Typical Test Setup 12
 - 5.4. Test Result and Data 13
 - 5.5. Test Photographs 17
- 6. Test of Spurious Emission (Radiated) 18
 - 6.1. Test Limit 18
 - 6.2. Test Procedures 18
 - 6.3. Typical Test Setup 19
 - 6.4. Test Result and Data (9kHz ~ 30MHz)..... 20
 - 6.5. Test Result and Data (30MHz ~ 1GHz)..... 20
 - 6.6. Test Result and Data (1GHz ~ 40GHz)..... 24
 - 6.7. Restricted Bands of Operation 60
 - 6.8. Test Photographs (30MHz ~ 1GHz) 61
 - 6.9. Test Photographs (1GHz ~ 40GHz) 62
- 7. On Time, Duty Cycle and Measurement methods 63
 - 7.1. Test Limit 63
 - 7.2. Test Procedure 63
 - 7.3. Test Setup Layout 63
 - 7.4. Test Result and Data 63
 - 7.5. Measurement Methods 63
- 8. 6dB Bandwidth 65
 - 8.1. Test Limit 65
 - 8.2. Test Procedure 65
 - 8.3. Test Setup Layout 65
 - 8.4. Test Result and Data 65
- 9. 26dB Bandwidth 70
 - 9.1. Test Limit 70
 - 9.2. Test Procedure 70
 - 9.3. Test Setup Layout 70



- 9.4. Test Result and Data 70
- 10. Average Power..... 75
 - 10.1. Test Limit 75
 - 10.2. Test Procedure 75
 - 10.3. Test Setup Layout 75
 - 10.4. Test Result and Data 75
- 11. Output Power and PPSD 77
 - 11.1. Test Limit 77
 - 11.2. Test Procedure 79
 - 11.3. Test Setup Layout 79
 - 11.4. Test Result and Data 80
- 12. Frequency Stability..... 89
 - 12.1. Test Procedure 89
 - 12.2. Test Setup Layout 89
 - 12.3. Test Result and Data 90
- 13. Automatically Discontinue Transmission 91
 - 13.1. Limit of Automatically Discontinue Transmission 91
 - 13.2. Test Result of Automatically Discontinue Transmission 91



1. Summary of Test Procedure and Test Results

1.1. Applicable Standards

ANSI C63.4:2014

ANSI C63.10:2013

FCC Rules and Regulations Part 15 Subpart E §15.407

First R&O 14-30

KDB662911

KDB789033

KDB644545

FCC Rule	Description of Test	Result
15.203	. Antenna Requirement	Pass
15.207(a)	. AC Power Line Conducted Emission	Pass
15.407(b) 15.209	. Radiated Spurious Emission	Pass
15.407(a)	. 26 dB Occupied Bandwidth	Pass
15.407	. 6 dB Bandwidth	Pass
15.407 (a) & (a)(3)	. Average Power	Pass
15.407(a)	. Output and PPSD	Pass



2. Test Configuration of Equipment under Test

2.1. Feature of Equipment under Test

Modulation Type	DSSS, OFDM
Frequency Range	802.11b/g/n: 2412-2462MHz 802.11a/an/ac: 5150-5250MHz, 5725-5850MHz
Data Rate	802.11b: 1, 2, 5.5, 11Mbps 802.11g: 6, 9, 12, 18, 24, 36, 48, 54Mbps 802.11n: MCS0 – MCS15, HT20/40 802.11a: 6, 9, 12, 18, 24, 36, 48, 54Mbps 802.11ac: MCS0 – MCS9, VHT 20/40/80)
Antenna Type	PIFA Antenna
Antenna Gain	802.11b/g/n: Antenna 1: 4.6 dBi Antenna 2: 3.3 dBi 802.11a/an/ac: Antenna 1: 4.7 dBi Antenna 2: 4.8 dBi

2.2. Carrier Frequency of Channels

Band: 5150MHz-5250MHz

802.11a, 802.11an HT 20, 802.11ac VHT20

Channel	Frequency(MHz)	Channel	Frequency(MHz)
*36	5180	*44	5220
40	5200	*48	5240

802.11an HT 40, 802.11ac VHT40

Channel	Frequency(MHz)	Channel	Frequency(MHz)
*38	5190	*46	5230

802.11ac VHT80

Channel	Frequency(MHz)
*42	5210

Band: 5725MHz -5850MHz

802.11a, 802.11an HT20, 802.11ac VHT20

Channel	Frequency(MHz)	Channel	Frequency(MHz)
*149	5745	161	5805
153	5765	*165	5825
*157	5785		

802.11an HT 40, 802.11ac VHT40

Channel	Frequency(MHz)	Channel	Frequency(MHz)
*151	5755	*159	5795

802.11ac VHT80

Channel	Frequency(MHz)
*155	5775

Note: Channels remarked * are selected to perform test.



2.3. Test Mode and Test Software

- a. During testing, the interface cables and equipment positions were varied according to ANSI C63.4.
- b. The complete test system included remote workstation and EUT for RF test. The remote workstation included Notebook.
- c. An executive program, "ART2-GUI" under WIN 7 was executed to transmit and receive data via WLAN.
- d. The following test modes were performed for the test:

- Test Mode 1: 802.11a (6Mbps)
- Test Mode 2: 802.11an HT20 (6.5Mbps)
- Test Mode 3: 802.11an HT40 (13.5Mbps)
- Test Mode 4: 802.11ac VHT20 (6.5Mbps)
- Test Mode 5: 802.11ac VHT40 (13.5Mbps)
- Test Mode 6: 802.11ac VHT80 (29.3Mbps)

For conduction 5.2G Band test, caused "Test Mode 5" generated the worst case, it was reported as the final data.

For conduction 5.8G Band test, caused "Test Mode 1" generated the worst case, it was reported as the final data.

For radiated 5.2G Band test (below 1GHz), caused "Test Mode 5" generated the worst case, it was reported as the final data.

For radiated 5.8G Band test (below 1GHz), caused "Test Mode 1" generated the worst case, it was reported as the final data.

For radiated test (above 1GHz), caused "Test Mode 1,4,5,6" generated the worst case, they were reported as the final data.

2.4. Description of Test System

Device	Manufacturer	Model No.	Description
Remote workstation			
Notebook	DELL	Latitude E6430	Power Cable, Unshielding, 1.8m



2.5. General Information of Test

Test Site	Cerpass Technology Corporation Test Laboratory Address: No.10, Ln. 2, Lianfu St., Luzhu Dist., Taoyuan City 33848, Taiwan (R.O.C.) Tel:+886-3-3226-888 Fax:+886-3-3226-881 Address: No.68-1, Shihbachongsi, Shihding Township, New Taipei City 223, Taiwan, R.O.C. Tel: +886-2-2663-8582	
	FCC	TW1079, TW1061, 390316, 228391, 641184
	IC	4934E-1, 4934E-2
	VCCI	T-2205 for Telecommunication Test C-4663 for Conducted emission test R-4218, R-4399 for Radiated emission test G-812, G-813 for radiated disturbance above 1GHz
Frequency Range Investigated:	Conducted: from 150kHz to 30 MHz Radiation: from 30 MHz to 40,000MHz	
Test Distance:	The test distance of radiated emission from antenna to EUT is 3 M.	

2.6. Measurement Uncertainty

Measurement Item	Measurement Frequency	Polarization	Uncertainty
Conducted Emission	9 kHz ~ 30 MHz	Line / Neutral	±2.9076 dB
Radiated Emission	9 kHz ~ 25,000 MHz	Vertical / Horizontal	±0.948 dB
Spurious Emission (Conducted)	-	-	±4.011 dB
Maximum Peak and Average Output Power	-	-	±0.322 dB
Power Spectral Density	-	-	±0.322 dB
Bandwidth	-	-	74.224Hz



3. Test Equipment and Ancillaries Used for Tests

Instrument	Manufacturer	Model No.	Serial No.	Calibration Date	Valid Date
EMI Receiver	R&S	ESCI3	100443	2016/03/28	2017/03/27
LISN	Schwarzbeck	NSLK 8127	8127-740	2016/08/30	2017/08/29
LISN	Schwarzbeck	NSLK 8127	8127-516	2016/09/06	2017/09/05
Pulse Limiter	R&S	ESH3-Z2	101934	2016/03/09	2017/03/08
Bilog Antenna	Schwarzbeck	VULB9168	369	2016/03/22	2017/03/21
Active Loop Antenna	EMCO	6507	40855	2016/05/11	2017/05/10
Horn Antenna	EMCO	3115	31601	2016/09/05	2017/09/04
Horn Antenna	EMCO	3116	31970	2016/03/18	2017/03/17
EXA Signal Analyzer	KEYSIGHT	N9010A	MY54200207	2016/03/16	2017/03/15
Preamplifier	EM	EM330	60660	2016/03/16	2017/03/15
Preamplifier	EMC INSTRUMENTS	EMC051845SE	980333	2016/09/13	2017/09/12
Preamplifier	Agilent	8449B	3008A01954	2016/03/04	2017/03/03
Preamplifier	MITEQ	AMF-7D-001010 0-30-10P	1860212	2016/03/16	2017/03/15
Preamplifier	EMC INSTRUMENTS	EMC184045	980065	2016/11/04	2017/11/03
MXG MW Analog Signal Generator	KEYSIGHT	N5183A	MY50142931	2016/03/18	2017/03/17
Spectrum Analyzer	R&S	FSP40	100219	2016/09/01	2017/08/31
BLUETOOTH TESTER	R&S	CBT	101133	2016/03/18	2017/03/17
Attenuator	KEYSIGHT	8491B	MY39250703	2016/03/07	2017/03/06
Rotary Attenuator	Agilent	8494B	MY42154466	2016/03/08	2017/03/07
Rotary Attenuator	Agilent	8495B	MY42146680	2016/03/08	2017/03/07
Temp & Humi chamber	T-MACHINE	TMJ-9712	T-12-040111	2016/09/05	2017/09/04
Series Power Meter	Anritsu	ML2495A	1224005	2016/03/03	2017/03/02
Power Sensor	Anritsu	MA2411B	1207295	2016/03/03	2017/03/02
Cable	HUBER SUHNER	SUCOFLEX 102	28422/2	2016/03/15	2017/03/14
Cable	HUBER SUHNER	SUCOFLEX 102	28418/2	2016/03/16	2017/03/15
Cable	HUBER SUHNER	SUCOFLEX 102	28417/2	2016/03/04	2017/03/03
Software	Farad	Ez-EMC	ver.ct3a1	N/A	N/A
Software	AUDIX	E3	V8.2014-8-6	N/A	N/A
Software	Keysight	N7607B Signal Studio	v2.0.0.1	N/A	N/A
Software	Keysight	Inservice MonitorUtility	N/A	N/A	N/A



4. Antenna Requirements

4.1. Standard Applicable

For intentional device, according to FCC 47 CFR Section 15.203, an intentional radiator shall be designed to ensure that no antenna other than that furnished by the responsible party shall be used with the device.

And according to FCC 47 CFR Section 15.407 (a), if transmitting antennas of directional gain greater than 6dBi are used, the power shall be reduced by the amount in dB that the directional gain of the antenna exceeds 6dBi.

4.2. Antenna Construction and Directional Gain

Antenna Type	Antenna Gain
PIFA Antenna	Antenna 1: 4.7 dBi
	Antenna 2: 4.8 dBi

For Power directional gain= G_{ant} = 4.80 dBi

For PSD directional gain = $10 \log[(10^{G1/20} + 10^{G2/20} + \dots + 10^{GN/20})^2 / NANT]$
= 7.76 (dBi)



5. Test of AC Power Line Conducted Emission

5.1. Test Limit

Conducted Emissions were measured from 150 kHz to 30 MHz with a bandwidth of 9 KHz, according to the methods defined in ANSI C63.4-2014. The EUT was placed on a nonmetallic stand in a shielded room 0.8 meters above the ground plane. The interface cables and equipment positioning were varied within limits of reasonable applications to determine the position produced maximum conducted emissions.

Frequency (MHz)	Quasi Peak (dB μ V)	Average (dB μ V)
0.15 – 0.5	66-56*	56-46*
0.5 – 5.0	56	46
5.0 – 30.0	60	50

*Decreases with the logarithm of the frequency.

5.2. Test Procedures

- The EUT was placed 0.4 meter from the conducting wall of the shielding room was kept at least 80 centimeters from any other grounded conducting surface.
- Connect EUT to the power mains through a line impedance stabilization network (LISN).
- All the support units are connecting to the other LISN.
- The LISN provides 50 ohm coupling impedance for the measuring instrument.
- The FCC states that a 50 ohm, 50 micro-Henry LISN should be used.
- Both sides of AC line were checked for maximum conducted interference.
- The frequency range from 150 kHz to 30 MHz was searched.
- Set the test-receiver system to Peak Detect Function and Specified Bandwidth with Maximum Hold Mode.



5.3. Typical Test Setup

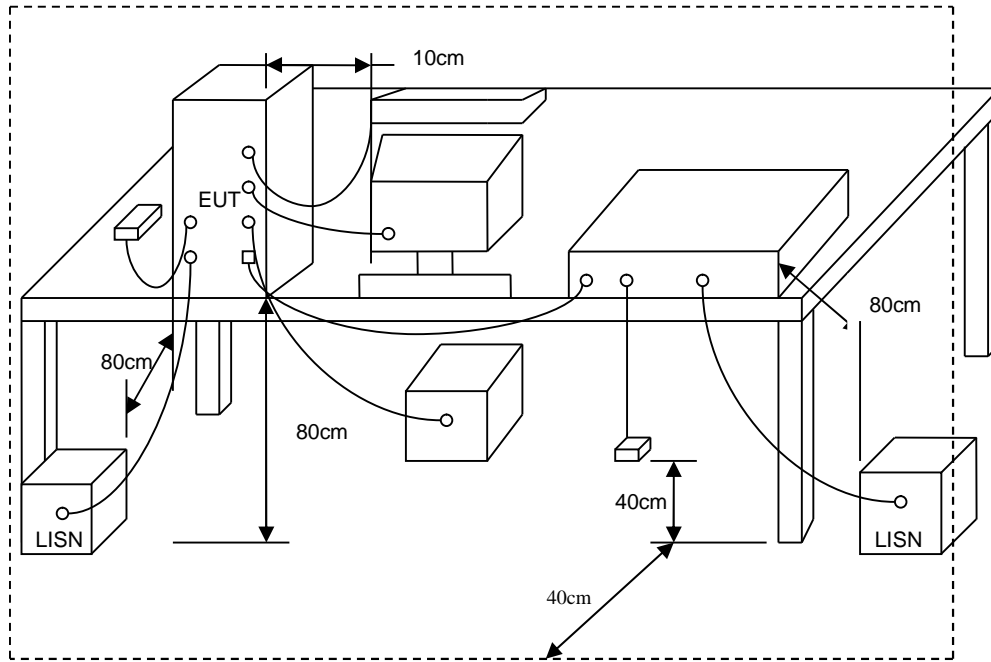



5.4. Test Result and Data

Power	: PoE	Pol/Phase	: LINE
Test Mode	: Mode 5 (5.2G Band)	Temperature	: 20 °C
Test date	: Dec. 15, 2016	Humidity	: 52 %

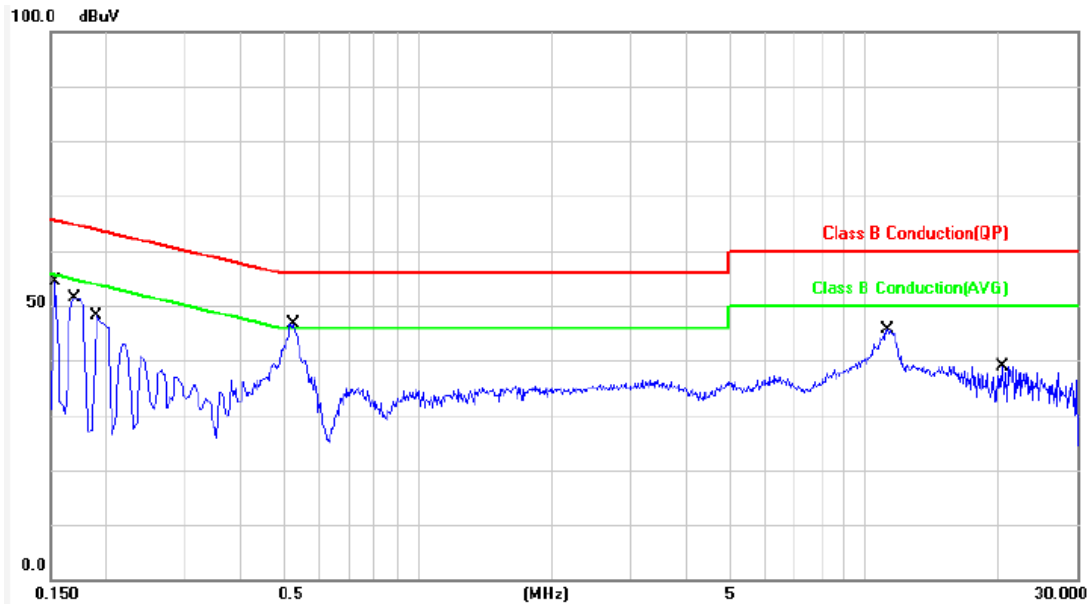

No.	Frequency (MHz)	Factor (dB)	Reading (dBuV)	Level (dBuV)	Limit (dBuV)	Margin (dB)	Detector	P/F
1	0.1539	9.98	42.66	52.64	65.78	-13.14	QP	P
2	0.1539	9.98	24.52	34.50	55.78	-21.28	AVG	P
3	0.1700	9.98	39.31	49.29	64.96	-15.67	QP	P
4	0.1700	9.98	20.20	30.18	54.96	-24.78	AVG	P
5	0.1900	9.97	35.53	45.50	64.03	-18.53	QP	P
6	0.1900	9.97	18.04	28.01	54.03	-26.02	AVG	P
7	0.5260	9.98	35.02	45.00	56.00	-11.00	QP	P
8	0.5260	9.98	29.74	39.72	46.00	-6.28	AVG	P
9	11.3020	10.30	31.24	41.54	60.00	-18.46	QP	P
10	11.3020	10.30	26.50	36.80	50.00	-13.20	AVG	P
11	20.4780	10.53	24.60	35.13	60.00	-24.87	QP	P
12	20.4780	10.53	20.69	31.22	50.00	-18.78	AVG	P

Note: Level = Reading + Factor
 Margin = Level – Limit
 Factor = (LISN, ISN, PLC or current probe) Factor + Cable Loss+ Attenuator



Power	: PoE	Pol/Phase	: NEUTRAL
Test Mode	: Mode 5 (5.2G Band)	Temperature	: 20 °C
Test date	: Dec. 15, 2016	Humidity	: 52 %

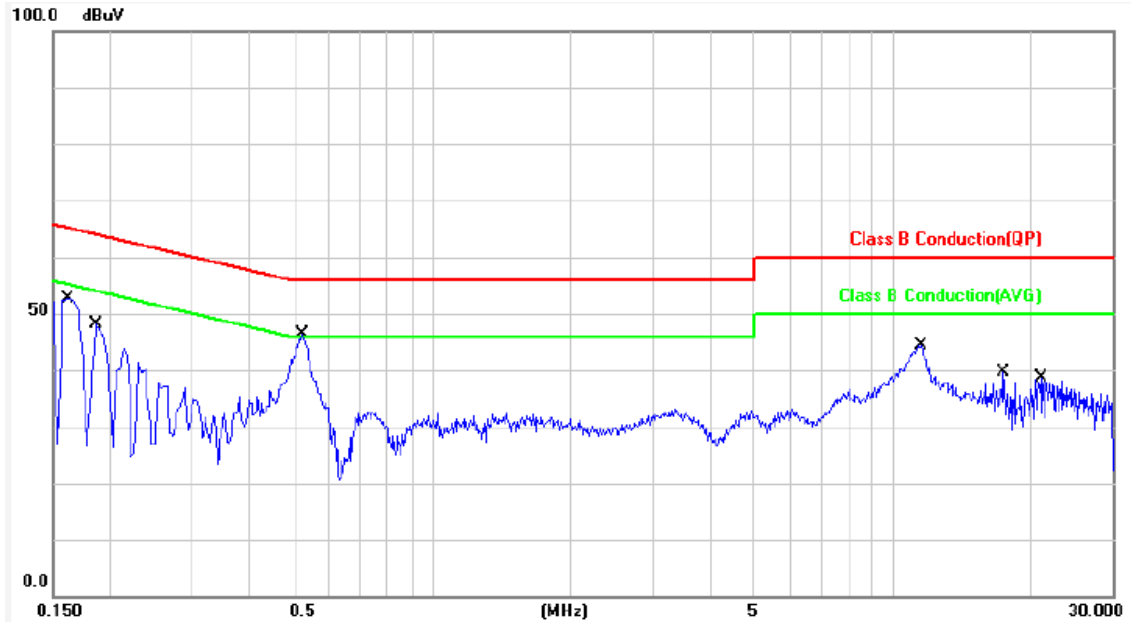

No.	Frequency (MHz)	Factor (dB)	Reading (dBuV)	Level (dBuV)	Limit (dBuV)	Margin (dB)	Detector	P/F
1	0.1620	9.98	40.68	50.66	65.36	-14.70	QP	P
2	0.1620	9.98	20.95	30.93	55.36	-24.43	AVG	P
3	0.1860	9.98	36.22	46.20	64.21	-18.01	QP	P
4	0.1860	9.98	17.65	27.63	54.21	-26.58	AVG	P
5	0.5220	9.95	34.86	44.81	56.00	-11.19	QP	P
6	0.5220	9.95	29.62	39.57	46.00	-6.43	AVG	P
7	11.5460	10.36	29.54	39.90	60.00	-20.10	QP	P
8	11.5460	10.36	24.71	35.07	50.00	-14.93	AVG	P
9	17.3900	10.53	18.47	29.00	60.00	-31.00	QP	P
10	17.3900	10.53	13.67	24.20	50.00	-25.80	AVG	P
11	20.9660	10.61	25.69	36.30	60.00	-23.70	QP	P
12	20.9660	10.61	23.35	33.96	50.00	-16.04	AVG	P

Note: Level = Reading + Factor
 Margin = Level – Limit
 Factor = (LISN, ISN, PLC or current probe) Factor + Cable Loss+ Attenuator



Power	: PoE	Pol/Phase	: LINE
Test Mode	: Mode 5 (5.8G Band)	Temperature	: 20 °C
Test date	: Dec. 15, 2016	Humidity	: 52 %

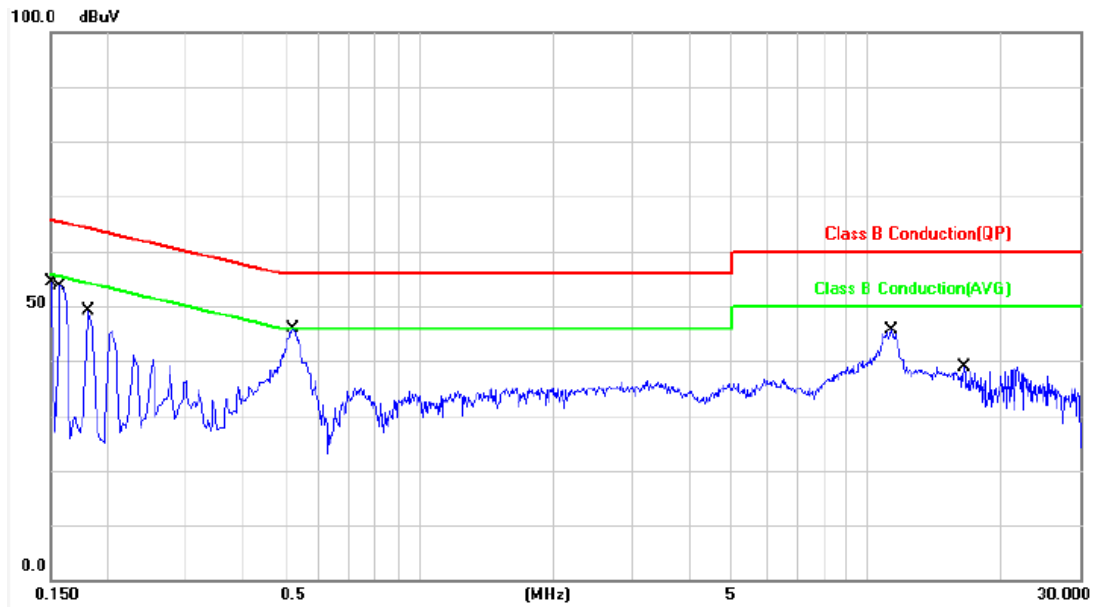

No.	Frequency (MHz)	Factor (dB)	Reading (dBuV)	Level (dBuV)	Limit (dBuV)	Margin (dB)	Detector	P/F
1	0.1500	9.98	42.45	52.43	65.99	-13.56	QP	P
2	0.1500	9.98	23.48	33.46	55.99	-22.53	AVG	P
3	0.1580	9.98	41.61	51.59	65.56	-13.97	QP	P
4	0.1580	9.98	23.38	33.36	55.56	-22.20	AVG	P
5	0.1819	9.97	36.91	46.88	64.39	-17.51	QP	P
6	0.1819	9.97	19.13	29.10	54.39	-25.29	AVG	P
7	0.5220	9.98	34.92	44.90	56.00	-11.10	QP	P
8	0.5220	9.98	29.61	39.59	46.00	-6.41	AVG	P
9	11.4220	10.30	31.23	41.53	60.00	-18.47	QP	P
10	11.4220	10.30	26.52	36.82	50.00	-13.18	AVG	P
11	16.5220	10.42	25.43	35.85	60.00	-24.15	QP	P
12	16.5220	10.42	21.15	31.57	50.00	-18.43	AVG	P

Note: Level = Reading + Factor
 Margin = Level – Limit
 Factor = (LISN, ISN, PLC or current probe) Factor + Cable Loss+ Attenuator



Power	: PoE	Pol/Phase	: NEUTRAL
Test Mode	: Mode 5 (5.8G Band)	Temperature	: 20 °C
Test date	: Dec. 15, 2016	Humidity	: 52 %

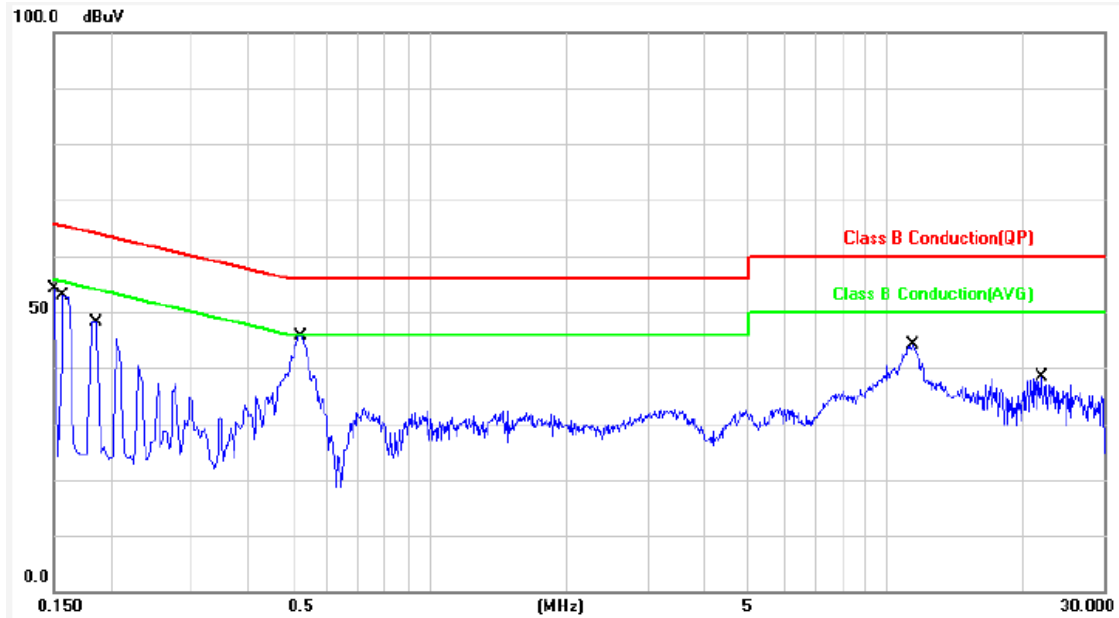

No.	Frequency (MHz)	Factor (dB)	Reading (dBuV)	Level (dBuV)	Limit (dBuV)	Margin (dB)	Detector	P/F
1	0.1500	9.98	42.09	52.07	65.99	-13.92	QP	P
2	0.1500	9.98	22.85	32.83	55.99	-23.16	AVG	P
3	0.1580	9.98	40.94	50.92	65.56	-14.64	QP	P
4	0.1580	9.98	22.16	32.14	55.56	-23.42	AVG	P
5	0.1860	9.98	35.40	45.38	64.21	-18.83	QP	P
6	0.1860	9.98	17.35	27.33	54.21	-26.88	AVG	P
7	0.5220	9.95	34.88	44.83	56.00	-11.17	QP	P
8	0.5220	9.95	29.60	39.55	46.00	-6.45	AVG	P
9	11.4700	10.36	29.61	39.97	60.00	-20.03	QP	P
10	11.4700	10.36	24.72	35.08	50.00	-14.92	AVG	P
11	21.9460	10.62	25.93	36.55	60.00	-23.45	QP	P
12	21.9460	10.62	24.57	35.19	50.00	-14.81	AVG	P

Note: Level = Reading + Factor
 Margin = Level – Limit
 Factor = (LISN, ISN, PLC or current probe) Factor + Cable Loss+ Attenuator



6. Test of Spurious Emission (Radiated)

6.1. Test Limit

Undesirable emission limits. Except as shown in paragraph (b)(7) of this section, the maximum emissions outside of the frequency bands of operation shall be attenuated in accordance with the following limits:

- (1) For transmitters operating in the 5.15-5.25 GHz band: All emissions outside of the 5.15-5.35 GHz band shall not exceed an e.i.r.p. of -27 dBm/MHz.
- (2) For transmitters operating in the 5.25-5.35 GHz band: All emissions outside of the 5.15-5.35 GHz band shall not exceed an e.i.r.p. of -27 dBm/MHz.
- (3) For transmitters operating in the 5.47-5.725 GHz band: All emissions outside of the 5.47-5.725 GHz band shall not exceed an e.i.r.p. of -27 dBm/MHz.
- (4) For transmitters operating in the 5.725-5.85 GHz band:
 - (i) All emissions shall be limited to a level of -27 dBm/MHz at 75 MHz or more above or below the band edge increasing linearly to 10 dBm/MHz at 25 MHz above or below the band edge, and from 25MHz above or below the band edge increasing linearly to a level of 15.6 dBm/MHz at 5 MHz above or below the band edge, and from 5 MHz above or below the band edge increasing linearly to a level of 27dBm/MHz at the band edge.
- (5) The emission measurements shall be performed using a minimum resolution bandwidth of 1 MHz. A lower resolution bandwidth may be employed near the band edge, when necessary, provided the measured energy is integrated to show the total power over 1 MHz.
- (6) Unwanted emissions below 1 GHz must comply with the general field strength limits set forth in §15.209. Further, any U-NII devices using an AC power line are required to comply also with the conducted limits set forth in §15.207.
- (7) The provisions of §15.205 apply to intentional radiators operating under this section.
- (8) When measuring the emission limits, the nominal carrier frequency shall be adjusted as close to the upper and lower frequency band edges as the design of the equipment permits.

6.2. Test Procedures

- a. The EUT was placed on a rotatable table top 0.8 meter above ground.
- b. The EUT was set 3 meters from the interference receiving antenna which was mounted on the top of a variable height antenna tower.
- c. The table was rotated 360 degrees to determine the position of the highest radiation.
- d. The antenna is a broadband antenna and its height is varied between one meter and four meters above ground to find the maximum value of the field strength both horizontal polarization and vertical polarization of the antenna are set to make the measurement.
- e. For each suspected emission the EUT was arranged to its worst case and then tune the antenna tower (from 1 M to 4 M) and turn table (from 0 degree to 360 degrees) to find the maximum reading.
- f. Set the test-receiver system to Peak or CISPR quasi-peak Detect Function and specified bandwidth with Maximum Hold Mode.
- g. If the emission level of the EUT in peak mode was 3 dB lower than the limit specified, then testing will be stopped and peak values of EUT will be reported, otherwise, the emissions which do not have 3 dB margin will be repeated one by one using the quasi-peak method and reported.
- h. For testing above 1GHz, the emission level of the EUT in peak mode was 20dB lower than average limit (that means the emission level in peak mode also complies with the limit in average mode), then testing will be stopped and peak values of EUT will be reported, otherwise, the emissions will be measured in average mode again and reported.
- i. "Cone of radiation" has been considered to be 3dB bandwidth of the measurement antenna.



6.3. Typical Test Setup

Below 30MHz test setup

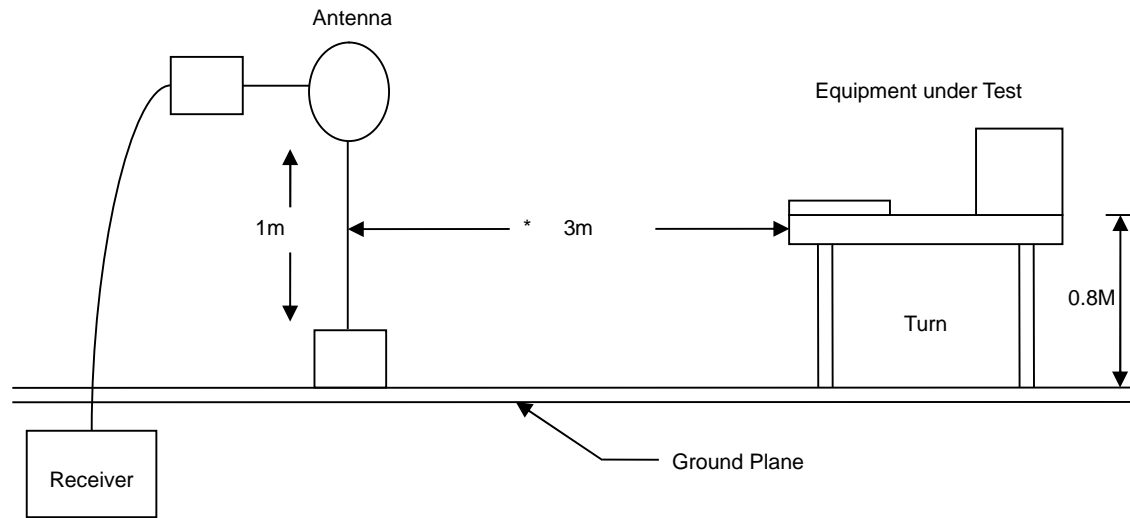

30MHz- 1GHz Test Setup

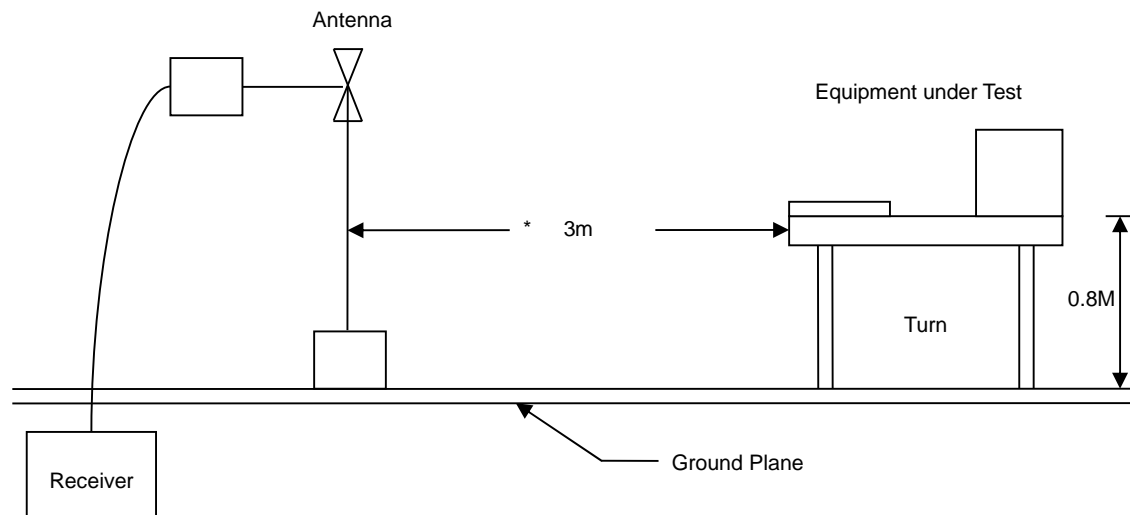

Above 1GHz Test Setup

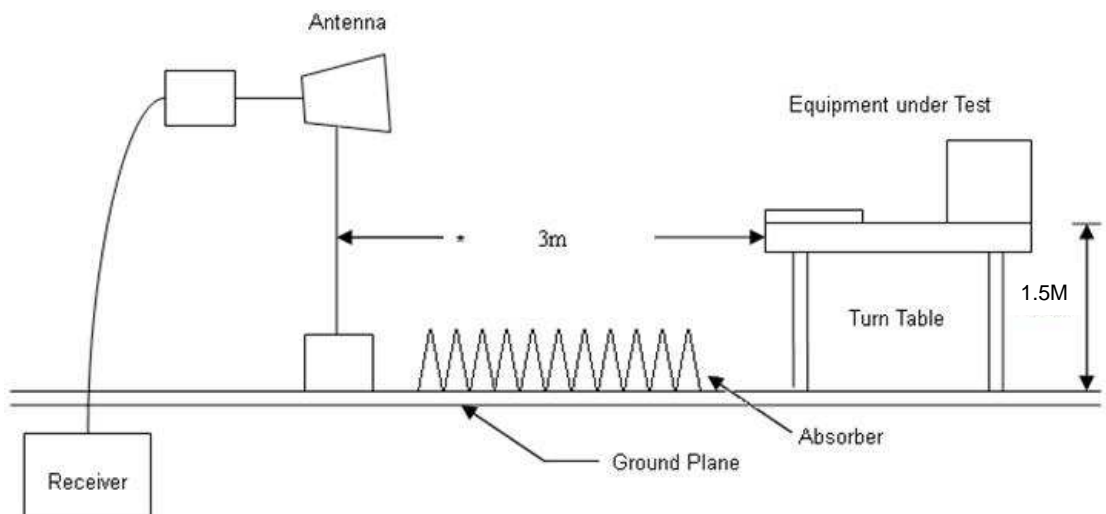



6.4. Test Result and Data (9kHz ~ 30MHz)

The 9kHz - 30MHz spurious emission is under limit 20dB more.

6.5. Test Result and Data (30MHz ~ 1GHz)

Power	: PoE	Pol/Phase	: VERTICAL
Test Mode	: Mode 5 (5.2G Band)	Temperature	: 25 °C
Test Date	: Dec. 14, 2016	Humidity	: 60 %

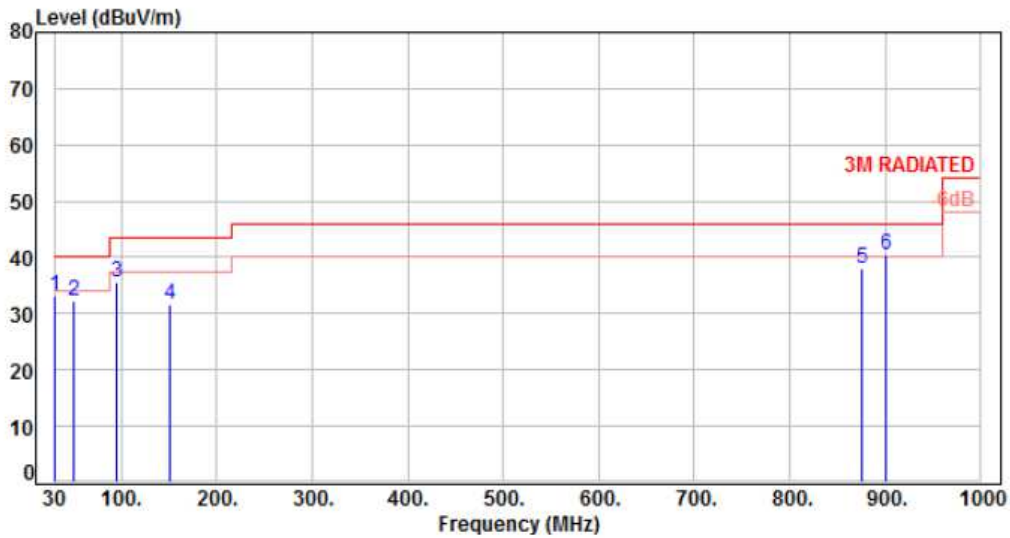

No.	Frequency (MHz)	Factor (dB)	Reading (dBUV)	Level (dBUV)	Limit (dBUV)	Margin (dB)	Detector	Height (cm)	Azimuth (deg)	P/F
1	30.00	-10.73	43.89	33.16	40.00	-6.84	QP	100	178	P
2	49.40	-9.73	41.85	32.12	40.00	-7.88	QP	100	177	P
3	95.96	-15.42	50.88	35.46	43.50	-8.04	Peak	100	0	P
4	150.28	-10.03	41.53	31.50	43.50	-12.00	Peak	100	0	P
5	875.84	1.87	36.25	38.12	46.00	-7.88	Peak	100	0	P
6	901.06	2.14	38.30	40.44	46.00	-5.56	QP	118	194	P

Note: Level=Reading+Factor
 Margin=Level-Limit
 Factor=Antenna Factor + cable loss - Amplifier Factor



Power	: PoE	Pol/Phase	: HORIZONTAL
Test Mode	: Mode 5 (5.2G Band)	Temperature	: 25 °C
Test Date	: Dec. 14, 2016	Humidity	: 60 %

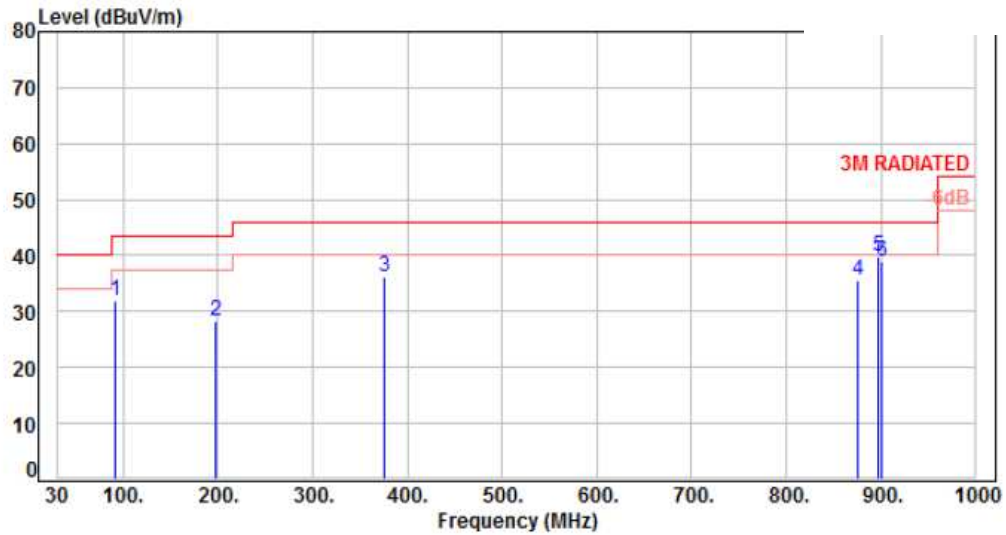

No.	Frequency (MHz)	Factor (dB)	Reading (dBuV)	Level (dBuV)	Limit (dBuV)	Margin (dB)	Detector	Height (cm)	Azimuth (deg)	P/F
1	92.08	-15.95	47.88	31.93	43.50	-11.57	Peak	100	0	P
2	196.84	-12.43	40.84	28.41	43.50	-15.09	Peak	100	0	P
3	375.32	-7.06	43.24	36.18	46.00	-9.82	Peak	100	0	P
4	875.84	1.87	33.67	35.54	46.00	-10.46	Peak	100	0	P
5	897.18	2.10	37.61	39.71	46.00	-6.29	Peak	100	0	P
6	901.06	2.14	36.79	38.93	46.00	-7.07	Peak	100	0	P

Note: Level=Reading+Factor
 Margin=Level-Limit
 Factor=Antenna Factor + cable loss - Amplifier Factor



Power	: PoE	Pol/Phase	: VERTICAL
Test Mode	: Mode 1 (5.8G Band)	Temperature	: 25 °C
Test Date	: Dec. 14, 2016	Humidity	: 60 %

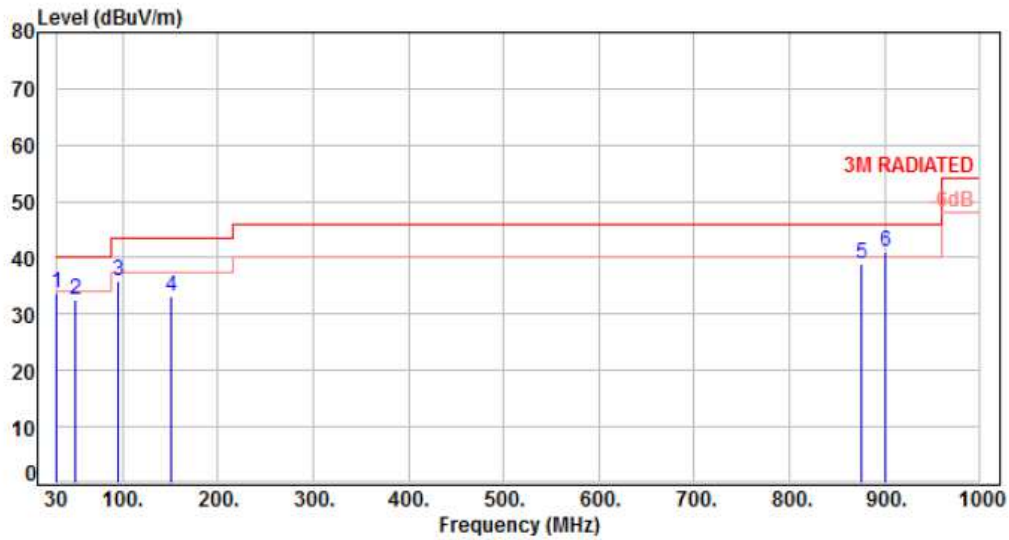

No.	Frequency (MHz)	Factor (dB)	Reading (dBuV)	Level (dBuV)	Limit (dBuV)	Margin (dB)	Detector	Height (cm)	Azimuth (deg)	P/F
1	30.00	-10.73	44.38	33.65	40.00	-6.35	QP	100	180	P
2	49.40	-9.73	42.35	32.62	40.00	-7.38	QP	100	180	P
3	95.96	-15.42	51.45	36.03	43.50	-7.47	Peak	100	0	P
4	150.28	-10.03	43.25	33.22	43.50	-10.28	Peak	100	0	P
5	875.84	1.87	37.13	39.00	46.00	-7.00	Peak	100	0	P
6	901.06	2.14	38.78	40.92	46.00	-5.08	QP	121	188	P

Note: Level=Reading+Factor
 Margin=Level-Limit
 Factor=Antenna Factor + cable loss - Amplifier Factor



Power	: PoE	Pol/Phase	: HORIZONTAL
Test Mode	: Mode 1 (5.8G Band)	Temperature	: 25 °C
Test Date	: Dec. 14, 2016	Humidity	: 60 %

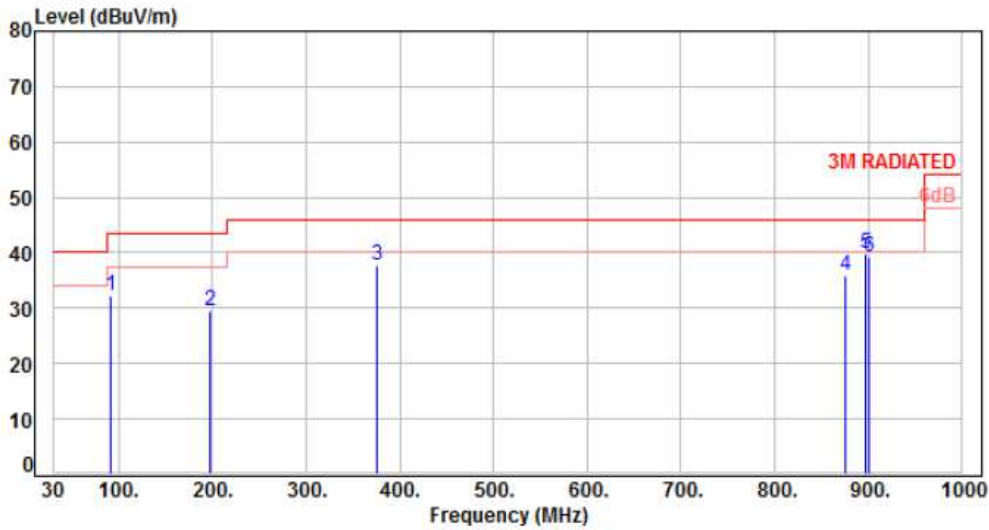

No.	Frequency (MHz)	Factor (dB)	Reading (dBuV)	Level (dBuV)	Limit (dBuV)	Margin (dB)	Detector	Height (cm)	Azimuth (deg)	P/F
1	92.08	-15.95	48.19	32.24	43.50	-11.26	Peak	100	0	P
2	196.84	-12.43	42.00	29.57	43.50	-13.93	Peak	100	0	P
3	375.32	-7.06	44.73	37.67	46.00	-8.33	Peak	100	0	P
4	875.84	1.87	34.11	35.98	46.00	-10.02	Peak	100	0	P
5	897.18	2.10	37.78	39.88	46.00	-6.12	Peak	100	0	P
6	901.06	2.14	36.97	39.11	46.00	-6.89	Peak	100	0	P

Note: Level=Reading+Factor
Margin=Level-Limit
Factor=Antenna Factor + cable loss - Amplifier Factor



6.6. Test Result and Data (1GHz ~ 40GHz)

Power	: PoE	Pol/Phase	: VERTICAL
Test Mode	: Mode 1, CH36	Temperature	: 25°C
Test Date	: Nov. 26, 2016	Humidity	: 60 %

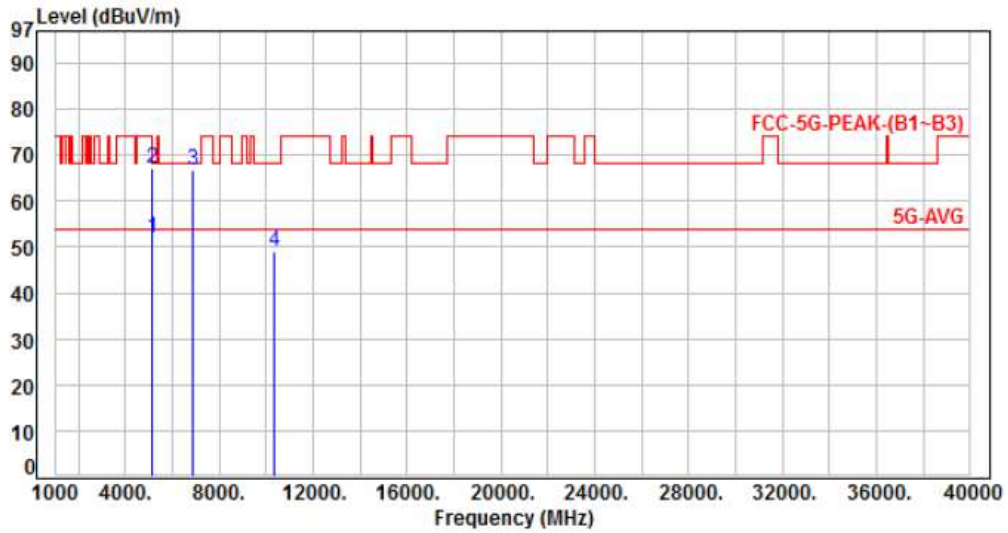

No.	Frequency (MHz)	Factor (dB)	Reading (dBuV)	Level (dBuV)	Limit (dBuV)	Margin (dB)	Detector	Height (cm)	Azimuth (deg)	P/F
1	5150.00	-6.47	58.50	52.03	54.00	-1.97	Average	222	308	P
2	5150.00	-6.47	73.50	67.03	74.00	-6.97	Peak	222	308	P
3	6906.00	-3.96	70.56	66.60	68.20	-1.60	Peak	165	310	P
4	10360.00	0.83	48.19	49.02	68.20	-19.18	Peak	125	156	P

Note: Level=Reading+Factor
Margin=Level-Limit
Factor=Antenna Factor + cable loss - Amplifier Factor



Power	: PoE	Pol/Phase	: HORIZONTAL
Test Mode	: Mode 1, CH36	Temperature	: 25°C
Test Date	: Nov. 26, 2016	Humidity	: 60 %

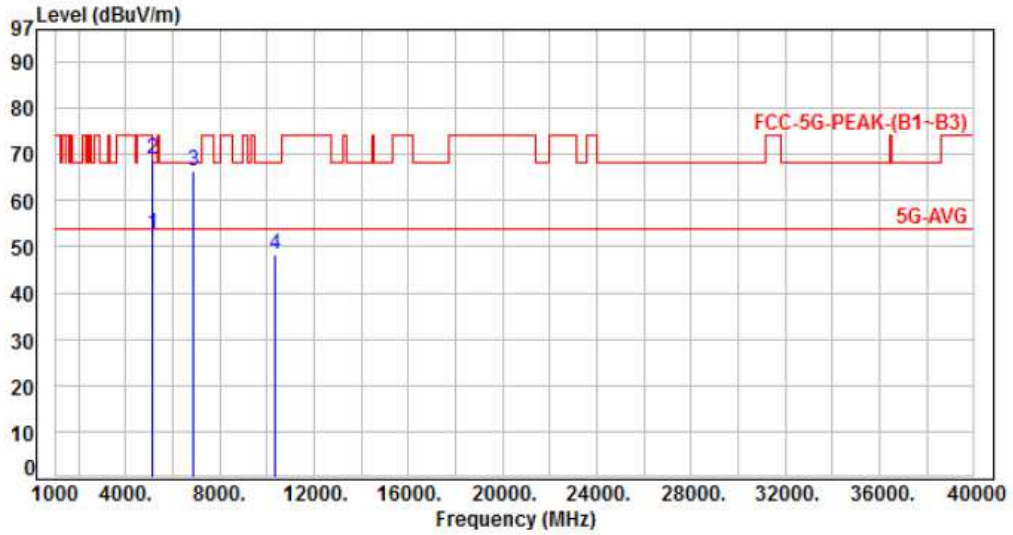

No.	Frequency (MHz)	Factor (dB)	Reading (dBuV)	Level (dBuV)	Limit (dBuV)	Margin (dB)	Detector	Height (cm)	Azimuth (deg)	P/F
1	5150.00	-6.47	59.06	52.59	54.00	-1.41	Average	225	358	P
2	5150.00	-6.47	75.48	69.01	74.00	-4.99	Peak	225	358	P
3	6906.00	-3.96	70.22	66.26	68.20	-1.94	Peak	271	30	P
4	10360.00	0.83	47.64	48.47	68.20	-19.73	Peak	155	49	P

Note: Level=Reading+Factor
Margin=Level-Limit
Factor=Antenna Factor + cable loss - Amplifier Factor



Power	: PoE	Pol/Phase	: VERTICAL
Test Mode	: Mode 1, CH44	Temperature	: 25°C
Test Date	: Nov. 26, 2016	Humidity	: 60%

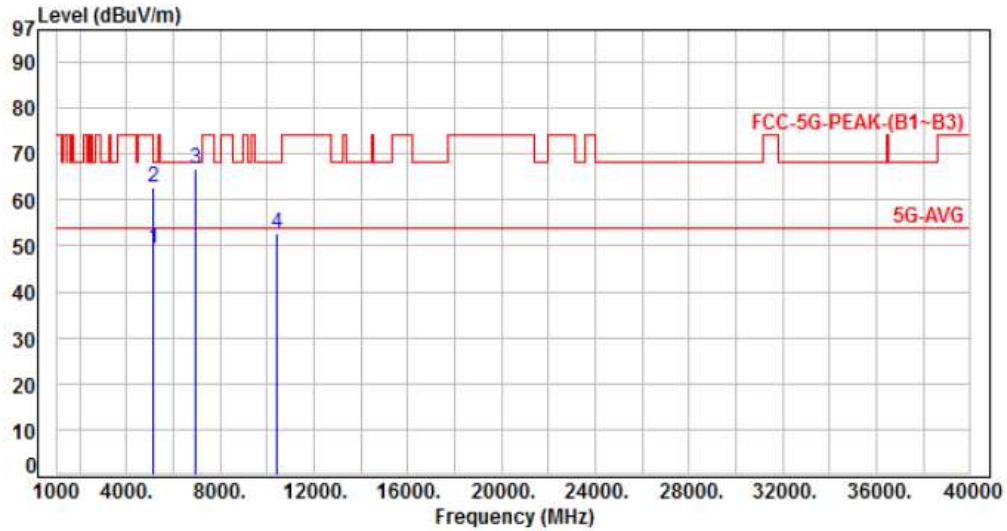

No.	Frequency (MHz)	Factor (dB)	Reading (dBuV)	Level (dBuV)	Limit (dBuV)	Margin (dB)	Detector	Height (cm)	Azimuth (deg)	P/F
1	5150.00	-6.47	56.06	49.59	54.00	-4.41	Average	248	317	P
2	5150.00	-6.47	69.12	62.65	74.00	-11.35	Peak	248	317	P
3	6960.00	-3.86	70.66	66.80	68.20	-1.40	Peak	111	304	P
4	10440.00	0.89	51.78	52.67	68.20	-15.53	Peak	212	337	P

Note: Level=Reading+Factor
 Margin=Level-Limit
 Factor=Antenna Factor + cable loss - Amplifier Factor



Power	: PoE	Pol/Phase	: HORIZONTAL
Test Mode	: Mode 1, CH44	Temperature	: 25°C
Test Date	: Nov. 26, 2016	Humidity	: 60%

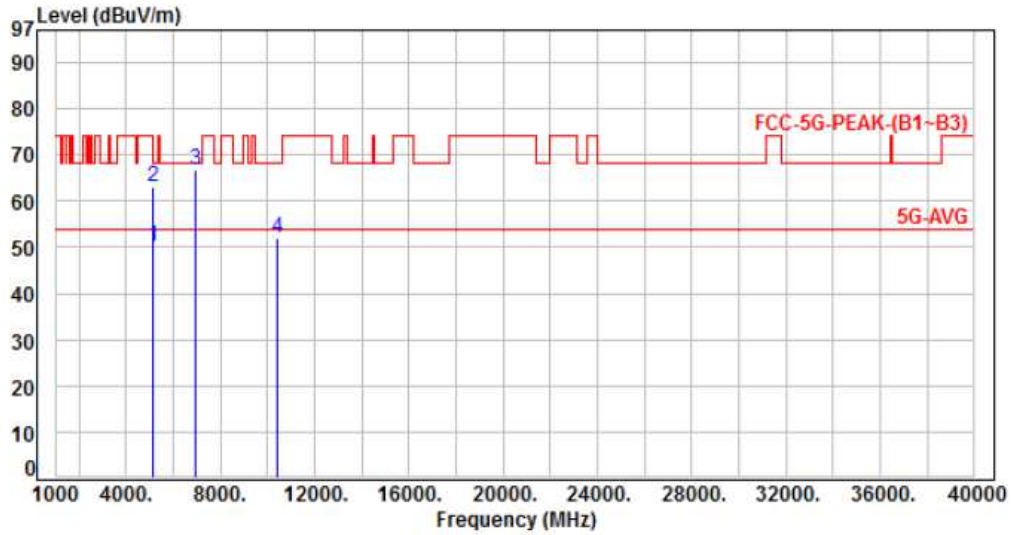

No.	Frequency (MHz)	Factor (dB)	Reading (dBuV)	Level (dBuV)	Limit (dBuV)	Margin (dB)	Detector	Height (cm)	Azimuth (deg)	P/F
1	5150.00	-6.47	56.48	50.01	54.00	-3.99	Average	169	83	P
2	5150.00	-6.47	69.49	63.02	74.00	-10.98	Peak	169	83	P
3	6960.00	-3.86	70.45	66.59	68.20	-1.61	Peak	138	248	P
4	10440.00	0.89	51.26	52.15	68.20	-16.05	Peak	168	102	P

Note: Level=Reading+Factor
 Margin=Level-Limit
 Factor=Antenna Factor + cable loss - Amplifier Factor



Power	:	PoE	Pol/Phase	:	VERTICAL
Test Mode	:	Mode 1, CH48	Temperature	:	25°C
Test Date	:	Nov. 26, 2016	Humidity	:	60%

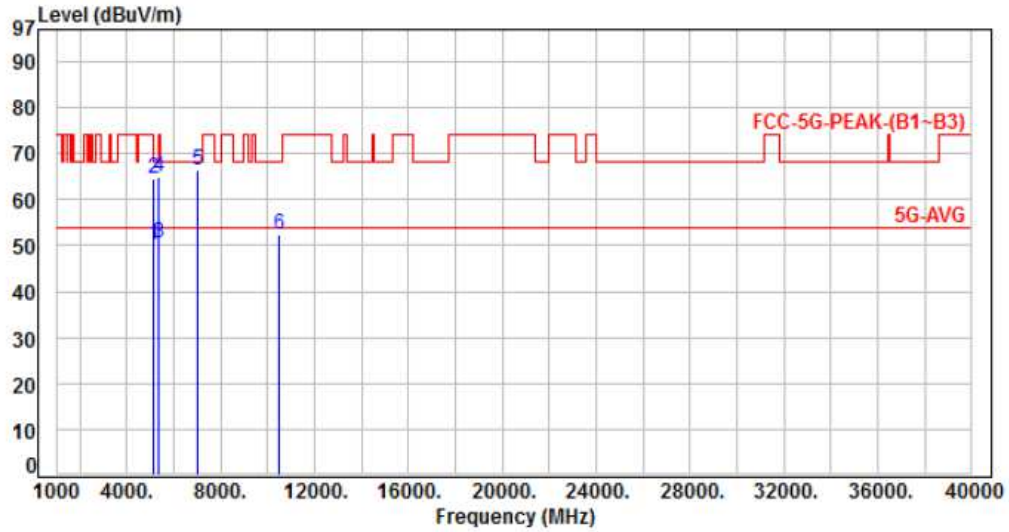

No.	Frequency (MHz)	Factor (dB)	Reading (dBuV)	Level (dBuV)	Limit (dBuV)	Margin (dB)	Detector	Height (cm)	Azimuth (deg)	P/F
1	5150.00	-6.47	56.73	50.26	54.00	-3.74	Average	127	325	P
2	5150.00	-6.47	70.87	64.40	74.00	-9.60	Peak	127	325	P
3	5350.00	-6.03	56.65	50.62	54.00	-3.38	Average	129	302	P
4	5350.00	-6.03	71.10	65.07	74.00	-8.93	Peak	129	302	P
5	6986.66	-3.81	70.23	66.42	68.20	-1.78	Peak	100	305	P
6	10480.00	0.92	51.46	52.38	68.20	-15.82	Peak	139	298	P

Note: Level=Reading+Factor
 Margin=Level-Limit
 Factor=Antenna Factor + cable loss - Amplifier Factor



Power	: PoE	Pol/Phase	: HORIZONTAL
Test Mode	: Mode 1, CH48	Temperature	: 25°C
Test Date	: Nov. 26, 2016	Humidity	: 60%

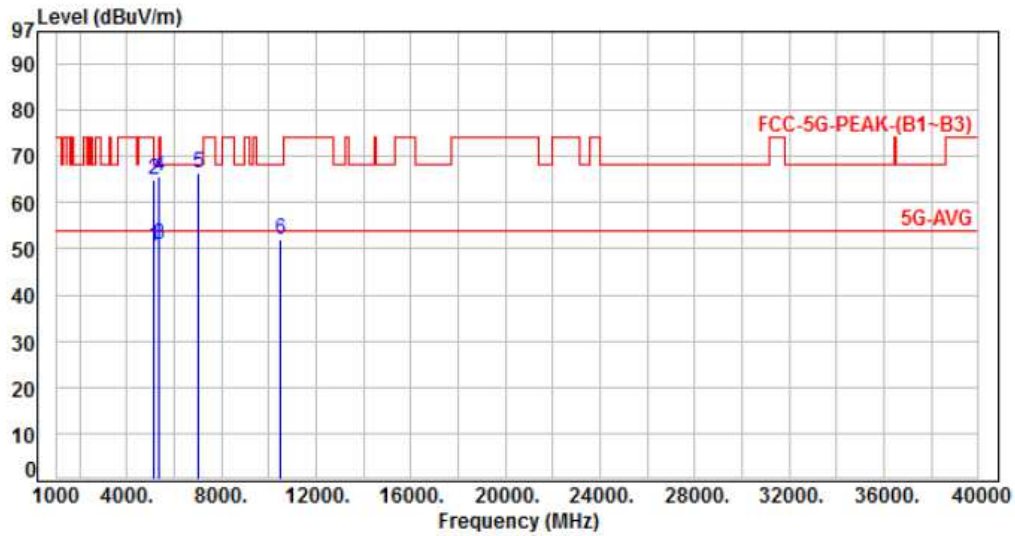

No.	Frequency (MHz)	Factor (dB)	Reading (dBuV)	Level (dBuV)	Limit (dBuV)	Margin (dB)	Detector	Height (cm)	Azimuth (deg)	P/F
1	5150.00	-6.47	56.92	50.45	54.00	-3.55	Average	269	255	P
2	5150.00	-6.47	71.37	64.90	74.00	-9.10	Peak	269	255	P
3	5350.00	-6.03	57.02	50.99	54.00	-3.01	Average	248	232	P
4	5350.00	-6.03	71.62	65.59	74.00	-8.41	Peak	248	232	P
5	6986.66	-3.81	70.07	66.26	68.20	-1.94	Peak	196	153	P
6	10480.00	0.92	50.98	51.90	68.20	-16.30	Peak	278	136	P

Note: Level=Reading+Factor
Margin=Level-Limit
Factor=Antenna Factor + cable loss - Amplifier Factor



Power	: PoE	Pol/Phase	: VERTICAL
Test Mode	: Mode 4, CH36	Temperature	: 25°C
Test Date	: Nov. 26, 2016	Humidity	: 60%

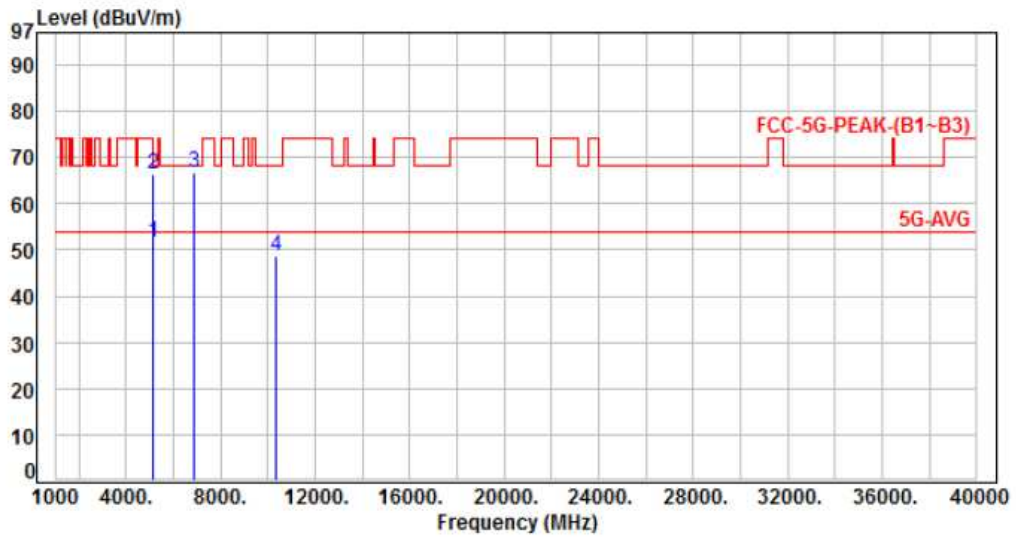

No.	Frequency (MHz)	Factor (dB)	Reading (dBuV)	Level (dBuV)	Limit (dBuV)	Margin (dB)	Detector	Height (cm)	Azimuth (deg)	P/F
1	5150.00	-6.47	58.13	51.66	54.00	-2.34	Average	131	298	P
2	5150.00	-6.47	72.96	66.49	74.00	-7.51	Peak	131	298	P
3	6906.00	-3.96	70.73	66.77	68.20	-1.43	Peak	162	321	P
4	10360.00	0.83	47.83	48.66	68.20	-19.54	Peak	122	151	P

Note: Level=Reading+Factor
 Margin=Level-Limit
 Factor=Antenna Factor + cable loss - Amplifier Factor



Power	: PoE	Pol/Phase	: HORIZONTAL
Test Mode	: Mode 4, CH36	Temperature	: 25°C
Test Date	: Nov. 26, 2016	Humidity	: 60%

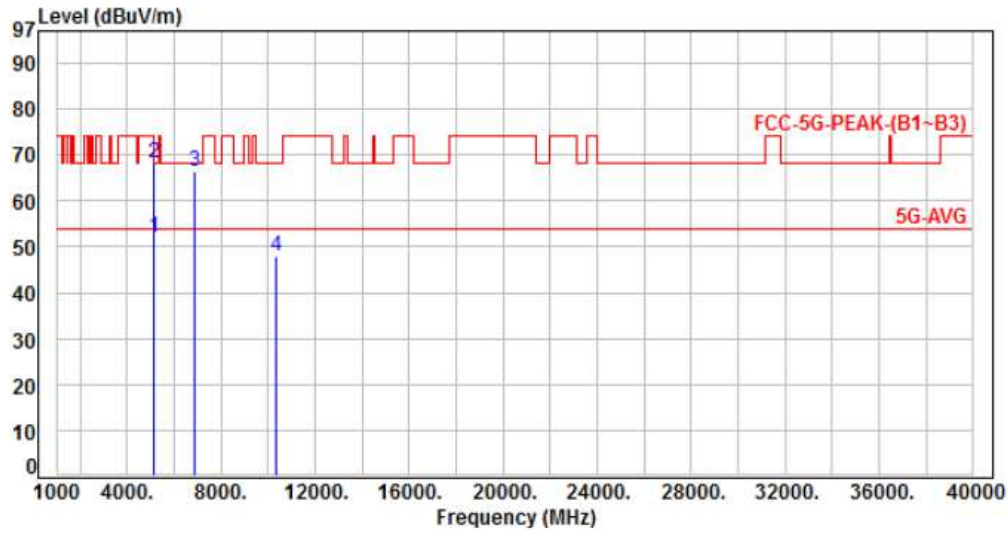

No.	Frequency (MHz)	Factor (dB)	Reading (dBuV)	Level (dBuV)	Limit (dBuV)	Margin (dB)	Detector	Height (cm)	Azimuth (deg)	P/F
1	5150.00	-6.47	58.53	52.06	54.00	-1.94	Average	361	322	P
2	5150.00	-6.47	74.64	68.17	74.00	-5.83	Peak	361	322	P
3	6906.00	-3.96	70.37	66.41	68.20	-1.79	Peak	270	32	P
4	10360.00	0.83	47.12	47.95	68.20	-20.25	Peak	153	56	P

Note: Level=Reading+Factor
Margin=Level-Limit
Factor=Antenna Factor + cable loss - Amplifier Factor



Power	: PoE	Pol/Phase	: VERTICAL
Test Mode	: Mode 4, CH44	Temperature	: 25°C
Test Date	: Nov. 26, 2016	Humidity	: 60%

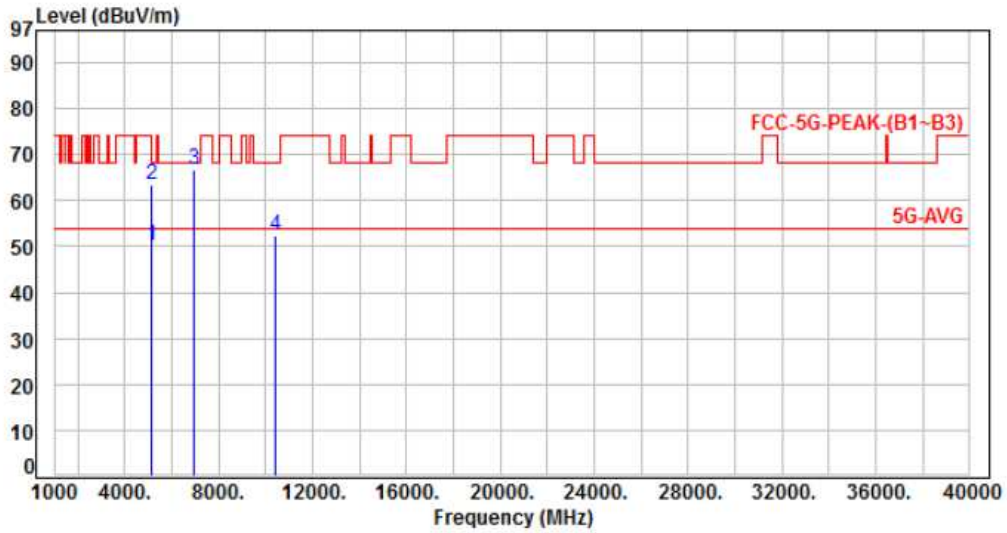

No.	Frequency (MHz)	Factor (dB)	Reading (dBuV)	Level (dBuV)	Limit (dBuV)	Margin (dB)	Detector	Height (cm)	Azimuth (deg)	P/F
1	5150.00	-6.47	56.65	50.18	54.00	-3.82	Average	231	308	P
2	5150.00	-6.47	69.89	63.42	74.00	-10.58	Peak	231	308	P
3	6960.00	-3.86	70.57	66.71	68.20	-1.49	Peak	109	306	P
4	10440.00	0.89	51.51	52.40	68.20	-15.80	Peak	210	333	P

Note: Level=Reading+Factor
Margin=Level-Limit
Factor=Antenna Factor + cable loss - Amplifier Factor



Power	: PoE	Pol/Phase	: HORIZONTAL
Test Mode	: Mode 4, CH44	Temperature	: 25°C
Test Date	: Nov. 26, 2016	Humidity	: 60%

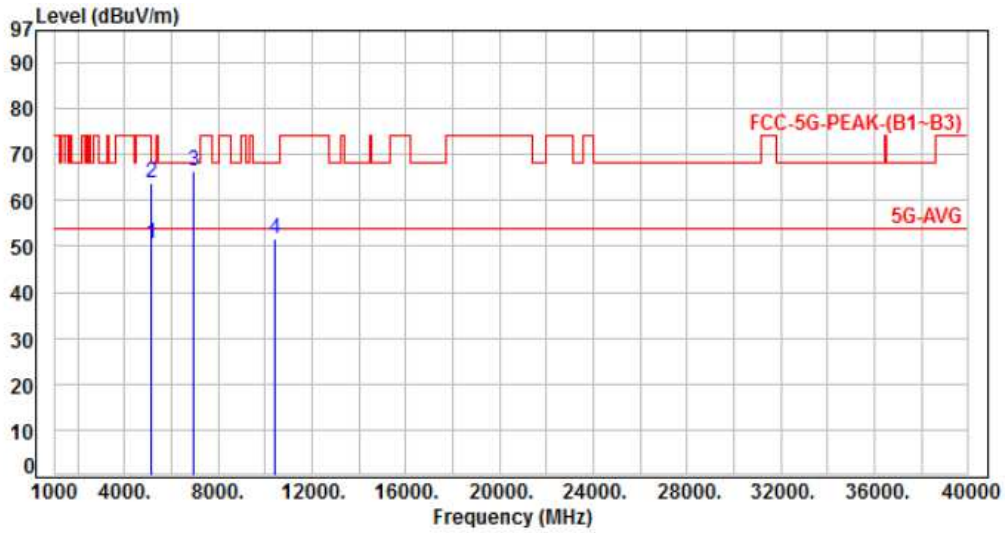

No.	Frequency (MHz)	Factor (dB)	Reading (dBuV)	Level (dBuV)	Limit (dBuV)	Margin (dB)	Detector	Height (cm)	Azimuth (deg)	P/F
1	5150.00	-6.47	56.93	50.46	54.00	-3.54	Average	172	89	P
2	5150.00	-6.47	70.12	63.65	74.00	-10.35	Peak	172	89	P
3	6960.00	-3.86	70.31	66.45	68.20	-1.75	Peak	141	250	P
4	10440.00	0.89	50.83	51.72	68.20	-16.48	Peak	172	99	P

Note: Level=Reading+Factor
 Margin=Level-Limit
 Factor=Antenna Factor + cable loss - Amplifier Factor



Power	: PoE	Pol/Phase	: VERTICAL
Test Mode	: Mode 4, CH48	Temperature	: 25°C
Test Date	: Nov. 26, 2016	Humidity	: 60%

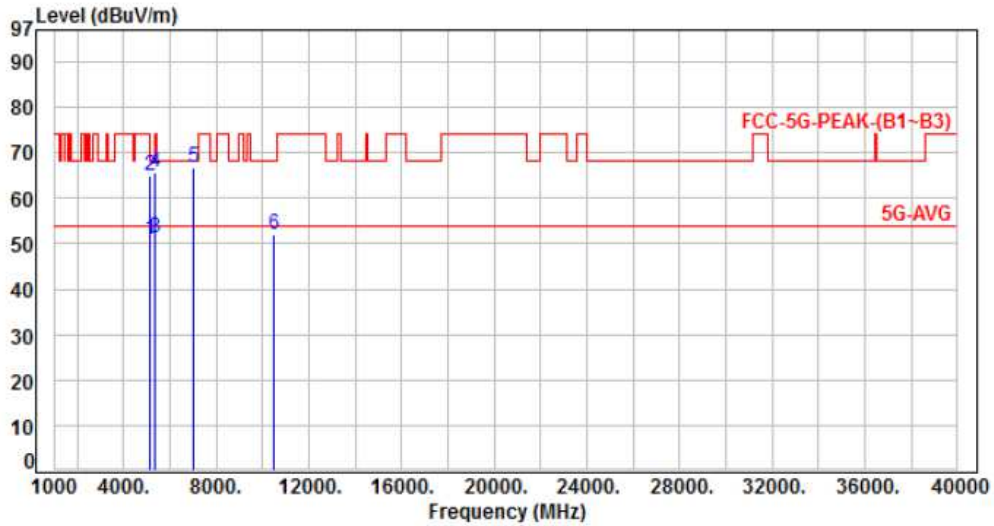

No.	Frequency (MHz)	Factor (dB)	Reading (dBuV)	Level (dBuV)	Limit (dBuV)	Margin (dB)	Detector	Height (cm)	Azimuth (deg)	P/F
1	5150.00	-6.47	57.26	50.79	54.00	-3.21	Average	133	321	P
2	5150.00	-6.47	71.55	65.08	74.00	-8.92	Peak	133	321	P
3	5350.00	-6.03	57.22	51.19	54.00	-2.81	Average	140	291	P
4	5350.00	-6.03	71.68	65.65	74.00	-8.35	Peak	140	291	P
5	6986.66	-3.81	70.39	66.58	68.20	-1.62	Peak	102	303	P
6	10480.00	0.92	51.24	52.16	68.20	-16.04	Peak	122	281	P

Note: Level=Reading+Factor
 Margin=Level-Limit
 Factor=Antenna Factor + cable loss - Amplifier Factor



Power	: PoE	Pol/Phase	: HORIZONTAL
Test Mode	: Mode 4, CH48	Temperature	: 25°C
Test Date	: Nov. 26, 2016	Humidity	: 60%

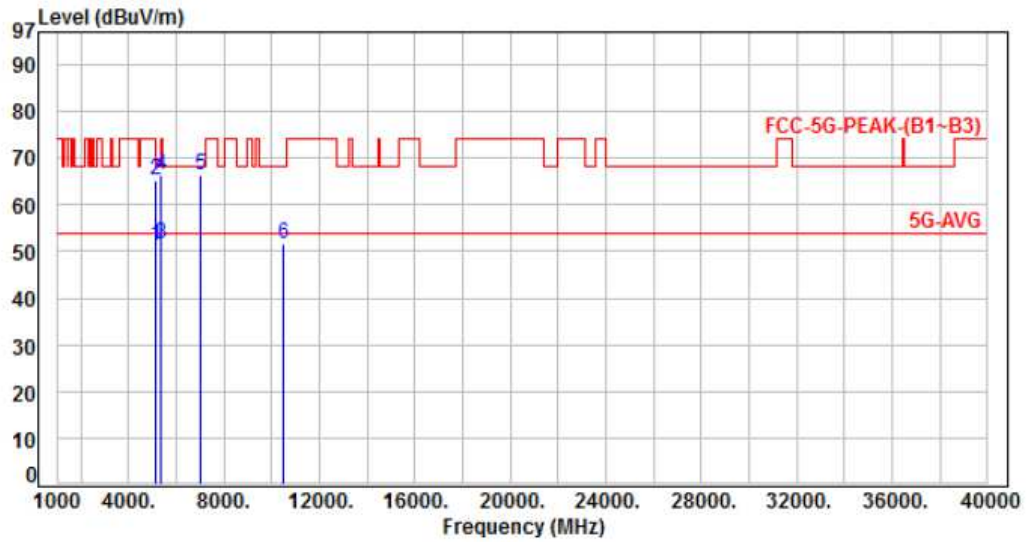

No.	Frequency (MHz)	Factor (dB)	Reading (dBuV)	Level (dBuV)	Limit (dBuV)	Margin (dB)	Detector	Height (cm)	Azimuth (deg)	P/F
1	5150.00	-6.47	57.61	51.14	54.00	-2.86	Average	275	288	P
2	5150.00	-6.47	71.86	65.39	74.00	-8.61	Peak	275	288	P
3	5350.00	-6.03	57.71	51.68	54.00	-2.32	Average	256	211	P
4	5350.00	-6.03	72.37	66.34	74.00	-7.66	Peak	256	211	P
5	6986.66	-3.81	70.11	66.30	68.20	-1.90	Peak	202	161	P
6	10480.00	0.92	50.58	51.50	68.20	-16.70	Peak	280	144	P

Note: Level=Reading+Factor
 Margin=Level-Limit
 Factor=Antenna Factor + cable loss - Amplifier Factor



Power	: PoE	Pol/Phase	: VERTICAL
Test Mode	: Mode 5, CH38	Temperature	: 25°C
Test Date	: Nov. 26, 2016	Humidity	: 60%

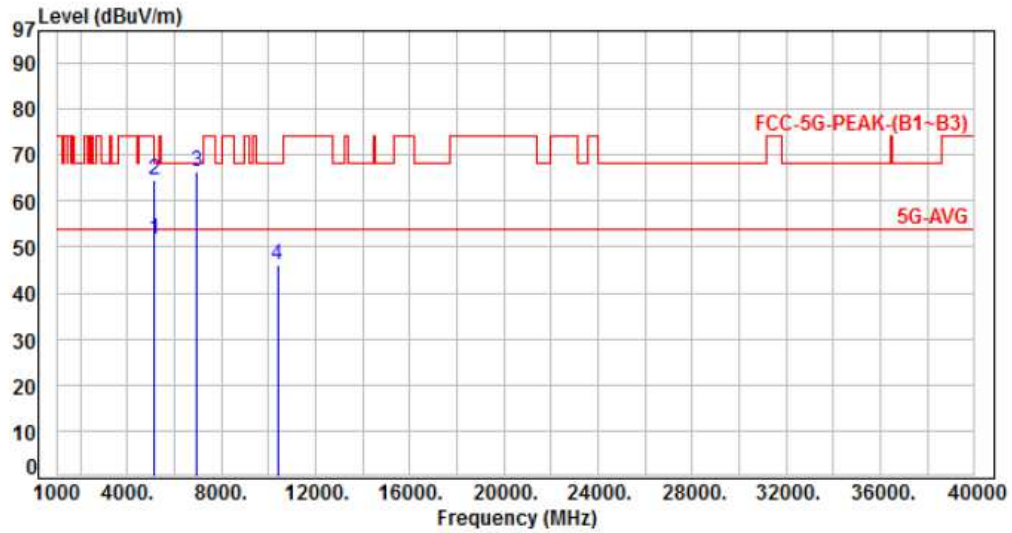

No.	Frequency (MHz)	Factor (dB)	Reading (dBuV)	Level (dBuV)	Limit (dBuV)	Margin (dB)	Detector	Height (cm)	Azimuth (deg)	P/F
1	5150.00	-6.47	58.17	51.70	54.00	-2.30	Average	244	269	P
2	5150.00	-6.47	70.87	64.40	74.00	-9.60	Peak	244	269	P
3	6920.00	-3.93	70.24	66.31	68.20	-1.89	Peak	112	345	P
4	10380.00	0.85	45.37	46.22	68.20	-21.98	Peak	212	288	P

Note: Level=Reading+Factor
Margin=Level-Limit
Factor=Antenna Factor + cable loss - Amplifier Factor



Power	: PoE	Pol/Phase	: HORIZONTAL
Test Mode	: Mode 5, CH38	Temperature	: 25°C
Test Date	: Nov. 26, 2016	Humidity	: 60%

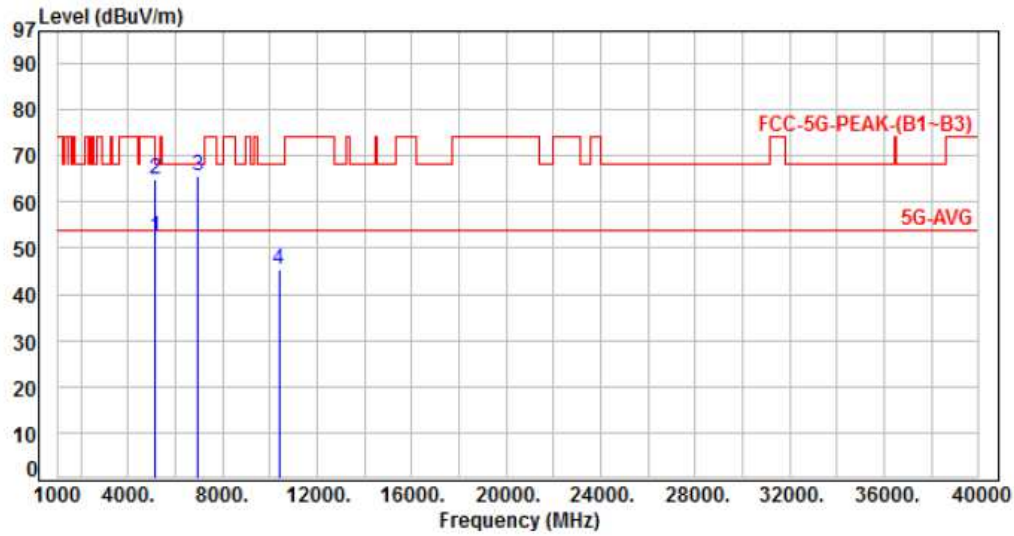

No.	Frequency (MHz)	Factor (dB)	Reading (dBuV)	Level (dBuV)	Limit (dBuV)	Margin (dB)	Detector	Height (cm)	Azimuth (deg)	P/F
1	5150.00	-6.47	58.71	52.24	54.00	-1.76	Average	352	339	P
2	5150.00	-6.47	71.29	64.82	74.00	-9.18	Peak	352	339	P
3	6920.00	-3.93	69.69	65.76	68.20	-2.44	Peak	194	360	P
4	10380.00	0.85	44.61	45.46	68.20	-22.74	Peak	182	341	P

Note: Level=Reading+Factor
 Margin=Level-Limit
 Factor=Antenna Factor + cable loss - Amplifier Factor



Power	: PoE	Pol/Phase	: VERTICAL
Test Mode	: Mode 5, CH46	Temperature	: 25°C
Test Date	: Nov. 26, 2016	Humidity	: 60%

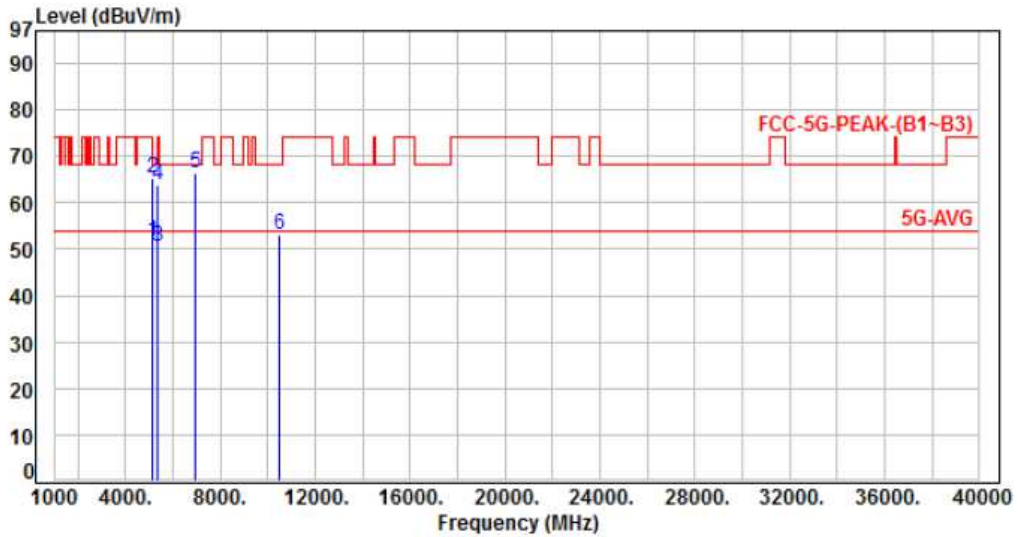

No.	Frequency (MHz)	Factor (dB)	Reading (dBuV)	Level (dBuV)	Limit (dBuV)	Margin (dB)	Detector	Height (cm)	Azimuth (deg)	P/F
1	5150.00	-6.47	58.24	51.77	54.00	-2.23	Average	212	237	P
2	5150.00	-6.47	71.59	65.12	74.00	-8.88	Peak	212	237	P
3	5350.00	-6.03	56.45	50.42	54.00	-3.58	Average	224	251	P
4	5350.00	-6.03	69.81	63.78	74.00	-10.22	Peak	224	251	P
5	6973.33	-3.82	70.10	66.28	68.20	-1.92	Peak	207	308	P
6	10460.00	0.91	52.16	53.07	68.20	-15.13	Peak	198	212	P

Note: Level=Reading+Factor
 Margin=Level-Limit
 Factor=Antenna Factor + cable loss - Amplifier Factor



Power	: PoE	Pol/Phase	: HORIZONTAL
Test Mode	: Mode 5, CH46	Temperature	: 25°C
Test Date	: Nov. 26, 2016	Humidity	: 60%

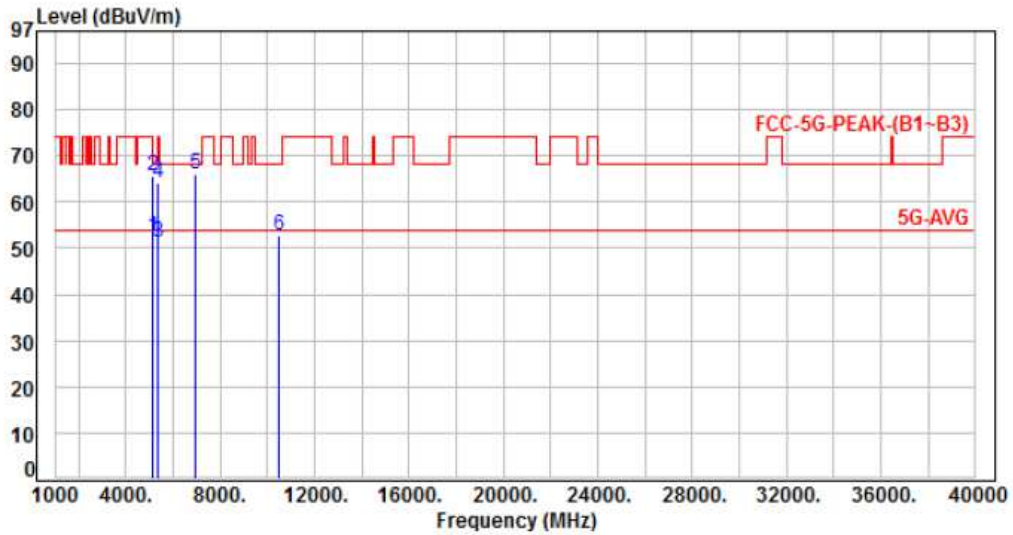

No.	Frequency (MHz)	Factor (dB)	Reading (dBuV)	Level (dBuV)	Limit (dBuV)	Margin (dB)	Detector	Height (cm)	Azimuth (deg)	P/F
1	5150.00	-6.47	58.76	52.29	54.00	-1.71	Average	178	360	P
2	5150.00	-6.47	72.14	65.67	74.00	-8.33	Peak	178	360	P
3	5350.00	-6.03	57.12	51.09	54.00	-2.91	Average	174	352	P
4	5350.00	-6.03	70.24	64.21	74.00	-9.79	Peak	174	352	P
5	6973.33	-3.82	69.72	65.90	68.20	-2.30	Peak	102	337	P
6	10460.00	0.91	51.87	52.78	68.20	-15.42	Peak	100	289	P

Note: Level=Reading+Factor
 Margin=Level-Limit
 Factor=Antenna Factor + cable loss - Amplifier Factor



Power	: PoE	Pol/Phase	: VERTICAL
Test Mode	: Mode 6, CH42	Temperature	: 25°C
Test Date	: Nov. 26, 2016	Humidity	: 60%

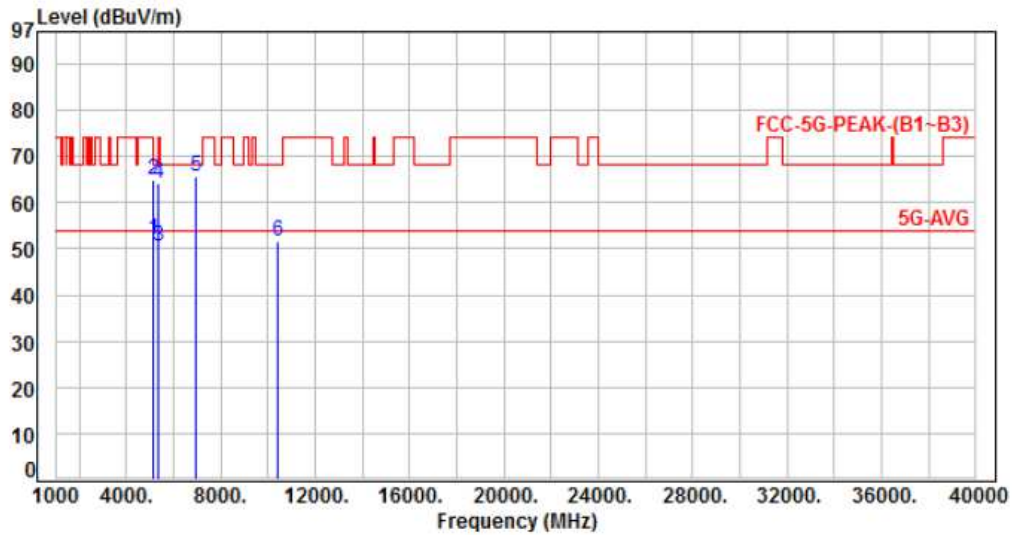

No.	Frequency (MHz)	Factor (dB)	Reading (dBuV)	Level (dBuV)	Limit (dBuV)	Margin (dB)	Detector	Height (cm)	Azimuth (deg)	P/F
1	5150.00	-6.47	58.36	51.89	54.00	-2.11	Average	100	316	P
2	5150.00	-6.47	71.39	64.92	74.00	-9.08	Peak	100	316	P
3	5350.00	-6.03	56.72	50.69	54.00	-3.31	Average	137	288	P
4	5350.00	-6.03	70.21	64.18	74.00	-9.82	Peak	137	288	P
5	6946.66	-3.89	69.46	65.57	68.20	-2.63	Peak	266	231	P
6	10420.00	0.88	50.88	51.76	68.20	-16.44	Peak	102	322	P

Note: Level=Reading+Factor
 Margin=Level-Limit
 Factor=Antenna Factor + cable loss - Amplifier Factor



Power	: PoE	Pol/Phase	: HORIZONTAL
Test Mode	: Mode 6, CH42	Temperature	: 25°C
Test Date	: Nov. 26, 2016	Humidity	: 60%

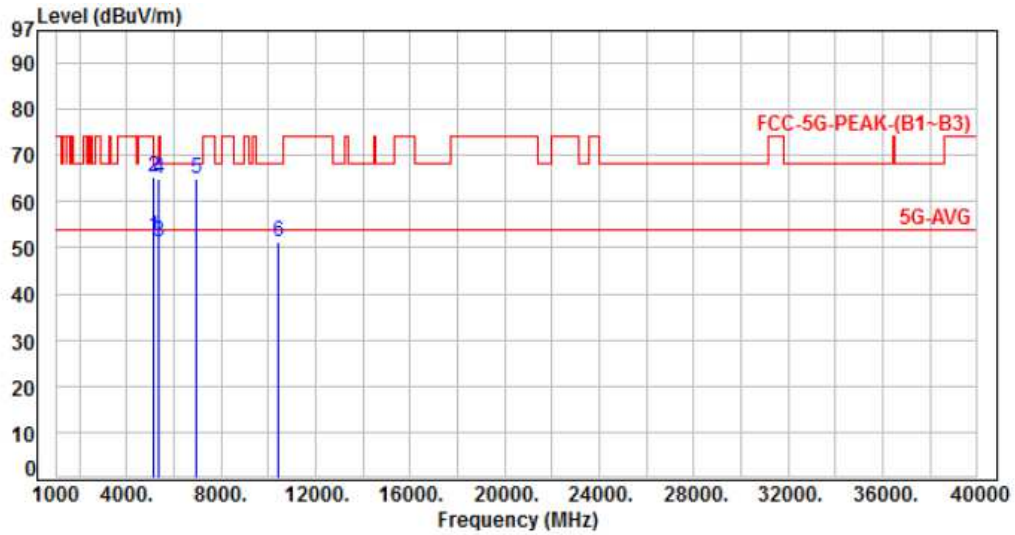

No.	Frequency (MHz)	Factor (dB)	Reading (dBuV)	Level (dBuV)	Limit (dBuV)	Margin (dB)	Detector	Height (cm)	Azimuth (deg)	P/F
1	5150.00	-6.47	58.96	52.49	54.00	-1.51	Average	204	358	P
2	5150.00	-6.47	71.90	65.43	74.00	-8.57	Peak	204	358	P
3	5350.00	-6.03	57.16	51.13	54.00	-2.87	Average	200	347	P
4	5350.00	-6.03	70.77	64.74	74.00	-9.26	Peak	200	347	P
5	6946.66	-3.89	68.71	64.82	68.20	-3.38	Peak	367	30	P
6	10420.00	0.88	50.29	51.17	68.20	-17.03	Peak	193	82	P

Note: Level=Reading+Factor
 Margin=Level-Limit
 Factor=Antenna Factor + cable loss - Amplifier Factor



Power	: PoE	Pol/Phase	: VERTICAL
Test Mode	: Mode 1, CH149	Temperature	: 25°C
Test Date	: Nov. 26, 2016	Humidity	: 60%

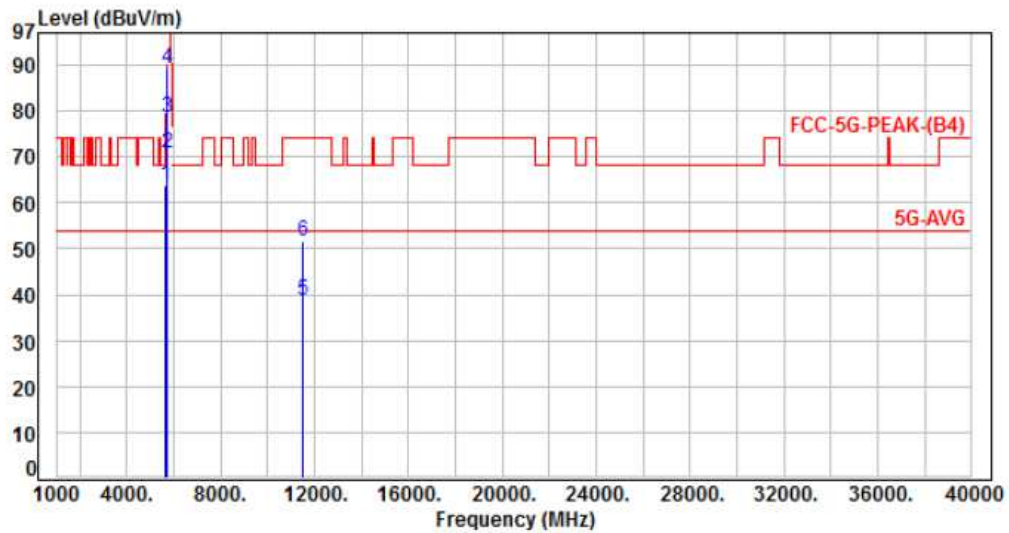

No.	Frequency (MHz)	Factor (dB)	Reading (dBuV)	Level (dBuV)	Limit (dBuV)	Margin (dB)	Detector	Height (cm)	Azimuth (deg)	P/F
1	5650.00	-5.77	69.60	63.83	68.20	-4.37	Peak	190	338	P
2	5700.00	-5.79	76.66	70.87	105.20	-34.33	Peak	190	338	P
3	5720.00	-5.80	84.43	78.63	110.80	-32.17	Peak	190	338	P
4	5725.00	-5.80	95.03	89.23	122.20	-32.97	Peak	190	338	P
5	11490.00	2.06	36.74	38.80	54.00	-15.20	Average	118	160	P
6	11490.00	2.06	49.50	51.56	74.00	-22.44	Peak	118	160	P

Note: Level=Reading+Factor
 Margin=Level-Limit
 Factor=Antenna Factor + cable loss - Amplifier Factor



Power	: PoE	Pol/Phase	: HORIZONTAL
Test Mode	: Mode 1, CH149	Temperature	: 25°C
Test Date	: Nov. 26, 2016	Humidity	: 60%

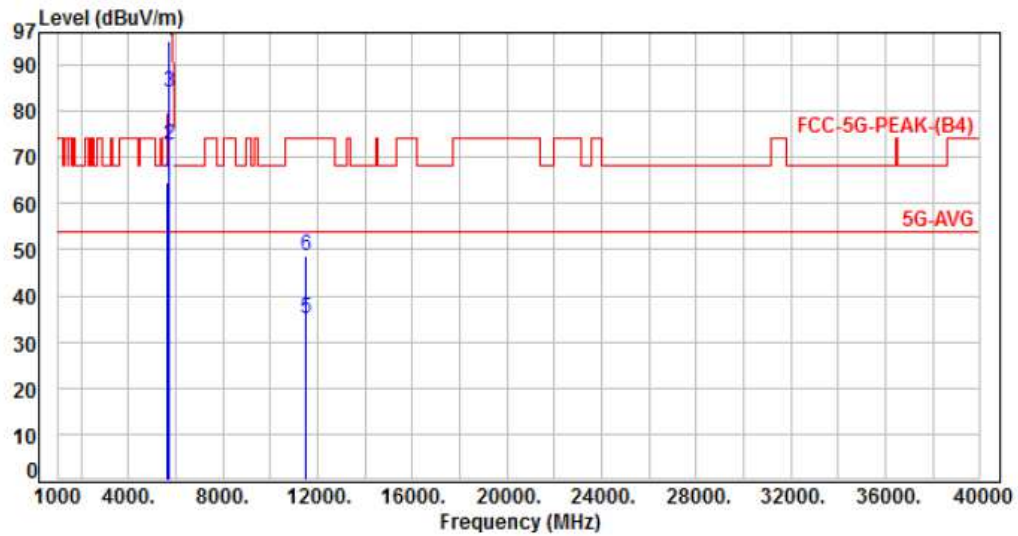

No.	Frequency (MHz)	Factor (dB)	Reading (dBuV)	Level (dBuV)	Limit (dBuV)	Margin (dB)	Detector	Height (cm)	Azimuth (deg)	P/F
1	5650.00	-5.77	70.23	64.46	68.20	-3.74	Peak	187	333	P
2	5700.00	-5.79	78.33	72.54	105.20	-32.66	Peak	187	333	P
3	5720.00	-5.80	89.98	84.18	110.80	-26.62	Peak	187	333	P
4	5725.00	-5.80	101.02	95.22	122.20	-26.98	Peak	187	333	P
5	11490.00	2.06	33.14	35.20	54.00	-18.80	Average	243	349	P
6	11490.00	2.06	46.80	48.86	74.00	-25.14	Peak	243	349	P

Note: Level=Reading+Factor
Margin=Level-Limit
Factor=Antenna Factor + cable loss - Amplifier Factor



Power	: PoE	Pol/Phase	: VERTICAL
Test Mode	: Mode 1, CH157	Temperature	: 25°C
Test Date	: Nov. 26, 2016	Humidity	: 60%

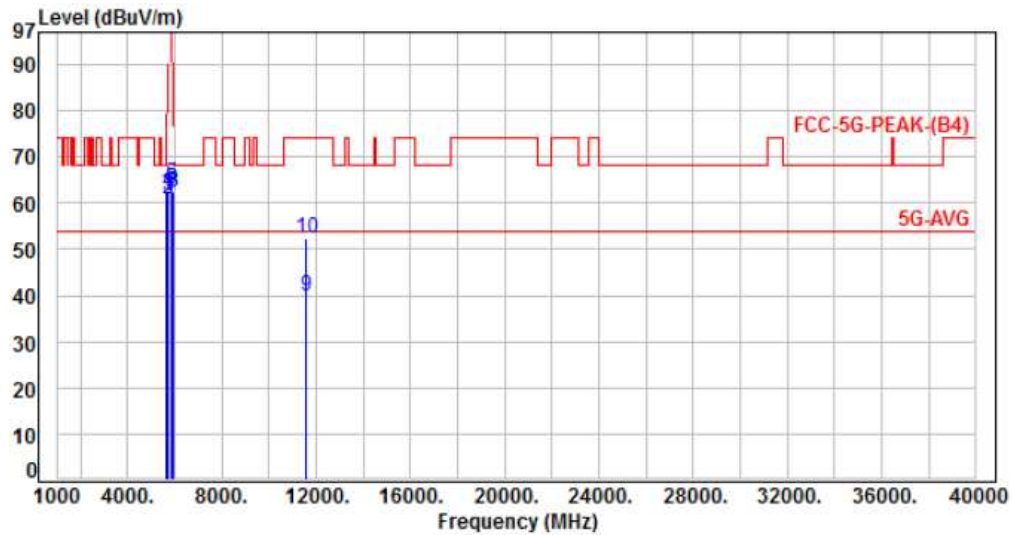

No.	Frequency (MHz)	Factor (dB)	Reading (dBuV)	Level (dBuV)	Limit (dBuV)	Margin (dB)	Detector	Height (cm)	Azimuth (deg)	P/F
1	5650.00	-5.77	68.03	62.26	68.20	-5.94	Peak	182	341	P
2	5700.00	-5.79	66.80	61.01	105.20	-44.19	Peak	182	341	P
3	5720.00	-5.80	67.46	61.66	110.80	-49.14	Peak	182	341	P
4	5725.00	-5.80	68.22	62.42	122.20	-59.78	Peak	182	341	P
5	5850.00	-5.84	69.98	64.14	122.20	-58.06	Peak	182	341	P
6	5855.00	-5.84	68.95	63.11	110.80	-47.69	Peak	182	341	P
7	5875.00	-5.85	67.93	62.08	105.20	-43.12	Peak	182	341	P
8	5925.00	-5.87	68.27	62.40	68.20	-5.80	Peak	182	341	P
9	11570.00	2.09	37.65	39.74	54.00	-14.26	Average	124	193	P
10	11570.00	2.09	50.41	52.50	74.00	-21.50	Peak	124	193	P

Note: Level=Reading+Factor
Margin=Level-Limit
Factor=Antenna Factor + cable loss - Amplifier Factor



Power	: PoE	Pol/Phase	: HORIZONTAL
Test Mode	: Mode 1, CH157	Temperature	: 25°C
Test Date	: Nov. 26, 2016	Humidity	: 60%

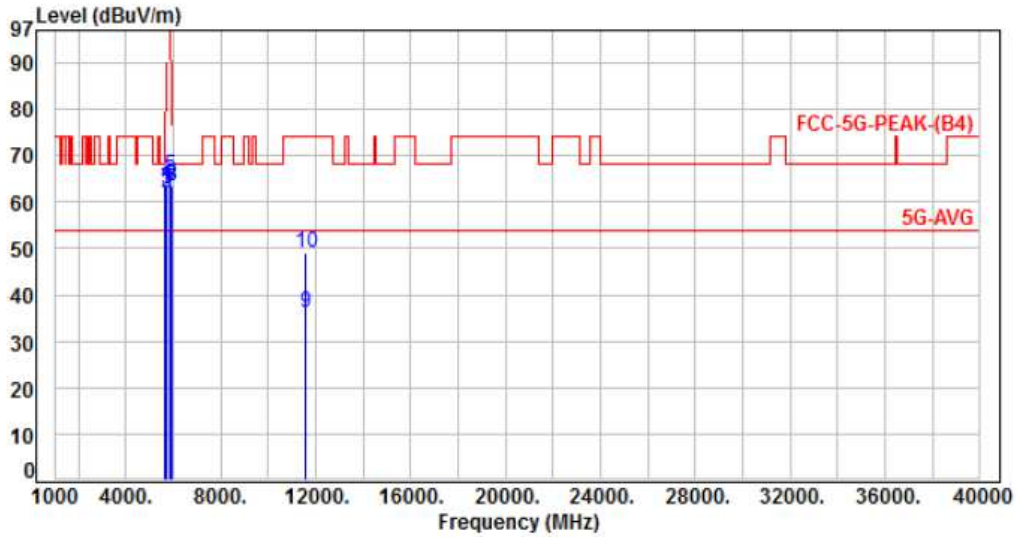

No.	Frequency (MHz)	Factor (dB)	Reading (dBuV)	Level (dBuV)	Limit (dBuV)	Margin (dB)	Detector	Height (cm)	Azimuth (deg)	P/F
1	5650.00	-5.77	69.21	63.44	68.20	-4.76	Peak	202	299	P
2	5700.00	-5.79	67.83	62.04	105.20	-43.16	Peak	202	299	P
3	5720.00	-5.80	68.38	62.58	110.80	-48.22	Peak	202	299	P
4	5725.00	-5.80	69.65	63.85	122.20	-58.35	Peak	202	299	P
5	5850.00	-5.84	71.37	65.53	122.20	-56.67	Peak	202	299	P
6	5855.00	-5.84	69.74	63.90	110.80	-46.90	Peak	202	299	P
7	5875.00	-5.85	68.66	62.81	105.20	-42.39	Peak	202	299	P
8	5925.00	-5.87	69.31	63.44	68.20	-4.76	Peak	202	299	P
9	11570.00	2.09	34.18	36.27	54.00	-17.73	Average	211	262	P
10	11570.00	2.09	47.12	49.21	74.00	-24.79	Peak	211	262	P

Note: Level=Reading+Factor
 Margin=Level-Limit
 Factor=Antenna Factor + cable loss - Amplifier Factor



Power	:	PoE	Pol/Phase	:	VERTICAL
Test Mode	:	Mode 1, CH165	Temperature	:	25°C
Test Date	:	Nov. 26, 2016	Humidity	:	60%

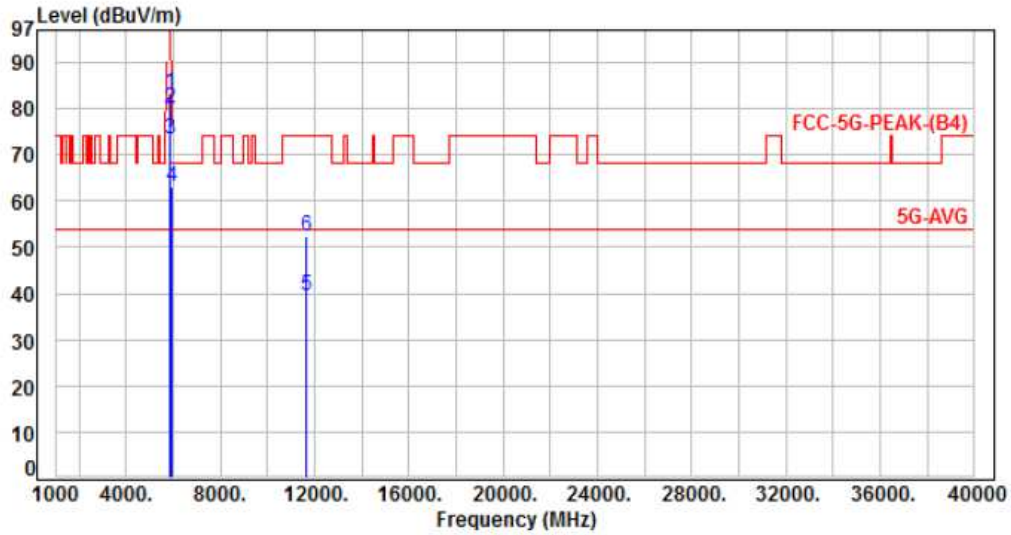

No.	Frequency (MHz)	Factor (dB)	Reading (dBuV)	Level (dBuV)	Limit (dBuV)	Margin (dB)	Detector	Height (cm)	Azimuth (deg)	P/F
1	5850.00	-5.84	89.10	83.26	122.20	-38.94	Peak	184	352	P
2	5855.00	-5.84	86.02	80.18	110.80	-30.62	Peak	184	352	P
3	5875.00	-5.85	79.07	73.22	105.20	-31.98	Peak	184	352	P
4	5925.00	-5.87	69.07	63.20	68.20	-5.00	Peak	184	352	P
5	11650.00	2.12	37.26	39.38	54.00	-14.62	Average	137	209	P
6	11650.00	2.12	50.12	52.24	74.00	-21.76	Peak	137	209	P

Note: Level=Reading+Factor
Margin=Level-Limit
Factor=Antenna Factor + cable loss - Amplifier Factor



Power	: PoE	Pol/Phase	: HORIZONTAL
Test Mode	: Mode 1, CH165	Temperature	: 25°C
Test Date	: Nov. 26, 2016	Humidity	: 60%

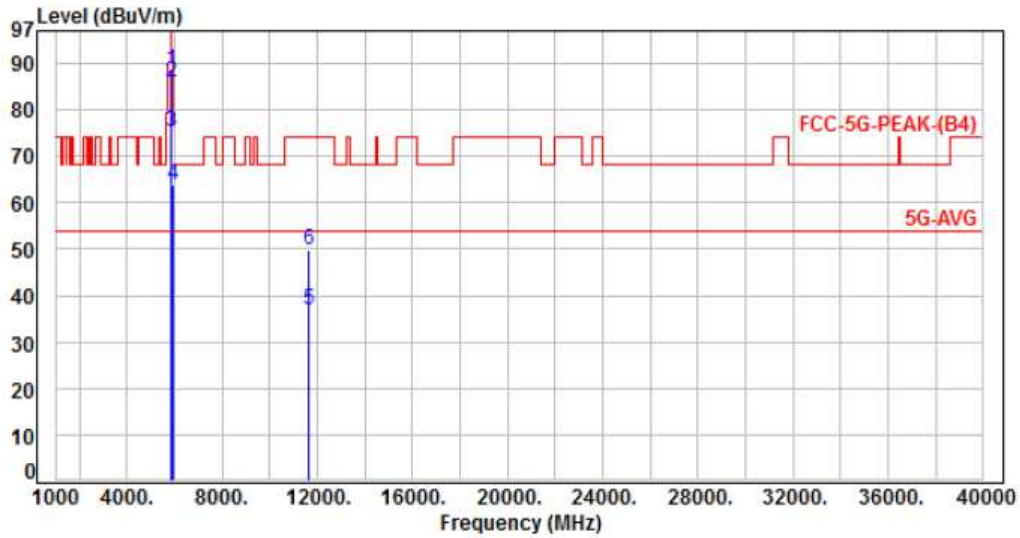

No.	Frequency (MHz)	Factor (dB)	Reading (dBuV)	Level (dBuV)	Limit (dBuV)	Margin (dB)	Detector	Height (cm)	Azimuth (deg)	P/F
1	5850.00	-5.84	94.36	88.52	122.20	-33.68	Peak	144	315	P
2	5855.00	-5.84	91.81	85.97	110.80	-24.83	Peak	144	315	P
3	5875.00	-5.85	81.25	75.40	105.20	-29.80	Peak	144	315	P
4	5925.00	-5.87	69.81	63.94	68.20	-4.26	Peak	144	315	P
5	11650.00	2.12	34.81	36.93	54.00	-17.07	Average	212	268	P
6	11650.00	2.12	47.77	49.89	74.00	-24.11	Peak	212	268	P

Note: Level=Reading+Factor
Margin=Level-Limit
Factor=Antenna Factor + cable loss - Amplifier Factor



Power	: PoE	Pol/Phase	: VERTICAL
Test Mode	: Mode 4, CH149	Temperature	: 25°C
Test Date	: Nov. 26, 2016	Humidity	: 60%

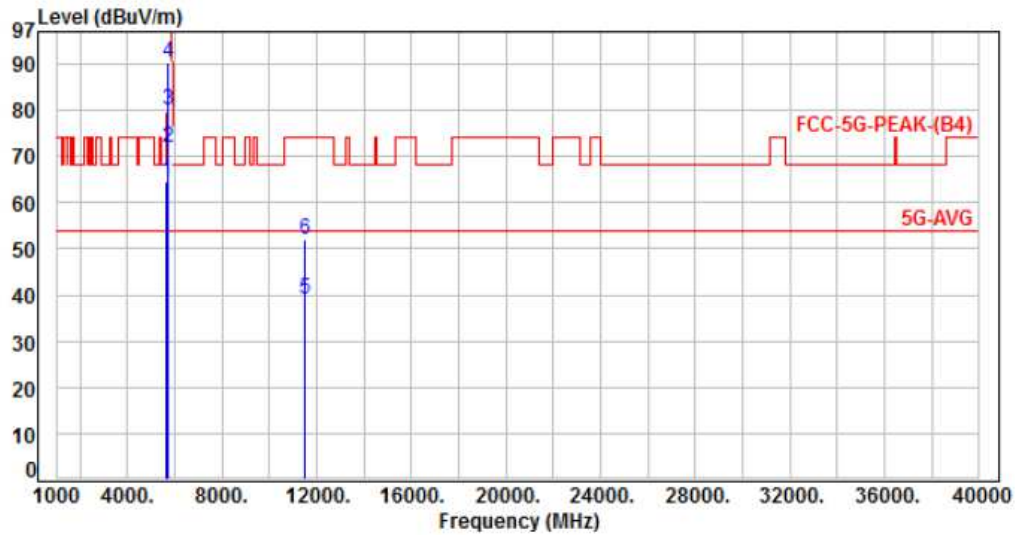

No.	Frequency (MHz)	Factor (dB)	Reading (dBuV)	Level (dBuV)	Limit (dBuV)	Margin (dB)	Detector	Height (cm)	Azimuth (deg)	P/F
1	5650.00	-5.77	70.13	64.36	68.20	-3.84	Peak	196	341	P
2	5700.00	-5.79	77.82	72.03	105.20	-33.17	Peak	196	341	P
3	5720.00	-5.80	85.96	80.16	110.80	-30.64	Peak	196	341	P
4	5725.00	-5.80	96.22	90.42	122.20	-31.78	Peak	196	341	P
5	11490.00	2.06	36.97	39.03	54.00	-14.97	Average	120	163	P
6	11490.00	2.06	49.78	51.84	74.00	-22.16	Peak	120	163	P

Note: Level=Reading+Factor
 Margin=Level-Limit
 Factor=Antenna Factor + cable loss - Amplifier Factor



Power	: PoE	Pol/Phase	: HORIZONTAL
Test Mode	: Mode 4, CH149	Temperature	: 25°C
Test Date	: Nov. 26, 2016	Humidity	: 60%

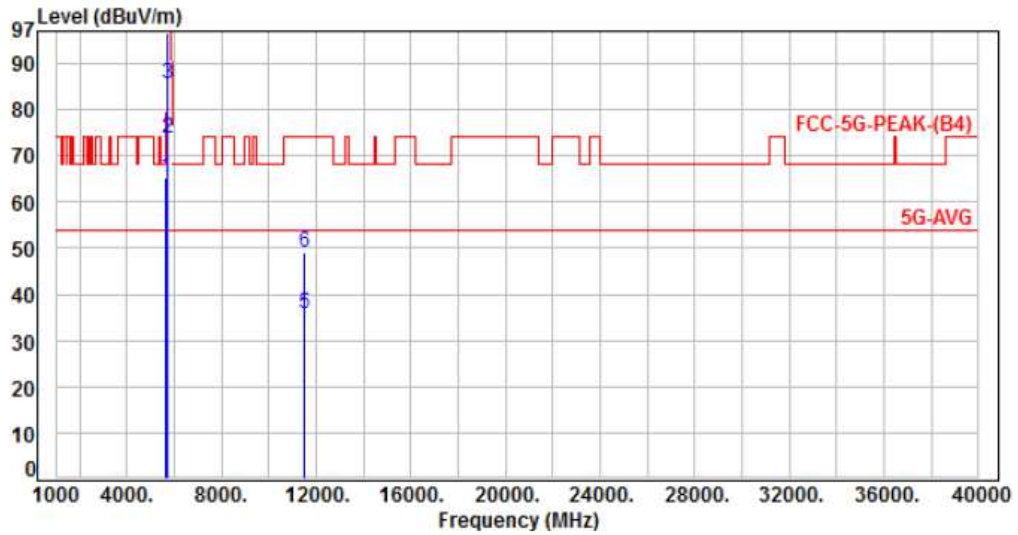

No.	Frequency (MHz)	Factor (dB)	Reading (dBuV)	Level (dBuV)	Limit (dBuV)	Margin (dB)	Detector	Height (cm)	Azimuth (deg)	P/F
1	5650.00	-5.77	70.87	65.10	68.20	-3.10	Peak	192	337	P
2	5700.00	-5.79	79.55	73.76	105.20	-31.44	Peak	192	337	P
3	5720.00	-5.80	91.33	85.53	110.80	-25.27	Peak	192	337	P
4	5725.00	-5.80	102.25	96.45	122.20	-25.75	Peak	192	337	P
5	11490.00	2.06	33.72	35.78	54.00	-18.22	Average	251	355	P
6	11490.00	2.06	47.13	49.19	74.00	-24.81	Peak	251	355	P

Note: Level=Reading+Factor
Margin=Level-Limit
Factor=Antenna Factor + cable loss - Amplifier Factor



Power	: PoE	Pol/Phase	: VERTICAL
Test Mode	: Mode 4, CH157	Temperature	: 25°C
Test Date	: Nov. 26, 2016	Humidity	: 60%

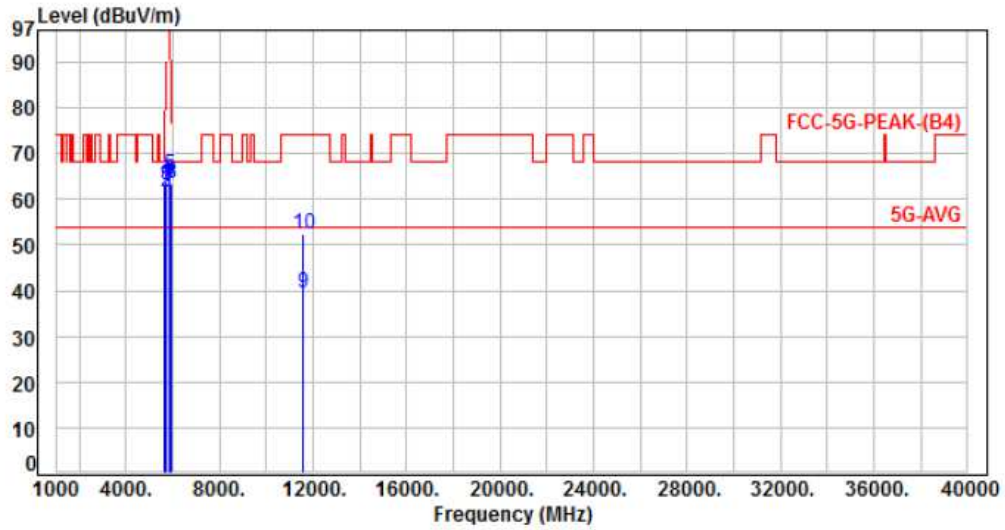

No.	Frequency (MHz)	Factor (dB)	Reading (dBuV)	Level (dBuV)	Limit (dBuV)	Margin (dB)	Detector	Height (cm)	Azimuth (deg)	P/F
1	5650.00	-5.77	68.71	62.94	68.20	-5.26	Peak	179	326	P
2	5700.00	-5.79	67.31	61.52	105.20	-43.68	Peak	179	326	P
3	5720.00	-5.80	68.93	63.13	110.80	-47.67	Peak	179	326	P
4	5725.00	-5.80	69.65	63.85	122.20	-58.35	Peak	179	326	P
5	5850.00	-5.84	70.97	65.13	122.20	-57.07	Peak	179	326	P
6	5855.00	-5.84	69.88	64.04	110.80	-46.76	Peak	179	326	P
7	5875.00	-5.85	68.72	62.87	105.20	-42.33	Peak	179	326	P
8	5925.00	-5.87	69.31	63.44	68.20	-4.76	Peak	179	326	P
9	11570.00	2.09	37.24	39.33	54.00	-14.67	Average	113	169	P
10	11570.00	2.09	50.13	52.22	74.00	-21.78	Peak	113	169	P

Note: Level=Reading+Factor
 Margin=Level-Limit
 Factor=Antenna Factor + cable loss - Amplifier Factor



Power	: PoE	Pol/Phase	: HORIZONTAL
Test Mode	: Mode 4, CH157	Temperature	: 25°C
Test Date	: Nov. 26, 2016	Humidity	: 60%

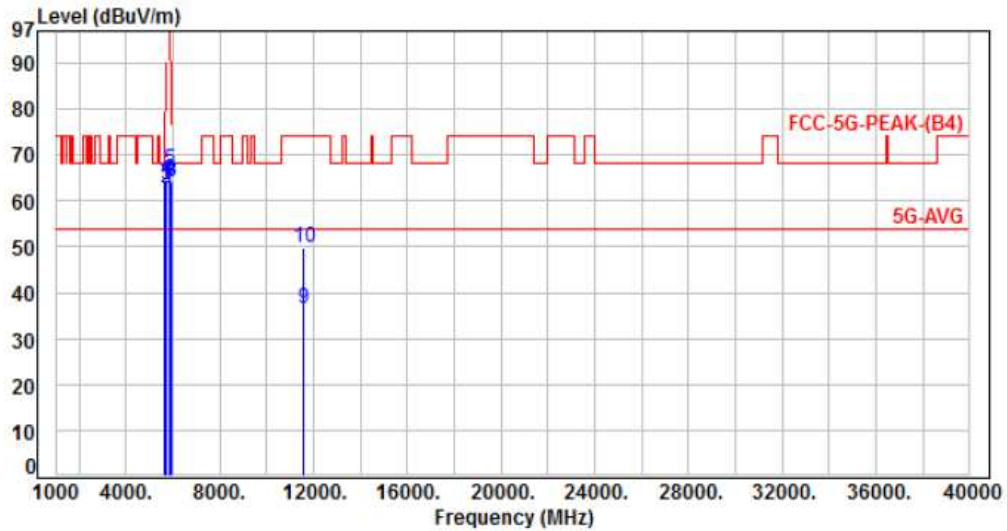

No.	Frequency (MHz)	Factor (dB)	Reading (dBUV)	Level (dBUV)	Limit (dBUV)	Margin (dB)	Detector	Height (cm)	Azimuth (deg)	P/F
1	5650.00	-5.77	69.87	64.10	68.20	-4.10	Peak	208	306	P
2	5700.00	-5.79	68.66	62.87	105.20	-42.33	Peak	208	306	P
3	5720.00	-5.80	69.13	63.33	110.80	-47.47	Peak	208	306	P
4	5725.00	-5.80	70.37	64.57	122.20	-57.63	Peak	208	306	P
5	5850.00	-5.84	72.45	66.61	122.20	-55.59	Peak	208	306	P
6	5855.00	-5.84	70.36	64.52	110.80	-46.28	Peak	208	306	P
7	5875.00	-5.85	69.37	63.52	105.20	-41.68	Peak	208	306	P
8	5925.00	-5.87	70.12	64.25	68.20	-3.95	Peak	208	306	P
9	11570.00	2.09	34.45	36.54	54.00	-17.46	Average	213	271	P
10	11570.00	2.09	47.78	49.87	74.00	-24.13	Peak	213	271	P

Note: Level=Reading+Factor
 Margin=Level-Limit
 Factor=Antenna Factor + cable loss - Amplifier Factor



Power	: PoE	Pol/Phase	: VERTICAL
Test Mode	: Mode 4, CH165	Temperature	: 25°C
Test Date	: Nov. 26, 2016	Humidity	: 60%

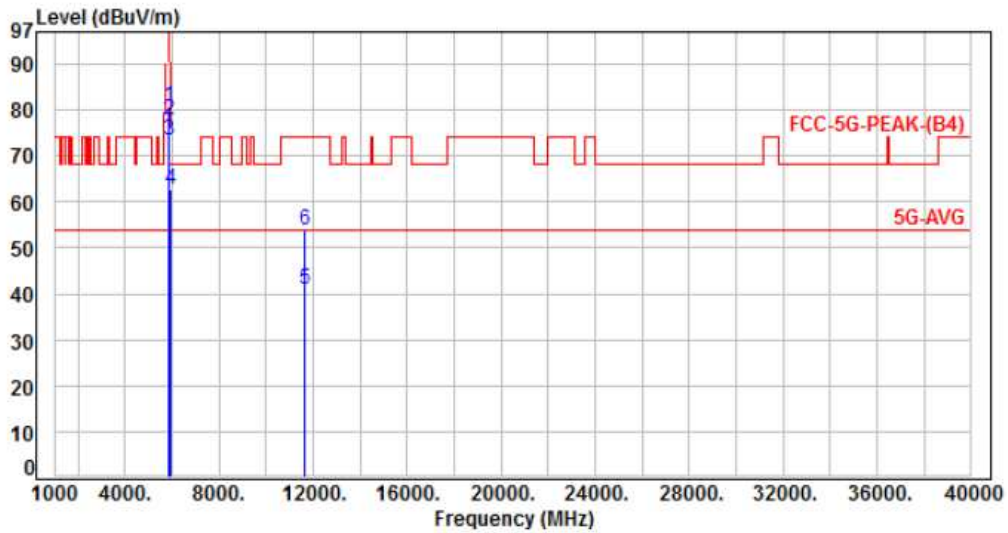

No.	Frequency (MHz)	Factor (dB)	Reading (dBuV)	Level (dBuV)	Limit (dBuV)	Margin (dB)	Detector	Height (cm)	Azimuth (deg)	P/F
1	5850.00	-5.84	86.66	80.82	122.20	-41.38	Peak	177	348	P
2	5855.00	-5.84	83.52	77.68	110.80	-33.12	Peak	177	348	P
3	5875.00	-5.85	79.35	73.50	105.20	-31.70	Peak	177	348	P
4	5925.00	-5.87	68.58	62.71	68.20	-5.49	Peak	177	348	P
5	11650.00	2.12	38.66	40.78	54.00	-13.22	Average	122	213	P
6	11650.00	2.12	51.89	54.01	74.00	-19.99	Peak	122	213	P

Note: Level=Reading+Factor
 Margin=Level-Limit
 Factor=Antenna Factor + cable loss - Amplifier Factor



Power	: PoE	Pol/Phase	: HORIZONTAL
Test Mode	: Mode 4, CH165	Temperature	: 25°C
Test Date	: Nov. 26, 2016	Humidity	: 60%

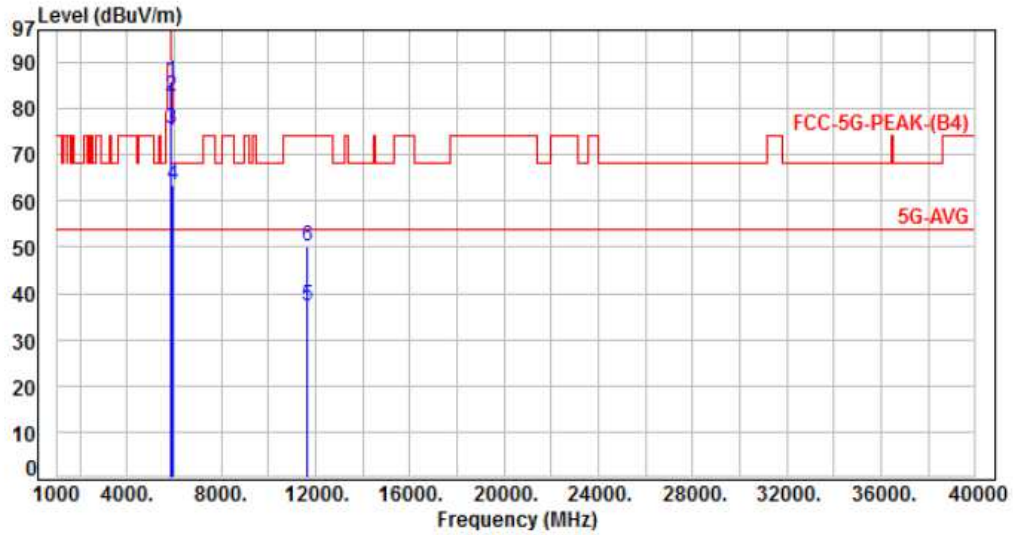

No.	Frequency (MHz)	Factor (dB)	Reading (dBuV)	Level (dBuV)	Limit (dBuV)	Margin (dB)	Detector	Height (cm)	Azimuth (deg)	P/F
1	5850.00	-5.84	91.78	85.94	122.20	-36.26	Peak	151	322	P
2	5855.00	-5.84	88.64	82.80	110.80	-28.00	Peak	151	322	P
3	5875.00	-5.85	81.45	75.60	105.20	-29.60	Peak	151	322	P
4	5925.00	-5.87	69.22	63.35	68.20	-4.85	Peak	151	322	P
5	11650.00	2.12	35.27	37.39	54.00	-16.61	Average	211	274	P
6	11650.00	2.12	48.13	50.25	74.00	-23.75	Peak	211	274	P

Note: Level=Reading+Factor
 Margin=Level-Limit
 Factor=Antenna Factor + cable loss - Amplifier Factor



Power	: PoE	Pol/Phase	: VERTICAL
Test Mode	: Mode 5, CH151	Temperature	: 25°C
Test Date	: Nov. 26, 2016	Humidity	: 60%

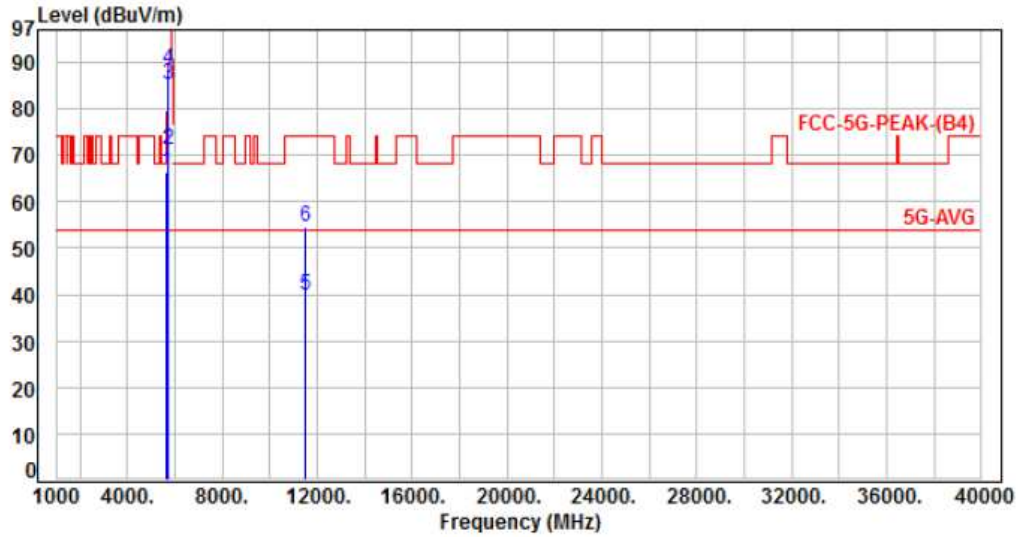

No.	Frequency (MHz)	Factor (dB)	Reading (dBuV)	Level (dBuV)	Limit (dBuV)	Margin (dB)	Detector	Height (cm)	Azimuth (deg)	P/F
1	5650.00	-5.77	72.12	66.35	68.20	-1.85	Peak	196	343	P
2	5700.00	-5.79	77.15	71.36	105.20	-33.84	Peak	196	343	P
3	5720.00	-5.80	90.88	85.08	110.80	-25.72	Peak	196	343	P
4	5725.00	-5.80	94.25	88.45	122.20	-33.75	Peak	196	343	P
5	11510.00	2.07	37.73	39.80	54.00	-14.20	Average	212	245	P
6	11510.00	2.07	52.67	54.74	74.00	-19.26	Peak	212	245	P

Note: Level=Reading+Factor
Margin=Level-Limit
Factor=Antenna Factor + cable loss - Amplifier Factor



Power	: PoE	Pol/Phase	: HORIZONTAL
Test Mode	: Mode 5, CH151	Temperature	: 25°C
Test Date	: Nov. 26, 2016	Humidity	: 60%

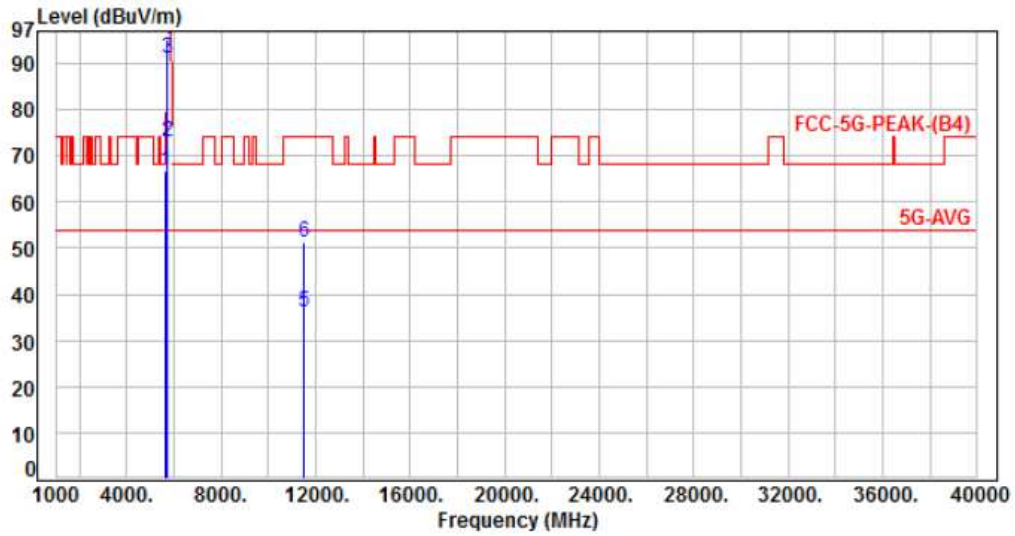

No.	Frequency (MHz)	Factor (dB)	Reading (dBuV)	Level (dBuV)	Limit (dBuV)	Margin (dB)	Detector	Height (cm)	Azimuth (deg)	P/F
1	5650.00	-5.77	72.46	66.69	68.20	-1.51	Peak	185	339	P
2	5700.00	-5.79	78.82	73.03	105.20	-32.17	Peak	185	339	P
3	5720.00	-5.80	96.90	91.10	110.80	-19.70	Peak	185	339	P
4	5725.00	-5.80	100.96	95.16	122.20	-27.04	Peak	185	339	P
5	11510.00	2.07	34.12	36.19	54.00	-17.81	Average	121	312	P
6	11510.00	2.07	49.03	51.10	74.00	-22.90	Peak	121	312	P

Note: Level=Reading+Factor
Margin=Level-Limit
Factor=Antenna Factor + cable loss - Amplifier Factor



Power	: PoE	Pol/Phase	: VERTICAL
Test Mode	: Mode 5, CH159	Temperature	: 25°C
Test Date	: Nov. 26, 2016	Humidity	: 60%

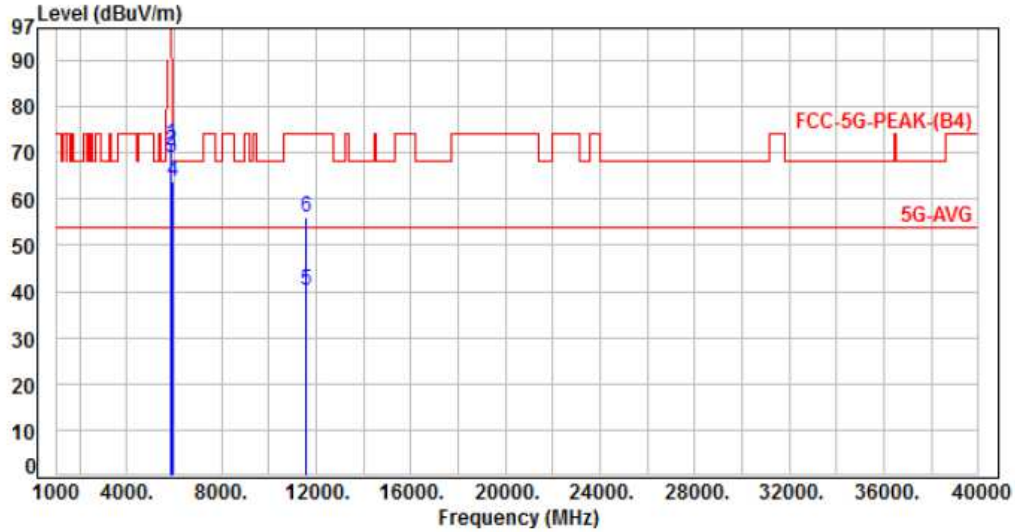

No.	Frequency (MHz)	Factor (dB)	Reading (dBuV)	Level (dBuV)	Limit (dBuV)	Margin (dB)	Detector	Height (cm)	Azimuth (deg)	P/F
1	5850.00	-5.84	77.92	72.08	122.20	-50.12	Peak	171	328	P
2	5855.00	-5.84	76.16	70.32	110.80	-40.48	Peak	171	328	P
3	5875.00	-5.85	74.79	68.94	105.20	-36.26	Peak	171	328	P
4	5925.00	-5.87	69.65	63.78	68.20	-4.42	Peak	171	328	P
5	11590.00	2.10	38.02	40.12	54.00	-13.88	Average	212	245	P
6	11590.00	2.10	53.81	55.91	74.00	-18.09	Peak	212	245	P

Note: Level=Reading+Factor
 Margin=Level-Limit
 Factor=Antenna Factor + cable loss - Amplifier Factor



Power	: PoE	Pol/Phase	: HORIZONTAL
Test Mode	: Mode 5, CH159	Temperature	: 25°C
Test Date	: Nov. 26, 2016	Humidity	: 60%

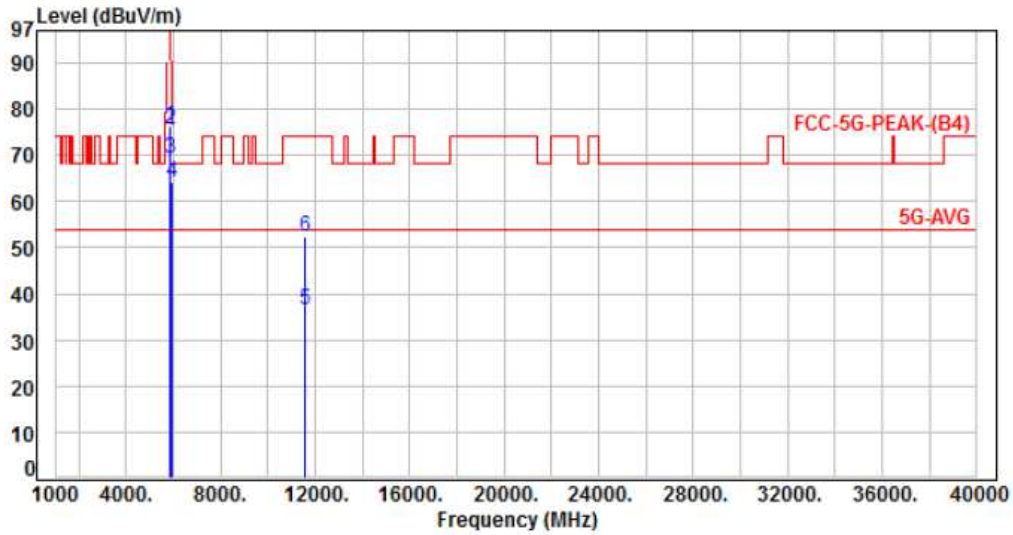

No.	Frequency (MHz)	Factor (dB)	Reading (dBuV)	Level (dBuV)	Limit (dBuV)	Margin (dB)	Detector	Height (cm)	Azimuth (deg)	P/F
1	5850.00	-5.84	82.35	76.51	122.20	-45.69	Peak	186	360	P
2	5855.00	-5.84	81.60	75.76	110.80	-35.04	Peak	186	360	P
3	5875.00	-5.85	75.30	69.45	105.20	-35.75	Peak	186	360	P
4	5925.00	-5.87	70.14	64.27	68.20	-3.93	Peak	186	360	P
5	11590.00	2.10	34.56	36.66	54.00	-17.34	Average	137	286	P
6	11590.00	2.10	50.45	52.55	74.00	-21.45	Peak	137	286	P

Note: Level=Reading+Factor
Margin=Level-Limit
Factor=Antenna Factor + cable loss - Amplifier Factor



Power	: PoE	Pol/Phase	: VERTICAL
Test Mode	: Mode 6, CH155	Temperature	: 25°C
Test Date	: Nov. 26, 2016	Humidity	: 60%

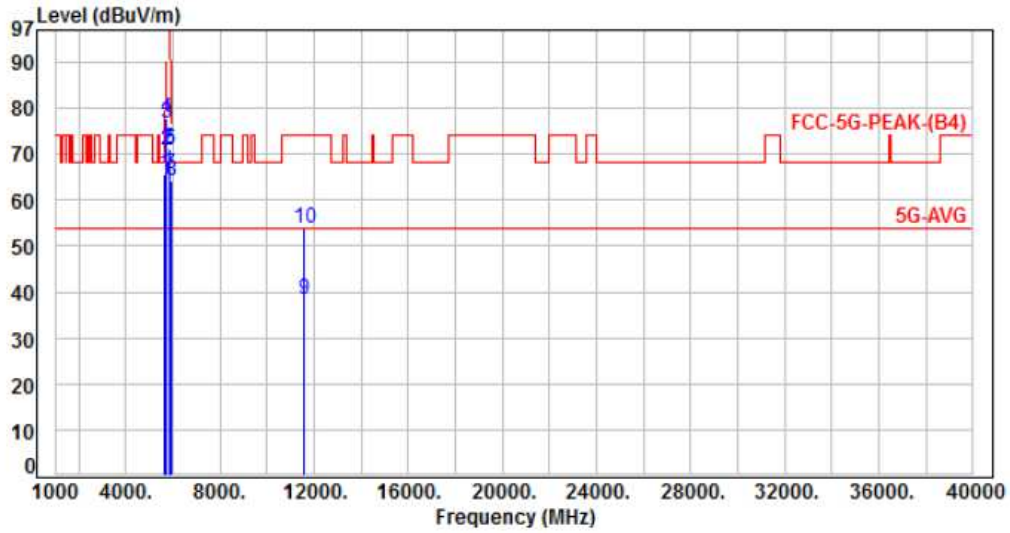

No.	Frequency (MHz)	Factor (dB)	Reading (dBuV)	Level (dBuV)	Limit (dBuV)	Margin (dB)	Detector	Height (cm)	Azimuth (deg)	P/F
1	5650.00	-5.77	71.51	65.74	68.20	-2.46	Peak	191	337	P
2	5700.00	-5.79	76.63	70.84	105.20	-34.36	Peak	191	337	P
3	5720.00	-5.80	82.50	76.70	110.80	-34.10	Peak	191	337	P
4	5725.00	-5.80	83.53	77.73	122.20	-44.47	Peak	191	337	P
5	5850.00	-5.84	76.70	70.86	122.20	-51.34	Peak	191	337	P
6	5855.00	-5.84	77.12	71.28	110.80	-39.52	Peak	191	337	P
7	5875.00	-5.85	71.48	65.63	105.20	-39.57	Peak	191	337	P
8	5925.00	-5.87	69.89	64.02	68.20	-4.18	Peak	191	337	P
9	11550.00	2.09	36.45	38.54	54.00	-15.46	Average	137	311	P
10	11550.00	2.09	51.73	53.82	74.00	-20.18	Peak	137	311	P

Note: Level=Reading+Factor
 Margin=Level-Limit
 Factor=Antenna Factor + cable loss - Amplifier Factor



Power	: PoE	Pol/Phase	: HORIZONTAL
Test Mode	: Mode 6, CH155	Temperature	: 25°C
Test Date	: Nov. 26, 2016	Humidity	: 60%

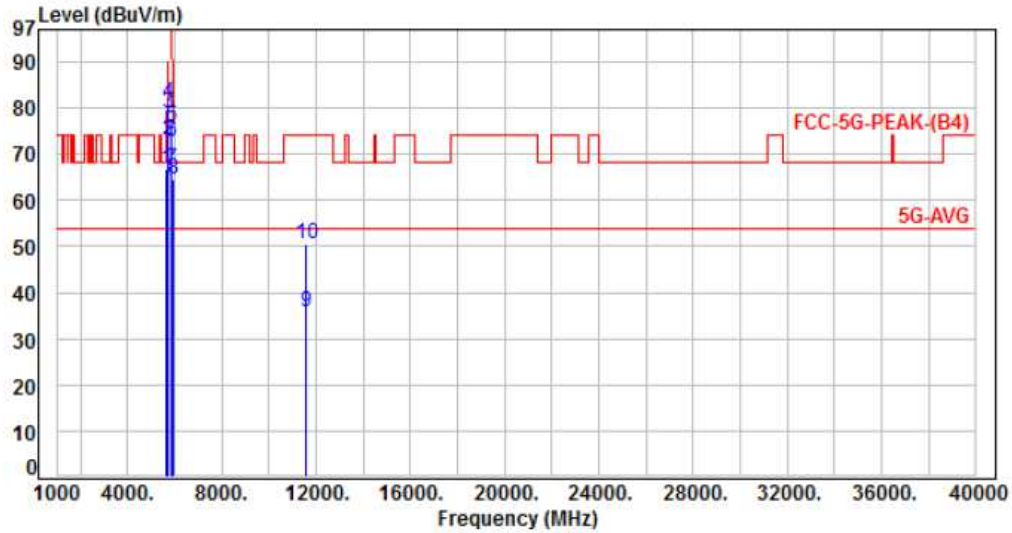

No.	Frequency (MHz)	Factor (dB)	Reading (dBuV)	Level (dBuV)	Limit (dBuV)	Margin (dB)	Detector	Height (cm)	Azimuth (deg)	P/F
1	5650.00	-5.77	72.50	66.73	68.20	-1.47	Peak	200	341	P
2	5700.00	-5.79	78.99	73.20	105.20	-32.00	Peak	200	341	P
3	5720.00	-5.80	84.89	79.09	110.80	-31.71	Peak	200	341	P
4	5725.00	-5.80	87.05	81.25	122.20	-40.95	Peak	200	341	P
5	5850.00	-5.84	81.77	75.93	122.20	-46.27	Peak	200	341	P
6	5855.00	-5.84	78.40	72.56	110.80	-38.24	Peak	200	341	P
7	5875.00	-5.85	72.69	66.84	105.20	-38.36	Peak	200	341	P
8	5925.00	-5.87	70.37	64.50	68.20	-3.70	Peak	200	341	P
9	11550.00	2.09	33.52	35.61	54.00	-18.39	Average	249	297	P
10	11550.00	2.09	48.37	50.46	74.00	-23.54	Peak	249	297	P

Note: Level=Reading+Factor
 Margin=Level-Limit
 Factor=Antenna Factor + cable loss - Amplifier Factor



6.7. Restricted Bands of Operation

Only spurious emissions are permitted in any of the frequency bands listed below:

MHz	MHz	MHz	GHz
0.09000 – 0.11000	16.42000 – 16.42300	399.9 – 410.0	4.500 – 5.150
0.49500 – 0.505**	16.69475 – 16.69525	608.0 – 614.0	5.350 – 5.460
2.17350 – 2.19050	16.80425 – 16.80475	960.0 – 1240.0	7.250 – 7.750
4.12500 – 4.12800	25.50000 – 25.67000	1300.0 – 1427.0	8.025 – 8.500
4.17725 – 4.17775	37.50000 – 38.25000	1435.0 – 1626.5	9.000 – 9.200
4.20725 – 4.20775	73.00000 – 74.60000	1645.5 – 1646.5	9.300 – 9.500
6.21500 – 6.21800	74.80000 – 75.20000	1660.0 – 1710.0	10.600 – 12.700
6.26775 – 6.26825	108.00000 – 121.94000	1718.8 – 1722.2	13.250 – 13.400
6.31175 – 6.31225	123.00000 – 138.00000	2200.0 – 2300.0	14.470 – 14.500
8.29100 – 8.29400	149.90000 – 150.05000	2310.0 – 2390.0	15.350 – 16.200
8.36200 – 8.36600	156.52475 – 156.52525	2483.5 – 2500.0	17.700 – 21.400
8.37625 – 8.38675	156.70000 – 156.90000	2655.0 – 2900.0	22.010 – 23.120
8.41425 – 8.41475	162.01250 – 167.17000	3260.0 – 3267.0	23.600 – 24.000
12.29000 – 12.29300	167.72000 – 173.20000	3332.0 – 3339.0	31.200 – 31.800
12.51975 – 12.52025	240.00000 – 285.00000	3345.8 – 3358.0	36.430 – 36.500
12.57675 – 12.57725	322.00000 – 335.40000	3600.0 – 4400.0	Above 38.6
13.36000 – 13.41000			

** : Until February 1, 1999, this restricted band shall be 0.490-0.510 MHz



7. On Time, Duty Cycle and Measurement methods

7.1. Test Limit

None; for reporting purposes only.

7.2. Test Procedure

KDB 789033 Zero-Span Spectrum Analyzer Method.

7.3. Test Setup Layout

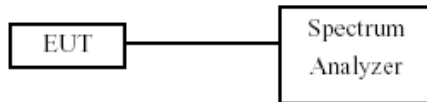

7.4. Test Result and Data

Temperature: 22°C

Humidity: 67%

Test Date: Dec. 06, 2016

Modulation Type	On Time (msec)	Period Time (msec)	Duty Cycle (%)	1/T Minimum VBW(Hz)	Duty Cycle correction Factor (dB)
802.11a	2.05	2.10	97.62%	487.80	0.10
802.11ac VHT20	1.93	1.98	97.47%	518.13	0.11
802.11ac VHT40	0.85	1.01	84.52%	1173.71	0.73
802.11ac VHT80	0.47	0.52	89.96%	2145.92	0.46

7.5. Measurement Methods

26 dB and 6dB Emission BW	KDB 789033 D02 v01, Section C
99% Occupied BW	KDB 789033 D02 v01, Section D
Conducted Output Power	KDB 789033 D02 v01, Section E.2.d and E.3.b (Method PM-G)
Power Spectral Density	KDB 789033 D02 v01, Section F
Unwanted emissions in restricted bands	KDB 789033 D02 v01, Sections G and H
Unwanted emissions in non-restricted bands	KDB 789033 D02 v01, Sections G and H



Modulation Standard: 802.11a (6Mbps)

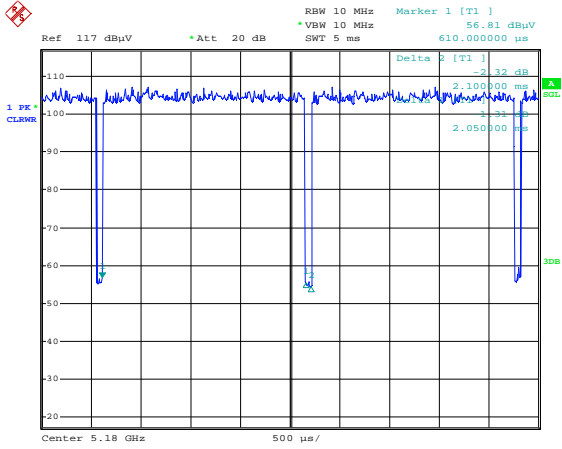

Modulation Standard: 802.11ac, VHT20 (6.5Mbps)

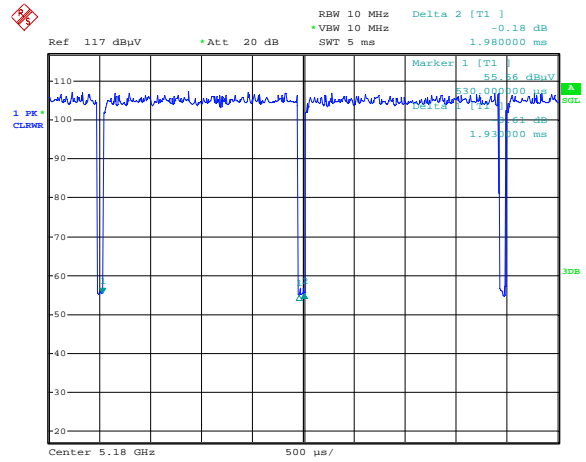

Modulation Standard: 802.11ac, VHT40 (13.5Mbps)

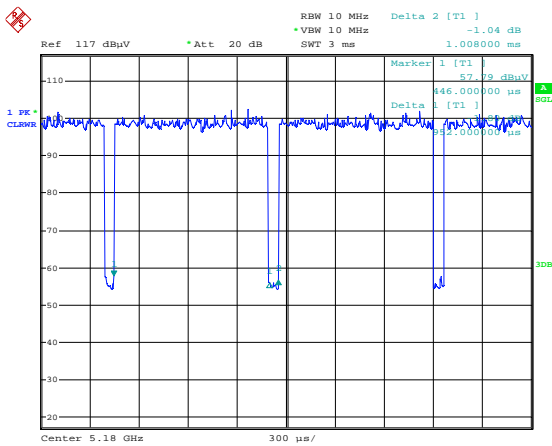

Modulation Standard: 802.11ac, VHT80 (29.3Mbps)

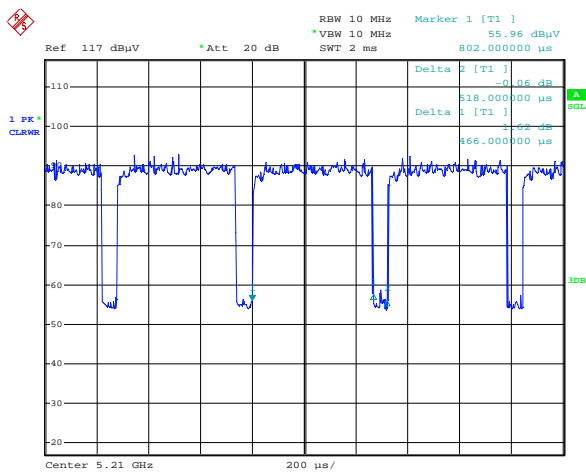



8. 6dB Bandwidth

8.1. Test Limit

FCC §15.407

The minimum 6 dB bandwidth shall be at least 500 kHz.

8.2. Test Procedure

Reference to 789033 D02 General UNII Test Procedures New Rules v01: The transmitter output is connected to a spectrum analyzer with the RBW set to 100KHz, the VBW >= 3 x RBW, peak detector and max hold.

8.3. Test Setup Layout

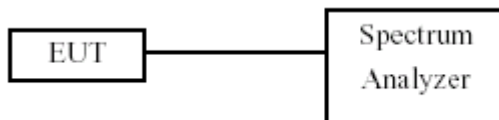

8.4. Test Result and Data

Temperature: 22°C

Humidity: 67%

Test Date: Dec. 06, 2016

In the 5.8G Band

Modulation Type	Channel	Frequency (MHz)	6dB Bandwidth (MHz)		Minimum Limit (MHz)
			ANT 1	ANT 2	
802.11a	149	5745	16.20	16.30	0.50
	157	5785	16.40	16.40	0.50
	165	5825	16.30	16.30	0.50
802.11ac VHT20	149	5745	17.50	17.60	0.50
	157	5785	17.60	17.60	0.50
	165	5825	17.50	17.60	0.50
802.11ac VHT40	151	5755	36.40	36.20	0.50
	159	5795	36.20	36.40	0.50
802.11ac VHT80	155	5775	75.84	75.52	0.50



Antenna 1
Modulation Standard: 802.11a (6Mbps)
CH149

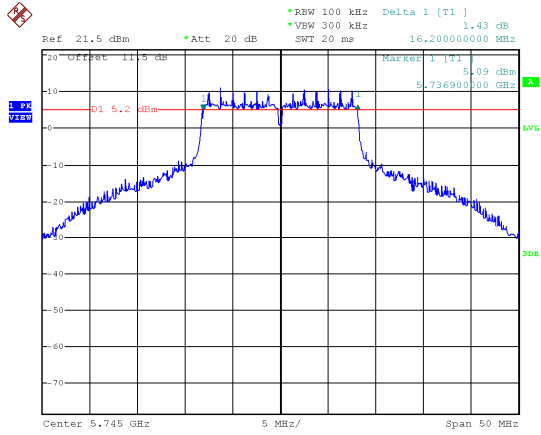

Modulation Standard: 802.11ac, VHT20 (6.5Mbps)
CH149

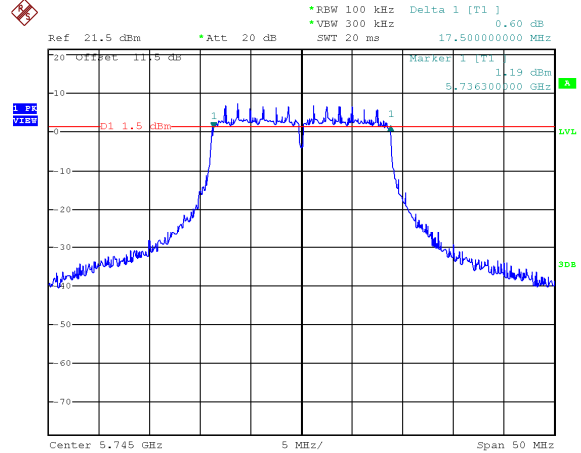

CH157

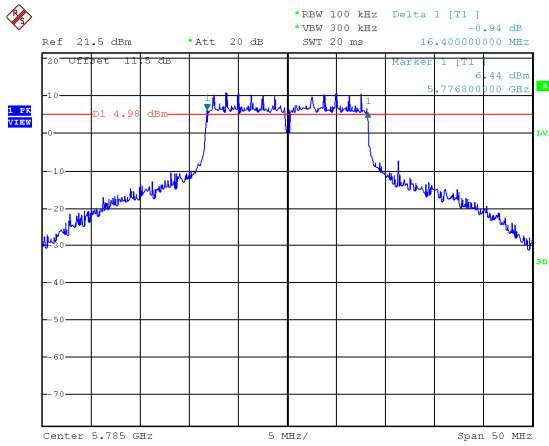

CH157

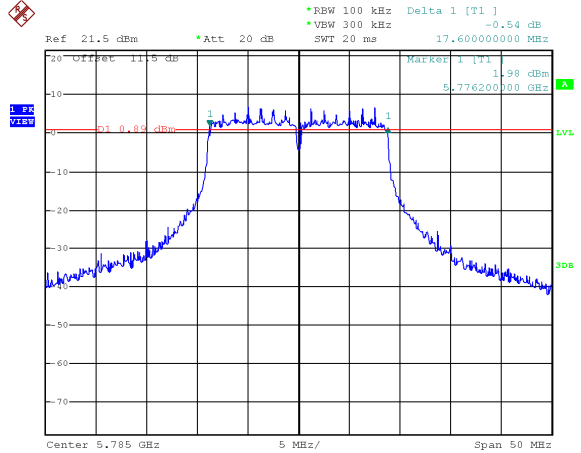

CH165

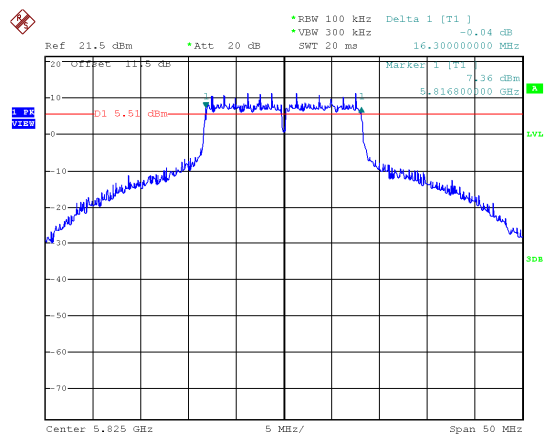

CH165

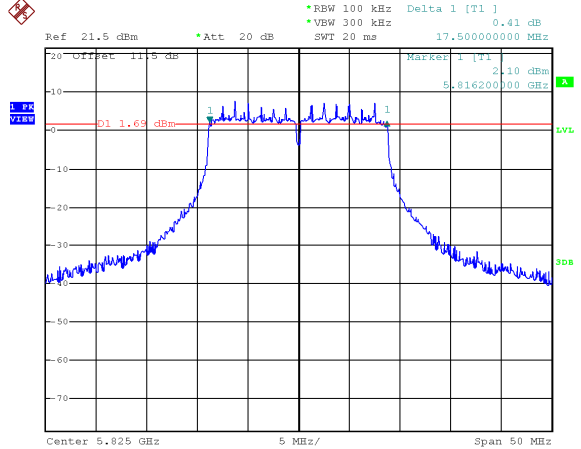



Antenna 1

Modulation Standard: 802.11ac, VHT40 (13.5Mbps)
CH151

Modulation Standard: 802.11ac, VHT80 (29.3Mbps)
CH155

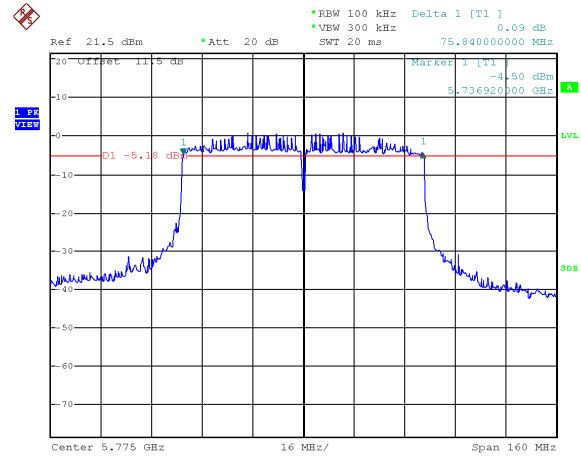
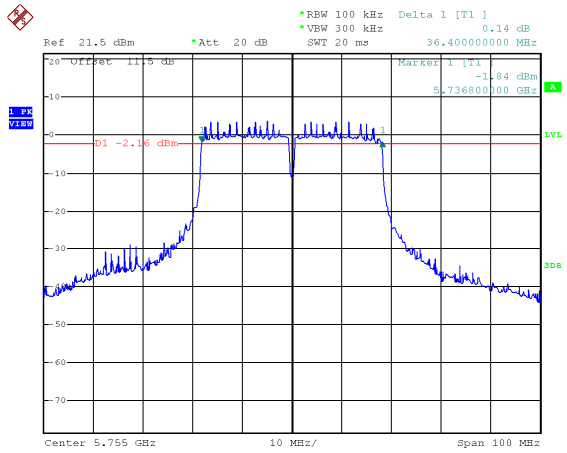

CH159

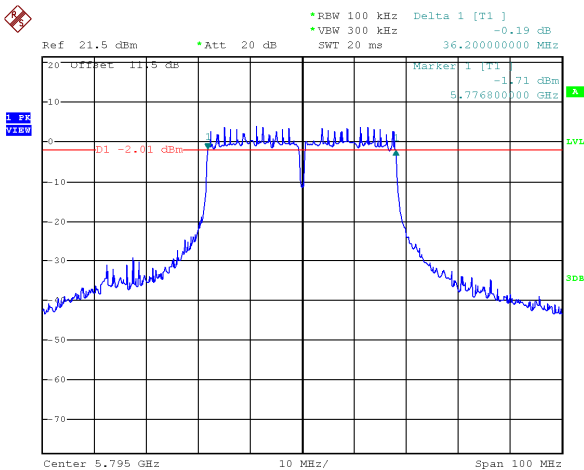



Antenna 2
Modulation Standard: 802.11a (6Mbps)
CH149

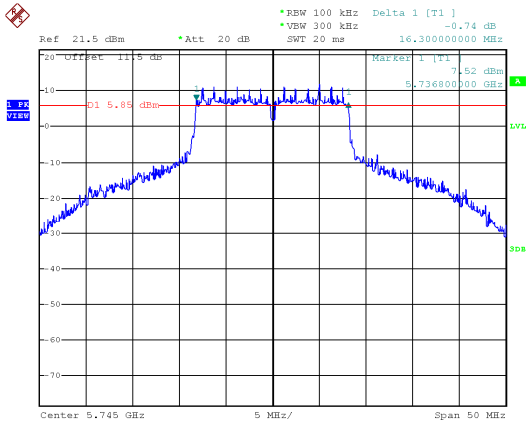

Modulation Standard: 802.11ac, VHT20 (6.5Mbps)
CH149

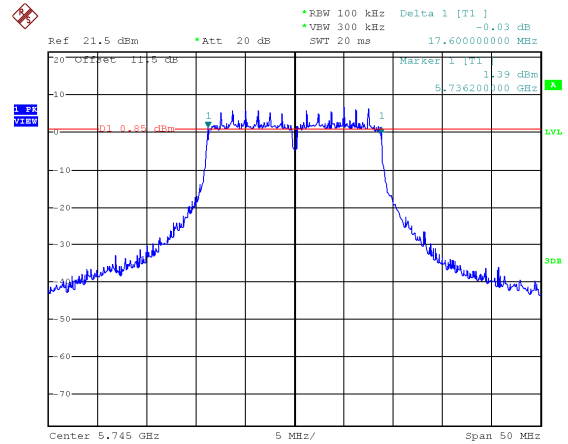

CH157

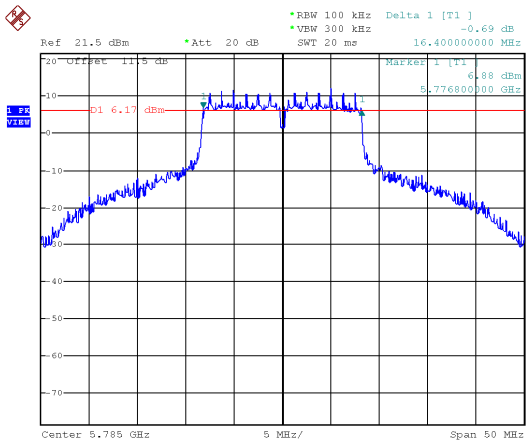

CH157

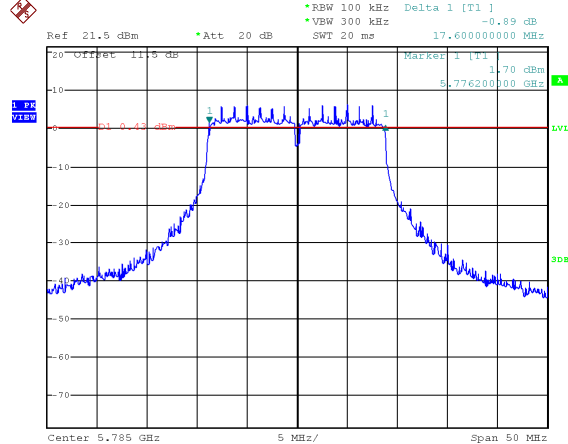

CH165

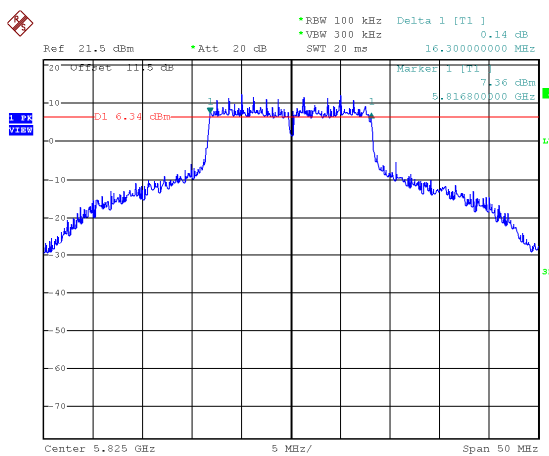

CH165

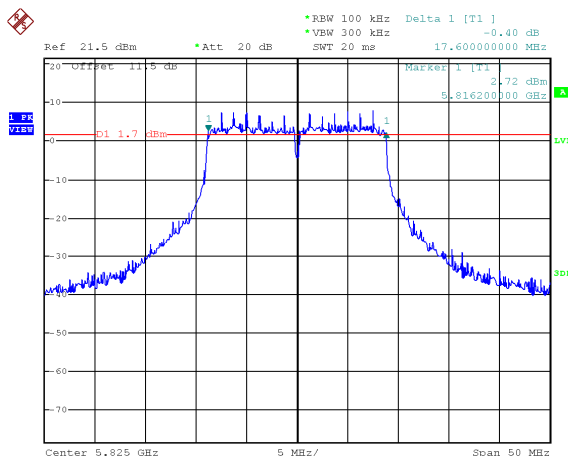



Antenna 2

Modulation Standard: 802.11ac, VHT40 (13.5Mbps)
CH151

Modulation Standard: 802.11ac, VHT80 (29.3Mbps)
CH155

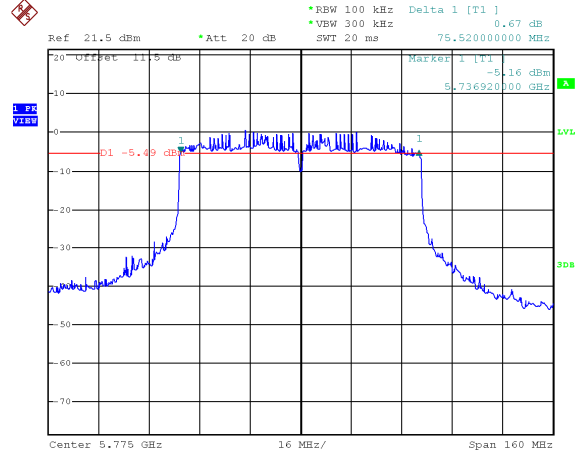
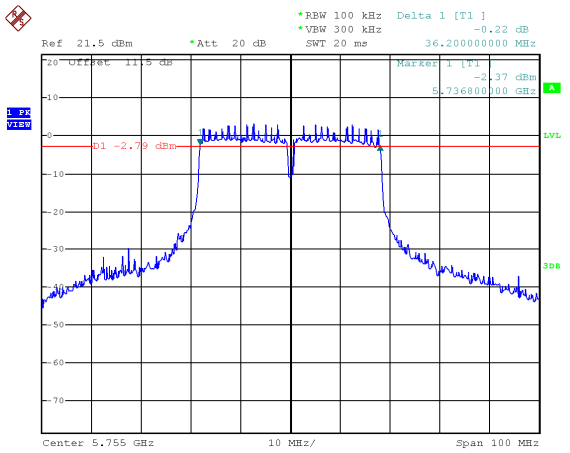

CH159

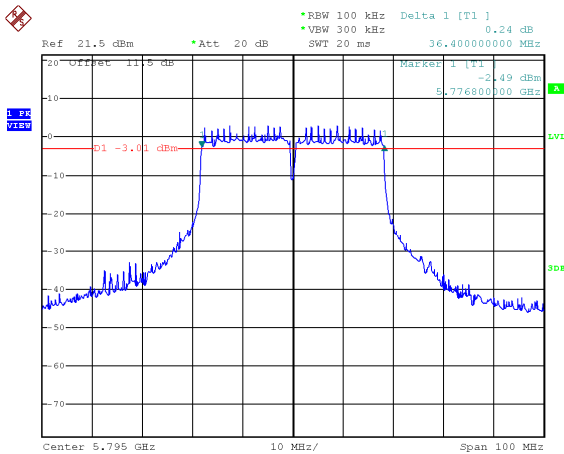



9. 26dB Bandwidth

9.1. Test Limit

None; for reporting purposes only.

9.2. Test Procedure

Reference to 789033 D02 General UNII Test Procedures New Rules v01: The transmitter output is connected to a spectrum analyzer with the RBW = approximately 1% of the emission bandwidth, the VBW >= 3 x RBW, peak detector and max hold.

9.3. Test Setup Layout

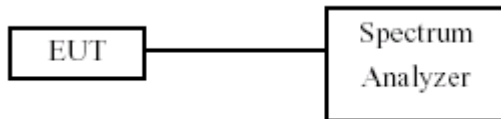

9.4. Test Result and Data

Temperature: 22°C

Humidity: 67%

Test Date: Dec. 06, 2016

In the 5.2G Band

Modulation Type	Channel	Frequency (MHz)	26dB Bandwidth (MHz)	
			ANT 1	ANT 2
802.11a	36	5180	22.40	21.60
	44	5220	27.10	22.40
	48	5240	25.60	21.70
802.11ac VHT20	36	5180	23.60	22.90
	44	5220	23.20	24.30
	48	5240	23.30	23.30
802.11ac VHT40	38	5190	46.20	45.80
	46	5230	46.20	45.60
802.11ac VHT80	42	5210	86.08	87.04



Antenna 1
Modulation Standard: 802.11a (6Mbps)
CH36

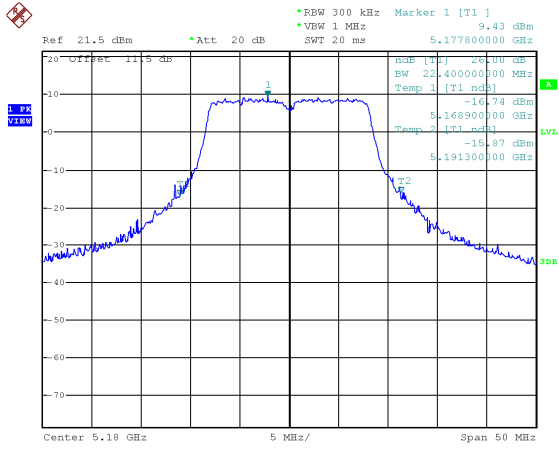

Modulation Standard: 802.11ac, VHT20 (6.5Mbps)
CH36

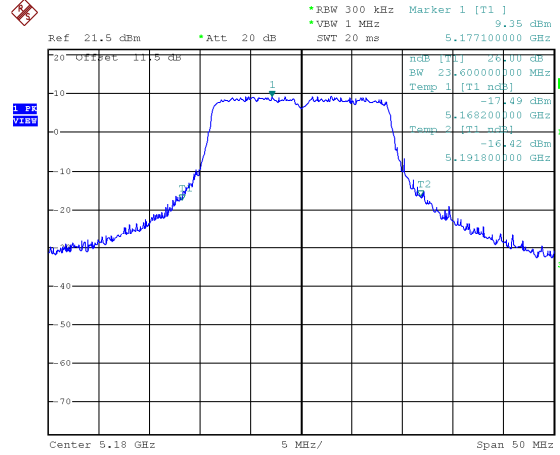

CH44

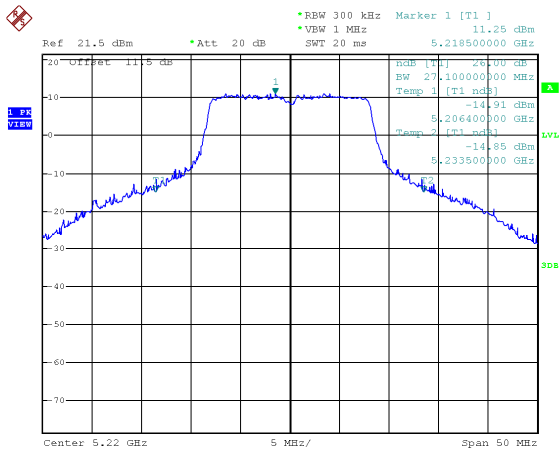

CH44

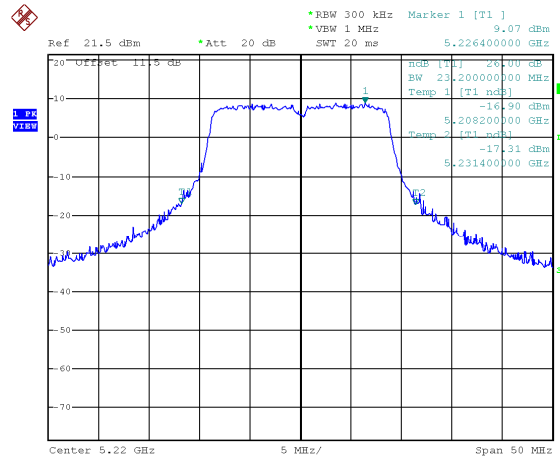

CH48

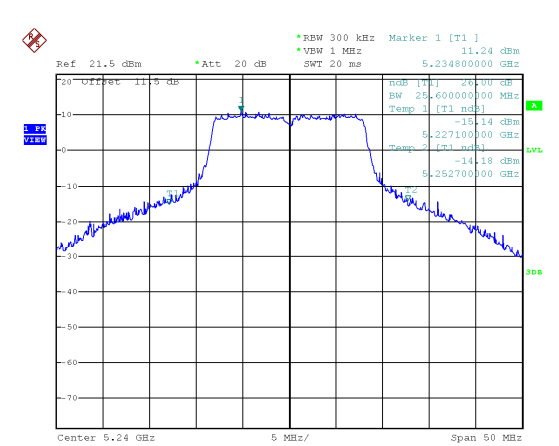

CH48

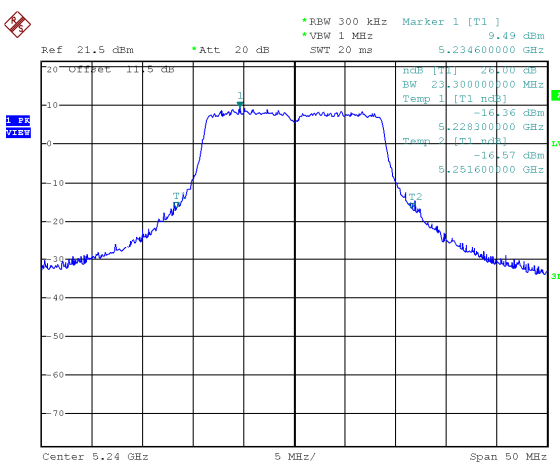



Antenna 1

Modulation Standard: 802.11ac, VHT40 (13.5Mbps) CH38

Modulation Standard: 802.11ac, VHT80 (29.3Mbps) CH42

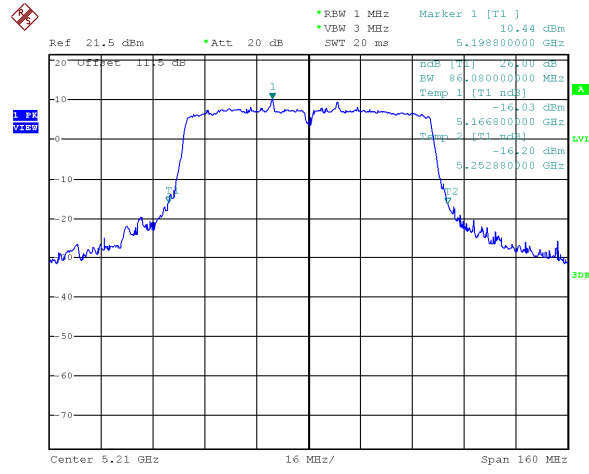
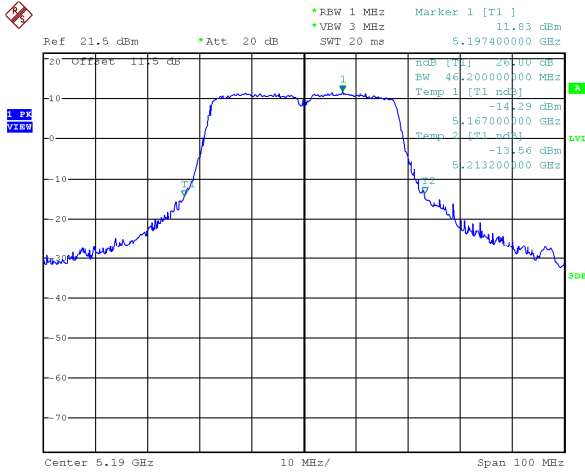

CH46

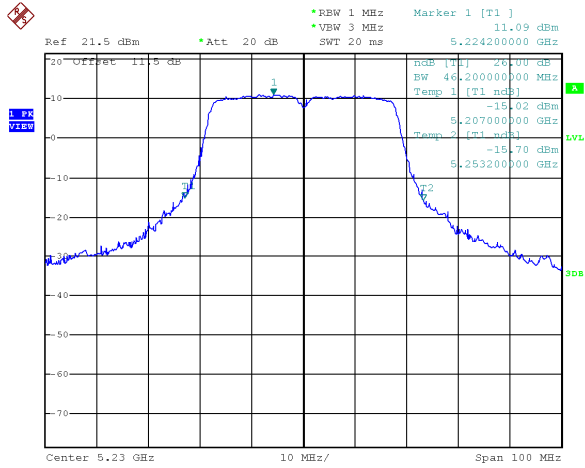



Antenna 2

Modulation Standard: 802.11a (6Mbps)
CH36

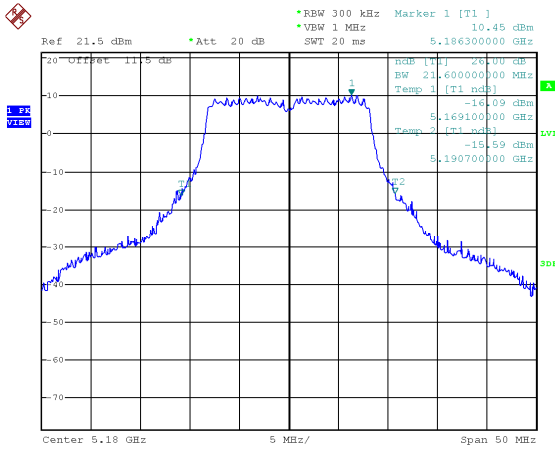

Modulation Standard: 802.11ac, VHT20 (6.5Mbps)
CH36

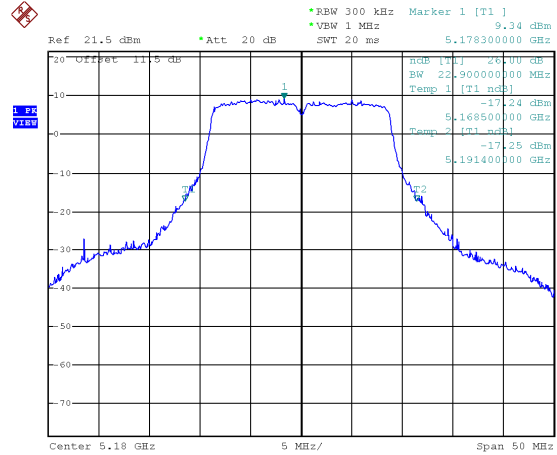

CH44

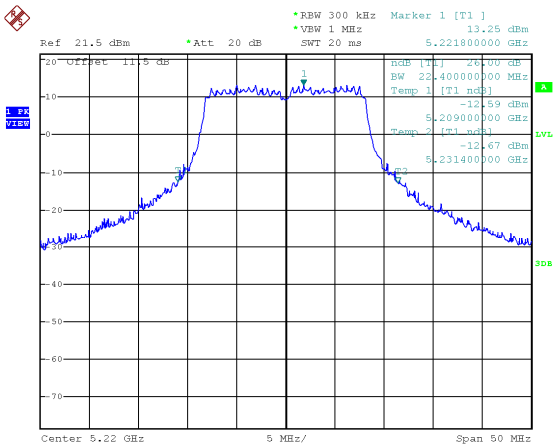

CH44

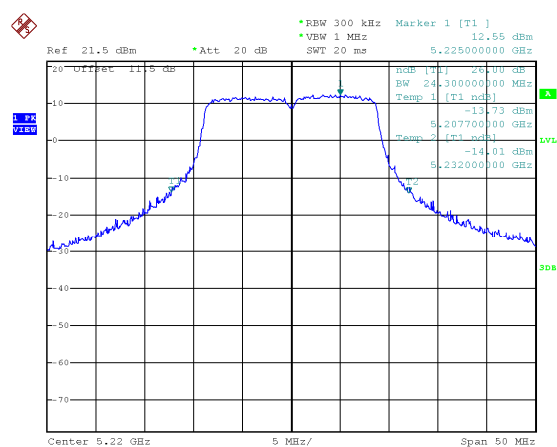

CH48

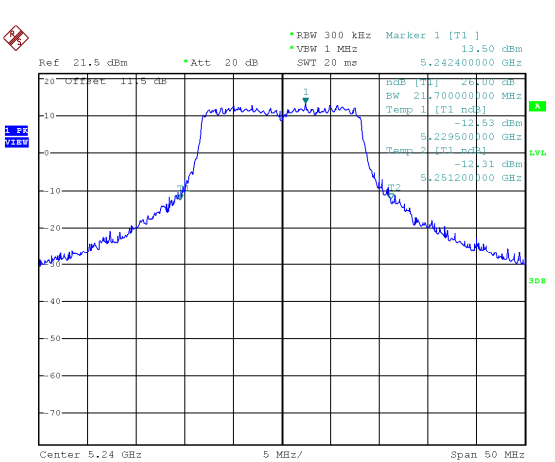

CH48

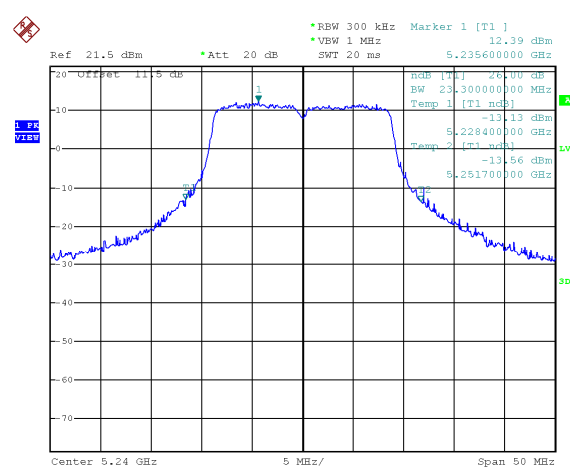



Antenna 2

Modulation Standard: 802.11ac, VHT40 (13.5Mbps) CH38

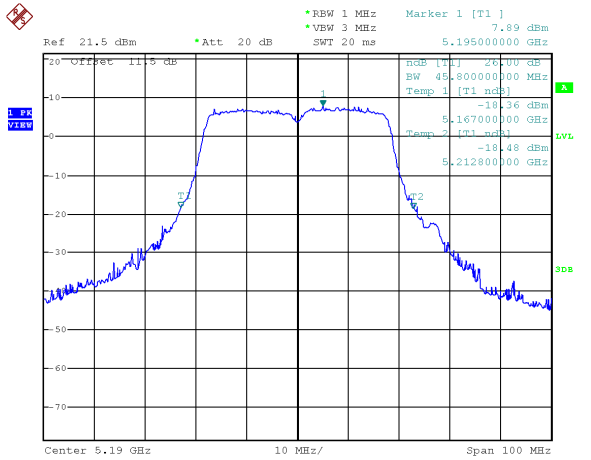

Modulation Standard: 802.11ac, VHT80 (29.3Mbps) CH42

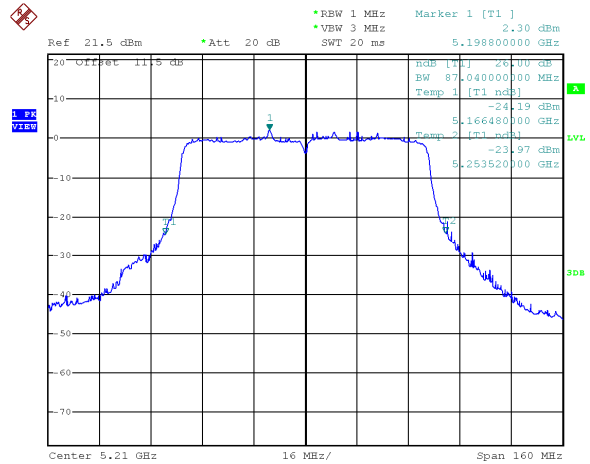

CH46

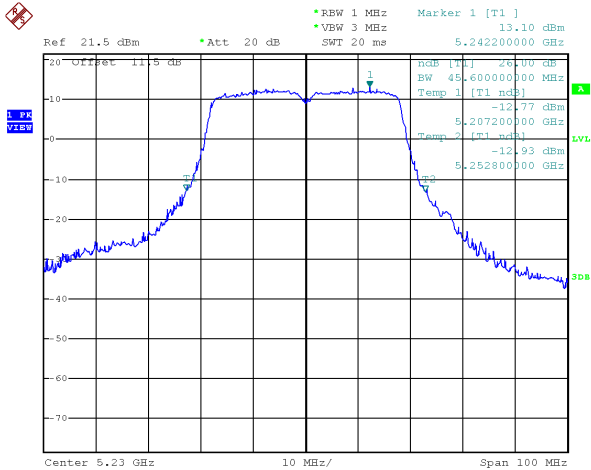



10. Average Power

10.1. Test Limit

None; for reporting purposes only.

10.2. Test Procedure

The transmitter output is connected to a power meter.

The cable assembly insertion loss of 11 dB (including 10 dB pad and 1 dB cable) was entered as an offset in the power meter to allow for direct reading of power.

10.3. Test Setup Layout

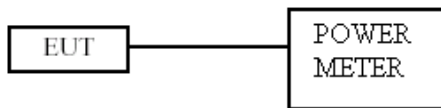

10.4. Test Result and Data

Temperature: 22°C

Humidity: 67%

Test Date: Dec. 06, 2016

In the 5.2G Band

Modulation Type	Channel	Frequency (MHz)	Avg Power Output (dBm)		Total Power (dBm) 1+2+3	Power Limit (dBm)
			ANT 1	ANT 2		
802.11a	36	5180	19.03	18.23	21.66	30.00
	44	5220	21.13	20.75	23.95	30.00
	48	5240	20.87	20.73	23.81	30.00
802.11an HT20	36	5180	18.51	17.62	21.10	30.00
	44	5220	21.00	20.83	23.93	30.00
	48	5240	20.85	20.61	23.74	30.00
802.11an HT40	38	5190	14.02	13.54	16.80	30.00
	46	5230	21.18	20.85	24.03	30.00
802.11ac VHT20	36	5180	18.54	17.66	21.13	30.00
	44	5220	21.02	20.85	23.95	30.00
	48	5240	20.89	20.67	23.79	30.00
802.11ac VHT40	38	5190	14.04	13.6	16.84	30.00
	46	5230	21.21	20.86	24.05	30.00
802.11ac VHT80	42	5210	12.68	12.15	15.43	30.00



Temperature: 22°C

Humidity: 67%

Test Date: Dec. 06, 2016

In the 5.8G Band

Modulation Type	Channel	Frequency (MHz)	Avg Power Output (dBm)		Total Power (dBm)	Power Limit (dBm)
			ANT 1	ANT 2	1+2+3	
802.11a	149	5745	23.12	22.76	25.95	30.00
	157	5785	22.93	22.56	25.76	30.00
	165	5825	23.30	22.87	26.10	30.00
802.11an HT20	149	5745	22.62	23.15	25.90	30.00
	157	5785	22.48	22.93	25.72	30.00
	165	5825	22.81	23.14	25.99	30.00
802.11an HT40	151	5755	22.86	22.38	25.64	30.00
	159	5795	22.71	22.11	25.43	30.00
802.11ac VHT20	149	5745	22.67	23.23	25.97	30.00
	157	5785	22.52	23.01	25.78	30.00
	165	5825	22.84	23.19	26.03	30.00
802.11ac VHT40	151	5755	22.90	22.41	25.67	30.00
	159	5795	22.76	22.15	25.48	30.00
802.11ac VHT80	155	5775	19.31	18.62	21.99	30.00



11. Output Power and PPSD

11.1. Test Limit

Output Power:

Frequency Band	Limit
<input checked="" type="checkbox"/> 5.15~5.25GHz	
Operating Mode	
<input type="checkbox"/> Outdoor access point	The maximum conducted output power over the frequency band of operation shall not exceed 1 W (30dBm) provided the maximum antenna gain does not exceed 6 dBi. If transmitting antennas of directional gain greater than 6 dBi are used, both the maximum conducted output power and the maximum power spectral density shall be reduced by the amount in dB that the directional gain of the antenna exceeds 6 dBi. The maximum e.i.r.p. at any elevation angle above 30degrees as measured from the horizon must not exceed 125 mW (21 dBm).
<input checked="" type="checkbox"/> Indoor access point	The maximum conducted output power over the frequency band of operation shall not exceed 1 W (30dBm) provided the maximum antenna gain does not exceed 6 dBi. If transmitting antennas of directional gain greater than 6 dBi are used, both the maximum conducted output power and the maximum power spectral density shall be reduced by the amount in dB that the directional gain of the antenna exceeds 6 dBi.
<input type="checkbox"/> Fixed point-to-point access points	The maximum conducted output power over the frequency band of operation shall not exceed 1 W (30dBm). Fixed point-to-point U-NII devices may employ antennas with directional gain up to 23 dBi without any corresponding reduction in the maximum conducted output power or maximum power spectral density. For fixed point-to-point transmitters that employ a directional antenna gain greater than 23 dBi, a 1 dB reduction in maximum conducted output power and maximum power spectral density is required for each 1 dB of antenna gain in excess of 23 dBi.
<input type="checkbox"/> Mobile and portable client devices	The maximum conducted output power over the frequency band of operation shall not exceed 250 mW (24dBm) provided the maximum antenna gain does not exceed 6 dBi. If transmitting antennas of directional gain greater than 6 dBi are used, both the maximum conducted output power and the maximum power spectral density shall be reduced by the amount in dB that the directional gain of the antenna exceeds 6 dBi.



Frequency Band		Limit
<input type="checkbox"/>	5.25-5.35 GHz	The maximum conducted output power over the frequency bands of operation shall not exceed the lesser of 250 mW (24dBm) or 11 dBm 10 log B, where B is the 26 dB emission bandwidth in megahertz. If transmitting antennas of directional gain greater than 6 dBi are used, both the maximum conducted output power and the maximum power spectral density shall be reduced by the amount in dB that the directional gain of the antenna exceeds 6 dBi.
<input type="checkbox"/>	5.470-5.725 GHz	
<input checked="" type="checkbox"/>	5.725~5.85 GHz	The maximum conducted output power over the frequency band of operation shall not exceed 1 W (30dBm). If transmitting antennas of directional gain greater than 6 dBi are used, both the maximum conducted output power and the maximum power spectral density shall be reduced by the amount in dB that the directional gain of the antenna exceeds 6 dBi. However, fixed point-to-point U-NII devices operating in this band may employ transmitting antennas with directional gain greater than 6 dBi without any corresponding reduction in transmitter conducted power.

PSD:

Frequency Band		Limit	
<input checked="" type="checkbox"/>	5.15~5.25GHz		
	Operating Mode		
	<input type="checkbox"/> Outdoor access point		17 dBm/MHz
	<input checked="" type="checkbox"/> Indoor access point		17 dBm/MHz
	<input type="checkbox"/> Fixed point-to-point access points		17 dBm/MHz
<input type="checkbox"/>	Mobile and portable client devices	11 dBm/MHz	
<input type="checkbox"/>	5.725~5.85 GHz	11 dBm/MHz	
<input type="checkbox"/>	5.470-5.725 GHz	11 dBm/MHz	
<input checked="" type="checkbox"/>	5.725~5.85 GHz	30 dBm/500kHz	



11.2. Test Procedure

As an alternative to FCC KDB-789033, the EUT maximum conducted output power was Measured with an average power meter employing a video bandwidth greater than 6dB BW of the emission under test. Maximum conducted output power was read directly from the meter across all data rates, and across three channels within each sub-band. Special care was used to make sure that the EUT was transmitting in continuous mode. This method exceeds the limitations of FCC KDB-789033, and provides more accurate measurements.

802.11an (BW ≤ 40MHz) Maximum conducted output power using KDB 789033 section E)3)b) Method PM-G (Measurement using a gated RF average power meter)

Note: the power meter have a video bandwidth that is greater than or equal to the measurement bandwidth, (Anritsu/ MA2411B video bandwidth: 65MHz)

802.11ac (BW=80MHz) Maximum conducted output power using KDB 789033 section E)2)b) Method SA-1 (trace averaging with the EUT transmitting at full power throughout each sweep).

When transmitted signals consist of two or more non-contiguous spectrum segments (e.g., 80+80 MHz mode) or when a single spectrum segment of a transmission crosses the boundary between two adjacent U-NII bands, KDB 644545 D01 section F) procedure is used for measurements.

11.3. Test Setup Layout

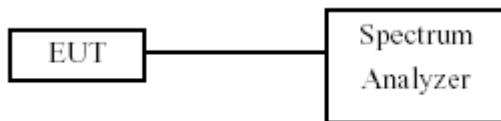

**11.4. Test Result and Data**

Temperature: 22°C

Humidity: 67%

Test Date: Dec. 06, 2016

In the 5.2G Band

Modulation Type	CH	Freq. (MHz)	Meas PPSD (dBm/MHz)		Sum chain (dBm)	Duty Cycle CF(dB)	Total Corr'd PPSD (dBm/MHz)	PPSD Limit (dBm/MHz)
			ANT 1	ANT 2				
802.11a	36	5180	6.02	5.15	8.62	0.10	8.72	15.24
	44	5220	9.13	9.06	12.11	0.10	12.21	15.24
	48	5240	9.10	9.12	12.12	0.10	12.22	15.24
802.11ac VHT20	36	5180	6.29	5.40	8.88	0.11	8.99	15.24
	44	5220	8.86	8.30	11.60	0.11	11.71	15.24
	48	5240	8.66	8.31	11.50	0.11	11.61	15.24
802.11ac VHT40	38	5190	-1.39	-2.28	1.20	0.73	1.93	15.24
	46	5230	5.85	5.88	8.88	0.73	9.61	15.24
802.11ac VHT80	42	5210	-8.51	-6.07	-4.11	0.46	-3.65	15.24

In the 5.8G Band

Modulation Type	CH	Freq. (MHz)	Meas PPSD (dBm/MHz)		Sum chain (dBm)	Duty Cycle CF(dB)	10log (500KHz/RBW) CF (dB)	Total Corr'd PPSD (dBm/500KHz)	PPSD Limit (dBm/500KHz)
			ANT 1	ANT 2					
802.11a	149	5745	10.19	10.40	13.31	0.10	-3.01	10.40	28.24
	157	5785	10.50	9.08	12.86	0.10	-3.01	9.95	28.24
	165	5825	11.12	9.57	13.42	0.10	-3.01	10.51	28.24
802.11ac VHT20	149	5745	6.12	6.08	9.11	0.11	-3.01	6.21	28.24
	157	5785	6.47	5.84	9.18	0.11	-3.01	6.28	28.24
	165	5825	7.03	6.95	10.00	0.11	-3.01	7.10	28.24
802.11ac VHT40	151	5755	2.99	2.35	5.69	0.73	-3.01	3.41	28.24
	159	5795	3.09	2.69	5.90	0.73	-3.01	3.62	28.24
802.11ac VHT80	155	5775	-1.09	-1.03	1.95	0.46	-3.01	-0.60	28.24



5.2G Band

Antenna 1

Modulation Standard: 802.11a (6Mbps)
CH36

Modulation Standard: 802.11ac, VHT20 (6.5Mbps)
CH36

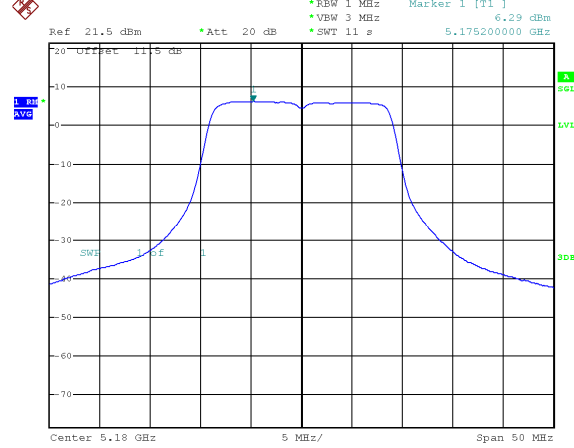
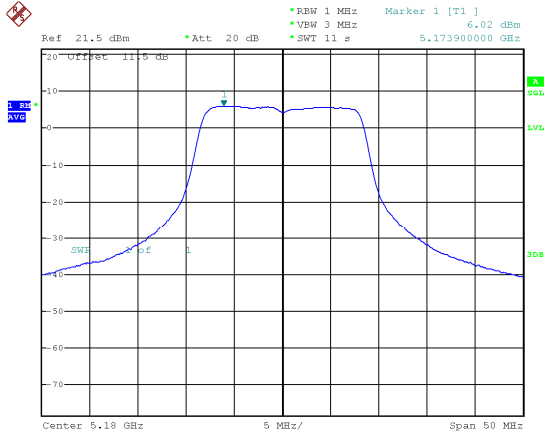

CH44

CH44

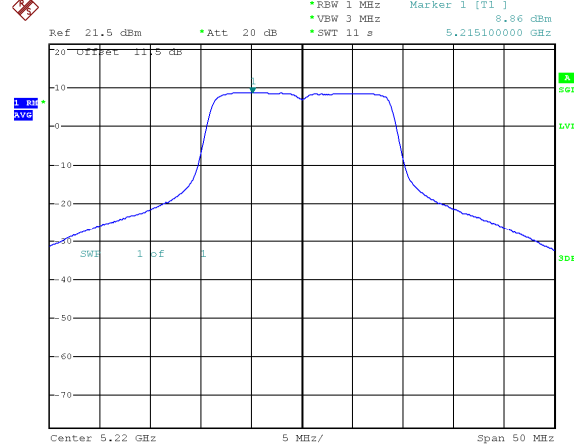
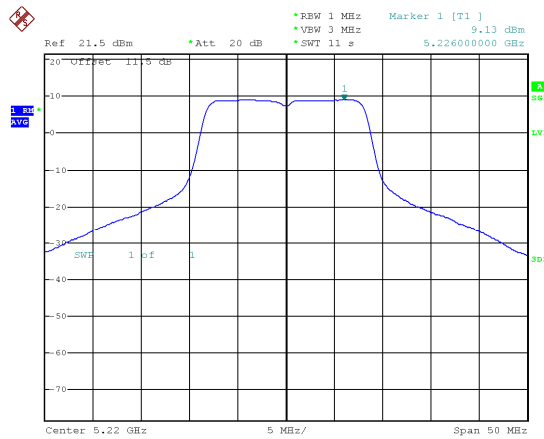

CH48

CH48

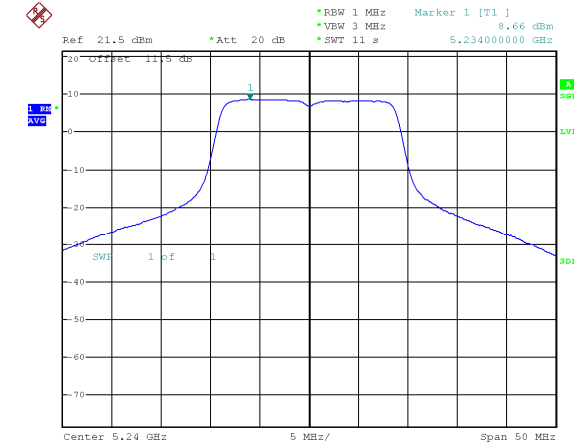
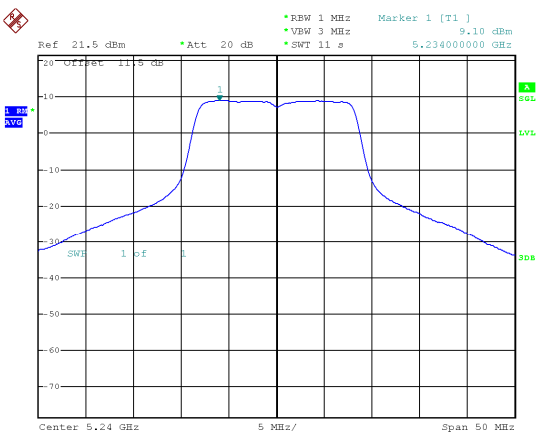



Antenna 1

Modulation Standard: 802.11ac, VHT40 (13.5Mbps)
CH38

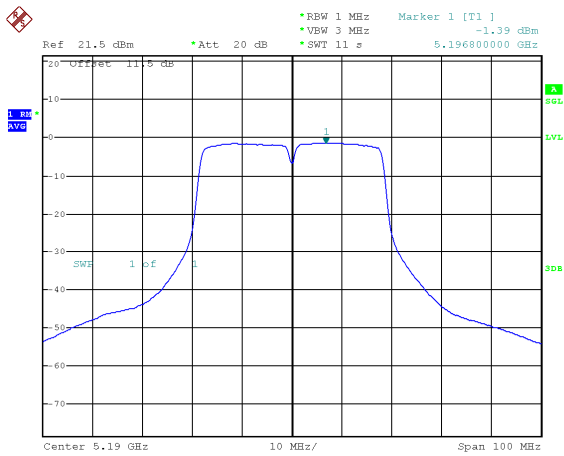

Modulation Standard: 802.11ac, VHT80 (29.3Mbps)
CH42

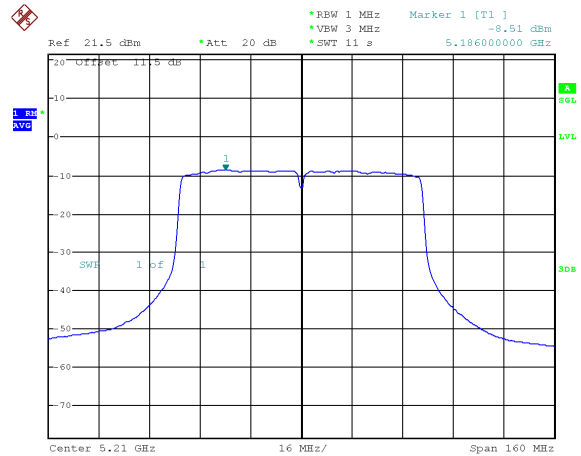

CH46

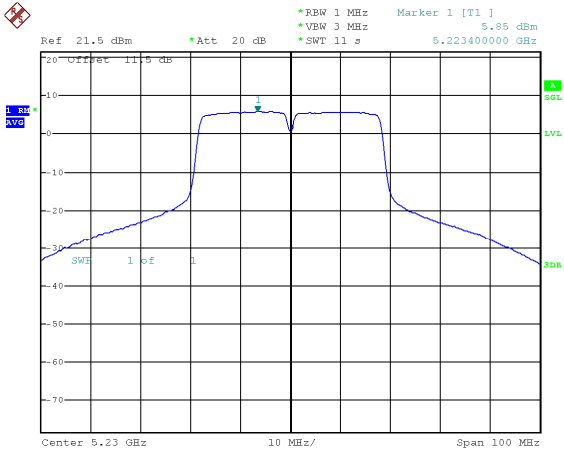



Antenna 2
Modulation Standard: 802.11a (6Mbps)
CH36

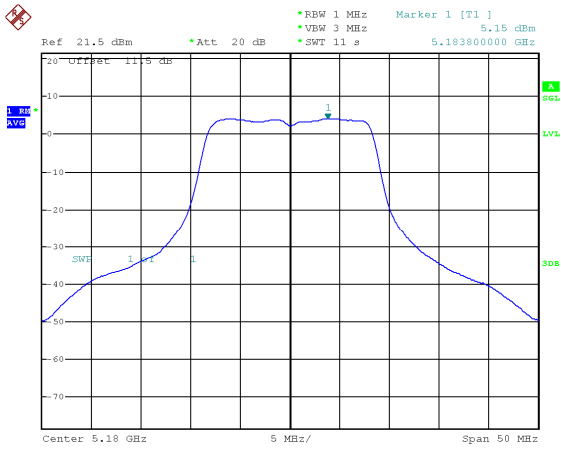

Modulation Standard: 802.11ac, VHT20 (6.5Mbps)
CH36

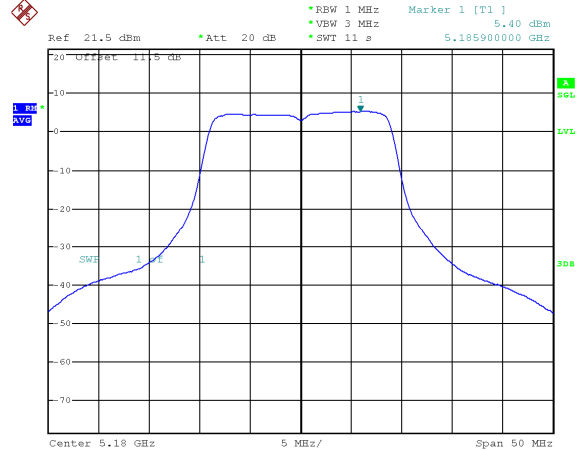

CH44

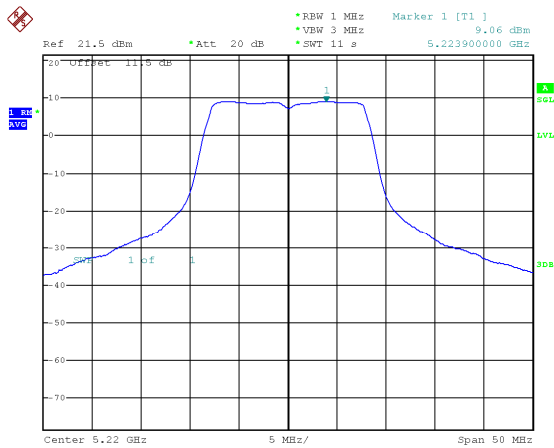

CH44

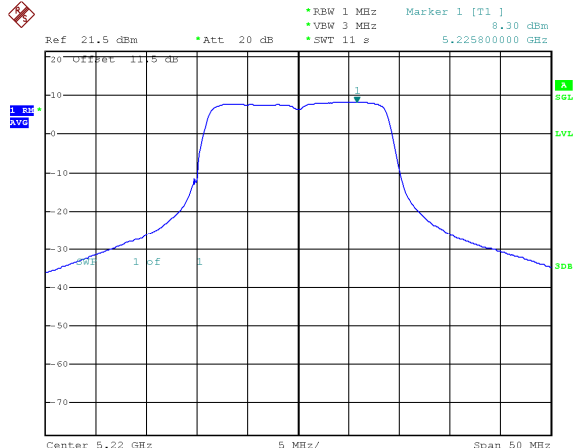

CH48

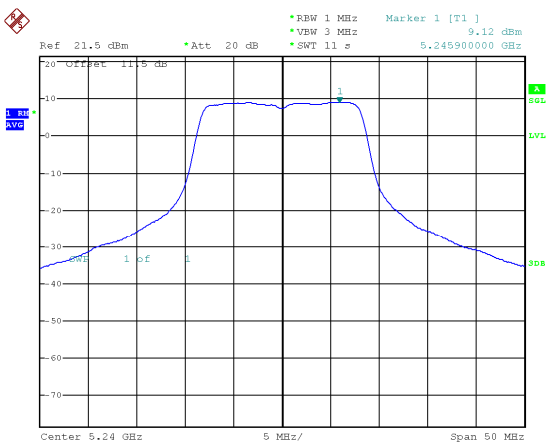

CH48

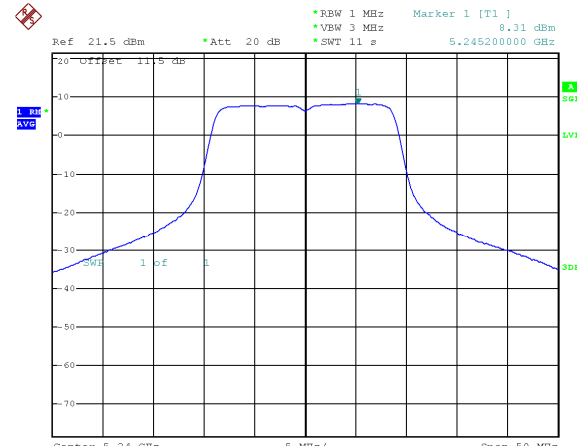



Antenna 2

Modulation Standard: 802.11ac, VHT40 (13.5Mbps)
CH38

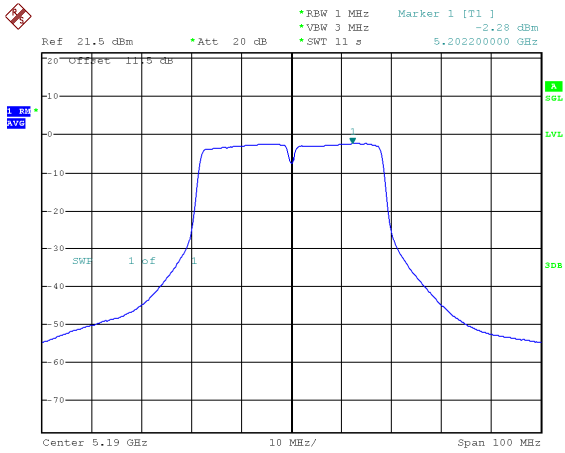

Modulation Standard: 802.11ac, VHT80 (29.3Mbps)
CH42

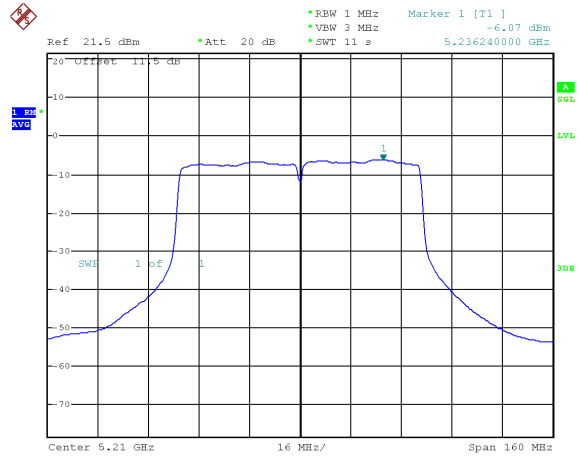

CH46

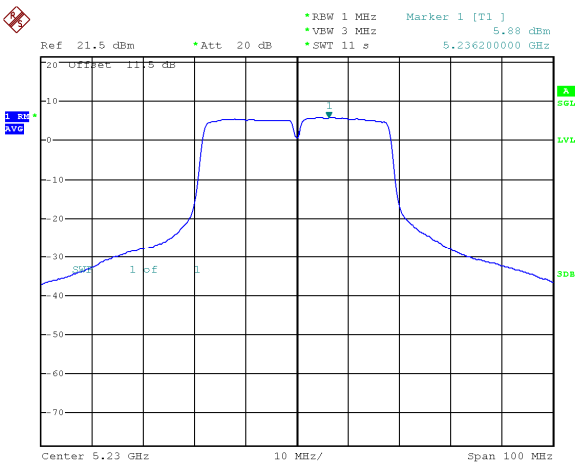



5.8G Band
Antenna 1
Modulation Standard: 802.11a (6Mbps)
CH149

Modulation Standard: 802.11ac, VHT20 (6.5Mbps)
CH149

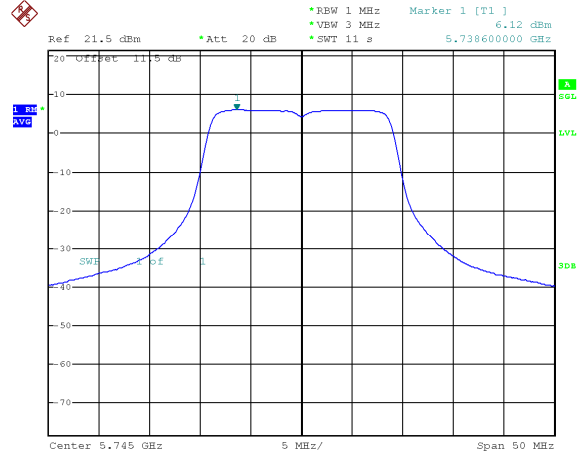
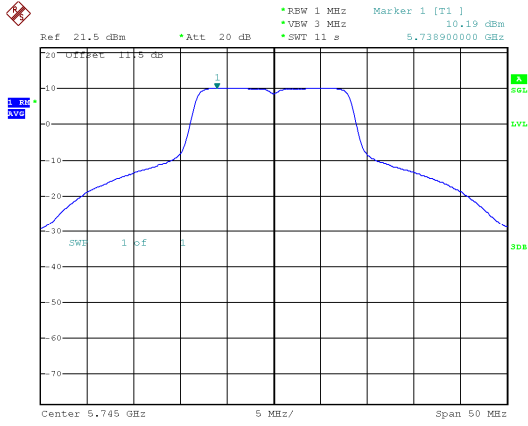

CH157

CH157

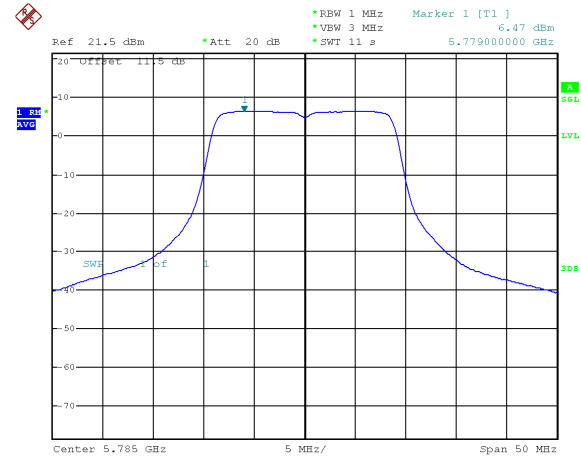
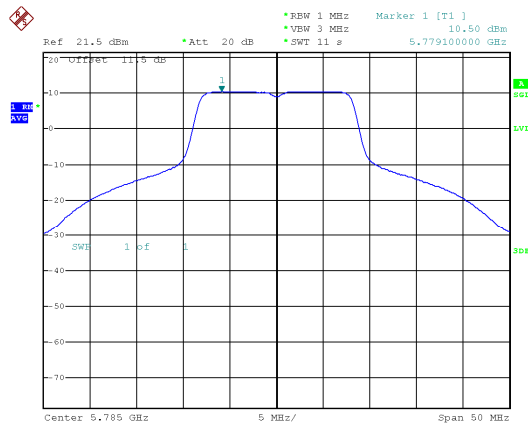

CH165

CH165

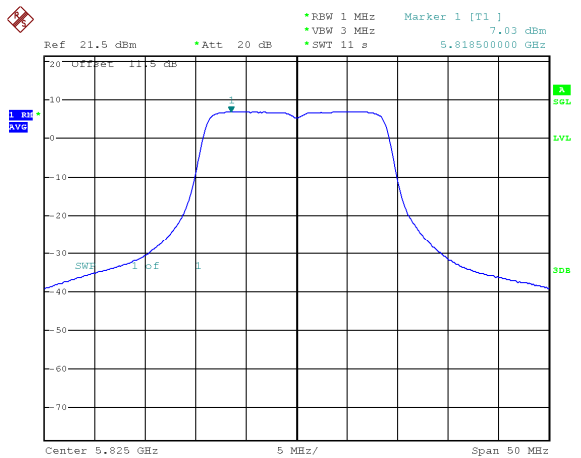
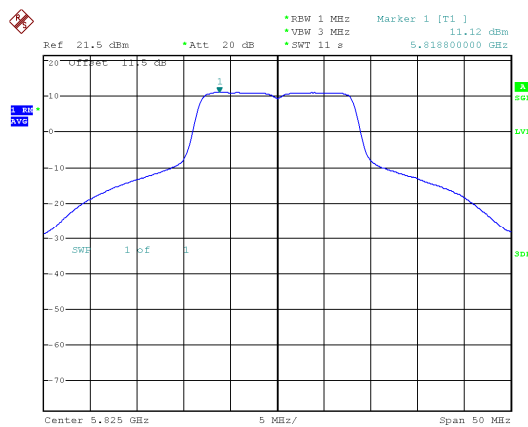



Antenna 1

Modulation Standard: 802.11ac, VHT40 (13.5Mbps)
CH151

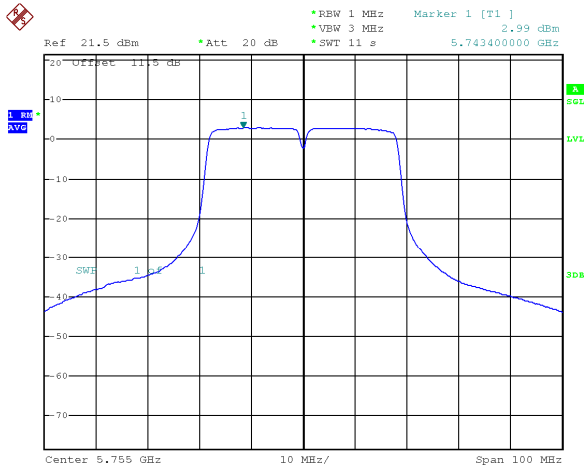

Modulation Standard: 802.11ac, VHT80 (29.3Mbps)
CH155

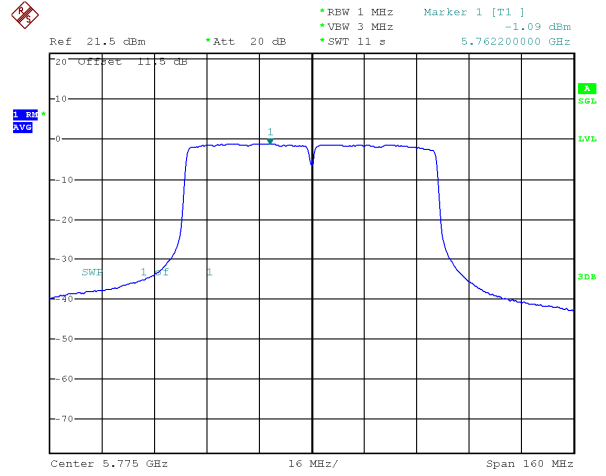

CH159

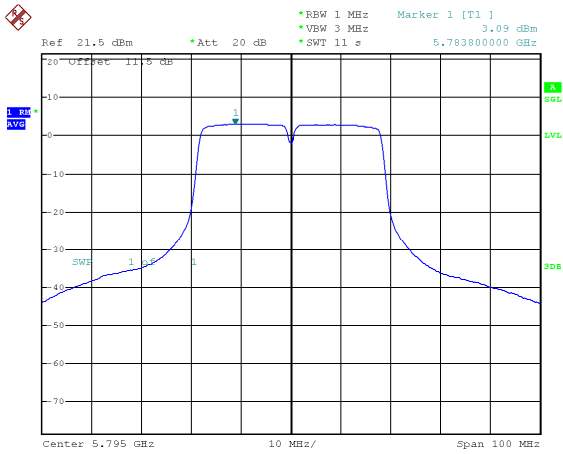



Antenna 2
Modulation Standard: 802.11a (6Mbps)
CH149

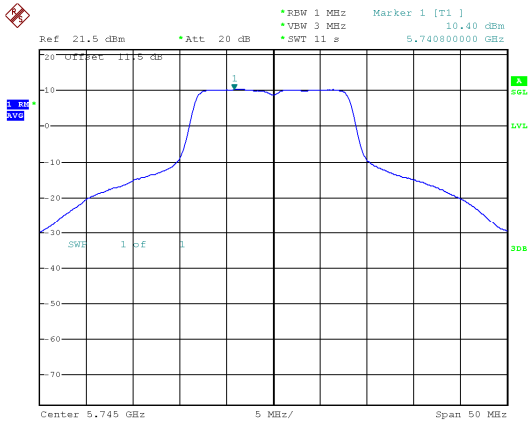

Modulation Standard: 802.11ac, VHT20 (6.5Mbps)
CH149

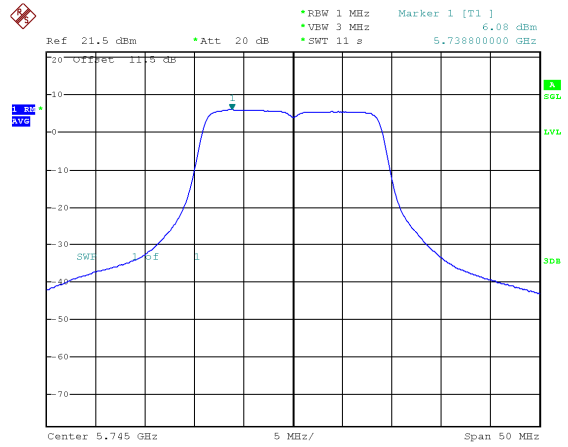

CH157

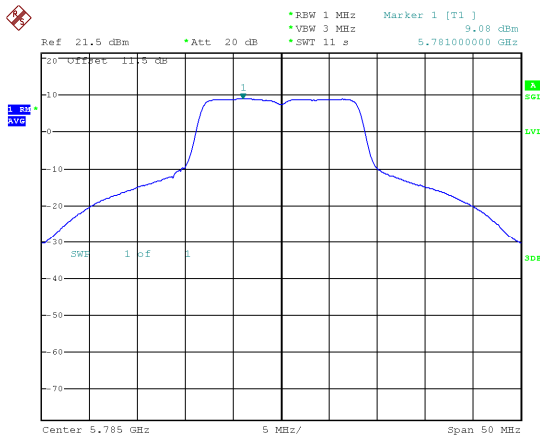

CH157

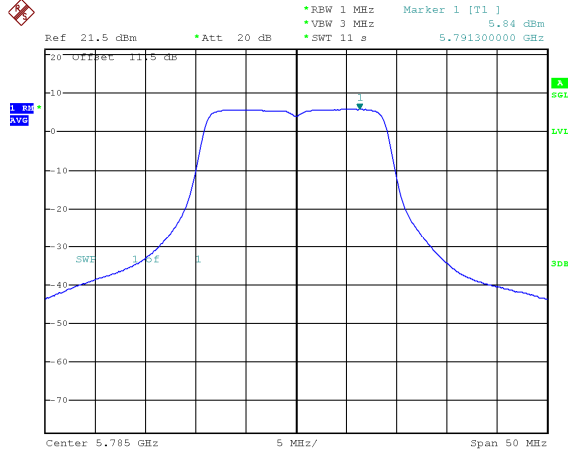

CH165

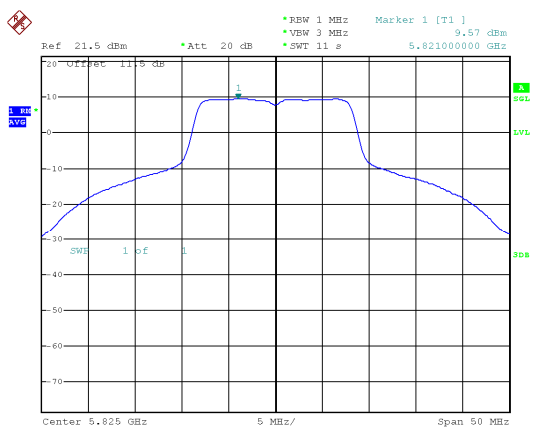

CH165

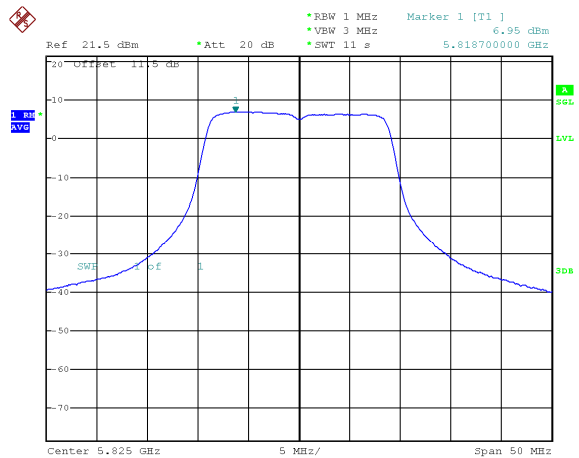



Antenna 2

Modulation Standard: 802.11ac, VHT40 (13.5Mbps)
CH151

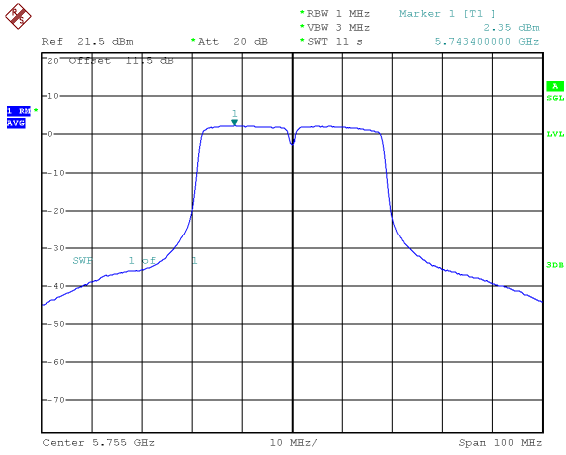

Modulation Standard: 802.11ac, VHT80 (29.3Mbps)
CH155

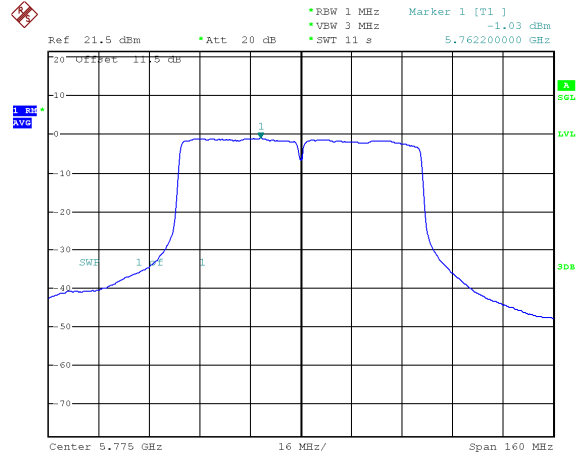

CH159

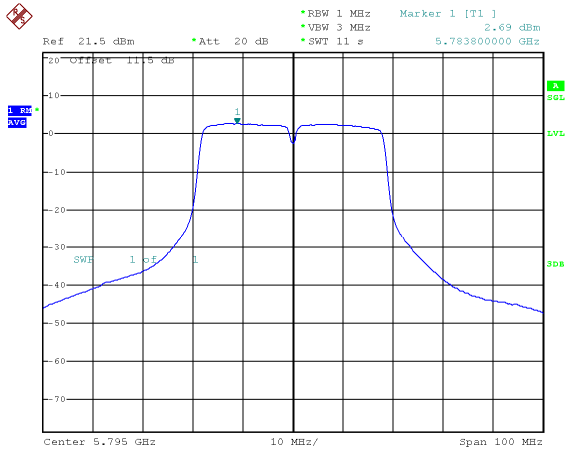



12. Frequency Stability

12.1. Test Procedure

1. The EUT was placed inside the Temperature and Humidity chamber.
2. The transmitter output was connected to spectrum analyzer.
3. Turn the EUT on and couple its output to a spectrum analyzer.
4. Turn the EUT off and set the chamber to the highest temperature specified.
5. Allow sufficient time (approximately 30 min) for the temperature of the chamber to stabilize, turn the EUT on and measure the operating frequency after 2, 5, and 10 minutes.
6. Repeat step 2 and 3 with the temperature chamber set to the lowest temperature.
7. The test chamber was allowed to stabilize at +20 degree C for a minimum of 30 minutes. The supply voltage was then adjusted on the EUT from 85% to 115% and the frequency record.

12.2. Test Setup Layout

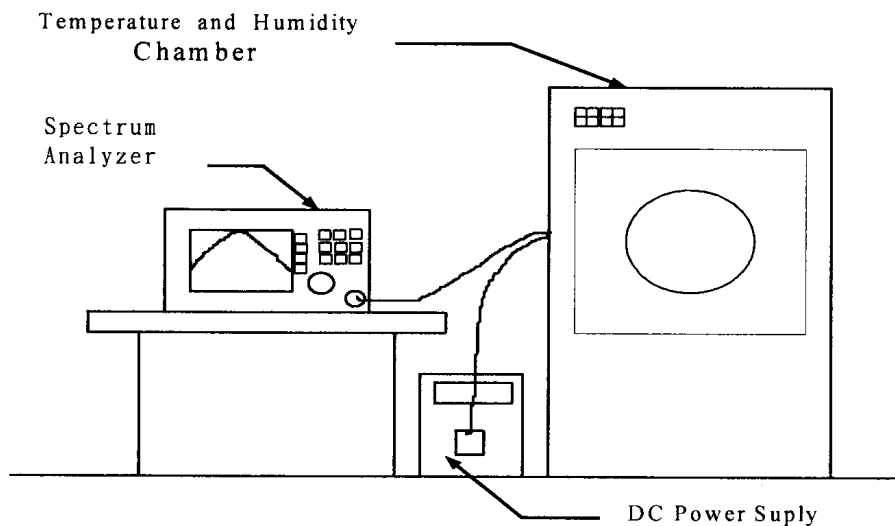



12.3. Test Result and Data

Temperature: 22°C

Humidity: 67%

Test Date: Dec. 06, 2016

Operating frequency: 5180 MHz							
Temp	Power supply	2 minute		5 minute		10 minute	
(°C)	(V)	(MHz)	(%)	(MHz)	(%)	(MHz)	(%)
50	102	5179.7112	-0.005575	5179.3383	-0.012775	5179.8859	-0.022028
	120	5179.9205	-0.001534	5179.4947	-0.009756	5179.0601	-0.181444
	138	5179.4713	-0.010206	5179.8630	-0.002646	5179.9189	-0.015662
40	102	5179.4123	-0.011346	5179.2355	-0.014759	5179.7676	-0.044859
	120	5179.1434	-0.016536	5179.2923	-0.013662	5179.5962	-0.077956
	138	5179.7385	-0.005048	5179.2830	-0.013841	5179.8073	-0.037198
30	102	5179.5950	-0.007818	5179.4929	-0.009790	5179.5005	-0.096426
	120	5179.6956	-0.005877	5179.1193	-0.017002	5179.0057	-0.191946
	138	5179.6183	-0.007369	5179.0298	-0.018730	5179.7629	-0.045780
20	102	5179.9727	-0.000528	5179.6132	-0.007468	5179.8501	-0.028936
	120	5179.3163	-0.013200	5179.9192	-0.001560	5179.6812	-0.061550
	138	5179.6036	-0.007652	5179.8474	-0.002945	5179.0266	-0.187915
10	102	5179.5014	-0.009625	5179.6683	-0.006403	5179.1328	-0.167405
	120	5179.6950	-0.005888	5179.5254	-0.009162	5179.7057	-0.056822
	138	5179.0293	-0.018739	5179.7742	-0.004360	5179.7548	-0.047343
0	102	5179.8077	-0.003713	5179.8012	-0.003837	5179.8409	-0.030710
	120	5179.6455	-0.006844	5179.5171	-0.009322	5179.0755	-0.178468
	138	5179.3411	-0.012721	5179.6699	-0.006372	5179.2622	-0.142429
-10	102	5179.1108	-0.017165	5179.3885	-0.011805	5179.8071	-0.037233
	120	5179.0388	-0.018555	5179.8673	-0.002562	5179.6104	-0.075214
	138	5179.4972	-0.009707	5179.6155	-0.007422	5179.7703	-0.044343
-20	102	5179.2849	-0.013805	5179.9431	-0.001098	5179.0057	-0.191953
	120	5179.7663	-0.004511	5179.1458	-0.016491	5179.6837	-0.061068
	138	5179.2543	-0.014396	5179.9323	-0.001308	5179.6749	-0.062767
-30	102	5179.3399	-0.012744	5179.8155	-0.003562	5179.4787	-0.100642
	120	5179.6201	-0.007334	5179.0740	-0.017877	5179.7160	-0.054832
	138	5179.9267	-0.001415	5179.1826	-0.015779	5179.8740	-0.024324

Limit:

Manufacturers of U-NII devices are responsible for ensuring frequency stability such that an emission is maintained within the band of operation under all conditions of normal operation as specified in the users manual.



13. Automatically Discontinue Transmission

13.1.Limit of Automatically Discontinue Transmission

The device shall automatically discontinue transmission in case of either absence of information to transmit or operational failure. These provisions are not intended to preclude the transmission of control or signaling information or the use of repetitive codes used by certain digital technologies to complete frame or burst intervals. Applicants shall include in their application for equipment authorization to describe how this requirement is met.

13.2.Test Result of Automatically Discontinue Transmission

While the EUT is not transmitting any information, the EUT can automatically discontinue transmission and become standby mode for power saving. The EUT can detect the controlling signal of ACK message transmitting from remote device and verify whether it shall resend or discontinue transmission.