



# FCC TEST REPORT

**REPORT NO.:** RF120810C18  
**MODEL NO.:** OM2P-HS  
**FCC ID:** WT8OM2PHS  
**RECEIVED:** Aug. 10, 2012  
**TESTED:** Aug. 16 ~ Aug. 22, 2012  
**ISSUED:** Aug. 27, 2012

**APPLICANT:** Open Mesh, Inc.

**ADDRESS:** 7327 SW Barnes Rd #422, Portland, OR 97225

**ISSUED BY:** Bureau Veritas Consumer Products Services  
(H.K.) Ltd., Taoyuan Branch

**LAB ADDRESS:** No. 47, 14th Ling, Chia Pau Vil., Lin Kou Dist.,  
New Taipei City, Taiwan, R.O.C.

**TEST LOCATION:** No. 19, Hwa Ya 2nd Rd, Wen Hwa Tsuen, Kwei  
Shan Hsiang, Taoyuan Hsien 333, Taiwan, R.O.C.

This report should not be used by the client to claim product certification, approval, or endorsement by TAF or any government agencies.



This report is for your exclusive use. Any copying or replication of this report to or for any other person or entity, or use of our name or trademark, is permitted only with our prior written permission. This report sets forth our findings solely with respect to the test samples identified herein. The results set forth in this report are not indicative or representative of the quality or characteristics of the lot from which a test sample was taken or any similar or identical product unless specifically and expressly noted. Our report includes all of the tests requested by you and the results thereof based upon the information that you provided to us. You have 60 days from date of issuance of this report to notify us of any material error or omission caused by our negligence, provided, however, that such notice shall be in writing and shall specifically address the issue you wish to raise. A failure to raise such issue within the prescribed time shall constitute your unqualified acceptance of the completeness of this report, the tests conducted and the correctness of the report contents. Unless specific mention, the uncertainty of measurement has been explicitly taken into account to declare the compliance or non-compliance to the specification.



## TABLE OF CONTENTS

RELEASE CONTROL RECORD.....	4
1. CERTIFICATION .....	5
2. SUMMARY OF TEST RESULTS .....	6
2.1 MEASUREMENT UNCERTAINTY.....	6
3. GENERAL INFORMATION.....	7
3.1 GENERAL DESCRIPTION OF EUT .....	7
3.2 DESCRIPTION OF TEST MODES .....	8
3.2.1 TEST MODE APPLICABILITY AND TESTED CHANNEL DETAIL .....	9
3.3 DESCRIPTION OF SUPPORT UNITS .....	11
3.3.1 CONFIGURATION OF SYSTEM UNDER TEST .....	12
3.4 GENERAL DESCRIPTION OF APPLIED STANDARDS .....	13
4. TEST TYPES AND RESULTS .....	14
4.1 RADIATED EMISSION AND BANDEDGE MEASUREMENT.....	14
4.1.1 LIMITS OF RADIATED EMISSION AND BANDEDGE MEASUREMENT .....	14
4.1.2 TEST INSTRUMENTS.....	15
4.1.3 TEST PROCEDURES .....	16
4.1.4 DEVIATION FROM TEST STANDARD .....	16
4.1.5 TEST SETUP.....	17
4.1.6 EUT OPERATING CONDITIONS .....	17
4.1.7 TEST RESULTS .....	18
4.2 CONDUCTED EMISSION MEASUREMENT .....	32
4.2.1 LIMITS OF CONDUCTED EMISSION MEASUREMENT .....	32
4.2.2 TEST INSTRUMENTS.....	32
4.2.3 TEST PROCEDURES .....	33
4.2.4 DEVIATION FROM TEST STANDARD .....	33
4.2.5 TEST SETUP.....	33
4.2.6 EUT OPERATING CONDITIONS .....	33
4.2.7 TEST RESULTS .....	34
4.3 6dB BANDWIDTH MEASUREMENT.....	38
4.3.1 LIMITS OF 6dB BANDWIDTH MEASUREMENT .....	38
4.3.2 TEST SETUP.....	38
4.3.3 TEST INSTRUMENTS.....	38
4.3.4 TEST PROCEDURE.....	38
4.3.5 DEVIATION FROM TEST STANDARD .....	38
4.3.6 EUT OPERATING CONDITIONS .....	38
4.3.7 TEST RESULTS .....	39
4.4 CONDUCTED OUTPUT POWER .....	40
4.4.1 LIMITS OF CONDUCTED OUTPUT POWER MEASUREMENT .....	40
4.4.2 TEST SETUP.....	40
4.4.3 TEST INSTRUMENTS.....	40
4.4.4 TEST PROCEDURES .....	40
4.4.5 DEVIATION FROM TEST STANDARD .....	40
4.4.6 EUT OPERATING CONDITIONS .....	40
4.4.7 TEST RESULTS .....	41
4.5 POWER SPECTRAL DENSITY MEASUREMENT.....	42
4.5.1 LIMITS OF POWER SPECTRAL DENSITY MEASUREMENT .....	42
4.5.2 TEST SETUP.....	42
4.5.3 TEST INSTRUMENTS.....	42



A D T

4.5.4	TEST PROCEDURE.....	42
4.5.5	DEVIATION FROM TEST STANDARD .....	42
4.5.6	EUT OPERATING CONDITION .....	42
4.5.7	TEST RESULTS .....	43
4.6	CONDUCTED OUT OF BAND EMISSION MEASUREMENT.....	44
4.6.1	LIMITS OF CONDUCTED OUT OF BAND EMISSION MEASUREMENT .....	44
4.6.2	TEST SETUP.....	44
4.6.3	TEST INSTRUMENTS.....	44
4.6.4	TEST PROCEDURE.....	44
4.6.5	DEVIATION FROM TEST STANDARD .....	45
4.6.6	EUT OPERATING CONDITION .....	45
4.6.7	TEST RESULTS .....	45
5.	PHOTOGRAPHS OF THE TEST CONFIGURATION.....	50
6.	INFORMATION ON THE TESTING LABORATORIES .....	51
7.	APPENDIX A - MODIFICATIONS RECORDERS FOR ENGINEERING CHANGES TO THE EUT BY THE LAB .....	52



## RELEASE CONTROL RECORD

ISSUE NO.	REASON FOR CHANGE	DATE ISSUED
RF120810C18	Original release	Aug. 27, 2012



# 1. CERTIFICATION

**PRODUCT:** Wireless 802.11b/g/n Mesh Router  
**MODEL NO.:** OM2P-HS  
**BRAND:** Open Mesh  
**APPLICANT:** Open Mesh, Inc.  
**TESTED:** Aug. 16 ~ Aug. 22, 2012  
**TEST SAMPLE:** ENGINEERING SAMPLE  
**STANDARDS:** **FCC Part 15, Subpart C (Section 15.247)**  
ANSI C63.10-2009

The above equipment (model: OM2P-HS) has been tested by **Bureau Veritas Consumer Products Services (H.K.) Ltd., Taoyuan Branch**, and found compliance with the requirement of the above standards. The test record, data evaluation & Equipment Under Test (EUT) configurations represented herein are true and accurate accounts of the measurements of the sample's EMC characteristics under the conditions specified in this report.

**PREPARED BY** : Andrea Hsia , **DATE** : Aug. 27, 2012  
Andrea Hsia / Specialist

**APPROVED BY** : Gary Chang , **DATE** : Aug. 27, 2012  
Gary Chang / Technical Manager

## 2. SUMMARY OF TEST RESULTS

The EUT has been tested according to the following specifications:

APPLIED STANDARD: FCC PART 15, SUBPART C (SECTION 15.247)			
STANDARD SECTION	TEST TYPE	RESULT	REMARK
15.207	AC Power Conducted Emission	PASS	Meet the requirement of limit. Minimum passing margin is -14.88dB at 0.16562MHz.
15.247(d) 15.209	Radiated Emissions	PASS	Meet the requirement of limit. Minimum passing margin is -1.2dB at 2390.00MHz.
15.247(d)	Band Edge Measurement	PASS	Meet the requirement of limit.
15.247(a)(2)	6dB bandwidth	PASS	Meet the requirement of limit.
15.247(b)	Conducted power	PASS	Meet the requirement of limit.
15.247(e)	Power Spectral Density	PASS	Meet the requirement of limit.
15.203	Antenna Requirement	PASS	No antenna connector is used.

### 2.1 MEASUREMENT UNCERTAINTY

Where relevant, the following measurement uncertainty levels have been estimated for tests performed on the EUT as specified in CISPR 16-4-2:

MEASUREMENT	FREQUENCY	UNCERTAINTY
Conducted emissions	9kHz~30MHz	2.44 dB
Radiated emissions	30MHz ~ 200MHz	3.34 dB
	200MHz ~1000MHz	3.35 dB
	1GHz ~ 18GHz	2.26 dB
	18GHz ~ 40GHz	1.94 dB

This uncertainty represents an expanded uncertainty expressed at approximately the 95% confidence level using a coverage factor of  $k = 2$ .



### 3. GENERAL INFORMATION

#### 3.1 GENERAL DESCRIPTION OF EUT

<b>EUT</b>	Wireless 802.11b/g/n Mesh Router
<b>MODEL NO.</b>	OM2P-HS
<b>NOMINAL VOLTAGE</b>	12Vdc (adapter) 12Vdc (POE)
<b>MODULATION TYPE</b>	CCK, DQPSK, DBPSK for DSSS 64QAM, 16QAM, QPSK, BPSK for OFDM
<b>MODULATION TECHNOLOGY</b>	DSSS, OFDM
<b>TRANSFER RATE</b>	802.11b:11/5.5/2/1Mbps 802.11g: 54/48/36/24/18/12/9/6Mbps 802.11n: up to 300Mbps
<b>OPERATING FREQUENCY</b>	2412 ~ 2462MHz
<b>NUMBER OF CHANNEL</b>	11 for 802.11b, 802.11g, 802.11n (20MHz) 7 for 802.11n (40MHz)
<b>OUTPUT POWER</b>	996.30mW
<b>ANTENNA TYPE</b>	Printing antenna with 2dBi gain
<b>ANTENNA CONNECTOR</b>	NA
<b>DATA CABLE</b>	NA
<b>I/O PORTS</b>	Refer to user's manual
<b>ACCESSORY DEVICES</b>	Adapter

**NOTE:**

- The EUT incorporates a MIMO function. Physically, the EUT provides two completed transmitters and two receivers.

MODULATION MODE	TX FUNCTION
802.11b	1TX
802.11g	1TX
802.11n (20MHz)	2TX
802.11n (40MHz)	2TX

- The EUT consumes power from the following adapters & POE:

ADAPTER	
<b>BRAND:</b>	DVE
<b>MODEL:</b>	DSA-15P-12 FEU
<b>INPUT:</b>	100-240Vac, 50/60Hz, 0.3A
<b>OUTPUT:</b>	12Vdc, 1.25A
<b>POWER LINE:</b>	1.5m non-shielded cable without core

POE	
<b>BRAND:</b>	EnGenius
<b>MODEL:</b>	EPE-1212
<b>OUTPUT:</b>	12Vdc, 0.6A

POE'S ADAPTER	
<b>BRAND:</b>	DVE
<b>MODEL:</b>	DSA-12G-12 FEU
<b>INPUT:</b>	100-240Vac, 50/60Hz, 0.3A
<b>OUTPUT:</b>	12Vdc, 1A
<b>POWER LINE:</b>	1.5m non-shielded cable without core

\*Adapter, POE & POE's adapter were for the optional accessory.

- The above EUT information is declared by the manufacturer and for more detailed features description, please refer to the manufacturer's specifications or User's Manual.

### 3.2 DESCRIPTION OF TEST MODES

11 channels are provided for 802.11b, 802.11g and 802.11n (20MHz):

CHANNEL	FREQUENCY	CHANNEL	FREQUENCY
1	2412MHz	7	2442MHz
2	2417MHz	8	2447MHz
3	2422MHz	9	2452MHz
4	2427MHz	10	2457MHz
5	2432MHz	11	2462MHz
6	2437MHz		

7 channels are provided for 802.11n (40MHz):

CHANNEL	FREQUENCY	CHANNEL	FREQUENCY
3	2422MHz	7	2442MHz
4	2427MHz	8	2447MHz
5	2432MHz	9	2452MHz
6	2437MHz		





### 3.2.1 TEST MODE APPLICABILITY AND TESTED CHANNEL DETAIL

EUT CONFIGURE MODE	APPLICABLE TO				DESCRIPTION
	RE≥1G	RE<1G	PLC	APCM	
A	√	√	√	√	Power from AC Adapter
B	-	√	√	-	Power from POE

Where **RE≥1G**: Radiated Emission above 1GHz      **RE<1G**: Radiated Emission below 1GHz  
**PLC**: Power Line Conducted Emission      **APCM**: Antenna Port Conducted Measurement

**NOTE: 1.** The EUT had been pre-tested on the positioned of each 3 axis. The worst case was found when positioned on **X-plane**.  
**2.** "-" means no effect.

#### **RADIATED EMISSION TEST (ABOVE 1GHz):**

- Pre-Scan has been conducted to determine the worst-case mode from all possible combinations between available modulations, data rates and antenna ports (if EUT with antenna diversity architecture).
- Following channel(s) was (were) selected for the final test as listed below.

EUT CONFIGURE MODE	MODE	AVAILABLE CHANNEL	TESTED CHANNEL	MODULATION TECHNOLOGY	MODULATION TYPE	DATA RATE (Mbps)
A	802.11b	1 to 11	1, 6, 11	DSSS	DBPSK	1.0
A	802.11g	1 to 11	1, 6, 11	OFDM	BPSK	6.0
A	802.11n (20MHz)	1 to 11	1, 6, 11	OFDM	BPSK	7.2
A	802.11n (40MHz)	3 to 9	3, 6, 9	OFDM	BPSK	15.0

#### **RADIATED EMISSION TEST (BELOW 1GHz):**

- Pre-Scan has been conducted to determine the worst-case mode from all possible combinations between available modulations, data rates and antenna ports (if EUT with antenna diversity architecture).
- Following channel(s) was (were) selected for the final test as listed below.

EUT CONFIGURE MODE	MODE	AVAILABLE CHANNEL	TESTED CHANNEL	MODULATION TECHNOLOGY	MODULATION TYPE	DATA RATE (Mbps)
A & B	802.11n (40MHz)	3 to 9	6	OFDM	BPSK	15.0

#### **POWER LINE CONDUCTED EMISSION TEST:**

- Pre-Scan has been conducted to determine the worst-case mode from all possible combinations between available modulations, data rates and antenna ports (if EUT with antenna diversity architecture).
- Following channel(s) was (were) selected for the final test as listed below.

EUT CONFIGURE MODE	MODE	AVAILABLE CHANNEL	TESTED CHANNEL	MODULATION TECHNOLOGY	MODULATION TYPE	DATA RATE (Mbps)
A & B	802.11n (40MHz)	3 to 9	6	OFDM	BPSK	15.0

**BANDEDGE MEASUREMENT:**

- Pre-Scan has been conducted to determine the worst-case mode from all possible combinations between available modulations, data rates and antenna ports (if EUT with antenna diversity architecture).
- Following channel(s) was (were) selected for the final test as listed below.

EUT CONFIGURE MODE	MODE	AVAILABLE CHANNEL	TESTED CHANNEL	MODULATION TECHNOLOGY	MODULATION TYPE	DATA RATE (Mbps)
A	802.11b	1 to 11	1, 11	DSSS	DBPSK	1.0
A	802.11g	1 to 11	1, 11	OFDM	BPSK	6.0
A	802.11n (20MHz)	1 to 11	1, 11	OFDM	BPSK	7.2
A	802.11n (40MHz)	3 to 9	3, 9	OFDM	BPSK	15.0

**ANTENNA PORT CONDUCTED MEASUREMENT:**

- This item includes all test value of each mode, but only includes spectrum plot of worst value of each mode.
- Pre-Scan has been conducted to determine the worst-case mode from all possible combinations between available modulations, data rates and antenna ports (if EUT with antenna diversity architecture).
- Following channel(s) was (were) selected for the final test as listed below.

EUT CONFIGURE MODE	MODE	AVAILABLE CHANNEL	TESTED CHANNEL	MODULATION TECHNOLOGY	MODULATION TYPE	DATA RATE (Mbps)
A	802.11b	1 to 11	1, 6, 11	DSSS	DBPSK	1.0
A	802.11g	1 to 11	1, 6, 11	OFDM	BPSK	6.0
A	802.11n (20MHz)	1 to 11	1, 6, 11	OFDM	BPSK	7.2
A	802.11n (40MHz)	3 to 9	3, 6, 9	OFDM	BPSK	15.0

**TEST CONDITION:**

APPLICABLE TO	ENVIRONMENTAL CONDITIONS	INPUT POWER	TESTED BY
RE≥1G	25deg. C, 65%RH	120Vac, 60Hz	Chirs Lin
RE<1G	25deg. C, 65%RH	48Vdc 120Vac, 60Hz	Haru Yang Chirs Lin
PLC	25deg. C, 65%RH	48Vdc 120Vac, 60Hz	Anderson Hong
APCM	25deg. C, 65%RH	120Vac, 60Hz	Haru Yang

### 3.3 DESCRIPTION OF SUPPORT UNITS

The EUT has been tested as an independent unit together with other necessary accessories or support units. The following support units or accessories were used to form a representative test configuration during the tests.

NO.	PRODUCT	BRAND	MODEL NO.	SERIAL NO.	FCC ID
1	NOTEBOOK	DELL	E5420	33MLMQ1	NA

NO.	SIGNAL CABLE DESCRIPTION OF THE ABOVE SUPPORT UNITS
1	10m UTP RJ45 cable

**NOTE:**

1. All power cords of the above support units are non shielded (1.8m).
2. Item 1 acted as communication partner to transfer data.

### 3.3.1 CONFIGURATION OF SYSTEM UNDER TEST

#### TEST MODE A

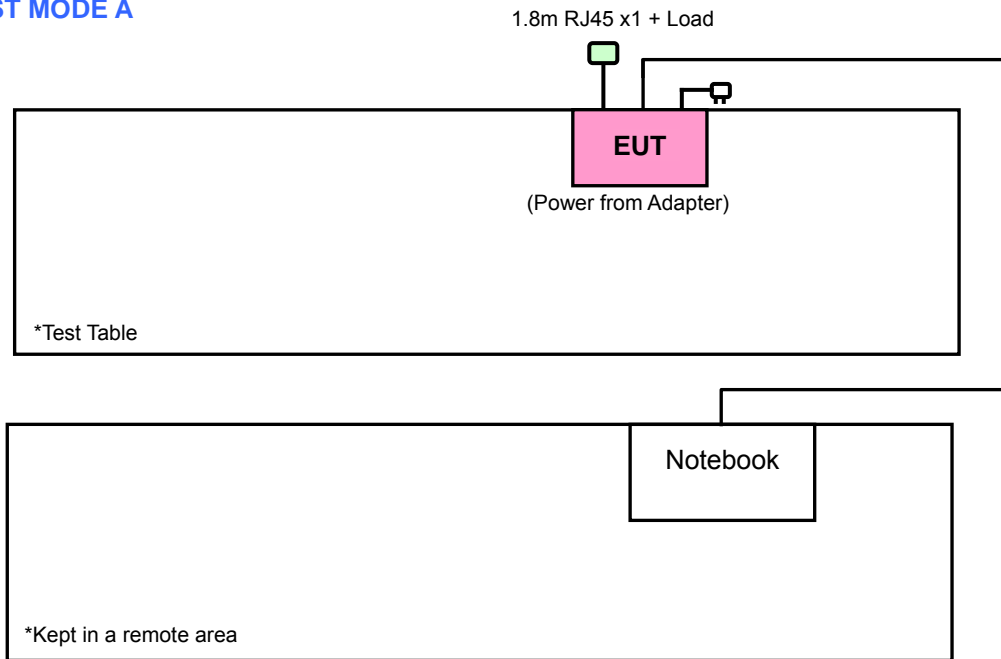

#### TEST MODE B

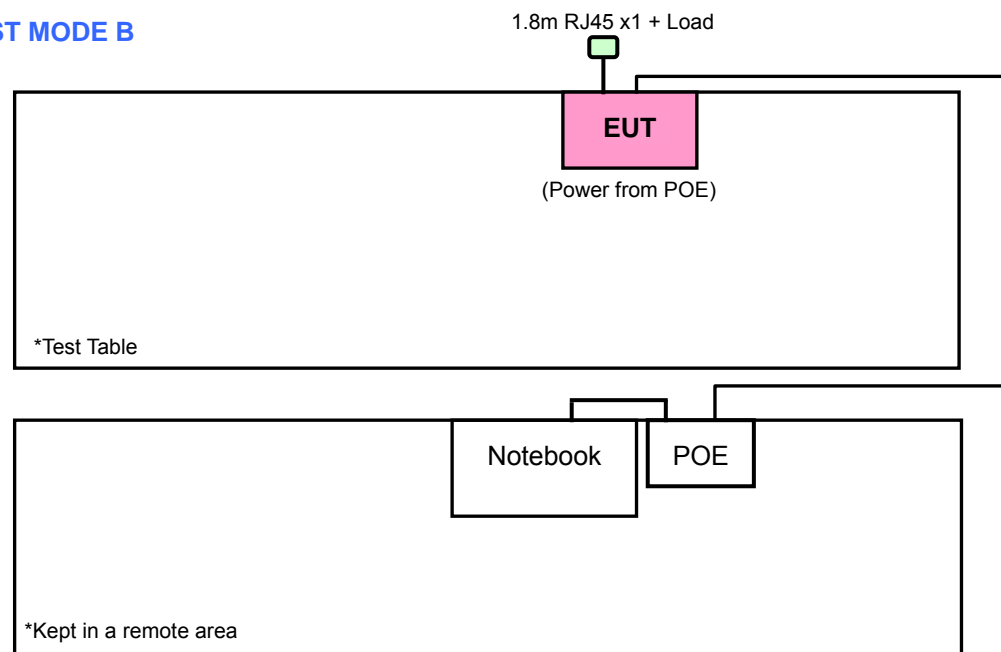

### 3.4 GENERAL DESCRIPTION OF APPLIED STANDARDS

The EUT is a RF Product. According to the specifications of the manufacturer, it must comply with the requirements of the following standards:

**FCC Part 15, Subpart C (15.247)**  
**558074 D01 DTS Meas Guidance v01**  
ANSI C63.10-2009

All test items have been performed and recorded as per the above standards.

**NOTE:** The EUT is also considered as a kind of computer peripheral, because the connection to computer is necessary for typical use. It has been verified to comply with the requirements of FCC Part 15, Subpart B, Class B (DoC). The test report has been issued separately.

## 4. TEST TYPES AND RESULTS

### 4.1 RADIATED EMISSION AND BANDEDGE MEASUREMENT

#### 4.1.1 LIMITS OF RADIATED EMISSION AND BANDEDGE MEASUREMENT

Radiated emissions which fall in the restricted bands must comply with the radiated emission limits specified as below table. Other emissions shall be at least 20dB below the highest level of the desired power:

FREQUENCIES (MHz)	FIELD STRENGTH (microvolts/meter)	MEASUREMENT DISTANCE (meters)
0.009 ~ 0.490	2400/F(kHz)	300
0.490 ~ 1.705	24000/F(kHz)	30
1.705 ~ 30.0	30	30
30 ~ 88	100	3
88 ~ 216	150	3
216 ~ 960	200	3
Above 960	500	3

**NOTE:**

1. The lower limit shall apply at the transition frequencies.
2. Emission level (dBuV/m) = 20 log Emission level (uV/m).
3. For frequencies above 1000MHz, the field strength limits are based on average detector, however, the peak field strength of any emission shall not exceed the maximum permitted average limits, specified above by more than 20dB under any condition of modulation.

#### 4.1.2 TEST INSTRUMENTS

DESCRIPTION & MANUFACTURER	MODEL NO.	SERIAL NO.	DATE OF CALIBRATION	DUE DATE OF CALIBRATION
Test Receiver ROHDE & SCHWARZ	ESIB7	100212	Aug. 06, 2012	Aug. 05, 2013
Spectrum Analyzer ROHDE & SCHWARZ	FSP40	100039	Feb. 03, 2012	Feb. 02, 2013
BILOG Antenna SCHWARZBECK	VULB9168	9168-160	Apr. 06, 2012	Apr. 05, 2013
HORN Antenna SCHWARZBECK	9120D	209	Aug. 25, 2011	Aug. 24, 2012
HORN Antenna SCHWARZBECK	BBHA 9170	148	Jul. 11, 2012	Jul. 10, 2013
Loop Antenna	HFH2-Z2	100070	Jan. 31, 2012	Jan. 30, 2014
Preamplifier Agilent	8447D	2944A10633	Oct. 29, 2011	Oct. 28, 2012
Preamplifier Agilent	8449B	3008A01964	Oct. 29, 2011	Oct. 28, 2012
RF signal cable HUBER+SUHNNER	SUCOFLEX 104	250723/4	Aug. 30, 2011	Aug. 29, 2012
RF signal cable HUBER+SUHNNER	SUCOFLEX 106	12738/6+309224/ 4	Aug. 30, 2011	Aug. 29, 2012
Software ADT.	ADT_Radiated_ V7.6.15.9.2	NA	NA	NA
Antenna Tower inn-co GmbH	MA 4000	013303	NA	NA
Antenna Tower Controller inn-co GmbH	CO2000	017303	NA	NA
Turn Table ADT.	TT100	TT93021703	NA	NA
Turn Table Controller ADT.	SC100	SC93021703	NA	NA
High Speed Peak Power Meter	ML2495A	0842014	Apr. 28, 2012	Apr. 27, 2013
Power Sensor	MA2411B	0738404	Apr. 28, 2012	Apr. 27, 2013

- NOTE:**
1. The calibration interval of the above test instruments is 12 months and the calibrations are traceable to NML/ROC and NIST/USA.
  2. The calibration interval of the loop antenna is 24 months and the calibrations are traceable to NML/ROC and NIST/USA.
  3. The test was performed in HwaYa Chamber 3.
  4. The horn antenna and HP preamplifier (model: 8449B) are used only for the measurement of emission frequency above 1GHz if tested.
  5. The FCC Site Registration No. is 988962.
  6. The IC Site Registration No. is IC 7450F-3.

#### 4.1.3 TEST PROCEDURES

- a. The EUT was placed on the top of a rotating table 0.8 meters above the ground at a 3 meters semi-anechoic chamber. The table was rotated 360 degrees to determine the position of the highest radiation.
- b. The EUT was set 3 meters away from the interference-receiving antenna, which was mounted on the top of a variable-height antenna tower.
- c. Height of receiving antenna is varied from one meter to four meters above the ground to determine the maximum value of the field strength. Both horizontal and vertical polarizations of the antenna are set to make the measurement.
- d. For each suspected emission, the EUT was arranged to its worst case and then the antenna was tuned to heights from 1 meter to 4 meters and the rotatable table was turned from 0 degrees to 360 degrees to find the maximum reading.
- e. The test-receiver system was set to Peak Detect Function and Specified Bandwidth with Maximum Hold Mode.
- f. If the emission level of the EUT in peak mode was lower than the limit specified, then testing could be stopped and the peak values of the EUT would be reported. Otherwise the emissions would be re-tested one by one using peak, quasi-peak or average method as specified and then reported in a data sheet.

**NOTE:**

1. The resolution bandwidth and video bandwidth of test receiver/spectrum analyzer is 120kHz for Quasi-peak detection at frequency below 1GHz.
2. The resolution bandwidth of test receiver/spectrum analyzer is 1MHz and video bandwidth is 3MHz for Peak detection at frequency above 1GHz.
3. The resolution bandwidth of test receiver/spectrum analyzer is 1MHz and the video bandwidth is 10Hz for Average detection (AV) at frequency above 1GHz.
4. All modes of operation were investigated and the worst-case emissions are reported.

#### 4.1.4 DEVIATION FROM TEST STANDARD

No deviation.



#### 4.1.5 TEST SETUP

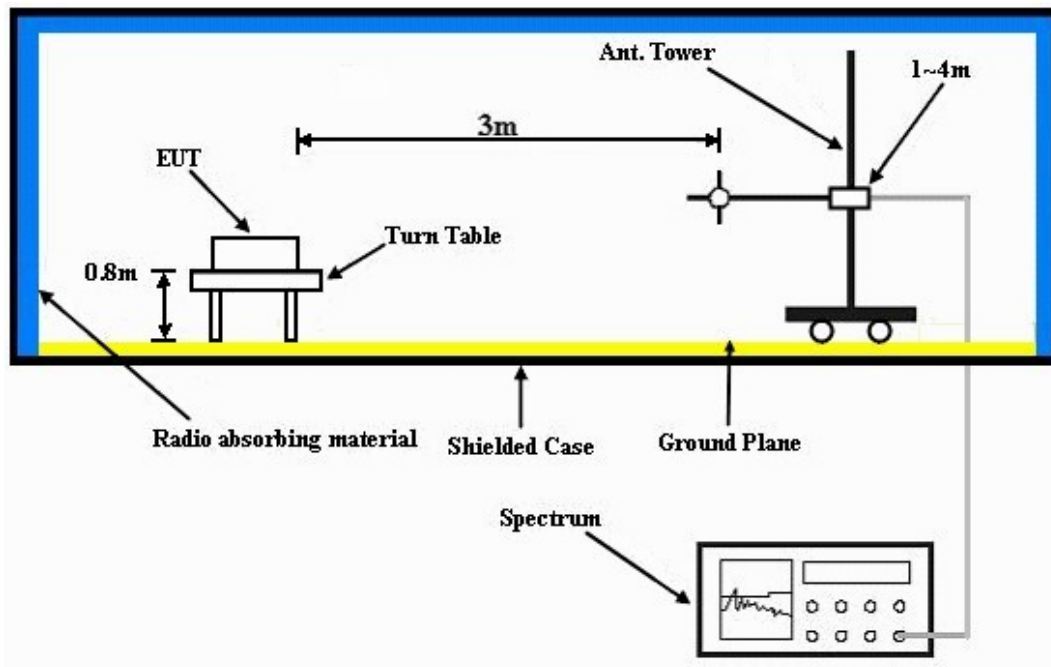

For the actual test configuration, please refer to the attached file (Test Setup Photo).

#### 4.1.6 EUT OPERATING CONDITIONS

- a. Placed the EUT on the testing table.
- b. Prepared notebooks to act as communication partner and placed it outside of testing area.
- c. The communication partner connected with EUT via a RJ45 cable and run a test program (provided by manufacturer) to enable EUT under transmission condition continuously at specific channel frequency.
- d. The communication partner sent data to EUT by command "PING".
- e. The necessary accessories enable the system in full functions.



A D T

#### 4.1.7 TEST RESULTS

##### ABOVE 1GHz WORST-CASE DATA : 802.11b

EUT TEST CONDITION		MEASUREMENT DETAIL	
CHANNEL	Channel 1	FREQUENCY RANGE	1 ~ 25GHz
INPUT POWER (SYSTEM)	120Vac, 60 Hz	DETECTOR FUNCTION	Peak (PK) Average (AV)
ENVIRONMENTAL CONDITIONS	25deg. C, 65%RH	TESTED BY	Chirs Lin

##### ANTENNA POLARITY & TEST DISTANCE: HORIZONTAL AT 3 M

NO.	FREQ. (MHz)	EMISSION LEVEL (dBuV/m)	LIMIT (dBuV/m)	MARGIN (dB)	ANTENNA HEIGHT (m)	TABLE ANGLE (Degree)	RAW VALUE (dBuV)	CORRECTION FACTOR (dB/m)
1	2390.00	54.8 PK	74.0	-19.2	1.00 H	124	23.50	31.30
2	2390.00	43.1 AV	54.0	-10.9	1.00 H	124	11.80	31.30
3	*2412.00	103.4 PK			1.07 H	143	72.00	31.40
4	*2412.00	99.3 AV			1.07 H	143	67.90	31.40
5	4824.00	47.0 PK	74.0	-27.0	1.00 H	72	9.80	37.20
6	4824.00	38.6 AV	54.0	-15.4	1.00 H	72	1.40	37.20

##### ANTENNA POLARITY & TEST DISTANCE: VERTICAL AT 3 M

NO.	FREQ. (MHz)	EMISSION LEVEL (dBuV/m)	LIMIT (dBuV/m)	MARGIN (dB)	ANTENNA HEIGHT (m)	TABLE ANGLE (Degree)	RAW VALUE (dBuV)	CORRECTION FACTOR (dB/m)
1	2390.00	60.2 PK	74.0	-13.8	1.00 V	262	28.90	31.30
2	2390.00	48.4 AV	54.0	-5.6	1.00 V	262	17.10	31.30
3	*2412.00	108.2 PK			1.24 V	340	76.80	31.40
4	*2412.00	103.7 AV			1.24 V	340	72.30	31.40
5	4824.00	47.9 PK	74.0	-26.1	1.11 V	360	10.70	37.20
6	4824.00	39.6 AV	54.0	-14.4	1.11 V	360	2.40	37.20

#### REMARKS:

1. Emission level (dBuV/m) = Raw Value (dBuV) + Correction Factor (dB/m).
2. Correction Factor (dB/m) = Antenna Factor (dB/m) + Cable Factor (dB).
3. The other emission levels were very low against the limit.
4. Margin value = Emission level – Limit value.
5. “ \* “: Fundamental frequency.



A D T

EUT TEST CONDITION		MEASUREMENT DETAIL	
CHANNEL	Channel 6	FREQUENCY RANGE	1 ~ 25GHz
INPUT POWER (SYSTEM)	120Vac, 60 Hz	DETECTOR FUNCTION	Peak (PK) Average (AV)
ENVIRONMENTAL CONDITIONS	25deg. C, 65%RH	TESTED BY	Chirs Lin

ANTENNA POLARITY & TEST DISTANCE: HORIZONTAL AT 3 M								
NO.	FREQ. (MHz)	EMISSION LEVEL (dBuV/m)	LIMIT (dBuV/m)	MARGIN (dB)	ANTENNA HEIGHT (m)	TABLE ANGLE (Degree)	RAW VALUE (dBuV)	CORRECTION FACTOR (dB/m)
1	*2437.00	103.4 PK			1.06 H	203	71.90	31.50
2	*2437.00	99.2 AV			1.06 H	203	67.70	31.50
3	4874.00	47.1 PK	74.0	-26.9	1.30 H	73	9.80	37.30
4	4874.00	38.6 AV	54.0	-15.4	1.30 H	73	1.30	37.30
5	7311.00	51.0 PK	74.0	-23.0	1.10 H	123	7.50	43.50
6	7311.00	38.1 AV	54.0	-15.9	1.10 H	123	-5.40	43.50
ANTENNA POLARITY & TEST DISTANCE: VERTICAL AT 3 M								
NO.	FREQ. (MHz)	EMISSION LEVEL (dBuV/m)	LIMIT (dBuV/m)	MARGIN (dB)	ANTENNA HEIGHT (m)	TABLE ANGLE (Degree)	RAW VALUE (dBuV)	CORRECTION FACTOR (dB/m)
1	*2437.00	108.0 PK			1.00 V	162	76.50	31.50
2	*2437.00	103.8 AV			1.00 V	162	72.30	31.50
3	4874.00	47.7 PK	74.0	-26.3	1.00 V	348	10.40	37.30
4	4874.00	39.6 AV	54.0	-14.4	1.00 V	348	2.30	37.30
5	7311.00	51.7 PK	74.0	-22.3	1.10 V	114	8.20	43.50
6	7311.00	38.4 AV	54.0	-15.6	1.10 V	114	-5.10	43.50

**REMARKS:**

1. Emission level (dBuV/m) = Raw Value (dBuV) + Correction Factor (dB/m).
2. Correction Factor (dB/m) = Antenna Factor (dB/m) + Cable Factor (dB).
3. The other emission levels were very low against the limit.
4. Margin value = Emission level – Limit value.
5. “ \* “: Fundamental frequency.



A D T

EUT TEST CONDITION		MEASUREMENT DETAIL	
CHANNEL	Channel 11	FREQUENCY RANGE	1 ~ 25GHz
INPUT POWER (SYSTEM)	120Vac, 60 Hz	DETECTOR FUNCTION	Peak (PK) Average (AV)
ENVIRONMENTAL CONDITIONS	25deg. C, 65%RH	TESTED BY	Chirs Lin

ANTENNA POLARITY & TEST DISTANCE: HORIZONTAL AT 3 M								
NO.	FREQ. (MHz)	EMISSION LEVEL (dBuV/m)	LIMIT (dBuV/m)	MARGIN (dB)	ANTENNA HEIGHT (m)	TABLE ANGLE (Degree)	RAW VALUE (dBuV)	CORRECTION FACTOR (dB/m)
1	*2462.00	103.6 PK			1.00 H	202	72.00	31.60
2	*2462.00	99.5 AV			1.00 H	202	67.90	31.60
3	2483.50	55.5 PK	74.0	-18.5	1.10 H	136	23.90	31.60
4	2483.50	45.4 AV	54.0	-8.6	1.10 H	136	13.80	31.60
5	4924.00	47.7 PK	74.0	-26.3	1.00 H	114	10.30	37.40
6	4924.00	36.3 AV	54.0	-17.7	1.00 H	114	-1.10	37.40
ANTENNA POLARITY & TEST DISTANCE: VERTICAL AT 3 M								
NO.	FREQ. (MHz)	EMISSION LEVEL (dBuV/m)	LIMIT (dBuV/m)	MARGIN (dB)	ANTENNA HEIGHT (m)	TABLE ANGLE (Degree)	RAW VALUE (dBuV)	CORRECTION FACTOR (dB/m)
1	*2462.00	107.7 PK			1.00 V	360	76.10	31.60
2	*2462.00	103.6 AV			1.00 V	360	72.00	31.60
3	2483.50	56.8 PK	74.0	-17.2	1.47 V	320	25.20	31.60
4	2483.50	44.9 AV	54.0	-9.1	1.47 V	320	13.30	31.60
5	4924.00	48.2 PK	74.0	-25.8	1.00 V	345	10.80	37.40
6	4924.00	38.6 AV	54.0	-15.4	1.00 V	345	1.20	37.40

**REMARKS:**

1. Emission level (dBuV/m) = Raw Value (dBuV) + Correction Factor (dB/m).
2. Correction Factor (dB/m) = Antenna Factor (dB/m) + Cable Factor (dB).
3. The other emission levels were very low against the limit.
4. Margin value = Emission level – Limit value.
5. “ \* “: Fundamental frequency.



802.11g

EUT TEST CONDITION		MEASUREMENT DETAIL	
CHANNEL	Channel 1	FREQUENCY RANGE	1 ~ 25GHz
INPUT POWER (SYSTEM)	120Vac, 60 Hz	DETECTOR FUNCTION	Peak (PK) Average (AV)
ENVIRONMENTAL CONDITIONS	25deg. C, 65%RH	TESTED BY	Chirs Lin

**ANTENNA POLARITY & TEST DISTANCE: HORIZONTAL AT 3 M**

NO.	FREQ. (MHz)	EMISSION LEVEL (dBuV/m)	LIMIT (dBuV/m)	MARGIN (dB)	ANTENNA HEIGHT (m)	TABLE ANGLE (Degree)	RAW VALUE (dBuV)	CORRECTION FACTOR (dB/m)
1	2390.00	59.5 PK	74.0	-14.5	1.12 H	218	28.20	31.30
2	2390.00	48.0 AV	54.0	-6.0	1.12 H	218	16.70	31.30
3	*2412.00	105.5 PK			1.12 H	158	74.10	31.40
4	*2412.00	95.5 AV			1.12 H	158	64.10	31.40
5	4824.00	46.6 PK	74.0	-27.4	1.03 H	124	9.40	37.20
6	4824.00	33.1 AV	54.0	-20.9	1.03 H	124	-4.10	37.20

**ANTENNA POLARITY & TEST DISTANCE: VERTICAL AT 3 M**

NO.	FREQ. (MHz)	EMISSION LEVEL (dBuV/m)	LIMIT (dBuV/m)	MARGIN (dB)	ANTENNA HEIGHT (m)	TABLE ANGLE (Degree)	RAW VALUE (dBuV)	CORRECTION FACTOR (dB/m)
1	2390.00	67.3 PK	74.0	-6.7	1.26 V	360	36.00	31.30
2	<b>2390.00</b>	<b>52.8 AV</b>	<b>54.0</b>	<b>-1.2</b>	<b>1.26 V</b>	<b>360</b>	<b>21.50</b>	<b>31.30</b>
3	*2412.00	108.4 PK			1.00 V	16	77.00	31.40
4	*2412.00	98.2 AV			1.00 V	16	66.80	31.40
5	4824.00	49.7 PK	74.0	-24.3	1.10 V	126	12.50	37.20
6	4824.00	37.2 AV	54.0	-16.8	1.10 V	126	0.00	37.20

**REMARKS:**

1. Emission level (dBuV/m) = Raw Value (dBuV) + Correction Factor (dB/m).
2. Correction Factor (dB/m) = Antenna Factor (dB/m) + Cable Factor (dB).
3. The other emission levels were very low against the limit.
4. Margin value = Emission level – Limit value.
5. “ \* “: Fundamental frequency.



A D T

EUT TEST CONDITION		MEASUREMENT DETAIL	
CHANNEL	Channel 6	FREQUENCY RANGE	1 ~ 25GHz
INPUT POWER (SYSTEM)	120Vac, 60 Hz	DETECTOR FUNCTION	Peak (PK) Average (AV)
ENVIRONMENTAL CONDITIONS	25deg. C, 65%RH	TESTED BY	Chirs Lin

ANTENNA POLARITY & TEST DISTANCE: HORIZONTAL AT 3 M								
NO.	FREQ. (MHz)	EMISSION LEVEL (dBuV/m)	LIMIT (dBuV/m)	MARGIN (dB)	ANTENNA HEIGHT (m)	TABLE ANGLE (Degree)	RAW VALUE (dBuV)	CORRECTION FACTOR (dB/m)
1	*2437.00	105.0 PK			1.08 H	159	73.50	31.50
2	*2437.00	96.2 AV			1.08 H	159	64.70	31.50
3	4874.00	45.2 PK	74.0	-28.8	1.10 H	147	7.90	37.30
4	4874.00	33.2 AV	54.0	-20.8	1.10 H	147	-4.10	37.30
5	7311.00	51.3 PK	74.0	-22.7	1.02 H	136	7.80	43.50
6	7311.00	40.2 AV	54.0	-13.8	1.02 H	136	-3.30	43.50
ANTENNA POLARITY & TEST DISTANCE: VERTICAL AT 3 M								
NO.	FREQ. (MHz)	EMISSION LEVEL (dBuV/m)	LIMIT (dBuV/m)	MARGIN (dB)	ANTENNA HEIGHT (m)	TABLE ANGLE (Degree)	RAW VALUE (dBuV)	CORRECTION FACTOR (dB/m)
1	*2437.00	109.4 PK			1.20 V	322	77.90	31.50
2	*2437.00	99.5 AV			1.20 V	322	68.00	31.50
3	4874.00	44.1 PK	74.0	-29.9	1.10 V	123	6.80	37.30
4	4874.00	32.2 AV	54.0	-21.8	1.10 V	123	-5.10	37.30
5	7311.00	52.2 PK	74.0	-21.8	1.10 V	125	8.70	43.50
6	7311.00	40.3 AV	54.0	-13.7	1.10 V	125	-3.20	43.50

**REMARKS:**

1. Emission level (dBuV/m) = Raw Value (dBuV) + Correction Factor (dB/m).
2. Correction Factor (dB/m) = Antenna Factor (dB/m) + Cable Factor (dB).
3. The other emission levels were very low against the limit.
4. Margin value = Emission level – Limit value.
5. “ \* “: Fundamental frequency.



A D T

EUT TEST CONDITION		MEASUREMENT DETAIL	
CHANNEL	Channel 11	FREQUENCY RANGE	1 ~ 25GHz
INPUT POWER (SYSTEM)	120Vac, 60 Hz	DETECTOR FUNCTION	Peak (PK) Average (AV)
ENVIRONMENTAL CONDITIONS	25deg. C, 65%RH	TESTED BY	Chirs Lin

**ANTENNA POLARITY & TEST DISTANCE: HORIZONTAL AT 3 M**

NO.	FREQ. (MHz)	EMISSION LEVEL (dBuV/m)	LIMIT (dBuV/m)	MARGIN (dB)	ANTENNA HEIGHT (m)	TABLE ANGLE (Degree)	RAW VALUE (dBuV)	CORRECTION FACTOR (dB/m)
1	*2462.00	107.7 PK			1.33 H	48	76.10	31.60
2	*2462.00	97.3 AV			1.33 H	48	65.70	31.60
3	2483.50	64.6 PK	74.0	-9.4	1.56 H	57	33.00	31.60
4	2483.50	49.0 AV	54.0	-5.0	1.56 H	57	17.40	31.60
5	4924.00	46.6 PK	74.0	-27.4	1.02 H	132	9.20	37.40
6	4924.00	35.3 AV	54.0	-18.7	1.02 H	132	-2.10	37.40

**ANTENNA POLARITY & TEST DISTANCE: VERTICAL AT 3 M**

NO.	FREQ. (MHz)	EMISSION LEVEL (dBuV/m)	LIMIT (dBuV/m)	MARGIN (dB)	ANTENNA HEIGHT (m)	TABLE ANGLE (Degree)	RAW VALUE (dBuV)	CORRECTION FACTOR (dB/m)
1	*2462.00	108.1 PK			1.19 V	360	76.50	31.60
2	*2462.00	99.0 AV			1.19 V	360	67.40	31.60
3	2483.50	65.3 PK	74.0	-8.7	1.18 V	338	33.70	31.60
4	2483.50	48.9 AV	54.0	-5.1	1.18 V	338	17.30	31.60
5	4924.00	46.6 PK	74.0	-27.4	1.11 V	123	9.20	37.40
6	4924.00	34.3 AV	54.0	-19.7	1.11 V	123	-3.10	37.40

**REMARKS:**

1. Emission level (dBuV/m) = Raw Value (dBuV) + Correction Factor (dB/m).
2. Correction Factor (dB/m) = Antenna Factor (dB/m) + Cable Factor (dB).
3. The other emission levels were very low against the limit.
4. Margin value = Emission level – Limit value.
5. “ \* “: Fundamental frequency.



802.11n (20MHz)

EUT TEST CONDITION		MEASUREMENT DETAIL	
CHANNEL	Channel 1	FREQUENCY RANGE	1 ~ 25GHz
INPUT POWER (SYSTEM)	120Vac, 60 Hz	DETECTOR FUNCTION	Peak (PK) Average (AV)
ENVIRONMENTAL CONDITIONS	25deg. C, 65%RH	TESTED BY	Chirs Lin

ANTENNA POLARITY & TEST DISTANCE: HORIZONTAL AT 3 M

NO.	FREQ. (MHz)	EMISSION LEVEL (dBuV/m)	LIMIT (dBuV/m)	MARGIN (dB)	ANTENNA HEIGHT (m)	TABLE ANGLE (Degree)	RAW VALUE (dBuV)	CORRECTION FACTOR (dB/m)
1	2390.00	66.7 PK	74.0	-7.3	1.39 H	15	35.40	31.30
2	2390.00	51.2 AV	54.0	-2.8	1.39 H	15	19.90	31.30
3	*2412.00	106.0 PK			1.41 H	360	74.60	31.40
4	*2412.00	97.1 AV			1.41 H	360	65.70	31.40
5	4824.00	47.3 PK	74.0	-26.7	1.01 H	126	10.10	37.20
6	4824.00	33.1 AV	54.0	-20.9	1.01 H	126	-4.10	37.20

ANTENNA POLARITY & TEST DISTANCE: VERTICAL AT 3 M

NO.	FREQ. (MHz)	EMISSION LEVEL (dBuV/m)	LIMIT (dBuV/m)	MARGIN (dB)	ANTENNA HEIGHT (m)	TABLE ANGLE (Degree)	RAW VALUE (dBuV)	CORRECTION FACTOR (dB/m)
1	2390.00	68.4 PK	74.0	-5.6	1.00 V	36	37.10	31.30
2	2390.00	52.1 AV	54.0	-1.9	1.00 V	36	20.80	31.30
3	*2412.00	110.7 PK			1.26 V	350	79.30	31.40
4	*2412.00	101.3 AV			1.26 V	350	69.90	31.40
5	4824.00	48.1 PK	74.0	-25.9	1.10 V	125	10.90	37.20
6	4824.00	36.4 AV	54.0	-17.6	1.10 V	125	-0.80	37.20

REMARKS:

1. Emission level (dBuV/m) = Raw Value (dBuV) + Correction Factor (dB/m).
2. Correction Factor (dB/m) = Antenna Factor (dB/m) + Cable Factor (dB).
3. The other emission levels were very low against the limit.
4. Margin value = Emission level – Limit value.
5. “ \* “: Fundamental frequency.





A D T

EUT TEST CONDITION		MEASUREMENT DETAIL	
CHANNEL	Channel 6	FREQUENCY RANGE	1 ~ 25GHz
INPUT POWER (SYSTEM)	120Vac, 60 Hz	DETECTOR FUNCTION	Peak (PK) Average (AV)
ENVIRONMENTAL CONDITIONS	25deg. C, 65%RH	TESTED BY	Chirs Lin

ANTENNA POLARITY & TEST DISTANCE: HORIZONTAL AT 3 M								
NO.	FREQ. (MHz)	EMISSION LEVEL (dBuV/m)	LIMIT (dBuV/m)	MARGIN (dB)	ANTENNA HEIGHT (m)	TABLE ANGLE (Degree)	RAW VALUE (dBuV)	CORRECTION FACTOR (dB/m)
1	*2437.00	110.8 PK			1.34 H	26	79.30	31.50
2	*2437.00	101.5 AV			1.34 H	26	70.00	31.50
3	4874.00	46.6 PK	74.0	-27.4	1.01 H	125	9.30	37.30
4	4874.00	34.2 AV	54.0	-19.8	1.01 H	125	-3.10	37.30
5	7311.00	50.9 PK	74.0	-23.1	1.10 H	145	7.40	43.50
6	7311.00	38.4 AV	54.0	-15.6	1.10 H	145	-5.10	43.50
ANTENNA POLARITY & TEST DISTANCE: VERTICAL AT 3 M								
NO.	FREQ. (MHz)	EMISSION LEVEL (dBuV/m)	LIMIT (dBuV/m)	MARGIN (dB)	ANTENNA HEIGHT (m)	TABLE ANGLE (Degree)	RAW VALUE (dBuV)	CORRECTION FACTOR (dB/m)
1	*2437.00	114.3 PK			1.00 V	347	82.80	31.50
2	*2437.00	104.7 AV			1.00 V	347	73.20	31.50
3	4874.00	46.8 PK	74.0	-27.2	1.00 V	346	9.50	37.30
4	4874.00	34.2 AV	54.0	-19.8	1.00 V	346	-3.10	37.30
5	7311.00	51.7 PK	74.0	-22.3	1.10 V	124	8.20	43.50
6	7311.00	38.1 AV	54.0	-15.9	1.10 V	124	-5.40	43.50

**REMARKS:**

1. Emission level (dBuV/m) = Raw Value (dBuV) + Correction Factor (dB/m).
2. Correction Factor (dB/m) = Antenna Factor (dB/m) + Cable Factor (dB).
3. The other emission levels were very low against the limit.
4. Margin value = Emission level – Limit value.
5. “ \* “: Fundamental frequency.



A D T

EUT TEST CONDITION		MEASUREMENT DETAIL	
CHANNEL	Channel 11	FREQUENCY RANGE	1 ~ 25GHz
INPUT POWER (SYSTEM)	120Vac, 60 Hz	DETECTOR FUNCTION	Peak (PK) Average (AV)
ENVIRONMENTAL CONDITIONS	25deg. C, 65%RH	TESTED BY	Chirs Lin

ANTENNA POLARITY & TEST DISTANCE: HORIZONTAL AT 3 M								
NO.	FREQ. (MHz)	EMISSION LEVEL (dBuV/m)	LIMIT (dBuV/m)	MARGIN (dB)	ANTENNA HEIGHT (m)	TABLE ANGLE (Degree)	RAW VALUE (dBuV)	CORRECTION FACTOR (dB/m)
1	*2462.00	109.7 PK			1.31 H	48	78.10	31.60
2	*2462.00	100.1 AV			1.31 H	48	68.50	31.60
3	2483.50	65.1 PK	74.0	-8.9	1.25 H	45	33.50	31.60
4	2483.50	52.5 AV	54.0	-1.5	1.25 H	45	20.90	31.60
5	4924.00	46.0 PK	74.0	-28.0	1.01 H	123	8.60	37.40
6	4924.00	33.2 AV	54.0	-20.8	1.01 H	123	-4.20	37.40
ANTENNA POLARITY & TEST DISTANCE: VERTICAL AT 3 M								
NO.	FREQ. (MHz)	EMISSION LEVEL (dBuV/m)	LIMIT (dBuV/m)	MARGIN (dB)	ANTENNA HEIGHT (m)	TABLE ANGLE (Degree)	RAW VALUE (dBuV)	CORRECTION FACTOR (dB/m)
1	*2462.00	112.3 PK			1.00 V	53	80.70	31.60
2	*2462.00	101.9 AV			1.00 V	53	70.30	31.60
3	2483.50	66.9 PK	74.0	-7.1	1.65 V	25	35.30	31.60
4	2483.50	52.5 AV	54.0	-1.5	1.65 V	25	20.90	31.60
5	4924.00	45.3 PK	74.0	-28.7	1.10 V	125	7.90	37.40
6	4924.00	34.1 AV	54.0	-19.9	1.10 V	125	-3.30	37.40

**REMARKS:**

1. Emission level (dBuV/m) = Raw Value (dBuV) + Correction Factor (dB/m).
2. Correction Factor (dB/m) = Antenna Factor (dB/m) + Cable Factor (dB).
3. The other emission levels were very low against the limit.
4. Margin value = Emission level – Limit value.
5. “ \* “: Fundamental frequency.



A D T

802.11n (40MHz)

EUT TEST CONDITION		MEASUREMENT DETAIL	
CHANNEL	Channel 3	FREQUENCY RANGE	1 ~ 25GHz
INPUT POWER (SYSTEM)	120Vac, 60 Hz	DETECTOR FUNCTION	Peak (PK) Average (AV)
ENVIRONMENTAL CONDITIONS	25deg. C, 65%RH	TESTED BY	Chirs Lin

ANTENNA POLARITY & TEST DISTANCE: HORIZONTAL AT 3 M

NO.	FREQ. (MHz)	EMISSION LEVEL (dBuV/m)	LIMIT (dBuV/m)	MARGIN (dB)	ANTENNA HEIGHT (m)	TABLE ANGLE (Degree)	RAW VALUE (dBuV)	CORRECTION FACTOR (dB/m)
1	2390.00	65.9 PK	74.0	-8.1	1.39 H	53	34.60	31.30
2	2390.00	52.7 AV	54.0	-1.3	1.39 H	53	21.40	31.30
3	*2422.00	103.6 PK			1.36 H	25	72.20	31.40
4	*2422.00	94.0 AV			1.36 H	25	62.60	31.40
5	4844.00	46.0 PK	74.0	-28.0	1.05 H	123	8.70	37.30
6	4844.00	34.1 AV	54.0	-19.9	1.05 H	123	-3.20	37.30

ANTENNA POLARITY & TEST DISTANCE: VERTICAL AT 3 M

NO.	FREQ. (MHz)	EMISSION LEVEL (dBuV/m)	LIMIT (dBuV/m)	MARGIN (dB)	ANTENNA HEIGHT (m)	TABLE ANGLE (Degree)	RAW VALUE (dBuV)	CORRECTION FACTOR (dB/m)
1	2390.00	68.4 PK	74.0	-5.6	1.27 V	360	37.10	31.30
2	2390.00	52.3 AV	54.0	-1.7	1.27 V	360	21.00	31.30
3	*2422.00	107.0 PK			1.00 V	349	75.60	31.40
4	*2422.00	97.6 AV			1.00 V	349	66.20	31.40
5	4844.00	46.1 PK	74.0	-27.9	1.01 V	124	8.80	37.30
6	4844.00	34.0 AV	54.0	-20.0	1.01 V	124	-3.30	37.30

REMARKS:

1. Emission level (dBuV/m) = Raw Value (dBuV) + Correction Factor (dB/m).
2. Correction Factor (dB/m) = Antenna Factor (dB/m) + Cable Factor (dB).
3. The other emission levels were very low against the limit.
4. Margin value = Emission level – Limit value.
5. “ \* “: Fundamental frequency.



A D T

EUT TEST CONDITION		MEASUREMENT DETAIL	
CHANNEL	Channel 6	FREQUENCY RANGE	1 ~ 25GHz
INPUT POWER (SYSTEM)	120Vac, 60 Hz	DETECTOR FUNCTION	Peak (PK) Average (AV)
ENVIRONMENTAL CONDITIONS	25deg. C, 65%RH	TESTED BY	Chirs Lin

ANTENNA POLARITY & TEST DISTANCE: HORIZONTAL AT 3 M								
NO.	FREQ. (MHz)	EMISSION LEVEL (dBuV/m)	LIMIT (dBuV/m)	MARGIN (dB)	ANTENNA HEIGHT (m)	TABLE ANGLE (Degree)	RAW VALUE (dBuV)	CORRECTION FACTOR (dB/m)
1	*2437.00	104.4 PK			1.00 H	28	72.90	31.50
2	*2437.00	94.4 AV			1.00 H	28	62.90	31.50
3	4874.00	45.8 PK	74.0	-28.2	1.06 H	125	8.50	37.30
4	4874.00	34.1 AV	54.0	-19.9	1.06 H	125	-3.20	37.30
5	7311.00	50.3 PK	74.0	-23.7	1.01 H	124	6.80	43.50
6	7311.00	39.3 AV	54.0	-14.7	1.01 H	124	-4.20	43.50
ANTENNA POLARITY & TEST DISTANCE: VERTICAL AT 3 M								
NO.	FREQ. (MHz)	EMISSION LEVEL (dBuV/m)	LIMIT (dBuV/m)	MARGIN (dB)	ANTENNA HEIGHT (m)	TABLE ANGLE (Degree)	RAW VALUE (dBuV)	CORRECTION FACTOR (dB/m)
1	*2437.00	110.7 PK			1.26 V	12	79.20	31.50
2	*2437.00	101.1 AV			1.26 V	12	69.60	31.50
3	4874.00	46.3 PK	74.0	-27.7	1.10 V	142	9.00	37.30
4	4874.00	34.9 AV	54.0	-19.1	1.10 V	142	-2.40	37.30
5	7311.00	51.3 PK	74.0	-22.7	1.01 V	123	7.80	43.50
6	7311.00	40.3 AV	54.0	-13.7	1.01 V	123	-3.20	43.50

**REMARKS:**

1. Emission level (dBuV/m) = Raw Value (dBuV) + Correction Factor (dB/m).
2. Correction Factor (dB/m) = Antenna Factor (dB/m) + Cable Factor (dB).
3. The other emission levels were very low against the limit.
4. Margin value = Emission level – Limit value.
5. “ \* “: Fundamental frequency.



A D T

EUT TEST CONDITION		MEASUREMENT DETAIL	
CHANNEL	Channel 9	FREQUENCY RANGE	1 ~ 25GHz
INPUT POWER (SYSTEM)	120Vac, 60 Hz	DETECTOR FUNCTION	Peak (PK) Average (AV)
ENVIRONMENTAL CONDITIONS	25deg. C, 65%RH	TESTED BY	Chirs Lin

ANTENNA POLARITY & TEST DISTANCE: HORIZONTAL AT 3 M								
NO.	FREQ. (MHz)	EMISSION LEVEL (dBuV/m)	LIMIT (dBuV/m)	MARGIN (dB)	ANTENNA HEIGHT (m)	TABLE ANGLE (Degree)	RAW VALUE (dBuV)	CORRECTION FACTOR (dB/m)
1	*2452.00	102.9 PK			1.08 H	360	71.40	31.50
2	*2452.00	93.8 AV			1.08 H	360	62.30	31.50
3	2483.50	65.6 PK	74.0	-8.4	1.01 H	360	34.00	31.60
4	2483.50	51.4 AV	54.0	-2.6	1.01 H	360	19.80	31.60
5	4904.00	45.7 PK	74.0	-28.3	1.10 H	125	8.30	37.40
6	4904.00	35.3 AV	54.0	-18.7	1.10 H	125	-2.10	37.40
ANTENNA POLARITY & TEST DISTANCE: VERTICAL AT 3 M								
NO.	FREQ. (MHz)	EMISSION LEVEL (dBuV/m)	LIMIT (dBuV/m)	MARGIN (dB)	ANTENNA HEIGHT (m)	TABLE ANGLE (Degree)	RAW VALUE (dBuV)	CORRECTION FACTOR (dB/m)
1	*2452.00	107.1 PK			1.29 V	360	75.60	31.50
2	*2452.00	97.5 AV			1.29 V	360	66.00	31.50
3	2483.50	69.7 PK	74.0	-4.3	1.21 V	338	38.10	31.60
4	2483.50	52.3 AV	54.0	-1.7	1.21 V	338	20.70	31.60
5	4904.00	45.6 PK	74.0	-28.4	1.01 V	136	8.20	37.40
6	4904.00	35.3 AV	54.0	-18.7	1.01 V	136	-2.10	37.40

**REMARKS:**

1. Emission level (dBuV/m) = Raw Value (dBuV) + Correction Factor (dB/m).
2. Correction Factor (dB/m) = Antenna Factor (dB/m) + Cable Factor (dB).
3. The other emission levels were very low against the limit.
4. Margin value = Emission level – Limit value.
5. “ \* “: Fundamental frequency.



A D T

**BELOW 1GHz WORST-CASE DATA : 802.11n (40MHz)**

EUT TEST CONDITION		MEASUREMENT DETAIL	
CHANNEL	Channel 6	FREQUENCY RANGE	Below 1000MHz
INPUT POWER (SYSTEM)	120Vac, 60 Hz	DETECTOR FUNCTION	Quasi-Peak
ENVIRONMENTAL CONDITIONS	25deg. C, 65%RH	TEST MODE	A
TESTED BY	Haru Yang		

ANTENNA POLARITY & TEST DISTANCE: HORIZONTAL AT 3 M								
NO.	FREQ. (MHz)	EMISSION LEVEL (dBuV/m)	LIMIT (dBuV/m)	MARGIN (dB)	ANTENNA HEIGHT (m)	TABLE ANGLE (Degree)	RAW VALUE (dBuV)	CORRECTION FACTOR (dB/m)
1	105.73	28.9 QP	43.5	-14.6	2.00 H	95	18.80	10.10
2	193.22	33.0 QP	43.5	-10.5	1.50 H	287	21.50	11.50
3	249.60	29.1 QP	46.0	-16.9	1.00 H	82	16.10	13.00
4	374.04	28.2 QP	46.0	-17.8	1.00 H	255	11.30	16.90
5	624.85	27.4 QP	46.0	-18.6	1.25 H	206	5.10	22.30
6	751.23	28.3 QP	46.0	-17.7	2.00 H	136	3.90	24.40
ANTENNA POLARITY & TEST DISTANCE: VERTICAL AT 3 M								
NO.	FREQ. (MHz)	EMISSION LEVEL (dBuV/m)	LIMIT (dBuV/m)	MARGIN (dB)	ANTENNA HEIGHT (m)	TABLE ANGLE (Degree)	RAW VALUE (dBuV)	CORRECTION FACTOR (dB/m)
1	35.24	34.5 QP	40.0	-5.5	1.83 V	204	21.60	12.90
2	105.73	37.1 QP	43.5	-6.4	1.00 V	65	27.00	10.10
3	193.22	29.8 QP	43.5	-13.7	1.00 V	147	18.30	11.50
4	294.32	26.0 QP	46.0	-20.0	1.24 V	15	11.30	14.70
5	374.04	26.5 QP	46.0	-19.5	1.24 V	211	9.60	16.90
6	434.31	28.3 QP	46.0	-17.7	1.24 V	319	9.90	18.40

**REMARKS:**

1. Emission level (dBuV/m) = Raw Value (dBuV) + Correction Factor (dB/m).
2. Correction Factor (dB/m) = Antenna Factor (dB/m) + Cable Factor (dB).
3. The other emission levels were very low against the limit.
4. Margin value = Emission level – Limit value.



A D T

EUT TEST CONDITION		MEASUREMENT DETAIL	
CHANNEL	Channel 6	FREQUENCY RANGE	Below 1000MHz
INPUT POWER (SYSTEM)	120Vac, 60 Hz	DETECTOR FUNCTION	Quasi-Peak
ENVIRONMENTAL CONDITIONS	25deg. C, 65%RH	TEST MODE	B
TESTED BY	Chirs Lin		

ANTENNA POLARITY & TEST DISTANCE: HORIZONTAL AT 3 M								
NO.	FREQ. (MHz)	EMISSION LEVEL (dBuV/m)	LIMIT (dBuV/m)	MARGIN (dB)	ANTENNA HEIGHT (m)	TABLE ANGLE (Degree)	RAW VALUE (dBuV)	CORRECTION FACTOR (dB/m)
1	148.50	24.4 QP	43.5	-19.1	1.24 H	88	10.30	14.10
2	249.60	20.0 QP	46.0	-26.0	1.00 H	91	7.00	13.00
3	374.04	26.0 QP	46.0	-20.0	1.24 H	114	9.10	16.90
4	500.42	20.5 QP	46.0	-25.5	1.50 H	114	0.50	20.00
5	751.23	25.8 QP	46.0	-20.2	1.00 H	130	1.40	24.40
6	875.67	26.7 QP	46.0	-19.3	1.50 H	196	0.20	26.50
ANTENNA POLARITY & TEST DISTANCE: VERTICAL AT 3 M								
NO.	FREQ. (MHz)	EMISSION LEVEL (dBuV/m)	LIMIT (dBuV/m)	MARGIN (dB)	ANTENNA HEIGHT (m)	TABLE ANGLE (Degree)	RAW VALUE (dBuV)	CORRECTION FACTOR (dB/m)
1	47.40	28.6 QP	40.0	-11.4	1.24 V	3	14.60	14.00
2	142.67	22.8 QP	43.5	-20.7	1.24 V	5	9.10	13.70
3	374.04	20.7 QP	46.0	-25.3	1.50 V	4	3.80	16.90
4	593.74	21.2 QP	46.0	-24.8	1.50 V	281	-0.80	22.00
5	751.23	24.8 QP	46.0	-21.2	1.00 V	160	0.40	24.40
6	875.67	26.1 QP	46.0	-19.9	2.00 V	172	-0.40	26.50

**REMARKS:**

1. Emission level (dBuV/m) = Raw Value (dBuV) + Correction Factor (dB/m).
2. Correction Factor (dB/m) = Antenna Factor (dB/m) + Cable Factor (dB).
3. The other emission levels were very low against the limit.
4. Margin value = Emission level – Limit value.

## 4.2 CONDUCTED EMISSION MEASUREMENT

### 4.2.1 LIMITS OF CONDUCTED EMISSION MEASUREMENT

FREQUENCY OF EMISSION (MHz)	CONDUCTED LIMIT (dB $\mu$ V)	
	Quasi-peak	Average
0.15 ~ 0.5	66 to 56	56 to 46
0.5 ~ 5	56	46
5 ~ 30	60	50

- NOTE:**
1. The lower limit shall apply at the transition frequencies.
  2. The limit decreases in line with the logarithm of the frequency in the range of 0.15 to 0.50MHz.
  3. All emanations from a class A/B digital device or system, including any network of conductors and apparatus connected thereto, shall not exceed the level of field strengths specified above.

### 4.2.2 TEST INSTRUMENTS

DESCRIPTION & MANUFACTURER	MODEL NO.	SERIAL NO.	DATE OF CALIBRATION	DUE DATE OF CALIBRATION
Test Receiver ROHDE & SCHWARZ	ESCS30	100289	Nov. 19, 2011	Nov. 18, 2012
RF signal cable Woken	5D-FB	Cable-HYCO2-01	Dec. 29, 2011	Dec. 28, 2012
LISN ROHDE & SCHWARZ (EUT)	ESH2-Z5	100100	Dec. 30, 2011	Dec. 29, 2012
LISN ROHDE & SCHWARZ (Peripheral)	ESH3-Z5	100311	Jul. 06, 2012	Jul. 05, 2013
Software ADT	BV ADT_Cond_ V7.3.7.3	NA	NA	NA

- NOTE:**
1. The calibration interval of the above test instruments is 12 months and the calibrations are traceable to NML/ROC and NIST/USA.
  2. The test was performed in HwaYa Shielded Room 2.
  3. The VCCI Site Registration No. is C-2047.



#### 4.2.3 TEST PROCEDURES

- a. The EUT was placed 0.4 meters from the conducting wall of the shielded room with EUT being connected to the power mains through a line impedance stabilization network (LISN). Other support units were connected to the power mains through another LISN. The two LISNs provide 50 ohm/ 50uH of coupling impedance for the measuring instrument.
- b. Both lines of the power mains connected to the EUT were checked for maximum conducted interference.
- c. The frequency range from 150kHz to 30MHz was searched. Emission levels under (Limit - 20dB) was not recorded.

**NOTE:** All modes of operation were investigated and the worst-case emissions are reported.

#### 4.2.4 DEVIATION FROM TEST STANDARD

No deviation.

#### 4.2.5 TEST SETUP

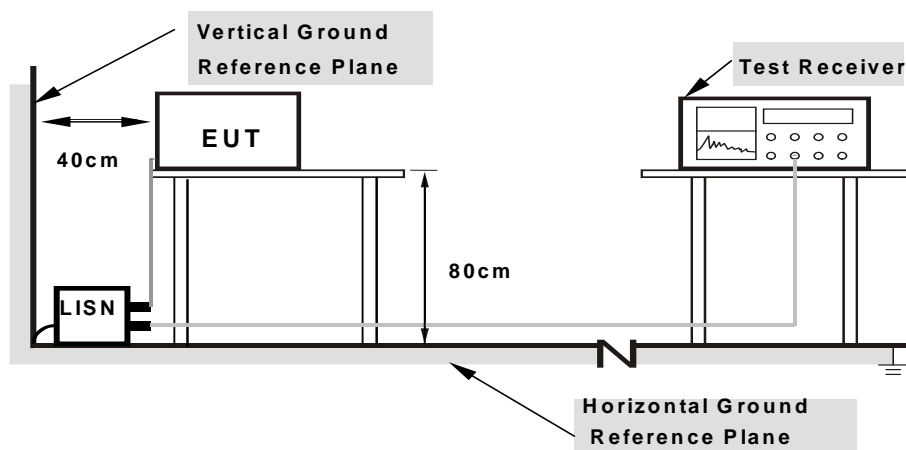

- Note:**
1. Support units were connected to second LISN.
  2. Both of LISNs (AMN) are 80 cm from EUT and at least 80 cm from other units and other metal planes

For the actual test configuration, please refer to the attached file (Test Setup Photo).

#### 4.2.6 EUT OPERATING CONDITIONS

Same as 4.1.6.

## 4.2.7 TEST RESULTS

### CONDUCTED WORST-CASE DATA : 802.11n (40MHz)

PHASE	Line 1	6dB BANDWIDTH	9kHz
TEST MODE	A		

No	Freq. [MHz]	Corr. Factor (dB)	Reading Value		Emission Level		Limit		Margin	
			[dB (uV)]		[dB (uV)]		[dB (uV)]		(dB)	
			Q.P.	AV.	Q.P.	AV.	Q.P.	AV.	Q.P.	AV.
1	0.16562	0.17	49.59	36.07	49.76	36.24	65.18	55.18	-15.42	-18.94
2	0.19687	0.17	45.42	31.38	45.59	31.55	63.74	53.74	-18.15	-22.19
3	0.80625	0.22	24.13	17.72	24.35	17.94	56.00	46.00	-31.65	-28.06
4	1.89453	0.29	23.97	16.94	24.26	17.23	56.00	46.00	-31.74	-28.77
5	14.75781	0.60	35.86	29.22	36.46	29.82	60.00	50.00	-23.54	-20.18
6	27.16406	0.66	29.81	23.86	30.47	24.52	60.00	50.00	-29.53	-25.48

#### REMARKS:

1. Q.P. and AV. are abbreviations of quasi-peak and average individually.
2. The emission levels of other frequencies were very low against the limit.
3. Margin value = Emission level - Limit value
4. Correction factor = Insertion loss + Cable loss
5. Emission Level = Correction Factor + Reading Value.

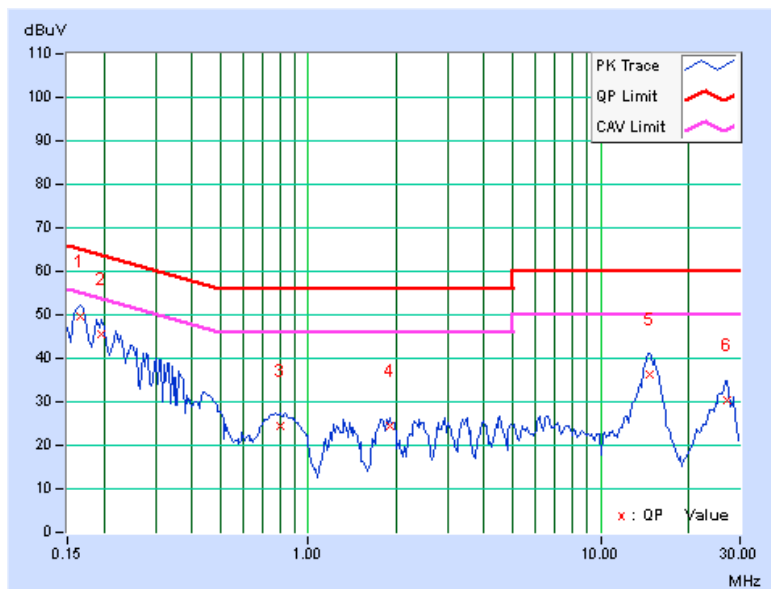

PHASE	Line 2	6dB BANDWIDTH	9kHz
TEST MODE	A		

No	Freq. [MHz]	Corr. Factor (dB)	Reading Value		Emission Level		Limit		Margin	
			[dB (uV)]		[dB (uV)]		[dB (uV)]		(dB)	
			Q.P.	AV.	Q.P.	AV.	Q.P.	AV.	Q.P.	AV.
1	0.16562	0.16	50.13	37.17	50.29	37.33	65.18	55.18	-14.88	-17.84
2	0.21641	0.15	43.14	27.90	43.29	28.05	62.96	52.96	-19.66	-24.90
3	0.80625	0.19	24.72	18.24	24.91	18.43	56.00	46.00	-31.09	-27.57
4	1.86328	0.26	24.52	17.48	24.78	17.74	56.00	46.00	-31.22	-28.26
5	14.72656	0.69	36.33	29.30	37.02	29.99	60.00	50.00	-22.98	-20.01
6	27.37109	0.71	26.32	19.84	27.03	20.55	60.00	50.00	-32.97	-29.45

**REMARKS:**

1. Q.P. and AV. are abbreviations of quasi-peak and average individually.
2. The emission levels of other frequencies were very low against the limit.
3. Margin value = Emission level - Limit value
4. Correction factor = Insertion loss + Cable loss
5. Emission Level = Correction Factor + Reading Value.

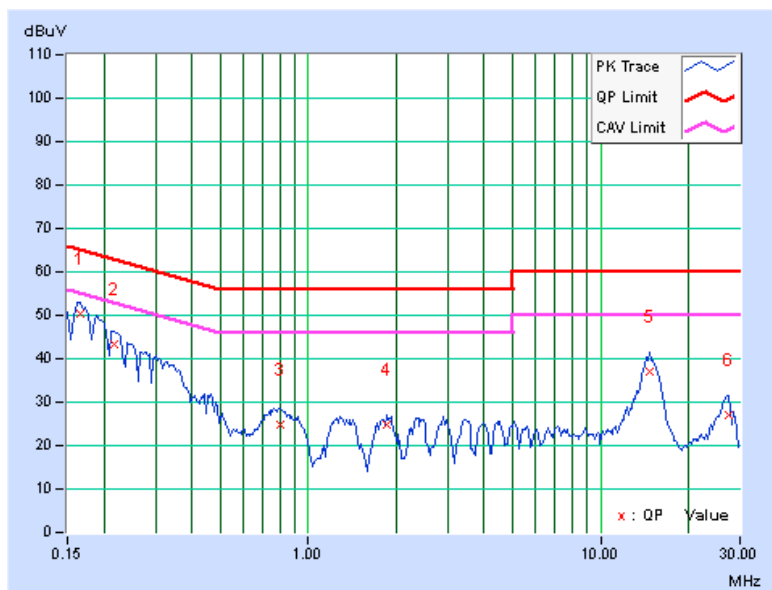

PHASE	Line 1	6dB BANDWIDTH	9kHz
TEST MODE	B		

No	Freq. [MHz]	Corr. Factor (dB)	Reading Value		Emission Level		Limit		Margin	
			[dB (uV)]		[dB (uV)]		[dB (uV)]		(dB)	
			Q.P.	AV.	Q.P.	AV.	Q.P.	AV.	Q.P.	AV.
1	0.19687	0.17	39.47	31.38	39.64	31.55	63.74	53.74	-24.10	-22.19
2	0.22812	0.17	36.39	16.48	36.56	16.65	62.52	52.52	-25.95	-35.86
3	0.62656	0.21	29.17	12.27	29.38	12.48	56.00	46.00	-26.62	-33.52
4	0.96641	0.23	25.75	11.17	25.98	11.40	56.00	46.00	-30.02	-34.60
5	12.77344	0.55	26.99	16.38	27.54	16.93	60.00	50.00	-32.46	-33.07
6	23.47656	0.70	22.34	11.28	23.04	11.98	60.00	50.00	-36.96	-38.02

**REMARKS:**

1. Q.P. and AV. are abbreviations of quasi-peak and average individually.
2. The emission levels of other frequencies were very low against the limit.
3. Margin value = Emission level - Limit value
4. Correction factor = Insertion loss + Cable loss
5. Emission Level = Correction Factor + Reading Value.

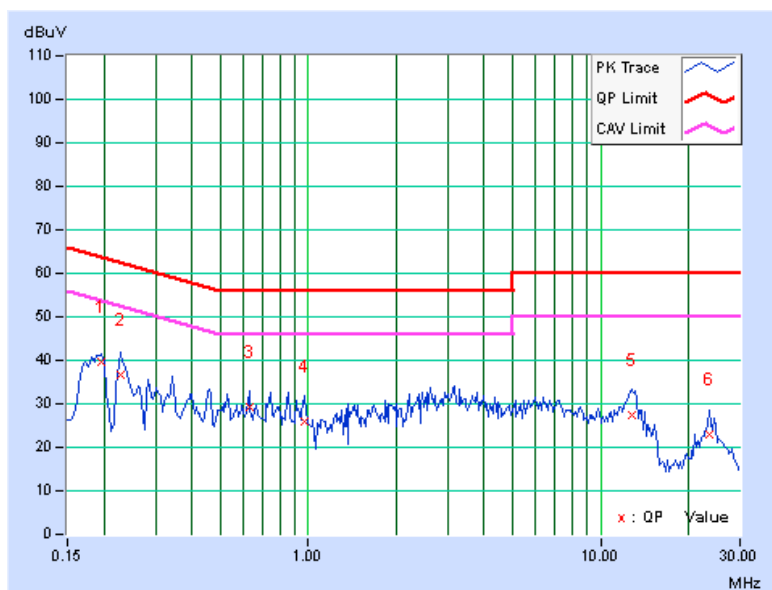

PHASE	Line 2	6dB BANDWIDTH	9kHz
TEST MODE	B		

No	Freq. [MHz]	Corr. Factor (dB)	Reading Value		Emission Level		Limit		Margin	
			[dB (uV)]		[dB (uV)]		[dB (uV)]		(dB)	
			Q.P.	AV.	Q.P.	AV.	Q.P.	AV.	Q.P.	AV.
1	0.19297	0.15	38.21	25.03	38.36	25.18	63.91	53.91	-25.54	-28.72
2	0.22422	0.15	30.91	13.75	31.06	13.90	62.66	52.66	-31.60	-38.76
3	0.62266	0.18	23.29	9.98	23.47	10.16	56.00	46.00	-32.53	-35.84
4	2.77734	0.31	29.05	15.25	29.36	15.56	56.00	46.00	-26.64	-30.44
5	13.02734	0.65	26.29	13.28	26.94	13.93	60.00	50.00	-33.06	-36.07
6	24.25781	0.76	21.12	7.64	21.88	8.40	60.00	50.00	-38.12	-41.60

**REMARKS:**

1. Q.P. and AV. are abbreviations of quasi-peak and average individually.
2. The emission levels of other frequencies were very low against the limit.
3. Margin value = Emission level - Limit value
4. Correction factor = Insertion loss + Cable loss
5. Emission Level = Correction Factor + Reading Value.

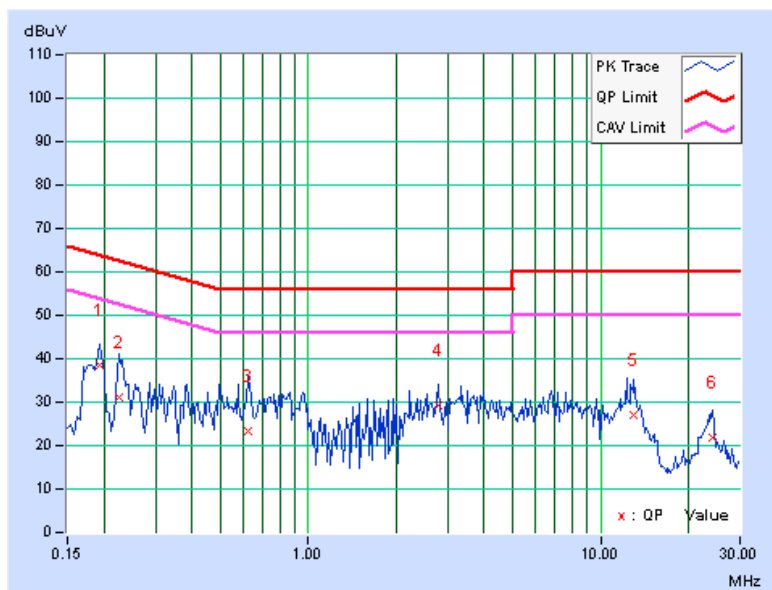

### 4.3 6dB BANDWIDTH MEASUREMENT

#### 4.3.1 LIMITS OF 6dB BANDWIDTH MEASUREMENT

The minimum of 6dB Bandwidth Measurement is 0.5 MHz.

#### 4.3.2 TEST SETUP

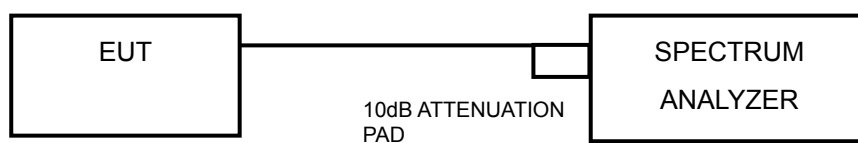

#### 4.3.3 TEST INSTRUMENTS

Refer to section 4.1.2 to get information of above instrument.

#### 4.3.4 TEST PROCEDURE

- a. Set resolution bandwidth (RBW) = approximately 1% of the emission bandwidth
- b. Set the video bandwidth (VBW)  $\geq 3 \times$  RBW, Detector = Peak.
- c. Trace mode = max hold.
- d. Sweep = auto couple.
- e. Measure the maximum width of the emission that is constrained by the frequencies associated with the two amplitude points (upper and lower) that are attenuated by 6 dB relative to the maximum level measured in the fundamental emission

#### 4.3.5 DEVIATION FROM TEST STANDARD

No deviation.

#### 4.3.6 EUT OPERATING CONDITIONS

The software provided by client to enable the EUT under transmission condition continuously at lowest, middle and highest channel frequencies individually.



### 4.3.7 TEST RESULTS

#### 802.11b

CHANNEL	FREQUENCY (MHz)	6dB BANDWIDTH (MHz)	MINIMUM LIMIT (MHz)	PASS / FAIL
1	2412	10.30	0.5	PASS
6	2437	10.29	0.5	PASS
11	2462	10.29	0.5	PASS

#### 802.11g

CHANNEL	FREQUENCY (MHz)	6dB BANDWIDTH (MHz)	MINIMUM LIMIT (MHz)	PASS / FAIL
1	2412	16.55	0.5	PASS
6	2437	16.52	0.5	PASS
11	2462	16.51	0.5	PASS

#### 802.11n (20MHz)

CHANNEL	FREQUENCY (MHz)	6dB BANDWIDTH (MHz)		MINIMUM LIMIT (MHz)	PASS / FAIL
		CHAIN 0	CHAIN 1		
1	2412	17.71	17.78	0.5	PASS
6	2437	17.76	17.39	0.5	PASS
11	2462	17.76	17.69	0.5	PASS

#### 802.11n (40MHz)

CHANNEL	FREQUENCY (MHz)	6dB BANDWIDTH (MHz)		MINIMUM LIMIT (MHz)	PASS / FAIL
		CHAIN 0	CHAIN 1		
3	2422	37.48	36.34	0.5	PASS
6	2437	37.25	36.97	0.5	PASS
9	2452	37.71	36.98	0.5	PASS

## 4.4 CONDUCTED OUTPUT POWER

### 4.4.1 LIMITS OF CONDUCTED OUTPUT POWER MEASUREMENT

For systems using digital modulation in the 2400–2483.5 MHz bands: 1 Watt (30dBm)

### 4.4.2 TEST SETUP

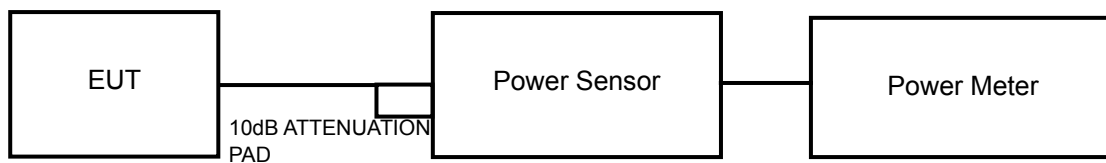

### 4.4.3 TEST INSTRUMENTS

Refer to section 4.1.2 to get information of above instrument.

### 4.4.4 TEST PROCEDURES

A peak power sensor was used on the output port of the EUT. A power meter was used to read the response of the peak power sensor. Record the peak power level.

### 4.4.5 DEVIATION FROM TEST STANDARD

No deviation.

### 4.4.6 EUT OPERATING CONDITIONS

Same as Item 4.3.6.





#### 4.4.7 TEST RESULTS

##### 802.11b

CHANNEL	FREQUENCY (MHz)	PEAK POWER (mW)	PEAK POWER (dBm)	LIMIT (dBm)	PASS/FAIL
1	2412	331.89	25.21	30	PASS
6	2437	274.79	24.39	30	PASS
11	2462	242.10	23.84	30	PASS

##### 802.11g

CHANNEL	FREQUENCY (MHz)	PEAK POWER (mW)	PEAK POWER (dBm)	LIMIT (dBm)	PASS/FAIL
1	2412	963.83	29.84	30	PASS
6	2437	931.11	29.69	30	PASS
11	2462	887.16	29.48	30	PASS

##### 802.11n (20MHz)

CHAN.	FREQUENCY (MHz)	PEAK POWER (dBm)		TOTAL POWER (mW)	TOTAL POWER (dBm)	LIMIT (dBm)	PASS / FAIL
		CHAIN 0	CHAIN 1				
1	2412	27.41	26.24	971.53	29.87	30	PASS
6	2437	27.45	26.04	957.70	29.81	30	PASS
11	2462	27.27	26.60	990.42	29.96	30	PASS

##### 802.11n (40MHz)

CHAN.	FREQUENCY (MHz)	PEAK POWER (dBm)		TOTAL POWER (mW)	TOTAL POWER (dBm)	LIMIT (dBm)	PASS / FAIL
		CHAIN 0	CHAIN 1				
3	2422	25.11	24.74	622.19	27.94	30	PASS
6	2437	27.63	26.20	996.30	29.98	30	PASS
9	2452	25.92	24.21	654.47	28.16	30	PASS

## 4.5 POWER SPECTRAL DENSITY MEASUREMENT

### 4.5.1 LIMITS OF POWER SPECTRAL DENSITY MEASUREMENT

The Maximum of Power Spectral Density Measurement is 8dBm.

### 4.5.2 TEST SETUP

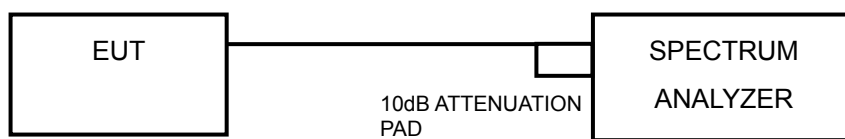

### 4.5.3 TEST INSTRUMENTS

Refer to section 4.1.2 to get information of above instrument.

### 4.5.4 TEST PROCEDURE

- a. Set the RBW = 100 kHz, VBW = 300 kHz, Detector = peak.
- b. Sweep time = auto couple, Trace mode = max hold, allow trace to fully stabilize.
- c. Use the peak marker function to determine the maximum power level in any 100 kHz band segment within the fundamental EBW.
- d. Scale the observed power level to an equivalent value in 3 kHz by adjusting (reducing) the measured power by a bandwidth correction factor (BWCF) where  $BWCF = 10\log(3 \text{ kHz}/100\text{kHz})$

### 4.5.5 DEVIATION FROM TEST STANDARD

No deviation.

### 4.5.6 EUT OPERATING CONDITION

Same as Item 4.3.6

## 4.5.7 TEST RESULTS

### 802.11b

Channel	FREQ. (MHz)	PSD (dBm/100kHz)	PSD (dBm/3kHz)	Limit (dBm/3kHz)	PASS /FAIL
1	2412	13.56	-1.67	8	PASS
6	2437	12.89	-2.34	8	PASS
11	2462	12.28	-2.95	8	PASS

### 802.11g

Channel	FREQ. (MHz)	PSD (dBm/100kHz)	PSD (dBm/3kHz)	Limit (dBm/3kHz)	PASS /FAIL
1	2412	9.40	-5.83	8	PASS
6	2437	10.47	-4.76	8	PASS
11	2462	9.16	-6.07	8	PASS

### 802.11n (20MHz)

Tx chain	Channel	FREQ. (MHz)	PSD (dBm/100kHz)	PSD (dBm/3kHz)	10 log (N=2) dB	Total PSD (dBm/3kHz)	Limit (dBm/3kHz)	PASS /FAIL
0	1	2412	6.98	-8.25	3.01	-5.24	8	PASS
	6	2437	7.70	-7.53	3.01	-4.52	8	PASS
	11	2462	6.89	-8.34	3.01	-5.33	8	PASS
1	1	2412	6.88	-8.35	3.01	-5.34	8	PASS
	6	2437	7.16	-8.07	3.01	-5.06	8	PASS
	11	2462	7.45	-7.78	3.01	-4.77	8	PASS

### 802.11n (40MHz)

Tx chain	Channel	FREQ. (MHz)	PSD (dBm/100kHz)	PSD (dBm/3kHz)	10 log (N=2) dB	Total PSD (dBm/3kHz)	Limit (dBm/3kHz)	PASS /FAIL
0	3	2422	3.05	-12.18	3.01	-9.17	8	PASS
	6	2437	5.73	-9.50	3.01	-6.49	8	PASS
	9	2452	4.49	-10.74	3.01	-7.73	8	PASS
1	3	2422	3.66	-11.57	3.01	-8.56	8	PASS
	6	2437	5.93	-9.30	3.01	-6.29	8	PASS
	9	2452	4.11	-11.12	3.01	-8.11	8	PASS

## 4.6 CONDUCTED OUT OF BAND EMISSION MEASUREMENT

### 4.6.1 LIMITS OF CONDUCTED OUT OF BAND EMISSION MEASUREMENT

Below  $-20\text{dB}$  of the highest emission level of operating band (in 100kHz Resolution Bandwidth).

### 4.6.2 TEST SETUP

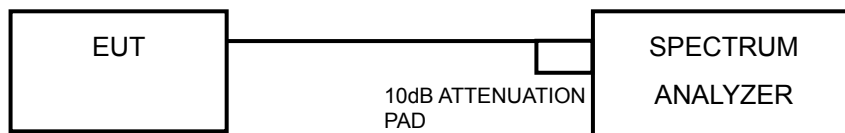

### 4.6.3 TEST INSTRUMENTS

Refer to section 4.1.2 to get information of above instrument.

### 4.6.4 TEST PROCEDURE

#### MEASUREMENT PROCEDURE REF

1. Set the RBW = 100 kHz.
2. Set the VBW  $\geq$  300 kHz.
3. Detector = peak.
4. Sweep time = auto couple.
5. Trace mode = max hold.
6. Allow trace to fully stabilize.
7. Use the peak marker function to determine the maximum power level in any 100 kHz band segment within the fundamental EBW.

## MEASUREMENT PROCEDURE OOB

1. Set RBW = 100 kHz.
2. Set VBW  $\geq$  300 kHz.
3. Set span to encompass the spectrum to be examined.
4. Detector = peak.
5. Trace Mode = max hold.
6. Sweep = auto couple.

### 4.6.5 DEVIATION FROM TEST STANDARD

No deviation.

### 4.6.6 EUT OPERATING CONDITION

Same as Item 4.3.6

### 4.6.7 TEST RESULTS

The conducted emission test is performed on each TX port of operating mode without summing or adding  $10\log(N)$  since the limit is relative emission limit. Only worst data of each operating mode is presented.

The spectrum plots are attached on the following pages. D1 line indicates the highest level, and D2 line indicates the 20dB offset below D1. It shows compliance with the requirement.

802.11b

CH 1

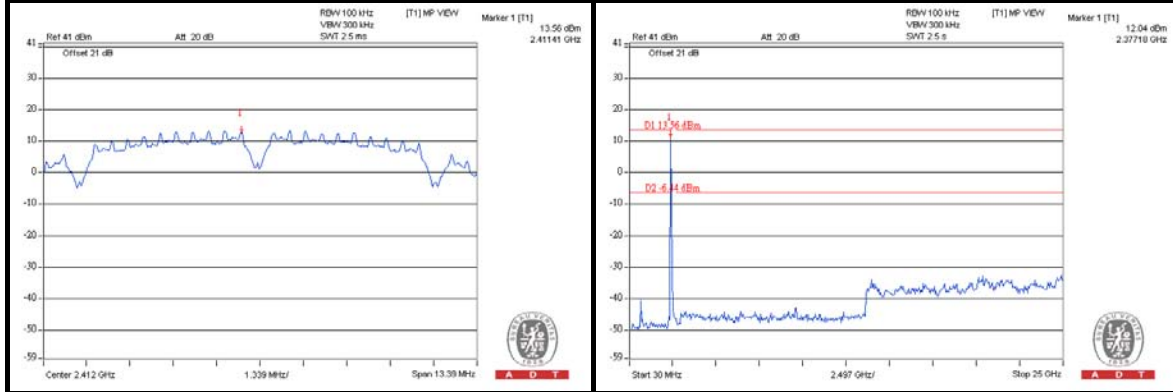

CH 6

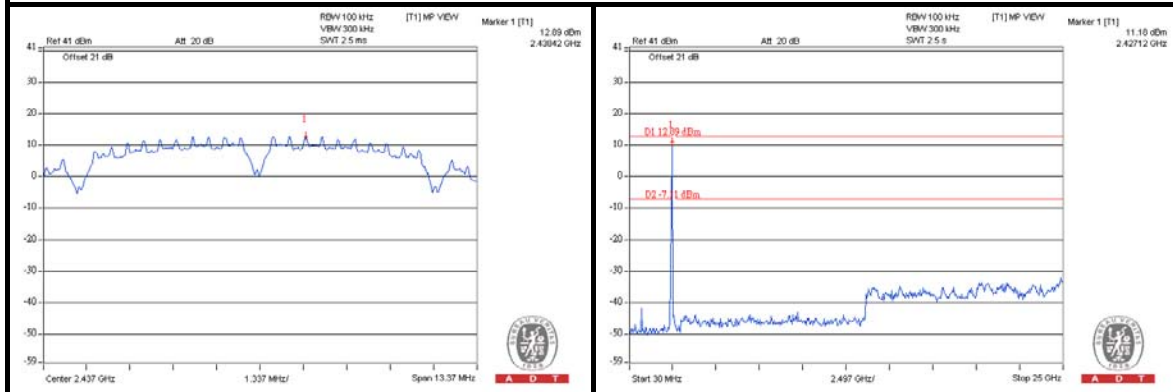

CH 11

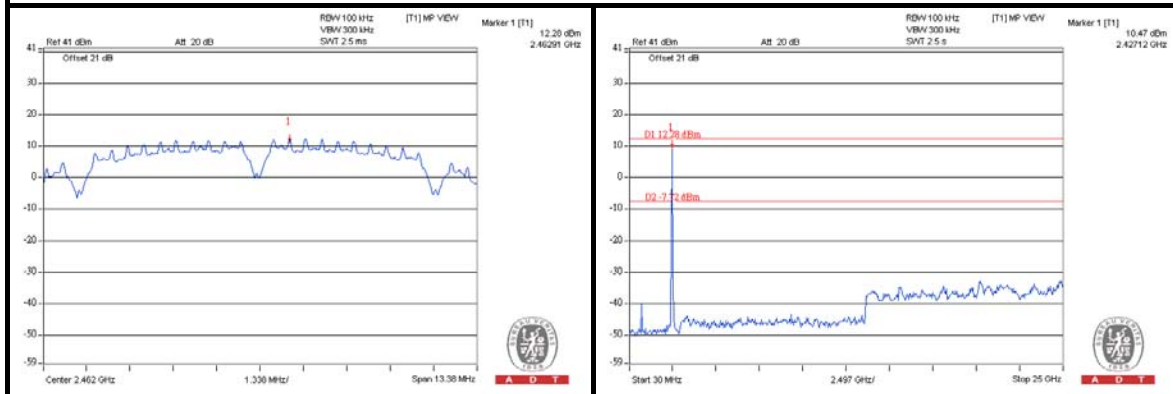

802.11g

CH 1

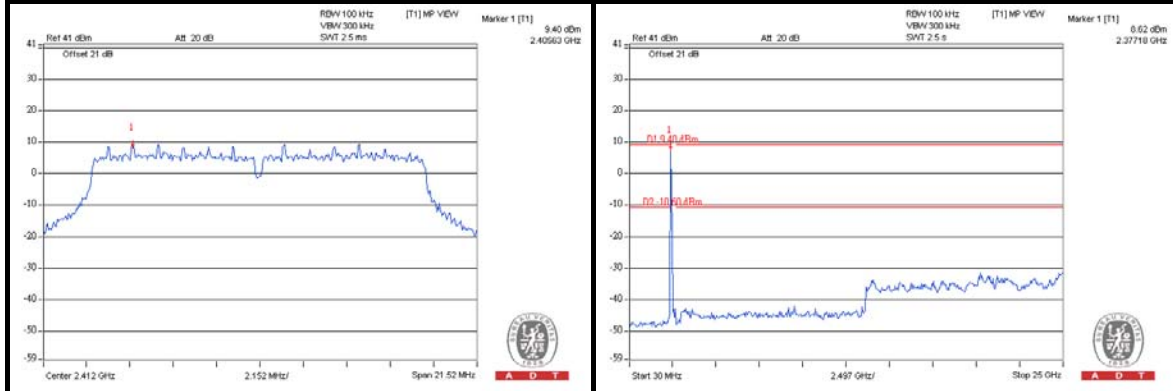

CH 6

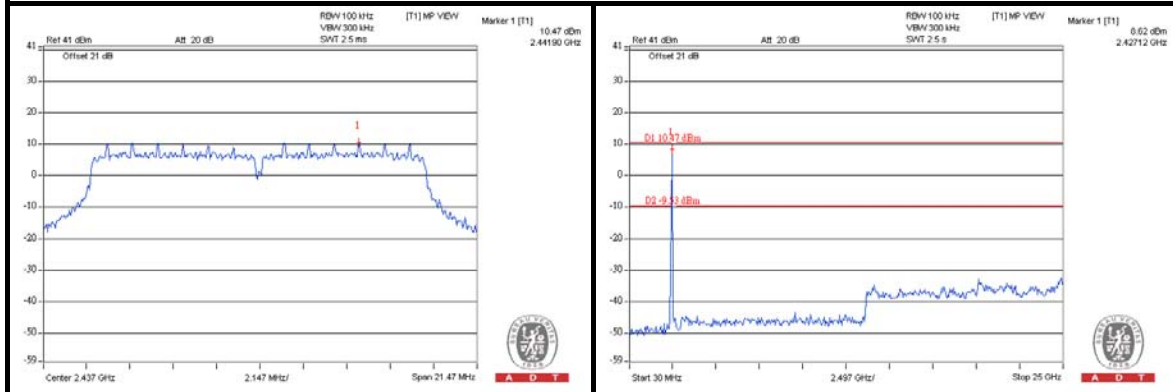

CH 11

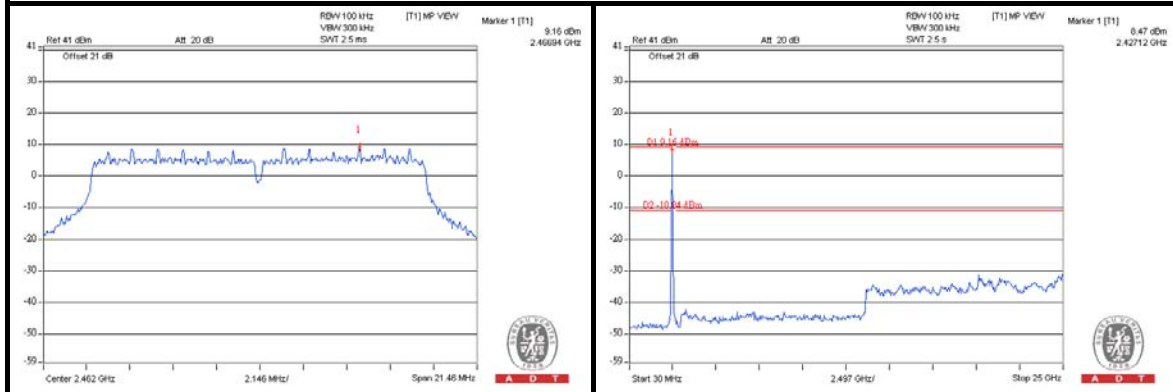

802.11n (20MHz)

CH 1

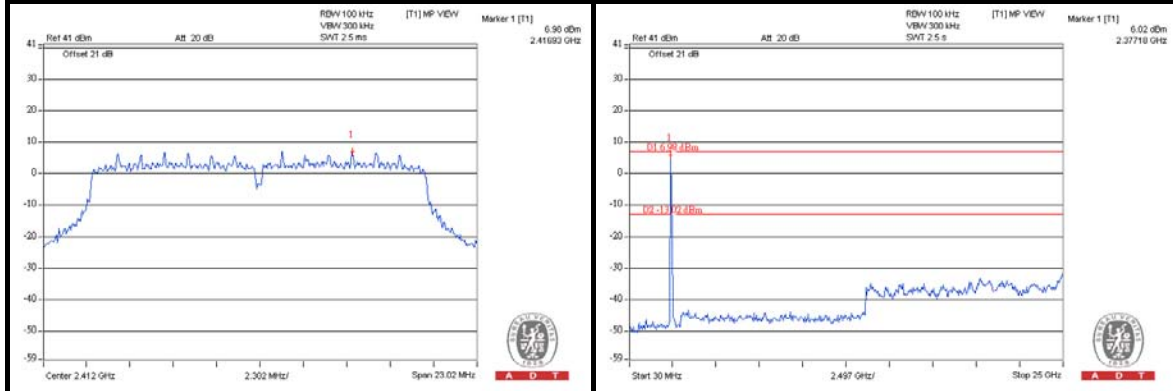

CH 6

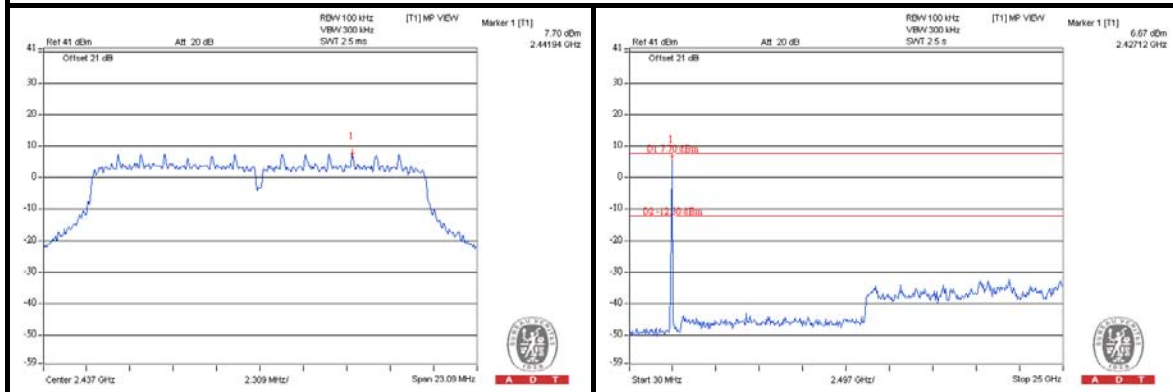

CH 11

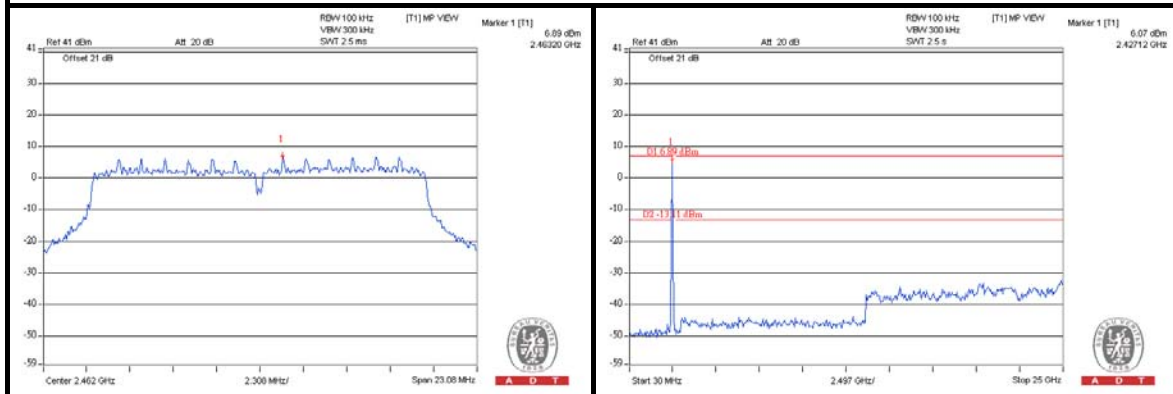



802.11n (40MHz)

CH 3

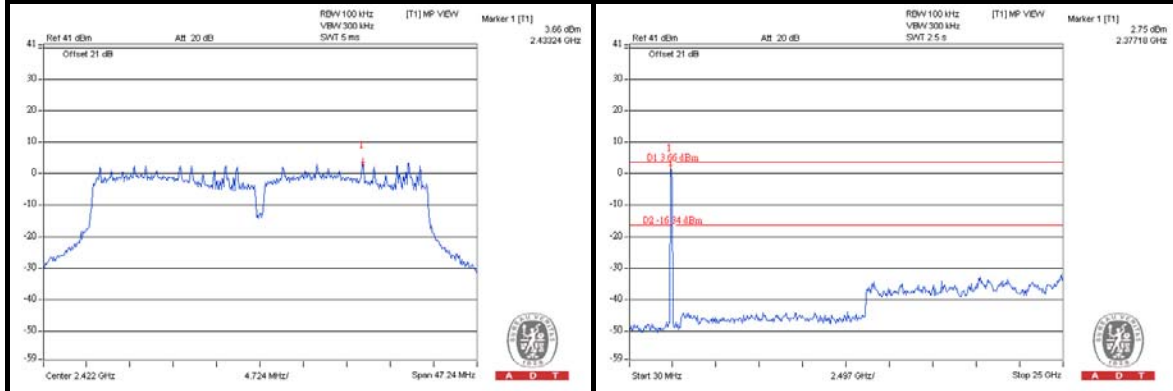

CH 6

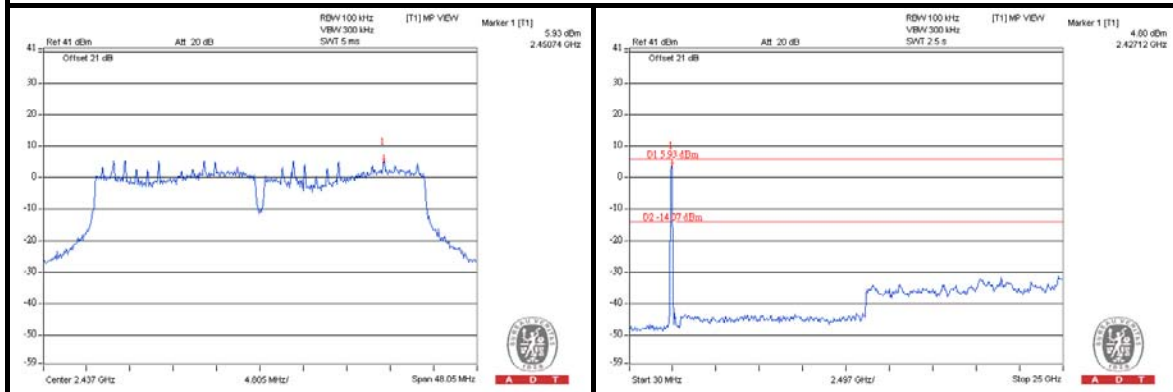

CH 9

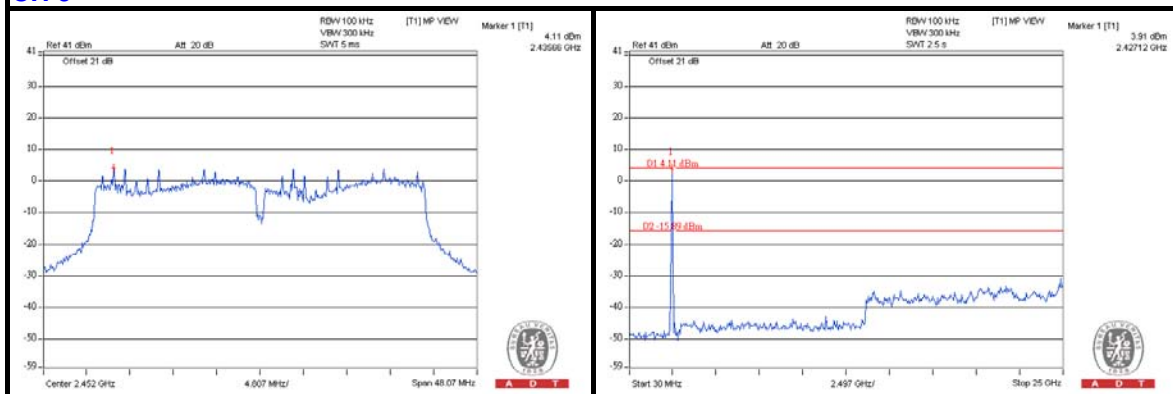

## 5. PHOTOGRAPHS OF THE TEST CONFIGURATION

Please refer to the attached file (Test Setup Photo).



## 6. INFORMATION ON THE TESTING LABORATORIES

We, Bureau Veritas Consumer Products Services (H.K.) Ltd., Taoyuan Branch, were founded in 1988 to provide our best service in EMC, Radio, Telecom and Safety consultation. Our laboratories are accredited and approved according to ISO/IEC 17025.

If you have any comments, please feel free to contact us at the following:

**Linko EMC/RF Lab:**

Tel: 886-2-26052180

Fax: 886-2-26051924

**Hsin Chu EMC/RF Lab:**

Tel: 886-3-5935343

Fax: 886-3-5935342

**Hwa Ya EMC/RF/Safety Telecom Lab:**

Tel: 886-3-3183232

Fax: 886-3-3270892

**Email:** [service.adt@tw.bureauveritas.com](mailto:service.adt@tw.bureauveritas.com)

**Web Site:** [www.adt.com.tw](http://www.adt.com.tw)

The address and road map of all our labs can be found in our web site also.



A D T

## 7. APPENDIX A - MODIFICATIONS RECORDERS FOR ENGINEERING CHANGES TO THE EUT BY THE LAB

No any modifications are made to the EUT by the lab during the test.

---END---