



FCC TEST REPORT (15.247)

REPORT NO.: RF140721C14

MODEL NO.: OM5P-AN

FCC ID: WT8-OM5PAN

RECEIVED: Jul. 21, 2014

TESTED: Nov. 13 ~ Nov. 28, 2014

ISSUED: Dec. 03, 2014

APPLICANT: Open Mesh, Inc.

ADDRESS: 7327 SW Barnes Rd #422, Portland, OR 97225

ISSUED BY: Bureau Veritas Consumer Products Services
(H.K.) Ltd., Taoyuan Branch

LAB ADDRESS: No. 47-2, 14th Ling, Chia Pau Vil., Lin Kou Dist.,
New Taipei City, Taiwan, R.O.C.

TEST LOCATION: No. 19, Hwa Ya 2nd Rd, Wen Hwa Tsuen, Kwei
Shan Hsiang, Taoyuan Hsien 333, Taiwan, R.O.C.

This report should not be used by the client to claim product certification, approval, or endorsement by TAF or any government agencies.



This report is for your exclusive use. Any copying or replication of this report to or for any other person or entity, or use of our name or trademark, is permitted only with our prior written permission. This report sets forth our findings solely with respect to the test samples identified herein. The results set forth in this report are not indicative or representative of the quality or characteristics of the lot from which a test sample was taken or any similar or identical product unless specifically and expressly noted. Our report includes all of the tests requested by you and the results thereof based upon the information that you provided to us. You have 60 days from date of issuance of this report to notify us of any material error or omission caused by our negligence, provided, however, that such notice shall be in writing and shall specifically address the issue you wish to raise. A failure to raise such issue within the prescribed time shall constitute your unqualified acceptance of the completeness of this report, the tests conducted and the correctness of the report contents. Unless specific mention, the uncertainty of measurement has been explicitly taken into account to declare the compliance or non-compliance to the specification.



TABLE OF CONTENTS

RELEASE CONTROL RECORD.....	5
1. CERTIFICATION	6
2. SUMMARY OF TEST RESULTS	7
2.1 MEASUREMENT UNCERTAINTY.....	7
3. GENERAL INFORMATION.....	8
3.1 GENERAL DESCRIPTION OF EUT	8
3.2 DESCRIPTION OF TEST MODES	10
3.2.1 TEST MODE APPLICABILITY AND TESTED CHANNEL DETAIL	11
3.3 DUTY CYCLE OF TEST SIGNAL.....	16
3.4 DESCRIPTION OF SUPPORT UNITS	18
3.4.1 CONFIGURATION OF SYSTEM UNDER TEST	19
3.5 GENERAL DESCRIPTION OF APPLIED STANDARDS	20
4. TEST TYPES AND RESULTS (FOR 2.4GHz BAND).....	21
4.1 RADIATED EMISSION AND BANDEDGE MEASUREMENT.....	21
4.1.1 LIMITS OF RADIATED EMISSION AND BANDEDGE MEASUREMENT	21
4.1.2 TEST INSTRUMENTS.....	22
4.1.3 TEST PROCEDURES	23
4.1.4 DEVIATION FROM TEST STANDARD	23
4.1.5 TEST SETUP.....	24
4.1.6 EUT OPERATING CONDITIONS	25
4.1.7 TEST RESULTS	26
4.2 CONDUCTED EMISSION MEASUREMENT	41
4.2.1 LIMITS OF CONDUCTED EMISSION MEASUREMENT.....	41
4.2.2 TEST INSTRUMENTS.....	41
4.2.3 TEST PROCEDURES	42
4.2.4 DEVIATION FROM TEST STANDARD	42
4.2.5 TEST SETUP.....	42
4.2.6 EUT OPERATING CONDITIONS	42
4.2.7 TEST RESULTS	43
4.3 6dB BANDWIDTH MEASUREMENT.....	49
4.3.1 LIMITS OF 6dB BANDWIDTH MEASUREMENT	49
4.3.2 TEST SETUP.....	49
4.3.3 TEST INSTRUMENTS.....	49
4.3.4 TEST PROCEDURE.....	49
4.3.5 DEVIATION FROM TEST STANDARD	49
4.3.6 EUT OPERATING CONDITIONS	49
4.3.7 TEST RESULTS	50
4.4 CONDUCTED OUTPUT POWER	52
4.4.1 LIMITS OF CONDUCTED OUTPUT POWER MEASUREMENT	52
4.4.2 TEST SETUP.....	52
4.4.3 TEST INSTRUMENTS.....	52
4.4.4 TEST PROCEDURES	52
4.4.5 DEVIATION FROM TEST STANDARD	52
4.4.6 EUT OPERATING CONDITIONS	52
4.4.7 TEST RESULTS	53
4.5 POWER SPECTRAL DENSITY MEASUREMENT.....	54
4.5.1 LIMITS OF POWER SPECTRAL DENSITY MEASUREMENT	54
4.5.2 TEST SETUP.....	54
4.5.3 TEST INSTRUMENTS.....	54
4.5.4 TEST PROCEDURE.....	54



4.5.5	DEVIATION FROM TEST STANDARD	54
4.5.6	EUT OPERATING CONDITION.....	54
4.5.7	TEST RESULTS	55
4.6	CONDUCTED OUT OF BAND EMISSION MEASUREMENT.....	57
4.6.1	LIMITS OF CONDUCTED OUT OF BAND EMISSION MEASUREMENT	57
4.6.2	TEST SETUP.....	57
4.6.3	TEST INSTRUMENTS.....	57
4.6.4	TEST PROCEDURE.....	58
4.6.5	DEVIATION FROM TEST STANDARD	58
4.6.6	EUT OPERATING CONDITION.....	58
4.6.7	TEST RESULTS	58
5.	TEST TYPES AND RESULTS (FOR 5.0GHz BAND).....	63
5.1	RADIATED EMISSION MEASUREMENT	63
5.1.1	LIMITS OF RADIATED EMISSION MEASUREMENT	63
5.1.2	TEST INSTRUMENTS.....	64
5.1.3	TEST PROCEDURES	64
5.1.4	DEVIATION FROM TEST STANDARD	64
5.1.5	TEST SETUP.....	64
5.1.6	EUT OPERATING CONDITIONS	64
5.1.7	TEST RESULTS	65
5.2	CONDUCTED EMISSION MEASUREMENT	76
5.2.1	LIMITS OF CONDUCTED EMISSION MEASUREMENT.....	76
5.2.2	TEST INSTRUMENTS.....	76
5.2.3	TEST PROCEDURES	76
5.2.4	DEVIATION FROM TEST STANDARD	76
5.2.5	TEST SETUP.....	76
5.2.6	EUT OPERATING CONDITIONS	76
5.2.7	TEST RESULTS	77
5.3	6dB BANDWIDTH MEASUREMENT.....	83
5.3.1	LIMITS OF 6dB BANDWIDTH MEASUREMENT	83
5.3.2	TEST SETUP.....	83
5.3.3	TEST INSTRUMENTS.....	83
5.3.4	TEST PROCEDURE.....	83
5.3.5	DEVIATION FROM TEST STANDARD	83
5.3.6	EUT OPERATING CONDITIONS	83
5.3.7	TEST RESULTS	84
5.4	CONDUCTED OUTPUT POWER	86
5.4.1	LIMITS OF CONDUCTED OUTPUT POWER MEASUREMENT	86
5.4.2	TEST SETUP.....	86
5.4.3	INSTRUMENTS.....	86
5.4.4	TEST PROCEDURES	86
5.4.5	DEVIATION FROM TEST STANDARD	86
5.4.6	EUT OPERATING CONDITIONS	86
5.4.7	TEST RESULTS	87
5.5	POWER SPECTRAL DENSITY MEASUREMENT.....	88
5.5.1	LIMITS OF POWER SPECTRAL DENSITY MEASUREMENT	88
5.5.2	TEST SETUP.....	88
5.5.3	TEST INSTRUMENTS.....	88
5.5.4	TEST PROCEDURE.....	88
5.5.5	DEVIATION FROM TEST STANDARD	88
5.5.6	EUT OPERATING CONDITION.....	88
5.5.7	TEST RESULTS	89
5.6	CONDUCTED OUT OF BAND EMISSION MEASUREMENT.....	91



A D T

5.6.1	LIMITS OF CONDUCTED OUT OF BAND EMISSION MEASUREMENT	91
5.6.2	TEST SETUP.....	91
5.6.3	TEST INSTRUMENTS.....	91
5.6.4	TEST PROCEDURE.....	91
5.6.5	DEVIATION FROM TEST STANDARD	91
5.6.6	EUT OPERATING CONDITION.....	91
5.6.7	TEST RESULTS	91
6.	PHOTOGRAPHS OF THE TEST CONFIGURATION.....	98
7.	INFORMATION ON THE TESTING LABORATORIES	99
8.	APPENDIX A – MODIFICATIONS RECORDERS FOR ENGINEERING CHANGES TO THE EUT BY THE LAB.....	100



RELEASE CONTROL RECORD

ISSUE NO.	REASON FOR CHANGE	DATE ISSUED
RF140721C14	Original release	Dec. 03, 2014

1. CERTIFICATION

PRODUCT: Wireless 802.11a/b/g/n Mesh Router
MODEL NO.: OM5P-AN
BRAND: Open Mesh
APPLICANT: Open Mesh, Inc.
TESTED: Nov. 13 ~ Nov. 28, 2014
TEST SAMPLE: ENGINEERING SAMPLE
STANDARDS: FCC Part 15, Subpart C (Section 15.247)

The above equipment (model: OM5P-AN) has been tested by **Bureau Veritas Consumer Products Services (H.K.) Ltd., Taoyuan Branch**, and found compliance with the requirement of the above standards. The test record, data evaluation & Equipment Under Test (EUT) configurations represented herein are true and accurate accounts of the measurements of the sample's EMC characteristics under the conditions specified in this report.

PREPARED BY : Celine Chou , **DATE** : Dec. 03, 2014
Celine Chou / Specialist

APPROVED BY : Ken Liu , **DATE** : Dec. 03, 2014
Ken Liu / Senior Manager

2. SUMMARY OF TEST RESULTS

The EUT has been tested according to the following specifications:

APPLIED STANDARD: FCC PART 15, SUBPART C (SECTION 15.247)			
STANDARD SECTION	TEST TYPE	RESULT	REMARK
15.207	AC Power Conducted Emission	PASS	Meet the requirement of limit. Minimum passing margin is -3.16dB at 23.12907MHz.
15.205 & 209	Radiated Emissions	PASS	Meet the requirement of limit. Minimum passing margin is -1.3dB at 2390.00MHz.
15.247(d)	Band Edge Measurement	PASS	Meet the requirement of limit. Minimum passing margin is -1.6dB at 2483.50MHz.
15.247(d)	Antenna Port Emission	PASS	Meet the requirement of limit.
15.247(a)(2)	6dB bandwidth	PASS	Meet the requirement of limit.
15.247(b)	Conducted power	PASS	Meet the requirement of limit.
15.247(e)	Power Spectral Density	PASS	Meet the requirement of limit.
15.203	Antenna Requirement	PASS	Antenna connector is IPEX not a standard connector.

2.1 MEASUREMENT UNCERTAINTY

Where relevant, the following measurement uncertainty levels have been estimated for tests performed on the EUT as specified in CISPR 16-4-2:

MEASUREMENT	FREQUENCY	UNCERTAINTY
Conducted emissions	150kHz~30MHz	2.44 dB
Radiated emissions	30MHz ~ 200MHz	3.86 dB
	200MHz ~1000MHz	3.87 dB
	1GHz ~ 18GHz	2.29 dB
	18GHz ~ 40GHz	2.29 dB

This uncertainty represents an expanded uncertainty expressed at approximately the 95% confidence level using a coverage factor of $k = 2$.

3. GENERAL INFORMATION

3.1 GENERAL DESCRIPTION OF EUT

EUT	Wireless 802.11a/b/g/n Mesh Router
MODEL NO.	OM5P-AN
POWER SUPPLY	12Vdc from adapter 24Vdc or 48Vdc from POE
MODULATION TYPE	CCK, DQPSK, DBPSK for DSSS 64QAM, 16QAM, QPSK, BPSK for OFDM
MODULATION TECHNOLOGY	DSSS, OFDM
TRANSFER RATE	802.11b: 11.0/ 5.5/ 2.0/ 1.0Mbps 802.11g: 54.0/ 48.0/ 36.0/ 24.0/ 18.0/ 12.0/ 9.0/ 6.0Mbps 802.11n: up to 300Mbps
OPERATING FREQUENCY	2.4GHz: 2412 ~ 2462MHz 5.0GHz: 5745 ~ 5825MHz
NUMBER OF CHANNEL	2.4GHz: 11 for 802.11b, 802.11g, 802.11n (20MHz) 7 for 802.11n (40MHz) 5.0GHz: 5 for 802.11a, 802.11n (20MHz) 2 for 802.11n (40MHz)
OUTPUT POWER	2.4GHz: 283.792mW 5.0GHz: 129.148mW
ANTENNA TYPE	2.4GHz: Ant. 1: Printed antenna with 2.6dBi gain 5GHz: Ant. 2: Printed antenna with 2.6dBi gain Ant. 3: Printed antenna with 2.7dBi gain
ANTENNA CONNECTOR	IPEX
DATA CABLE	N/A
I/O PORTS	Refer to user's manual
ACCESSORY DEVICES	N/A

NOTE:

1. The EUT incorporates a MIMO function. Physically, the EUT provides 2 completed transmitters and 2 receivers.

BAND	MODULATION MODE	TX FUNCTION
2.4GHz	802.11b	1TX
	802.11g	1TX
	802.11n (20MHz)	1TX
	802.11n (40MHz)	1TX
5GHz	802.11a	2TX
	802.11n (20MHz)	2TX
	802.11n (40MHz)	2TX



2. The following adapter and POE & POE's adapters are supports only.

ADAPTER FOR EUT USED	
BRAND	Powertron Electronics Corp.
MODEL	PA1024-2T1
INPUT POWER	100-240Vac, 50-60Hz, 0.6A
OUTPUT POWER	12Vdc, 1.5A, 18W Max
POWER LINE	1.5m cable with 1 core attached on adapter

POE 1	
BRAND	InscapeData
MODEL	IPW-2408
OUTPUT POWER	24Vdc, 0.8A

ADAPTER FOR POE 1 USED	
BRAND	Powertron Electronics Corp.
MODEL	PA1024-3HU
INPUT POWER	100-240Vac, 50-60Hz, 0.5A
OUTPUT POWER	24Vdc, 1.0A, 24W Max
POWER LINE	1.55m cable without core attached on adapter

POE 2	
BRAND	EnGenius
MODEL	EPE-48GR
OUTPUT POWER	48Vdc, 0.8A

ADAPTER FOR POE 2 USED	
BRAND	Powertron
MODEL	PA1040-480IB080
INPUT POWER	100-240Vac, 50-60Hz, 1.5A
OUTPUT POWER	48Vdc, 0.8A, 38.4W Max
POWER LINE	1.5m cable with 1 core attached on adapter

3. The above EUT information is declared by manufacturer and for more detailed features description, please refer to the manufacturer's specifications or user's manual.

3.2 DESCRIPTION OF TEST MODES

FOR 2.4GHz:

11 channels are provided for 802.11b, 802.11g and 802.11n (20MHz):

CHANNEL	FREQUENCY	CHANNEL	FREQUENCY
1	2412MHz	7	2442MHz
2	2417MHz	8	2447MHz
3	2422MHz	9	2452MHz
4	2427MHz	10	2457MHz
5	2432MHz	11	2462MHz
6	2437MHz		

7 channels are provided for 802.11n (40MHz):

CHANNEL	FREQUENCY	CHANNEL	FREQUENCY
3	2422MHz	7	2442MHz
4	2427MHz	8	2447MHz
5	2432MHz	9	2452MHz
6	2437MHz		

FOR 5745 ~ 5825MHz:

5 channels are provided for 802.11a, 802.11n (20MHz):

CHANNEL	FREQUENCY	CHANNEL	FREQUENCY
149	5745MHz	161	5805MHz
153	5765MHz	165	5825MHz
157	5785MHz		

2 channels are provided for 802.11n (40MHz):

CHANNEL	FREQUENCY	CHANNEL	FREQUENCY
151	5755MHz	159	5795MHz



3.2.1 TEST MODE APPLICABILITY AND TESTED CHANNEL DETAIL

FOR 2.4GHz:

EUT CONFIGURE MODE	APPLICABLE TO				DESCRIPTION
	RE≥1G	RE<1G	PLC	APCM	
A	√	√	√	√	Powered by adapter
B	-	√	√	-	Powered by POE 1
C	-	√	√	-	Powered by POE 2

Where **RE≥1G**: Radiated Emission above 1GHz **RE<1G**: Radiated Emission below 1GHz
PLC: Power Line Conducted Emission **APCM**: Antenna Port Conducted Measurement

NOTE:

1. The EUT had been pre-tested on the positioned of each 3 axis. The worst case was found when positioned on **Z-plane**.
2. "-" means no effect.

RADIATED EMISSION TEST (ABOVE 1GHz):

- Pre-Scan has been conducted to determine the worst-case mode from all possible combinations between available modulations, data rates and antenna ports (if EUT with antenna diversity architecture).
- Following channel(s) was (were) selected for the final test as listed below.

EUT CONFIGURE MODE	MODE	AVAILABLE CHANNEL	TESTED CHANNEL	MODULATION TECHNOLOGY	MODULATION TYPE	DATA RATE (Mbps)
A	802.11b	1 to 11	1, 6, 11	DSSS	DBPSK	1.0
A	802.11g	1 to 11	1, 6, 11	OFDM	BPSK	6.0
A	802.11n (20MHz)	1 to 11	1, 6, 11	OFDM	BPSK	7.2
A	802.11n (40MHz)	3 to 9	3, 6, 9	OFDM	BPSK	15.0

RADIATED EMISSION TEST (BELOW 1GHz):

- Pre-Scan has been conducted to determine the worst-case mode from all possible combinations between available modulations, data rates and antenna ports (if EUT with antenna diversity architecture).
- Following channel(s) was (were) selected for the final test as listed below.

EUT CONFIGURE MODE	MODE	AVAILABLE CHANNEL	TESTED CHANNEL	MODULATION TECHNOLOGY	MODULATION TYPE	DATA RATE (Mbps)
A & B & C	802.11b	1 to 11	1	DSSS	DBPSK	1.0



POWER LINE CONDUCTED EMISSION TEST:

- Pre-Scan has been conducted to determine the worst-case mode from all possible combinations between available modulations, data rates and antenna ports (if EUT with antenna diversity architecture).
- Following channel(s) was (were) selected for the final test as listed below.

EUT CONFIGURE MODE	MODE	AVAILABLE CHANNEL	TESTED CHANNEL	MODULATION TECHNOLOGY	MODULATION TYPE	DATA RATE (Mbps)
A & B & C	802.11b	1 to 11	1	DSSS	DBPSK	1.0

BANDEDGE MEASUREMENT:

- Pre-Scan has been conducted to determine the worst-case mode from all possible combinations between available modulations, data rates and antenna ports (if EUT with antenna diversity architecture).
- Following channel(s) was (were) selected for the final test as listed below.

EUT CONFIGURE MODE	MODE	AVAILABLE CHANNEL	TESTED CHANNEL	MODULATION TECHNOLOGY	MODULATION TYPE	DATA RATE (Mbps)
A	802.11b	1 to 11	1, 11	DSSS	DBPSK	1.0
A	802.11g	1 to 11	1, 11	OFDM	BPSK	6.0
A	802.11n (20MHz)	1 to 11	1, 11	OFDM	BPSK	7.2
A	802.11n (40MHz)	3 to 9	3, 9	OFDM	BPSK	15.0

ANTENNA PORT CONDUCTED MEASUREMENT:

- This item includes all test value of each mode, but only includes spectrum plot of worst value of each mode.
- Pre-Scan has been conducted to determine the worst-case mode from all possible combinations between available modulations, data rates and antenna ports (if EUT with antenna diversity architecture).
- Following channel(s) was (were) selected for the final test as listed below.

EUT CONFIGURE MODE	MODE	AVAILABLE CHANNEL	TESTED CHANNEL	MODULATION TECHNOLOGY	MODULATION TYPE	DATA RATE (Mbps)
A	802.11b	1 to 11	1, 6, 11	DSSS	DBPSK	1.0
A	802.11g	1 to 11	1, 6, 11	OFDM	BPSK	6.0
A	802.11n (20MHz)	1 to 11	1, 6, 11	OFDM	BPSK	7.2
A	802.11n (40MHz)	3 to 9	3, 6, 9	OFDM	BPSK	15.0



A D T

TEST CONDITION:

APPLICABLE TO	ENVIRONMENTAL CONDITIONS	INPUT POWER	TESTED BY
RE \geq 1G	21deg. C, 66%RH	120Vac, 60Hz	Jones Chang
RE<1G	18deg. C, 70%RH	120Vac, 60Hz 24Vdc 48Vdc	Ted Chang
PLC	22deg. C, 70%RH	120Vac, 60Hz 24Vdc 48Vdc	Jones Chang
APCM	25deg. C, 60%RH	120Vac, 60Hz	Frank Liu



FOR 5.0GHz (5745 ~ 5825MHz):

EUT CONFIGURE MODE	APPLICABLE TO				DESCRIPTION
	RE≥1G	RE<1G	PLC	APCM	
A	√	√	√	√	Powered by adapter
B	-	√	√	-	Powered by POE 1
C	-	√	√	-	Powered by POE 2

Where **RE≥1G**: Radiated Emission above 1GHz **RE<1G**: Radiated Emission below 1GHz
PLC: Power Line Conducted Emission **APCM**: Antenna Port Conducted Measurement

NOTE:

1. The EUT had been pre-tested on the positioned of each 3 axis. The worst case was found when positioned on **X-plane**.
2. "-" means no effect.

RADIATED EMISSION TEST (ABOVE 1GHz):

- Pre-Scan has been conducted to determine the worst-case mode from all possible combinations between available modulations, data rates and antenna ports (if EUT with antenna diversity architecture).
- Following channel(s) was (were) selected for the final test as listed below.

EUT CONFIGURE MODE	MODE	AVAILABLE CHANNEL	TESTED CHANNEL	MODULATION TECHNOLOGY	MODULATION TYPE	DATA RATE (Mbps)
A	802.11a	149 to 165	149, 157, 165	OFDM	BPSK	6.0
A	802.11n (20MHz)	149 to 165	149, 157, 165	OFDM	BPSK	7.2
A	802.11n (40MHz)	151 to 159	151, 159	OFDM	BPSK	15.0

RADIATED EMISSION TEST (BELOW 1GHz):

- Pre-Scan has been conducted to determine the worst-case mode from all possible combinations between available modulations, data rates and antenna ports (if EUT with antenna diversity architecture).
- Following channel(s) was (were) selected for the final test as listed below.

EUT CONFIGURE MODE	MODE	AVAILABLE CHANNEL	TESTED CHANNEL	MODULATION TECHNOLOGY	MODULATION TYPE	DATA RATE (Mbps)
A & B & C	802.11a	149 to 165	149	OFDM	BPSK	6.0

POWER LINE CONDUCTED EMISSION TEST:

- Pre-Scan has been conducted to determine the worst-case mode from all possible combinations between available modulations, data rates and antenna ports (if EUT with antenna diversity architecture).
- Following channel(s) was (were) selected for the final test as listed below.

EUT CONFIGURE MODE	MODE	AVAILABLE CHANNEL	TESTED CHANNEL	MODULATION TECHNOLOGY	MODULATION TYPE	DATA RATE (Mbps)
A & B & C	802.11a	149 to 165	149	OFDM	BPSK	6.0



BANDEDGE MEASUREMENT:

- Pre-Scan has been conducted to determine the worst-case mode from all possible combinations between available modulations, data rates and antenna ports (if EUT with antenna diversity architecture).
- Following channel(s) was (were) selected for the final test as listed below.

EUT CONFIGURE MODE	MODE	AVAILABLE CHANNEL	TESTED CHANNEL	MODULATION TECHNOLOGY	MODULATION TYPE	DATA RATE (Mbps)
A	802.11a	149 to 165	149, 165	OFDM	BPSK	6.0
A	802.11n (20MHz)	149 to 165	149, 165	OFDM	BPSK	7.2
A	802.11n (40MHz)	151 to 159	151, 159	OFDM	BPSK	15.0

ANTENNA PORT CONDUCTED MEASUREMENT:

- This item includes all test value of each mode, but only includes spectrum plot of worst value of each mode.
- Pre-Scan has been conducted to determine the worst-case mode from all possible combinations between available modulations, data rates and antenna ports (if EUT with antenna diversity architecture).
- Following channel(s) was (were) selected for the final test as listed below.

EUT CONFIGURE MODE	MODE	AVAILABLE CHANNEL	TESTED CHANNEL	MODULATION TECHNOLOGY	MODULATION TYPE	DATA RATE (Mbps)
A	802.11a	149 to 165	149, 157, 165	OFDM	BPSK	6.0
A	802.11n (20MHz)	149 to 165	149, 157, 165	OFDM	BPSK	7.2
A	802.11n (40MHz)	151 to 159	151, 159	OFDM	BPSK	15.0

TEST CONDITION:

APPLICABLE TO	ENVIRONMENTAL CONDITIONS	INPUT POWER	TESTED BY
RE≥1G	18deg. C, 70%RH	120Vac, 60Hz	Jones Chang
RE<1G	18deg. C, 70%RH	120Vac, 60Hz 24Vdc 48Vdc	Ted Chang
PLC	22deg. C, 70%RH	120Vac, 60Hz 24Vdc 48Vdc	Jones Chang
APCM	25deg. C, 60%RH	120Vac, 60Hz	Frank Liu

3.3 DUTY CYCLE OF TEST SIGNAL

For 2.4GHz Band:

802.11b: Duty cycle of test signal is > 98 %, duty factor is not required.

802.11g, 802.11n (20MHz), 802.11n (40MHz): Duty cycle is < 98%, duty factor shall be considered.

802.11g: Duty cycle = $1.356/1.417 = 0.957$, Duty factor = $10 * \log(1/0.957) = 0.19$

802.11n (20MHz): Duty cycle = $1.271/1.326 = 0.959$, Duty factor = $10 * \log(1/0.959) = 0.18$

802.11n (40MHz): Duty cycle = $0.627/0.675 = 0.929$, Duty factor = $10 * \log(1/0.929) = 0.32$

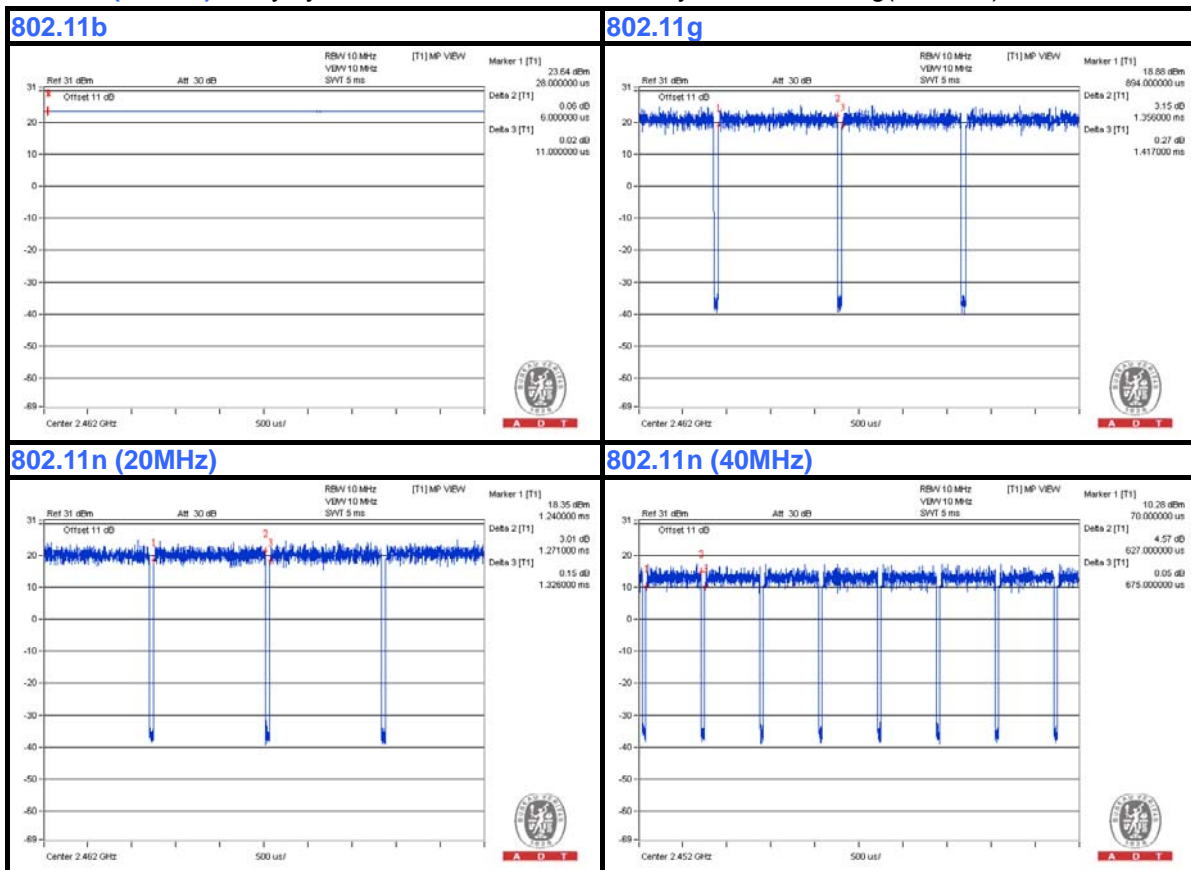

For 5GHz Band:

Duty cycle of test signal is < 98 %, duty factor is required

802.11a: Duty cycle = 1.300/1.413 = 0.920, Duty factor = $10 * \log(1/0.920) = 0.36$

802.11n (20MHz): Duty cycle = 1.250/1.350 = 0.926, Duty factor = $10 * \log(1/0.926) = 0.33$

802.11n (40MHz): Duty cycle = 0.612/0.662 = 0.924, Duty factor = $10 * \log(1/0.924) = 0.34$



3.4 DESCRIPTION OF SUPPORT UNITS

The EUT has been tested as an independent unit together with other necessary accessories or support units. The following support units or accessories were used to form a representative test configuration during the tests.

NO.	PRODUCT	BRAND	MODEL NO.	SERIAL NO.	FCC ID
1	NOTEBOOK	DELL	D531	CN-0XM006-48643 -81U-2610	QDS-BRCM1020
2	POE 1	InscapeData	IPW-2408	NA	NA
3	POE 2	EnGenius	EPE-48GR	NA	NA

NO.	SIGNAL CABLE DESCRIPTION OF THE ABOVE SUPPORT UNITS
1	10m RJ45 UTP cable
2	1.8m RJ45 UTP cable
3	1.8m RJ45 UTP cable

NOTE:

1. All power cords of the above support units are non-shielded (1.8 m).
2. Item 1 acted as a communication partner to transfer data.
3. Items 2-3 were provided by the client.

3.4.1 CONFIGURATION OF SYSTEM UNDER TEST

TEST MODE A

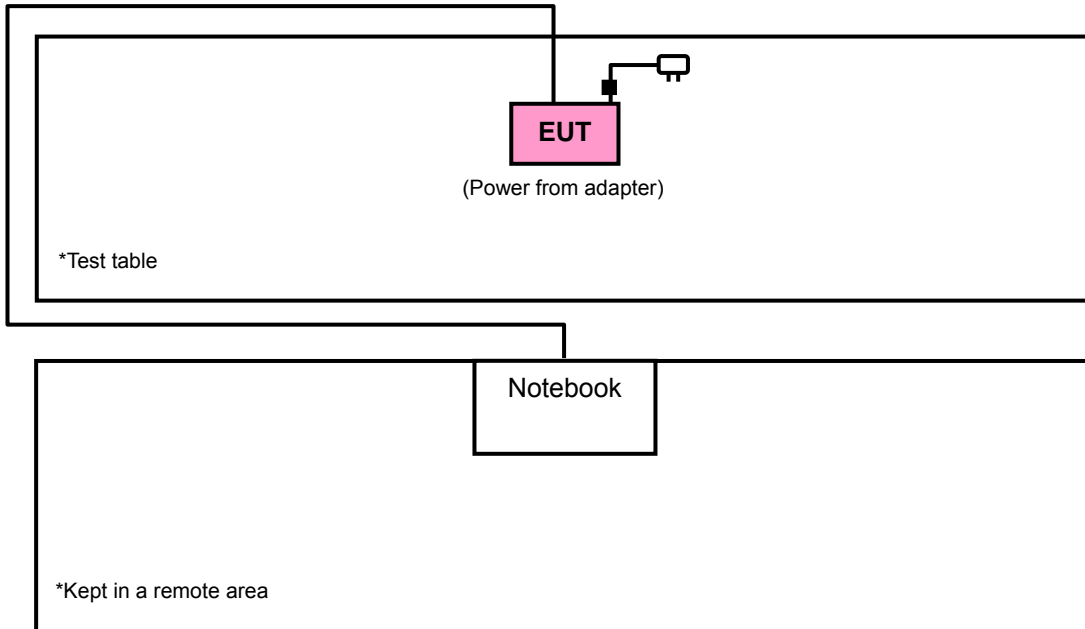

TEST MODE B, C

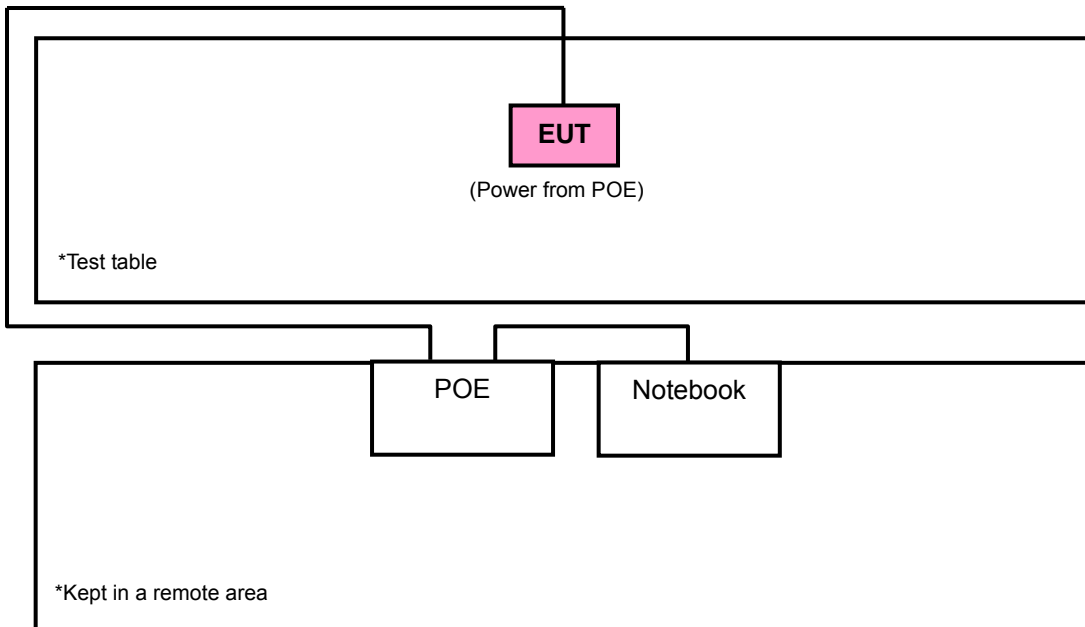

3.5 GENERAL DESCRIPTION OF APPLIED STANDARDS

The EUT is a RF Product. According to the specifications of the manufacturer, it must comply with the requirements of the following standards:

FCC Part 15, Subpart C (15.247)

558074 D01 DTS Meas Guidance v03r02

662911 D01 Multiple Transmitter Output v02r01

ANSI C63.10-2009

All test items have been performed and recorded as per the above standards.

NOTE: The EUT is also considered as a kind of computer peripheral, because the connection to computer is necessary for typical use. It has been verified to comply with the requirements of FCC Part 15, Subpart B, Class B (DoC). The test report has been issued separately.

4. TEST TYPES AND RESULTS (FOR 2.4GHz BAND)

4.1 RADIATED EMISSION AND BANDEDGE MEASUREMENT

4.1.1 LIMITS OF RADIATED EMISSION AND BANDEDGE MEASUREMENT

Radiated emissions which fall in the restricted bands must comply with the radiated emission limits specified as below table. Other emissions shall be at least 30dB below the highest level of the desired power:

FREQUENCIES (MHz)	FIELD STRENGTH (microvolts/meter)	MEASUREMENT DISTANCE (meters)
0.009 ~ 0.490	2400/F(kHz)	300
0.490 ~ 1.705	24000/F(kHz)	30
1.705 ~ 30.0	30	30
30 ~ 88	100	3
88 ~ 216	150	3
216 ~ 960	200	3
Above 960	500	3

NOTE:

1. The lower limit shall apply at the transition frequencies.
2. Emission level (dBuV/m) = 20 log Emission level (uV/m).
3. For frequencies above 1000MHz, the field strength limits are based on average detector, however, the peak field strength of any emission shall not exceed the maximum permitted average limits, specified above by more than 30dB under any condition of modulation.



4.1.2 TEST INSTRUMENTS

DESCRIPTION & MANUFACTURER	MODEL NO.	SERIAL NO.	DATE OF CALIBRATION	DUE DATE OF CALIBRATION
Test Receiver ROHDE & SCHWARZ	ESIB7	100187	Jan. 02, 2014	Jan. 01, 2015
Spectrum Analyzer ROHDE & SCHWARZ	FSP40	100039	Mar. 03, 2014	Mar. 02, 2015
BILOG Antenna SCHWARZBECK	VULB9168	9168-160	Feb. 26, 2014	Feb. 25, 2015
HORN Antenna SCHWARZBECK	9120D	209	Aug. 25, 2014	Aug. 24, 2015
HORN Antenna SCHWARZBECK	BBHA 9170	BBHA9170241	Feb. 17, 2014	Feb. 16, 2015
Preamplifier Agilent	8447D	2944A10738	Oct.18, 2014	Oct. 17, 2015
Preamplifier Agilent	8449B	3008A01964	Aug. 22, 2014	Aug. 21, 2015
RF signal cable HUBER+SUHNNER	SUCOFLEX 104	214378/4	Aug. 22, 2014	Aug. 21, 2015
RF signal cable HUBER+SUHNNER	SUCOFLEX 106	12738/6 +309224/4	Aug. 22, 2014	Aug. 21, 2015
Software BV ADT	ADT_Radiated_ V7.6.15.9.4	NA	NA	NA
Antenna Tower inn-co GmbH	MA 4000	013303	NA	NA
Antenna Tower Controller inn-co GmbH	CO2000	017303	NA	NA
Turn Table BV ADT	TT100	TT93021703	NA	NA
Turn Table Controller BV ADT	SC100	SC93021703	NA	NA
26GHz ~ 40GHz Amplifier	EM26400	815221	Oct. 18, 2014	Oct. 17, 2015
High Speed Peak Power Meter	ML2495A	0824011	Jul. 26, 2014	Jul. 25, 2015
Power Sensor	MA2411B	0738171	Jul. 26, 2014	Jul. 25, 2015

- NOTE:**
1. The calibration interval of the above test instruments is 12 months and the calibrations are traceable to NML/ROC and NIST/USA.
 2. The test was performed in HwaYa Chamber 3.
 3. The horn antenna and HP preamplifier (model: 8449B) are used only for the measurement of emission frequency above 1GHz if tested.
 4. The FCC Site Registration No. is 988962.
 5. The IC Site Registration No. is IC 7450F-3.

4.1.3 TEST PROCEDURES

- a. The EUT was placed on the top of a rotating table 0.8 meters above the ground at a 3 meters semi-anechoic chamber. The table was rotated 360 degrees to determine the position of the highest radiation.
- b. The EUT was set 3 meters away from the interference-receiving antenna, which was mounted on the top of a variable-height antenna tower.
- c. Height of receiving antenna is varied from one meter to four meters above the ground to determine the maximum value of the field strength. Both horizontal and vertical polarizations of the antenna are set to make the measurement.
- d. For each suspected emission, the EUT was arranged to its worst case and then the antenna was tuned to heights from 1 meter to 4 meters and the rotatable table was turned from 0 degrees to 360 degrees to find the maximum reading.
- e. The test-receiver system was set to Peak Detect Function and Specified Bandwidth with Maximum Hold Mode.
- f. If the emission level of the EUT in peak mode was lower than the limit specified, then testing could be stopped and the peak values of the EUT would be reported. Otherwise the emissions would be re-tested one by one using peak, quasi-peak or average method as specified and then reported in a data sheet.

NOTE:

1. The resolution bandwidth and video bandwidth of test receiver/spectrum analyzer is 120kHz for Quasi-peak detection at frequency below 1GHz.
2. The resolution bandwidth of test receiver/spectrum analyzer is 1MHz and video bandwidth is 3MHz for Peak detection at frequency above 1GHz.
3. The resolution bandwidth of test receiver/spectrum analyzer is 1MHz and the video bandwidth is $\geq 1/T$ (Duty cycle < 98%) or 10Hz(Duty cycle > 98%) for Average detection (AV) at frequency above 1GHz.
4. All modes of operation were investigated and the worst-case emissions are reported.

4.1.4 DEVIATION FROM TEST STANDARD

No deviation.

4.1.5 TEST SETUP

Frequency range 30MHz~1GHz

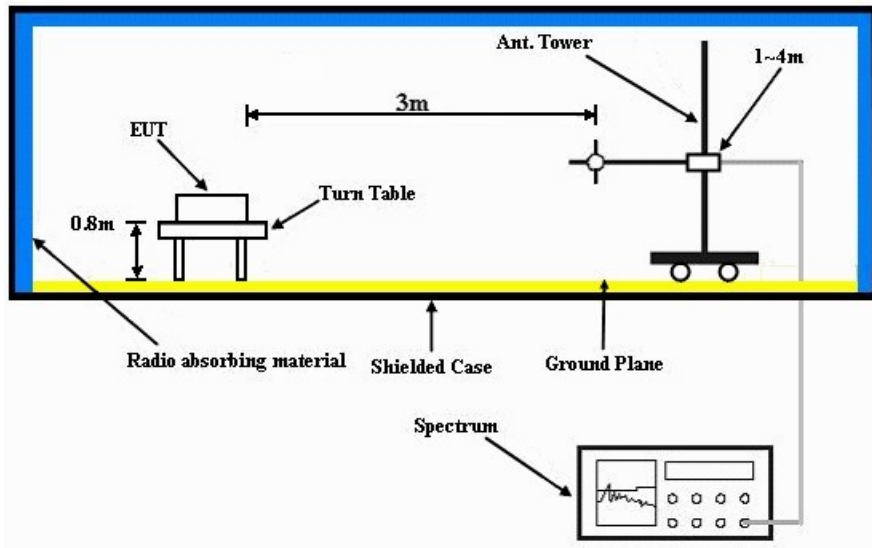

Frequency range above 1GHz

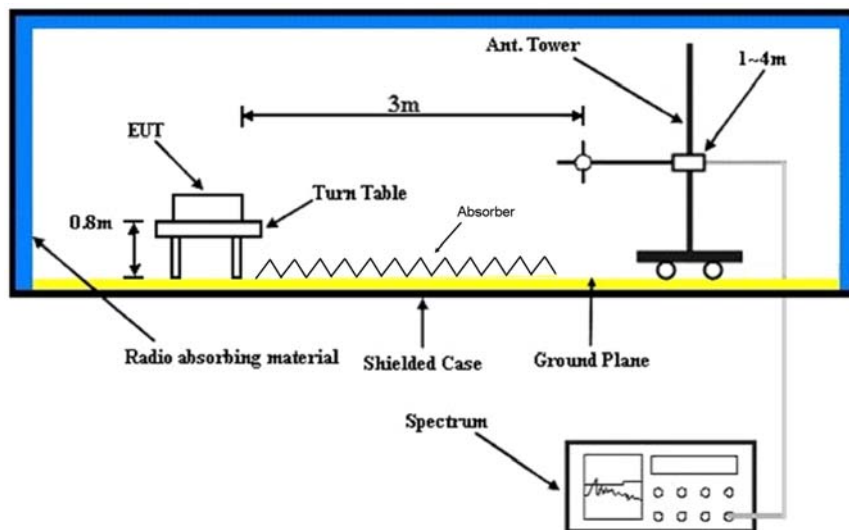

For the actual test configuration, please refer to the attached file (Test Setup Photo).

4.1.6 EUT OPERATING CONDITIONS

- a. Placed the EUT on the testing table.
- b. Prepared a notebook to act as communication partner and placed it outside of testing area.
- c. The communication partner connected with EUT via a RJ45 cable and run a test program (provided by manufacturer) to enable EUT under transmission condition continuously at specific channel frequency.
- d. The communication partner sent data to EUT by command "PING".



A D T

4.1.7 TEST RESULTS

ABOVE 1GHz DATA

802.11b

CHANNEL	TX Channel 1	DETECTOR FUNCTION	Peak (PK)
FREQUENCY RANGE	1GHz ~ 25GHz		Average (AV)

ANTENNA POLARITY & TEST DISTANCE: HORIZONTAL AT 3 M

NO.	FREQ. (MHz)	EMISSION LEVEL (dBuV/m)	LIMIT (dBuV/m)	MARGIN (dB)	ANTENNA HEIGHT (m)	TABLE ANGLE (Degree)	RAW VALUE (dBuV)	CORRECTION FACTOR (dB/m)
1	2390.00	63.8 PK	74.0	-10.2	1.33 H	80	30.60	33.20
2	2390.00	52.1 AV	54.0	-1.9	1.33 H	80	18.90	33.20
3	*2412.00	110.6 PK			1.22 H	61	77.30	33.30
4	*2412.00	106.6 AV			1.22 H	61	73.30	33.30
5	4824.00	50.8 PK	74.0	-23.2	1.24 H	135	44.70	6.10
6	4824.00	39.4 AV	54.0	-14.6	1.24 H	135	33.30	6.10

ANTENNA POLARITY & TEST DISTANCE: VERTICAL AT 3 M

NO.	FREQ. (MHz)	EMISSION LEVEL (dBuV/m)	LIMIT (dBuV/m)	MARGIN (dB)	ANTENNA HEIGHT (m)	TABLE ANGLE (Degree)	RAW VALUE (dBuV)	CORRECTION FACTOR (dB/m)
1	2390.00	58.9 PK	74.0	-15.1	1.14 V	126	25.70	33.20
2	2390.00	47.8 AV	54.0	-6.2	1.14 V	126	14.60	33.20
3	*2412.00	108.1 PK			1.14 V	126	74.80	33.30
4	*2412.00	104.3 AV			1.14 V	126	71.00	33.30
5	4874.00	49.8 PK	74.0	-24.2	1.24 V	194	43.60	6.20
6	4874.00	37.3 AV	54.0	-16.7	1.24 V	194	31.10	6.20

REMARKS:

1. Emission Level(dBuV/m) = Raw Value(dBuV) + Correction Factor(dB/m)
2. Correction Factor(dB/m) = Antenna Factor(dB/m) + Cable Factor(dB) - Pre-Amplifier Factor(dB)
3. The other emission levels were very low against the limit.
4. Margin value = Emission Level - Limit value
5. " * ": Fundamental frequency.



A D T

CHANNEL	TX Channel 6	DETECTOR FUNCTION	Peak (PK)
FREQUENCY RANGE	1GHz ~ 25GHz		Average (AV)

ANTENNA POLARITY & TEST DISTANCE: HORIZONTAL AT 3 M

NO.	FREQ. (MHz)	EMISSION LEVEL (dBuV/m)	LIMIT (dBuV/m)	MARGIN (dB)	ANTENNA HEIGHT (m)	TABLE ANGLE (Degree)	RAW VALUE (dBuV)	CORRECTION FACTOR (dB/m)
1	2390.00	62.9 PK	74.0	-11.1	1.30 H	79	29.70	33.20
2	2390.00	52.2 AV	54.0	-1.8	1.30 H	79	19.00	33.20
3	*2437.00	115.0 PK			1.27 H	81	81.60	33.40
4	*2437.00	110.9 AV			1.27 H	81	77.50	33.40
5	2483.50	61.5 PK	74.0	-12.5	1.26 H	83	28.10	33.40
6	2483.50	51.2 AV	54.0	-2.8	1.26 H	83	17.80	33.40
7	4874.00	53.4 PK	74.0	-20.6	1.37 H	77	47.20	6.20
8	4874.00	41.5 AV	54.0	-12.5	1.37 H	77	35.30	6.20

ANTENNA POLARITY & TEST DISTANCE: VERTICAL AT 3 M

NO.	FREQ. (MHz)	EMISSION LEVEL (dBuV/m)	LIMIT (dBuV/m)	MARGIN (dB)	ANTENNA HEIGHT (m)	TABLE ANGLE (Degree)	RAW VALUE (dBuV)	CORRECTION FACTOR (dB/m)
1	2390.00	61.0 PK	74.0	-13.0	1.16 V	131	27.80	33.20
2	2390.00	48.8 AV	54.0	-5.2	1.16 V	131	15.60	33.20
3	*2437.00	113.5 PK			1.11 V	127	80.10	33.40
4	*2437.00	109.1 AV			1.11 V	127	75.70	33.40
5	2483.50	58.4 PK	74.0	-15.6	1.17 V	131	25.00	33.40
6	2483.50	47.3 AV	54.0	-6.7	1.17 V	131	13.90	33.40
7	4874.00	51.9 PK	74.0	-22.1	1.00 V	222	45.70	6.20
8	4874.00	40.4 AV	54.0	-13.6	1.00 V	222	34.20	6.20

REMARKS:

1. Emission Level(dBuV/m) = Raw Value(dBuV) + Correction Factor(dB/m)
2. Correction Factor(dB/m) = Antenna Factor(dB/m) + Cable Factor(dB) – Pre-Amplifier Factor(dB)
3. The other emission levels were very low against the limit.
4. Margin value = Emission Level – Limit value
5. " * ": Fundamental frequency.



A D T

CHANNEL	TX Channel 11	DETECTOR FUNCTION	Peak (PK)
FREQUENCY RANGE	1GHz ~ 25GHz		Average (AV)

ANTENNA POLARITY & TEST DISTANCE: HORIZONTAL AT 3 M

NO.	FREQ. (MHz)	EMISSION LEVEL (dBuV/m)	LIMIT (dBuV/m)	MARGIN (dB)	ANTENNA HEIGHT (m)	TABLE ANGLE (Degree)	RAW VALUE (dBuV)	CORRECTION FACTOR (dB/m)
1	*2462.00	112.6 PK			1.26 H	82	79.30	33.30
2	*2462.00	108.9 AV			1.26 H	82	75.60	33.30
3	2483.50	62.4 PK	74.0	-11.6	1.26 H	82	29.00	33.40
4	2483.50	52.2 AV	54.0	-1.8	1.26 H	82	18.80	33.40
5	4924.00	51.6 PK	74.0	-22.4	1.36 H	146	45.30	6.30
6	4924.00	43.3 AV	54.0	-10.7	1.36 H	146	37.00	6.30

ANTENNA POLARITY & TEST DISTANCE: VERTICAL AT 3 M

NO.	FREQ. (MHz)	EMISSION LEVEL (dBuV/m)	LIMIT (dBuV/m)	MARGIN (dB)	ANTENNA HEIGHT (m)	TABLE ANGLE (Degree)	RAW VALUE (dBuV)	CORRECTION FACTOR (dB/m)
1	*2462.00	111.5 PK			1.10 V	124	78.20	33.30
2	*2462.00	107.1 AV			1.10 V	124	73.80	33.30
3	2483.50	60.3 PK	74.0	-13.7	1.09 V	126	26.90	33.40
4	2483.50	49.8 AV	54.0	-4.2	1.09 V	126	16.40	33.40
5	4924.00	51.1 PK	74.0	-22.9	1.08 V	237	44.80	6.30
6	4924.00	38.5 AV	54.0	-15.5	1.08 V	237	32.20	6.30

REMARKS:

1. Emission Level(dBuV/m) = Raw Value(dBuV) + Correction Factor(dB/m)
2. Correction Factor(dB/m) = Antenna Factor(dB/m) + Cable Factor(dB) – Pre-Amplifier Factor(dB)
3. The other emission levels were very low against the limit.
4. Margin value = Emission Level – Limit value
5. " * ": Fundamental frequency.



A D T

802.11g

CHANNEL	TX Channel 1	DETECTOR FUNCTION	Peak (PK)
FREQUENCY RANGE	1GHz ~ 25GHz		Average (AV)

ANTENNA POLARITY & TEST DISTANCE: HORIZONTAL AT 3 M

NO.	FREQ. (MHz)	EMISSION LEVEL (dBuV/m)	LIMIT (dBuV/m)	MARGIN (dB)	ANTENNA HEIGHT (m)	TABLE ANGLE (Degree)	RAW VALUE (dBuV)	CORRECTION FACTOR (dB/m)
1	2390.00	72.5 PK	74.0	-1.5	1.31 H	99	39.30	33.20
2	2390.00	52.3 AV	54.0	-1.7	1.31 H	99	19.10	33.20
3	*2412.00	111.0 PK			1.31 H	80	77.70	33.30
4	*2412.00	100.9 AV			1.31 H	80	67.60	33.30
5	4824.00	50.1 PK	74.0	-23.9	1.44 H	322	44.00	6.10
6	4824.00	38.1 AV	54.0	-15.9	1.44 H	322	32.00	6.10

ANTENNA POLARITY & TEST DISTANCE: VERTICAL AT 3 M

NO.	FREQ. (MHz)	EMISSION LEVEL (dBuV/m)	LIMIT (dBuV/m)	MARGIN (dB)	ANTENNA HEIGHT (m)	TABLE ANGLE (Degree)	RAW VALUE (dBuV)	CORRECTION FACTOR (dB/m)
1	2390.00	68.0 PK	74.0	-6.0	2.06 V	126	34.80	33.20
2	2390.00	52.2 AV	54.0	-1.8	2.06 V	126	19.00	33.20
3	*2412.00	108.1 PK			1.08 V	96	74.80	33.30
4	*2412.00	98.0 AV			1.08 V	96	64.70	33.30
5	4824.00	49.5 PK	74.0	-24.5	1.48 V	256	43.40	6.10
6	4824.00	37.7 AV	54.0	-16.3	1.48 V	256	31.60	6.10

REMARKS:

1. Emission Level(dBuV/m) = Raw Value(dBuV) + Correction Factor(dB/m)
2. Correction Factor(dB/m) = Antenna Factor(dB/m) + Cable Factor(dB) - Pre-Amplifier Factor(dB)
3. The other emission levels were very low against the limit.
4. Margin value = Emission Level - Limit value
5. " * ": Fundamental frequency.



A D T

CHANNEL	TX Channel 6	DETECTOR FUNCTION	Peak (PK)
FREQUENCY RANGE	1GHz ~ 25GHz		Average (AV)

ANTENNA POLARITY & TEST DISTANCE: HORIZONTAL AT 3 M

NO.	FREQ. (MHz)	EMISSION LEVEL (dBuV/m)	LIMIT (dBuV/m)	MARGIN (dB)	ANTENNA HEIGHT (m)	TABLE ANGLE (Degree)	RAW VALUE (dBuV)	CORRECTION FACTOR (dB/m)
1	2390.00	70.6 PK	74.0	-3.4	1.33 H	100	37.40	33.20
2	2390.00	52.4 AV	54.0	-1.6	1.33 H	100	19.20	33.20
3	*2437.00	118.2 PK			1.28 H	81	84.80	33.40
4	*2437.00	107.7 AV			1.28 H	81	74.30	33.40
5	2483.50	68.9 PK	74.0	-5.1	1.24 H	81	35.50	33.40
6	2483.50	51.1 AV	54.0	-2.9	1.24 H	81	17.70	33.40
7	4874.00	51.8 PK	74.0	-22.2	1.38 H	163	45.60	6.20
8	4874.00	39.4 AV	54.0	-14.6	1.38 H	163	33.20	6.20

ANTENNA POLARITY & TEST DISTANCE: VERTICAL AT 3 M

NO.	FREQ. (MHz)	EMISSION LEVEL (dBuV/m)	LIMIT (dBuV/m)	MARGIN (dB)	ANTENNA HEIGHT (m)	TABLE ANGLE (Degree)	RAW VALUE (dBuV)	CORRECTION FACTOR (dB/m)
1	2390.00	66.3 PK	74.0	-7.7	2.06 V	130	33.10	33.20
2	2390.00	49.9 AV	54.0	-4.1	2.06 V	130	16.70	33.20
3	*2437.00	114.0 PK			1.66 V	126	80.60	33.40
4	*2437.00	104.5 AV			1.66 V	126	71.10	33.40
5	2483.50	66.4 PK	74.0	-7.6	1.61 V	126	33.00	33.40
6	2483.50	50.5 AV	54.0	-3.5	1.61 V	126	17.10	33.40
7	4874.00	49.6 PK	74.0	-24.4	1.35 V	162	43.40	6.20
8	4874.00	37.9 AV	54.0	-16.1	1.35 V	162	31.70	6.20

REMARKS:

1. Emission Level(dBuV/m) = Raw Value(dBuV) + Correction Factor(dB/m)
2. Correction Factor(dB/m) = Antenna Factor(dB/m) + Cable Factor(dB)
– Pre-Amplifier Factor(dB)
3. The other emission levels were very low against the limit.
4. Margin value = Emission Level – Limit value
5. " * ": Fundamental frequency.



A D T

CHANNEL	TX Channel 11	DETECTOR FUNCTION	Peak (PK)
FREQUENCY RANGE	1GHz ~ 25GHz		Average (AV)

ANTENNA POLARITY & TEST DISTANCE: HORIZONTAL AT 3 M

NO.	FREQ. (MHz)	EMISSION LEVEL (dBuV/m)	LIMIT (dBuV/m)	MARGIN (dB)	ANTENNA HEIGHT (m)	TABLE ANGLE (Degree)	RAW VALUE (dBuV)	CORRECTION FACTOR (dB/m)
1	*2462.00	111.9 PK			1.26 H	79	78.60	33.30
2	*2462.00	100.8 AV			1.26 H	79	67.50	33.30
3	2483.50	72.4 PK	74.0	-1.6	1.24 H	81	39.00	33.40
4	2483.50	51.9 AV	54.0	-2.1	1.24 H	81	18.50	33.40
5	4924.00	49.1 PK	74.0	-24.9	1.31 H	281	42.80	6.30
6	4924.00	36.4 AV	54.0	-17.6	1.31 H	281	30.10	6.30

ANTENNA POLARITY & TEST DISTANCE: VERTICAL AT 3 M

NO.	FREQ. (MHz)	EMISSION LEVEL (dBuV/m)	LIMIT (dBuV/m)	MARGIN (dB)	ANTENNA HEIGHT (m)	TABLE ANGLE (Degree)	RAW VALUE (dBuV)	CORRECTION FACTOR (dB/m)
1	*2462.00	107.4 PK			1.30 V	125	74.10	33.30
2	*2462.00	97.3 AV			1.30 V	125	64.00	33.30
3	2483.50	67.3 PK	74.0	-6.7	1.06 V	125	33.90	33.40
4	2483.50	50.8 AV	54.0	-3.2	1.06 V	125	17.40	33.40
5	4924.00	49.3 PK	74.0	-24.7	1.10 V	239	43.00	6.30
6	4924.00	36.6 AV	54.0	-17.4	1.10 V	239	30.30	6.30

REMARKS:

- Emission Level(dBuV/m) = Raw Value(dBuV) + Correction Factor(dB/m)
- Correction Factor(dB/m) = Antenna Factor(dB/m) + Cable Factor(dB)
– Pre-Amplifier Factor(dB)
- The other emission levels were very low against the limit.
- Margin value = Emission Level – Limit value
- " * ": Fundamental frequency.



A D T

802.11n (20MHz)

CHANNEL	TX Channel 1	DETECTOR FUNCTION	Peak (PK)
FREQUENCY RANGE	1GHz ~ 25GHz		Average (AV)

ANTENNA POLARITY & TEST DISTANCE: HORIZONTAL AT 3 M

NO.	FREQ. (MHz)	EMISSION LEVEL (dBuV/m)	LIMIT (dBuV/m)	MARGIN (dB)	ANTENNA HEIGHT (m)	TABLE ANGLE (Degree)	RAW VALUE (dBuV)	CORRECTION FACTOR (dB/m)
1	2390.00	70.7 PK	74.0	-3.3	1.32 H	78	37.50	33.20
2	2390.00	52.5 AV	54.0	-1.5	1.32 H	78	19.30	33.20
3	*2412.00	109.5 PK			1.00 H	81	76.20	33.30
4	*2412.00	99.8 AV			1.00 H	81	66.50	33.30
5	4824.00	49.1 PK	74.0	-24.9	1.44 H	330	43.00	6.10
6	4824.00	36.2 AV	54.0	-17.8	1.44 H	330	30.10	6.10

ANTENNA POLARITY & TEST DISTANCE: VERTICAL AT 3 M

NO.	FREQ. (MHz)	EMISSION LEVEL (dBuV/m)	LIMIT (dBuV/m)	MARGIN (dB)	ANTENNA HEIGHT (m)	TABLE ANGLE (Degree)	RAW VALUE (dBuV)	CORRECTION FACTOR (dB/m)
1	2390.00	69.6 PK	74.0	-4.4	1.14 V	127	36.40	33.20
2	2390.00	51.6 AV	54.0	-2.4	1.14 V	127	18.40	33.20
3	*2412.00	108.6 PK			1.12 V	123	75.30	33.30
4	*2412.00	98.3 AV			1.12 V	123	65.00	33.30
5	4924.00	49.0 PK	74.0	-25.0	1.22 V	272	42.70	6.30
6	4924.00	35.8 AV	54.0	-18.2	1.22 V	272	29.50	6.30

REMARKS:

1. Emission Level(dBuV/m) = Raw Value(dBuV) + Correction Factor(dB/m)
2. Correction Factor(dB/m) = Antenna Factor(dB/m) + Cable Factor(dB) - Pre-Amplifier Factor(dB)
3. The other emission levels were very low against the limit.
4. Margin value = Emission Level - Limit value
5. " * ": Fundamental frequency.



A D T

CHANNEL	TX Channel 6	DETECTOR FUNCTION	Peak (PK)
FREQUENCY RANGE	1GHz ~ 25GHz		Average (AV)

ANTENNA POLARITY & TEST DISTANCE: HORIZONTAL AT 3 M

NO.	FREQ. (MHz)	EMISSION LEVEL (dBuV/m)	LIMIT (dBuV/m)	MARGIN (dB)	ANTENNA HEIGHT (m)	TABLE ANGLE (Degree)	RAW VALUE (dBuV)	CORRECTION FACTOR (dB/m)
1	2390.00	71.3 PK	74.0	-2.7	1.28 H	79	38.10	33.20
2	2390.00	52.7 AV	54.0	-1.3	1.28 H	79	19.50	33.20
3	*2437.00	116.8 PK			1.24 H	80	83.40	33.40
4	*2437.00	106.2 AV			1.24 H	80	72.80	33.40
5	2483.50	70.4 PK	74.0	-3.6	1.22 H	80	37.00	33.40
6	2483.50	51.6 AV	54.0	-2.4	1.22 H	80	18.20	33.40
7	4874.00	51.8 PK	74.0	-22.2	1.40 H	155	45.60	6.20
8	4874.00	40.4 AV	54.0	-13.6	1.40 H	155	34.20	6.20

ANTENNA POLARITY & TEST DISTANCE: VERTICAL AT 3 M

NO.	FREQ. (MHz)	EMISSION LEVEL (dBuV/m)	LIMIT (dBuV/m)	MARGIN (dB)	ANTENNA HEIGHT (m)	TABLE ANGLE (Degree)	RAW VALUE (dBuV)	CORRECTION FACTOR (dB/m)
1	2390.00	72.0 PK	74.0	-2.0	1.14 V	126	38.80	33.20
2	2390.00	51.8 AV	54.0	-2.2	1.14 V	126	18.60	33.20
3	*2437.00	114.6 PK			1.10 V	124	81.20	33.40
4	*2437.00	104.6 AV			1.10 V	124	71.20	33.40
5	2483.50	66.0 PK	74.0	-8.0	1.09 V	127	32.60	33.40
6	2483.50	51.4 AV	54.0	-2.6	1.09 V	127	18.00	33.40
7	4874.00	49.3 PK	74.0	-24.7	1.32 V	155	43.10	6.20
8	4874.00	38.2 AV	54.0	-15.8	1.32 V	155	32.00	6.20

REMARKS:

1. Emission Level(dBuV/m) = Raw Value(dBuV) + Correction Factor(dB/m)
2. Correction Factor(dB/m) = Antenna Factor(dB/m) + Cable Factor(dB)
- Pre-Amplifier Factor(dB)
3. The other emission levels were very low against the limit.
4. Margin value = Emission Level – Limit value
5. " * ": Fundamental frequency.



A D T

CHANNEL	TX Channel 11	DETECTOR FUNCTION	Peak (PK)
FREQUENCY RANGE	1GHz ~ 25GHz		Average (AV)

ANTENNA POLARITY & TEST DISTANCE: HORIZONTAL AT 3 M

NO.	FREQ. (MHz)	EMISSION LEVEL (dBuV/m)	LIMIT (dBuV/m)	MARGIN (dB)	ANTENNA HEIGHT (m)	TABLE ANGLE (Degree)	RAW VALUE (dBuV)	CORRECTION FACTOR (dB/m)
1	*2462.00	108.4 PK			1.21 H	80	75.10	33.30
2	*2462.00	98.4 AV			1.21 H	80	65.10	33.30
3	2483.50	72.2 PK	74.0	-1.8	1.18 H	82	38.80	33.40
4	2483.50	51.1 AV	54.0	-2.9	1.18 H	82	17.70	33.40
5	4924.00	49.9 PK	74.0	-24.1	1.31 H	244	43.60	6.30
6	4924.00	36.9 AV	54.0	-17.1	1.31 H	244	30.60	6.30

ANTENNA POLARITY & TEST DISTANCE: VERTICAL AT 3 M

NO.	FREQ. (MHz)	EMISSION LEVEL (dBuV/m)	LIMIT (dBuV/m)	MARGIN (dB)	ANTENNA HEIGHT (m)	TABLE ANGLE (Degree)	RAW VALUE (dBuV)	CORRECTION FACTOR (dB/m)
1	*2462.00	108.9 PK			1.10 V	125	75.60	33.30
2	*2462.00	98.8 AV			1.10 V	125	65.50	33.30
3	2483.50	68.6 PK	74.0	-5.4	1.11 V	140	35.20	33.40
4	2483.50	50.0 AV	54.0	-4.0	1.11 V	140	16.60	33.40
5	4924.00	49.0 PK	74.0	-25.0	1.20 V	233	42.70	6.30
6	4924.00	36.0 AV	54.0	-18.0	1.20 V	233	29.70	6.30

REMARKS:

1. Emission Level(dBuV/m) = Raw Value(dBuV) + Correction Factor(dB/m)
2. Correction Factor(dB/m) = Antenna Factor(dB/m) + Cable Factor(dB)
– Pre-Amplifier Factor(dB)
3. The other emission levels were very low against the limit.
4. Margin value = Emission Level – Limit value
5. " * ": Fundamental frequency.



A D T

802.11n (40MHz)

CHANNEL	TX Channel 3	DETECTOR FUNCTION	Peak (PK)
FREQUENCY RANGE	1GHz ~ 25GHz		Average (AV)

ANTENNA POLARITY & TEST DISTANCE: HORIZONTAL AT 3 M

NO.	FREQ. (MHz)	EMISSION LEVEL (dBuV/m)	LIMIT (dBuV/m)	MARGIN (dB)	ANTENNA HEIGHT (m)	TABLE ANGLE (Degree)	RAW VALUE (dBuV)	CORRECTION FACTOR (dB/m)
1	2390.00	71.0 PK	74.0	-3.0	1.32 H	82	37.80	33.20
2	2390.00	52.7 AV	54.0	-1.3	1.32 H	82	19.50	33.20
3	*2422.00	101.9 PK			1.32 H	101	68.60	33.30
4	*2422.00	92.6 AV			1.32 H	101	59.30	33.30
5	4844.00	48.9 PK	74.0	-25.1	1.26 H	90	42.80	6.10
6	4844.00	35.7 AV	54.0	-18.3	1.26 H	90	29.60	6.10

ANTENNA POLARITY & TEST DISTANCE: VERTICAL AT 3 M

NO.	FREQ. (MHz)	EMISSION LEVEL (dBuV/m)	LIMIT (dBuV/m)	MARGIN (dB)	ANTENNA HEIGHT (m)	TABLE ANGLE (Degree)	RAW VALUE (dBuV)	CORRECTION FACTOR (dB/m)
1	2390.00	70.3 PK	74.0	-3.7	1.12 V	124	37.10	33.20
2	2390.00	52.5 AV	54.0	-1.5	1.12 V	124	19.30	33.20
3	*2422.00	102.1 PK			1.12 V	124	68.80	33.30
4	*2422.00	91.7 AV			1.12 V	124	58.40	33.30
5	4844.00	48.6 PK	74.0	-25.4	1.31 V	260	42.50	6.10
6	4844.00	35.4 AV	54.0	-18.6	1.31 V	260	29.30	6.10

REMARKS:

1. Emission Level(dBuV/m) = Raw Value(dBuV) + Correction Factor(dB/m)
2. Correction Factor(dB/m) = Antenna Factor(dB/m) + Cable Factor(dB) - Pre-Amplifier Factor(dB)
3. The other emission levels were very low against the limit.
4. Margin value = Emission Level - Limit value
5. " * ": Fundamental frequency.



A D T

CHANNEL	TX Channel 6	DETECTOR FUNCTION	Peak (PK)
FREQUENCY RANGE	1GHz ~ 25GHz		Average (AV)

ANTENNA POLARITY & TEST DISTANCE: HORIZONTAL AT 3 M

NO.	FREQ. (MHz)	EMISSION LEVEL (dBuV/m)	LIMIT (dBuV/m)	MARGIN (dB)	ANTENNA HEIGHT (m)	TABLE ANGLE (Degree)	RAW VALUE (dBuV)	CORRECTION FACTOR (dB/m)
1	2390.00	69.9 PK	74.0	-4.1	1.32 H	101	36.70	33.20
2	2390.00	52.7 AV	54.0	-1.3	1.32 H	101	19.50	33.20
3	*2437.00	108.2 PK			1.95 H	81	74.80	33.40
4	*2437.00	98.5 AV			1.95 H	81	65.10	33.40
5	2483.50	67.8 PK	74.0	-6.2	1.23 H	83	34.40	33.40
6	2483.50	48.7 AV	54.0	-5.3	1.23 H	83	15.30	33.40
7	4874.00	49.4 PK	74.0	-24.6	1.53 H	106	43.20	6.20
8	4874.00	36.6 AV	54.0	-17.4	1.53 H	106	30.40	6.20

ANTENNA POLARITY & TEST DISTANCE: VERTICAL AT 3 M

NO.	FREQ. (MHz)	EMISSION LEVEL (dBuV/m)	LIMIT (dBuV/m)	MARGIN (dB)	ANTENNA HEIGHT (m)	TABLE ANGLE (Degree)	RAW VALUE (dBuV)	CORRECTION FACTOR (dB/m)
1	2390.00	69.7 PK	74.0	-4.3	1.12 V	126	36.50	33.20
2	2390.00	52.1 AV	54.0	-1.9	1.12 V	126	18.90	33.20
3	*2437.00	106.1 PK			1.37 V	125	72.70	33.40
4	*2437.00	96.1 AV			1.37 V	125	62.70	33.40
5	2483.50	65.5 PK	74.0	-8.5	1.33 V	123	32.10	33.40
6	2483.50	46.6 AV	54.0	-7.4	1.33 V	123	13.20	33.40
7	4874.00	49.2 PK	74.0	-24.8	1.41 V	193	43.00	6.20
8	4874.00	35.7 AV	54.0	-18.3	1.41 V	193	29.50	6.20

REMARKS:

1. Emission Level(dBuV/m) = Raw Value(dBuV) + Correction Factor(dB/m)
2. Correction Factor(dB/m) = Antenna Factor(dB/m) + Cable Factor(dB) – Pre-Amplifier Factor(dB)
3. The other emission levels were very low against the limit.
4. Margin value = Emission Level – Limit value
5. " * ": Fundamental frequency.



A D T

CHANNEL	TX Channel 9	DETECTOR FUNCTION	Peak (PK)
FREQUENCY RANGE	1GHz ~ 25GHz		Average (AV)

ANTENNA POLARITY & TEST DISTANCE: HORIZONTAL AT 3 M

NO.	FREQ. (MHz)	EMISSION LEVEL (dBuV/m)	LIMIT (dBuV/m)	MARGIN (dB)	ANTENNA HEIGHT (m)	TABLE ANGLE (Degree)	RAW VALUE (dBuV)	CORRECTION FACTOR (dB/m)
1	*2452.00	104.7 PK			1.26 H	80	71.30	33.40
2	*2452.00	94.1 AV			1.26 H	80	60.70	33.40
3	2483.50	72.0 PK	74.0	-2.0	1.28 H	263	38.60	33.40
4	2483.50	52.2 AV	54.0	-1.8	1.28 H	263	18.80	33.40
5	4904.00	48.6 PK	74.0	-25.4	1.28 H	99	42.50	6.10
6	4904.00	35.5 AV	54.0	-18.5	1.28 H	99	29.40	6.10

ANTENNA POLARITY & TEST DISTANCE: VERTICAL AT 3 M

NO.	FREQ. (MHz)	EMISSION LEVEL (dBuV/m)	LIMIT (dBuV/m)	MARGIN (dB)	ANTENNA HEIGHT (m)	TABLE ANGLE (Degree)	RAW VALUE (dBuV)	CORRECTION FACTOR (dB/m)
1	*2452.00	102.9 PK			1.11 V	122	69.50	33.40
2	*2452.00	92.1 AV			1.11 V	122	58.70	33.40
3	2483.50	67.0 PK	74.0	-7.0	1.08 V	126	33.60	33.40
4	2483.50	49.9 AV	54.0	-4.1	1.08 V	126	16.50	33.40
5	4904.00	48.3 PK	74.0	-25.7	1.30 V	231	42.20	6.10
6	4904.00	35.2 AV	54.0	-18.8	1.30 V	231	29.10	6.10

REMARKS:

1. Emission Level(dBuV/m) = Raw Value(dBuV) + Correction Factor(dB/m)
2. Correction Factor(dB/m) = Antenna Factor(dB/m) + Cable Factor(dB) – Pre-Amplifier Factor(dB)
3. The other emission levels were very low against the limit.
4. Margin value = Emission Level – Limit value
5. " * ": Fundamental frequency.



A D T

BELOW 1GHz WORST-CASE DATA

802.11b

CHANNEL	TX Channel 1	DETECTOR FUNCTION	Quasi-Peak (QP)
FREQUENCY RANGE	30MHz ~ 1GHz		
TEST MODE	A		

ANTENNA POLARITY & TEST DISTANCE: HORIZONTAL AT 3 M

NO.	FREQ. (MHz)	EMISSION LEVEL (dBuV/m)	LIMIT (dBuV/m)	MARGIN (dB)	ANTENNA HEIGHT (m)	TABLE ANGLE (Degree)	RAW VALUE (dBuV)	CORRECTION FACTOR (dB/m)
1	57.12	33.5 QP	40.0	-6.5	2.00 H	144	48.20	-14.70
2	96.01	28.6 QP	43.5	-14.9	2.00 H	226	48.00	-19.40
3	158.22	28.4 QP	43.5	-15.1	1.26 H	258	42.30	-13.90
4	249.60	29.3 QP	46.0	-16.7	1.01 H	83	43.60	-14.30
5	375.98	29.1 QP	46.0	-16.9	1.01 H	203	39.90	-10.80
6	552.91	31.8 QP	46.0	-14.2	1.51 H	133	39.30	-7.50

ANTENNA POLARITY & TEST DISTANCE: VERTICAL AT 3 M

NO.	FREQ. (MHz)	EMISSION LEVEL (dBuV/m)	LIMIT (dBuV/m)	MARGIN (dB)	ANTENNA HEIGHT (m)	TABLE ANGLE (Degree)	RAW VALUE (dBuV)	CORRECTION FACTOR (dB/m)
1	35.73	31.8 QP	40.0	-8.2	1.00 V	219	47.50	-15.70
2	158.22	28.0 QP	43.5	-15.5	1.00 V	123	41.90	-13.90
3	249.60	25.3 QP	46.0	-20.7	1.99 V	203	39.60	-14.30
4	375.98	28.7 QP	46.0	-17.3	1.99 V	242	39.50	-10.80
5	500.42	35.7 QP	46.0	-10.3	1.24 V	83	44.10	-8.40
6	681.24	28.0 QP	46.0	-18.0	1.49 V	331	32.80	-4.80

REMARKS:

1. Emission Level(dBuV/m) = Raw Value(dBuV) + Correction Factor(dB/m)
2. Correction Factor(dB/m) = Antenna Factor(dB/m) + Cable Factor(dB) – Pre-Amplifier Factor(dB)
3. The other emission levels were very low against the limit.
4. Margin value = Emission Level – Limit value



A D T

CHANNEL	TX Channel 1	DETECTOR FUNCTION	Quasi-Peak (QP)
FREQUENCY RANGE	30MHz ~ 1GHz		
TEST MODE	B		

ANTENNA POLARITY & TEST DISTANCE: HORIZONTAL AT 3 M

NO.	FREQ. (MHz)	EMISSION LEVEL (dBuV/m)	LIMIT (dBuV/m)	MARGIN (dB)	ANTENNA HEIGHT (m)	TABLE ANGLE (Degree)	RAW VALUE (dBuV)	CORRECTION FACTOR (dB/m)
1	70.73	31.3 QP	40.0	-8.7	1.01 H	173	47.70	-16.40
2	109.62	32.5 QP	43.5	-11.0	1.01 H	111	49.90	-17.40
3	375.98	30.8 QP	46.0	-15.2	1.01 H	14	41.60	-10.80
4	552.91	29.3 QP	46.0	-16.7	1.01 H	98	36.80	-7.50
5	799.84	34.3 QP	46.0	-11.7	1.95 H	172	36.50	-2.20
6	1000.00	32.1 QP	54.0	-21.9	1.01 H	2	31.30	0.80

ANTENNA POLARITY & TEST DISTANCE: VERTICAL AT 3 M

NO.	FREQ. (MHz)	EMISSION LEVEL (dBuV/m)	LIMIT (dBuV/m)	MARGIN (dB)	ANTENNA HEIGHT (m)	TABLE ANGLE (Degree)	RAW VALUE (dBuV)	CORRECTION FACTOR (dB/m)
1	68.79	31.2 QP	40.0	-8.8	1.00 V	12	47.30	-16.10
2	107.67	32.7 QP	43.5	-10.8	1.00 V	116	50.40	-17.70
3	375.98	30.8 QP	46.0	-15.2	1.24 V	16	41.60	-10.80
4	560.69	29.1 QP	46.0	-16.9	1.00 V	12	36.40	-7.30
5	799.84	34.7 QP	46.0	-11.3	1.00 V	158	36.90	-2.20
6	1000.00	32.9 QP	54.0	-21.1	1.00 V	12	32.10	0.80

REMARKS:

1. Emission Level(dBuV/m) = Raw Value(dBuV) + Correction Factor(dB/m)
2. Correction Factor(dB/m) = Antenna Factor(dB/m) + Cable Factor(dB)
– Pre-Amplifier Factor(dB)
3. The other emission levels were very low against the limit.
4. Margin value = Emission Level – Limit value



A D T

CHANNEL	TX Channel 1	DETECTOR FUNCTION	Quasi-Peak (QP)
FREQUENCY RANGE	30MHz ~ 1GHz		
TEST MODE	C		

ANTENNA POLARITY & TEST DISTANCE: HORIZONTAL AT 3 M								
NO.	FREQ. (MHz)	EMISSION LEVEL (dBuV/m)	LIMIT (dBuV/m)	MARGIN (dB)	ANTENNA HEIGHT (m)	TABLE ANGLE (Degree)	RAW VALUE (dBuV)	CORRECTION FACTOR (dB/m)
1	57.12	32.4 QP	40.0	-7.6	2.00 H	94	47.10	-14.70
2	158.22	28.3 QP	43.5	-15.2	1.01 H	253	42.20	-13.90
3	249.60	24.1 QP	46.0	-21.9	1.01 H	67	38.40	-14.30
4	375.98	28.4 QP	46.0	-17.6	1.01 H	200	39.20	-10.80
5	599.58	31.2 QP	46.0	-14.8	1.26 H	191	37.40	-6.20
6	799.84	41.3 QP	46.0	-4.7	1.01 H	193	43.50	-2.20
ANTENNA POLARITY & TEST DISTANCE: VERTICAL AT 3 M								
NO.	FREQ. (MHz)	EMISSION LEVEL (dBuV/m)	LIMIT (dBuV/m)	MARGIN (dB)	ANTENNA HEIGHT (m)	TABLE ANGLE (Degree)	RAW VALUE (dBuV)	CORRECTION FACTOR (dB/m)
1	57.12	29.1 QP	40.0	-10.9	1.49 V	337	43.80	-14.70
2	158.22	25.6 QP	43.5	-17.9	1.00 V	94	39.50	-13.90
3	249.60	22.9 QP	46.0	-23.1	1.49 V	139	37.20	-14.30
4	375.98	25.7 QP	46.0	-20.3	1.24 V	302	36.50	-10.80
5	500.42	32.5 QP	46.0	-13.5	1.00 V	234	40.90	-8.40
6	549.03	29.3 QP	46.0	-16.7	1.49 V	151	36.90	-7.60

REMARKS:

1. Emission Level(dBuV/m) = Raw Value(dBuV) + Correction Factor(dB/m)
2. Correction Factor(dB/m) = Antenna Factor(dB/m) + Cable Factor(dB)
– Pre-Amplifier Factor(dB)
3. The other emission levels were very low against the limit.
4. Margin value = Emission Level – Limit value



A D T

4.2 CONDUCTED EMISSION MEASUREMENT

4.2.1 LIMITS OF CONDUCTED EMISSION MEASUREMENT

FREQUENCY OF EMISSION (MHz)	CONDUCTED LIMIT (dB μ V)	
	Quasi-peak	Average
0.15 ~ 0.5	66 to 56	56 to 46
0.5 ~ 5	56	46
5 ~ 30	60	50

- NOTE:** 1. The lower limit shall apply at the transition frequencies.
2. The limit decreases in line with the logarithm of the frequency in the range of 0.15 to 0.50MHz.
3. All emanations from a class A/B digital device or system, including any network of conductors and apparatus connected thereto, shall not exceed the level of field strengths specified above.

4.2.2 TEST INSTRUMENTS

DESCRIPTION & MANUFACTURER	MODEL NO.	SERIAL NO.	DATE OF CALIBRATION	DUE DATE OF CALIBRATION
Test Receiver ROHDE & SCHWARZ	ESCI	100612	Sep. 30, 2014	Sep. 29, 2015
RF signal cable Woken	5D-FB	Cable-HYC01-01	Dec. 27, 2013	Dec. 26, 2014
LISN ROHDE & SCHWARZ (EUT)	ESH3-Z5	835239/001	Feb. 13, 2014	Feb. 12, 2015
LISN ROHDE & SCHWARZ (Peripheral)	ESH3-Z5	100311	Jul. 21, 2014	Jul. 20, 2015
Software ADT	BV ADT_Cond_ V7.3.7.3	NA	NA	NA

- NOTE:** 1. The calibration interval of the above test instruments is 12 months and the calibrations are traceable to NML/ROC and NIST/USA.
2. The test was performed in HwaYa Shielded Room 1.
3. The VCCI Site Registration No. is C-2040.

4.2.3 TEST PROCEDURES

- a. The EUT was placed 0.4 meters from the conducting wall of the shielded room with EUT being connected to the power mains through a line impedance stabilization network (LISN). Other support units were connected to the power mains through another LISN. The two LISNs provide 50 ohm/ 50uH of coupling impedance for the measuring instrument.
- b. Both lines of the power mains connected to the EUT were checked for maximum conducted interference.
- c. The frequency range from 150kHz to 30MHz was searched. Emission levels under (Limit - 20dB) was not recorded.

NOTE: All modes of operation were investigated and the worst-case emissions are reported.

4.2.4 DEVIATION FROM TEST STANDARD

No deviation.

4.2.5 TEST SETUP

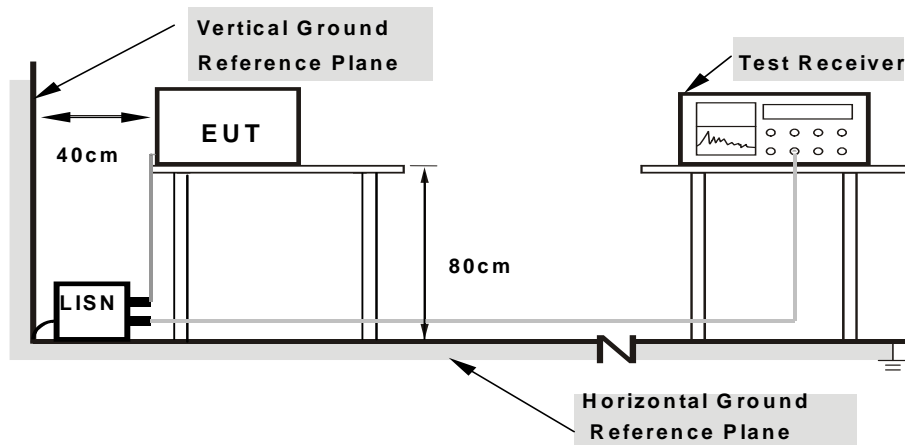

- Note:**
1. Support units were connected to second LISN.
 2. Both of LISNs (AMN) are 80 cm from EUT and at least 80 from other units and other metal planes

For the actual test configuration, please refer to the attached file (Test Setup Photo).

4.2.6 EUT OPERATING CONDITIONS

Same as 4.1.6.

4.2.7 TEST RESULTS

CONDUCTED WORST-CASE DATA : 802.11b

PHASE	Line 1	6dB BANDWIDTH	9kHz
TEST MODE	A		

No	Freq. [MHz]	Corr. Factor (dB)	Reading Value		Emission Level		Limit		Margin	
			[dB (uV)]		[dB (uV)]		[dB (uV)]		(dB)	
			Q.P.	AV.	Q.P.	AV.	Q.P.	AV.	Q.P.	AV.
1	0.16173	0.11	47.05	32.48	47.16	32.59	65.37	55.37	-18.22	-22.79
2	0.27512	0.10	37.88	28.65	37.98	28.75	60.96	50.96	-22.98	-22.21
3	0.52821	0.13	41.26	34.03	41.39	34.16	56.00	46.00	-14.61	-11.84
4	4.19294	0.27	38.72	32.96	38.99	33.23	56.00	46.00	-17.01	-12.77
5	6.76963	0.39	38.05	31.09	38.44	31.48	60.00	50.00	-21.56	-18.52
6	9.37369	0.52	36.89	30.21	37.41	30.73	60.00	50.00	-22.59	-19.27

REMARKS:

1. Q.P. and AV. are abbreviations of quasi-peak and average individually.
2. The emission levels of other frequencies were very low against the limit.
3. Margin value = Emission level - Limit value
4. Correction factor = Insertion loss + Cable loss
5. Emission Level = Correction Factor + Reading Value

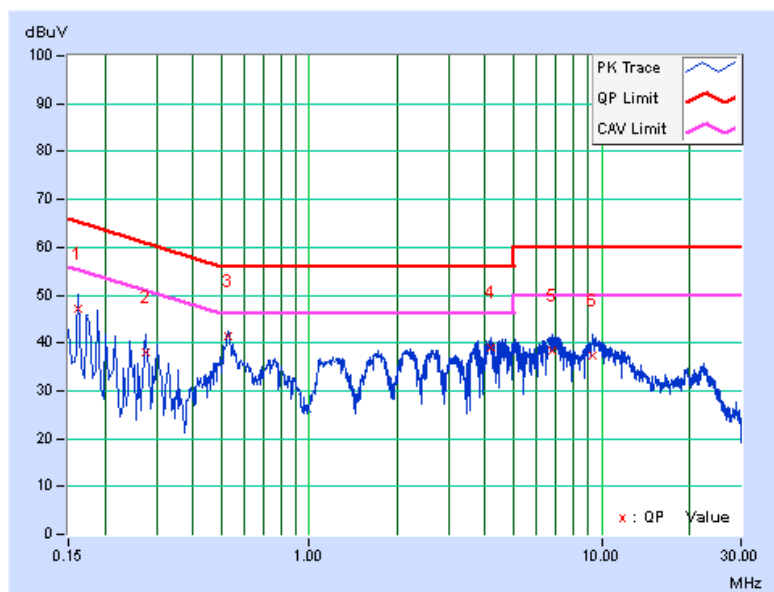



A D T

PHASE	Line 2	6dB BANDWIDTH	9kHz
TEST MODE	A		

No	Freq. [MHz]	Corr. Factor (dB)	Reading Value		Emission Level		Limit		Margin	
			[dB (uV)]		[dB (uV)]		[dB (uV)]		(dB)	
			Q.P.	AV.	Q.P.	AV.	Q.P.	AV.	Q.P.	AV.
1	0.15000	0.05	48.26	30.06	48.31	30.11	66.00	56.00	-17.69	-25.89
2	0.23602	0.10	39.29	26.74	39.39	26.84	62.24	52.24	-22.84	-25.39
3	0.52536	0.18	41.15	33.82	41.33	34.00	56.00	46.00	-14.67	-12.00
4	4.70124	0.29	39.95	32.79	40.24	33.08	56.00	46.00	-15.76	-12.92
5	6.98468	0.40	42.21	36.03	42.61	36.43	60.00	50.00	-17.39	-13.57
6	9.58092	0.52	43.95	37.97	44.47	38.49	60.00	50.00	-15.53	-11.51

REMARKS:

1. Q.P. and AV. are abbreviations of quasi-peak and average individually.
2. The emission levels of other frequencies were very low against the limit.
3. Margin value = Emission level - Limit value
4. Correction factor = Insertion loss + Cable loss
5. Emission Level = Correction Factor + Reading Value

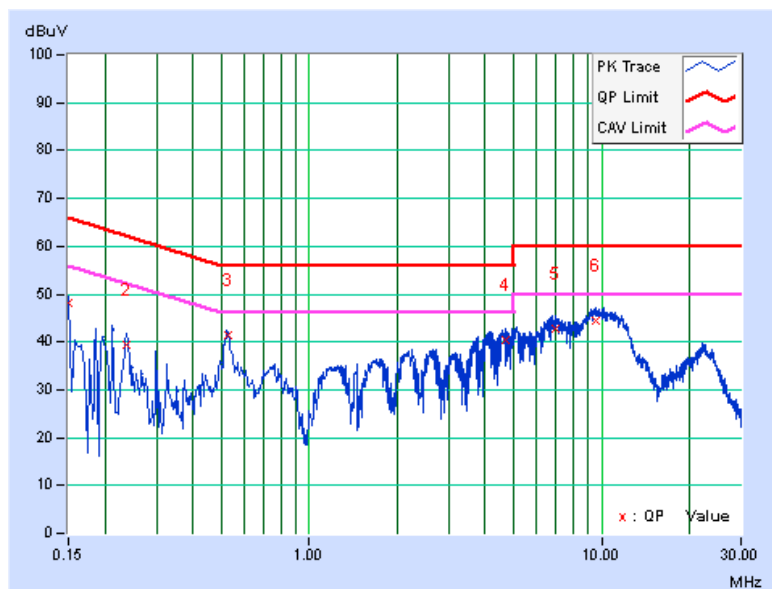

PHASE	Line 1	6dB BANDWIDTH	9kHz
TEST MODE	B		

No	Freq. [MHz]	Corr. Factor (dB)	Reading Value		Emission Level		Limit		Margin	
			[dB (uV)]		[dB (uV)]		[dB (uV)]		(dB)	
			Q.P.	AV.	Q.P.	AV.	Q.P.	AV.	Q.P.	AV.
1	0.16173	0.11	43.77	30.33	43.88	30.44	65.37	55.37	-21.50	-24.94
2	0.29467	0.10	44.94	33.25	45.04	33.35	60.39	50.39	-15.35	-17.04
3	0.47915	0.12	39.50	28.05	39.62	28.17	56.35	46.35	-16.73	-18.18
4	2.09718	0.25	38.41	27.70	38.66	27.95	56.00	46.00	-17.34	-18.05
5	20.25913	1.12	48.55	44.34	49.67	45.46	60.00	50.00	-10.33	-4.54
6	23.12907	1.21	48.30	45.63	49.51	46.84	60.00	50.00	-10.49	-3.16

REMARKS:

1. Q.P. and AV. are abbreviations of quasi-peak and average individually.
2. The emission levels of other frequencies were very low against the limit.
3. Margin value = Emission level - Limit value
4. Correction factor = Insertion loss + Cable loss
5. Emission Level = Correction Factor + Reading Value

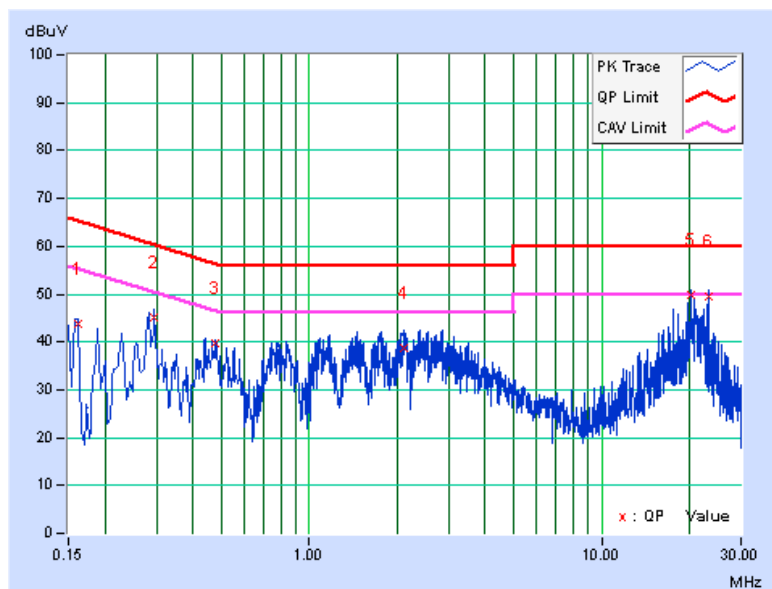

PHASE	Line 2	6dB BANDWIDTH	9kHz
TEST MODE	B		

No	Freq. [MHz]	Corr. Factor (dB)	Reading Value		Emission Level		Limit		Margin	
			[dB (uV)]		[dB (uV)]		[dB (uV)]		(dB)	
			Q.P.	AV.	Q.P.	AV.	Q.P.	AV.	Q.P.	AV.
1	0.15782	0.06	44.01	29.97	44.07	30.03	65.58	55.58	-21.51	-25.55
2	0.28294	0.12	42.53	31.97	42.65	32.09	60.73	50.73	-18.08	-18.64
3	0.43934	0.17	34.86	23.03	35.03	23.20	57.07	47.07	-22.04	-23.87
4	2.17538	0.22	32.55	18.27	32.77	18.49	56.00	46.00	-23.23	-27.51
5	19.70782	1.01	45.67	38.85	46.68	39.86	60.00	50.00	-13.32	-10.14
6	21.66282	1.06	46.09	41.33	47.15	42.39	60.00	50.00	-12.85	-7.61

REMARKS:

1. Q.P. and AV. are abbreviations of quasi-peak and average individually.
2. The emission levels of other frequencies were very low against the limit.
3. Margin value = Emission level - Limit value
4. Correction factor = Insertion loss + Cable loss
5. Emission Level = Correction Factor + Reading Value

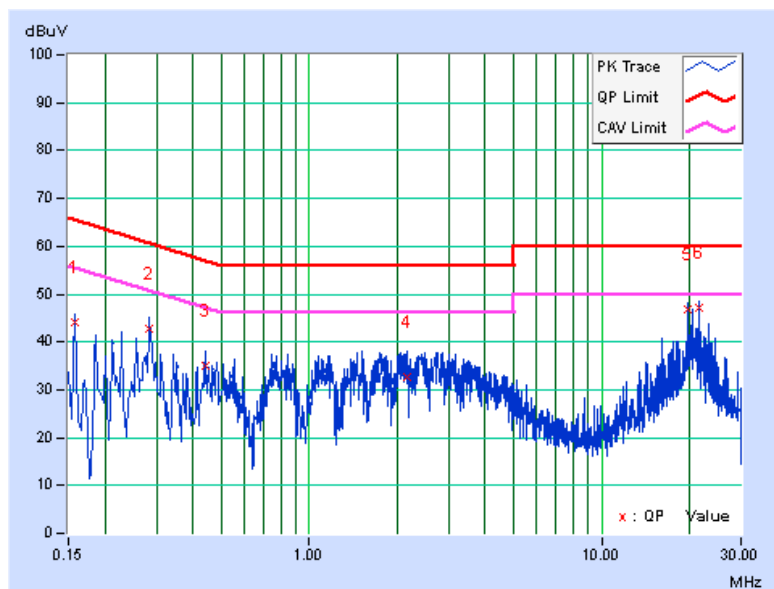



A D T

PHASE	Line 1	6dB BANDWIDTH	9kHz
TEST MODE	C		

No	Freq. [MHz]	Corr. Factor (dB)	Reading Value		Emission Level		Limit		Margin	
			[dB (uV)]		[dB (uV)]		[dB (uV)]		(dB)	
			Q.P.	AV.	Q.P.	AV.	Q.P.	AV.	Q.P.	AV.
1	0.15000	0.11	39.20	28.03	39.31	28.14	66.00	56.00	-26.69	-27.86
2	0.22429	0.09	26.70	12.73	26.79	12.82	62.66	52.66	-35.87	-39.84
3	0.45889	0.12	34.44	26.14	34.56	26.26	56.71	46.71	-22.15	-20.45
4	0.66605	0.15	25.13	19.25	25.28	19.40	56.00	46.00	-30.72	-26.60
5	5.12352	0.31	24.77	19.44	25.08	19.75	60.00	50.00	-34.92	-30.25
6	7.10198	0.41	24.83	19.01	25.24	19.42	60.00	50.00	-34.76	-30.58

REMARKS:

1. Q.P. and AV. are abbreviations of quasi-peak and average individually.
2. The emission levels of other frequencies were very low against the limit.
3. Margin value = Emission level - Limit value
4. Correction factor = Insertion loss + Cable loss
5. Emission Level = Correction Factor + Reading Value

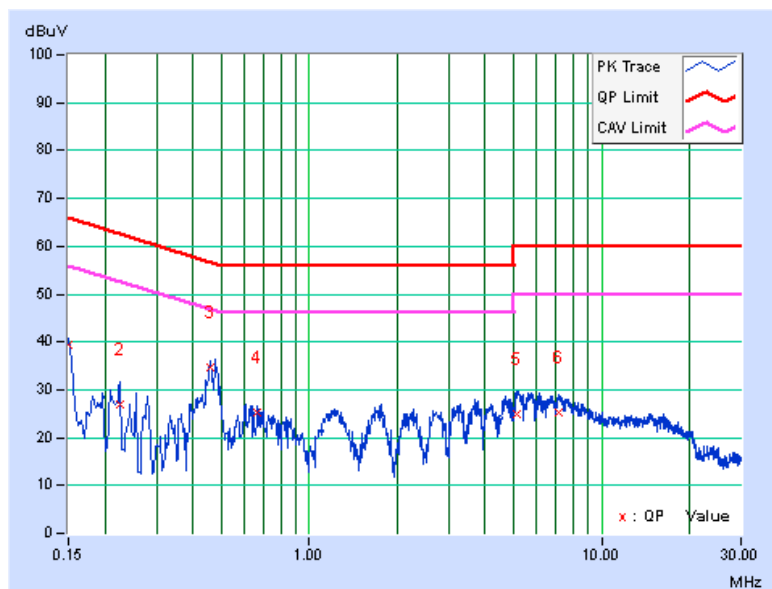

PHASE	Line 2	6dB BANDWIDTH	9kHz
TEST MODE	C		

No	Freq. [MHz]	Corr. Factor (dB)	Reading Value		Emission Level		Limit		Margin	
			[dB (uV)]		[dB (uV)]		[dB (uV)]		(dB)	
			Q.P.	AV.	Q.P.	AV.	Q.P.	AV.	Q.P.	AV.
1	0.15391	0.05	37.81	26.33	37.86	26.38	65.79	55.79	-27.92	-29.40
2	0.18122	0.07	34.67	21.81	34.74	21.88	64.43	54.43	-29.68	-32.54
3	0.47062	0.18	30.99	19.10	31.17	19.28	56.50	46.50	-25.34	-27.23
4	0.79124	0.20	23.74	14.34	23.94	14.54	56.00	46.00	-32.06	-31.46
5	1.23698	0.22	27.02	17.86	27.24	18.08	56.00	46.00	-28.76	-27.92
6	5.64746	0.34	24.21	18.99	24.55	19.33	60.00	50.00	-35.45	-30.67

REMARKS:

1. Q.P. and AV. are abbreviations of quasi-peak and average individually.
2. The emission levels of other frequencies were very low against the limit.
3. Margin value = Emission level - Limit value
4. Correction factor = Insertion loss + Cable loss
5. Emission Level = Correction Factor + Reading Value

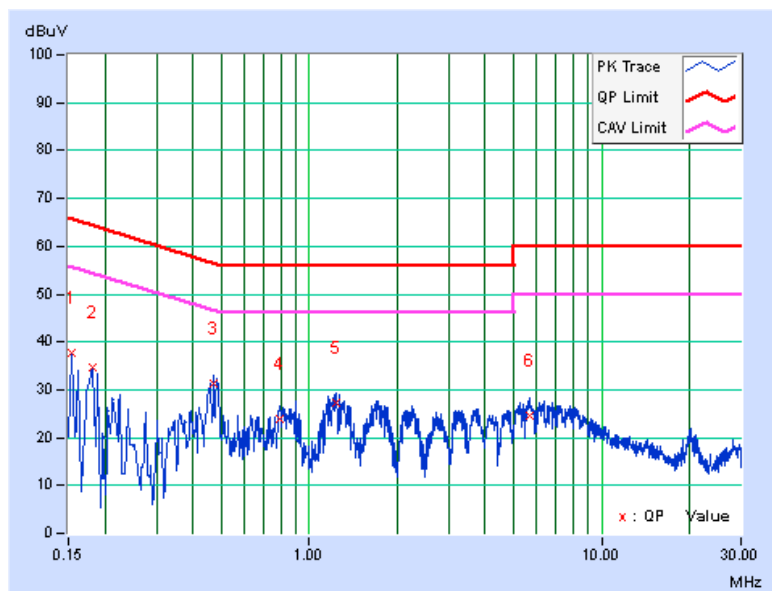

4.3 6dB BANDWIDTH MEASUREMENT

4.3.1 LIMITS OF 6dB BANDWIDTH MEASUREMENT

The minimum of 6dB Bandwidth Measurement is 0.5 MHz.

4.3.2 TEST SETUP

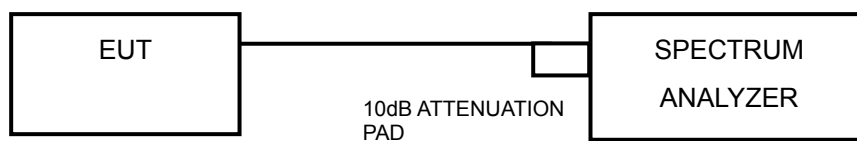

4.3.3 TEST INSTRUMENTS

Refer to section 4.1.2 to get information of above instrument.

4.3.4 TEST PROCEDURE

- a. Set resolution bandwidth (RBW) = 100kHz
- b. Set the video bandwidth (VBW) $\geq 3 \times$ RBW, Detector = Peak.
- c. Trace mode = max hold.
- d. Sweep = auto couple.
- e. Measure the maximum width of the emission that is constrained by the frequencies associated with the two amplitude points (upper and lower) that are attenuated by 6 dB relative to the maximum level measured in the fundamental emission

4.3.5 DEVIATION FROM TEST STANDARD

No deviation.

4.3.6 EUT OPERATING CONDITIONS

The software provided by client to enable the EUT under transmission condition continuously at lowest, middle and highest channel frequencies individually.

4.3.7 TEST RESULTS

802.11b

CHANNEL	FREQUENCY (MHz)	6dB BANDWIDTH (MHz)	MINIMUM LIMIT (MHz)	PASS / FAIL
1	2412	10.12	0.5	PASS
6	2437	10.12	0.5	PASS
11	2462	10.11	0.5	PASS

802.11g

CHANNEL	FREQUENCY (MHz)	6dB BANDWIDTH (MHz)	MINIMUM LIMIT (MHz)	PASS / FAIL
1	2412	16.38	0.5	PASS
6	2437	16.34	0.5	PASS
11	2462	16.38	0.5	PASS

802.11n (20MHz)

CHANNEL	FREQUENCY (MHz)	6dB BANDWIDTH (MHz)	MINIMUM LIMIT (MHz)	PASS / FAIL
1	2412	17.35	0.5	PASS
6	2437	16.71	0.5	PASS
11	2462	17.37	0.5	PASS

802.11n (40MHz)

CHANNEL	FREQUENCY (MHz)	6dB BANDWIDTH (MHz)	MINIMUM LIMIT (MHz)	PASS / FAIL
3	2422	36.06	0.5	PASS
6	2437	36.13	0.5	PASS
9	2452	36.20	0.5	PASS



A D T

SPECTRUM PLOT OF WORST VALUE

802.11b

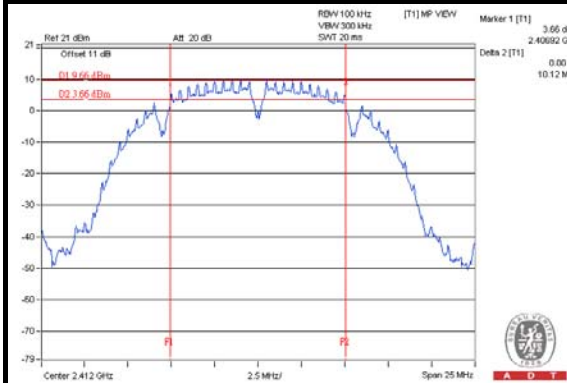

802.11g

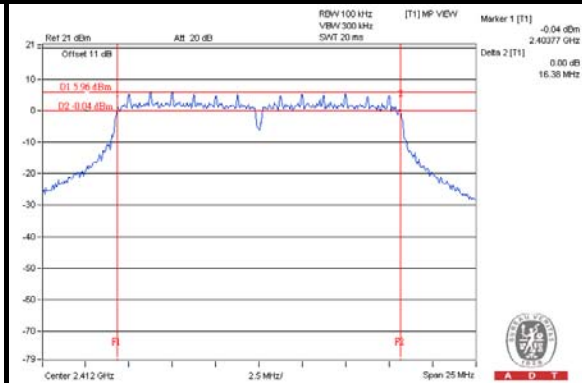

802.11n (20MHz)

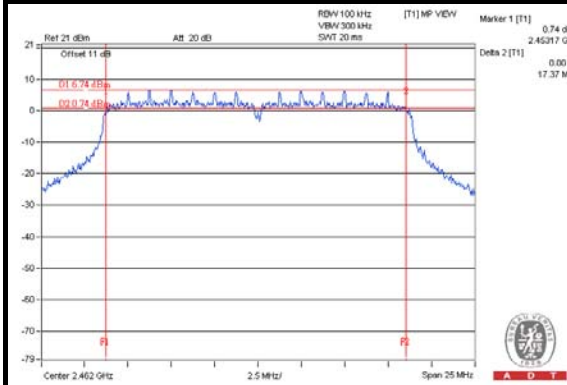

802.11n (40MHz)

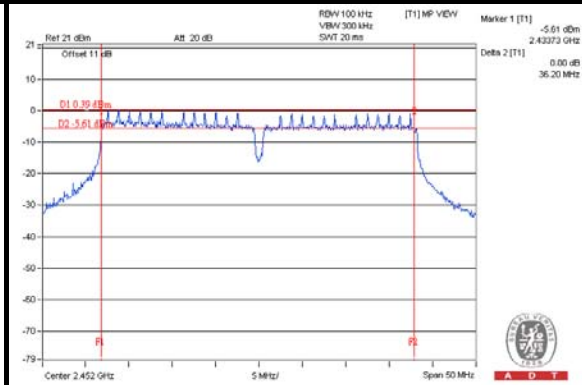

4.4 CONDUCTED OUTPUT POWER

4.4.1 LIMITS OF CONDUCTED OUTPUT POWER MEASUREMENT

For systems using digital modulation in the 2400–2483.5 MHz bands: 1 Watt (30dBm)

4.4.2 TEST SETUP

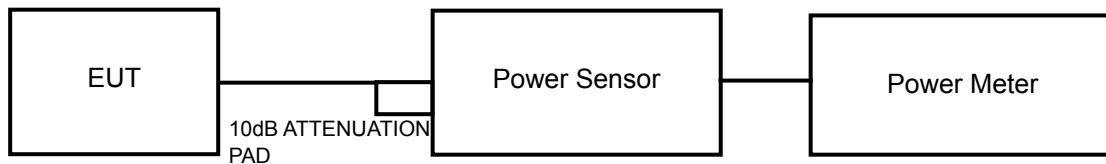

4.4.3 TEST INSTRUMENTS

Refer to section 4.1.2 to get information of above instrument.

4.4.4 TEST PROCEDURES

An average power sensor was used on the output port of the EUT. A power meter was used to read the response of the average power sensor. Record the power level.

4.4.5 DEVIATION FROM TEST STANDARD

No deviation.

4.4.6 EUT OPERATING CONDITIONS

Same as Item 4.3.6.



4.4.7 TEST RESULTS

802.11b

CHANNEL	FREQUENCY (MHz)	AVG. POWER (mW)	AVG. POWER (dBm)	LIMIT (dBm)	PASS/FAIL
1	2412	75.858	18.80	30	PASS
6	2437	257.040	24.10	30	PASS
11	2462	204.644	23.11	30	PASS

802.11g

CHANNEL	FREQUENCY (MHz)	AVG. POWER (mW)	AVG. POWER (dBm)	LIMIT (dBm)	PASS/FAIL
1	2412	56.364	17.51	30	PASS
6	2437	271.019	24.33	30	PASS
11	2462	69.024	18.39	30	PASS

802.11n (20MHz)

CHANNEL	FREQUENCY (MHz)	AVG. POWER (mW)	AVG. POWER (dBm)	LIMIT (dBm)	PASS/FAIL
1	2412	45.499	16.58	30	PASS
6	2437	283.792	24.53	30	PASS
11	2462	49.774	16.97	30	PASS

802.11n (40MHz)

CHANNEL	FREQUENCY (MHz)	AVG. POWER (mW)	AVG. POWER (dBm)	LIMIT (dBm)	PASS/FAIL
3	2422	13.397	11.27	30	PASS
6	2437	42.855	16.32	30	PASS
9	2452	24.322	13.86	30	PASS

4.5 POWER SPECTRAL DENSITY MEASUREMENT

4.5.1 LIMITS OF POWER SPECTRAL DENSITY MEASUREMENT

The Maximum of Power Spectral Density Measurement is 8dBm.

4.5.2 TEST SETUP

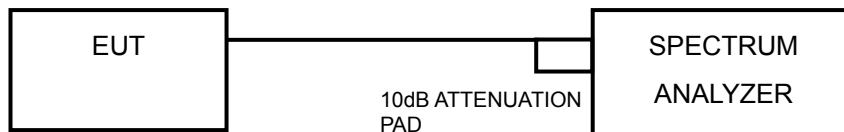

4.5.3 TEST INSTRUMENTS

Refer to section 4.1.2 to get information of above instrument.

4.5.4 TEST PROCEDURE

- a) Set instrument center frequency to DTS channel center frequency.
- b) Set span to at least 1.5 times the OBW.
- c) Set RBW to: $3 \text{ kHz} \leq \text{RBW} \leq 100 \text{ kHz}$.
- d) Set VBW $\geq 3 \times \text{RBW}$.
- e) Detector = power averaging (RMS) or sample detector (when RMS not available).
- f) Ensure that the number of measurement points in the sweep $\geq 2 \times \text{span}/\text{RBW}$.
- g) Sweep time = auto couple.
- h) Employ trace averaging (RMS) mode over a minimum of 100 traces.
- i) Use the peak marker function to determine the maximum amplitude level.

4.5.5 DEVIATION FROM TEST STANDARD

No deviation.

4.5.6 EUT OPERATING CONDITION

Same as Item 4.3.6



4.5.7 TEST RESULTS

802.11b

Channel	Freq. (MHz)	PSD (dBm)	Limit (dBm)	PASS /FAIL
1	2412	-10.22	8	PASS
6	2437	-5.54	8	PASS
11	2462	-7.02	8	PASS

802.11g

CHANNEL	FREQUENCY (MHz)	PSD W/O DUTY FACTOR (dBm)	DUTY FACTOR	PSD WITH DUTY FACTOR (dBm)	MAXIMUM LIMIT (dBm)	PASS/FAIL
1	2412	-13.72	0.19	-13.53	8	PASS
6	2437	-2.61	0.19	-2.42	8	PASS
11	2462	-9.06	0.19	-8.87	8	PASS

NOTE: Refer to section 3.3 for duty cycle spectrum plot.

802.11n (20MHz)

CHANNEL	FREQUENCY (MHz)	PSD W/O DUTY FACTOR (dBm)	DUTY FACTOR	PSD WITH DUTY FACTOR (dBm)	MAXIMUM LIMIT (dBm)	PASS/FAIL
1	2412	-14.59	0.18	-14.41	8	PASS
6	2437	-2.89	0.18	-2.71	8	PASS
11	2462	-8.15	0.18	-7.97	8	PASS

NOTE: Refer to section 3.3 for duty cycle spectrum plot.

802.11n (40MHz)

CHANNEL	FREQUENCY (MHz)	PSD W/O DUTY FACTOR (dBm)	DUTY FACTOR	PSD WITH DUTY FACTOR (dBm)	MAXIMUM LIMIT (dBm)	PASS/FAIL
3	2422	-22.11	0.32	-21.79	8	PASS
6	2437	-16.78	0.32	-16.46	8	PASS
9	2452	-19.05	0.32	-18.73	8	PASS

NOTE: Refer to section 3.3 for duty cycle spectrum plot.



A D T

SPECTRUM PLOT OF WORST VALUE

802.11b

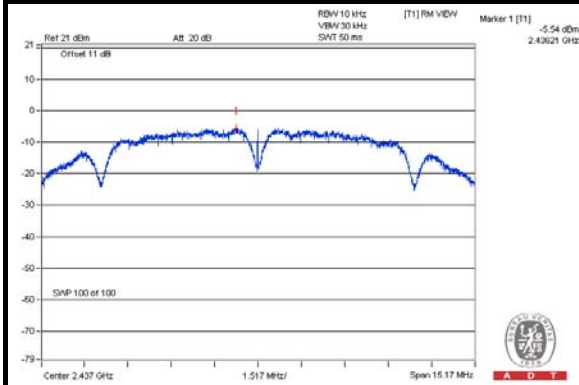

802.11g

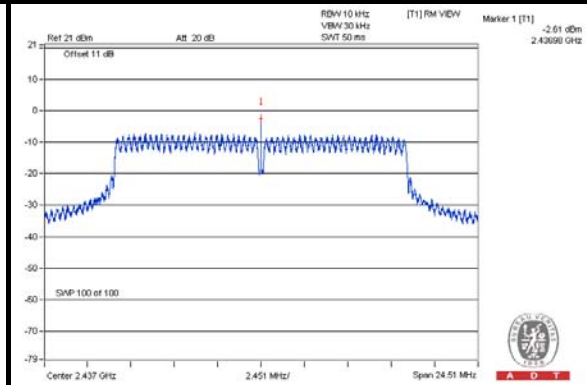

802.11n (20MHz)

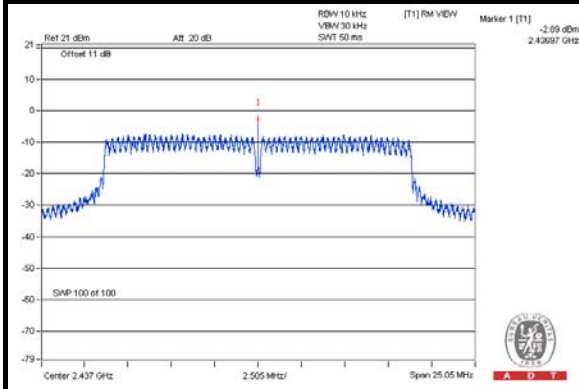

802.11n (40MHz)

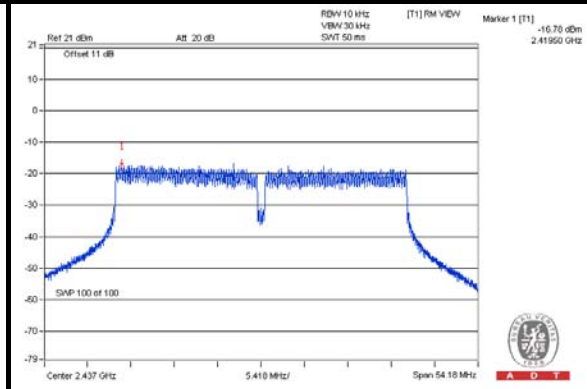

4.6 CONDUCTED OUT OF BAND EMISSION MEASUREMENT

4.6.1 LIMITS OF CONDUCTED OUT OF BAND EMISSION MEASUREMENT

Below -30dB of the highest emission level of operating band (in 100kHz Resolution Bandwidth).

4.6.2 TEST SETUP

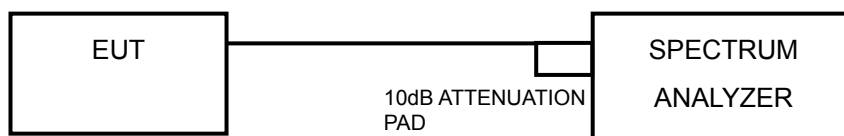

4.6.3 TEST INSTRUMENTS

Refer to section 4.1.2 to get information of above instrument.

4.6.4 TEST PROCEDURE

MEASUREMENT PROCEDURE REF

1. Set the RBW = 100 kHz.
2. Set the VBW \geq 300 kHz.
3. Detector = average.
4. Sweep time = auto couple.
5. Trace mode = max hold.
6. Allow trace to fully stabilize.
7. Use the peak marker function to determine the maximum power level in any 100 kHz band segment within the fundamental EBW.

MEASUREMENT PROCEDURE OOB

1. Set RBW = 100 kHz.
2. Set VBW \geq 300 kHz.
3. Detector = peak.
4. Sweep = auto couple.
5. Trace Mode = max hold.
6. Allow trace to fully stabilize.
7. Use the peak marker function to determine the maximum amplitude level.

4.6.5 DEVIATION FROM TEST STANDARD

No deviation.

4.6.6 EUT OPERATING CONDITION

Same as Item 4.3.6

4.6.7 TEST RESULTS

The spectrum plots are attached on the following pages. D1 line indicates the highest level, and D2 line indicates the 30dB offset below D1. It shows compliance with the requirement.



A D T

802.11b

CH 1

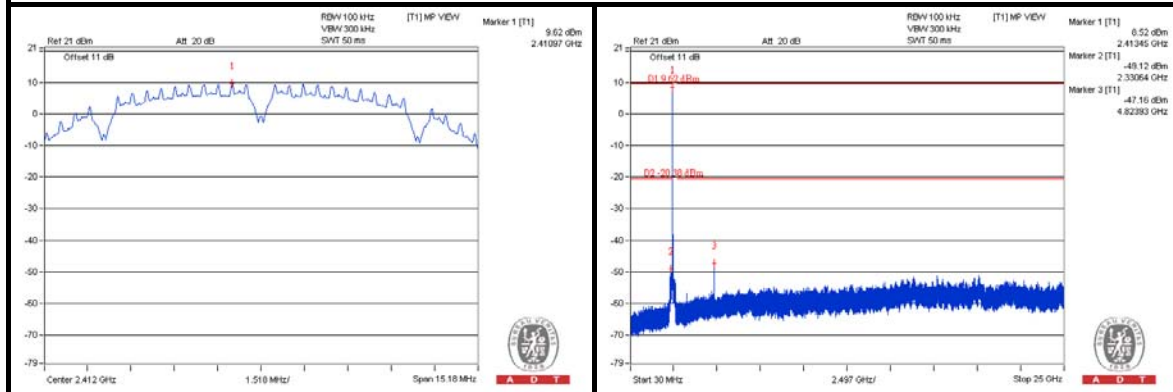

CH 6

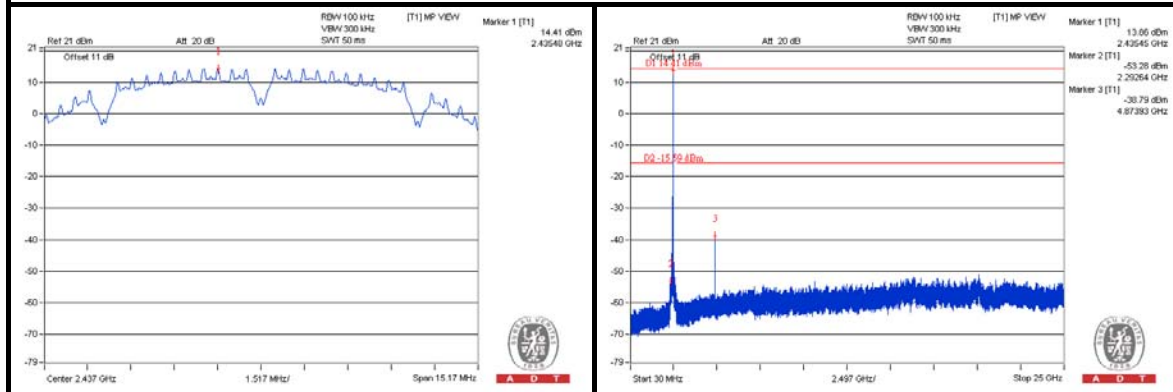

CH 11

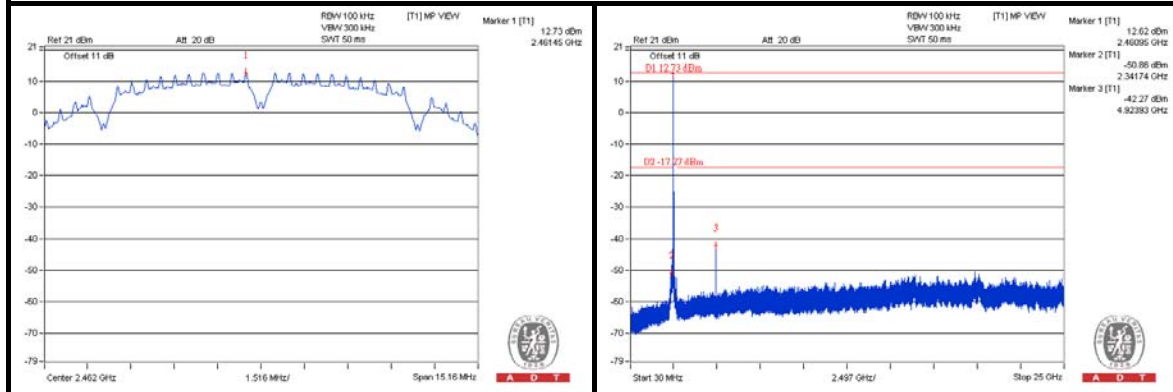

CH 1 Band edge

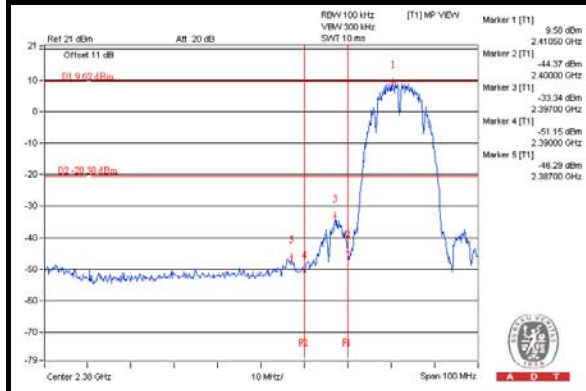

CH 11 Band edge

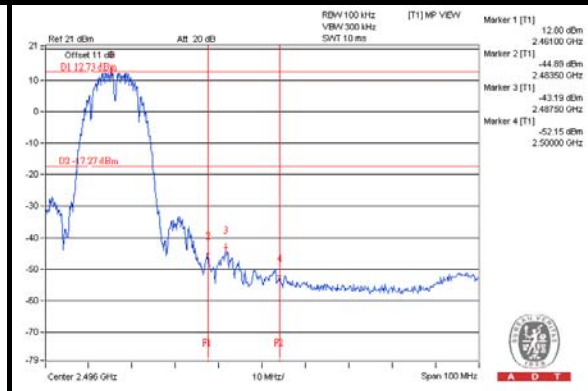



A D T

802.11g

CH 1

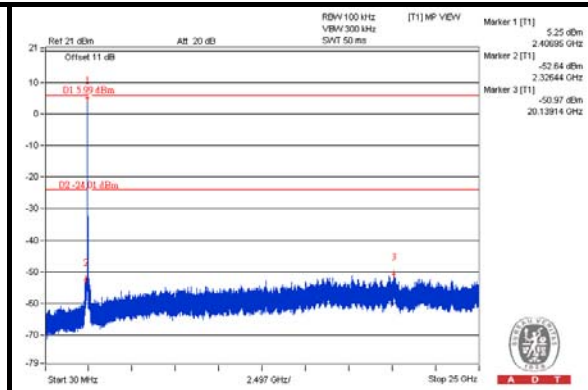
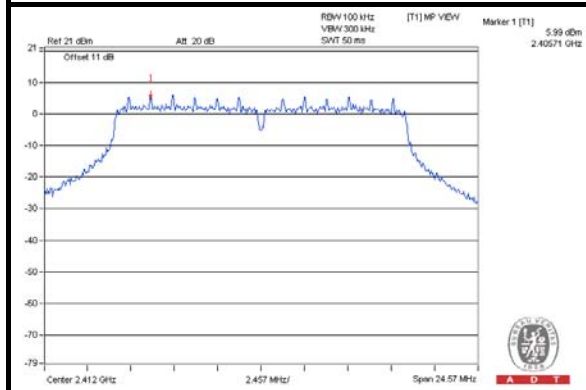

CH 6

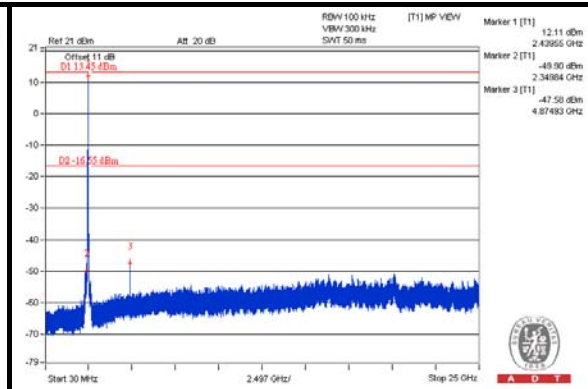
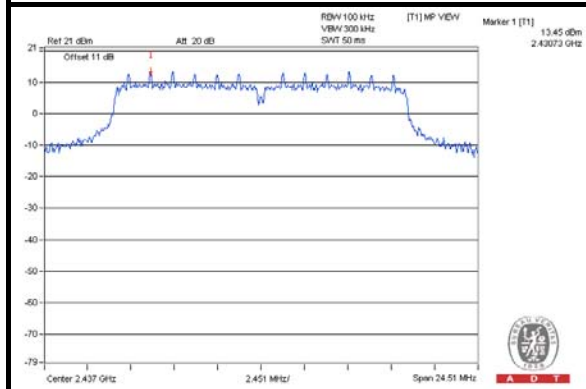

CH 11

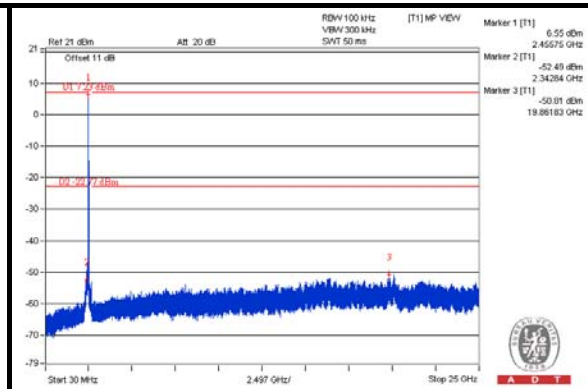
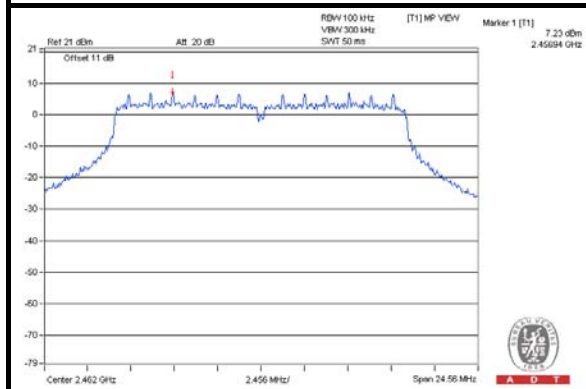

CH 1 Band edge

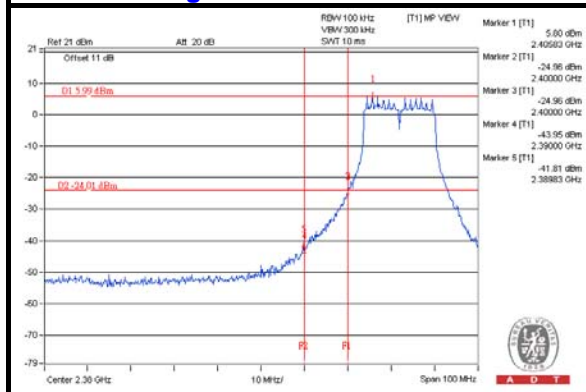

CH 11 Band edge

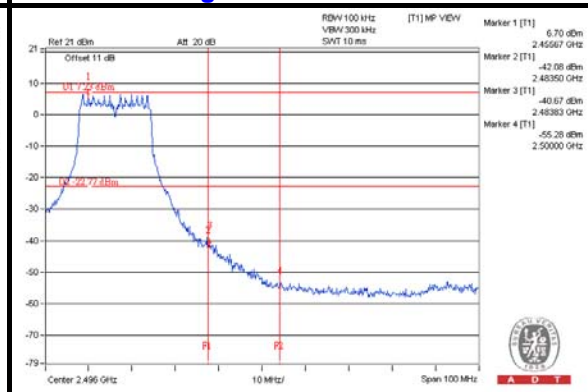

802.11n (20MHz)

CH 1

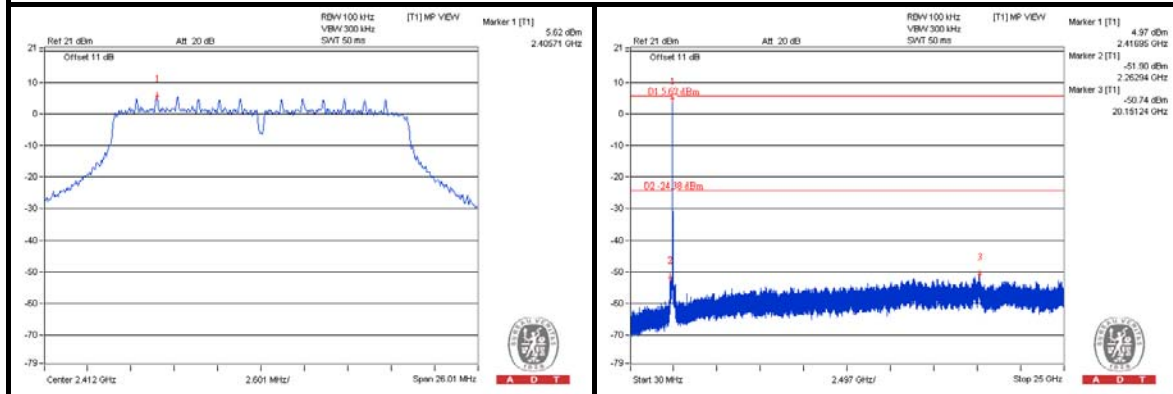

CH 6

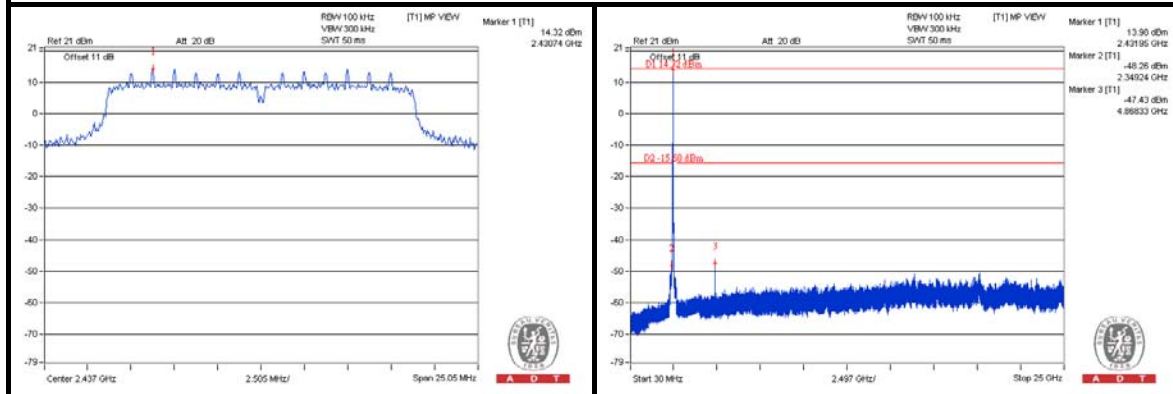

CH 11

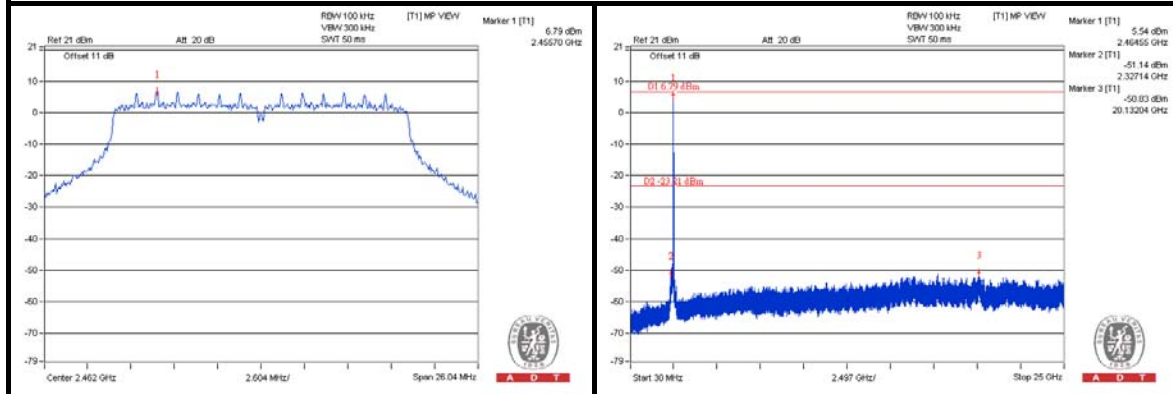

CH 1 Band edge

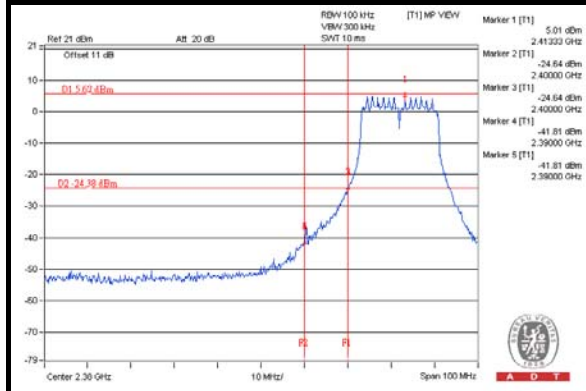

CH 11 Band edge

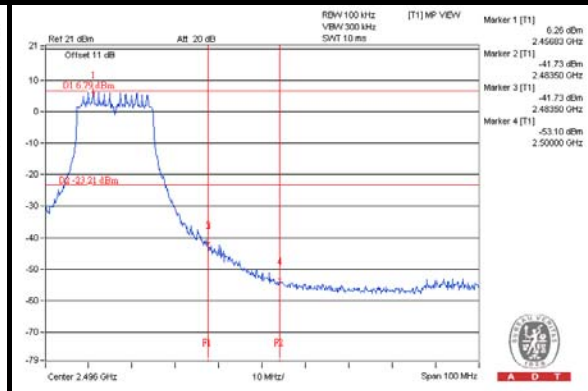

802.11n (40MHz)

CH 3

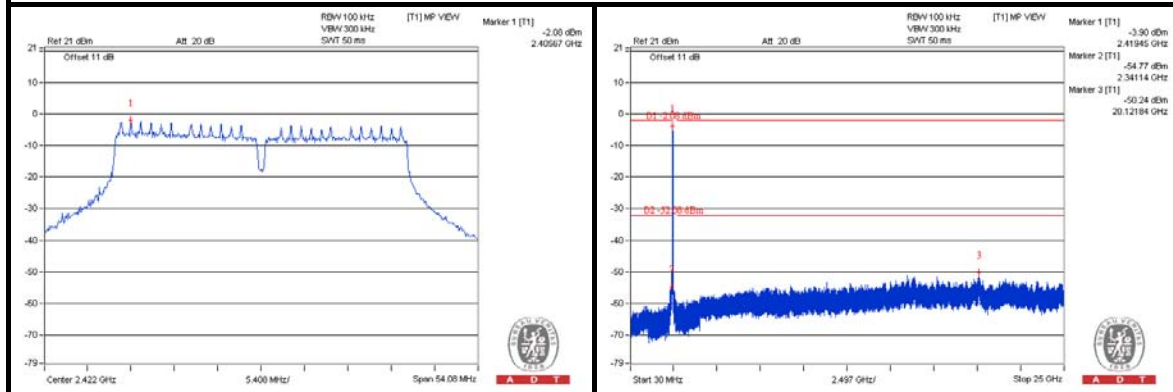

CH 6

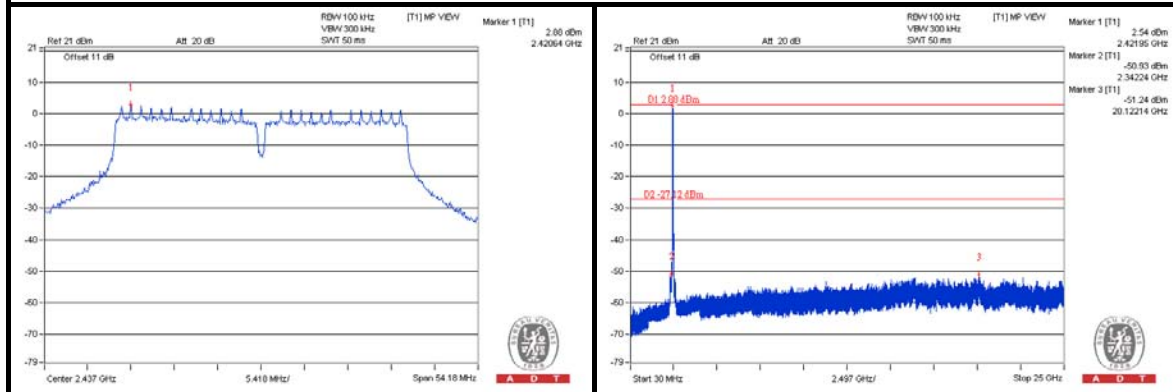

CH 9

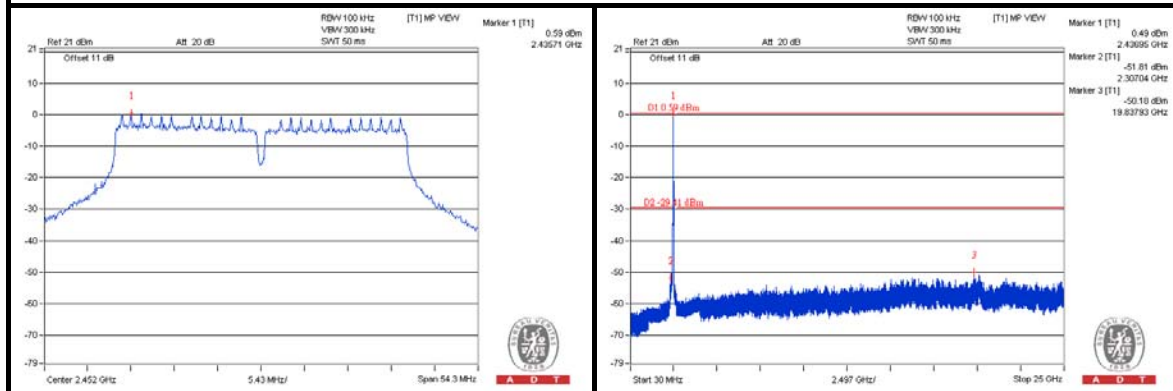

CH 3 Band edge

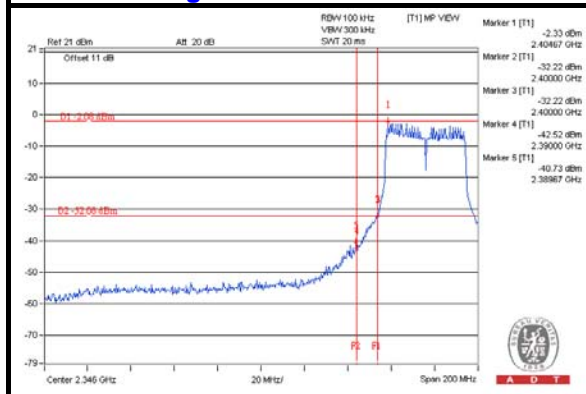

CH 9 Band edge

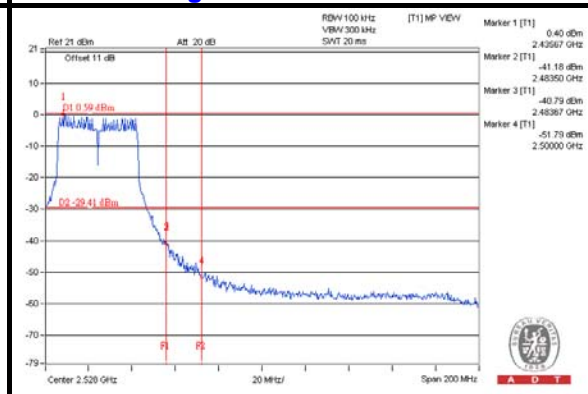

5. TEST TYPES AND RESULTS (FOR 5.0GHz BAND)

5.1 RADIATED EMISSION MEASUREMENT

5.1.1 LIMITS OF RADIATED EMISSION MEASUREMENT

Radiated emissions which fall in the restricted bands must comply with the radiated emission limits specified as below table. Other emissions shall be at least 30dB below the highest level of the desired power:

FREQUENCIES (MHz)	FIELD STRENGTH (microvolts/meter)	MEASUREMENT DISTANCE (meters)
0.009 ~ 0.490	2400/F(kHz)	300
0.490 ~ 1.705	24000/F(kHz)	30
1.705 ~ 30.0	30	30
30 ~ 88	100	3
88 ~ 216	150	3
216 ~ 960	200	3
Above 960	500	3

NOTE:

1. The lower limit shall apply at the transition frequencies.
2. Emission level (dBuV/m) = 20 log Emission level (uV/m).
3. For frequencies above 1000MHz, the field strength limits are based on average detector, however, the peak field strength of any emission shall not exceed the maximum permitted average limits, specified above by more than 30dB under any condition of modulation.

5.1.2 TEST INSTRUMENTS

Same as item 4.1.2.

5.1.3 TEST PROCEDURES

Same as item 4.1.3.

5.1.4 DEVIATION FROM TEST STANDARD

No deviation.

5.1.5 TEST SETUP

Same as item 4.1.5.

5.1.6 EUT OPERATING CONDITIONS

Same as item 4.1.6.



A D T

5.1.7 TEST RESULTS

ABOVE 1GHz DATA

802.11a

CHANNEL	TX Channel 149	DETECTOR FUNCTION	Peak (PK)
FREQUENCY RANGE	1GHz ~ 40GHz		Average (AV)

ANTENNA POLARITY & TEST DISTANCE: HORIZONTAL AT 3 M

NO.	FREQ. (MHz)	EMISSION LEVEL (dBuV/m)	LIMIT (dBuV/m)	MARGIN (dB)	ANTENNA HEIGHT (m)	TABLE ANGLE (Degree)	RAW VALUE (dBuV)	CORRECTION FACTOR (dB/m)
1	5000.00	57.9 PK	74.0	-16.1	1.00 H	212	51.80	6.10
2	5000.00	45.6 AV	54.0	-8.4	1.00 H	212	39.50	6.10
3	*5745.00	107.1 PK			1.01 H	316	66.50	40.60
4	*5745.00	97.5 AV			1.01 H	316	56.90	40.60
5	11490.00	59.0 PK	74.0	-15.0	1.15 H	167	40.30	18.70
6	11490.00	46.2 AV	54.0	-7.8	1.15 H	167	27.50	18.70

ANTENNA POLARITY & TEST DISTANCE: VERTICAL AT 3 M

NO.	FREQ. (MHz)	EMISSION LEVEL (dBuV/m)	LIMIT (dBuV/m)	MARGIN (dB)	ANTENNA HEIGHT (m)	TABLE ANGLE (Degree)	RAW VALUE (dBuV)	CORRECTION FACTOR (dB/m)
1	5000.00	60.7 PK	74.0	-13.3	1.61 V	282	54.60	6.10
2	5000.00	52.2 AV	54.0	-1.8	1.61 V	282	46.10	6.10
3	*5745.00	114.4 PK			1.03 V	337	73.80	40.60
4	*5745.00	104.6 AV			1.03 V	337	64.00	40.60
5	11490.00	59.7 PK	74.0	-14.3	1.04 V	221	41.00	18.70
6	11490.00	46.0 AV	54.0	-8.0	1.04 V	221	27.30	18.70

REMARKS:

1. Emission Level(dBuV/m) = Raw Value(dBuV) + Correction Factor(dB/m)
2. Correction Factor(dB/m) = Antenna Factor(dB/m) + Cable Factor(dB) - Pre-Amplifier Factor(dB)
3. The other emission levels were very low against the limit.
4. Margin value = Emission Level - Limit value
5. " * ": Fundamental frequency.



A D T

CHANNEL	TX Channel 157	DETECTOR FUNCTION	Peak (PK)
FREQUENCY RANGE	1GHz ~ 40GHz		Average (AV)

ANTENNA POLARITY & TEST DISTANCE: HORIZONTAL AT 3 M

NO.	FREQ. (MHz)	EMISSION LEVEL (dBuV/m)	LIMIT (dBuV/m)	MARGIN (dB)	ANTENNA HEIGHT (m)	TABLE ANGLE (Degree)	RAW VALUE (dBuV)	CORRECTION FACTOR (dB/m)
1	5000.00	57.4 PK	74.0	-16.6	1.02 H	213	51.30	6.10
2	5000.00	46.7 AV	54.0	-7.3	1.02 H	213	40.60	6.10
3	*5785.00	106.4 PK			1.08 H	320	65.70	40.70
4	*5785.00	96.9 AV			1.08 H	320	56.20	40.70
5	11570.00	59.7 PK	74.0	-14.3	1.17 H	243	40.90	18.80
6	11570.00	46.6 AV	54.0	-7.4	1.17 H	243	27.80	18.80

ANTENNA POLARITY & TEST DISTANCE: VERTICAL AT 3 M

NO.	FREQ. (MHz)	EMISSION LEVEL (dBuV/m)	LIMIT (dBuV/m)	MARGIN (dB)	ANTENNA HEIGHT (m)	TABLE ANGLE (Degree)	RAW VALUE (dBuV)	CORRECTION FACTOR (dB/m)
1	5000.00	59.7 PK	74.0	-14.3	1.20 V	338	53.60	6.10
2	5000.00	52.4 AV	54.0	-1.6	1.20 V	338	46.30	6.10
3	*5785.00	112.7 PK			1.00 V	45	72.00	40.70
4	*5785.00	102.2 AV			1.00 V	45	61.50	40.70
5	11570.00	59.8 PK	74.0	-14.2	1.14 V	172	41.00	18.80
6	11570.00	46.9 AV	54.0	-7.1	1.14 V	172	28.10	18.80

REMARKS:

1. Emission Level(dBuV/m) = Raw Value(dBuV) + Correction Factor(dB/m)
2. Correction Factor(dB/m) = Antenna Factor(dB/m) + Cable Factor(dB) – Pre-Amplifier Factor(dB)
3. The other emission levels were very low against the limit.
4. Margin value = Emission Level – Limit value
5. " * " : Fundamental frequency.



A D T

CHANNEL	TX Channel 165	DETECTOR FUNCTION	Peak (PK)
FREQUENCY RANGE	1GHz ~ 40GHz		Average (AV)

ANTENNA POLARITY & TEST DISTANCE: HORIZONTAL AT 3 M

NO.	FREQ. (MHz)	EMISSION LEVEL (dBuV/m)	LIMIT (dBuV/m)	MARGIN (dB)	ANTENNA HEIGHT (m)	TABLE ANGLE (Degree)	RAW VALUE (dBuV)	CORRECTION FACTOR (dB/m)
1	5000.00	58.7 PK	74.0	-15.3	1.14 H	269	52.60	6.10
2	5000.00	48.3 AV	54.0	-5.7	1.14 H	269	42.20	6.10
3	*5825.00	105.8 PK			1.00 H	321	65.10	40.70
4	*5825.00	97.0 AV			1.00 H	321	56.30	40.70
5	11650.00	60.5 PK	74.0	-13.5	1.21 H	149	41.30	19.20
6	11650.00	48.0 AV	54.0	-6.0	1.21 H	149	28.80	19.20

ANTENNA POLARITY & TEST DISTANCE: VERTICAL AT 3 M

NO.	FREQ. (MHz)	EMISSION LEVEL (dBuV/m)	LIMIT (dBuV/m)	MARGIN (dB)	ANTENNA HEIGHT (m)	TABLE ANGLE (Degree)	RAW VALUE (dBuV)	CORRECTION FACTOR (dB/m)
1	5000.00	59.9 PK	74.0	-14.1	1.03 V	283	53.80	6.10
2	5000.00	52.2 AV	54.0	-1.8	1.03 V	283	46.10	6.10
3	*5825.00	113.2 PK			1.01 V	335	72.50	40.70
4	*5825.00	104.3 AV			1.01 V	335	63.60	40.70
5	11650.00	59.8 PK	74.0	-14.2	1.02 V	243	40.60	19.20
6	11650.00	47.8 AV	54.0	-6.2	1.02 V	243	28.60	19.20

REMARKS:

1. Emission Level(dBuV/m) = Raw Value(dBuV) + Correction Factor(dB/m)
2. Correction Factor(dB/m) = Antenna Factor(dB/m) + Cable Factor(dB) – Pre-Amplifier Factor(dB)
3. The other emission levels were very low against the limit.
4. Margin value = Emission Level – Limit value
5. " * ": Fundamental frequency.



A D T

802.11n (20MHz)

CHANNEL	TX Channel 149	DETECTOR FUNCTION	Peak (PK)
FREQUENCY RANGE	1GHz ~ 40GHz		Average (AV)

ANTENNA POLARITY & TEST DISTANCE: HORIZONTAL AT 3 M								
NO.	FREQ. (MHz)	EMISSION LEVEL (dBuV/m)	LIMIT (dBuV/m)	MARGIN (dB)	ANTENNA HEIGHT (m)	TABLE ANGLE (Degree)	RAW VALUE (dBuV)	CORRECTION FACTOR (dB/m)
1	5000.00	59.4 PK	74.0	-14.6	1.60 H	270	53.30	6.10
2	5000.00	47.6 AV	54.0	-6.4	1.60 H	270	41.50	6.10
3	*5745.00	106.0 PK			1.08 H	311	65.40	40.60
4	*5745.00	96.6 AV			1.08 H	311	56.00	40.60
5	11490.00	60.6 PK	74.0	-13.4	1.26 H	104	41.90	18.70
6	11490.00	47.6 AV	54.0	-6.4	1.26 H	104	28.90	18.70
ANTENNA POLARITY & TEST DISTANCE: VERTICAL AT 3 M								
NO.	FREQ. (MHz)	EMISSION LEVEL (dBuV/m)	LIMIT (dBuV/m)	MARGIN (dB)	ANTENNA HEIGHT (m)	TABLE ANGLE (Degree)	RAW VALUE (dBuV)	CORRECTION FACTOR (dB/m)
1	5000.00	61.3 PK	74.0	-12.7	1.03 V	299	55.20	6.10
2	5000.00	52.3 AV	54.0	-1.7	1.03 V	299	46.20	6.10
3	*5745.00	115.5 PK			1.02 V	339	74.90	40.60
4	*5745.00	105.1 AV			1.02 V	339	64.50	40.60
5	11490.00	61.7 PK	74.0	-12.3	1.10 V	175	43.00	18.70
6	11490.00	47.9 AV	54.0	-6.1	1.10 V	175	29.20	18.70

REMARKS:

1. Emission Level(dBuV/m) = Raw Value(dBuV) + Correction Factor(dB/m)
2. Correction Factor(dB/m) = Antenna Factor(dB/m) + Cable Factor(dB) – Pre-Amplifier Factor(dB)
3. The other emission levels were very low against the limit.
4. Margin value = Emission Level – Limit value
5. " * ": Fundamental frequency.



A D T

CHANNEL	TX Channel 157	DETECTOR FUNCTION	Peak (PK)
FREQUENCY RANGE	1GHz ~ 40GHz		Average (AV)

ANTENNA POLARITY & TEST DISTANCE: HORIZONTAL AT 3 M

NO.	FREQ. (MHz)	EMISSION LEVEL (dBuV/m)	LIMIT (dBuV/m)	MARGIN (dB)	ANTENNA HEIGHT (m)	TABLE ANGLE (Degree)	RAW VALUE (dBuV)	CORRECTION FACTOR (dB/m)
1	5000.00	57.6 PK	74.0	-16.4	1.05 H	310	51.50	6.10
2	5000.00	46.8 AV	54.0	-7.2	1.05 H	310	40.70	6.10
3	*5785.00	105.7 PK			1.08 H	320	65.00	40.70
4	*5785.00	95.7 AV			1.08 H	320	55.00	40.70
5	11570.00	60.1 PK	74.0	-13.9	1.15 H	173	41.30	18.80
6	11570.00	47.2 AV	54.0	-6.8	1.15 H	173	28.40	18.80

ANTENNA POLARITY & TEST DISTANCE: VERTICAL AT 3 M

NO.	FREQ. (MHz)	EMISSION LEVEL (dBuV/m)	LIMIT (dBuV/m)	MARGIN (dB)	ANTENNA HEIGHT (m)	TABLE ANGLE (Degree)	RAW VALUE (dBuV)	CORRECTION FACTOR (dB/m)
1	5000.00	61.7 PK	74.0	-12.3	1.04 V	299	55.60	6.10
2	5000.00	52.3 AV	54.0	-1.7	1.04 V	299	46.20	6.10
3	*5785.00	114.3 PK			1.02 V	333	73.60	40.70
4	*5785.00	104.0 AV			1.02 V	333	63.30	40.70
5	11570.00	60.5 PK	74.0	-13.5	1.18 V	176	41.70	18.80
6	11570.00	47.5 AV	54.0	-6.5	1.18 V	176	28.70	18.80

REMARKS:

1. Emission Level(dBuV/m) = Raw Value(dBuV) + Correction Factor(dB/m)
2. Correction Factor(dB/m) = Antenna Factor(dB/m) + Cable Factor(dB) – Pre-Amplifier Factor(dB)
3. The other emission levels were very low against the limit.
4. Margin value = Emission Level – Limit value
5. " * " : Fundamental frequency.



A D T

CHANNEL	TX Channel 165	DETECTOR FUNCTION	Peak (PK)
FREQUENCY RANGE	1GHz ~ 40GHz		Average (AV)

ANTENNA POLARITY & TEST DISTANCE: HORIZONTAL AT 3 M

NO.	FREQ. (MHz)	EMISSION LEVEL (dBuV/m)	LIMIT (dBuV/m)	MARGIN (dB)	ANTENNA HEIGHT (m)	TABLE ANGLE (Degree)	RAW VALUE (dBuV)	CORRECTION FACTOR (dB/m)
1	5000.00	59.5 PK	74.0	-14.5	1.53 H	263	53.40	6.10
2	5000.00	47.6 AV	54.0	-6.4	1.53 H	263	41.50	6.10
3	*5825.00	105.7 PK			1.04 H	310	65.00	40.70
4	*5825.00	95.7 AV			1.04 H	310	55.00	40.70
5	11650.00	61.6 PK	74.0	-12.4	1.37 H	70	42.40	19.20
6	11650.00	48.4 AV	54.0	-5.6	1.37 H	70	29.20	19.20

ANTENNA POLARITY & TEST DISTANCE: VERTICAL AT 3 M

NO.	FREQ. (MHz)	EMISSION LEVEL (dBuV/m)	LIMIT (dBuV/m)	MARGIN (dB)	ANTENNA HEIGHT (m)	TABLE ANGLE (Degree)	RAW VALUE (dBuV)	CORRECTION FACTOR (dB/m)
1	5000.00	61.4 PK	74.0	-12.6	1.03 V	298	55.30	6.10
2	5000.00	52.1 AV	54.0	-1.9	1.03 V	298	46.00	6.10
3	*5825.00	113.7 PK			1.01 V	330	73.00	40.70
4	*5825.00	103.7 AV			1.01 V	330	63.00	40.70
5	11650.00	62.0 PK	74.0	-12.0	1.00 V	241	42.80	19.20
6	11650.00	49.1 AV	54.0	-4.9	1.00 V	241	29.90	19.20

REMARKS:

1. Emission Level(dBuV/m) = Raw Value(dBuV) + Correction Factor(dB/m)
2. Correction Factor(dB/m) = Antenna Factor(dB/m) + Cable Factor(dB) – Pre-Amplifier Factor(dB)
3. The other emission levels were very low against the limit.
4. Margin value = Emission Level – Limit value
5. " * " : Fundamental frequency.



A D T

802.11n (40MHz)

CHANNEL	TX Channel 151	DETECTOR FUNCTION	Peak (PK)
FREQUENCY RANGE	1GHz ~ 40GHz		Average (AV)

ANTENNA POLARITY & TEST DISTANCE: HORIZONTAL AT 3 M

NO.	FREQ. (MHz)	EMISSION LEVEL (dBuV/m)	LIMIT (dBuV/m)	MARGIN (dB)	ANTENNA HEIGHT (m)	TABLE ANGLE (Degree)	RAW VALUE (dBuV)	CORRECTION FACTOR (dB/m)
1	5000.00	57.6 PK	74.0	-16.4	1.46 H	288	51.50	6.10
2	5000.00	46.7 AV	54.0	-7.3	1.46 H	288	40.60	6.10
3	*5795.00	104.3 PK			1.40 H	316	63.60	40.70
4	*5795.00	93.7 AV			1.40 H	316	53.00	40.70
5	11590.00	59.7 PK	74.0	-14.3	1.01 H	219	40.80	18.90
6	11590.00	46.6 AV	54.0	-7.4	1.01 H	219	27.70	18.90

ANTENNA POLARITY & TEST DISTANCE: VERTICAL AT 3 M

NO.	FREQ. (MHz)	EMISSION LEVEL (dBuV/m)	LIMIT (dBuV/m)	MARGIN (dB)	ANTENNA HEIGHT (m)	TABLE ANGLE (Degree)	RAW VALUE (dBuV)	CORRECTION FACTOR (dB/m)
1	5000.00	61.4 PK	74.0	-12.6	1.02 V	297	55.30	6.10
2	5000.00	52.1 AV	54.0	-1.9	1.02 V	297	46.00	6.10
3	*5795.00	110.2 PK			1.12 V	338	69.50	40.70
4	*5795.00	100.1 AV			1.12 V	338	59.40	40.70
5	11590.00	60.1 PK	74.0	-13.9	1.02 V	272	41.20	18.90
6	11590.00	47.0 AV	54.0	-7.0	1.02 V	272	28.10	18.90

REMARKS:

1. Emission Level(dBuV/m) = Raw Value(dBuV) + Correction Factor(dB/m)
2. Correction Factor(dB/m) = Antenna Factor(dB/m) + Cable Factor(dB) – Pre-Amplifier Factor(dB)
3. The other emission levels were very low against the limit.
4. Margin value = Emission Level – Limit value



A D T

CHANNEL	TX Channel 159	DETECTOR FUNCTION	Peak (PK)
FREQUENCY RANGE	1GHz ~ 40GHz		Average (AV)

ANTENNA POLARITY & TEST DISTANCE: HORIZONTAL AT 3 M

NO.	FREQ. (MHz)	EMISSION LEVEL (dBuV/m)	LIMIT (dBuV/m)	MARGIN (dB)	ANTENNA HEIGHT (m)	TABLE ANGLE (Degree)	RAW VALUE (dBuV)	CORRECTION FACTOR (dB/m)
1	5000.00	58.6 PK	74.0	-15.4	1.55 H	275	52.50	6.10
2	5000.00	47.6 AV	54.0	-6.4	1.55 H	275	41.50	6.10
3	*5755.00	103.7 PK			1.05 H	323	63.00	40.70
4	*5755.00	93.7 AV			1.05 H	323	53.00	40.70
5	11510.00	59.8 PK	74.0	-14.2	1.06 H	222	41.10	18.70
6	11510.00	47.0 AV	54.0	-7.0	1.06 H	222	28.30	18.70

ANTENNA POLARITY & TEST DISTANCE: VERTICAL AT 3 M

NO.	FREQ. (MHz)	EMISSION LEVEL (dBuV/m)	LIMIT (dBuV/m)	MARGIN (dB)	ANTENNA HEIGHT (m)	TABLE ANGLE (Degree)	RAW VALUE (dBuV)	CORRECTION FACTOR (dB/m)
1	5000.00	59.3 PK	74.0	-14.7	1.04 V	297	53.20	6.10
2	5000.00	52.1 AV	54.0	-1.9	1.04 V	297	46.00	6.10
3	*5755.00	111.7 PK			1.02 V	336	71.00	40.70
4	*5755.00	100.7 AV			1.02 V	336	60.00	40.70
5	11510.00	59.4 PK	74.0	-14.6	1.00 V	256	40.70	18.70
6	11510.00	46.3 AV	54.0	-7.7	1.00 V	256	27.60	18.70

REMARKS:

1. Emission Level(dBuV/m) = Raw Value(dBuV) + Correction Factor(dB/m)
2. Correction Factor(dB/m) = Antenna Factor(dB/m) + Cable Factor(dB) – Pre-Amplifier Factor(dB)
3. The other emission levels were very low against the limit.
4. Margin value = Emission Level – Limit value



A D T

BELOW 1GHz WORST-CASE DATA

802.11a

CHANNEL	TX Channel 149	DETECTOR FUNCTION	Quasi-Peak (QP)
FREQUENCY RANGE	30MHz ~ 1GHz		
TEST MODE	A		

ANTENNA POLARITY & TEST DISTANCE: HORIZONTAL AT 3 M

NO.	FREQ. (MHz)	EMISSION LEVEL (dBuV/m)	LIMIT (dBuV/m)	MARGIN (dB)	ANTENNA HEIGHT (m)	TABLE ANGLE (Degree)	RAW VALUE (dBuV)	CORRECTION FACTOR (dB/m)
1	57.12	29.8 QP	40.0	-10.2	1.24 H	313	44.50	-14.70
2	175.72	26.4 QP	43.5	-17.1	1.24 H	267	41.20	-14.80
3	249.60	28.1 QP	46.0	-17.9	1.99 H	110	42.40	-14.30
4	375.98	25.6 QP	46.0	-20.4	1.00 H	15	36.40	-10.80
5	500.42	24.8 QP	46.0	-21.2	1.00 H	328	33.20	-8.40
6	731.79	32.8 QP	46.0	-13.2	1.49 H	138	36.50	-3.70

ANTENNA POLARITY & TEST DISTANCE: VERTICAL AT 3 M

NO.	FREQ. (MHz)	EMISSION LEVEL (dBuV/m)	LIMIT (dBuV/m)	MARGIN (dB)	ANTENNA HEIGHT (m)	TABLE ANGLE (Degree)	RAW VALUE (dBuV)	CORRECTION FACTOR (dB/m)
1	84.34	32.1 QP	40.0	-7.9	1.99 V	128	51.60	-19.50
2	162.11	28.8 QP	43.5	-14.7	1.49 V	71	42.70	-13.90
3	249.60	24.8 QP	46.0	-21.2	1.00 V	164	39.10	-14.30
4	449.87	26.9 QP	46.0	-19.1	1.24 V	199	36.10	-9.20
5	500.42	30.4 QP	46.0	-15.6	1.00 V	206	38.80	-8.40
6	685.13	28.4 QP	46.0	-17.6	1.24 V	18	33.10	-4.70

REMARKS:

1. Emission Level(dBuV/m) = Raw Value(dBuV) + Correction Factor(dB/m)
2. Correction Factor(dB/m) = Antenna Factor(dB/m) + Cable Factor(dB) – Pre-Amplifier Factor(dB)
3. The other emission levels were very low against the limit.
4. Margin value = Emission Level – Limit value



A D T

CHANNEL	TX Channel 149	DETECTOR FUNCTION	Quasi-Peak (QP)
FREQUENCY RANGE	30MHz ~ 1GHz		
TEST MODE	B		

ANTENNA POLARITY & TEST DISTANCE: HORIZONTAL AT 3 M								
NO.	FREQ. (MHz)	EMISSION LEVEL (dBuV/m)	LIMIT (dBuV/m)	MARGIN (dB)	ANTENNA HEIGHT (m)	TABLE ANGLE (Degree)	RAW VALUE (dBuV)	CORRECTION FACTOR (dB/m)
1	57.12	33.2 QP	40.0	-6.8	2.00 H	293	47.90	-14.70
2	177.67	26.7 QP	43.5	-16.8	2.00 H	81	41.70	-15.00
3	375.98	32.1 QP	46.0	-13.9	1.01 H	214	42.90	-10.80
4	560.69	33.9 QP	46.0	-12.1	1.50 H	215	41.20	-7.30
5	799.84	41.6 QP	46.0	-4.4	1.01 H	133	43.80	-2.20
6	1000.00	32.9 QP	54.0	-21.1	1.26 H	127	32.10	0.80
ANTENNA POLARITY & TEST DISTANCE: VERTICAL AT 3 M								
NO.	FREQ. (MHz)	EMISSION LEVEL (dBuV/m)	LIMIT (dBuV/m)	MARGIN (dB)	ANTENNA HEIGHT (m)	TABLE ANGLE (Degree)	RAW VALUE (dBuV)	CORRECTION FACTOR (dB/m)
1	68.79	32.3 QP	40.0	-7.7	1.00 V	10	48.40	-16.10
2	107.67	31.7 QP	43.5	-11.8	1.00 V	99	49.40	-17.70
3	375.98	30.6 QP	46.0	-15.4	1.24 V	112	41.40	-10.80
4	599.58	28.2 QP	46.0	-17.8	1.00 V	290	34.40	-6.20
5	799.84	39.3 QP	46.0	-6.7	1.24 V	231	41.50	-2.20
6	1000.00	32.5 QP	54.0	-21.5	1.99 V	5	31.70	0.80

REMARKS:

1. Emission Level(dBuV/m) = Raw Value(dBuV) + Correction Factor(dB/m)
2. Correction Factor(dB/m) = Antenna Factor(dB/m) + Cable Factor(dB)
– Pre-Amplifier Factor(dB)
3. The other emission levels were very low against the limit.
4. Margin value = Emission Level – Limit value



A D T

CHANNEL	TX Channel 149	DETECTOR FUNCTION	Quasi-Peak (QP)
FREQUENCY RANGE	30MHz ~ 1GHz		
TEST MODE	C		

ANTENNA POLARITY & TEST DISTANCE: HORIZONTAL AT 3 M

NO.	FREQ. (MHz)	EMISSION LEVEL (dBuV/m)	LIMIT (dBuV/m)	MARGIN (dB)	ANTENNA HEIGHT (m)	TABLE ANGLE (Degree)	RAW VALUE (dBuV)	CORRECTION FACTOR (dB/m)
1	57.12	29.5 QP	40.0	-10.5	1.99 H	0	44.20	-14.70
2	158.22	26.8 QP	43.5	-16.7	1.00 H	114	40.70	-13.90
3	249.60	24.0 QP	46.0	-22.0	1.49 H	112	38.30	-14.30
4	375.98	28.6 QP	46.0	-17.4	1.24 H	60	39.40	-10.80
5	696.79	30.9 QP	46.0	-15.1	1.00 H	192	35.30	-4.40
6	799.84	38.7 QP	46.0	-7.3	1.49 H	132	40.90	-2.20

ANTENNA POLARITY & TEST DISTANCE: VERTICAL AT 3 M

NO.	FREQ. (MHz)	EMISSION LEVEL (dBuV/m)	LIMIT (dBuV/m)	MARGIN (dB)	ANTENNA HEIGHT (m)	TABLE ANGLE (Degree)	RAW VALUE (dBuV)	CORRECTION FACTOR (dB/m)
1	57.12	29.5 QP	40.0	-10.5	1.00 V	29	44.20	-14.70
2	72.67	29.0 QP	40.0	-11.0	1.24 V	178	46.10	-17.10
3	375.98	26.2 QP	46.0	-19.8	1.49 V	21	37.00	-10.80
4	500.42	30.5 QP	46.0	-15.5	1.00 V	204	38.90	-8.40
5	599.58	26.5 QP	46.0	-19.5	1.49 V	5	32.70	-6.20
6	799.84	35.8 QP	46.0	-10.2	1.00 V	199	38.00	-2.20

REMARKS:

1. Emission Level(dBuV/m) = Raw Value(dBuV) + Correction Factor(dB/m)
2. Correction Factor(dB/m) = Antenna Factor(dB/m) + Cable Factor(dB)
– Pre-Amplifier Factor(dB)
3. The other emission levels were very low against the limit.
4. Margin value = Emission Level – Limit value

5.2 CONDUCTED EMISSION MEASUREMENT

5.2.1 LIMITS OF CONDUCTED EMISSION MEASUREMENT

FREQUENCY OF EMISSION (MHz)	CONDUCTED LIMIT (dB μ V)	
	Quasi-peak	Average
0.15 ~ 0.5	66 to 56	56 to 46
0.5 ~ 5	56	46
5 ~ 30	60	50

- NOTE:**
1. The lower limit shall apply at the transition frequencies.
 2. The limit decreases in line with the logarithm of the frequency in the range of 0.15 to 0.50MHz.
 3. All emanations from a class A/B digital device or system, including any network of conductors and apparatus connected thereto, shall not exceed the level of field strengths specified above.

5.2.2 TEST INSTRUMENTS

Same as item 4.2.2.

5.2.3 TEST PROCEDURES

Same as item 4.2.3.

5.2.4 DEVIATION FROM TEST STANDARD

No deviation.

5.2.5 TEST SETUP

Same as item 4.2.5.

5.2.6 EUT OPERATING CONDITIONS

Same as item 4.1.6.

5.2.7 TEST RESULTS

CONDUCTED WORST-CASE DATA : 802.11a

PHASE	Line 1	6dB BANDWIDTH	9kHz
TEST MODE	A		

No	Freq. [MHz]	Corr. Factor (dB)	Reading Value		Emission Level		Limit		Margin	
			[dB (uV)]		[dB (uV)]		[dB (uV)]		(dB)	
			Q.P.	AV.	Q.P.	AV.	Q.P.	AV.	Q.P.	AV.
1	0.17374	0.10	45.34	30.48	45.44	30.58	64.78	54.78	-19.34	-24.20
2	0.20474	0.09	41.64	28.28	41.73	28.37	63.42	53.42	-21.69	-25.05
3	0.52960	0.13	41.43	34.20	41.56	34.33	56.00	46.00	-14.44	-11.67
4	4.66996	0.29	38.22	31.73	38.51	32.02	56.00	46.00	-17.49	-13.98
5	6.60541	0.39	38.56	32.59	38.95	32.98	60.00	50.00	-21.05	-17.02
6	9.19383	0.51	37.01	29.97	37.52	30.48	60.00	50.00	-22.48	-19.52

REMARKS:

1. Q.P. and AV. are abbreviations of quasi-peak and average individually.
2. The emission levels of other frequencies were very low against the limit.
3. Margin value = Emission level - Limit value
4. Correction factor = Insertion loss + Cable loss
5. Emission Level = Correction Factor + Reading Value

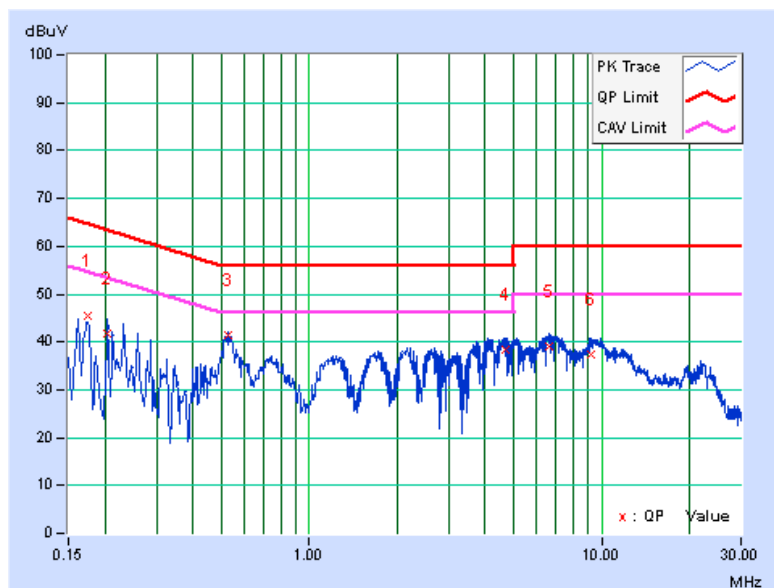

PHASE	Line 2	6dB BANDWIDTH	9kHz
TEST MODE	A		

No	Freq. [MHz]	Corr. Factor (dB)	Reading Value		Emission Level		Limit		Margin	
			[dB (uV)]		[dB (uV)]		[dB (uV)]		(dB)	
			Q.P.	AV.	Q.P.	AV.	Q.P.	AV.	Q.P.	AV.
1	0.15000	0.05	48.12	30.01	48.17	30.06	66.00	56.00	-17.83	-25.94
2	0.21256	0.10	40.73	26.02	40.83	26.12	63.10	53.10	-22.28	-26.99
3	0.52130	0.18	41.23	34.50	41.41	34.68	56.00	46.00	-14.59	-11.32
4	4.74816	0.29	39.31	30.86	39.60	31.15	56.00	46.00	-16.40	-14.85
5	7.09025	0.40	42.12	35.31	42.52	35.71	60.00	50.00	-17.48	-14.29
6	9.69040	0.53	43.98	38.42	44.51	38.95	60.00	50.00	-15.49	-11.05

REMARKS:

1. Q.P. and AV. are abbreviations of quasi-peak and average individually.
2. The emission levels of other frequencies were very low against the limit.
3. Margin value = Emission level - Limit value
4. Correction factor = Insertion loss + Cable loss
5. Emission Level = Correction Factor + Reading Value

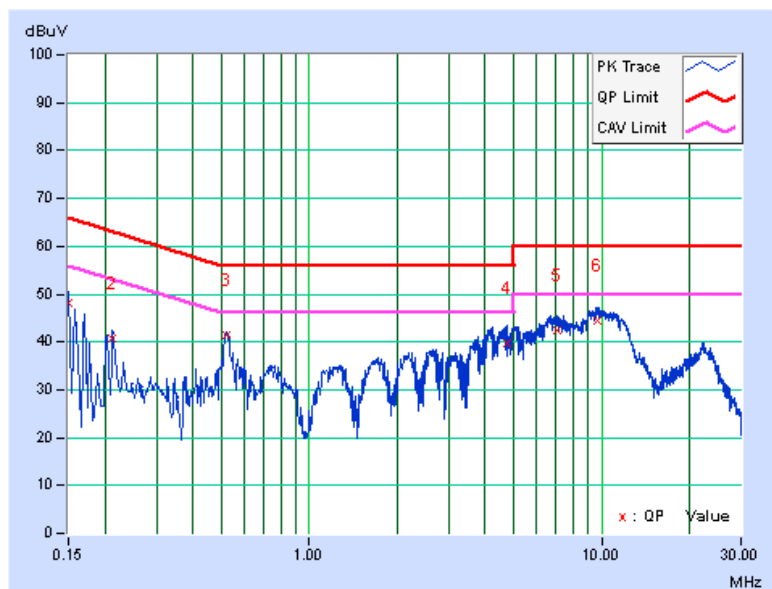



A D T

PHASE	Line 1	6dB BANDWIDTH	9kHz
TEST MODE	B		

No	Freq. [MHz]	Corr. Factor (dB)	Reading Value		Emission Level		Limit		Margin	
			[dB (uV)]		[dB (uV)]		[dB (uV)]		(dB)	
			Q.P.	AV.	Q.P.	AV.	Q.P.	AV.	Q.P.	AV.
1	0.16139	0.11	44.00	30.68	44.11	30.79	65.39	55.39	-21.29	-24.61
2	0.29120	0.10	45.41	36.31	45.51	36.41	60.49	50.49	-14.98	-14.08
3	0.45498	0.12	39.36	28.05	39.48	28.17	56.78	46.78	-17.30	-18.61
4	2.44517	0.25	38.19	26.68	38.44	26.93	56.00	46.00	-17.56	-19.07
5	19.70782	1.09	47.84	43.50	48.93	44.59	60.00	50.00	-11.07	-5.41
6	21.66282	1.16	49.02	45.62	50.18	46.78	60.00	50.00	-9.82	-3.22

REMARKS:

1. Q.P. and AV. are abbreviations of quasi-peak and average individually.
2. The emission levels of other frequencies were very low against the limit.
3. Margin value = Emission level - Limit value
4. Correction factor = Insertion loss + Cable loss
5. Emission Level = Correction Factor + Reading Value

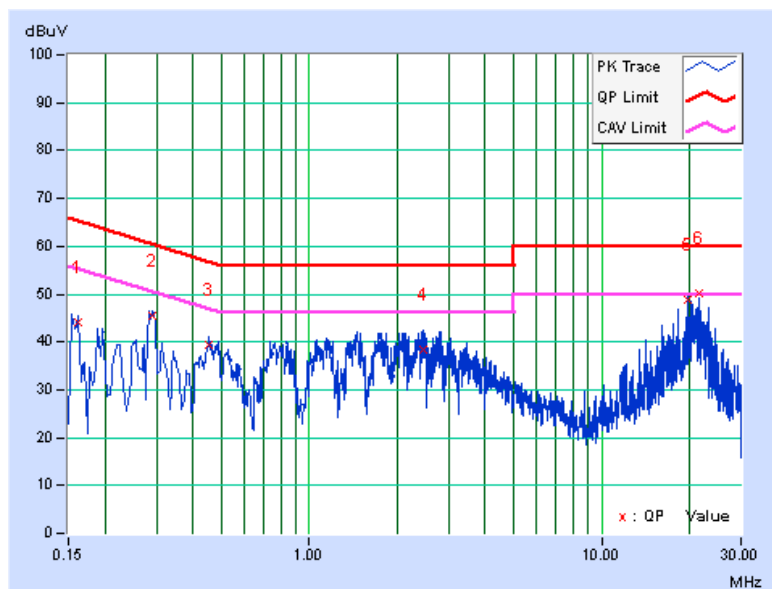



A D T

PHASE	Line 2	6dB BANDWIDTH	9kHz
TEST MODE	B		

No	Freq. [MHz]	Corr. Factor (dB)	Reading Value		Emission Level		Limit		Margin	
			[dB (uV)]		[dB (uV)]		[dB (uV)]		(dB)	
			Q.P.	AV.	Q.P.	AV.	Q.P.	AV.	Q.P.	AV.
1	0.16173	0.06	44.42	29.17	44.48	29.23	65.37	55.37	-20.90	-26.15
2	0.29120	0.13	42.20	31.11	42.33	31.24	60.49	50.49	-18.16	-19.25
3	0.48626	0.18	34.96	22.90	35.14	23.08	56.23	46.23	-21.09	-23.15
4	2.10500	0.22	34.34	22.48	34.56	22.70	56.00	46.00	-21.44	-23.30
5	20.38034	1.03	44.76	37.86	45.79	38.89	60.00	50.00	-14.21	-11.11
6	21.66282	1.06	45.93	41.30	46.99	42.36	60.00	50.00	-13.01	-7.64

REMARKS:

1. Q.P. and AV. are abbreviations of quasi-peak and average individually.
2. The emission levels of other frequencies were very low against the limit.
3. Margin value = Emission level - Limit value
4. Correction factor = Insertion loss + Cable loss
5. Emission Level = Correction Factor + Reading Value

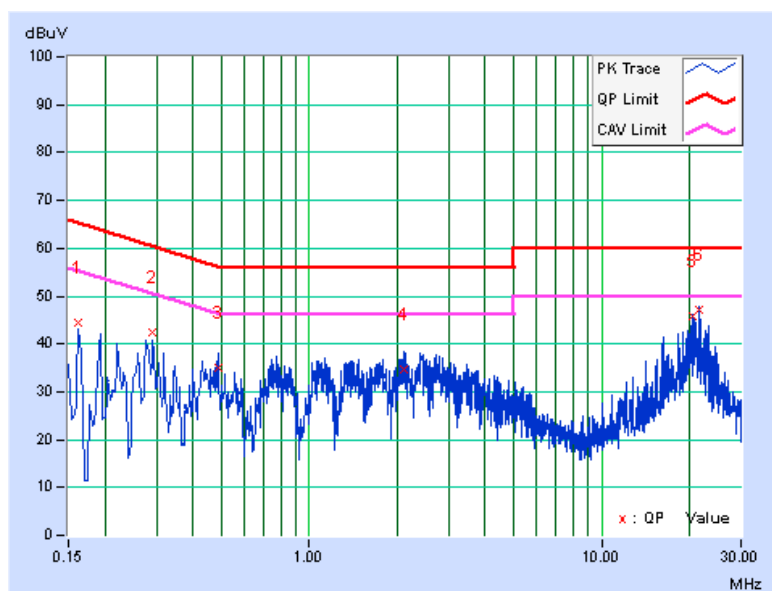



A D T

PHASE	Line 1	6dB BANDWIDTH	9kHz
TEST MODE	C		

No	Freq. [MHz]	Corr. Factor (dB)	Reading Value		Emission Level		Limit		Margin	
			[dB (uV)]		[dB (uV)]		[dB (uV)]		(dB)	
			Q.P.	AV.	Q.P.	AV.	Q.P.	AV.	Q.P.	AV.
1	0.15391	0.11	38.00	27.73	38.11	27.84	65.79	55.79	-27.68	-27.95
2	0.18519	0.10	34.37	24.56	34.47	24.66	64.25	54.25	-29.78	-29.59
3	0.21282	0.09	31.63	24.14	31.72	24.23	63.09	53.09	-31.37	-28.86
4	0.47062	0.12	35.51	24.23	35.63	24.35	56.50	46.50	-20.87	-22.15
5	1.26018	0.22	23.41	18.22	23.63	18.44	56.00	46.00	-32.37	-27.56
6	5.32684	0.32	24.35	17.22	24.67	17.54	60.00	50.00	-35.33	-32.46

REMARKS:

1. Q.P. and AV. are abbreviations of quasi-peak and average individually.
2. The emission levels of other frequencies were very low against the limit.
3. Margin value = Emission level - Limit value
4. Correction factor = Insertion loss + Cable loss
5. Emission Level = Correction Factor + Reading Value

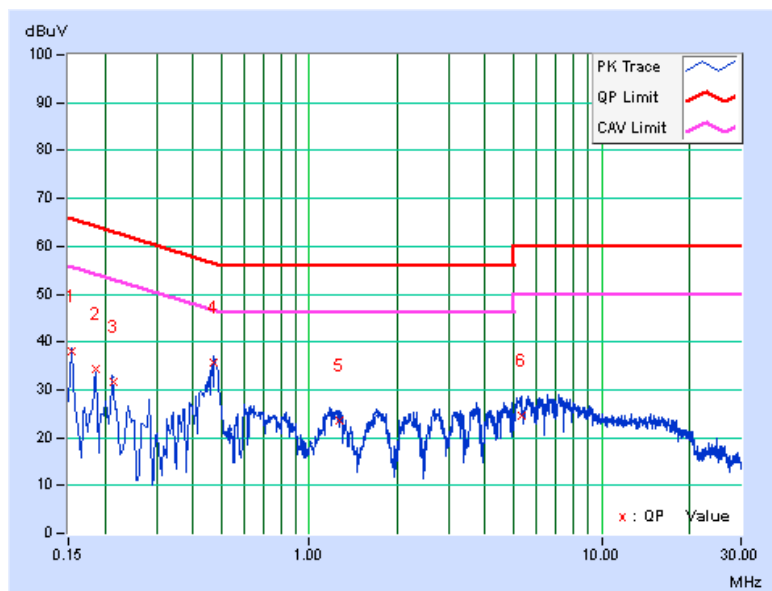



A D T

PHASE	Line 2	6dB BANDWIDTH	9kHz
TEST MODE	C		

No	Freq. [MHz]	Corr. Factor (dB)	Reading Value		Emission Level		Limit		Margin	
			[dB (uV)]		[dB (uV)]		[dB (uV)]		(dB)	
			Q.P.	AV.	Q.P.	AV.	Q.P.	AV.	Q.P.	AV.
1	0.18519	0.08	33.12	20.12	33.20	20.20	64.25	54.25	-31.05	-34.05
2	0.47062	0.18	31.85	20.11	32.03	20.29	56.50	46.50	-24.48	-26.22
3	0.86944	0.21	22.85	15.36	23.06	15.57	56.00	46.00	-32.94	-30.43
4	1.19397	0.22	26.42	17.61	26.64	17.83	56.00	46.00	-29.36	-28.17
5	1.67881	0.22	24.01	15.88	24.23	16.10	56.00	46.00	-31.77	-29.90
6	6.30394	0.37	22.95	16.87	23.32	17.24	60.00	50.00	-36.68	-32.76

REMARKS:

1. Q.P. and AV. are abbreviations of quasi-peak and average individually.
2. The emission levels of other frequencies were very low against the limit.
3. Margin value = Emission level - Limit value
4. Correction factor = Insertion loss + Cable loss
5. Emission Level = Correction Factor + Reading Value

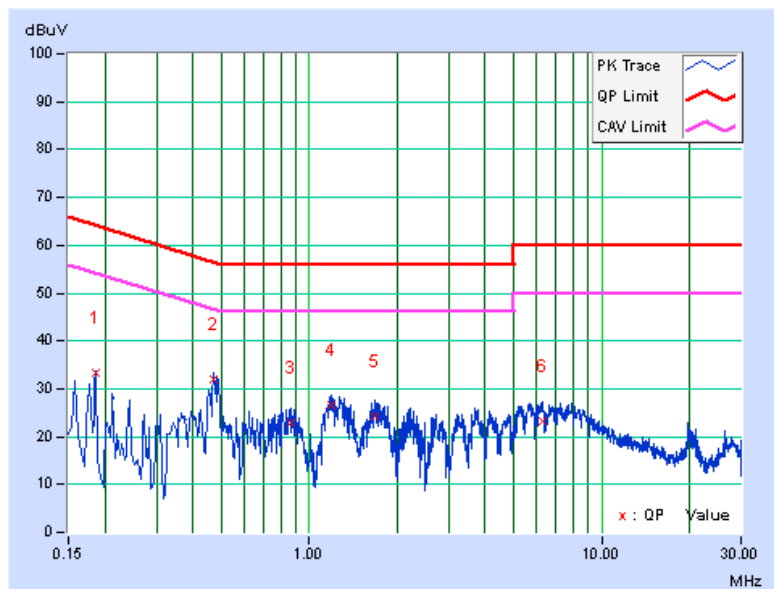

5.3 6dB BANDWIDTH MEASUREMENT

5.3.1 LIMITS OF 6dB BANDWIDTH MEASUREMENT

The minimum of 6dB Bandwidth Measurement is 0.5MHz.

5.3.2 TEST SETUP

Same as item 4.3.2.

5.3.3 TEST INSTRUMENTS

Refer to section 4.1.2 to get information of above instrument.

5.3.4 TEST PROCEDURE

Same as item 4.3.4.

5.3.5 DEVIATION FROM TEST STANDARD

No deviation.

5.3.6 EUT OPERATING CONDITIONS

Same as item 4.3.6.

5.3.7 TEST RESULTS

802.11a

CHANNEL	FREQUENCY (MHz)	6dB BANDWIDTH (MHz)		MINIMUM LIMIT (MHz)	PASS / FAIL
		CHAIN 0	CHAIN 1		
149	5745	15.36	16.40	0.5	PASS
157	5785	16.37	16.41	0.5	PASS
165	5825	16.12	16.39	0.5	PASS

802.11n (20MHz)

CHANNEL	FREQUENCY (MHz)	6dB BANDWIDTH (MHz)		MINIMUM LIMIT (MHz)	PASS / FAIL
		CHAIN 0	CHAIN 1		
149	5745	17.63	17.64	0.5	PASS
157	5785	17.25	17.62	0.5	PASS
165	5825	16.67	17.36	0.5	PASS

802.11n (40MHz)

CHANNEL	FREQUENCY (MHz)	6dB BANDWIDTH (MHz)		MINIMUM LIMIT (MHz)	PASS / FAIL
		CHAIN 0	CHAIN 1		
151	5755	36.19	36.01	0.5	PASS
159	5795	35.86	36.44	0.5	PASS



A D T

SPECTRUM PLOT OF WORST VALUE

802.11a

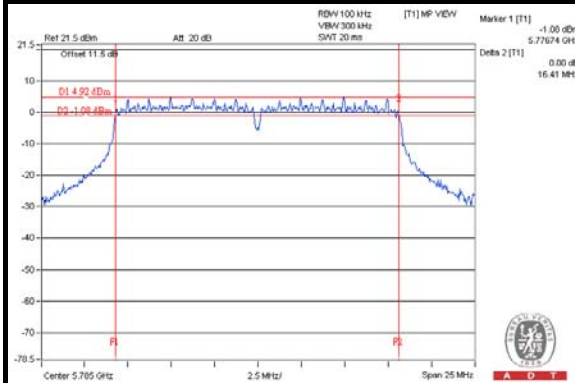

802.11n (20MHz)

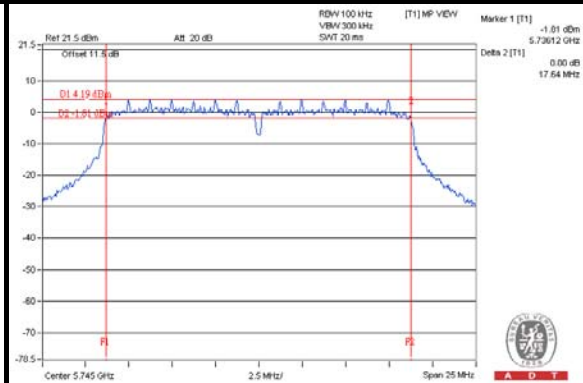

802.11n (40MHz)

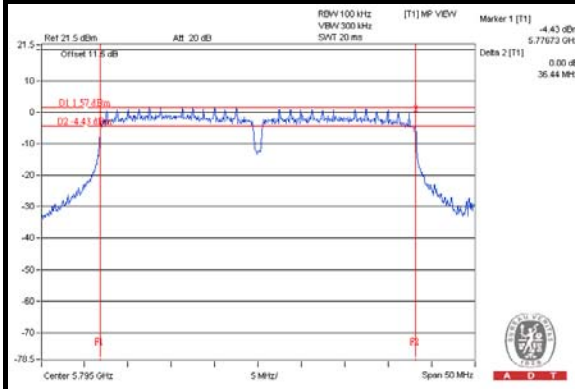

5.4 CONDUCTED OUTPUT POWER

5.4.1 LIMITS OF CONDUCTED OUTPUT POWER MEASUREMENT

For systems using digital modulation in the 5725 –5850 MHz bands: 1 Watt (30dBm)

Per KDB 662911 D01 Multiple Transmitter Output v02r01 Method of conducted output power measurement on IEEE 802.11 devices,

Array Gain = 0 dB (i.e., no array gain) for NANT \leq 4;

Array Gain = 0 dB (i.e., no array gain) for channel widths \geq 40 MHz for any NANT;

Array Gain = 5 log(NANT/NSS) dB or 3 dB, whichever is less for 20-MHz channel widths with NANT \geq 5.

For power measurements on all other devices: Array Gain = 10 log(NANT/NSS) dB.

5.4.2 TEST SETUP

Same as Item 4.4.2.

5.4.3 INSTRUMENTS

Refer to section 4.1.2 to get information of above instrument.

5.4.4 TEST PROCEDURES

Same as Item 4.4.4.

5.4.5 DEVIATION FROM TEST STANDARD

No deviation.

5.4.6 EUT OPERATING CONDITIONS

Same as Item 4.3.6.



A D T

5.4.7 TEST RESULTS

802.11a

CHAN.	CHAN. FREQ. (MHz)	AVG. POWER (dBm)		TOTAL POWER (mW)	TOTAL POWER (dBm)	LIMIT (dBm)	PASS / FAIL
		CHAIN 0	CHAIN 1				
149	5745	18.12	18.01	128.104	21.08	30	PASS
157	5785	18.03	18.17	129.148	21.11	30	PASS
165	5825	18.31	17.70	126.648	21.03	30	PASS

802.11n (20MHz)

CHAN.	CHAN. FREQ. (MHz)	AVG. POWER (dBm)		TOTAL POWER (mW)	TOTAL POWER (dBm)	LIMIT (dBm)	PASS / FAIL
		CHAIN 0	CHAIN 1				
149	5745	17.84	17.43	116.149	20.65	30	PASS
157	5785	17.92	17.43	117.279	20.69	30	PASS
165	5825	17.59	16.64	103.544	20.15	30	PASS

802.11n (40MHz)

CHAN.	CHAN. FREQ. (MHz)	AVG. POWER (dBm)		TOTAL POWER (mW)	TOTAL POWER (dBm)	LIMIT (dBm)	PASS / FAIL
		CHAIN 0	CHAIN 1				
151	5755	17.33	16.91	103.166	20.14	30	PASS
159	5795	17.50	16.75	103.549	20.15	30	PASS

5.5 POWER SPECTRAL DENSITY MEASUREMENT

5.5.1 LIMITS OF POWER SPECTRAL DENSITY MEASUREMENT

The Maximum of Power Spectral Density Measurement is 8dBm.

5.5.2 TEST SETUP

Same as item 4.5.2.

5.5.3 TEST INSTRUMENTS

Refer to section 4.1.2 to get information of above instrument.

5.5.4 TEST PROCEDURE.

Same as item 4.5.4.

5.5.5 DEVIATION FROM TEST STANDARD

No deviation.

5.5.6 EUT OPERATING CONDITION

Same as item 4.3.6.

5.5.7 TEST RESULTS

802.11a

TX chain	Channel	Freq. (MHz)	PSD (dBm)	10 log (N=2) dB	Duty Factor	Total PSD with Duty Factor (dBm)	Limit (dBm)	PASS /FAIL
0	149	5745	-12.89	3.01	0.36	-9.52	8	PASS
	157	5785	-12.56	3.01	0.36	-9.19	8	PASS
	165	5825	-12.38	3.01	0.36	-9.01	8	PASS
1	149	5745	-14.27	3.01	0.36	-10.90	8	PASS
	157	5785	-13.74	3.01	0.36	-10.37	8	PASS
	165	5825	-14.01	3.01	0.36	-10.64	8	PASS

NOTE: Directional gain = $10 \log[(10^{G1/20} + 10^{G2/20} + \dots + 10^{GN/20})^2] = 5.66\text{dBi} < 6\text{dBi}$, so the power density limit no need to reduced.

802.11n (20MHz)

TX chain	Channel	Freq. (MHz)	PSD (dBm)	10 log (N=2) dB	Duty Factor	Total PSD with Duty Factor (dBm)	Limit (dBm)	PASS /FAIL
0	149	5745	-13.35	3.01	0.33	-10.01	8	PASS
	157	5785	-13.15	3.01	0.33	-9.81	8	PASS
	165	5825	-13.22	3.01	0.33	-9.88	8	PASS
1	149	5745	-15.06	3.01	0.33	-11.72	8	PASS
	157	5785	-14.54	3.01	0.33	-11.20	8	PASS
	165	5825	-14.52	3.01	0.33	-11.18	8	PASS

NOTE: Directional gain = $10 \log[(10^{G1/20} + 10^{G2/20} + \dots + 10^{GN/20})^2] = 5.66\text{dBi} < 6\text{dBi}$, so the power density limit no need to reduced.

802.11n (40MHz)

TX chain	Channel	Freq. (MHz)	PSD (dBm)	10 log (N=2) dB	Duty Factor	Total PSD with Duty Factor (dBm)	Limit (dBm)	PASS /FAIL
0	151	5755	-16.81	3.01	0.34	-13.46	8	PASS
	159	5795	-16.27	3.01	0.34	-12.92	8	PASS
1	151	5755	-18.19	3.01	0.34	-14.84	8	PASS
	159	5795	-17.08	3.01	0.34	-13.73	8	PASS

NOTE: Directional gain = $10 \log[(10^{G1/20} + 10^{G2/20} + \dots + 10^{GN/20})^2] = 5.66\text{dBi} < 6\text{dBi}$, so the power density limit no need to reduced.



A D T

SPECTRUM PLOT OF WORST VALUE

802.11a

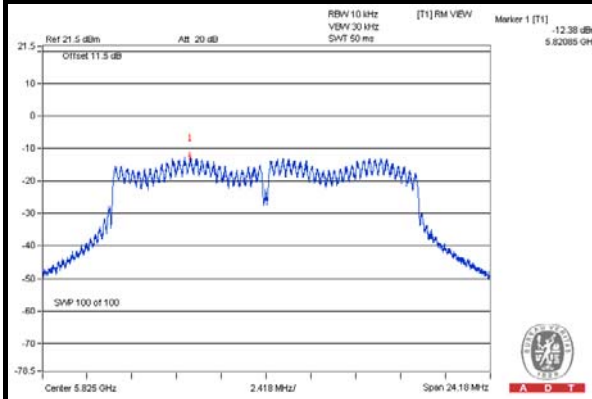

802.11n (20MHz)

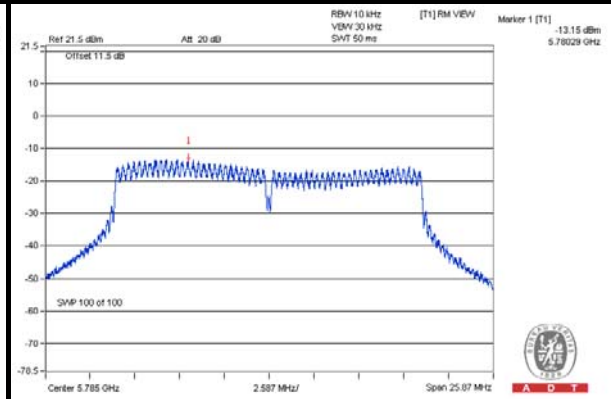

802.11n (40MHz)

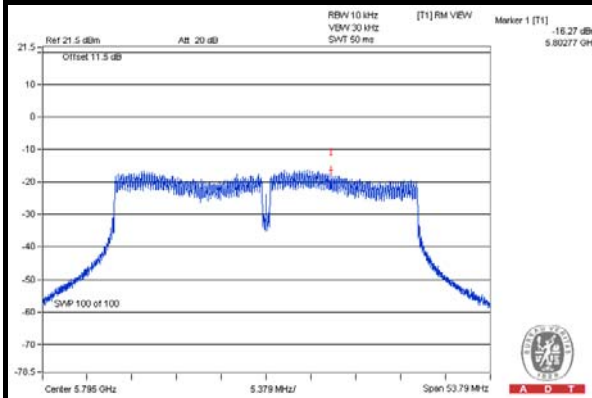

5.6 CONDUCTED OUT OF BAND EMISSION MEASUREMENT

5.6.1 LIMITS OF CONDUCTED OUT OF BAND EMISSION MEASUREMENT

Below -20dB of the highest emission level of operating band (in 100kHz Resolution Bandwidth).

5.6.2 TEST SETUP

Same as Item 4.6.2

5.6.3 TEST INSTRUMENTS

Refer to section 4.1.2 to get information of above instrument.

5.6.4 TEST PROCEDURE

Same as Item 4.6.4

5.6.5 DEVIATION FROM TEST STANDARD

No deviation.

5.6.6 EUT OPERATING CONDITION

Same as Item 4.3.6

5.6.7 TEST RESULTS

The conducted emission test is performed on each TX port of operating mode without summing or adding $10\log(N)$ since the limit is relative emission limit.

The spectrum plots are attached on the following pages. D1 line indicates the highest level, and D2 line indicates the 20dB offset below D1. It shows compliance with the requirement.



A D T

802.11a
CHAIN 0

CH 149

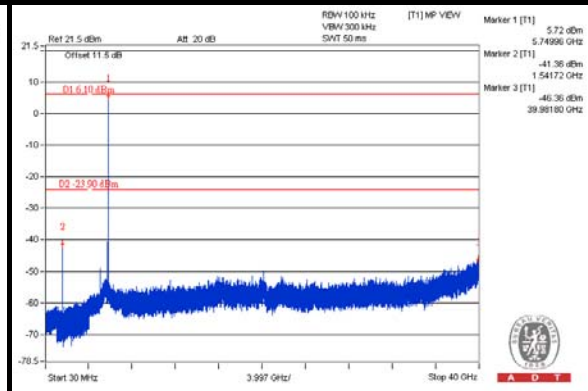
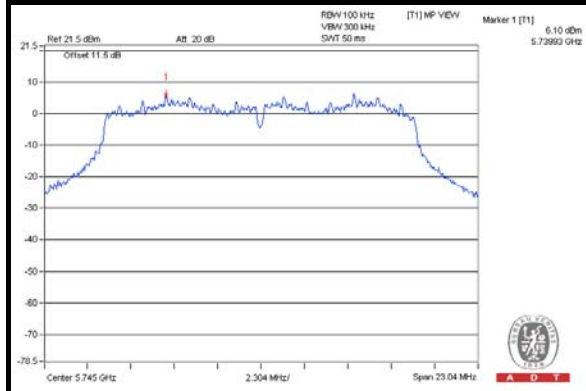

CH 157

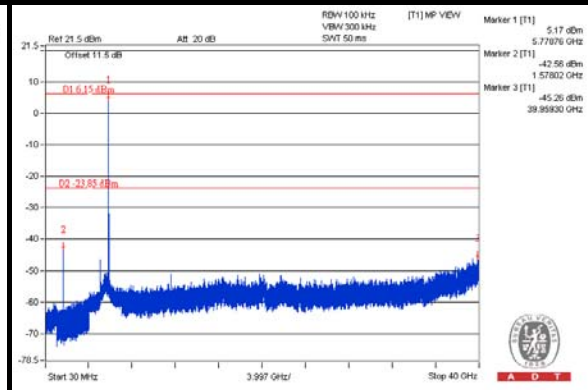
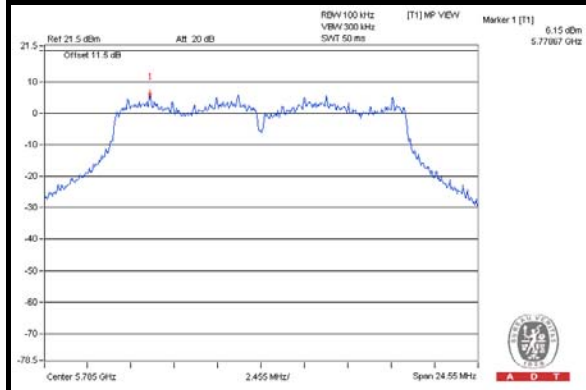

CH 165

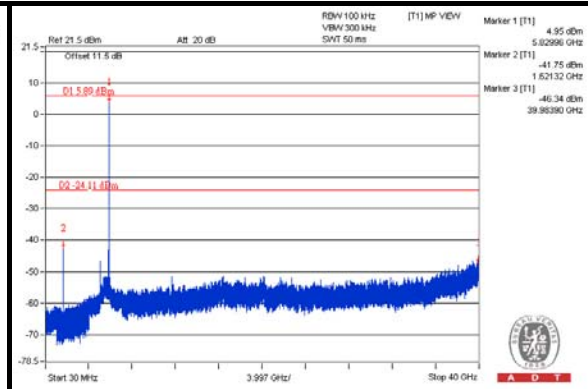
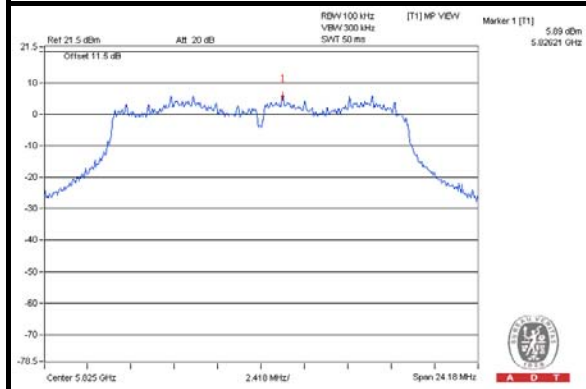

CH 149 Band edge

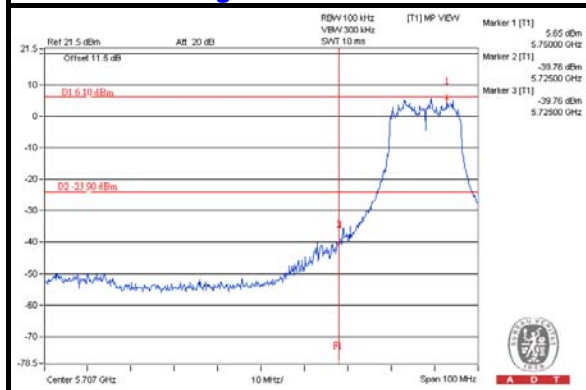

CH 165 Band edge

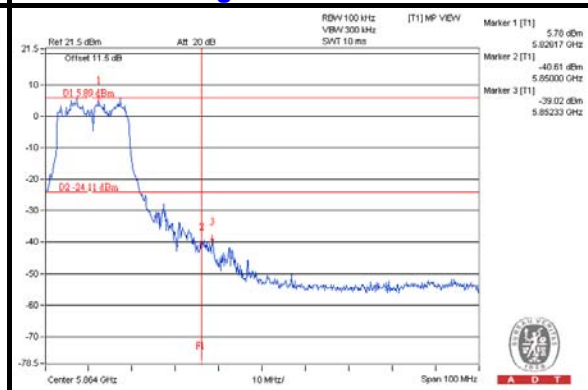

CHAIN 1

CH 149

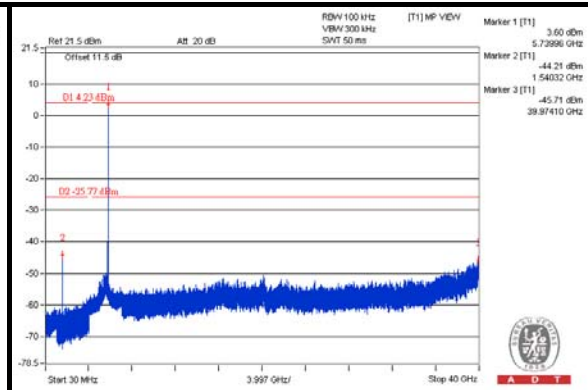
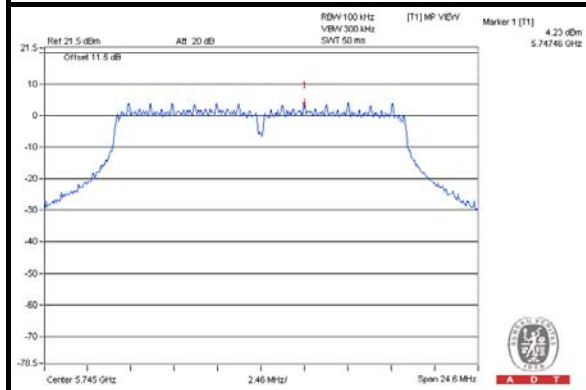

CH 157

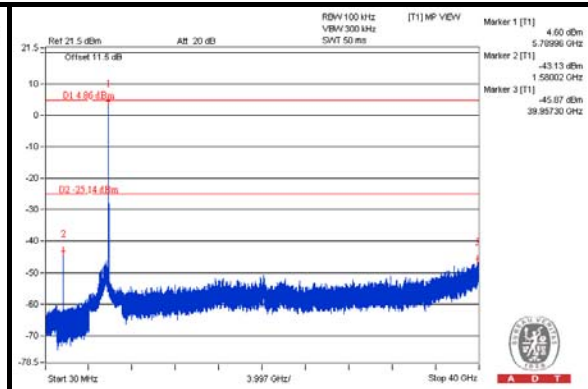
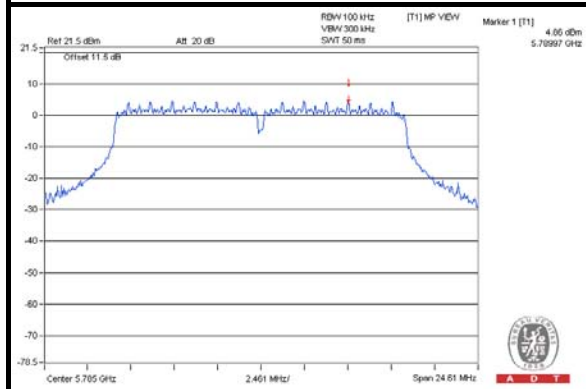

CH 165

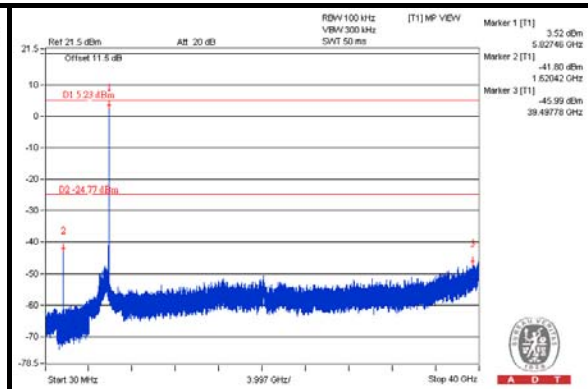
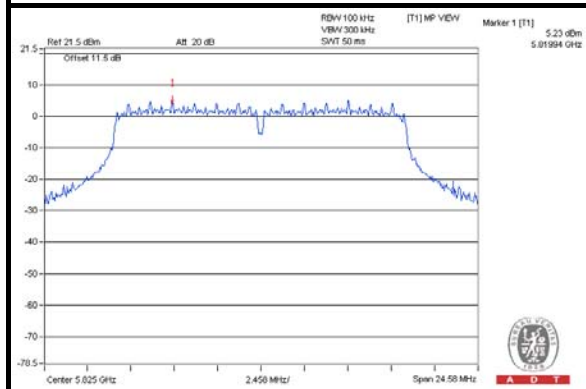

CH 149 Band edge

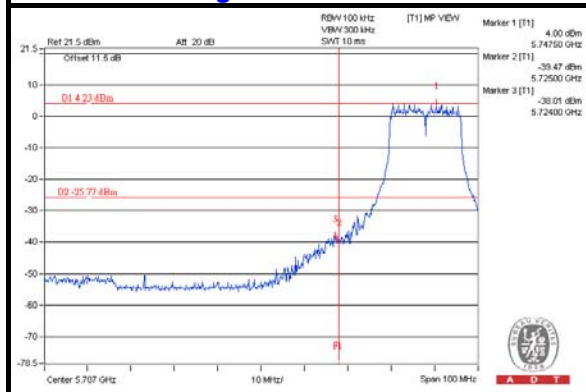

CH 165 Band edge

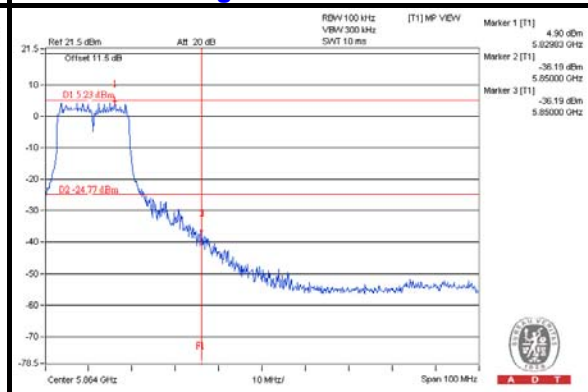



A D T

802.11n (20MHz) CHAIN 0

CH 149

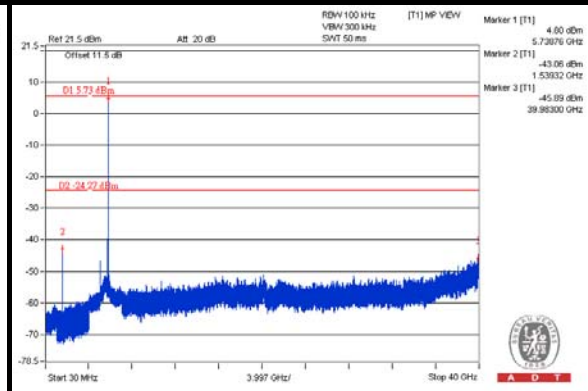
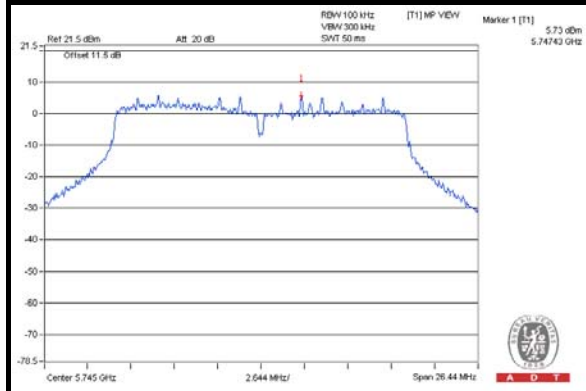

CH 157

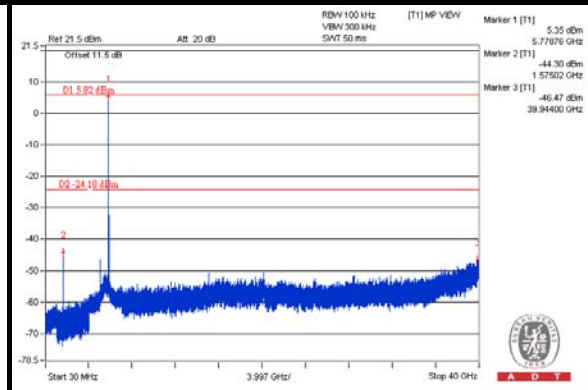
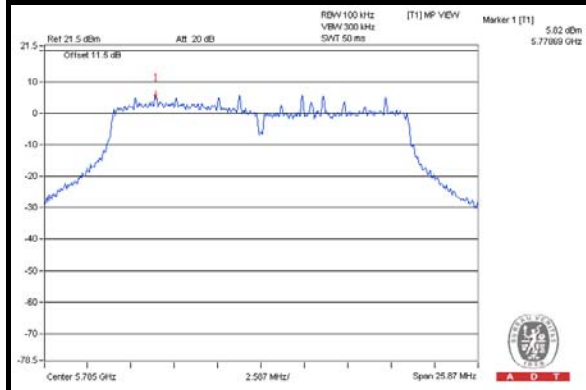

CH 165

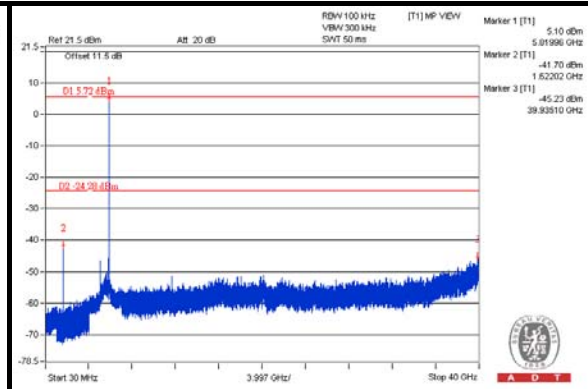
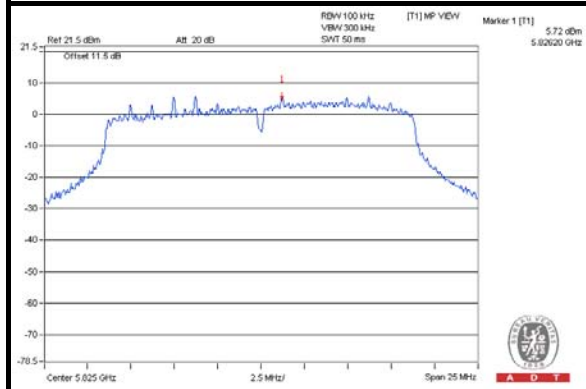

CH 149 Band edge

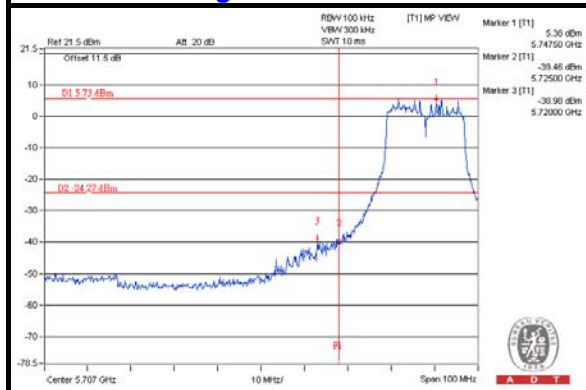

CH 165 Band edge

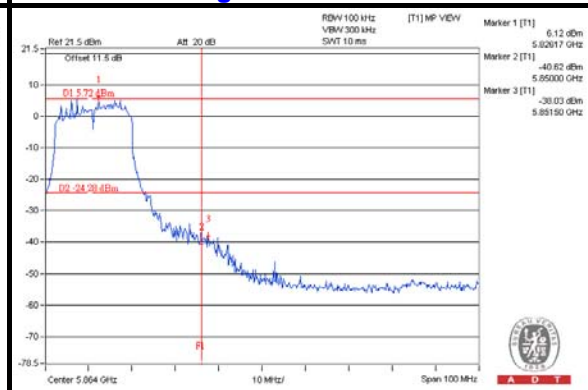



A D T

CHAIN 1

CH 149

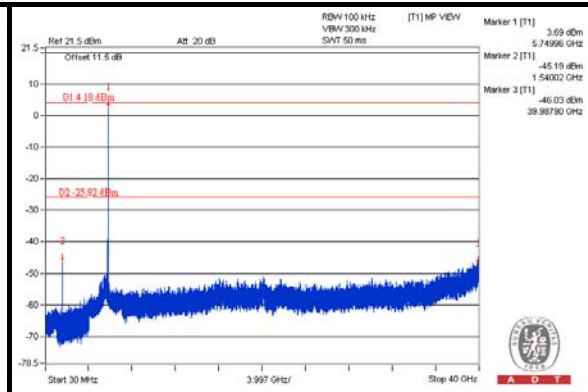
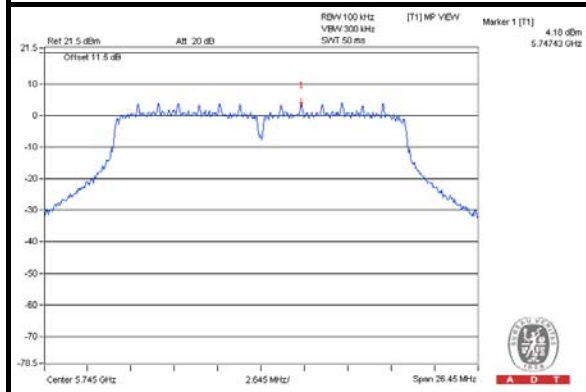

CH 157

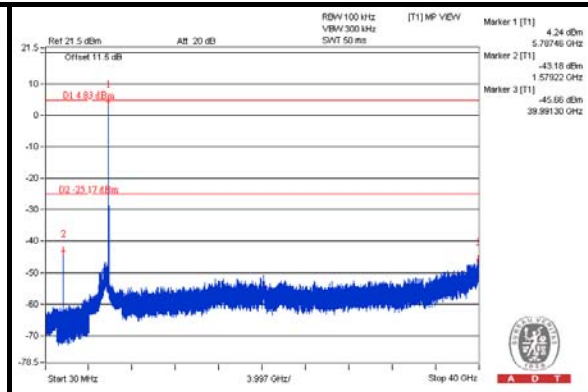
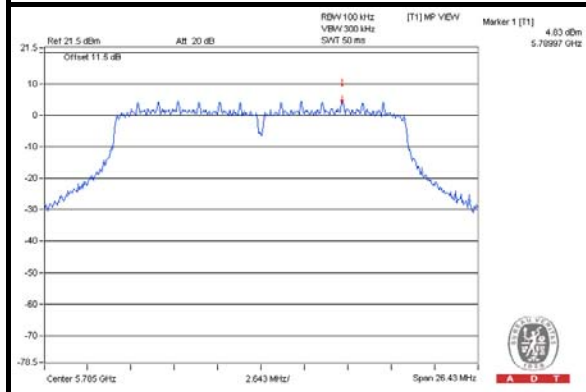

CH 165

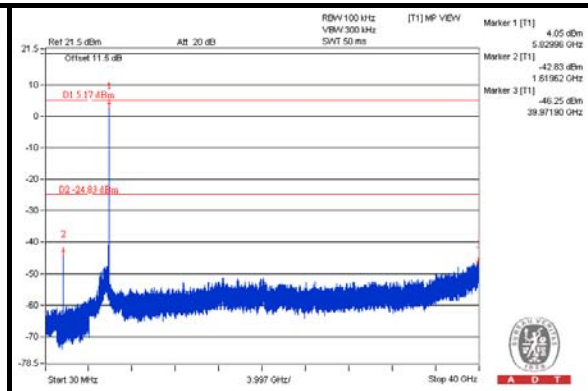
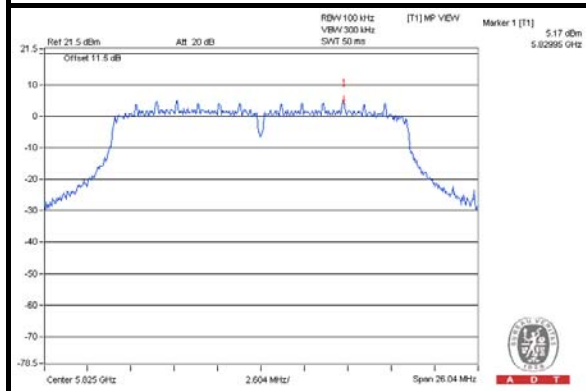

CH 149 Band edge

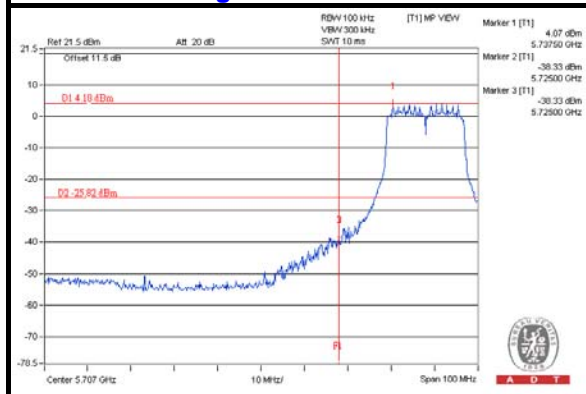

CH 165 Band edge

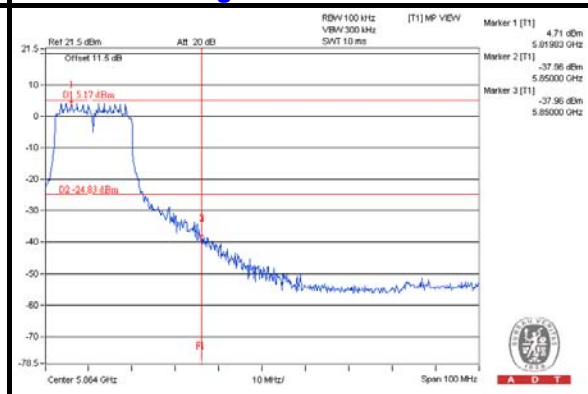



A D T

802.11n (40MHz) CHAIN 0

CH 151

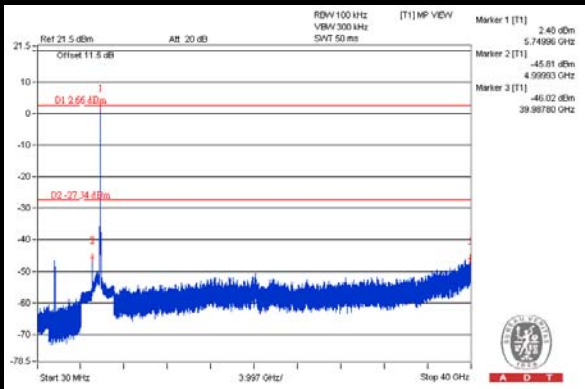
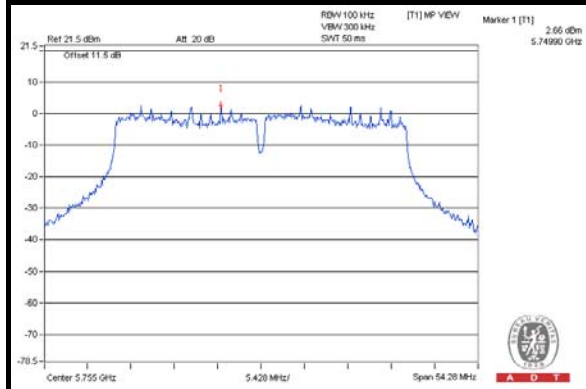

CH 159

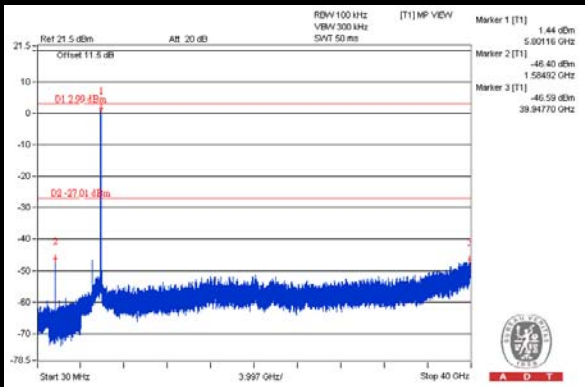
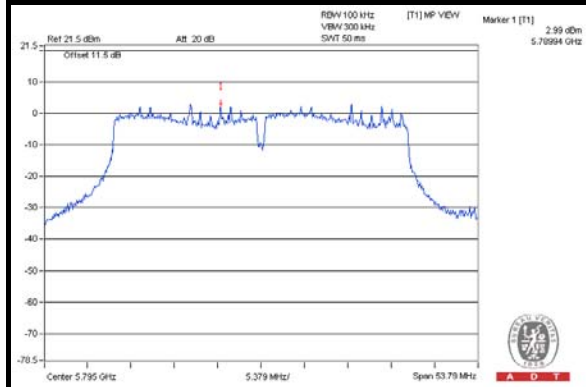

CH 151 Band edge

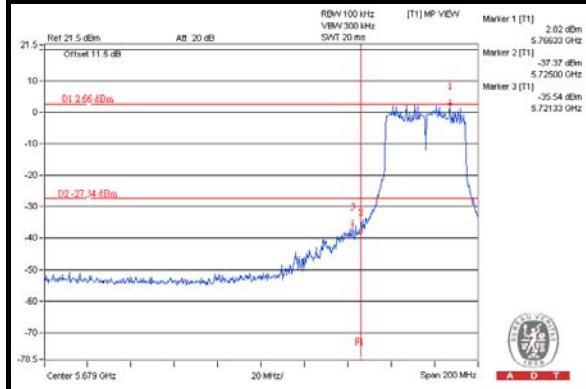

CH 159 Band edge

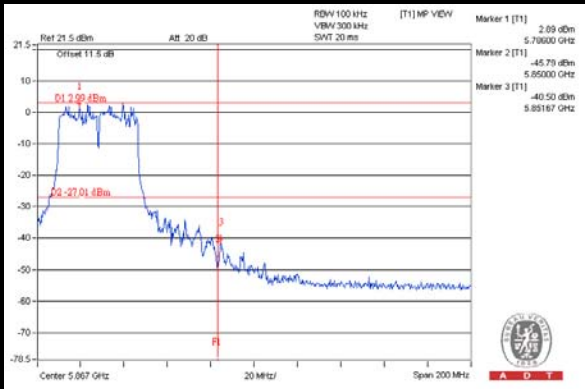

CHAIN 1

CH 151

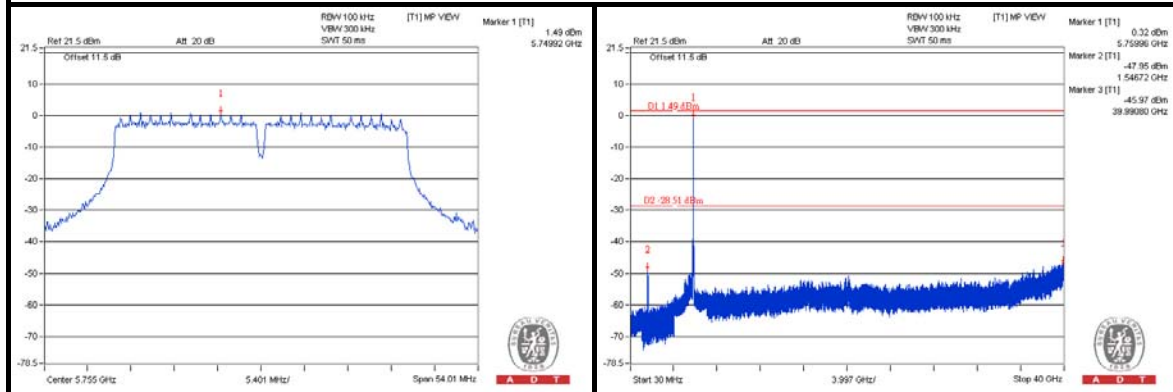

CH 159

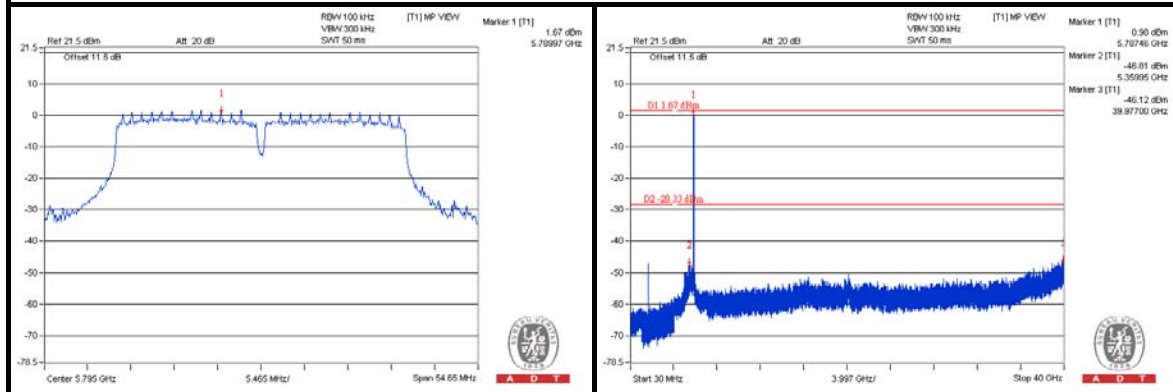

CH 151 Band edge

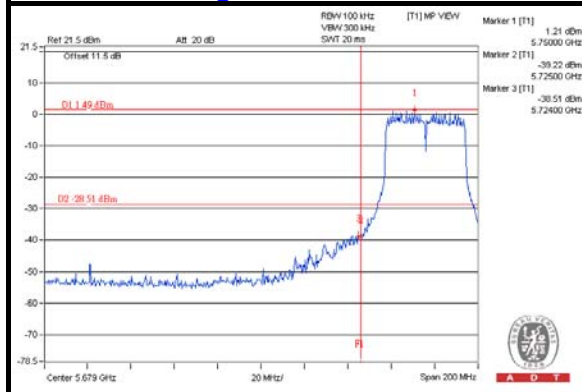

CH 159 Band edge

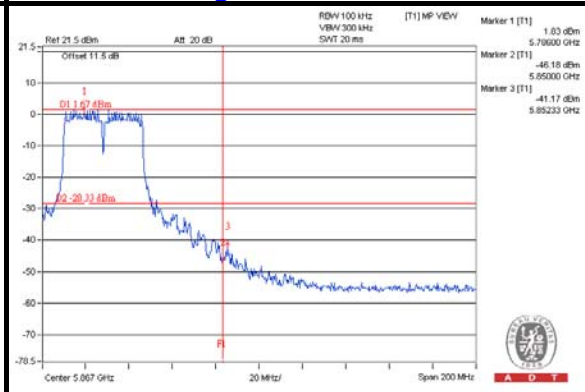



A D T

6. PHOTOGRAPHS OF THE TEST CONFIGURATION

Please refer to the attached file (Test Setup Photo).



7. INFORMATION ON THE TESTING LABORATORIES

We, Bureau Veritas Consumer Products Services (H.K.) Ltd., Taoyuan Branch, were founded in 1988 to provide our best service in EMC, Radio, Telecom and Safety consultation. Our laboratories are accredited and approved according to ISO/IEC 17025.

If you have any comments, please feel free to contact us at the following:

Linko EMC/RF Lab:

Tel: 886-2-26052180

Fax: 886-2-26051924

Hsin Chu EMC/RF/ Telecom Lab:

Tel: 886-3-5935343

Fax: 886-3-5935342

Hwa Ya EMC/RF/Safety Lab:

Tel: 886-3-3183232

Fax: 886-3-3270892

Email: service.adt@tw.bureauveritas.com

Web Site: www.bureauveritas-adt.com

The address and road map of all our labs can be found in our web site also.



A D T

8. APPENDIX A – MODIFICATIONS RECORDERS FOR ENGINEERING CHANGES TO THE EUT BY THE LAB

No any modifications were made to the EUT by the lab during the test.

---END---