



A D T

FCC TEST REPORT (15.247)

REPORT NO.: RF131230C23A

MODEL NO.: MR900 v2

FCC ID: WT8-MR900V2

RECEIVED: Nov. 26, 2013

TESTED: Nov. 27, 2013 ~ Jan. 16, 2014

ISSUED: Feb. 27, 2014

APPLICANT: Open Mesh, Inc.

ADDRESS: 7327 SW Barnes Rd #422, Portland, OR 97225

ISSUED BY: Bureau Veritas Consumer Products Services
(H.K.) Ltd., Taoyuan Branch

LAB ADDRESS: No. 47, 14th Ling, Chia Pau Vil., Lin Kou Dist.,
New Taipei City, Taiwan, R.O.C.

TEST LOCATION: No. 19, Hwa Ya 2nd Rd, Wen Hwa Tsuen, Kwei
Shan Hsiang, Taoyuan Hsien 333, Taiwan, R.O.C.

This report should not be used by the client to claim product certification, approval, or endorsement by TAF or any government agencies.



This report is for your exclusive use. Any copying or replication of this report to or for any other person or entity, or use of our name or trademark, is permitted only with our prior written permission. This report sets forth our findings solely with respect to the test samples identified herein. The results set forth in this report are not indicative or representative of the quality or characteristics of the lot from which a test sample was taken or any similar or identical product unless specifically and expressly noted. Our report includes all of the tests requested by you and the results thereof based upon the information that you provided to us. You have 60 days from date of issuance of this report to notify us of any material error or omission caused by our negligence, provided, however, that such notice shall be in writing and shall specifically address the issue you wish to raise. A failure to raise such issue within the prescribed time shall constitute your unqualified acceptance of the completeness of this report, the tests conducted and the correctness of the report contents. Unless specific mention, the uncertainty of measurement has been explicitly taken into account to declare the compliance or non-compliance to the specification.



A D T

TABLE OF CONTENTS

RELEASE CONTROL RECORD.....	5
1. CERTIFICATION.....	6
2. SUMMARY OF TEST RESULTS	7
2.1 MEASUREMENT UNCERTAINTY.....	7
3. GENERAL INFORMATION.....	8
3.1 GENERAL DESCRIPTION OF EUT	8
3.2 DESCRIPTION OF TEST MODES	10
3.2.1 TEST MODE APPLICABILITY AND TESTED CHANNEL DETAIL	11
3.3 DUTY CYCLE OF TEST SIGNAL.....	15
3.4 DESCRIPTION OF SUPPORT UNITS	17
3.4.1 CONFIGURATION OF SYSTEM UNDER TEST	18
3.5 GENERAL DESCRIPTION OF APPLIED STANDARDS	19
4. TEST TYPES AND RESULTS (FOR 2.4GHz BAND).....	20
4.1 RADIATED EMISSION AND BANDEDGE MEASUREMENT.....	20
4.1.1 LIMITS OF RADIATED EMISSION AND BANDEDGE MEASUREMENT	20
4.1.2 TEST INSTRUMENTS.....	21
4.1.3 TEST PROCEDURES	22
4.1.4 DEVIATION FROM TEST STANDARD.....	22
4.1.5 TEST SETUP.....	23
4.1.6 EUT OPERATING CONDITIONS	24
4.1.7 TEST RESULTS	25
4.2 CONDUCTED EMISSION MEASUREMENT	39
4.2.1 LIMITS OF CONDUCTED EMISSION MEASUREMENT	39
4.2.2 TEST INSTRUMENTS.....	39
4.2.3 TEST PROCEDURES	40
4.2.4 DEVIATION FROM TEST STANDARD.....	40
4.2.5 TEST SETUP.....	40
4.2.6 EUT OPERATING CONDITIONS	40
4.2.7 TEST RESULTS	41
4.3 6dB BANDWIDTH MEASUREMENT.....	45
4.3.1 LIMITS OF 6dB BANDWIDTH MEASUREMENT	45
4.3.2 TEST SETUP.....	45
4.3.3 TEST INSTRUMENTS.....	45
4.3.4 TEST PROCEDURE.....	45
4.3.5 DEVIATION FROM TEST STANDARD.....	45
4.3.6 EUT OPERATING CONDITIONS	45
4.3.7 TEST RESULTS	46



A D T

4.4	CONDUCTED OUTPUT POWER.....	48
4.4.1	LIMITS OF CONDUCTED OUTPUT POWER MEASUREMENT	48
4.4.2	TEST SETUP	48
4.4.3	TEST INSTRUMENTS.....	48
4.4.4	TEST PROCEDURES	48
4.4.5	DEVIATION FROM TEST STANDARD.....	49
4.4.6	EUT OPERATING CONDITIONS	49
4.4.7	TEST RESULTS	50
4.5	POWER SPECTRAL DENSITY MEASUREMENT	51
4.5.1	LIMITS OF POWER SPECTRAL DENSITY MEASUREMENT	51
4.5.2	TEST SETUP.....	51
4.5.3	TEST INSTRUMENTS.....	51
4.5.4	TEST PROCEDURE.....	51
4.5.5	DEVIATION FROM TEST STANDARD.....	51
4.5.6	EUT OPERATING CONDITION.....	51
4.5.7	TEST RESULTS	52
4.6	CONDUCTED OUT OF BAND EMISSION MEASUREMENT.....	55
4.6.1	LIMITS OF CONDUCTED OUT OF BAND EMISSION MEASUREMENT	55
4.6.2	TEST SETUP.....	55
4.6.3	TEST INSTRUMENTS.....	55
4.6.4	TEST PROCEDURE.....	56
4.6.5	DEVIATION FROM TEST STANDARD.....	56
4.6.6	EUT OPERATING CONDITION.....	56
4.6.7	TEST RESULTS	56
5.	TEST TYPES AND RESULTS (FOR 5.0GHz BAND).....	69
5.1	RADIATED EMISSION MEASUREMENT	69
5.1.1	LIMITS OF RADIATED EMISSION MEASUREMENT	69
5.1.2	TEST INSTRUMENTS.....	70
5.1.3	TEST PROCEDURES	70
5.1.4	DEVIATION FROM TEST STANDARD.....	70
5.1.5	TEST SETUP.....	70
5.1.6	EUT OPERATING CONDITIONS	70
5.1.7	TEST RESULTS	71
5.2	CONDUCTED EMISSION MEASUREMENT	81
5.2.1	LIMITS OF CONDUCTED EMISSION MEASUREMENT	81
5.2.2	TEST INSTRUMENTS.....	81
5.2.3	TEST PROCEDURES	81
5.2.4	DEVIATION FROM TEST STANDARD.....	81
5.2.5	TEST SETUP.....	81



A D T

5.2.6	EUT OPERATING CONDITIONS	81
5.2.7	TEST RESULTS	82
5.3	6dB BANDWIDTH MEASUREMENT	86
5.3.1	LIMITS OF 6dB BANDWIDTH MEASUREMENT	86
5.3.2	TEST SETUP	86
5.3.3	TEST INSTRUMENTS.....	86
5.3.4	TEST PROCEDURE.....	86
5.3.5	DEVIATION FROM TEST STANDARD.....	86
5.3.6	EUT OPERATING CONDITIONS	86
5.3.7	TEST RESULTS	87
5.4	CONDUCTED OUTPUT POWER.....	89
5.4.1	LIMITS OF CONDUCTED OUTPUT POWER MEASUREMENT	89
5.4.2	TEST SETUP	89
5.4.3	INSTRUMENTS.....	89
5.4.4	TEST PROCEDURES	89
5.4.5	DEVIATION FROM TEST STANDARD.....	89
5.4.6	EUT OPERATING CONDITIONS	89
5.4.7	TEST RESULTS	90
5.5	POWER SPECTRAL DENSITY MEASUREMENT	91
5.5.1	LIMITS OF POWER SPECTRAL DENSITY MEASUREMENT	91
5.5.2	TEST SETUP.....	91
5.5.3	TEST INSTRUMENTS.....	91
5.5.4	TEST PROCEDURE.....	91
5.5.5	DEVIATION FROM TEST STANDARD.....	91
5.5.6	EUT OPERATING CONDITION.....	91
5.5.7	TEST RESULTS	92
5.6	CONDUCTED OUT OF BAND EMISSION MEASUREMENT	95
5.6.1	LIMITS OF CONDUCTED OUT OF BAND EMISSION MEASUREMENT	95
5.6.2	TEST SETUP.....	95
5.6.3	TEST INSTRUMENTS.....	95
5.6.4	TEST PROCEDURE.....	95
5.6.5	DEVIATION FROM TEST STANDARD.....	95
5.6.6	EUT OPERATING CONDITION.....	95
5.6.7	TEST RESULTS	95
6.	PHOTOGRAPHS OF THE TEST CONFIGURATION.....	105
7.	INFORMATION ON THE TESTING LABORATORIES	106
8.	APPENDIX A – MODIFICATIONS RECORDERS FOR ENGINEERING CHANGES TO THE EUT BY THE LAB.....	107



A D T

RELEASE CONTROL RECORD

ISSUE NO.	REASON FOR CHANGE	DATE ISSUED
RF131230C23A	Original release	Feb. 27, 2014



A D T

1. CERTIFICATION

PRODUCT: Dual Band 450Mbps+450Mbps Indoor Access Point
MODEL NO.: MR900 v2
BRAND: Open Mesh
APPLICANT: Open Mesh, Inc.
TESTED: Nov. 27, 2013 ~ Jan. 16, 2014
TEST SAMPLE: ENGINEERING SAMPLE
STANDARDS: **FCC Part 15, Subpart C (Section 15.247)**
ANSI C63.10-2009

The above equipment (model: MR900 v2) has been tested by **Bureau Veritas Consumer Products Services (H.K.) Ltd., Taoyuan Branch**, and found compliance with the requirement of the above standards. The test record, data evaluation & Equipment Under Test (EUT) configurations represented herein are true and accurate accounts of the measurements of the sample's EMC characteristics under the conditions specified in this report.

PREPARED BY : Celine Chou , **DATE :** Feb. 27, 2014
Celine Chou / Specialist

APPROVED BY : Ken Liu , **DATE :** Feb. 27, 2014
Ken Liu / Senior Manager



2. SUMMARY OF TEST RESULTS

The EUT has been tested according to the following specifications:

APPLIED STANDARD: FCC PART 15, SUBPART C (SECTION 15.247)			
STANDARD SECTION	TEST TYPE	RESULT	REMARK
15.207	AC Power Conducted Emission	PASS	Meet the requirement of limit. Minimum passing margin is -8.21dB at 0.46669MHz.
15.247(d) 15.209	Radiated Emissions	PASS	Meet the requirement of limit. Minimum passing margin is -1.0dB at 4874.00, 7386.00, 2483.50, 5400.00, 11570.00, 11490.00 and 11590.00MHz.
15.247(d)	Band Edge Measurement	PASS	Meet the requirement of limit.
15.247(a)(2)	6dB bandwidth	PASS	Meet the requirement of limit.
15.247(b)	Conducted power	PASS	Meet the requirement of limit.
15.247(e)	Power Spectral Density	PASS	Meet the requirement of limit.
15.203	Antenna Requirement	PASS	Antenna connector is IPEX not a standard connector.

2.1 MEASUREMENT UNCERTAINTY

Where relevant, the following measurement uncertainty levels have been estimated for tests performed on the EUT as specified in CISPR 16-4-2:

MEASUREMENT	FREQUENCY	UNCERTAINTY
Conducted emissions	9kHz~30MHz	2.44 dB
Radiated emissions	30MHz ~ 200MHz	3.34 dB
	200MHz ~1000MHz	3.35 dB
	1GHz ~ 18GHz	2.26 dB
	18GHz ~ 40GHz	1.94 dB

This uncertainty represents an expanded uncertainty expressed at approximately the 95% confidence level using a coverage factor of $k = 2$.



3. GENERAL INFORMATION

3.1 GENERAL DESCRIPTION OF EUT

EUT	Dual Band 450Mbps+450Mbps Indoor Access Point
MODEL NO.	MR900 v2
POWER SUPPLY	12Vdc (Adapter) 48Vdc (PoE)
MODULATION TYPE	CCK, DQPSK, DBPSK for DSSS 64QAM, 16QAM, QPSK, BPSK for OFDM
MODULATION TECHNOLOGY	DSSS, OFDM
TRANSFER RATE	802.11b:11.0/ 5.5/ 2.0/ 1.0Mbps 802.11g: 54.0/ 48.0/ 36.0/ 24.0/ 18.0/ 12.0/ 9.0/ 6.0Mbps 802.11a: 54.0/ 48.0/ 36.0/ 24.0/ 18.0/ 12.0/ 9.0/ 6.0Mbps 802.11n: up to 450.0Mbps
OPERATING FREQUENCY	2.4GHz: 2412 ~ 2462MHz 5.0GHz: 5745 ~ 5825MHz
NUMBER OF CHANNEL	2.4GHz: 11 for 802.11b, 802.11g, 802.11n (20MHz) 7 for 802.11n (40MHz) 5.0GHz: 5 for 802.11a, 802.11n (20MHz) 2 for 802.11n (40MHz)
OUTPUT POWER	680.032mW for 2412 ~ 2462MHz 992.768mW for 5745 ~ 5825MHz
ANTENNA TYPE	For 2.4GHz: PIFA antenna with 4.0dBi gain For 5.0GHz: PIFA antenna with 5.0dBi gain
ANTENNA CONNECTOR	IPEX
DATA CABLE	N/A
I/O PORTS	Refer to user's manual
ACCESSORY DEVICES	Adapter



NOTE:

1. The EUT incorporates a MIMO function. Physically, the EUT provides 3 completed transmitters and 3 receivers.

MODULATION MODE	TX FUNCTION
802.11b	3TX
802.11g	3TX
802.11a	3TX
802.11n (20MHz) MCS 0-7	1TX
802.11n (20MHz) MCS 8-15	2TX
802.11n (20MHz) MCS 16-23	3TX
802.11n (40MHz) MCS 0-7	1TX
802.11n (40MHz) MCS 8-15	2TX
802.11n (40MHz) MCS 16-23	3TX

2. The EUT consumes power from the following adapter and POE.

ADAPTER	
BRAND:	Powertron Electronics Corp.
MODEL:	PA1024-2HUB PA1024-2HU PA1024-120HUB200
INPUT:	100-240Vac, 50-60Hz, 0.6A
OUTPUT:	12Vdc, 2.0A, 24W Max
POWER LINE:	1.5m cable with 1 core attached on adapter

ADAPTER FOR POE (SUPPORT UNIT)	
BRAND:	Powertron Electronics Corp.
MODEL:	PA1040-480IB080
INPUT:	100-240Vac, 50-60Hz, 1.5A
OUTPUT:	48Vdc, 0.8A, 38.4W Max
POWER LINE:	1.5m cable with 1 core attached on adapter

POE (SUPPORT UNIT)	
BRAND:	EnGenius
MODEL:	NPE-7530G
POWER RATING:	48Vdc

3. The above EUT information was declared by the manufacturer and for more detailed features description, please refer to the manufacturer's specifications or User's Manual.



3.2 DESCRIPTION OF TEST MODES

FOR 2.4GHz:

11 channels are provided for 802.11b, 802.11g and 802.11n (20MHz):

CHANNEL	FREQUENCY	CHANNEL	FREQUENCY
1	2412MHz	7	2442MHz
2	2417MHz	8	2447MHz
3	2422MHz	9	2452MHz
4	2427MHz	10	2457MHz
5	2432MHz	11	2462MHz
6	2437MHz		

7 channels are provided for 802.11n (40MHz):

CHANNEL	FREQUENCY	CHANNEL	FREQUENCY
3	2422MHz	7	2442MHz
4	2427MHz	8	2447MHz
5	2432MHz	9	2452MHz
6	2437MHz		

FOR 5.0GHz (5745 ~ 5825MHz):

5 channels are provided for 802.11a, 802.11n (20MHz):

CHANNEL	FREQUENCY	CHANNEL	FREQUENCY
149	5745MHz	161	5805MHz
153	5765MHz	165	5825MHz
157	5785MHz		

2 channels are provided for 802.11n (40MHz):

CHANNEL	FREQUENCY	CHANNEL	FREQUENCY
151	5755MHz	159	5795MHz



3.2.1 TEST MODE APPLICABILITY AND TESTED CHANNEL DETAIL

FOR 2.4GHz:

EUT CONFIGURE MODE	APPLICABLE TO				DESCRIPTION
	RE≥1G	RE<1G	PLC	APCM	
A	√	√	√	√	Power from adapter
B	-	√	-	-	Power from POE

Where **RE≥1G**: Radiated Emission above 1GHz **RE<1G**: Radiated Emission below 1GHz
PLC: Power Line Conducted Emission **APCM**: Antenna Port Conducted Measurement

NOTE:

1. The EUT had been pre-tested on the positioned of each 3 axis. The worst case was found when positioned on **Z-plane**.
2. "-" means no effect.

RADIATED EMISSION TEST (ABOVE 1GHz):

- Pre-Scan has been conducted to determine the worst-case mode from all possible combinations between available modulations, data rates and antenna ports (if EUT with antenna diversity architecture).
- Following channel(s) was (were) selected for the final test as listed below.

EUT CONFIGURE MODE	MODE	AVAILABLE CHANNEL	TESTED CHANNEL	MODULATION TECHNOLOGY	MODULATION TYPE	DATA RATE (Mbps)
A	802.11b	1 to 11	1, 6, 11	DSSS	DBPSK	1.0
A	802.11g	1 to 11	1, 6, 11	OFDM	BPSK	6.0
A	802.11n (20MHz)	1 to 11	1, 6, 11	OFDM	BPSK	7.2
A	802.11n (40MHz)	3 to 9	3, 6, 9	OFDM	BPSK	15.0

RADIATED EMISSION TEST (BELOW 1GHz):

- Pre-Scan has been conducted to determine the worst-case mode from all possible combinations between available modulations, data rates and antenna ports (if EUT with antenna diversity architecture).
- Following channel(s) was (were) selected for the final test as listed below.

EUT CONFIGURE MODE	MODE	AVAILABLE CHANNEL	TESTED CHANNEL	MODULATION TECHNOLOGY	MODULATION TYPE	DATA RATE (Mbps)
A & B	802.11b	1 to 11	1	DSSS	DBPSK	1.0

POWER LINE CONDUCTED EMISSION TEST:

- Pre-Scan has been conducted to determine the worst-case mode from all possible combinations between available modulations, data rates and antenna ports (if EUT with antenna diversity architecture).
- Following channel(s) was (were) selected for the final test as listed below.

EUT CONFIGURE MODE	MODE	AVAILABLE CHANNEL	TESTED CHANNEL	MODULATION TECHNOLOGY	MODULATION TYPE	DATA RATE (Mbps)
A & B	802.11b	1 to 11	1	DSSS	DBPSK	1.0



BANDEDGE MEASUREMENT:

- Pre-Scan has been conducted to determine the worst-case mode from all possible combinations between available modulations, data rates and antenna ports (if EUT with antenna diversity architecture).
- Following channel(s) was (were) selected for the final test as listed below.

EUT CONFIGURE MODE	MODE	AVAILABLE CHANNEL	TESTED CHANNEL	MODULATION TECHNOLOGY	MODULATION TYPE	DATA RATE (Mbps)
A	802.11b	1 to 11	1, 11	DSSS	DBPSK	1.0
A	802.11g	1 to 11	1, 11	OFDM	BPSK	6.0
A	802.11n (20MHz)	1 to 11	1, 11	OFDM	BPSK	7.2
A	802.11n (40MHz)	3 to 9	3, 9	OFDM	BPSK	15.0

ANTENNA PORT CONDUCTED MEASUREMENT:

- This item includes all test value of each mode, but only includes spectrum plot of worst value of each mode.
- Pre-Scan has been conducted to determine the worst-case mode from all possible combinations between available modulations, data rates and antenna ports (if EUT with antenna diversity architecture).
- Following channel(s) was (were) selected for the final test as listed below.

EUT CONFIGURE MODE	MODE	AVAILABLE CHANNEL	TESTED CHANNEL	MODULATION TECHNOLOGY	MODULATION TYPE	DATA RATE (Mbps)
A	802.11b	1 to 11	1, 6, 11	DSSS	DBPSK	1.0
A	802.11g	1 to 11	1, 6, 11	OFDM	BPSK	6.0
A	802.11n (20MHz)	1 to 11	1, 6, 11	OFDM	BPSK	7.2
A	802.11n (40MHz)	3 to 9	3, 6, 9	OFDM	BPSK	15.0

TEST CONDITION:

APPLICABLE TO	ENVIRONMENTAL CONDITIONS	INPUT POWER	TESTED BY
RE≥1G	25deg. C, 65%RH	120Vac, 60Hz	Ted Chang
RE<1G	25deg. C, 65%RH	120Vac, 60Hz 48Vdc	Ted Chang
PLC	25deg. C, 65%RH	120Vac, 60Hz 48Vdc	Chris Lin
APCM	25deg. C, 60%RH	120Vac, 60Hz	Ted Chang



A D T

FOR 5.0GHz (5745 ~ 5825MHz):

EUT CONFIGURE MODE	APPLICABLE TO				DESCRIPTION
	RE≥1G	RE<1G	PLC	APCM	
A	√	√	√	√	Power from adapter
B	-	√	-	-	Power from POE

Where **RE≥1G**: Radiated Emission above 1GHz **RE<1G**: Radiated Emission below 1GHz
PLC: Power Line Conducted Emission **APCM**: Antenna Port Conducted Measurement

NOTE:

1. The EUT had been pre-tested on the positioned of each 3 axis. The worst case was found when positioned on **X-plane**.
2. "-" means no effect.

RADIATED EMISSION TEST (ABOVE 1GHz):

- Pre-Scan has been conducted to determine the worst-case mode from all possible combinations between available modulations, data rates and antenna ports (if EUT with antenna diversity architecture).
- Following channel(s) was (were) selected for the final test as listed below.

EUT CONFIGURE MODE	MODE	AVAILABLE CHANNEL	TESTED CHANNEL	MODULATION TECHNOLOGY	MODULATION TYPE	DATA RATE (Mbps)
A	802.11a	149 to 165	149, 157, 165	OFDM	BPSK	6.0
A	802.11n (20MHz)	149 to 165	149, 157, 165	OFDM	BPSK	7.2
A	802.11n (40MHz)	151 to 159	151, 159	OFDM	BPSK	15.0

RADIATED EMISSION TEST (BELOW 1GHz):

- Pre-Scan has been conducted to determine the worst-case mode from all possible combinations between available modulations, data rates and antenna ports (if EUT with antenna diversity architecture).
- Following channel(s) was (were) selected for the final test as listed below.

EUT CONFIGURE MODE	MODE	AVAILABLE CHANNEL	TESTED CHANNEL	MODULATION TECHNOLOGY	MODULATION TYPE	DATA RATE (Mbps)
A & B	802.11a	149 to 165	149	OFDM	BPSK	6.0

POWER LINE CONDUCTED EMISSION TEST:

- Pre-Scan has been conducted to determine the worst-case mode from all possible combinations between available modulations, data rates and antenna ports (if EUT with antenna diversity architecture).
- Following channel(s) was (were) selected for the final test as listed below.

EUT CONFIGURE MODE	MODE	AVAILABLE CHANNEL	TESTED CHANNEL	MODULATION TECHNOLOGY	MODULATION TYPE	DATA RATE (Mbps)
A & B	802.11a	149 to 165	149	OFDM	BPSK	6.0



BANDEDGE MEASUREMENT:

- Pre-Scan has been conducted to determine the worst-case mode from all possible combinations between available modulations, data rates and antenna ports (if EUT with antenna diversity architecture).
- Following channel(s) was (were) selected for the final test as listed below.

EUT CONFIGURE MODE	MODE	AVAILABLE CHANNEL	TESTED CHANNEL	MODULATION TECHNOLOGY	MODULATION TYPE	DATA RATE (Mbps)
A	802.11a	149 to 165	149, 165	OFDM	BPSK	6.0
A	802.11n (20MHz)	149 to 165	149, 165	OFDM	BPSK	7.2
A	802.11n (40MHz)	151 to 159	151, 159	OFDM	BPSK	15.0

ANTENNA PORT CONDUCTED MEASUREMENT:

- This item includes all test value of each mode, but only includes spectrum plot of worst value of each mode.
- Pre-Scan has been conducted to determine the worst-case mode from all possible combinations between available modulations, data rates and antenna ports (if EUT with antenna diversity architecture).
- Following channel(s) was (were) selected for the final test as listed below.

EUT CONFIGURE MODE	MODE	AVAILABLE CHANNEL	TESTED CHANNEL	MODULATION TECHNOLOGY	MODULATION TYPE	DATA RATE (Mbps)
A	802.11a	149 to 165	149, 157, 165	OFDM	BPSK	6.0
A	802.11n (20MHz)	149 to 165	149, 157, 165	OFDM	BPSK	7.2
A	802.11n (40MHz)	151 to 159	151, 159	OFDM	BPSK	15.0

TEST CONDITION:

APPLICABLE TO	ENVIRONMENTAL CONDITIONS	INPUT POWER	TESTED BY
RE≥1G	25deg. C, 65%RH	120Vac, 60Hz	Ted Chang
RE<1G	25deg. C, 65%RH	120Vac, 60Hz 48Vdc	Ted Chang
PLC	25deg. C, 65%RH	120Vac, 60Hz 48Vdc	Chris Lin
APCM	25deg. C, 60%RH	120Vac, 60Hz	Ted Chang

3.3 DUTY CYCLE OF TEST SIGNAL

2.4GHz Band:

802.11b: Duty cycle of test signal is > 98 %

802.11g, 802.11n (20MHz), 802.11n (40MHz): Duty cycle of test signal is < 98%

802.11g: Duty cycle = $2.023/2.075 = 0.975$, Duty factor = $10 * \log(1/0.975) = 0.11$

802.11n (20MHz): Duty cycle = $0.666/0.718 = 0.928$, Duty factor = $10 * \log(1/0.928) = 0.32$

802.11n (40MHz): Duty cycle = $0.348/0.386 = 0.902$, Duty factor = $10 * \log(1/0.902) = 0.45$

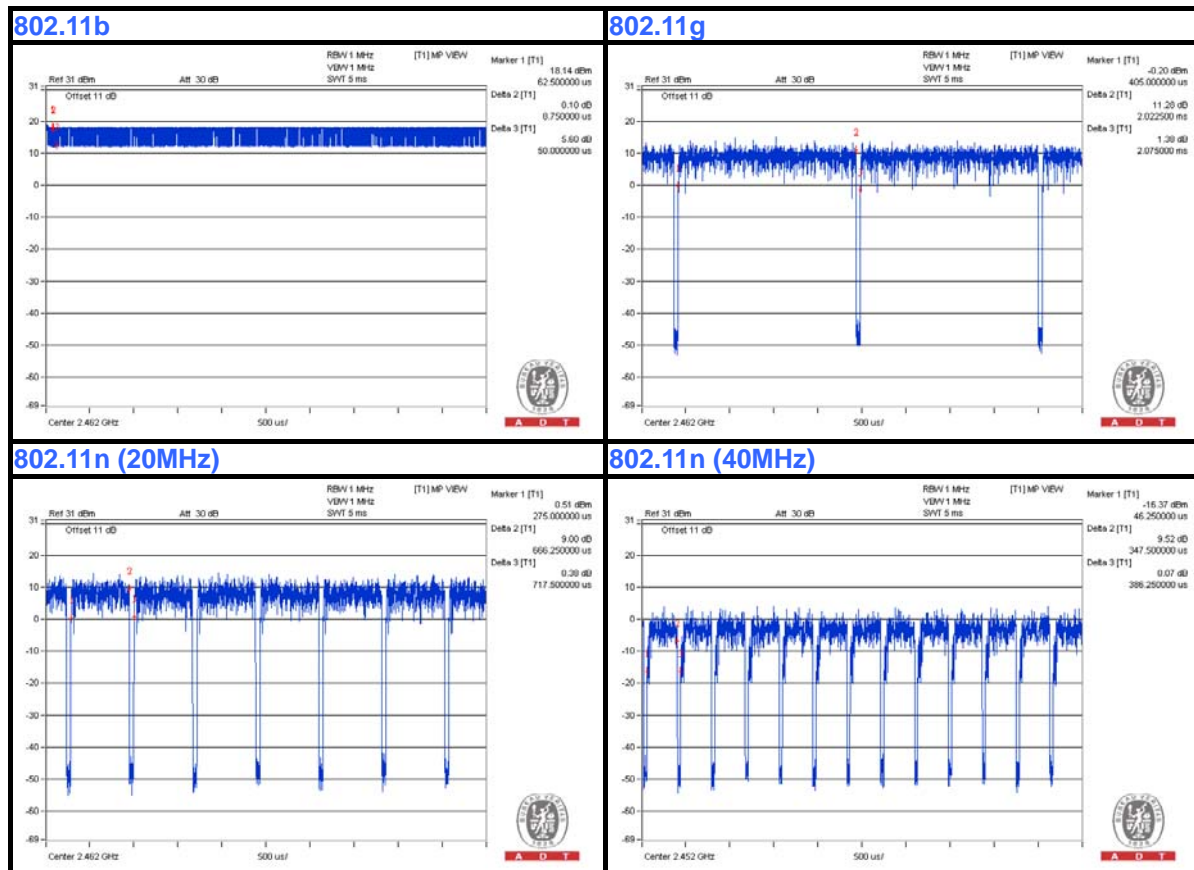



A D T

5.0GHz Band:

802.11a, 802.11n (20MHz), 802.11n (40MHz): Duty cycle of test signal is < 98%

802.11a: Duty cycle = $2.021/2.068 = 0.977$, Duty factor = $10 * \log(1/0.977) = 0.10$

802.11n (20MHz): Duty cycle = $0.666/0.713 = 0.934$, Duty factor = $10 * \log(1/0.934) = 0.30$

802.11n (40MHz): Duty cycle = $0.348/0.380 = 0.916$, Duty factor = $10 * \log(1/0.916) = 0.38$

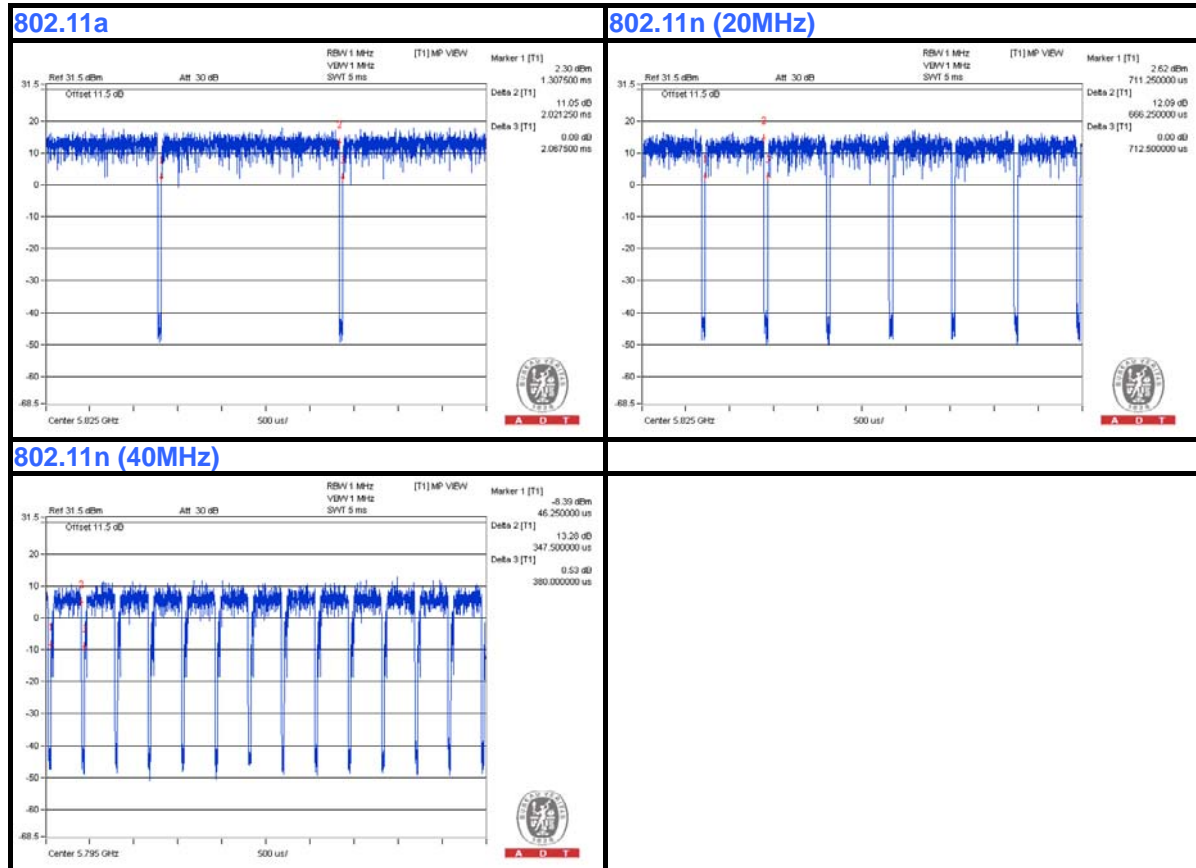



A D T

3.4 DESCRIPTION OF SUPPORT UNITS

The EUT has been tested as an independent unit together with other necessary accessories or support units. The following support units or accessories were used to form a representative test configuration during the tests.

NO.	PRODUCT	BRAND	MODEL NO.	SERIAL NO.	FCC ID
1	NOTEBOOK	DELL	D531	CN-0XM006-4864 3-81U-2610	QDS-BRCM1020
2	POE	EnGenius	NPE-7530G	NA	NA
3	ADAPTER	Powertron Electronics Corp.	PA1040-480IB080	NA	NA

NO.	SIGNAL CABLE DESCRIPTION OF THE ABOVE SUPPORT UNITS
1	10m RJ45 UTP cable for test mode A, 1.8m RJ45 UTP cable for test mode B
2	10m RJ45 UTP cable
3	NA

NOTE:

1. All power cords of the above support units are non-shielded (1.8 m).
2. Item 1 acted as a communication partner to transfer data.
3. Items 2-3 were provided by the manufacturer.

3.4.1 CONFIGURATION OF SYSTEM UNDER TEST

TEST MODE A

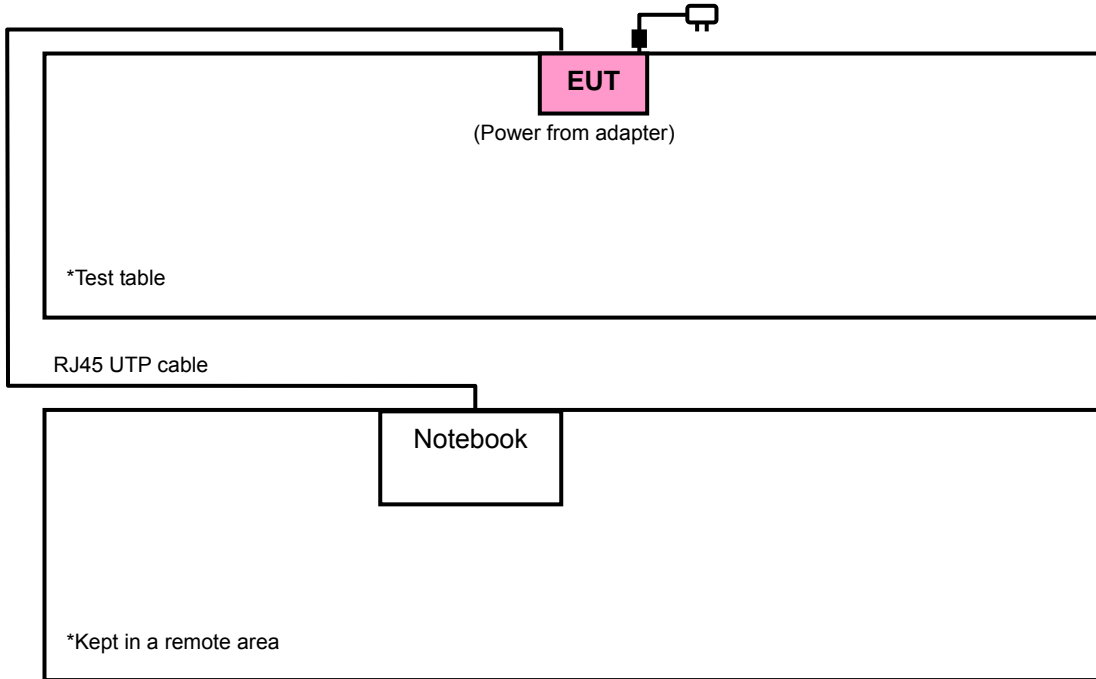

TEST MODE B

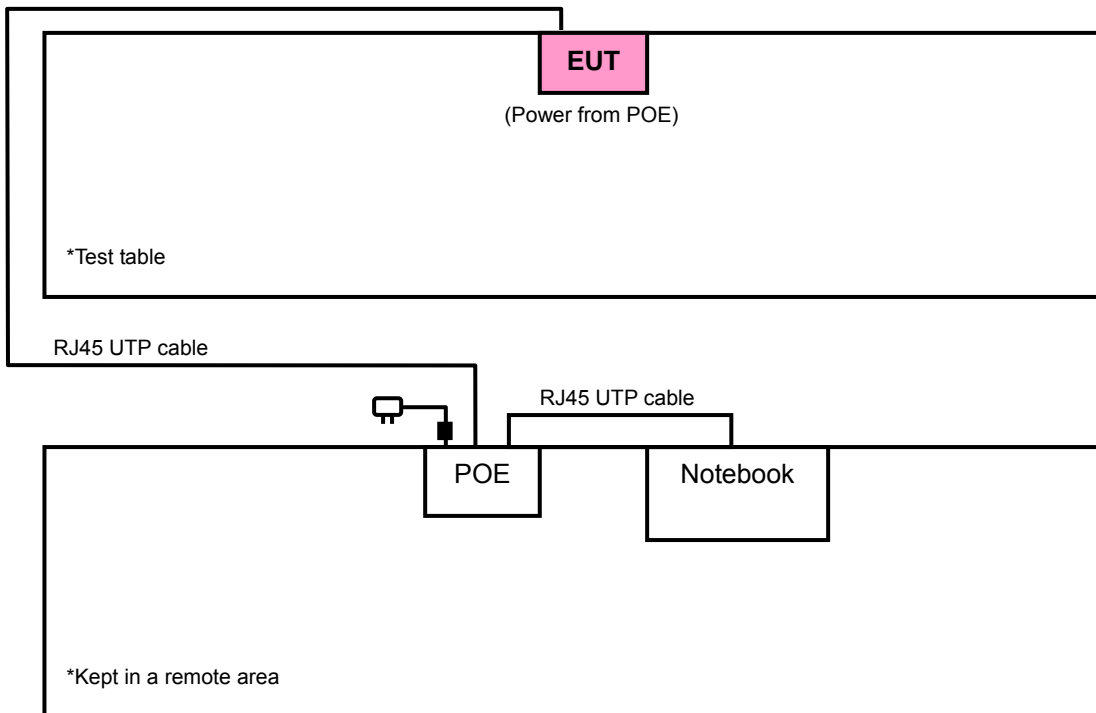



A D T

3.5 GENERAL DESCRIPTION OF APPLIED STANDARDS

The EUT is a RF Product. According to the specifications of the manufacturer, it must comply with the requirements of the following standards:

FCC Part 15, Subpart C (15.247)

558074 D01 DTS Meas Guidance v03r01

662911 D01 Multiple Transmitter Output v02

ANSI C63.10-2009

All test items have been performed and recorded as per the above standards.

NOTE: The EUT is also considered as a kind of computer peripheral, because the connection to computer is necessary for typical use. It has been verified to comply with the requirements of FCC Part 15, Subpart B, Class B (DoC). The test report has been issued separately.



4. TEST TYPES AND RESULTS (FOR 2.4GHz BAND)

4.1 RADIATED EMISSION AND BANDEDGE MEASUREMENT

4.1.1 LIMITS OF RADIATED EMISSION AND BANDEDGE MEASUREMENT

Radiated emissions which fall in the restricted bands must comply with the radiated emission limits specified as below table. Other emissions shall be at least 30dB below the highest level of the desired power:

FREQUENCIES (MHz)	FIELD STRENGTH (microvolts/meter)	MEASUREMENT DISTANCE (meters)
0.009 ~ 0.490	2400/F(kHz)	300
0.490 ~ 1.705	24000/F(kHz)	30
1.705 ~ 30.0	30	30
30 ~ 88	100	3
88 ~ 216	150	3
216 ~ 960	200	3
Above 960	500	3

NOTE:

1. The lower limit shall apply at the transition frequencies.
2. Emission level (dBuV/m) = 20 log Emission level (uV/m).
3. For frequencies above 1000MHz, the field strength limits are based on average detector, however, the peak field strength of any emission shall not exceed the maximum permitted average limits, specified above by more than 30dB under any condition of modulation.



A D T

4.1.2 TEST INSTRUMENTS

DESCRIPTION & MANUFACTURER	MODEL NO.	SERIAL NO.	DATE OF CALIBRATION	DUE DATE OF CALIBRATION
Test Receiver ROHDE & SCHWARZ	ESIB7	100187	Jan. 03, 2013	Jan. 02, 2014
			Jan. 02, 2014	Jan. 01, 2015
Spectrum Analyzer ROHDE & SCHWARZ	FSP40	100039	Jan. 31, 2013	Jan. 30, 2014
BILOG Antenna SCHWARZBECK	VULB9168	9168-160	Mar. 20, 2013	Mar. 19, 2014
HORN Antenna SCHWARZBECK	9120D	209	Sep. 12, 2013	Sep. 11, 2014
HORN Antenna SCHWARZBECK	BBHA 9170	148	Jul. 15, 2013	Jul. 14, 2014
Preamplifier Agilent	8447D	2944A10633	Oct. 07, 2013	Oct. 06, 2014
Preamplifier Agilent	8449B	3008A01964	Aug. 26, 2013	Aug. 25, 2014
RF signal cable HUBER+SUHNNER	SUCOFLEX 104	214378/4	Aug. 26, 2013	Aug. 25, 2014
RF signal cable HUBER+SUHNNER	SUCOFLEX 106	12738/6+309224/4	Aug. 26, 2013	Aug. 25, 2014
Software BV ADT	ADT_Radiated_ V7.6.15.9.4	NA	NA	NA
Antenna Tower inn-co GmbH	MA 4000	013303	NA	NA
Antenna Tower Controller inn-co GmbH	CO2000	017303	NA	NA
Turn Table BV ADT	TT100	TT93021703	NA	NA
Turn Table Controller BV ADT	SC100	SC93021703	NA	NA
26GHz ~ 40GHz Amplifier	EM26400	815221	Oct. 18, 2013	Oct. 17, 2014
High Speed Peak Power Meter	ML2495A	0824012	Aug. 22, 2013	Aug. 21, 2014
Power Sensor	MA2411B	0738171	Jul. 30, 2013	Jul. 29, 2014

- NOTE:**
1. The calibration interval of the above test instruments is 12 months and the calibrations are traceable to NML/ROC and NIST/USA.
 2. The test was performed in HwaYa Chamber 3.
 3. The horn antenna and HP preamplifier (model: 8449B) are used only for the measurement of emission frequency above 1GHz if tested.
 4. The FCC Site Registration No. is 988962.
 5. The IC Site Registration No. is IC 7450F-3.



A D T

4.1.3 TEST PROCEDURES

- a. The EUT was placed on the top of a rotating table 0.8 meters above the ground at a 3 meters semi-anechoic chamber. The table was rotated 360 degrees to determine the position of the highest radiation.
- b. The EUT was set 3 meters away from the interference-receiving antenna, which was mounted on the top of a variable-height antenna tower.
- c. The antenna is a broadband antenna, and its height is varied from one meter to four meters above the ground to determine the maximum value of the field strength. Both horizontal and vertical polarizations of the antenna are set to make the measurement.
- d. For each suspected emission, the EUT was arranged to its worst case and then the antenna was tuned to heights from 1 meter to 4 meters and the rotatable table was turned from 0 degrees to 360 degrees to find the maximum reading.
- e. The test-receiver system was set to Peak Detect Function and Specified Bandwidth with Maximum Hold Mode.
- f. If the emission level of the EUT in peak mode was lower than the limit specified, then testing could be stopped and the peak values of the EUT would be reported. Otherwise the emissions would be re-tested one by one using peak, quasi-peak or average method as specified and then reported in a data sheet.

NOTE:

1. The resolution bandwidth and video bandwidth of test receiver/spectrum analyzer is 120kHz for Quasi-peak detection at frequency below 1GHz.
2. The resolution bandwidth of test receiver/spectrum analyzer is 1MHz and video bandwidth is 3MHz for Peak detection at frequency above 1GHz.
3. The resolution bandwidth of test receiver/spectrum analyzer is 1MHz and the video bandwidth is $\geq 1/T$ (Duty cycle < 98%) or 10Hz (Duty cycle > 98%) for Average detection (AV) at frequency above 1GHz.
4. All modes of operation were investigated and the worst-case emissions are reported.

4.1.4 DEVIATION FROM TEST STANDARD

No deviation.

4.1.5 TEST SETUP

Frequency range 30MHz~1GHz

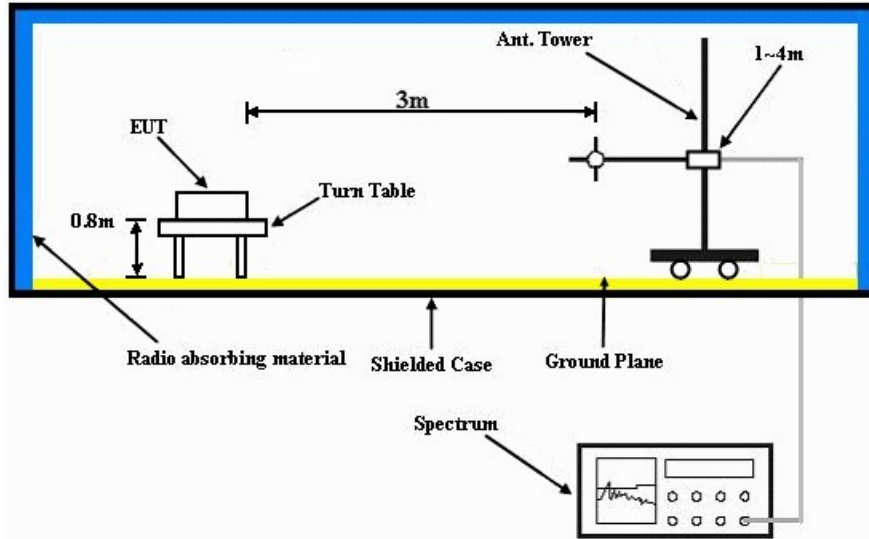

Frequency range above 1GHz

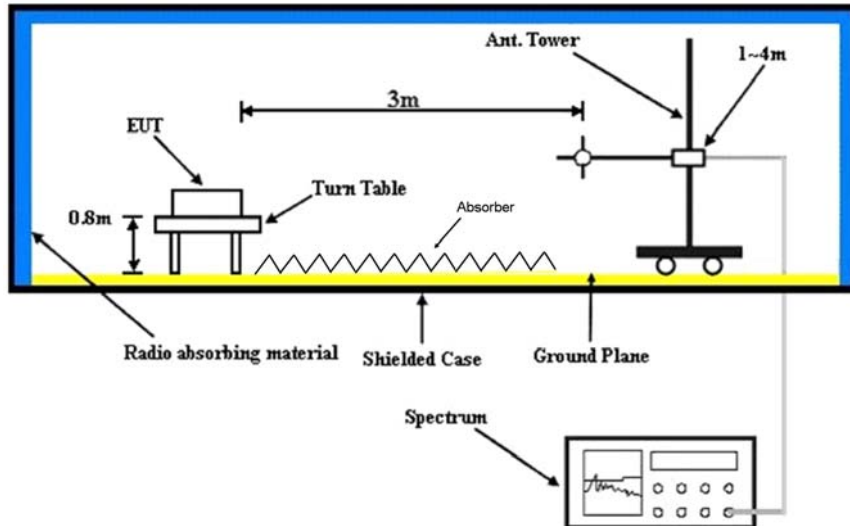

For the actual test configuration, please refer to the attached file (Test Setup Photo).



A D T

4.1.6 EUT OPERATING CONDITIONS

- a. Placed the EUT on the testing table.
- b. Prepared notebook to act as communication partner and placed it outside of testing area.
- c. The communication partner connected with EUT via a RJ45 cable and ran a test program (provided by manufacturer) to enable EUT under transmission condition continuously at specific channel frequency.
- d. The communication partner sent data to EUT by command "PING".



A D T

4.1.7 TEST RESULTS

ABOVE 1GHz DATA :

802.11b

EUT TEST CONDITION		MEASUREMENT DETAIL	
CHANNEL	Channel 1	FREQUENCY RANGE	1 ~ 25GHz
INPUT POWER	120Vac, 60Hz	DETECTOR FUNCTION	Peak (PK) Average (AV)
ENVIRONMENTAL CONDITIONS	25deg. C, 65%RH	TESTED BY	Ted Chang

ANTENNA POLARITY & TEST DISTANCE: HORIZONTAL AT 3 M								
NO.	FREQ. (MHz)	EMISSION LEVEL (dBuV/m)	LIMIT (dBuV/m)	MARGIN (dB)	ANTENNA HEIGHT (m)	TABLE ANGLE (Degree)	RAW VALUE (dBuV)	CORRECTION FACTOR (dB/m)
1	2288.00	58.8 PK	74.0	-15.2	1.04 H	281	28.10	30.70
2	2288.00	47.3 AV	54.0	-6.7	1.04 H	281	16.60	30.70
3	2371.00	63.7 PK	74.0	-10.3	1.32 H	307	32.80	30.90
4	2371.00	52.8 AV	54.0	-1.2	1.32 H	307	21.90	30.90
5	2390.00	61.1 PK	74.0	-12.9	1.32 H	307	30.10	31.00
6	2390.00	50.1 AV	54.0	-3.9	1.32 H	307	19.10	31.00
7	*2412.00	122.2 PK			1.32 H	317	91.10	31.10
8	*2412.00	118.4 AV			1.32 H	317	87.30	31.10
9	4824.00	51.2 PK	74.0	-22.8	1.12 H	119	46.80	4.40
10	4824.00	45.5 PK	54.0	-8.5	1.12 H	119	41.10	4.40

ANTENNA POLARITY & TEST DISTANCE: VERTICAL AT 3 M								
NO.	FREQ. (MHz)	EMISSION LEVEL (dBuV/m)	LIMIT (dBuV/m)	MARGIN (dB)	ANTENNA HEIGHT (m)	TABLE ANGLE (Degree)	RAW VALUE (dBuV)	CORRECTION FACTOR (dB/m)
1	2288.00	59.2 PK	74.0	-14.8	1.49 V	0	28.50	30.70
2	2288.00	48.9 AV	54.0	-5.1	1.49 V	0	18.20	30.70
3	2371.00	58.3 PK	74.0	-15.7	1.39 V	3	27.40	30.90
4	2371.00	46.6 AV	54.0	-7.4	1.39 V	3	15.70	30.90
5	2390.00	56.9 PK	74.0	-17.1	1.39 V	3	25.90	31.00
6	2390.00	45.2 AV	54.0	-8.8	1.39 V	3	14.20	31.00
7	*2412.00	117.2 PK			1.21 V	349	86.10	31.10
8	*2412.00	113.8 AV			1.21 V	349	82.70	31.10
9	4824.00	51.9 PK	74.0	-22.1	1.12 V	331	47.50	4.40
10	4824.00	46.5 AV	54.0	-7.5	1.12 V	331	42.10	4.40

REMARKS:

- Emission Level(dBuV/m) = Raw Value(dBuV) + Correction Factor(dB/m)
- Correction Factor(dB/m) = Antenna Factor(dB/m) + Cable Factor(dB) – Pre-Amplifier Factor(dB)
- The other emission levels were very low against the limit.
- Margin value = Emission Level – Limit value
- “ * “: Fundamental frequency.



A D T

EUT TEST CONDITION		MEASUREMENT DETAIL	
CHANNEL	Channel 6	FREQUENCY RANGE	1 ~ 25GHz
INPUT POWER	120Vac, 60Hz	DETECTOR FUNCTION	Peak (PK) Average (AV)
ENVIRONMENTAL CONDITIONS	25deg. C, 65%RH	TESTED BY	Ted Chang

ANTENNA POLARITY & TEST DISTANCE: HORIZONTAL AT 3 M								
NO.	FREQ. (MHz)	EMISSION LEVEL (dBuV/m)	LIMIT (dBuV/m)	MARGIN (dB)	ANTENNA HEIGHT (m)	TABLE ANGLE (Degree)	RAW VALUE (dBuV)	CORRECTION FACTOR (dB/m)
1	*2437.00	117.7 PK			1.03 H	316	86.50	31.20
2	*2437.00	113.9 AV			1.03 H	316	82.70	31.20
3	2483.50	63.9 PK	74.0	-10.1	1.00 H	313	32.50	31.40
4	2483.50	51.1 AV	54.0	-2.9	1.00 H	313	19.70	31.40
5	4874.00	53.3 PK	74.0	-20.7	1.19 H	199	48.80	4.50
6	4874.00	49.4 AV	54.0	-4.6	1.19 H	199	44.90	4.50
7	7311.00	55.0 PK	74.0	-19.0	1.00 H	175	44.30	10.70
8	7311.00	45.3 AV	54.0	-8.7	1.00 H	175	34.60	10.70

ANTENNA POLARITY & TEST DISTANCE: VERTICAL AT 3 M								
NO.	FREQ. (MHz)	EMISSION LEVEL (dBuV/m)	LIMIT (dBuV/m)	MARGIN (dB)	ANTENNA HEIGHT (m)	TABLE ANGLE (Degree)	RAW VALUE (dBuV)	CORRECTION FACTOR (dB/m)
1	*2437.00	111.4 PK			1.00 V	82	80.20	31.20
2	*2437.00	108.0 AV			1.00 V	82	76.80	31.20
3	2483.50	59.4 PK	74.0	-14.6	1.20 V	341	28.00	31.40
4	2483.50	47.4 AV	54.0	-6.6	1.20 V	341	16.00	31.40
5	4874.00	56.7 PK	74.0	-17.3	1.00 V	172	52.20	4.50
6	4874.00	53.0 AV	54.0	-1.0	1.00 V	172	48.50	4.50
7	7311.00	55.0 PK	74.0	-19.0	1.11 V	117	44.30	10.70
8	7311.00	45.1 AV	54.0	-8.9	1.11 V	117	34.40	10.70

REMARKS:

- Emission Level(dBuV/m) = Raw Value(dBuV) + Correction Factor(dB/m)
- Correction Factor(dB/m) = Antenna Factor(dB/m) + Cable Factor(dB)
– Pre-Amplifier Factor(dB)
- The other emission levels were very low against the limit.
- Margin value = Emission Level – Limit value
- “ * “: Fundamental frequency.



A D T

EUT TEST CONDITION		MEASUREMENT DETAIL	
CHANNEL	Channel 11	FREQUENCY RANGE	1 ~ 25GHz
INPUT POWER	120Vac, 60Hz	DETECTOR FUNCTION	Peak (PK) Average (AV)
ENVIRONMENTAL CONDITIONS	25deg. C, 65%RH	TESTED BY	Ted Chang

ANTENNA POLARITY & TEST DISTANCE: HORIZONTAL AT 3 M								
NO.	FREQ. (MHz)	EMISSION LEVEL (dBuV/m)	LIMIT (dBuV/m)	MARGIN (dB)	ANTENNA HEIGHT (m)	TABLE ANGLE (Degree)	RAW VALUE (dBuV)	CORRECTION FACTOR (dB/m)
1	*2462.00	119.6 PK			1.03 H	0	88.30	31.30
2	*2462.00	115.8 AV			1.03 H	0	84.50	31.30
3	2483.50	64.8 PK	74.0	-9.2	1.00 H	310	33.40	31.40
4	2483.50	50.7 AV	54.0	-3.3	1.00 H	310	19.30	31.40
5	4924.00	53.4 PK	74.0	-20.6	1.41 H	258	48.60	4.80
6	4924.00	48.8 AV	54.0	-5.2	1.41 H	258	44.00	4.80
7	7386.00	57.1 PK	74.0	-16.9	1.17 H	133	46.20	10.90
8	7386.00	49.0 AV	54.0	-5.0	1.17 H	133	38.10	10.90

ANTENNA POLARITY & TEST DISTANCE: VERTICAL AT 3 M								
NO.	FREQ. (MHz)	EMISSION LEVEL (dBuV/m)	LIMIT (dBuV/m)	MARGIN (dB)	ANTENNA HEIGHT (m)	TABLE ANGLE (Degree)	RAW VALUE (dBuV)	CORRECTION FACTOR (dB/m)
1	*2462.00	113.4 PK			1.00 V	109	82.10	31.30
2	*2462.00	109.9 AV			1.00 V	109	78.60	31.30
3	2483.50	59.6 PK	74.0	-14.4	1.18 V	346	28.20	31.40
4	2483.50	46.7 AV	54.0	-7.3	1.18 V	346	15.30	31.40
5	4924.00	56.0 PK	74.0	-18.0	1.00 V	180	51.20	4.80
6	4924.00	52.2 AV	54.0	-1.8	1.00 V	180	47.40	4.80
7	7386.00	60.0 PK	74.0	-14.0	1.00 V	119	49.10	10.90
8	7386.00	53.0 AV	54.0	-1.0	1.00 V	119	42.10	10.90

REMARKS:

- Emission Level(dBuV/m) = Raw Value(dBuV) + Correction Factor(dB/m)
- Correction Factor(dB/m) = Antenna Factor(dB/m) + Cable Factor(dB)
– Pre-Amplifier Factor(dB)
- The other emission levels were very low against the limit.
- Margin value = Emission Level – Limit value
- “ * “: Fundamental frequency.



A D T

802.11g

EUT TEST CONDITION		MEASUREMENT DETAIL	
CHANNEL	Channel 1	FREQUENCY RANGE	1 ~ 25GHz
INPUT POWER	120Vac, 60Hz	DETECTOR FUNCTION	Peak (PK) Average (AV)
ENVIRONMENTAL CONDITIONS	25deg. C, 65%RH	TESTED BY	Ted Chang

ANTENNA POLARITY & TEST DISTANCE: HORIZONTAL AT 3 M								
NO.	FREQ. (MHz)	EMISSION LEVEL (dBuV/m)	LIMIT (dBuV/m)	MARGIN (dB)	ANTENNA HEIGHT (m)	TABLE ANGLE (Degree)	RAW VALUE (dBuV)	CORRECTION FACTOR (dB/m)
1	2288.00	60.1 PK	74.0	-13.9	1.34 H	295	29.40	30.70
2	2288.00	50.1 AV	54.0	-3.9	1.34 H	295	19.40	30.70
3	2390.00	69.4 PK	74.0	-4.6	1.05 H	322	38.40	31.00
4	2390.00	52.4 AV	54.0	-1.6	1.05 H	322	21.40	31.00
5	*2412.00	116.8 PK			1.05 H	321	85.70	31.10
6	*2412.00	107.1 AV			1.05 H	321	76.00	31.10
7	2483.50	65.5 PK	74.0	-8.5	1.00 H	311	34.10	31.40
8	2483.50	51.7 AV	54.0	-2.3	1.00 H	311	20.30	31.40
9	4824.00	46.2 PK	74.0	-27.8	1.00 H	124	41.80	4.40
10	4824.00	33.5 AV	54.0	-20.5	1.00 H	124	29.10	4.40

ANTENNA POLARITY & TEST DISTANCE: VERTICAL AT 3 M								
NO.	FREQ. (MHz)	EMISSION LEVEL (dBuV/m)	LIMIT (dBuV/m)	MARGIN (dB)	ANTENNA HEIGHT (m)	TABLE ANGLE (Degree)	RAW VALUE (dBuV)	CORRECTION FACTOR (dB/m)
1	2288.00	58.2 PK	74.0	-15.8	1.77 V	359	27.50	30.70
2	2288.00	49.4 AV	54.0	-4.6	1.77 V	359	18.70	30.70
3	2390.00	64.1 PK	74.0	-9.9	1.67 V	323	33.10	31.00
4	2390.00	48.0 AV	54.0	-6.0	1.67 V	323	17.00	31.00
5	*2412.00	110.8 PK			1.20 V	0	79.70	31.10
6	*2412.00	101.0 AV			1.20 V	0	69.90	31.10
7	2483.50	60.0 PK	74.0	-14.0	1.05 V	125	28.60	31.40
8	2483.50	45.0 AV	54.0	-9.0	1.05 V	125	13.60	31.40
9	4824.00	51.0 PK	74.0	-23.0	1.51 V	114	46.60	4.40
10	4824.00	35.9 AV	54.0	-18.1	1.51 V	114	31.50	4.40

REMARKS:

1. Emission Level(dBuV/m) = Raw Value(dBuV) + Correction Factor(dB/m)
2. Correction Factor(dB/m) = Antenna Factor(dB/m) + Cable Factor(dB)
– Pre-Amplifier Factor(dB)
3. The other emission levels were very low against the limit.
4. Margin value = Emission Level – Limit value
5. “ * “: Fundamental frequency.



A D T

EUT TEST CONDITION		MEASUREMENT DETAIL	
CHANNEL	Channel 6	FREQUENCY RANGE	1 ~ 25GHz
INPUT POWER	120Vac, 60Hz	DETECTOR FUNCTION	Peak (PK) Average (AV)
ENVIRONMENTAL CONDITIONS	25deg. C, 65%RH	TESTED BY	Ted Chang

ANTENNA POLARITY & TEST DISTANCE: HORIZONTAL AT 3 M								
NO.	FREQ. (MHz)	EMISSION LEVEL (dBuV/m)	LIMIT (dBuV/m)	MARGIN (dB)	ANTENNA HEIGHT (m)	TABLE ANGLE (Degree)	RAW VALUE (dBuV)	CORRECTION FACTOR (dB/m)
1	2390.00	62.4 PK	74.0	-11.6	1.03 H	22	31.40	31.00
2	2390.00	50.2 AV	54.0	-3.8	1.03 H	22	19.20	31.00
3	*2437.00	121.3 PK			1.01 H	307	90.10	31.20
4	*2437.00	111.6 AV			1.01 H	307	80.40	31.20
5	2483.50	67.2 PK	74.0	-6.8	1.02 H	321	35.80	31.40
6	2483.50	53.0 AV	54.0	-1.0	1.02 H	321	21.60	31.40
7	4874.00	48.2 PK	74.0	-25.8	1.51 H	115	43.70	4.50
8	4874.00	37.0 AV	54.0	-17.0	1.51 H	115	32.50	4.50

ANTENNA POLARITY & TEST DISTANCE: VERTICAL AT 3 M								
NO.	FREQ. (MHz)	EMISSION LEVEL (dBuV/m)	LIMIT (dBuV/m)	MARGIN (dB)	ANTENNA HEIGHT (m)	TABLE ANGLE (Degree)	RAW VALUE (dBuV)	CORRECTION FACTOR (dB/m)
1	2390.00	59.9 PK	74.0	-14.1	1.02 V	14	28.90	31.00
2	2390.00	45.5 AV	54.0	-8.5	1.02 V	14	14.50	31.00
3	*2437.00	114.2 PK			1.22 V	340	83.00	31.20
4	*2437.00	104.4 AV			1.22 V	340	73.20	31.20
5	2483.50	59.1 PK	74.0	-14.9	1.47 V	334	27.70	31.40
6	2483.50	46.7 AV	54.0	-7.3	1.47 V	334	15.30	31.40
7	4874.00	48.0 PK	74.0	-26.0	1.05 V	16	43.50	4.50
8	4874.00	35.0 AV	54.0	-19.0	1.05 V	16	30.50	4.50

REMARKS:

- Emission Level(dBuV/m) = Raw Value(dBuV) + Correction Factor(dB/m)
- Correction Factor(dB/m) = Antenna Factor(dB/m) + Cable Factor(dB)
– Pre-Amplifier Factor(dB)
- The other emission levels were very low against the limit.
- Margin value = Emission Level – Limit value
- “ * “: Fundamental frequency.



A D T

EUT TEST CONDITION		MEASUREMENT DETAIL	
CHANNEL	Channel 11	FREQUENCY RANGE	1 ~ 25GHz
INPUT POWER	120Vac, 60Hz	DETECTOR FUNCTION	Peak (PK) Average (AV)
ENVIRONMENTAL CONDITIONS	25deg. C, 65%RH	TESTED BY	Ted Chang

ANTENNA POLARITY & TEST DISTANCE: HORIZONTAL AT 3 M								
NO.	FREQ. (MHz)	EMISSION LEVEL (dBuV/m)	LIMIT (dBuV/m)	MARGIN (dB)	ANTENNA HEIGHT (m)	TABLE ANGLE (Degree)	RAW VALUE (dBuV)	CORRECTION FACTOR (dB/m)
1	*2462.00	118.3 PK			1.26 H	308	87.00	31.30
2	*2462.00	108.8 AV			1.26 H	308	77.50	31.30
3	2483.50	72.4 PK	74.0	-1.6	1.03 H	321	41.00	31.40
4	2483.50	53.0 AV	54.0	-1.0	1.03 H	321	21.60	31.40
5	4924.00	48.5 PK	74.0	-25.5	1.52 H	189	43.70	4.80
6	4924.00	35.3 AV	54.0	-18.7	1.52 H	189	30.50	4.80
ANTENNA POLARITY & TEST DISTANCE: VERTICAL AT 3 M								
NO.	FREQ. (MHz)	EMISSION LEVEL (dBuV/m)	LIMIT (dBuV/m)	MARGIN (dB)	ANTENNA HEIGHT (m)	TABLE ANGLE (Degree)	RAW VALUE (dBuV)	CORRECTION FACTOR (dB/m)
1	*2462.00	113.0 PK			1.51 V	332	81.70	31.30
2	*2462.00	102.8 AV			1.51 V	332	71.50	31.30
3	2483.50	68.4 PK	74.0	-5.6	1.20 V	334	37.00	31.40
4	2483.50	49.1 AV	54.0	-4.9	1.20 V	334	17.70	31.40
5	4924.00	48.1 PK	74.0	-25.9	1.02 V	218	43.30	4.80
6	4924.00	35.0 AV	54.0	-19.0	1.02 V	218	30.20	4.80

REMARKS:

1. Emission Level(dBuV/m) = Raw Value(dBuV) + Correction Factor(dB/m)
2. Correction Factor(dB/m) = Antenna Factor(dB/m) + Cable Factor(dB)
– Pre-Amplifier Factor(dB)
3. The other emission levels were very low against the limit.
4. Margin value = Emission Level – Limit value
5. “ * “: Fundamental frequency.



A D T

802.11n (20MHz)

EUT TEST CONDITION		MEASUREMENT DETAIL	
CHANNEL	Channel 1	FREQUENCY RANGE	1 ~ 25GHz
INPUT POWER	120Vac, 60Hz	DETECTOR FUNCTION	Peak (PK) Average (AV)
ENVIRONMENTAL CONDITIONS	25deg. C, 65%RH	TESTED BY	Ted Chang

ANTENNA POLARITY & TEST DISTANCE: HORIZONTAL AT 3 M								
NO.	FREQ. (MHz)	EMISSION LEVEL (dBuV/m)	LIMIT (dBuV/m)	MARGIN (dB)	ANTENNA HEIGHT (m)	TABLE ANGLE (Degree)	RAW VALUE (dBuV)	CORRECTION FACTOR (dB/m)
1	2288.00	58.7 PK	74.0	-15.3	1.33 H	283	28.00	30.70
2	2288.00	47.6 AV	54.0	-6.4	1.33 H	283	16.90	30.70
3	2390.00	69.2 PK	74.0	-4.8	1.32 H	309	38.20	31.00
4	2390.00	52.6 AV	54.0	-1.4	1.32 H	309	21.60	31.00
5	*2412.00	116.4 PK			1.04 H	309	85.30	31.10
6	*2412.00	106.5 AV			1.04 H	309	75.40	31.10
7	2483.50	68.7 PK	74.0	-5.3	1.00 H	317	37.30	31.40
8	2483.50	50.9 AV	54.0	-3.1	1.00 H	317	19.50	31.40
9	4824.00	49.8 PK	74.0	-24.2	1.54 H	88	45.40	4.40
10	4824.00	36.9 AV	54.0	-17.1	1.54 H	88	32.50	4.40

ANTENNA POLARITY & TEST DISTANCE: VERTICAL AT 3 M								
NO.	FREQ. (MHz)	EMISSION LEVEL (dBuV/m)	LIMIT (dBuV/m)	MARGIN (dB)	ANTENNA HEIGHT (m)	TABLE ANGLE (Degree)	RAW VALUE (dBuV)	CORRECTION FACTOR (dB/m)
1	2288.00	58.2 PK	74.0	-15.8	1.00 V	12	27.50	30.70
2	2288.00	49.1 AV	54.0	-4.9	1.00 V	12	18.40	30.70
3	2390.00	65.7 PK	74.0	-8.3	1.00 V	0	34.70	31.00
4	2390.00	49.4 AV	54.0	-4.6	1.00 V	0	18.40	31.00
5	*2412.00	110.6 PK			1.25 V	343	79.50	31.10
6	*2412.00	100.6 AV			1.25 V	343	69.50	31.10
7	2483.50	60.4 PK	74.0	-13.6	1.21 V	332	29.00	31.40
8	2483.50	46.7 AV	54.0	-7.3	1.21 V	332	15.30	31.40
9	4824.00	47.1 PK	74.0	-26.9	1.00 V	159	42.70	4.40
10	4824.00	35.0 AV	54.0	-19.0	1.00 V	159	30.60	4.40

REMARKS:

1. Emission Level(dBuV/m) = Raw Value(dBuV) + Correction Factor(dB/m)
2. Correction Factor(dB/m) = Antenna Factor(dB/m) + Cable Factor(dB)
– Pre-Amplifier Factor(dB)
3. The other emission levels were very low against the limit.
4. Margin value = Emission Level – Limit value
5. “ * “: Fundamental frequency.



A D T

EUT TEST CONDITION		MEASUREMENT DETAIL	
CHANNEL	Channel 6	FREQUENCY RANGE	1 ~ 25GHz
INPUT POWER	120Vac, 60Hz	DETECTOR FUNCTION	Peak (PK) Average (AV)
ENVIRONMENTAL CONDITIONS	25deg. C, 65%RH	TESTED BY	Ted Chang

ANTENNA POLARITY & TEST DISTANCE: HORIZONTAL AT 3 M								
NO.	FREQ. (MHz)	EMISSION LEVEL (dBuV/m)	LIMIT (dBuV/m)	MARGIN (dB)	ANTENNA HEIGHT (m)	TABLE ANGLE (Degree)	RAW VALUE (dBuV)	CORRECTION FACTOR (dB/m)
1	2390.00	62.9 PK	74.0	-11.1	1.04 H	36	31.90	31.00
2	2390.00	50.4 AV	54.0	-3.6	1.04 H	36	19.40	31.00
3	*2437.00	122.0 PK			1.30 H	316	90.80	31.20
4	*2437.00	112.0 AV			1.30 H	316	80.80	31.20
5	2483.50	71.5 PK	74.0	-2.5	1.00 H	313	40.10	31.40
6	2483.50	53.0 AV	54.0	-1.0	1.00 H	313	21.60	31.40
7	4874.00	48.2 PK	74.0	-25.8	1.51 H	225	43.70	4.50
8	4874.00	37.0 AV	54.0	-17.0	1.51 H	225	32.50	4.50
ANTENNA POLARITY & TEST DISTANCE: VERTICAL AT 3 M								
NO.	FREQ. (MHz)	EMISSION LEVEL (dBuV/m)	LIMIT (dBuV/m)	MARGIN (dB)	ANTENNA HEIGHT (m)	TABLE ANGLE (Degree)	RAW VALUE (dBuV)	CORRECTION FACTOR (dB/m)
1	2390.00	57.9 PK	74.0	-16.1	1.59 V	264	26.90	31.00
2	2390.00	45.5 AV	54.0	-8.5	1.59 V	264	14.50	31.00
3	*2437.00	115.0 PK			1.19 V	0	83.80	31.20
4	*2437.00	105.6 AV			1.19 V	0	74.40	31.20
5	2483.50	66.2 PK	74.0	-7.8	1.21 V	330	34.80	31.40
6	2483.50	47.9 AV	54.0	-6.1	1.21 V	330	16.50	31.40
7	4874.00	47.5 PK	74.0	-26.5	1.00 V	201	43.00	4.50
8	4874.00	34.7 AV	54.0	-19.3	1.00 V	201	30.20	4.50

REMARKS:

- Emission Level(dBuV/m) = Raw Value(dBuV) + Correction Factor(dB/m)
- Correction Factor(dB/m) = Antenna Factor(dB/m) + Cable Factor(dB)
– Pre-Amplifier Factor(dB)
- The other emission levels were very low against the limit.
- Margin value = Emission Level – Limit value
- * * *: Fundamental frequency.



A D T

EUT TEST CONDITION		MEASUREMENT DETAIL	
CHANNEL	Channel 11	FREQUENCY RANGE	1 ~ 25GHz
INPUT POWER	120Vac, 60Hz	DETECTOR FUNCTION	Peak (PK) Average (AV)
ENVIRONMENTAL CONDITIONS	25deg. C, 65%RH	TESTED BY	Ted Chang

ANTENNA POLARITY & TEST DISTANCE: HORIZONTAL AT 3 M								
NO.	FREQ. (MHz)	EMISSION LEVEL (dBuV/m)	LIMIT (dBuV/m)	MARGIN (dB)	ANTENNA HEIGHT (m)	TABLE ANGLE (Degree)	RAW VALUE (dBuV)	CORRECTION FACTOR (dB/m)
1	*2462.00	116.5 PK			1.03 H	312	85.20	31.30
2	*2462.00	106.7 AV			1.03 H	312	75.40	31.30
3	2483.50	73.0 PK	74.0	-1.0	1.02 H	324	41.60	31.40
4	2483.50	52.9 AV	54.0	-1.1	1.02 H	324	21.50	31.40
5	4924.00	50.5 PK	74.0	-23.5	1.51 H	66	45.70	4.80
6	4924.00	40.3 AV	54.0	-13.7	1.51 H	66	35.50	4.80
ANTENNA POLARITY & TEST DISTANCE: VERTICAL AT 3 M								
NO.	FREQ. (MHz)	EMISSION LEVEL (dBuV/m)	LIMIT (dBuV/m)	MARGIN (dB)	ANTENNA HEIGHT (m)	TABLE ANGLE (Degree)	RAW VALUE (dBuV)	CORRECTION FACTOR (dB/m)
1	*2462.00	111.1 PK			1.49 V	332	79.80	31.30
2	*2462.00	101.3 AV			1.49 V	332	70.00	31.30
3	2483.50	69.1 PK	74.0	-4.9	1.18 V	333	37.70	31.40
4	2483.50	49.4 AV	54.0	-4.6	1.18 V	333	18.00	31.40
5	4924.00	48.4 PK	74.0	-25.6	1.52 V	223	43.60	4.80
6	4924.00	35.4 AV	54.0	-18.6	1.52 V	223	30.60	4.80

REMARKS:

1. Emission Level(dBuV/m) = Raw Value(dBuV) + Correction Factor(dB/m)
2. Correction Factor(dB/m) = Antenna Factor(dB/m) + Cable Factor(dB)
– Pre-Amplifier Factor(dB)
3. The other emission levels were very low against the limit.
4. Margin value = Emission Level – Limit value
5. “ * “: Fundamental frequency.



A D T

802.11n (40MHz)

EUT TEST CONDITION		MEASUREMENT DETAIL	
CHANNEL	Channel 3	FREQUENCY RANGE	1 ~ 25GHz
INPUT POWER	120Vac, 60Hz	DETECTOR FUNCTION	Peak (PK) Average (AV)
ENVIRONMENTAL CONDITIONS	25deg. C, 65%RH	TESTED BY	Ted Chang

ANTENNA POLARITY & TEST DISTANCE: HORIZONTAL AT 3 M								
NO.	FREQ. (MHz)	EMISSION LEVEL (dBuV/m)	LIMIT (dBuV/m)	MARGIN (dB)	ANTENNA HEIGHT (m)	TABLE ANGLE (Degree)	RAW VALUE (dBuV)	CORRECTION FACTOR (dB/m)
1	2288.00	56.9 PK	74.0	-17.1	2.06 H	19	26.20	30.70
2	2288.00	45.9 AV	54.0	-8.1	2.06 H	19	15.20	30.70
3	2390.00	66.9 PK	74.0	-7.1	1.01 H	36	35.90	31.00
4	2390.00	52.8 AV	54.0	-1.2	1.01 H	36	21.80	31.00
5	*2422.00	109.4 PK			1.26 H	309	78.20	31.20
6	*2422.00	100.1 AV			1.26 H	309	68.90	31.20
7	4844.00	48.0 PK	74.0	-26.0	1.08 H	99	43.50	4.50
8	4844.00	34.9 AV	54.0	-19.1	1.08 H	99	30.40	4.50

ANTENNA POLARITY & TEST DISTANCE: VERTICAL AT 3 M								
NO.	FREQ. (MHz)	EMISSION LEVEL (dBuV/m)	LIMIT (dBuV/m)	MARGIN (dB)	ANTENNA HEIGHT (m)	TABLE ANGLE (Degree)	RAW VALUE (dBuV)	CORRECTION FACTOR (dB/m)
1	2288.00	56.7 PK	74.0	-17.3	1.20 V	294	26.00	30.70
2	2288.00	45.7 AV	54.0	-8.3	1.20 V	294	15.00	30.70
3	2390.00	64.4 PK	74.0	-9.6	1.00 V	324	33.40	31.00
4	2390.00	51.2 AV	54.0	-2.8	1.00 V	324	20.20	31.00
5	*2422.00	106.9 PK			1.00 V	343	75.70	31.20
6	*2422.00	96.7 AV			1.00 V	343	65.50	31.20
7	4844.00	45.8 PK	74.0	-28.2	1.36 V	147	41.30	4.50
8	4844.00	33.2 AV	54.0	-20.8	1.36 V	147	28.70	4.50

REMARKS:

- Emission Level(dBuV/m) = Raw Value(dBuV) + Correction Factor(dB/m)
- Correction Factor(dB/m) = Antenna Factor(dB/m) + Cable Factor(dB) – Pre-Amplifier Factor(dB)
- The other emission levels were very low against the limit.
- Margin value = Emission Level – Limit value
- “ * “: Fundamental frequency.



A D T

EUT TEST CONDITION		MEASUREMENT DETAIL	
CHANNEL	Channel 6	FREQUENCY RANGE	1 ~ 25GHz
INPUT POWER	120Vac, 60Hz	DETECTOR FUNCTION	Peak (PK) Average (AV)
ENVIRONMENTAL CONDITIONS	25deg. C, 65%RH	TESTED BY	Ted Chang

ANTENNA POLARITY & TEST DISTANCE: HORIZONTAL AT 3 M								
NO.	FREQ. (MHz)	EMISSION LEVEL (dBuV/m)	LIMIT (dBuV/m)	MARGIN (dB)	ANTENNA HEIGHT (m)	TABLE ANGLE (Degree)	RAW VALUE (dBuV)	CORRECTION FACTOR (dB/m)
1	2288.00	57.5 PK	74.0	-16.5	1.01 H	246	26.80	30.70
2	2288.00	46.8 AV	54.0	-7.2	1.01 H	246	16.10	30.70
3	2390.00	65.1 PK	74.0	-8.9	1.28 H	310	34.10	31.00
4	2390.00	52.7 AV	54.0	-1.3	1.28 H	310	21.70	31.00
5	*2437.00	114.4 PK			1.00 H	308	83.20	31.20
6	*2437.00	105.1 AV			1.00 H	308	73.90	31.20
7	2483.50	68.4 PK	74.0	-5.6	1.02 H	319	37.00	31.40
8	2483.50	52.6 AV	54.0	-1.4	1.02 H	319	21.20	31.40
9	4874.00	47.1 PK	74.0	-26.9	1.18 H	56	42.60	4.50
10	4874.00	34.9 AV	54.0	-19.1	1.18 H	56	30.40	4.50

ANTENNA POLARITY & TEST DISTANCE: VERTICAL AT 3 M								
NO.	FREQ. (MHz)	EMISSION LEVEL (dBuV/m)	LIMIT (dBuV/m)	MARGIN (dB)	ANTENNA HEIGHT (m)	TABLE ANGLE (Degree)	RAW VALUE (dBuV)	CORRECTION FACTOR (dB/m)
1	2288.00	58.1 PK	74.0	-15.9	1.00 V	0	27.40	30.70
2	2288.00	49.3 AV	54.0	-4.7	1.00 V	0	18.60	30.70
3	2390.00	62.5 PK	74.0	-11.5	1.00 V	81	31.50	31.00
4	2390.00	49.0 AV	54.0	-5.0	1.00 V	81	18.00	31.00
5	*2437.00	110.3 PK			1.17 V	343	79.10	31.20
6	*2437.00	100.4 AV			1.17 V	343	69.20	31.20
7	2483.50	60.0 PK	74.0	-14.0	1.57 V	360	28.60	31.40
8	2483.50	47.0 AV	54.0	-7.0	1.57 V	360	15.60	31.40
9	4874.00	44.8 PK	74.0	-29.2	1.32 V	54	40.30	4.50
10	4874.00	32.9 AV	54.0	-21.1	1.32 V	54	28.40	4.50

REMARKS:

1. Emission Level(dBuV/m) = Raw Value(dBuV) + Correction Factor(dB/m)
2. Correction Factor(dB/m) = Antenna Factor(dB/m) + Cable Factor(dB)
– Pre-Amplifier Factor(dB)
3. The other emission levels were very low against the limit.
4. Margin value = Emission Level – Limit value
5. “ * “: Fundamental frequency.



A D T

EUT TEST CONDITION		MEASUREMENT DETAIL	
CHANNEL	Channel 9	FREQUENCY RANGE	1 ~ 25GHz
INPUT POWER	120Vac, 60Hz	DETECTOR FUNCTION	Peak (PK) Average (AV)
ENVIRONMENTAL CONDITIONS	25deg. C, 65%RH	TESTED BY	Ted Chang

ANTENNA POLARITY & TEST DISTANCE: HORIZONTAL AT 3 M								
NO.	FREQ. (MHz)	EMISSION LEVEL (dBuV/m)	LIMIT (dBuV/m)	MARGIN (dB)	ANTENNA HEIGHT (m)	TABLE ANGLE (Degree)	RAW VALUE (dBuV)	CORRECTION FACTOR (dB/m)
1	2288.00	56.6 PK	74.0	-17.4	1.11 H	8	25.90	30.70
2	2288.00	46.0 AV	54.0	-8.0	1.11 H	8	15.30	30.70
3	*2452.00	109.7 PK			1.03 H	314	78.40	31.30
4	*2452.00	100.4 AV			1.03 H	314	69.10	31.30
5	2483.50	71.0 PK	74.0	-3.0	1.00 H	320	39.60	31.40
6	2483.50	53.0 AV	54.0	-1.0	1.00 H	320	21.60	31.40
7	4904.00	47.6 PK	74.0	-26.4	1.14 H	85	42.90	4.70
8	4904.00	35.1 AV	54.0	-18.9	1.14 H	85	30.40	4.70

ANTENNA POLARITY & TEST DISTANCE: VERTICAL AT 3 M								
NO.	FREQ. (MHz)	EMISSION LEVEL (dBuV/m)	LIMIT (dBuV/m)	MARGIN (dB)	ANTENNA HEIGHT (m)	TABLE ANGLE (Degree)	RAW VALUE (dBuV)	CORRECTION FACTOR (dB/m)
1	2288.00	55.9 PK	74.0	-18.1	1.52 V	348	25.20	30.70
2	2288.00	45.8 AV	54.0	-8.2	1.52 V	348	15.10	30.70
3	*2452.00	104.4 PK			1.00 V	340	73.10	31.30
4	*2452.00	95.0 AV			1.00 V	340	63.70	31.30
5	2483.50	62.7 PK	74.0	-11.3	1.60 V	1	31.30	31.40
6	2483.50	47.1 AV	54.0	-6.9	1.60 V	1	15.70	31.40
7	4904.00	45.0 PK	74.0	-29.0	1.15 V	74	40.30	4.70
8	4904.00	33.1 AV	54.0	-20.9	1.15 V	74	28.40	4.70

REMARKS:

- Emission Level(dBuV/m) = Raw Value(dBuV) + Correction Factor(dB/m)
- Correction Factor(dB/m) = Antenna Factor(dB/m) + Cable Factor(dB)
– Pre-Amplifier Factor(dB)
- The other emission levels were very low against the limit.
- Margin value = Emission Level – Limit value
- * *: Fundamental frequency.



A D T

BELOW 1GHz WORST-CASE DATA : 802.11b

EUT TEST CONDITION		MEASUREMENT DETAIL	
CHANNEL	Channel 1	FREQUENCY RANGE	Below 1000MHz
INPUT POWER	120Vac, 60Hz	DETECTOR FUNCTION	Quasi-Peak
ENVIRONMENTAL CONDITIONS	25deg. C, 65%RH	TESTED BY	Ted Chang
TEST MODE	A		

ANTENNA POLARITY & TEST DISTANCE: HORIZONTAL AT 3 M

NO.	FREQ. (MHz)	EMISSION LEVEL (dBuV/m)	LIMIT (dBuV/m)	MARGIN (dB)	ANTENNA HEIGHT (m)	TABLE ANGLE (Degree)	RAW VALUE (dBuV)	CORRECTION FACTOR (dB/m)
1	57.07	31.5 QP	40.0	-8.5	2.00 H	238	46.40	-14.90
2	91.99	35.7 QP	43.5	-7.8	2.00 H	192	55.60	-19.90
3	190.95	37.4 QP	43.5	-6.1	2.00 H	255	53.80	-16.40
4	270.51	36.7 QP	46.0	-9.3	1.25 H	100	49.80	-13.10
5	386.93	44.0 QP	46.0	-2.0	1.00 H	140	54.60	-10.60
6	740.09	43.4 QP	46.0	-2.6	2.00 H	306	47.00	-3.60

ANTENNA POLARITY & TEST DISTANCE: VERTICAL AT 3 M

NO.	FREQ. (MHz)	EMISSION LEVEL (dBuV/m)	LIMIT (dBuV/m)	MARGIN (dB)	ANTENNA HEIGHT (m)	TABLE ANGLE (Degree)	RAW VALUE (dBuV)	CORRECTION FACTOR (dB/m)
1	74.53	36.5 QP	40.0	-3.5	1.00 V	94	53.90	-17.40
2	185.13	37.9 QP	43.5	-5.6	1.00 V	90	53.80	-15.90
3	295.73	32.8 QP	46.0	-13.2	1.00 V	358	45.30	-12.50
4	400.52	39.2 QP	46.0	-6.8	1.24 V	72	49.70	-10.50
5	499.48	33.6 QP	46.0	-12.4	1.00 V	145	41.90	-8.30
6	722.62	42.7 QP	46.0	-3.3	1.24 V	24	46.60	-3.90

REMARKS:

1. Emission Level(dBuV/m) = Raw Value(dBuV) + Correction Factor(dB/m)
2. Correction Factor(dB/m) = Antenna Factor(dB/m) + Cable Factor(dB) – Pre-Amplifier Factor (dB)
3. The other emission levels were very low against the limit.
4. Margin value = Emission Level – Limit value



A D T

EUT TEST CONDITION		MEASUREMENT DETAIL	
CHANNEL	Channel 1	FREQUENCY RANGE	Below 1000MHz
INPUT POWER	48Vdc	DETECTOR FUNCTION	Quasi-Peak
ENVIRONMENTAL CONDITIONS	25deg. C, 65%RH	TESTED BY	Ted Chang
TEST MODE	B		

ANTENNA POLARITY & TEST DISTANCE: HORIZONTAL AT 3 M								
NO.	FREQ. (MHz)	EMISSION LEVEL (dBuV/m)	LIMIT (dBuV/m)	MARGIN (dB)	ANTENNA HEIGHT (m)	TABLE ANGLE (Degree)	RAW VALUE (dBuV)	CORRECTION FACTOR (dB/m)
1	57.07	26.0 QP	40.0	-14.0	1.99 H	259	40.90	-14.90
2	159.91	26.6 QP	43.5	-16.9	1.24 H	107	40.30	-13.70
3	272.45	31.1 QP	46.0	-14.9	1.00 H	113	44.10	-13.00
4	392.75	25.6 QP	46.0	-20.4	1.50 H	127	36.30	-10.70
5	625.60	32.4 QP	46.0	-13.6	1.50 H	216	37.90	-5.50
6	751.73	35.3 QP	46.0	-10.7	1.00 H	304	38.30	-3.00

ANTENNA POLARITY & TEST DISTANCE: VERTICAL AT 3 M								
NO.	FREQ. (MHz)	EMISSION LEVEL (dBuV/m)	LIMIT (dBuV/m)	MARGIN (dB)	ANTENNA HEIGHT (m)	TABLE ANGLE (Degree)	RAW VALUE (dBuV)	CORRECTION FACTOR (dB/m)
1	84.23	30.5 QP	40.0	-9.5	1.24 V	293	50.20	-19.70
2	167.67	30.7 QP	43.5	-12.8	1.00 V	87	45.00	-14.30
3	272.45	27.0 QP	46.0	-19.0	1.50 V	238	40.00	-13.00
4	392.75	25.6 QP	46.0	-20.4	1.00 V	175	36.30	-10.70
5	625.60	31.0 QP	46.0	-15.0	1.99 V	36	36.50	-5.50
6	839.05	29.2 QP	46.0	-16.8	1.99 V	305	30.70	-1.50

REMARKS:

1. Emission Level(dBuV/m) = Raw Value(dBuV) + Correction Factor(dB/m)
2. Correction Factor(dB/m) = Antenna Factor(dB/m) + Cable Factor(dB)
 - Pre-Amplifier Factor (dB)
3. The other emission levels were very low against the limit.
4. Margin value = Emission Level – Limit value



4.2 CONDUCTED EMISSION MEASUREMENT

4.2.1 LIMITS OF CONDUCTED EMISSION MEASUREMENT

FREQUENCY OF EMISSION (MHz)	CONDUCTED LIMIT (dB μ V)	
	Quasi-peak	Average
0.15 ~ 0.5	66 to 56	56 to 46
0.5 ~ 5	56	46
5 ~ 30	60	50

- NOTE:**
1. The lower limit shall apply at the transition frequencies.
 2. The limit decreases in line with the logarithm of the frequency in the range of 0.15 to 0.50MHz.
 3. All emanations from a class A/B digital device or system, including any network of conductors and apparatus connected thereto, shall not exceed the level of field strengths specified above.

4.2.2 TEST INSTRUMENTS

DESCRIPTION & MANUFACTURER	MODEL NO.	SERIAL NO.	DATE OF CALIBRATION	DUE DATE OF CALIBRATION
Test Receiver ROHDE & SCHWARZ	ESCS30	100289	Nov. 30, 2012	Nov. 29, 2013
			Nov. 29, 2013	Nov. 28, 2014
RF signal cable Woken	5D-FB	Cable-HYC01-01	Dec. 28, 2012	Dec. 27, 2013
			Dec. 27, 2013	Dec. 26, 2014
LISN ROHDE & SCHWARZ (Peripheral)	ESH3-Z5	100311	Jul. 17, 2013	Jul. 16, 2014
LISN ROHDE & SCHWARZ (EUT)	ESH3-Z5	835239/001	Feb. 04, 2013	Feb. 03, 2014
Software ADT	BV ADT_Cond_ V7.3.7.3	NA	NA	NA

- NOTE:**
1. The calibration interval of the above test instruments is 12 months and the calibrations are traceable to NML/ROC and NIST/USA.
 2. The test was performed in HwaYa Shielded Room 1.
 3. The VCCI Site Registration No. is C-2040.

4.2.3 TEST PROCEDURES

- a. The EUT was placed 0.4 meters from the conducting wall of the shielded room with EUT being connected to the power mains through a line impedance stabilization network (LISN). Other support units were connected to the power mains through another LISN. The two LISNs provide 50 ohm/ 50uH of coupling impedance for the measuring instrument.
- b. Both lines of the power mains connected to the EUT were checked for maximum conducted interference.
- c. The frequency range from 150kHz to 30MHz was searched. Emission levels under (Limit - 20dB) was not recorded.

NOTE: All modes of operation were investigated and the worst-case emissions are reported.

4.2.4 DEVIATION FROM TEST STANDARD

No deviation.

4.2.5 TEST SETUP

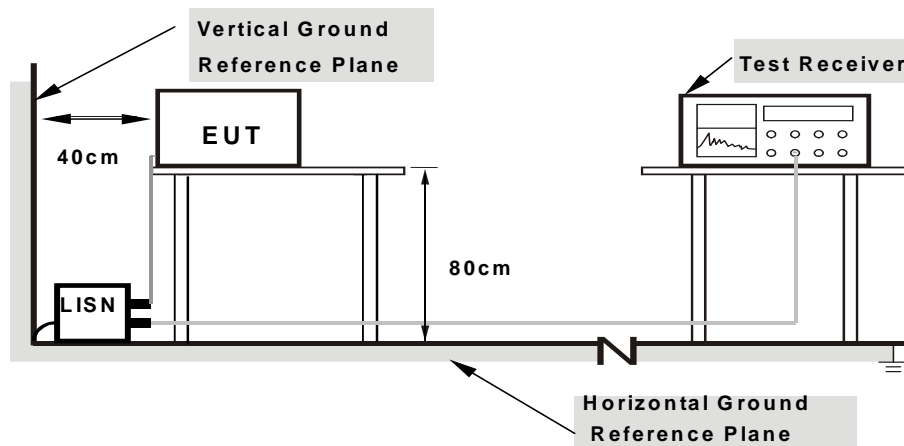

- Note:**
1. Support units were connected to second LISN.
 2. Both of LISNs (AMN) are 80 cm from EUT and at least 80 from other units and other metal planes

For the actual test configuration, please refer to the attached file (Test Setup Photo).

4.2.6 EUT OPERATING CONDITIONS

Same as 4.1.6.

4.2.7 TEST RESULTS

CONDUCTED WORST-CASE DATA : 802.11b

PHASE	Line 1	6dB BANDWIDTH	9kHz
TEST MODE	A		

No	Freq. [MHz]	Corr. Factor (dB)	Reading Value		Emission Level		Limit		Margin	
			[dB (uV)]		[dB (uV)]		[dB (uV)]		(dB)	
			Q.P.	AV.	Q.P.	AV.	Q.P.	AV.	Q.P.	AV.
1	0.15782	0.10	50.72	34.18	50.82	34.28	65.58	55.58	-14.76	-21.30
2	0.24775	0.10	41.81	27.97	41.91	28.07	61.83	51.83	-19.92	-23.76
3	0.51043	0.12	40.83	32.48	40.95	32.60	56.00	46.00	-15.05	-13.40
4	1.93296	0.17	25.46	17.74	25.63	17.91	56.00	46.00	-30.37	-28.09
5	3.96225	0.23	26.40	18.49	26.63	18.72	56.00	46.00	-29.37	-27.28
6	10.46067	0.51	26.22	19.24	26.73	19.75	60.00	50.00	-33.27	-30.25

REMARKS:

1. Q.P. and AV. are abbreviations of quasi-peak and average individually.
2. The emission levels of other frequencies were very low against the limit.
3. Margin value = Emission level - Limit value
4. Correction factor = Insertion loss + Cable loss
5. Emission Level = Correction Factor + Reading Value

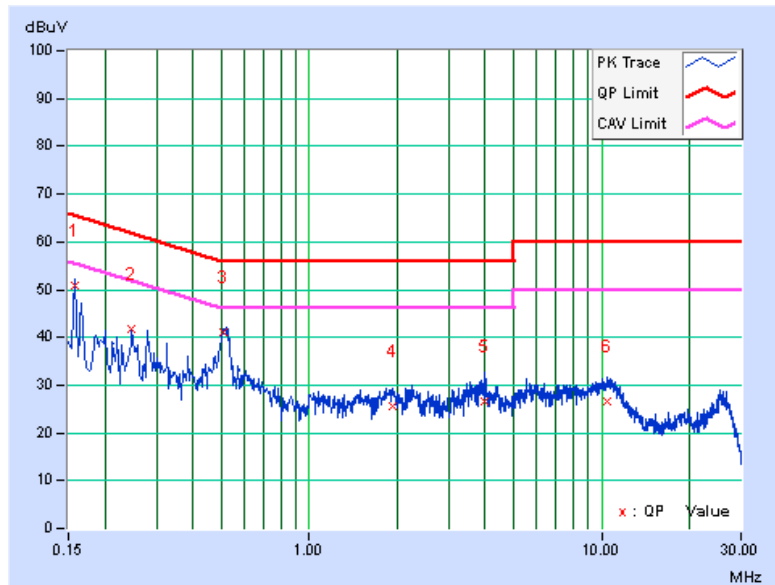

PHASE	Line 2	6dB BANDWIDTH	9kHz
TEST MODE	A		

No	Freq. [MHz]	Corr. Factor (dB)	Reading Value		Emission Level		Limit		Margin	
			[dB (uV)]		[dB (uV)]		[dB (uV)]		(dB)	
			Q.P.	AV.	Q.P.	AV.	Q.P.	AV.	Q.P.	AV.
1	0.15782	0.11	49.81	32.42	49.92	32.53	65.58	55.58	-15.66	-23.05
2	0.21647	0.11	42.74	27.89	42.85	28.00	62.95	52.95	-20.10	-24.95
3	0.28685	0.12	35.87	23.64	35.99	23.76	60.62	50.62	-24.63	-26.86
4	0.51177	0.13	39.59	30.95	39.72	31.08	56.00	46.00	-16.28	-14.92
5	1.12750	0.14	30.55	21.15	30.69	21.29	56.00	46.00	-25.31	-24.71
6	10.85167	0.39	29.16	21.97	29.55	22.36	60.00	50.00	-30.45	-27.64

REMARKS:

1. Q.P. and AV. are abbreviations of quasi-peak and average individually.
2. The emission levels of other frequencies were very low against the limit.
3. Margin value = Emission level - Limit value
4. Correction factor = Insertion loss + Cable loss
5. Emission Level = Correction Factor + Reading Value

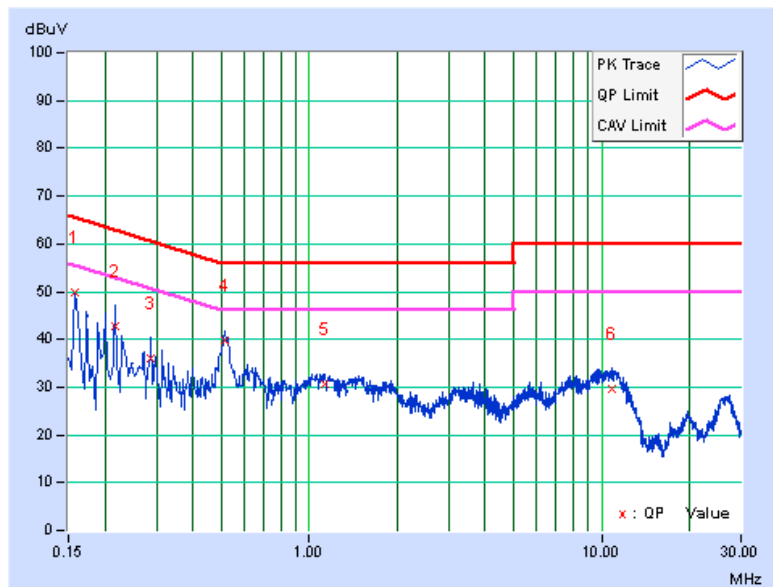

PHASE	Line 1	6dB BANDWIDTH	9kHz
TEST MODE	B		

No	Freq. [MHz]	Corr. Factor (dB)	Reading Value		Emission Level		Limit		Margin	
			[dB (uV)]		[dB (uV)]		[dB (uV)]		(dB)	
			Q.P.	AV.	Q.P.	AV.	Q.P.	AV.	Q.P.	AV.
1	0.23216	0.10	43.34	38.70	43.44	38.80	62.37	52.37	-18.93	-13.57
2	0.45889	0.12	37.35	29.80	37.47	29.92	56.71	46.71	-19.24	-16.79
3	0.70131	0.13	40.11	33.05	40.24	33.18	56.00	46.00	-15.76	-12.82
4	1.04539	0.14	37.54	32.93	37.68	33.07	56.00	46.00	-18.32	-12.93
5	2.09327	0.17	34.92	24.84	35.09	25.01	56.00	46.00	-20.91	-20.99
6	14.85942	0.69	41.32	39.86	42.01	40.55	60.00	50.00	-17.99	-9.45

REMARKS:

1. Q.P. and AV. are abbreviations of quasi-peak and average individually.
2. The emission levels of other frequencies were very low against the limit.
3. Margin value = Emission level - Limit value
4. Correction factor = Insertion loss + Cable loss
5. Emission Level = Correction Factor + Reading Value

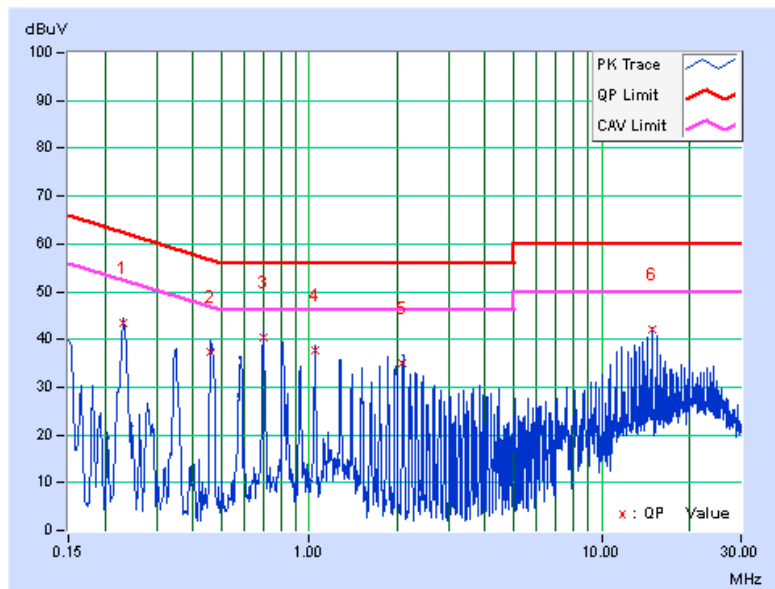



A D T

PHASE	Line 2	6dB BANDWIDTH	9kHz
TEST MODE	B		

No	Freq. [MHz]	Corr. Factor (dB)	Reading Value		Emission Level		Limit		Margin	
			[dB (uV)]		[dB (uV)]		[dB (uV)]		(dB)	
			Q.P.	AV.	Q.P.	AV.	Q.P.	AV.	Q.P.	AV.
1	0.23155	0.11	45.30	41.53	45.41	41.64	62.39	52.39	-16.98	-10.75
2	0.34941	0.12	42.79	40.26	42.91	40.38	58.98	48.98	-16.06	-8.59
3	0.46669	0.13	41.91	38.23	42.04	38.36	56.57	46.57	-14.53	-8.21
4	0.69349	0.13	39.84	35.13	39.97	35.26	56.00	46.00	-16.03	-10.74
5	1.87040	0.16	34.81	19.07	34.97	19.23	56.00	46.00	-21.03	-26.77
6	14.30029	0.47	40.41	38.89	40.88	39.36	60.00	50.00	-19.12	-10.64

REMARKS:

1. Q.P. and AV. are abbreviations of quasi-peak and average individually.
2. The emission levels of other frequencies were very low against the limit.
3. Margin value = Emission level - Limit value
4. Correction factor = Insertion loss + Cable loss
5. Emission Level = Correction Factor + Reading Value

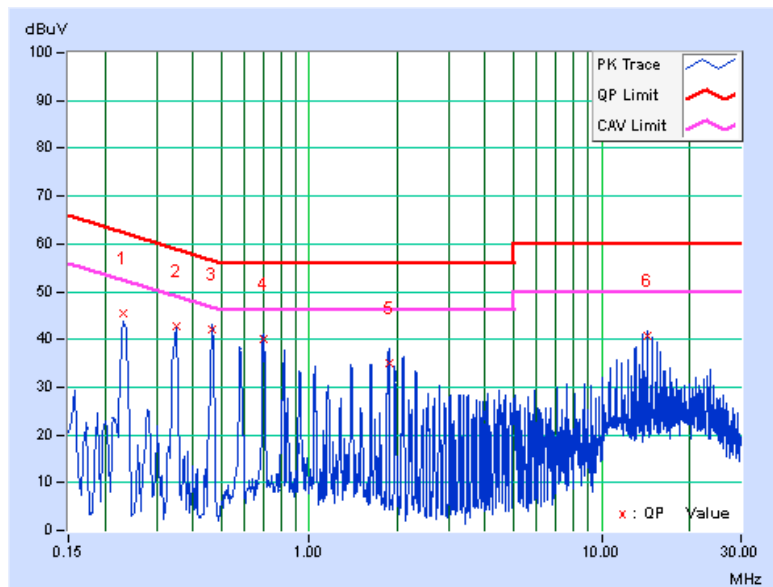

4.3 6dB BANDWIDTH MEASUREMENT

4.3.1 LIMITS OF 6dB BANDWIDTH MEASUREMENT

The minimum of 6dB Bandwidth Measurement is 0.5 MHz.

4.3.2 TEST SETUP

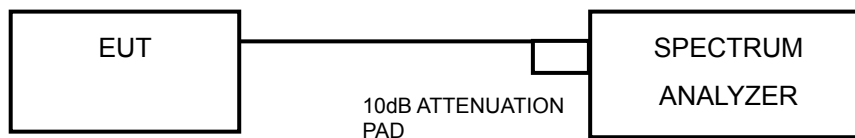

4.3.3 TEST INSTRUMENTS

Refer to section 4.1.2 to get information of above instrument.

4.3.4 TEST PROCEDURE

- a. Set resolution bandwidth (RBW) = 100kHz
- b. Set the video bandwidth (VBW) $\geq 3 \times$ RBW, Detector = Peak.
- c. Trace mode = max hold.
- d. Sweep = auto couple.
- e. Measure the maximum width of the emission that is constrained by the frequencies associated with the two amplitude points (upper and lower) that are attenuated by 6 dB relative to the maximum level measured in the fundamental emission

4.3.5 DEVIATION FROM TEST STANDARD

No deviation.

4.3.6 EUT OPERATING CONDITIONS

The software provided by client to enable the EUT under transmission condition continuously at lowest, middle and highest channel frequencies individually.



A D T

4.3.7 TEST RESULTS

802.11b

CHANNEL	FREQUENCY (MHz)	6dB BANDWIDTH (MHz)			MINIMUM LIMIT (MHz)	PASS / FAIL
		CHAIN 0	CHAIN 1	CHAIN 2		
1	2412	6.08	5.63	6.06	0.5	PASS
6	2437	6.07	6.08	6.10	0.5	PASS
11	2462	6.11	6.08	6.07	0.5	PASS

802.11g

CHANNEL	FREQUENCY (MHz)	6dB BANDWIDTH (MHz)			MINIMUM LIMIT (MHz)	PASS / FAIL
		CHAIN 0	CHAIN 1	CHAIN 2		
1	2412	16.38	16.08	16.37	0.5	PASS
6	2437	16.38	16.38	16.38	0.5	PASS
11	2462	16.39	16.40	16.41	0.5	PASS

802.11n (20MHz)

CHANNEL	FREQUENCY (MHz)	6dB BANDWIDTH (MHz)			MINIMUM LIMIT (MHz)	PASS / FAIL
		CHAIN 0	CHAIN 1	CHAIN 2		
1	2412	17.24	17.71	17.69	0.5	PASS
6	2437	16.33	17.67	17.72	0.5	PASS
11	2462	16.54	17.67	17.72	0.5	PASS

802.11n (40MHz)

CHANNEL	FREQUENCY (MHz)	6dB BANDWIDTH (MHz)			MINIMUM LIMIT (MHz)	PASS / FAIL
		CHAIN 0	CHAIN 1	CHAIN 2		
3	2422	36.07	35.80	36.49	0.5	PASS
6	2437	35.43	35.87	36.51	0.5	PASS
9	2452	35.87	35.86	36.51	0.5	PASS



A D T

SPECTRUM PLOT OF WORST VALUE

802.11b

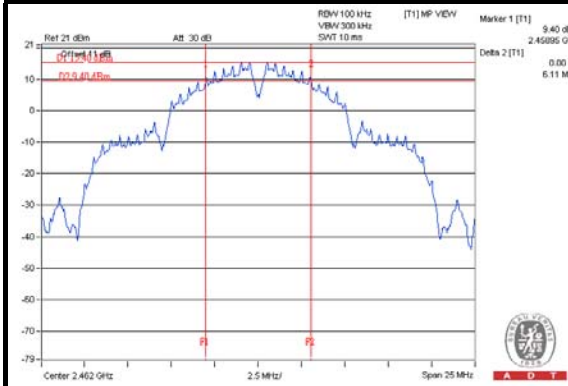

802.11g

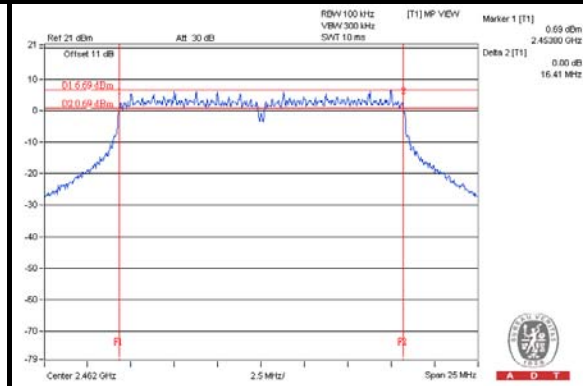

802.11n (20MHz)

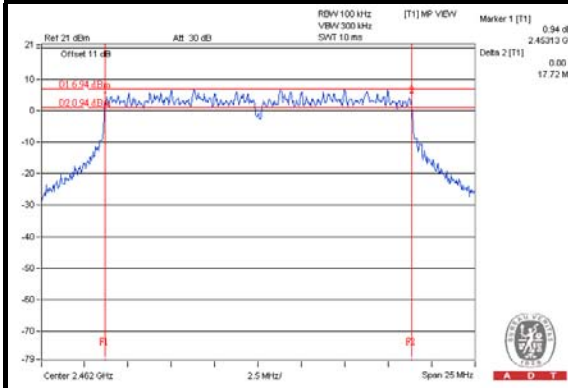

802.11n (40MHz)

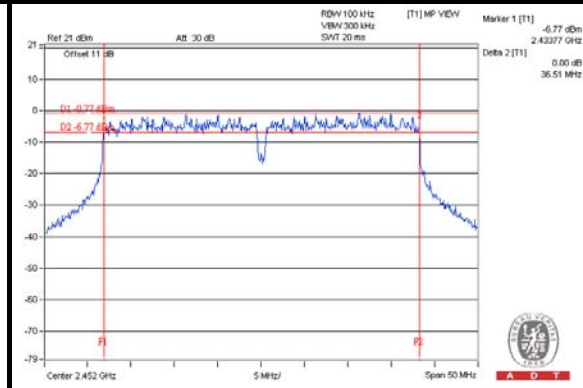

4.4 CONDUCTED OUTPUT POWER

4.4.1 LIMITS OF CONDUCTED OUTPUT POWER MEASUREMENT

For systems using digital modulation in the 2400–2483.5 MHz bands: 1 Watt (30dBm)

Per KDB 662911 D01 Multiple Transmitter Output v02 Method of conducted output power measurement on IEEE 802.11 devices,

Array Gain = 0 dB (i.e., no array gain) for $NANT \leq 4$;

Array Gain = 0 dB (i.e., no array gain) for channel widths ≥ 40 MHz for any NANT;

Array Gain = $5 \log(NANT/NSS)$ dB or 3 dB, whichever is less for 20-MHz channel widths with $NANT \geq 5$.

For power measurements on all other devices: Array Gain = $10 \log(NANT/NSS)$ dB.

4.4.2 TEST SETUP

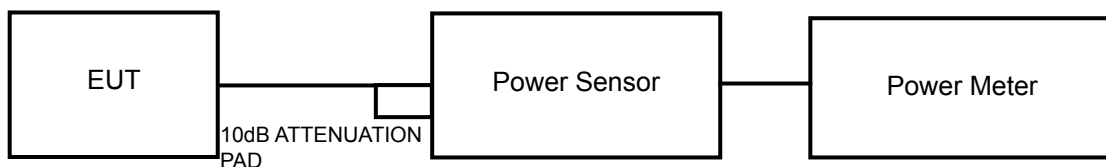

4.4.3 TEST INSTRUMENTS

Refer to section 4.1.2 to get information of above instrument.

4.4.4 TEST PROCEDURES

An average power sensor was used on the output port of the EUT. A power meter was used to read the response of the average power sensor. Record the power level.



A D T

4.4.5 DEVIATION FROM TEST STANDARD

No deviation.

4.4.6 EUT OPERATING CONDITIONS

Same as Item 4.3.6.



A D T

4.4.7 TEST RESULTS

802.11b

CHAN.	FREQ. (MHz)	AVG. POWER (dBm)			TOTAL POWER (mW)	TOTAL POWER (dBm)	LIMIT (dBm)	PASS / FAIL
		CHAIN 0	CHAIN 1	CHAIN 2				
1	2412	23.80	23.72	23.11	680.032	28.33	30	PASS
6	2437	21.56	21.36	19.76	374.616	25.74	30	PASS
11	2462	23.16	22.34	21.62	523.621	27.19	30	PASS

802.11g

CHAN.	FREQ. (MHz)	AVG. POWER (dBm)			TOTAL POWER (mW)	TOTAL POWER (dBm)	LIMIT (dBm)	PASS / FAIL
		CHAIN 0	CHAIN 1	CHAIN 2				
1	2412	18.44	18.19	17.12	187.263	22.72	30	PASS
6	2437	22.52	22.15	21.32	478.227	26.80	30	PASS
11	2462	19.60	19.18	18.83	250.379	23.99	30	PASS

802.11n (20MHz)

CHAN.	FREQ. (MHz)	AVG. POWER (dBm)			TOTAL POWER (mW)	TOTAL POWER (dBm)	LIMIT (dBm)	PASS / FAIL
		CHAIN 0	CHAIN 1	CHAIN 2				
1	2412	17.32	16.48	15.78	136.258	21.34	30	PASS
6	2437	23.85	23.50	22.22	633.258	28.02	30	PASS
11	2462	19.15	18.89	17.94	221.900	23.46	30	PASS

802.11n (40MHz)

CHAN.	FREQ. (MHz)	AVG. POWER (dBm)			TOTAL POWER (mW)	TOTAL POWER (dBm)	LIMIT (dBm)	PASS / FAIL
		CHAIN 0	CHAIN 1	CHAIN 2				
3	2422	15.46	14.32	14.07	87.723	19.43	30	PASS
6	2437	19.49	18.84	17.94	227.710	23.57	30	PASS
9	2452	15.07	14.27	13.37	80.594	19.06	30	PASS

4.5 POWER SPECTRAL DENSITY MEASUREMENT

4.5.1 LIMITS OF POWER SPECTRAL DENSITY MEASUREMENT

The Maximum of Power Spectral Density Measurement is 8dBm.

4.5.2 TEST SETUP

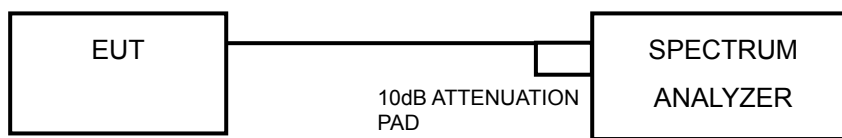

4.5.3 TEST INSTRUMENTS

Refer to section 4.1.2 to get information of above instrument.

4.5.4 TEST PROCEDURE

- a. Set the RBW = 3 kHz, VBW = 10 kHz, Detector = peak.
- b. Sweep time = auto couple, Trace mode = max hold, allow trace to fully stabilize.
- c. Use the peak marker function to determine the maximum power level in any 100 kHz band segment within the fundamental EBW.

4.5.5 DEVIATION FROM TEST STANDARD

No deviation.

4.5.6 EUT OPERATING CONDITION

Same as Item 4.3.6



A D T

4.5.7 TEST RESULTS

802.11b

TX chain	Channel	Freq. (MHz)	PSD (dBm/3kHz)	10 log (N=3) dB	Total PSD (dBm/3kHz)	Limit (dBm/3kHz)	PASS /FAIL
0	1	2412	-4.33	4.77	0.44	5.23	PASS
	6	2437	-7.02	4.77	-2.25	5.23	PASS
	11	2462	-4.46	4.77	0.31	5.23	PASS
1	1	2412	-6.23	4.77	-1.46	5.23	PASS
	6	2437	-8.68	4.77	-3.91	5.23	PASS
	11	2462	-5.98	4.77	-1.21	5.23	PASS
2	1	2412	-7.32	4.77	-2.55	5.23	PASS
	6	2437	-10.09	4.77	-5.32	5.23	PASS
	11	2462	-7.16	4.77	-2.39	5.23	PASS

NOTE: Directional gain = $4\text{dBi} + 10\log(3) = 8.77\text{dBi} > 6\text{dBi}$, so the power density limit shall be reduced to $8-(8.77-6) = 5.23\text{dBm}$.

802.11g

TX chain	Channel	Freq. (MHz)	PSD (dBm/3kHz)	10 log (N=3) dB	Total PSD (dBm/3kHz)	Limit (dBm/3kHz)	PASS /FAIL
0	1	2412	-13.58	4.77	-8.81	5.23	PASS
	6	2437	-10.16	4.77	-5.39	5.23	PASS
	11	2462	-12.55	4.77	-7.78	5.23	PASS
1	1	2412	-11.12	4.77	-6.35	5.23	PASS
	6	2437	-7.51	4.77	-2.74	5.23	PASS
	11	2462	-12.53	4.77	-7.76	5.23	PASS
2	1	2412	-14.78	4.77	-10.01	5.23	PASS
	6	2437	-12.22	4.77	-7.45	5.23	PASS
	11	2462	-11.96	4.77	-7.19	5.23	PASS

NOTE: Directional gain = $4\text{dBi} + 10\log(3) = 8.77\text{dBi} > 6\text{dBi}$, so the power density limit shall be reduced to $8-(8.77-6) = 5.23\text{dBm}$.



A D T

802.11n (20MHz)

TX chain	Channel	Freq. (MHz)	PSD (dBm/3kHz)	10 log (N=3) dB	Total PSD (dBm/3kHz)	Limit (dBm/3kHz)	PASS /FAIL
0	1	2412	-13.88	4.77	-9.11	8	PASS
	6	2437	-7.75	4.77	-2.98	8	PASS
	11	2462	-13.06	4.77	-8.29	8	PASS
1	1	2412	-15.11	4.77	-10.34	8	PASS
	6	2437	-8.99	4.77	-4.22	8	PASS
	11	2462	-13.50	4.77	-8.73	8	PASS
2	1	2412	-16.80	4.77	-12.03	8	PASS
	6	2437	-9.44	4.77	-4.67	8	PASS
	11	2462	-10.80	4.77	-6.03	8	PASS

NOTE:

1. 802.11n transmit signals are completely uncorrelated.
2. Directional gain = 4dBi + 10log(3/3) = 4dBi < 6dBi, so the power density limit no need to reduced.

802.11n (40MHz)

TX chain	Channel	Freq. (MHz)	PSD (dBm/3kHz)	10 log (N=3) dB	Total PSD (dBm/3kHz)	Limit (dBm/3kHz)	PASS /FAIL
0	3	2422	-16.90	4.77	-12.13	8	PASS
	6	2437	-14.65	4.77	-9.88	8	PASS
	9	2452	-19.72	4.77	-14.95	8	PASS
1	3	2422	-20.06	4.77	-15.29	8	PASS
	6	2437	-15.70	4.77	-10.93	8	PASS
	9	2452	-20.44	4.77	-15.67	8	PASS
2	3	2422	-21.67	4.77	-16.90	8	PASS
	6	2437	-17.25	4.77	-12.48	8	PASS
	9	2452	-22.34	4.77	-17.57	8	PASS

NOTE:

1. 802.11n transmit signals are completely uncorrelated.
2. Directional gain = 4dBi + 10log(3/3) = 4dBi < 6dBi, so the power density limit no need to reduced.



A D T

SPECTRUM PLOT OF WORST VALUE

802.11b

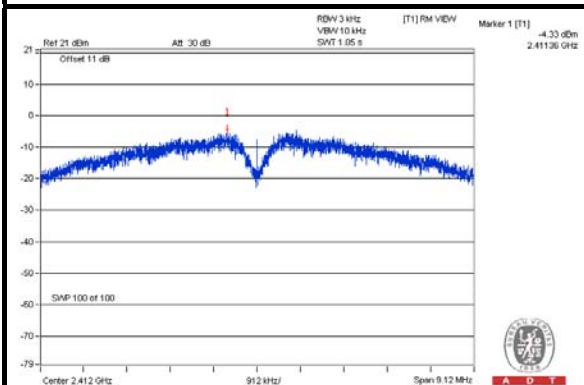

802.11g

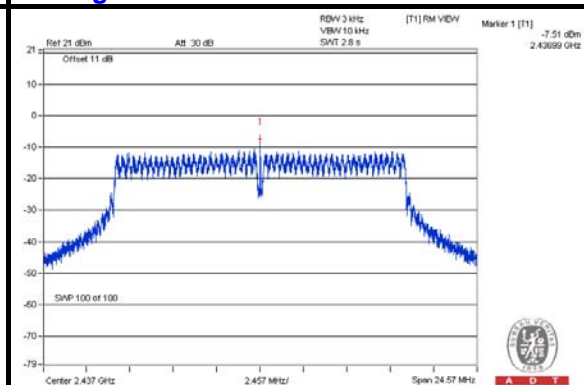

802.11n (20MHz)

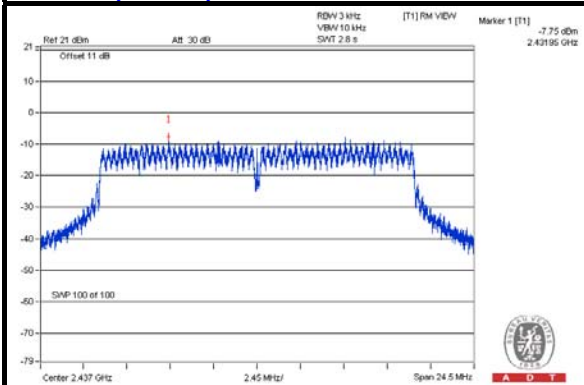

802.11n (40MHz)

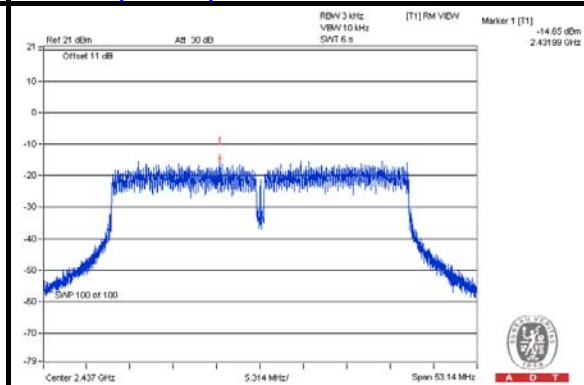

4.6 CONDUCTED OUT OF BAND EMISSION MEASUREMENT

4.6.1 LIMITS OF CONDUCTED OUT OF BAND EMISSION MEASUREMENT

Below -30dB of the highest emission level of operating band (in 100kHz Resolution Bandwidth).

4.6.2 TEST SETUP

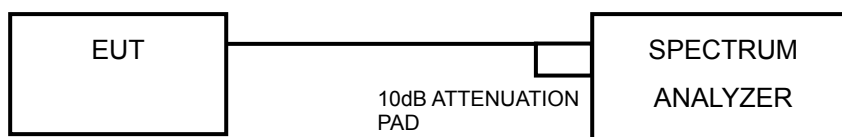

4.6.3 TEST INSTRUMENTS

Refer to section 4.1.2 to get information of above instrument.



A D T

4.6.4 TEST PROCEDURE

MEASUREMENT PROCEDURE REF

1. Set the RBW = 100 kHz.
2. Set the VBW \geq 300 kHz.
3. Detector = peak.
4. Sweep time = auto couple.
5. Trace mode = max hold.
6. Allow trace to fully stabilize.
7. Use the peak marker function to determine the maximum power level in any 100 kHz band segment within the fundamental EBW.

MEASUREMENT PROCEDURE OOB

1. Set RBW = 100 kHz.
2. Set VBW \geq 300 kHz.
3. Ensure that the number of measurement points \geq span/RBW
4. According to measurement points to set differ measurement span.
5. Detector = peak.
6. Trace Mode = max hold.
7. Sweep = auto couple.

4.6.5 DEVIATION FROM TEST STANDARD

No deviation.

4.6.6 EUT OPERATING CONDITION

Same as Item 4.3.6

4.6.7 TEST RESULTS

The conducted emission test is performed on each TX port of operating mode without summing or adding $10\log(N)$ since the limit is relative emission limit.

The spectrum plots are attached on the following pages. D1 line indicates the highest level, and D2 line indicates the 30dB offset below D1. It shows compliance with the requirement.



A D T

802.11b CHAIN 0

CH 1

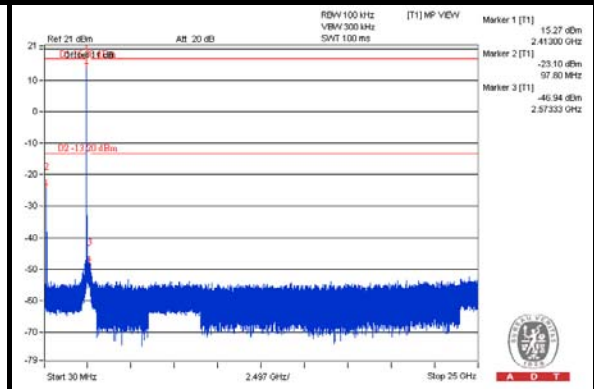
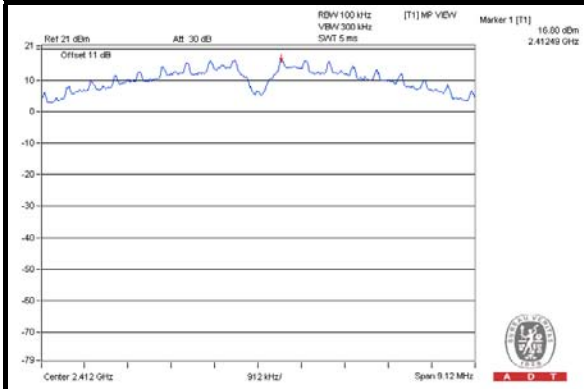

CH 6

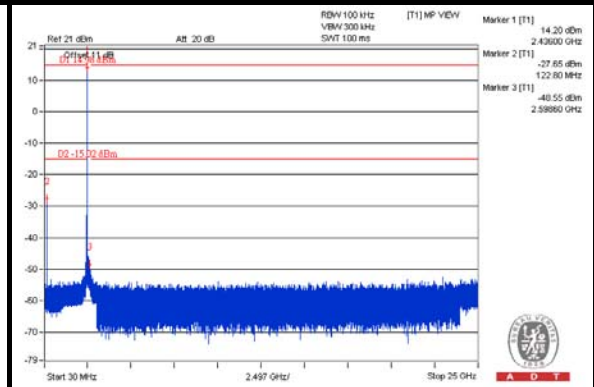
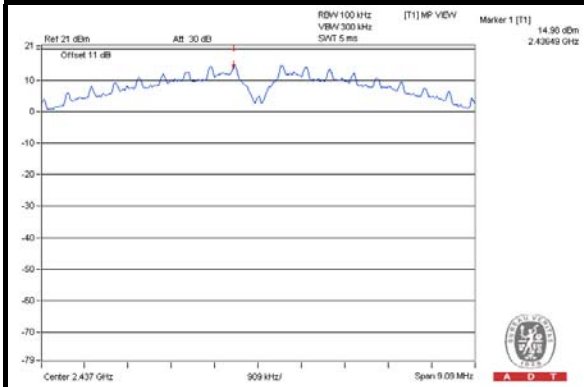

CH 11

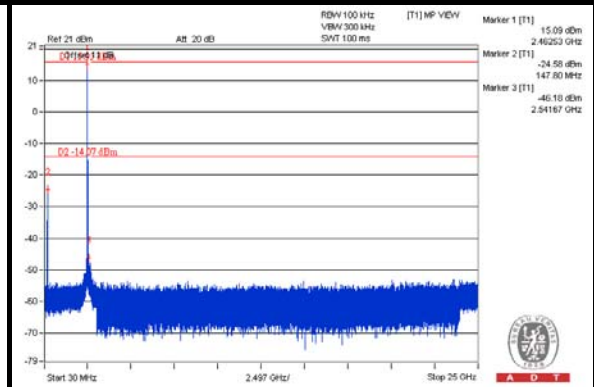
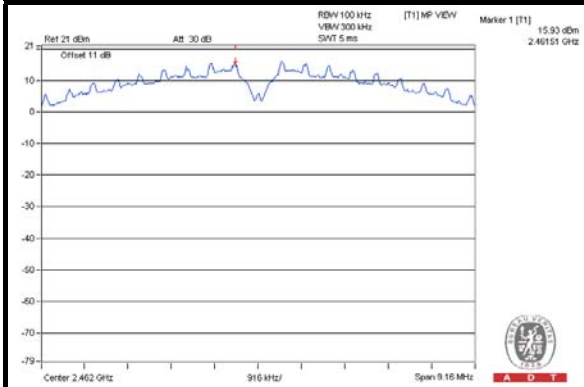

CH 1 Band edge

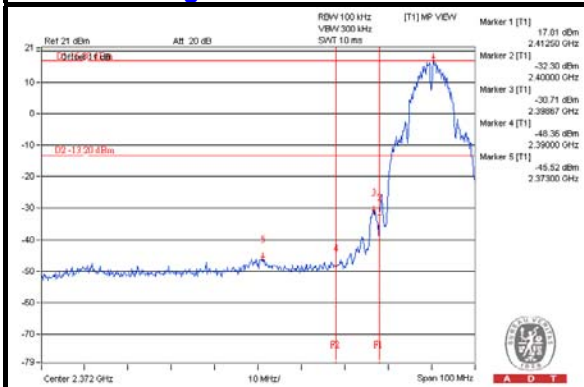

CH 11 Band edge

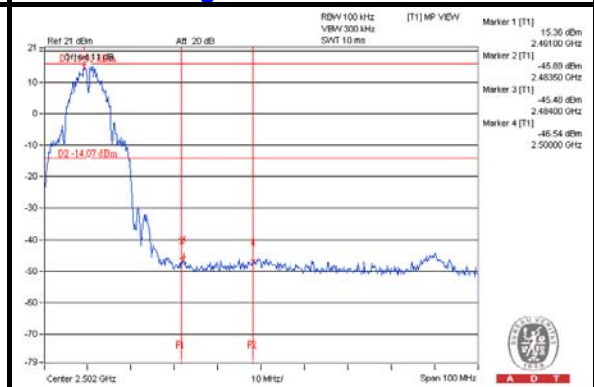



A D T

CHAIN 1

CH 1

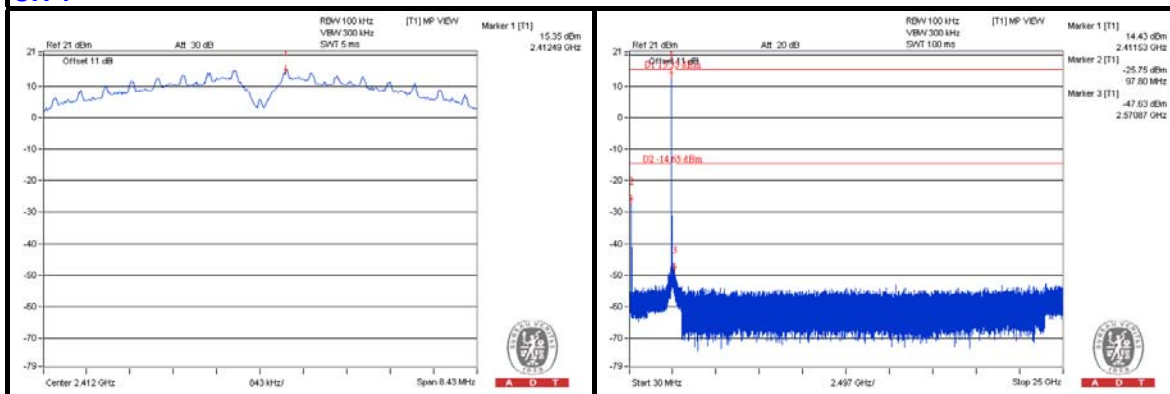

CH 6

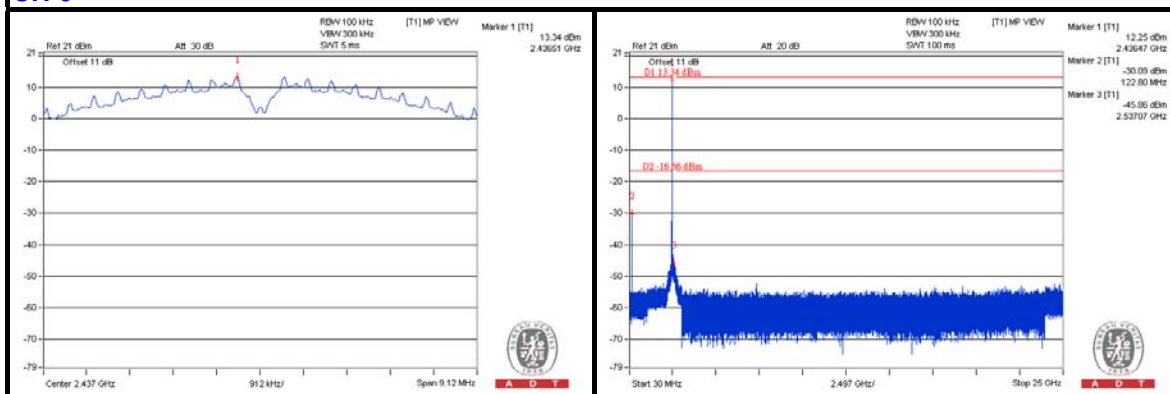

CH 11

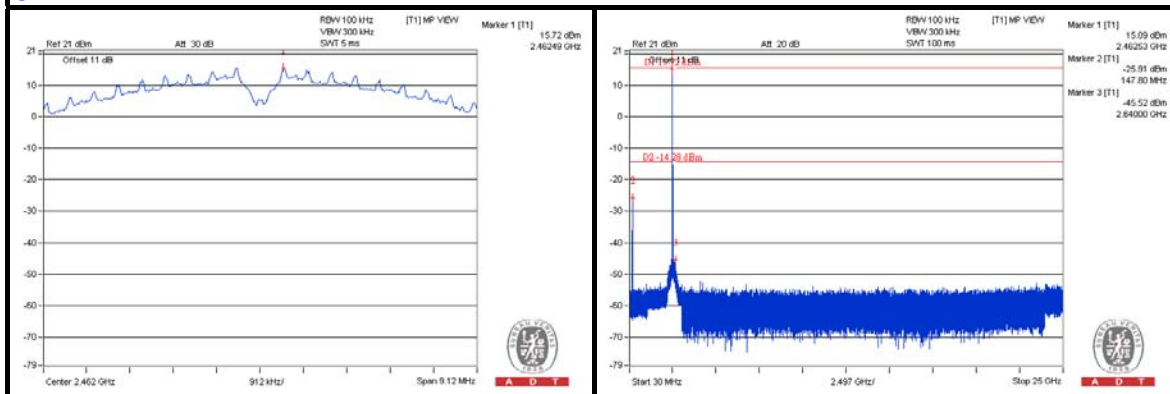

CH 1 Band edge

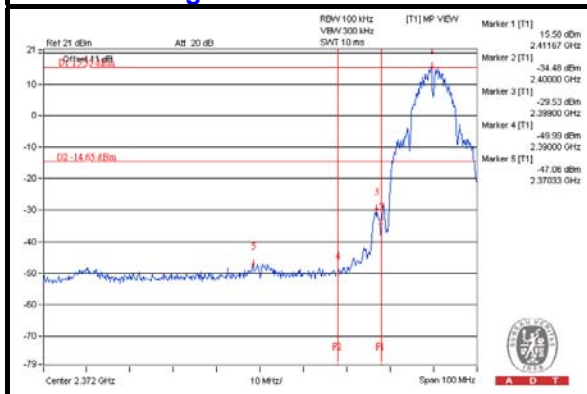

CH 11 Band edge

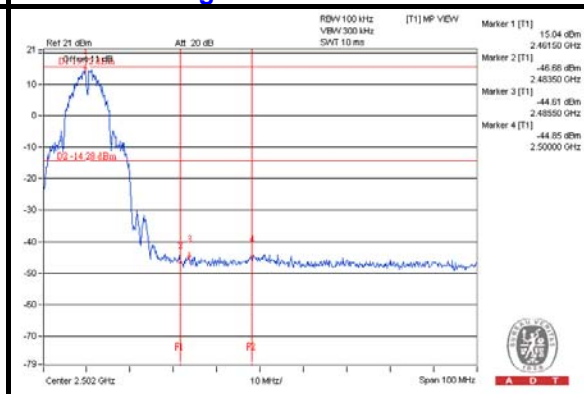



A D T

CHAIN 2

CH 1

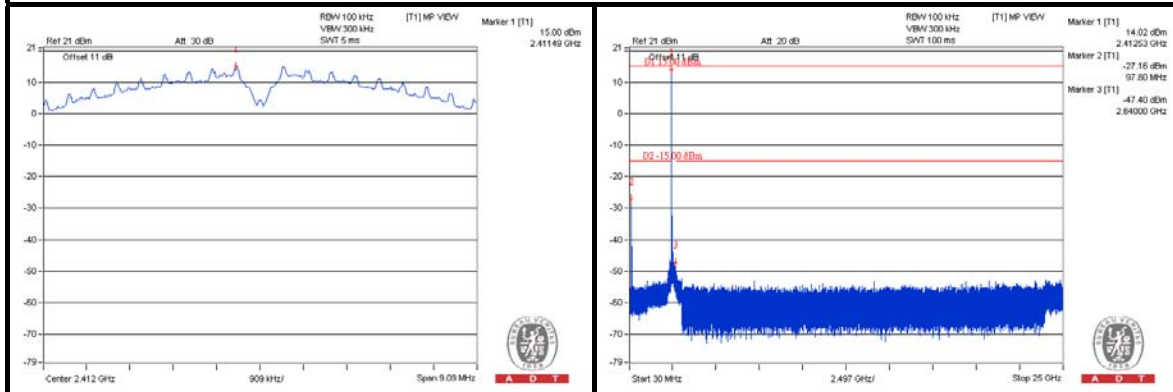

CH 6

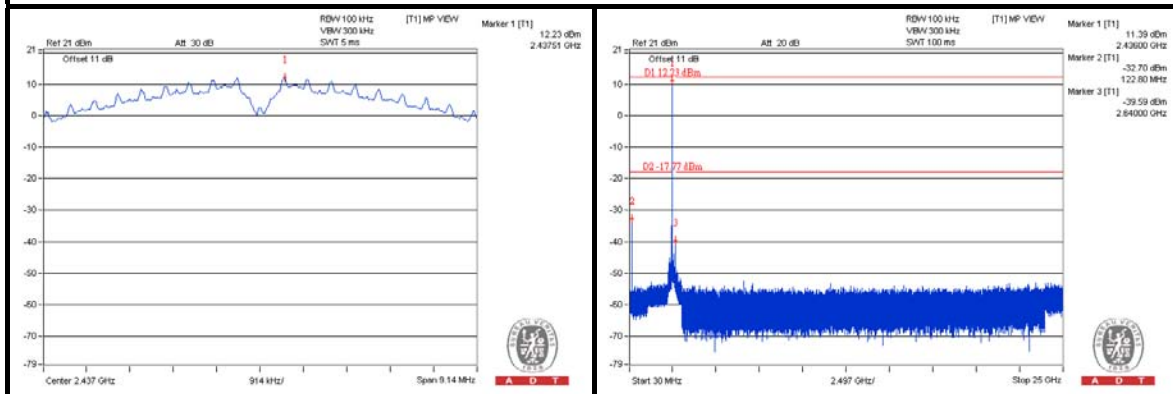

CH 11

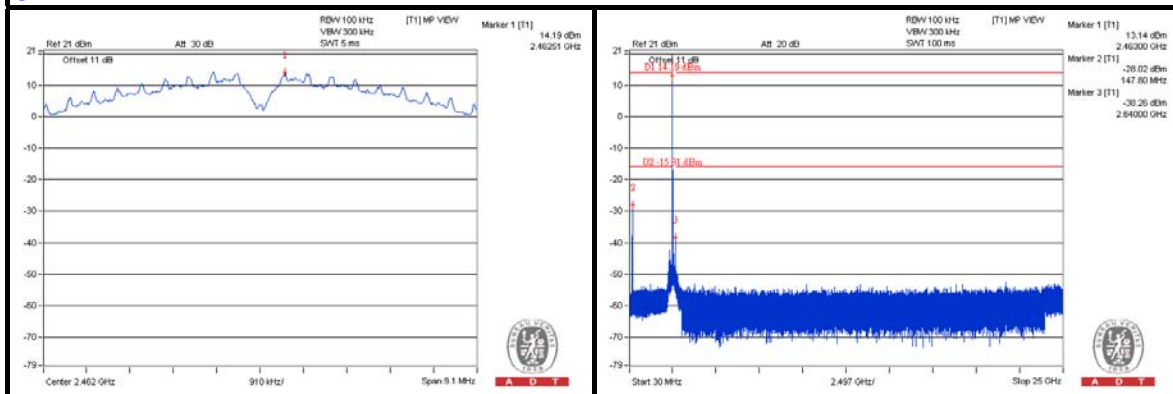

CH 1 Band edge

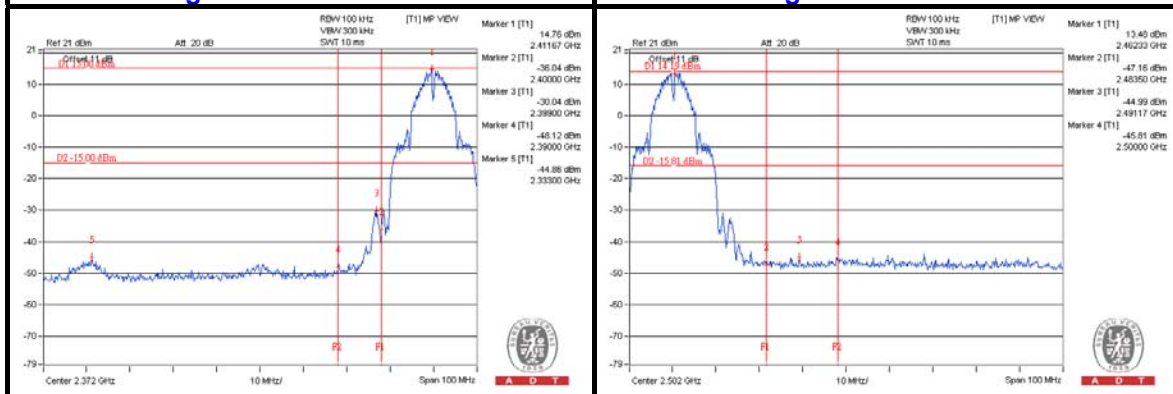



A D T

802.11g CHAIN 0

CH 1

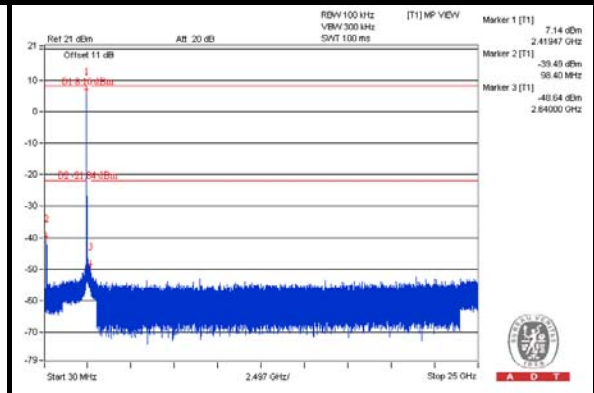
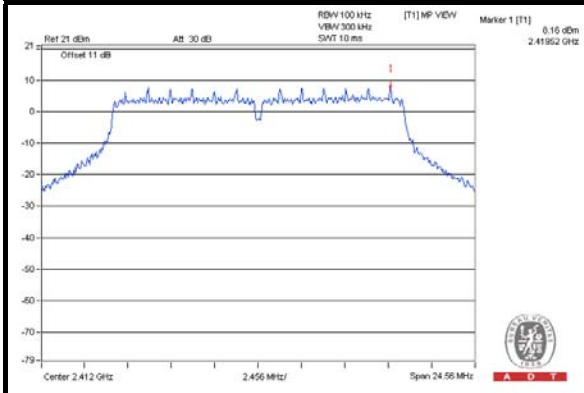

CH 6

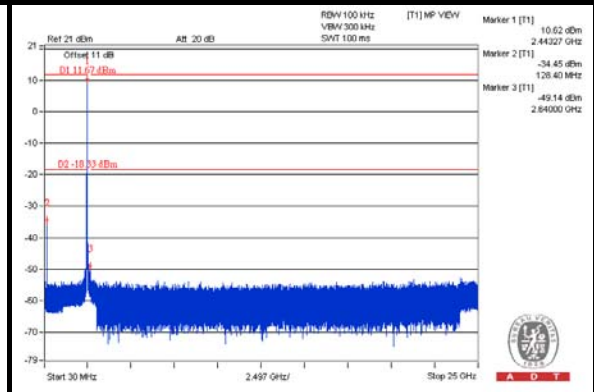
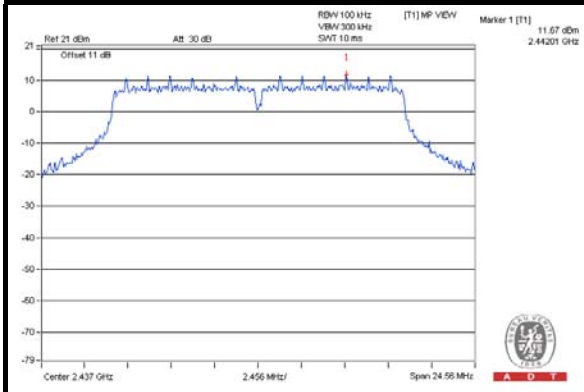

CH 11

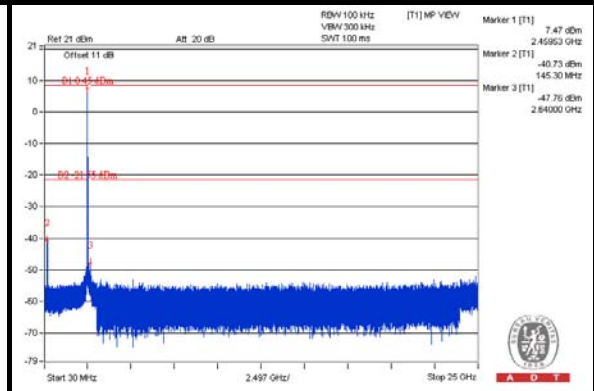
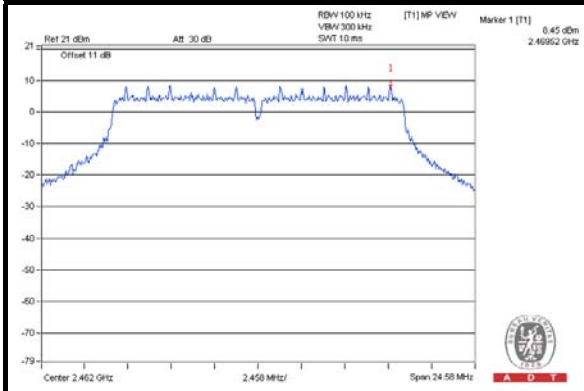

CH 1 Band edge

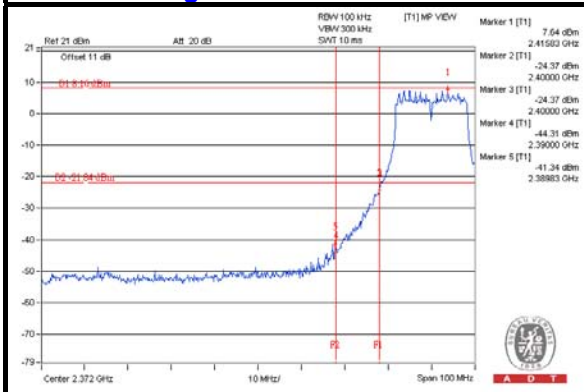

CH 11 Band edge

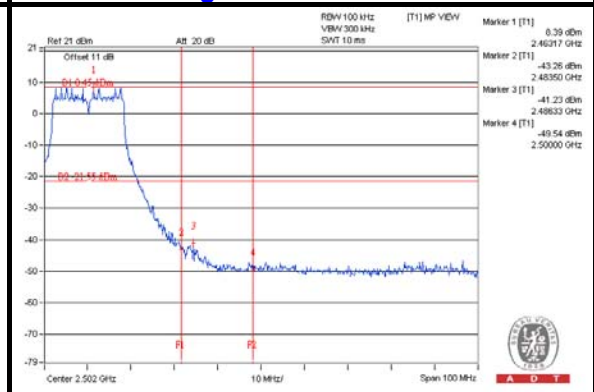



A D T

CHAIN 1

CH 1

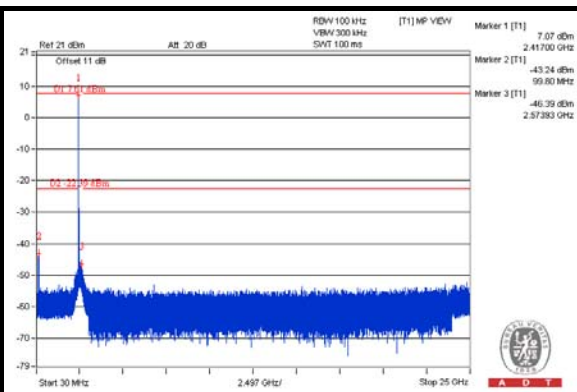
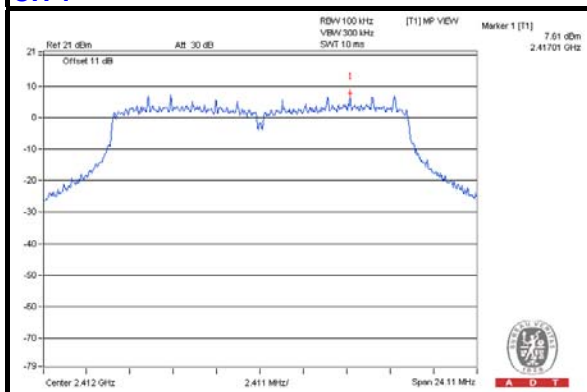

CH 6

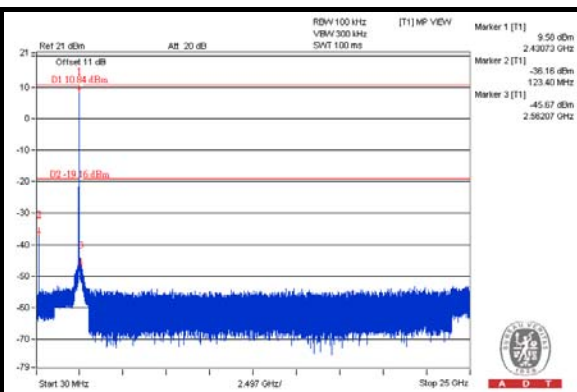
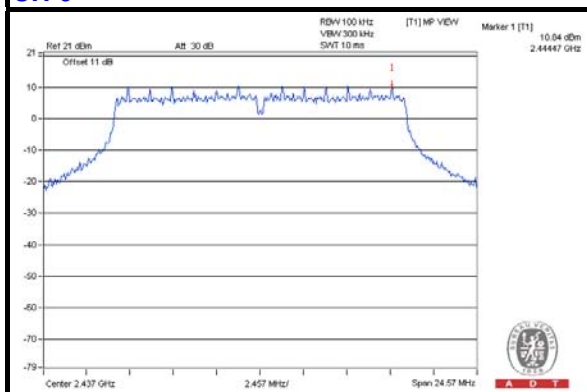

CH 11

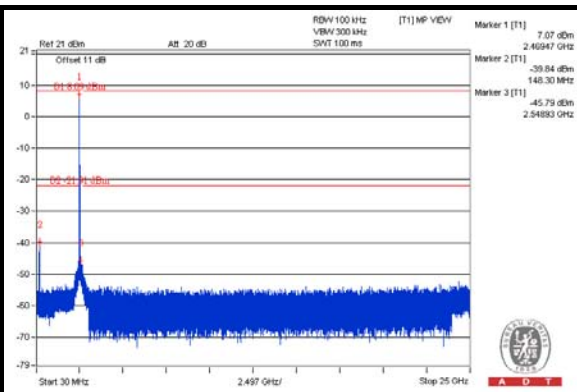
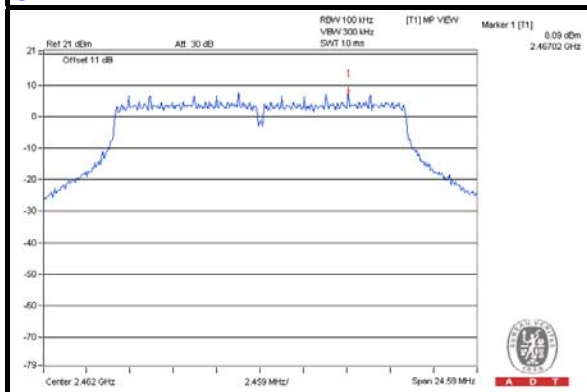

CH 1 Band edge

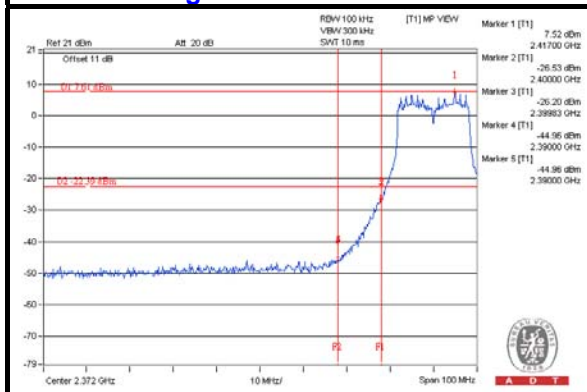

CH 11 Band edge

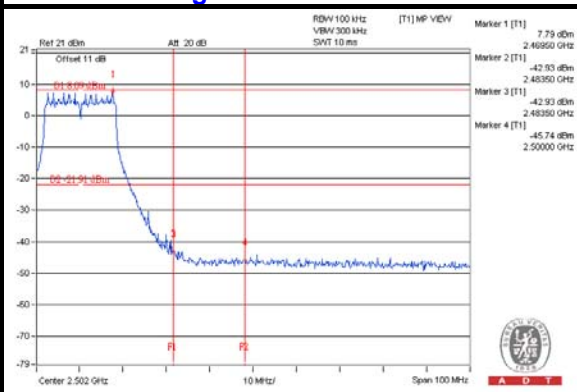



A D T

CHAIN 2

CH 1

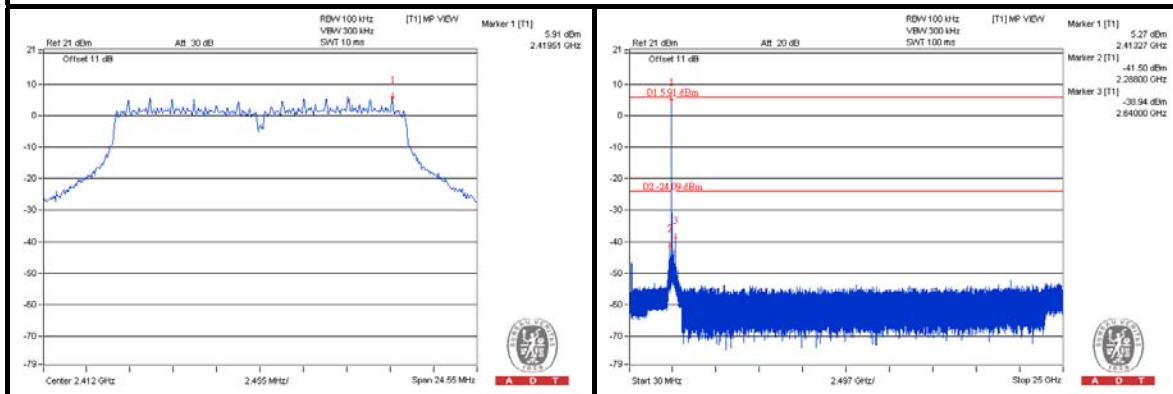

CH 6

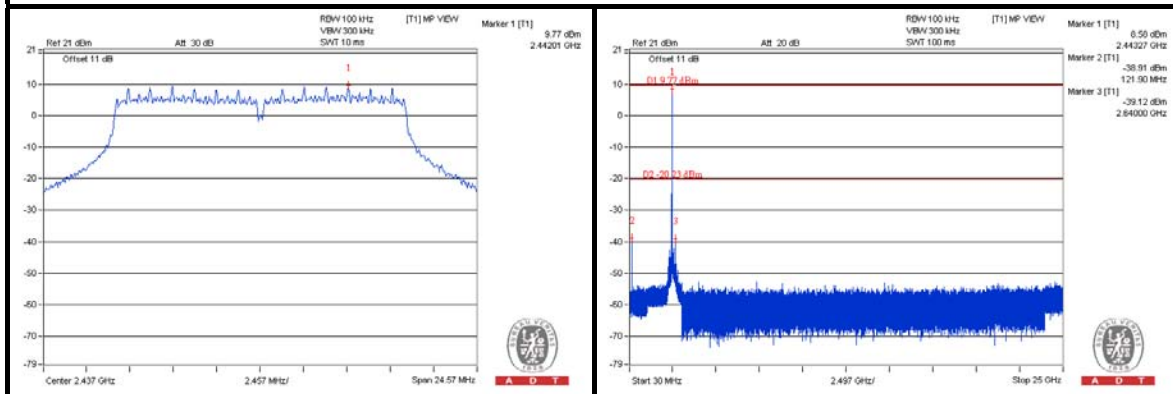

CH 11

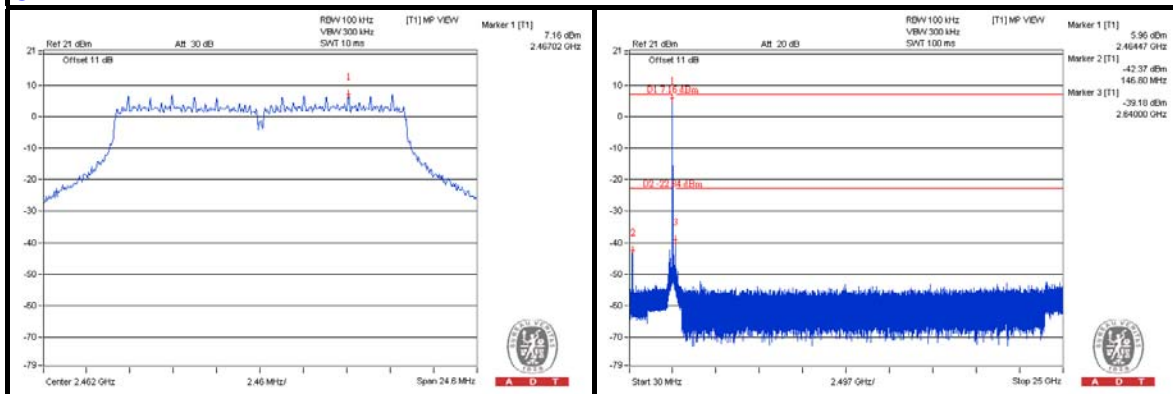

CH 1 Band edge

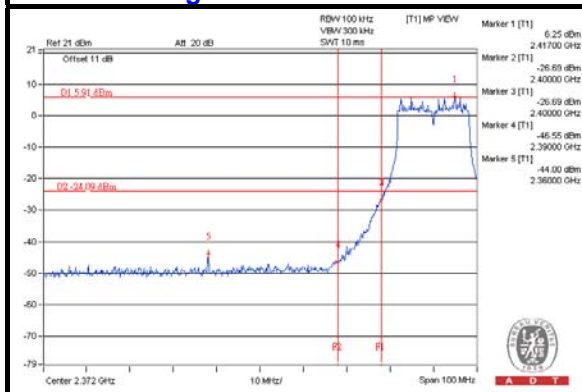

CH 11 Band edge

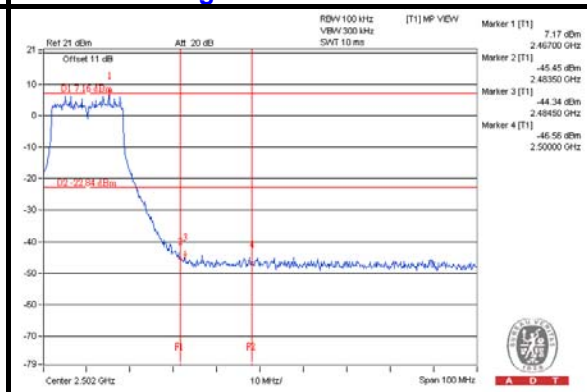



A D T

802.11n (20MHz) CHAIN 0

CH 1

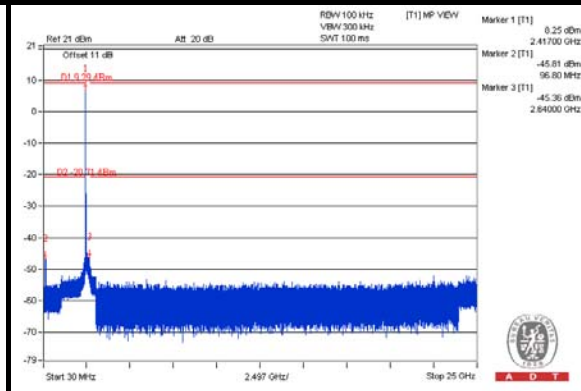
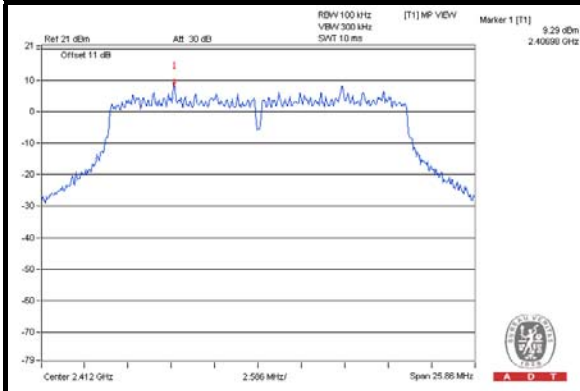

CH 6

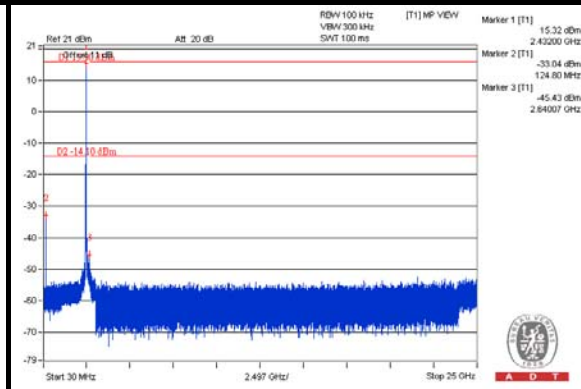
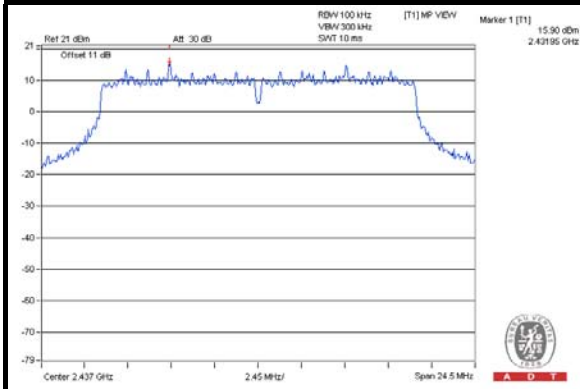

CH 11

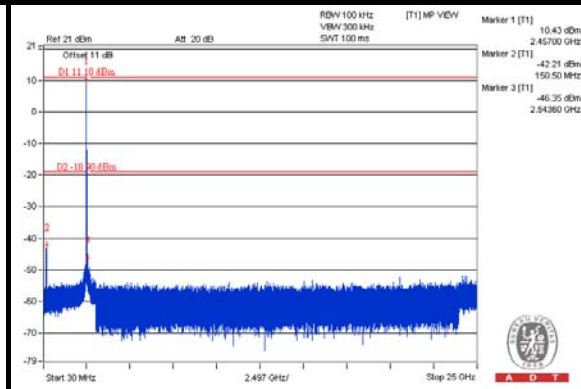
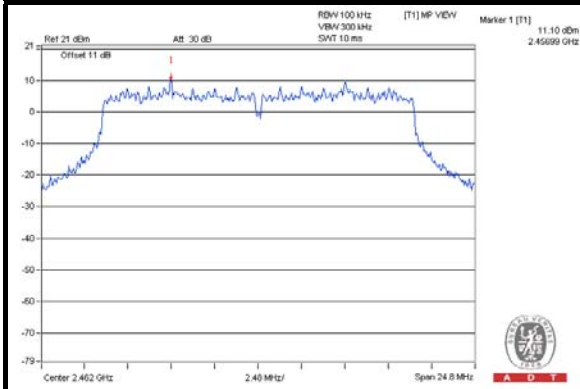

CH 1 Band edge

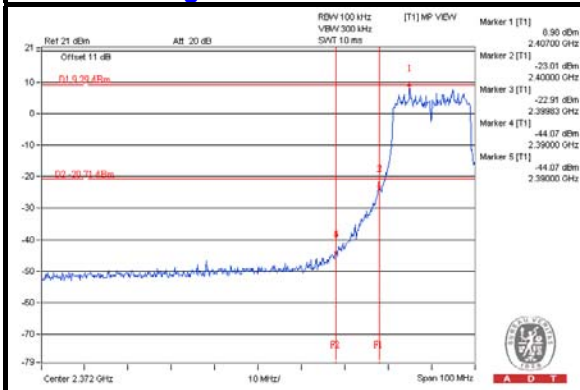

CH 11 Band edge

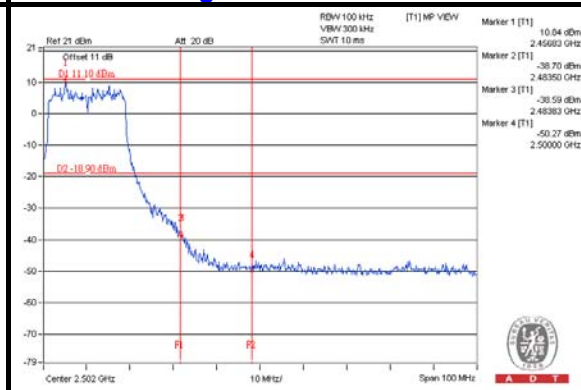



A D T

CHAIN 1

CH 1

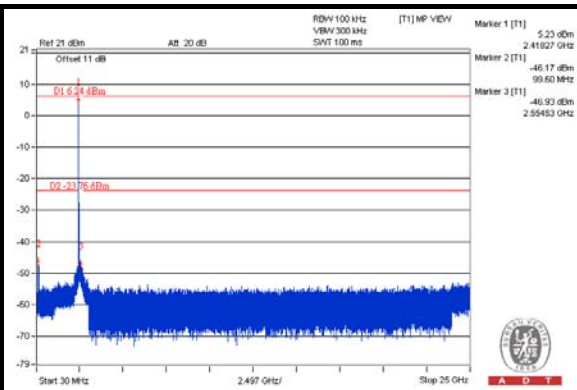
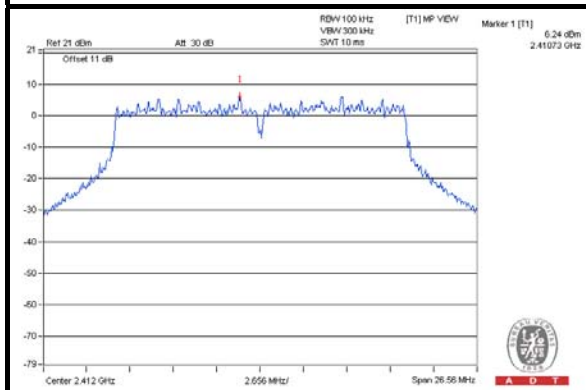

CH 6

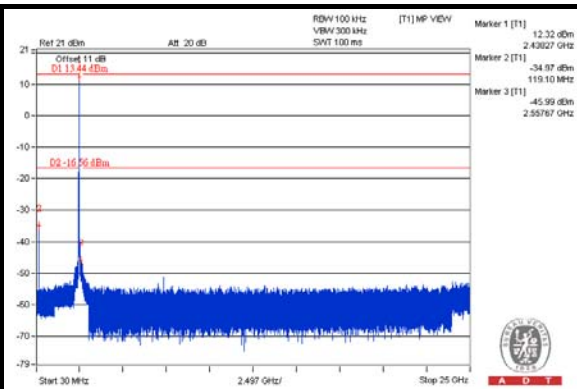
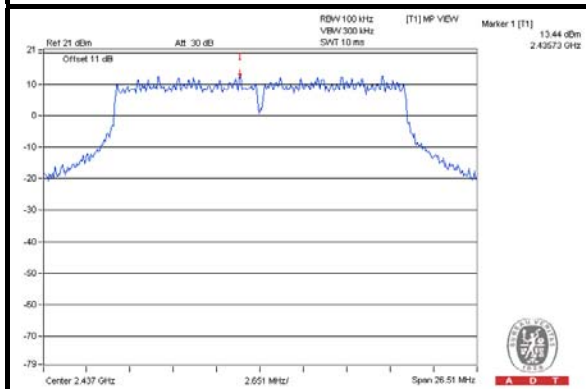

CH 11

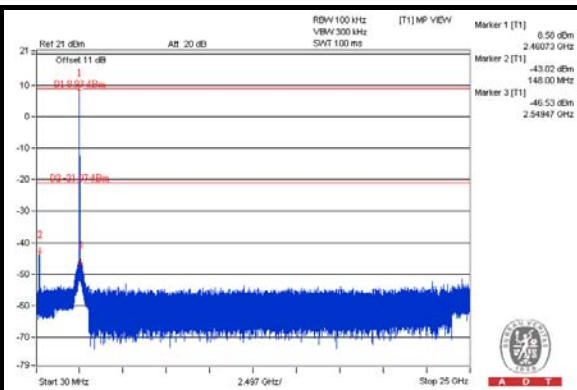
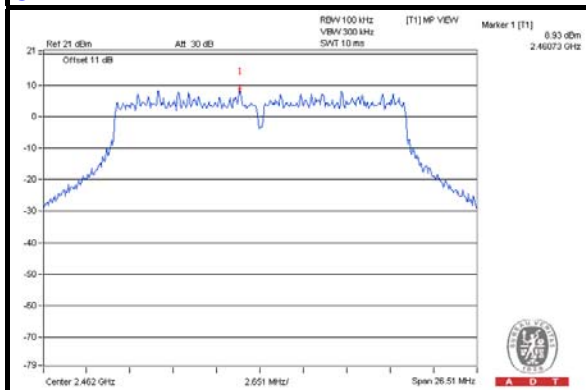

CH 1 Band edge

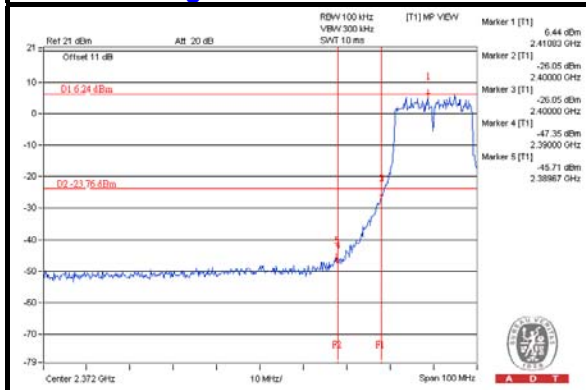

CH 11 Band edge

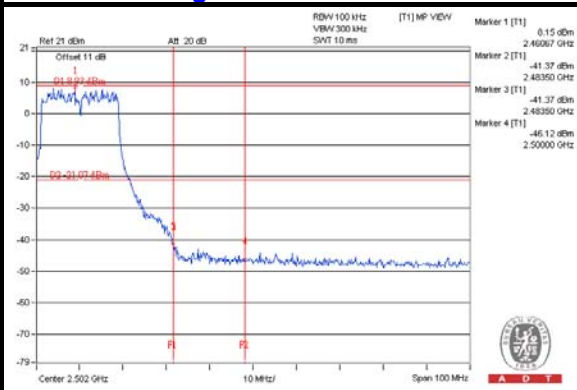



A D T

CHAIN 2

CH 1

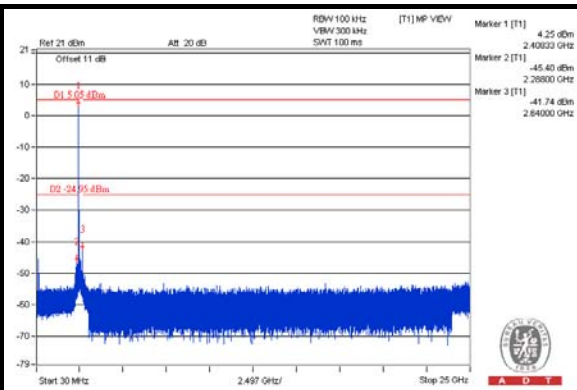
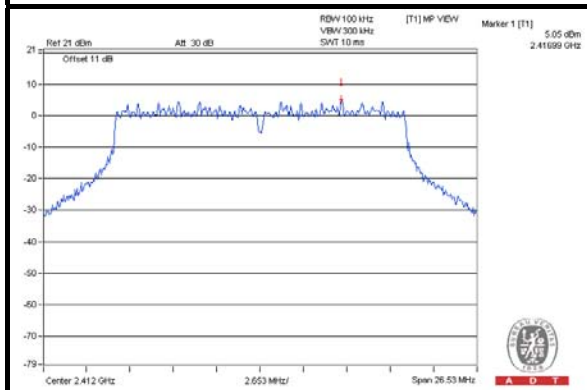

CH 6

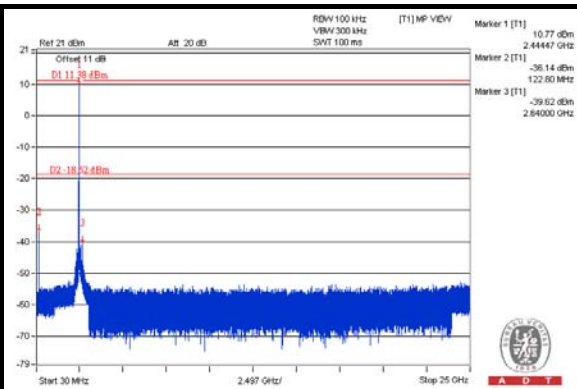
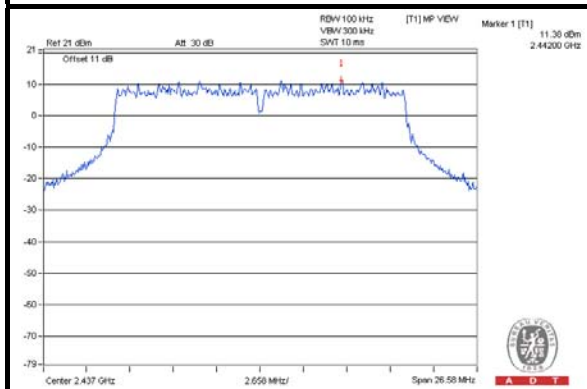

CH 11

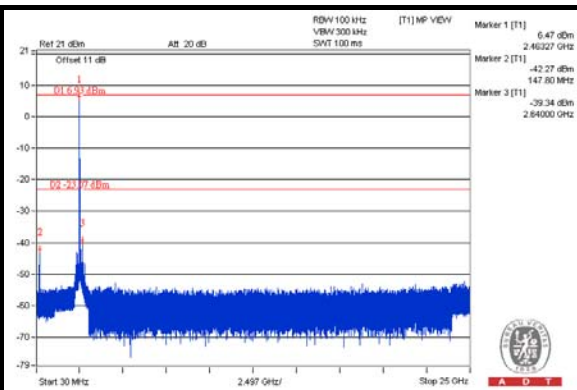
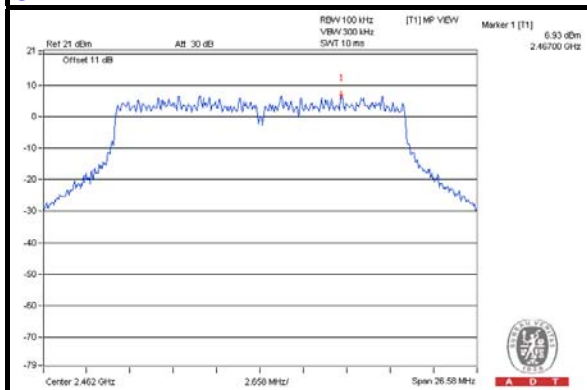

CH 1 Band edge

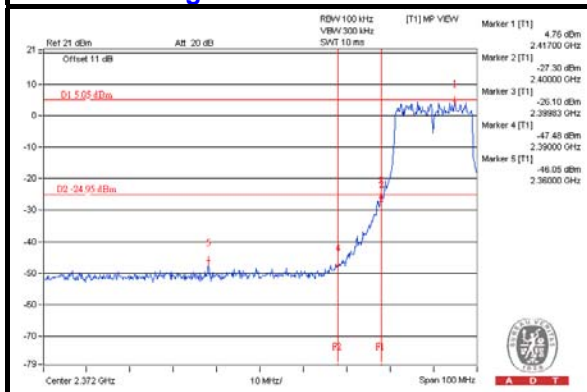

CH 11 Band edge

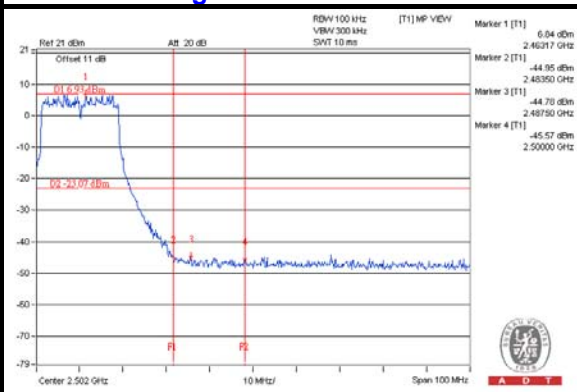



A D T

802.11n (40MHz) CHAIN 0

CH 3

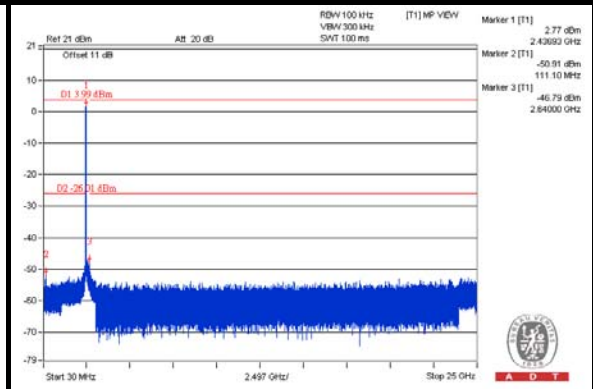
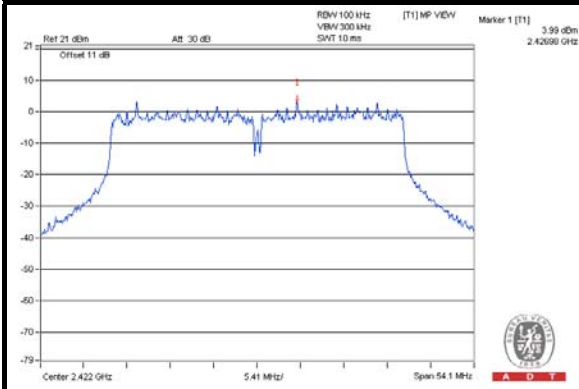

CH 6

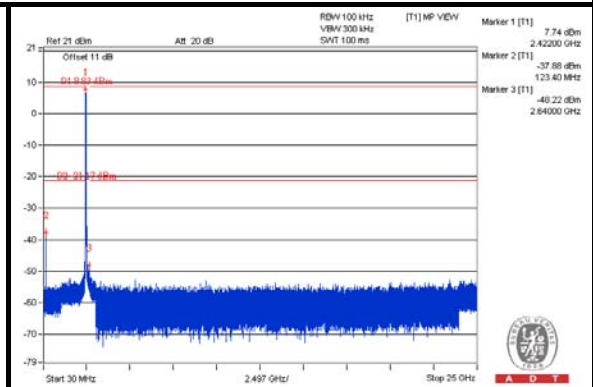
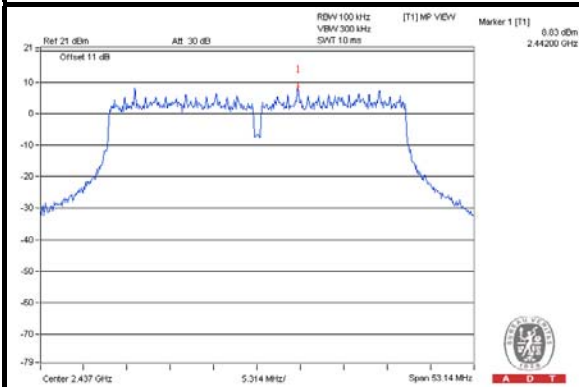

CH 9

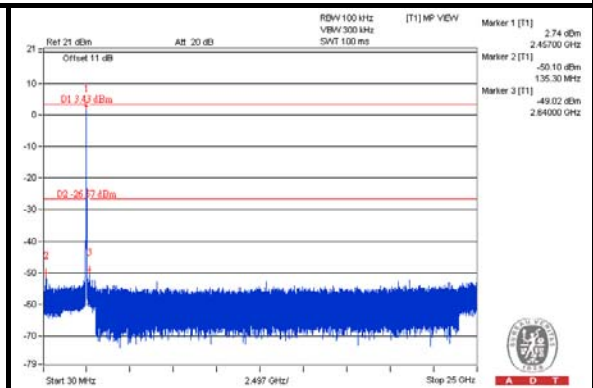
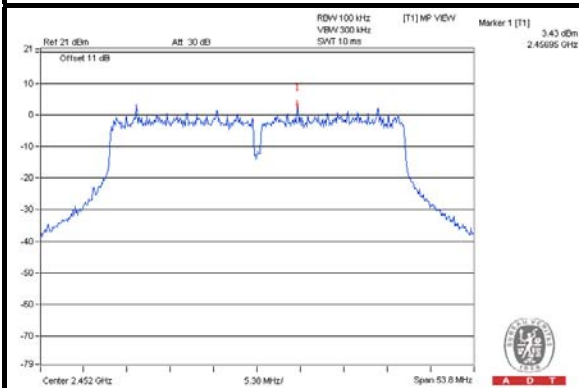

CH 3 Band edge

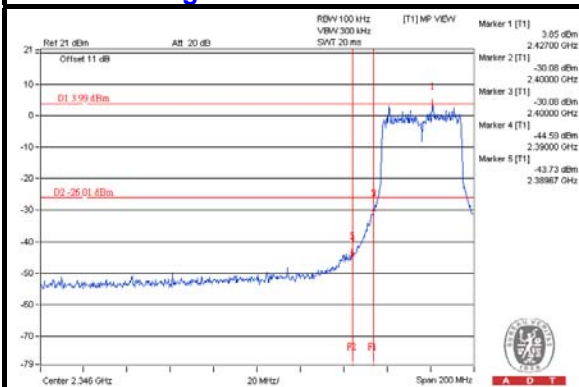

CH 9 Band edge

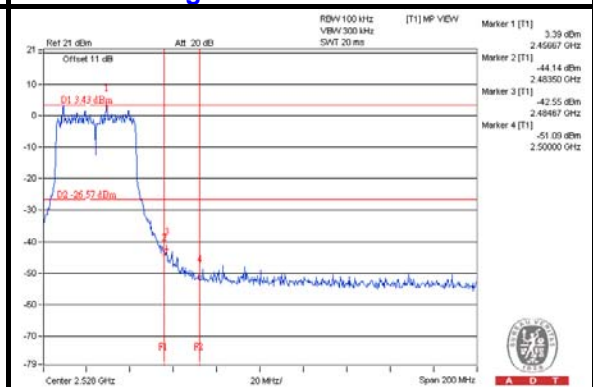



A D T

CHAIN 1

CH 3

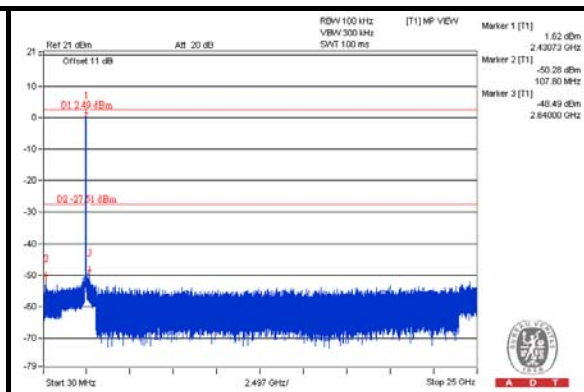
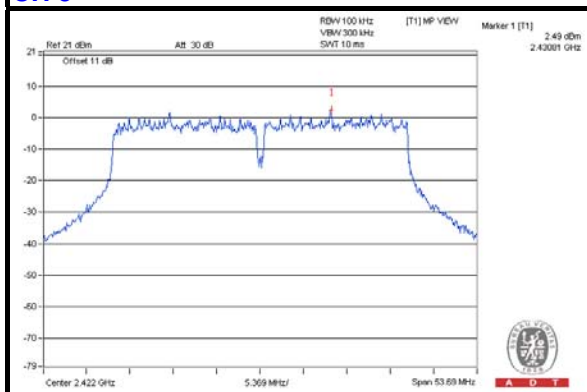

CH 6

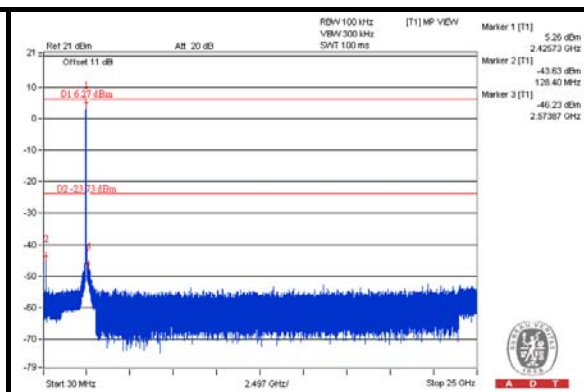
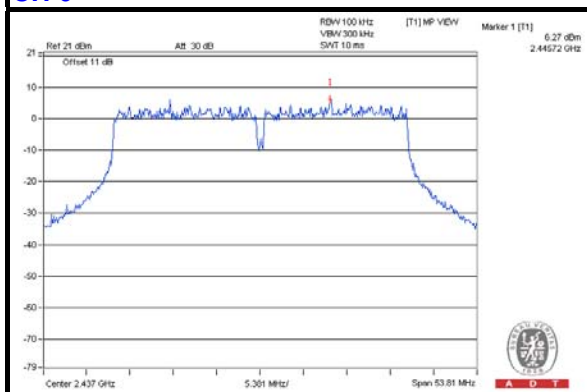

CH 9

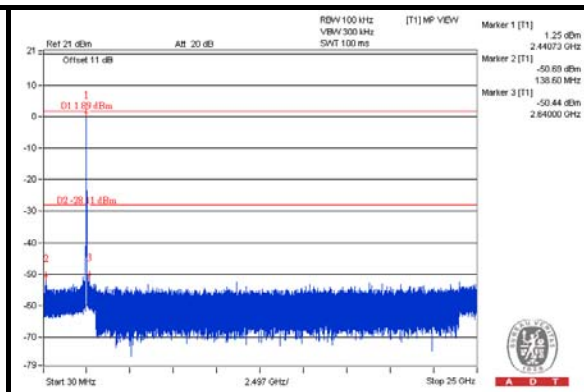
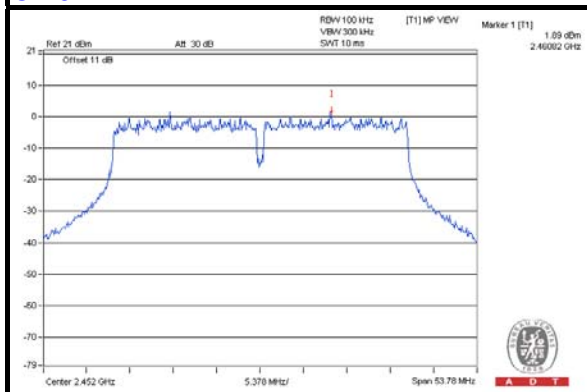

CH 3 Band edge

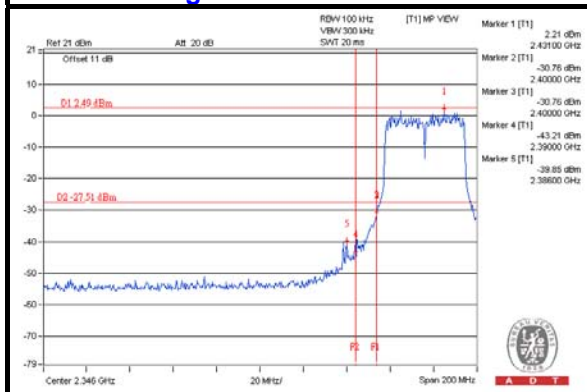

CH 9 Band edge

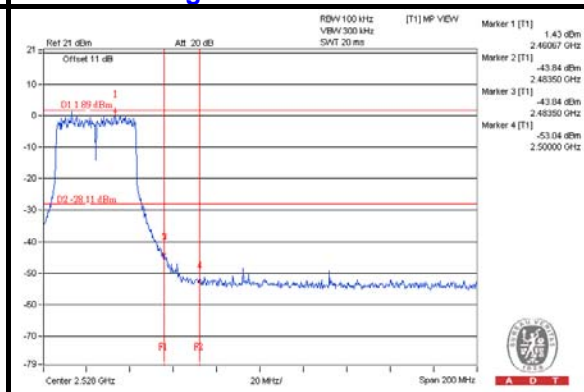



A D T

CHAIN 2

CH 3

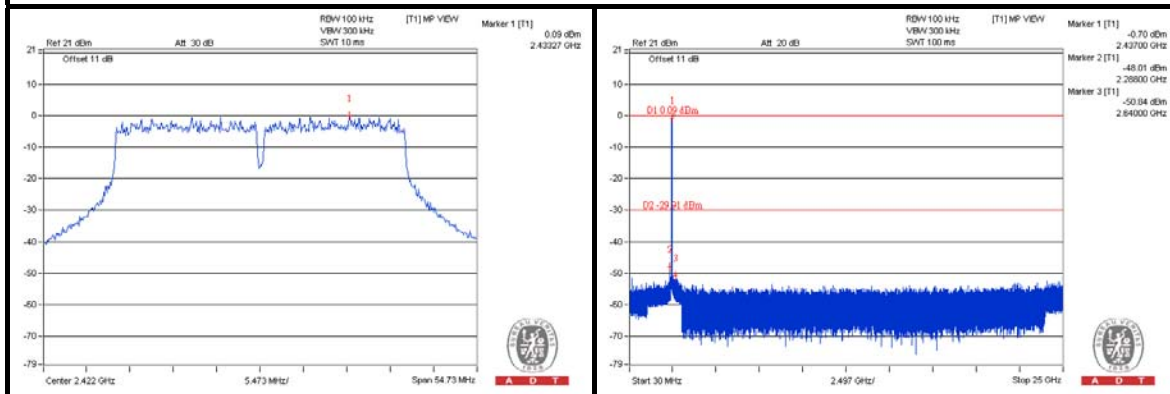

CH 6

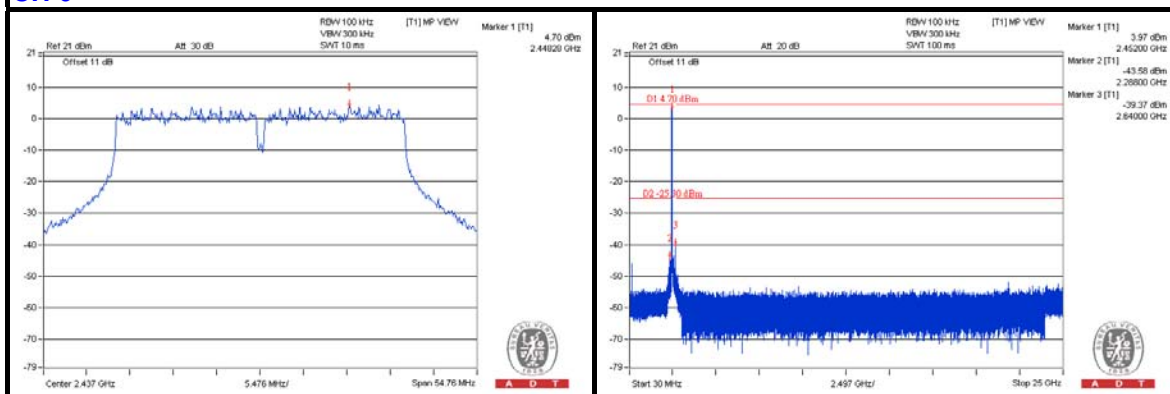

CH 9

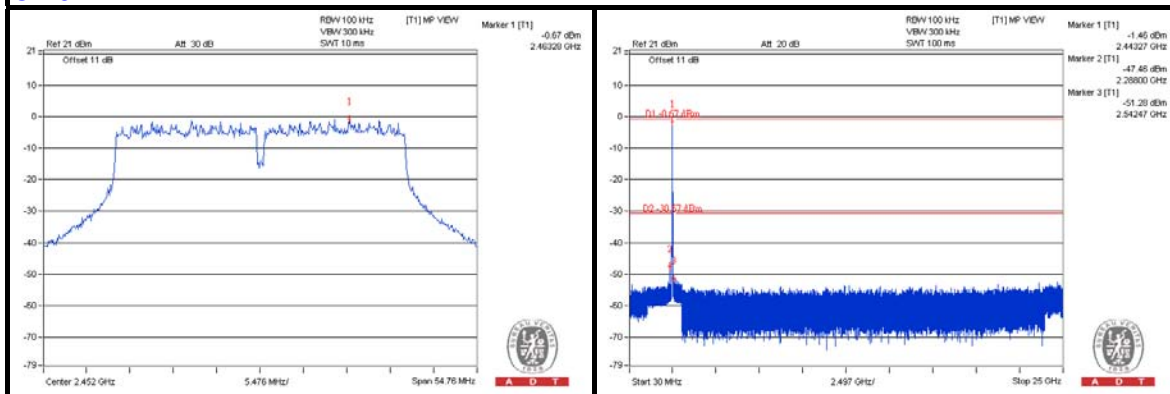

CH 3 Band edge

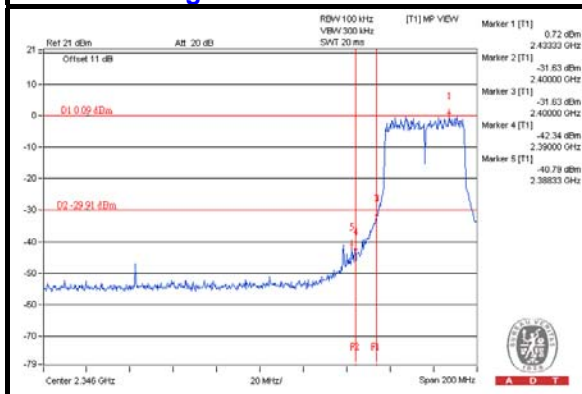

CH 9 Band edge

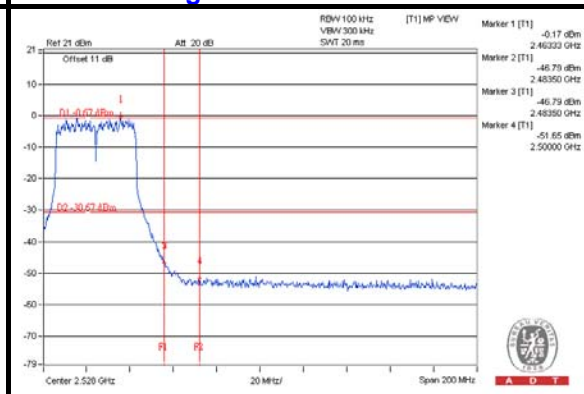



5. TEST TYPES AND RESULTS (FOR 5.0GHz BAND)

5.1 RADIATED EMISSION MEASUREMENT

5.1.1 LIMITS OF RADIATED EMISSION MEASUREMENT

Radiated emissions which fall in the restricted bands must comply with the radiated emission limits specified as below table. Other emissions shall be at least 30dB below the highest level of the desired power:

FREQUENCIES (MHz)	FIELD STRENGTH (microvolts/meter)	MEASUREMENT DISTANCE (meters)
0.009 ~ 0.490	2400/F(kHz)	300
0.490 ~ 1.705	24000/F(kHz)	30
1.705 ~ 30.0	30	30
30 ~ 88	100	3
88 ~ 216	150	3
216 ~ 960	200	3
Above 960	500	3

NOTE:

1. The lower limit shall apply at the transition frequencies.
2. Emission level (dBuV/m) = 20 log Emission level (uV/m).
3. For frequencies above 1000MHz, the field strength limits are based on average detector, however, the peak field strength of any emission shall not exceed the maximum permitted average limits, specified above by more than 30dB under any condition of modulation.



A D T

5.1.2 TEST INSTRUMENTS

Same as item 4.1.2.

5.1.3 TEST PROCEDURES

Same as item 4.1.3.

5.1.4 DEVIATION FROM TEST STANDARD

No deviation.

5.1.5 TEST SETUP

Same as item 4.1.5.

5.1.6 EUT OPERATING CONDITIONS

Same as item 4.1.6.



A D T

5.1.7 TEST RESULTS

ABOVE 1GHz DATA :

802.11a

EUT TEST CONDITION		MEASUREMENT DETAIL	
CHANNEL	Channel 149	FREQUENCY RANGE	1 ~ 40GHz
INPUT POWER	120Vac, 60Hz	DETECTOR FUNCTION	Peak (PK) Average (AV)
ENVIRONMENTAL CONDITIONS	25deg. C, 65%RH	TESTED BY	Ted Chang

ANTENNA POLARITY & TEST DISTANCE: HORIZONTAL AT 3 M								
NO.	FREQ. (MHz)	EMISSION LEVEL (dBuV/m)	LIMIT (dBuV/m)	MARGIN (dB)	ANTENNA HEIGHT (m)	TABLE ANGLE (Degree)	RAW VALUE (dBuV)	CORRECTION FACTOR (dB/m)
1	5400.00	58.8 PK	74.0	-15.2	1.52 H	55	53.40	5.40
2	5400.00	46.9 AV	54.0	-7.1	1.52 H	55	41.50	5.40
3	#5725.00	80.0 PK	84.5	-4.5	1.00 H	275	41.50	38.50
4	#5725.00	69.7 AV	74.2	-4.5	1.00 H	275	31.20	38.50
5	*5745.00	114.5 PK			1.73 H	211	76.00	38.50
6	*5745.00	104.2 AV			1.73 H	211	65.70	38.50
7	11490.00	64.4 PK	74.0	-9.6	1.40 H	139	45.40	19.00
8	11490.00	51.2 AV	54.0	-2.8	1.40 H	139	32.20	19.00
ANTENNA POLARITY & TEST DISTANCE: VERTICAL AT 3 M								
NO.	FREQ. (MHz)	EMISSION LEVEL (dBuV/m)	LIMIT (dBuV/m)	MARGIN (dB)	ANTENNA HEIGHT (m)	TABLE ANGLE (Degree)	RAW VALUE (dBuV)	CORRECTION FACTOR (dB/m)
1	5400.00	63.5 PK	74.0	-10.5	1.10 V	170	58.10	5.40
2	5400.00	53.0 AV	54.0	-1.0	1.10 V	170	47.60	5.40
3	#5725.00	86.5 PK	91.0	-4.5	1.00 V	275	48.00	38.50
4	#5725.00	76.4 AV	80.9	-4.5	1.00 V	275	37.90	38.50
5	*5745.00	121.0 PK			1.02 V	176	82.50	38.50
6	*5745.00	110.9 AV			1.02 V	176	72.40	38.50
7	11490.00	67.4 PK	74.0	-6.6	1.39 V	60	48.40	19.00
8	11490.00	52.7 AV	54.0	-1.3	1.39 V	60	33.70	19.00

REMARKS:

- Emission Level(dBuV/m) = Raw Value(dBuV) + Correction Factor(dB/m)
- Correction Factor(dB/m) = Antenna Factor(dB/m) + Cable Factor(dB) – Pre-Amplifier Factor(dB)
- The other emission levels were very low against the limit.
- Margin value = Emission Level – Limit value
- " * ": Fundamental frequency.
- The limit value is defined as per 15.247.
- "#":The radiated frequency is out the restricted band.



A D T

EUT TEST CONDITION		MEASUREMENT DETAIL	
CHANNEL	Channel 157	FREQUENCY RANGE	1 ~ 40GHz
INPUT POWER	120Vac, 60Hz	DETECTOR FUNCTION	Peak (PK) Average (AV)
ENVIRONMENTAL CONDITIONS	25deg. C, 65%RH	TESTED BY	Ted Chang

ANTENNA POLARITY & TEST DISTANCE: HORIZONTAL AT 3 M								
NO.	FREQ. (MHz)	EMISSION LEVEL (dBuV/m)	LIMIT (dBuV/m)	MARGIN (dB)	ANTENNA HEIGHT (m)	TABLE ANGLE (Degree)	RAW VALUE (dBuV)	CORRECTION FACTOR (dB/m)
1	5360.00	59.1 PK	74.0	-14.9	1.00 H	114	53.70	5.40
2	5360.00	47.0 AV	54.0	-7.0	1.00 H	114	41.60	5.40
3	*5785.00	111.5 PK			1.02 H	304	72.90	38.60
4	*5785.00	101.6 AV			1.02 H	304	63.00	38.60
5	11570.00	63.0 PK	74.0	-11.0	1.46 H	145	44.00	19.00
6	11570.00	49.5 AV	54.0	-4.5	1.46 H	145	30.50	19.00
ANTENNA POLARITY & TEST DISTANCE: VERTICAL AT 3 M								
NO.	FREQ. (MHz)	EMISSION LEVEL (dBuV/m)	LIMIT (dBuV/m)	MARGIN (dB)	ANTENNA HEIGHT (m)	TABLE ANGLE (Degree)	RAW VALUE (dBuV)	CORRECTION FACTOR (dB/m)
1	5360.00	61.4 PK	74.0	-12.6	1.11 V	167	56.00	5.40
2	5360.00	51.6 AV	54.0	-2.4	1.11 V	167	46.20	5.40
3	*5785.00	119.0 PK			1.12 V	161	80.40	38.60
4	*5785.00	108.4 AV			1.12 V	161	69.80	38.60
5	11570.00	68.3 PK	74.0	-5.7	1.45 V	35	49.30	19.00
6	11570.00	53.0 AV	54.0	-1.0	1.45 V	35	34.00	19.00

REMARKS:

1. Emission Level(dBuV/m) = Raw Value(dBuV) + Correction Factor(dB/m)
2. Correction Factor(dB/m) = Antenna Factor(dB/m) + Cable Factor(dB) – Pre-Amplifier Factor(dB)
3. The other emission levels were very low against the limit.
4. Margin value = Emission Level – Limit value
5. “ * “: Fundamental frequency.
6. The limit value is defined as per 15.247.



A D T

EUT TEST CONDITION		MEASUREMENT DETAIL	
CHANNEL	Channel 165	FREQUENCY RANGE	1 ~ 40GHz
INPUT POWER	120Vac, 60Hz	DETECTOR FUNCTION	Peak (PK) Average (AV)
ENVIRONMENTAL CONDITIONS	25deg. C, 65%RH	TESTED BY	Ted Chang

ANTENNA POLARITY & TEST DISTANCE: HORIZONTAL AT 3 M								
NO.	FREQ. (MHz)	EMISSION LEVEL (dBuV/m)	LIMIT (dBuV/m)	MARGIN (dB)	ANTENNA HEIGHT (m)	TABLE ANGLE (Degree)	RAW VALUE (dBuV)	CORRECTION FACTOR (dB/m)
1	5400.00	58.6 PK	74.0	-15.4	1.05 H	119	53.20	5.40
2	5400.00	47.5 AV	54.0	-6.5	1.05 H	119	42.10	5.40
3	*5825.00	112.5 PK			1.74 H	304	73.80	38.70
4	*5825.00	102.7 AV			1.74 H	304	64.00	38.70
5	#5850.00	69.3 PK	82.5	-13.2	1.00 H	177	30.60	38.70
6	#5850.00	59.5 AV	72.7	-13.2	1.00 H	177	20.80	38.70
7	11650.00	64.2 PK	74.0	-9.8	2.01 H	152	45.30	18.90
8	11650.00	51.1 AV	54.0	-2.9	2.01 H	152	32.20	18.90

ANTENNA POLARITY & TEST DISTANCE: VERTICAL AT 3 M								
NO.	FREQ. (MHz)	EMISSION LEVEL (dBuV/m)	LIMIT (dBuV/m)	MARGIN (dB)	ANTENNA HEIGHT (m)	TABLE ANGLE (Degree)	RAW VALUE (dBuV)	CORRECTION FACTOR (dB/m)
1	5400.00	62.0 PK	74.0	-12.0	1.00 V	159	56.60	5.40
2	5400.00	52.1 AV	54.0	-1.9	1.00 V	159	46.70	5.40
3	*5825.00	120.7 PK			1.57 V	168	82.00	38.70
4	*5825.00	110.8 AV			1.57 V	168	72.10	38.70
5	#5850.00	77.5 PK	90.7	-13.2	1.00 V	177	38.80	38.70
6	#5850.00	67.6 AV	80.8	-13.2	1.00 V	177	28.90	38.70
7	11650.00	65.9 PK	74.0	-8.1	1.00 V	8	47.00	18.90
8	11650.00	52.6 AV	54.0	-1.4	1.00 V	8	33.70	18.90

REMARKS:

- Emission Level(dBuV/m) = Raw Value(dBuV) + Correction Factor(dB/m)
- Correction Factor(dB/m) = Antenna Factor(dB/m) + Cable Factor(dB) – Pre-Amplifier Factor(dB)
- The other emission levels were very low against the limit.
- Margin value = Emission Level – Limit value
- " * ": Fundamental frequency.
- The limit value is defined as per 15.247.
- "#":The radiated frequency is out the restricted band.



A D T

802.11n (20MHz)

EUT TEST CONDITION		MEASUREMENT DETAIL	
CHANNEL	Channel 149	FREQUENCY RANGE	1 ~ 40GHz
INPUT POWER	120Vac, 60Hz	DETECTOR FUNCTION	Peak (PK) Average (AV)
ENVIRONMENTAL CONDITIONS	25deg. C, 65%RH	TESTED BY	Ted Chang

ANTENNA POLARITY & TEST DISTANCE: HORIZONTAL AT 3 M								
NO.	FREQ. (MHz)	EMISSION LEVEL (dBuV/m)	LIMIT (dBuV/m)	MARGIN (dB)	ANTENNA HEIGHT (m)	TABLE ANGLE (Degree)	RAW VALUE (dBuV)	CORRECTION FACTOR (dB/m)
1	5400.00	60.8 PK	74.0	-13.2	1.52 H	188	55.40	5.40
2	5400.00	47.8 AV	54.0	-6.2	1.52 H	188	42.40	5.40
3	#5725.00	74.0 PK	79.7	-5.7	1.00 H	275	68.00	6.00
4	#5725.00	64.3 AV	70.0	-5.7	1.00 H	275	58.30	6.00
5	*5745.00	109.7 PK			1.07 H	211	71.20	38.50
6	*5745.00	100.0 AV			1.07 H	211	61.50	38.50
7	11490.00	63.6 PK	74.0	-10.4	1.05 H	114	44.60	19.00
8	11490.00	51.5 AV	54.0	-2.5	1.05 H	114	32.50	19.00

ANTENNA POLARITY & TEST DISTANCE: VERTICAL AT 3 M								
NO.	FREQ. (MHz)	EMISSION LEVEL (dBuV/m)	LIMIT (dBuV/m)	MARGIN (dB)	ANTENNA HEIGHT (m)	TABLE ANGLE (Degree)	RAW VALUE (dBuV)	CORRECTION FACTOR (dB/m)
1	5400.00	62.7 PK	74.0	-11.3	1.10 V	169	57.30	5.40
2	5400.00	51.5 AV	54.0	-2.5	1.10 V	169	46.10	5.40
3	#5725.00	82.7 PK	88.4	-5.7	1.00 V	275	44.20	38.50
4	#5725.00	72.9 AV	78.6	-5.7	1.00 V	275	34.40	38.50
5	*5745.00	118.4 PK			1.13 V	175	79.90	38.50
6	*5745.00	108.6 AV			1.13 V	175	70.10	38.50
7	11490.00	67.9 PK	74.0	-6.1	1.45 V	33	48.90	19.00
8	11490.00	53.0 AV	54.0	-1.0	1.45 V	33	34.00	19.00

REMARKS:

- Emission Level(dBuV/m) = Raw Value(dBuV) + Correction Factor(dB/m)
- Correction Factor(dB/m) = Antenna Factor(dB/m) + Cable Factor(dB) – Pre-Amplifier Factor(dB)
- The other emission levels were very low against the limit.
- Margin value = Emission Level – Limit value
- " * ": Fundamental frequency.
- The limit value is defined as per 15.247.
- "#":The radiated frequency is out the restricted band.



A D T

EUT TEST CONDITION		MEASUREMENT DETAIL	
CHANNEL	Channel 157	FREQUENCY RANGE	1 ~ 40GHz
INPUT POWER	120Vac, 60Hz	DETECTOR FUNCTION	Peak (PK) Average (AV)
ENVIRONMENTAL CONDITIONS	25deg. C, 65%RH	TESTED BY	Ted Chang

ANTENNA POLARITY & TEST DISTANCE: HORIZONTAL AT 3 M								
NO.	FREQ. (MHz)	EMISSION LEVEL (dBuV/m)	LIMIT (dBuV/m)	MARGIN (dB)	ANTENNA HEIGHT (m)	TABLE ANGLE (Degree)	RAW VALUE (dBuV)	CORRECTION FACTOR (dB/m)
1	5360.00	59.1 PK	74.0	-14.9	1.88 H	159	53.70	5.40
2	5360.00	47.9 AV	54.0	-6.1	1.88 H	159	42.50	5.40
3	5440.00	59.1 PK	74.0	-14.9	1.20 H	52	53.50	5.60
4	5440.00	48.1 AV	54.0	-5.9	1.20 H	52	42.50	5.60
5	*5785.00	114.0 PK			1.61 H	304	75.40	38.60
6	*5785.00	103.6 AV			1.61 H	304	65.00	38.60
7	11570.00	62.7 PK	74.0	-11.3	1.02 H	118	43.70	19.00
8	11570.00	51.5 AV	54.0	-2.5	1.02 H	118	32.50	19.00

ANTENNA POLARITY & TEST DISTANCE: VERTICAL AT 3 M								
NO.	FREQ. (MHz)	EMISSION LEVEL (dBuV/m)	LIMIT (dBuV/m)	MARGIN (dB)	ANTENNA HEIGHT (m)	TABLE ANGLE (Degree)	RAW VALUE (dBuV)	CORRECTION FACTOR (dB/m)
1	5360.00	63.0 PK	74.0	-11.0	1.10 V	166	57.60	5.40
2	5360.00	52.7 AV	54.0	-1.3	1.10 V	166	47.30	5.40
3	5440.00	62.7 PK	74.0	-11.3	1.09 V	163	57.10	5.60
4	5440.00	51.7 AV	54.0	-2.3	1.09 V	163	46.10	5.60
5	*5785.00	121.0 PK			1.12 V	161	82.40	38.60
6	*5785.00	111.0 AV			1.12 V	161	72.40	38.60
7	11570.00	67.0 PK	74.0	-7.0	1.06 V	203	48.00	19.00
8	11570.00	53.0 AV	54.0	-1.0	1.06 V	203	34.00	19.00

REMARKS:

- Emission Level(dBuV/m) = Raw Value(dBuV) + Correction Factor(dB/m)
- Correction Factor(dB/m) = Antenna Factor(dB/m) + Cable Factor(dB)
– Pre-Amplifier Factor(dB)
- The other emission levels were very low against the limit.
- Margin value = Emission Level – Limit value
- * * *: Fundamental frequency.
- The limit value is defined as per 15.247.



A D T

EUT TEST CONDITION		MEASUREMENT DETAIL	
CHANNEL	Channel 165	FREQUENCY RANGE	1 ~ 40GHz
INPUT POWER	120Vac, 60Hz	DETECTOR FUNCTION	Peak (PK) Average (AV)
ENVIRONMENTAL CONDITIONS	25deg. C, 65%RH	TESTED BY	Ted Chang

ANTENNA POLARITY & TEST DISTANCE: HORIZONTAL AT 3 M								
NO.	FREQ. (MHz)	EMISSION LEVEL (dBuV/m)	LIMIT (dBuV/m)	MARGIN (dB)	ANTENNA HEIGHT (m)	TABLE ANGLE (Degree)	RAW VALUE (dBuV)	CORRECTION FACTOR (dB/m)
1	5360.00	59.1 PK	74.0	-14.9	1.52 H	228	53.70	5.40
2	5360.00	48.9 AV	54.0	-5.1	1.52 H	228	43.50	5.40
3	5440.00	59.2 PK	74.0	-14.8	1.00 H	152	53.60	5.60
4	5440.00	48.2 AV	54.0	-5.8	1.00 H	152	42.60	5.60
5	*5825.00	112.6 PK			1.60 H	303	73.90	38.70
6	*5825.00	102.8 AV			1.60 H	303	64.10	38.70
7	#5850.00	74.9 PK	82.6	-7.7	1.00 H	322	36.20	38.70
8	#5850.00	65.1 AV	72.8	-7.7	1.00 H	322	26.40	38.70
9	11650.00	62.6 PK	74.0	-11.4	1.02 H	52	43.70	18.90
10	11650.00	50.9 AV	54.0	-3.1	1.02 H	52	32.00	18.90

ANTENNA POLARITY & TEST DISTANCE: VERTICAL AT 3 M								
NO.	FREQ. (MHz)	EMISSION LEVEL (dBuV/m)	LIMIT (dBuV/m)	MARGIN (dB)	ANTENNA HEIGHT (m)	TABLE ANGLE (Degree)	RAW VALUE (dBuV)	CORRECTION FACTOR (dB/m)
1	5360.00	63.2 PK	74.0	-10.8	1.23 V	167	57.80	5.40
2	5360.00	52.8 AV	54.0	-1.2	1.23 V	167	47.40	5.40
3	5440.00	63.8 PK	74.0	-10.2	1.20 V	169	58.20	5.60
4	5440.00	52.0 AV	54.0	-2.0	1.20 V	169	46.40	5.60
5	*5825.00	119.7 PK			1.00 V	168	81.00	38.70
6	*5825.00	109.7 AV			1.00 V	168	71.00	38.70
7	#5850.00	82.0 PK	89.7	-7.7	1.00 V	322	43.30	38.70
8	#5850.00	72.0 AV	79.7	-7.7	1.00 V	322	33.30	38.70
9	11650.00	65.4 PK	74.0	-8.6	1.00 V	8	46.50	18.90
10	11650.00	51.9 AV	54.0	-2.1	1.00 V	8	33.00	18.90

REMARKS:

1. Emission Level(dBuV/m) = Raw Value(dBuV) + Correction Factor(dB/m)
2. Correction Factor(dB/m) = Antenna Factor(dB/m) + Cable Factor(dB)
– Pre-Amplifier Factor(dB)
3. The other emission levels were very low against the limit.
4. Margin value = Emission Level – Limit value
5. “ * “: Fundamental frequency.
6. The limit value is defined as per 15.247.
7. “#”:The radiated frequency is out the restricted band.



A D T

802.11n (40MHz)

EUT TEST CONDITION		MEASUREMENT DETAIL	
CHANNEL	Channel 151	FREQUENCY RANGE	1 ~ 40GHz
INPUT POWER	120Vac, 60Hz	DETECTOR FUNCTION	Peak (PK) Average (AV)
ENVIRONMENTAL CONDITIONS	25deg. C, 65%RH	TESTED BY	Ted Chang

ANTENNA POLARITY & TEST DISTANCE: HORIZONTAL AT 3 M								
NO.	FREQ. (MHz)	EMISSION LEVEL (dBuV/m)	LIMIT (dBuV/m)	MARGIN (dB)	ANTENNA HEIGHT (m)	TABLE ANGLE (Degree)	RAW VALUE (dBuV)	CORRECTION FACTOR (dB/m)
1	#5725.00	74.0 PK	75.2	-1.2	1.00 H	114	35.50	38.50
2	#5725.00	64.6 AV	65.8	-1.2	1.00 H	114	26.10	38.50
3	*5755.00	105.2 PK			1.16 H	27	66.60	38.60
4	*5755.00	95.8 AV			1.16 H	27	57.20	38.60
5	11510.00	62.3 PK	74.0	-11.7	1.05 H	118	43.30	19.00
6	11510.00	49.5 AV	54.0	-4.5	1.05 H	118	30.50	19.00
ANTENNA POLARITY & TEST DISTANCE: VERTICAL AT 3 M								
NO.	FREQ. (MHz)	EMISSION LEVEL (dBuV/m)	LIMIT (dBuV/m)	MARGIN (dB)	ANTENNA HEIGHT (m)	TABLE ANGLE (Degree)	RAW VALUE (dBuV)	CORRECTION FACTOR (dB/m)
1	#5725.00	84.2 PK	85.4	-1.2	1.00 V	114	45.70	38.50
2	#5725.00	73.9 AV	75.1	-1.2	1.00 V	114	35.40	38.50
3	*5755.00	115.4 PK			1.01 V	179	76.80	38.60
4	*5755.00	105.1 AV			1.01 V	179	66.50	38.60
5	11510.00	63.8 PK	74.0	-10.2	1.52 V	33	44.80	19.00
6	11510.00	50.6 AV	54.0	-3.4	1.52 V	33	31.60	19.00

REMARKS:

1. Emission Level(dBuV/m) = Raw Value(dBuV) + Correction Factor(dB/m)
2. Correction Factor(dB/m) = Antenna Factor(dB/m) + Cable Factor(dB) – Pre-Amplifier Factor(dB)
3. The other emission levels were very low against the limit.
4. Margin value = Emission Level – Limit value
5. “ * “: Fundamental frequency.
6. The limit value is defined as per 15.247.
7. “#”:The radiated frequency is out the restricted band.



A D T

EUT TEST CONDITION		MEASUREMENT DETAIL	
CHANNEL	Channel 159	FREQUENCY RANGE	1 ~ 40GHz
INPUT POWER	120Vac, 60Hz	DETECTOR FUNCTION	Peak (PK) Average (AV)
ENVIRONMENTAL CONDITIONS	25deg. C, 65%RH	TESTED BY	Ted Chang

ANTENNA POLARITY & TEST DISTANCE: HORIZONTAL AT 3 M								
NO.	FREQ. (MHz)	EMISSION LEVEL (dBuV/m)	LIMIT (dBuV/m)	MARGIN (dB)	ANTENNA HEIGHT (m)	TABLE ANGLE (Degree)	RAW VALUE (dBuV)	CORRECTION FACTOR (dB/m)
1	*5795.00	109.8 PK			1.35 H	298	71.20	38.60
2	*5795.00	99.1 AV			1.35 H	298	60.50	38.60
3	#5850.00	69.6 PK	79.8	-10.2	1.00 H	158	30.90	38.70
4	#5850.00	58.9 AV	69.1	-10.2	1.00 H	158	20.20	38.70
5	11590.00	62.5 PK	74.0	-11.5	1.02 H	302	43.50	19.00
6	11590.00	50.1 AV	54.0	-3.9	1.02 H	302	31.10	19.00
ANTENNA POLARITY & TEST DISTANCE: VERTICAL AT 3 M								
NO.	FREQ. (MHz)	EMISSION LEVEL (dBuV/m)	LIMIT (dBuV/m)	MARGIN (dB)	ANTENNA HEIGHT (m)	TABLE ANGLE (Degree)	RAW VALUE (dBuV)	CORRECTION FACTOR (dB/m)
1	*5795.00	118.3 PK			1.00 V	179	79.70	38.60
2	*5795.00	107.5 AV			1.00 V	179	68.90	38.60
3	#5850.00	78.1 PK	88.3	-10.2	1.00 V	158	39.40	38.70
4	#5850.00	67.3 AV	77.5	-10.2	1.00 V	158	28.60	38.70
5	11590.00	66.0 PK	74.0	-8.0	1.51 V	32	47.00	19.00
6	11590.00	53.0 AV	54.0	-1.0	1.51 V	32	34.00	19.00

REMARKS:

1. Emission Level(dBuV/m) = Raw Value(dBuV) + Correction Factor(dB/m)
2. Correction Factor(dB/m) = Antenna Factor(dB/m) + Cable Factor(dB)
– Pre-Amplifier Factor(dB)
3. The other emission levels were very low against the limit.
4. Margin value = Emission Level – Limit value
5. “ * “: Fundamental frequency.
6. The limit value is defined as per 15.247.
7. "#":The radiated frequency is out the restricted band.



A D T

BELOW 1GHz WORST-CASE DATA : 802.11a

EUT TEST CONDITION		MEASUREMENT DETAIL	
CHANNEL	Channel 149	FREQUENCY RANGE	Below 1000MHz
INPUT POWER	120Vac, 60Hz	DETECTOR FUNCTION	Quasi-Peak
ENVIRONMENTAL CONDITIONS	25deg. C, 65%RH	TESTED BY	Ted Chang
TEST MODE	A		

ANTENNA POLARITY & TEST DISTANCE: HORIZONTAL AT 3 M

NO.	FREQ. (MHz)	EMISSION LEVEL (dBuV/m)	LIMIT (dBuV/m)	MARGIN (dB)	ANTENNA HEIGHT (m)	TABLE ANGLE (Degree)	RAW VALUE (dBuV)	CORRECTION FACTOR (dB/m)
1	76.47	28.4 QP	40.0	-11.6	1.00 H	36	46.30	-17.90
2	140.50	31.6 QP	43.5	-11.9	1.99 H	132	46.30	-14.70
3	189.01	37.2 QP	43.5	-6.3	1.24 H	270	53.40	-16.20
4	322.90	40.0 QP	46.0	-6.0	1.00 H	133	51.70	-11.70
5	392.75	43.6 QP	46.0	-2.4	1.24 H	128	54.30	-10.70
6	716.80	42.9 QP	46.0	-3.1	1.00 H	309	47.00	-4.10

ANTENNA POLARITY & TEST DISTANCE: VERTICAL AT 3 M

NO.	FREQ. (MHz)	EMISSION LEVEL (dBuV/m)	LIMIT (dBuV/m)	MARGIN (dB)	ANTENNA HEIGHT (m)	TABLE ANGLE (Degree)	RAW VALUE (dBuV)	CORRECTION FACTOR (dB/m)
1	76.47	35.8 QP	40.0	-4.2	1.99 V	127	53.70	-17.90
2	187.07	37.5 QP	43.5	-6.0	1.24 V	64	53.50	-16.00
3	295.73	32.8 QP	46.0	-13.2	1.99 V	16	45.30	-12.50
4	400.52	37.2 QP	46.0	-8.8	1.00 V	70	47.70	-10.50
5	515.00	32.3 QP	46.0	-13.7	1.50 V	106	40.40	-8.10
6	728.44	40.7 QP	46.0	-5.3	1.00 V	14	44.50	-3.80

REMARKS:

1. Emission Level(dBuV/m) = Raw Value(dBuV) + Correction Factor(dB/m)
2. Correction Factor(dB/m) = Antenna Factor(dB/m) + Cable Factor(dB) – Pre-Amplifier Factor (dB)
3. The other emission levels were very low against the limit.
4. Margin value = Emission Level – Limit value



A D T

EUT TEST CONDITION		MEASUREMENT DETAIL	
CHANNEL	Channel 149	FREQUENCY RANGE	Below 1000MHz
INPUT POWER	48Vdc	DETECTOR FUNCTION	Quasi-Peak
ENVIRONMENTAL CONDITIONS	25deg. C, 65%RH	TESTED BY	Ted Chang
TEST MODE	B		

ANTENNA POLARITY & TEST DISTANCE: HORIZONTAL AT 3 M								
NO.	FREQ. (MHz)	EMISSION LEVEL (dBuV/m)	LIMIT (dBuV/m)	MARGIN (dB)	ANTENNA HEIGHT (m)	TABLE ANGLE (Degree)	RAW VALUE (dBuV)	CORRECTION FACTOR (dB/m)
1	78.41	29.2 QP	40.0	-10.8	1.99 H	37	47.30	-18.10
2	159.91	28.0 QP	43.5	-15.5	1.00 H	259	41.70	-13.70
3	274.39	30.5 QP	46.0	-15.5	1.99 H	238	43.50	-13.00
4	375.29	26.0 QP	46.0	-20.0	1.00 H	105	36.90	-10.90
5	625.60	33.4 QP	46.0	-12.6	1.24 H	126	38.90	-5.50
6	751.73	35.3 QP	46.0	-10.7	1.00 H	13	38.30	-3.00

ANTENNA POLARITY & TEST DISTANCE: VERTICAL AT 3 M								
NO.	FREQ. (MHz)	EMISSION LEVEL (dBuV/m)	LIMIT (dBuV/m)	MARGIN (dB)	ANTENNA HEIGHT (m)	TABLE ANGLE (Degree)	RAW VALUE (dBuV)	CORRECTION FACTOR (dB/m)
1	78.41	36.8 QP	40.0	-3.2	1.50 V	106	54.90	-18.10
2	167.67	34.2 QP	43.5	-9.3	1.00 V	103	48.50	-14.30
3	272.45	30.0 QP	46.0	-16.0	1.24 V	245	43.00	-13.00
4	375.29	27.6 QP	46.0	-18.4	1.24 V	187	38.50	-10.90
5	625.60	29.7 QP	46.0	-16.3	1.99 V	73	35.20	-5.50
6	749.79	29.1 QP	46.0	-16.9	1.00 V	67	32.30	-3.20

REMARKS:

1. Emission Level(dBuV/m) = Raw Value(dBuV) + Correction Factor(dB/m)
2. Correction Factor(dB/m) = Antenna Factor(dB/m) + Cable Factor(dB)
 - Pre-Amplifier Factor (dB)
3. The other emission levels were very low against the limit.
4. Margin value = Emission Level – Limit value



A D T

5.2 CONDUCTED EMISSION MEASUREMENT

5.2.1 LIMITS OF CONDUCTED EMISSION MEASUREMENT

FREQUENCY OF EMISSION (MHz)	CONDUCTED LIMIT (dB μ V)	
	Quasi-peak	Average
0.15 ~ 0.5	66 to 56	56 to 46
0.5 ~ 5	56	46
5 ~ 30	60	50

- NOTE:**
1. The lower limit shall apply at the transition frequencies.
 2. The limit decreases in line with the logarithm of the frequency in the range of 0.15 to 0.50MHz.
 3. All emanations from a class A/B digital device or system, including any network of conductors and apparatus connected thereto, shall not exceed the level of field strengths specified above.

5.2.2 TEST INSTRUMENTS

Same as item 4.2.2.

5.2.3 TEST PROCEDURES

Same as item 4.2.3.

5.2.4 DEVIATION FROM TEST STANDARD

No deviation.

5.2.5 TEST SETUP

Same as item 4.2.5.

5.2.6 EUT OPERATING CONDITIONS

Same as item 4.1.6.

5.2.7 TEST RESULTS

CONDUCTED WORST-CASE DATA : 802.11a

PHASE	Line 1	6dB BANDWIDTH	9kHz
TEST MODE	A		

No	Freq. [MHz]	Corr. Factor (dB)	Reading Value		Emission Level		Limit		Margin	
			[dB (uV)]		[dB (uV)]		[dB (uV)]		(dB)	
			Q.P.	AV.	Q.P.	AV.	Q.P.	AV.	Q.P.	AV.
1	0.16967	0.10	47.83	31.00	47.93	31.10	64.98	54.98	-17.05	-23.88
2	0.23602	0.10	44.15	30.93	44.25	31.03	62.24	52.24	-17.98	-21.20
3	0.50641	0.12	39.96	31.37	40.08	31.49	56.00	46.00	-15.92	-14.51
4	2.19884	0.18	25.39	16.76	25.57	16.94	56.00	46.00	-30.43	-29.06
5	3.79803	0.22	25.64	17.89	25.86	18.11	56.00	46.00	-30.14	-27.89
6	10.79302	0.52	26.24	19.57	26.76	20.09	60.00	50.00	-33.24	-29.91

REMARKS:

1. Q.P. and AV. are abbreviations of quasi-peak and average individually.
2. The emission levels of other frequencies were very low against the limit.
3. Margin value = Emission level - Limit value
4. Correction factor = Insertion loss + Cable loss
5. Emission Level = Correction Factor + Reading Value

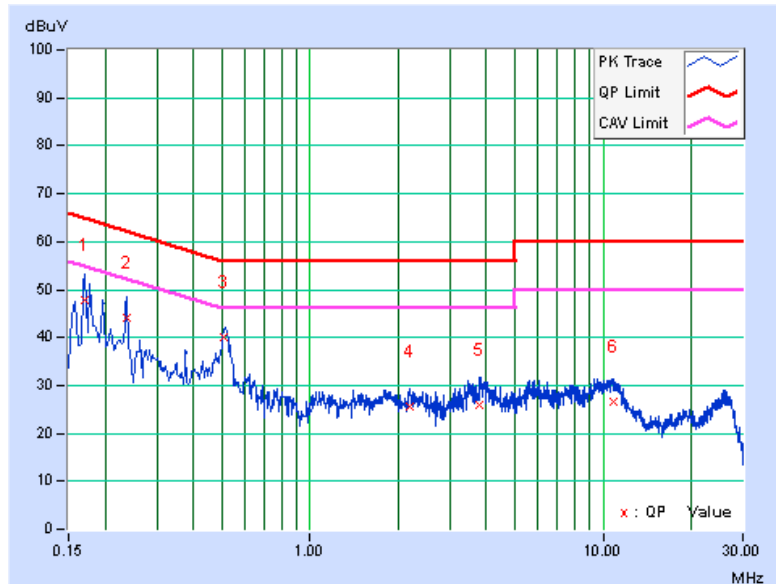



A D T

PHASE	Line 2	6dB BANDWIDTH	9kHz
TEST MODE	A		

No	Freq. [MHz]	Corr. Factor (dB)	Reading Value		Emission Level		Limit		Margin	
			[dB (uV)]		[dB (uV)]		[dB (uV)]		(dB)	
			Q.P.	AV.	Q.P.	AV.	Q.P.	AV.	Q.P.	AV.
1	0.17374	0.11	47.22	29.49	47.33	29.60	64.78	54.78	-17.45	-25.18
2	0.22024	0.11	41.82	26.78	41.93	26.89	62.81	52.81	-20.88	-25.92
3	0.51312	0.13	39.82	31.26	39.95	31.39	56.00	46.00	-16.05	-14.61
4	1.07591	0.14	30.84	21.18	30.98	21.32	56.00	46.00	-25.02	-24.68
5	3.45786	0.20	26.08	19.06	26.28	19.26	56.00	46.00	-29.72	-26.74
6	10.96115	0.39	29.05	21.98	29.44	22.37	60.00	50.00	-30.56	-27.63

REMARKS:

1. Q.P. and AV. are abbreviations of quasi-peak and average individually.
2. The emission levels of other frequencies were very low against the limit.
3. Margin value = Emission level - Limit value
4. Correction factor = Insertion loss + Cable loss
5. Emission Level = Correction Factor + Reading Value

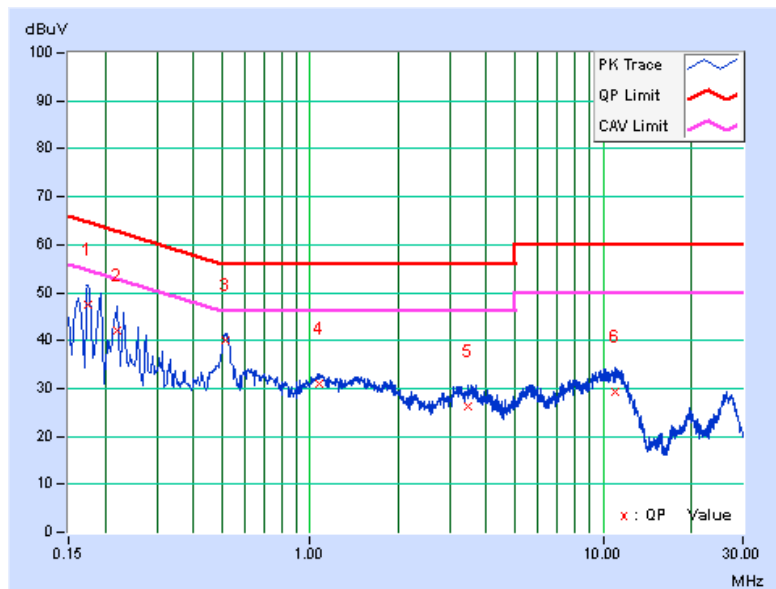

PHASE	Line 1	6dB BANDWIDTH	9kHz
TEST MODE	B		

No	Freq. [MHz]	Corr. Factor (dB)	Reading Value		Emission Level		Limit		Margin	
			[dB (uV)]		[dB (uV)]		[dB (uV)]		(dB)	
			Q.P.	AV.	Q.P.	AV.	Q.P.	AV.	Q.P.	AV.
1	0.23216	0.10	44.98	40.75	45.08	40.85	62.37	52.37	-17.29	-11.52
2	0.35296	0.12	42.83	40.23	42.95	40.35	58.89	48.89	-15.95	-8.55
3	0.46301	0.12	38.93	32.41	39.05	32.53	56.64	46.64	-17.59	-14.11
4	0.70209	0.13	39.85	36.90	39.98	37.03	56.00	46.00	-16.02	-8.97
5	1.88213	0.17	37.36	28.01	37.53	28.18	56.00	46.00	-18.47	-17.82
6	13.73725	0.65	40.05	38.64	40.70	39.29	60.00	50.00	-19.30	-10.71

REMARKS:

1. Q.P. and AV. are abbreviations of quasi-peak and average individually.
2. The emission levels of other frequencies were very low against the limit.
3. Margin value = Emission level - Limit value
4. Correction factor = Insertion loss + Cable loss
5. Emission Level = Correction Factor + Reading Value

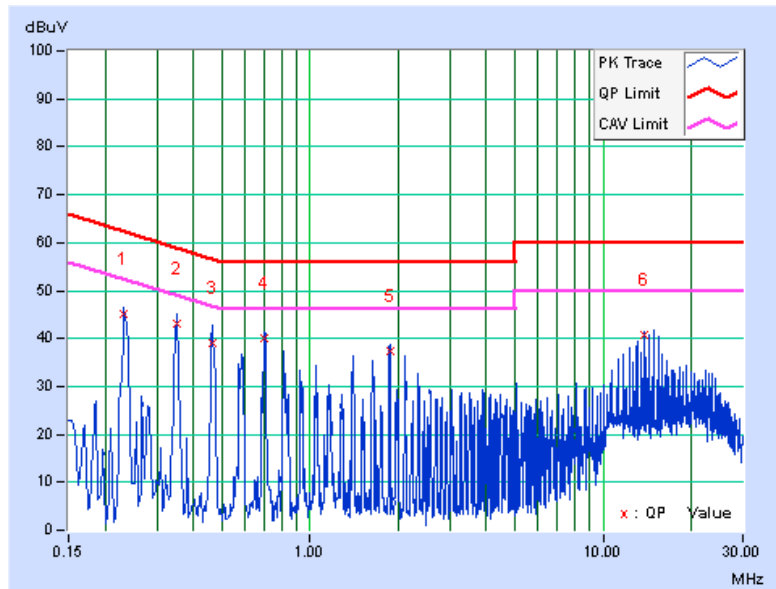



A D T

PHASE	Line 2	6dB BANDWIDTH	9kHz
TEST MODE	B		

No	Freq. [MHz]	Corr. Factor (dB)	Reading Value		Emission Level		Limit		Margin	
			[dB (uV)]		[dB (uV)]		[dB (uV)]		(dB)	
			Q.P.	AV.	Q.P.	AV.	Q.P.	AV.	Q.P.	AV.
1	0.23602	0.11	42.37	38.24	42.48	38.35	62.24	52.24	-19.75	-13.88
2	0.46669	0.13	40.97	37.52	41.10	37.65	56.57	46.57	-15.47	-8.92
3	0.70395	0.14	40.04	36.91	40.18	37.05	56.00	46.00	-15.82	-8.95
4	1.87040	0.16	36.17	27.69	36.33	27.85	56.00	46.00	-19.67	-18.15
5	12.33747	0.43	36.87	35.50	37.30	35.93	60.00	50.00	-22.70	-14.07
6	14.85942	0.49	41.26	39.80	41.75	40.29	60.00	50.00	-18.25	-9.71

REMARKS:

1. Q.P. and AV. are abbreviations of quasi-peak and average individually.
2. The emission levels of other frequencies were very low against the limit.
3. Margin value = Emission level - Limit value
4. Correction factor = Insertion loss + Cable loss
5. Emission Level = Correction Factor + Reading Value

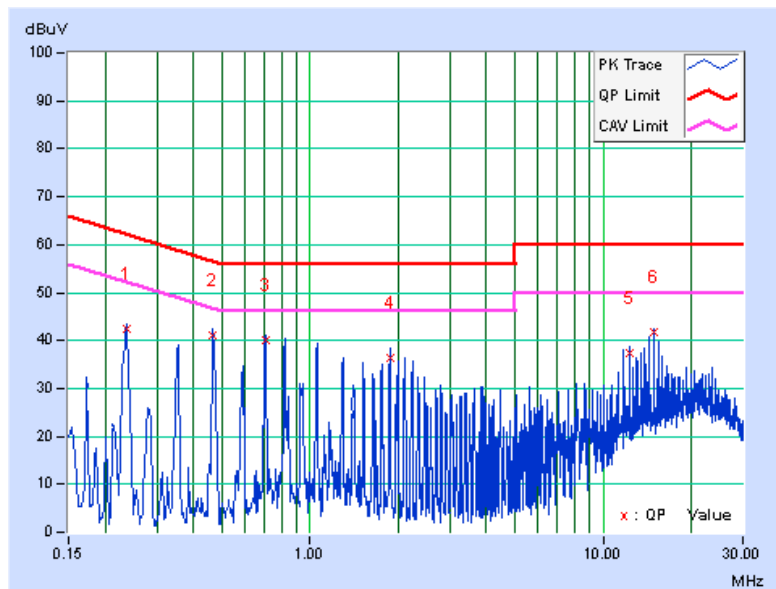



A D T

5.3 6dB BANDWIDTH MEASUREMENT

5.3.1 LIMITS OF 6dB BANDWIDTH MEASUREMENT

The minimum of 6dB Bandwidth Measurement is 0.5MHz.

5.3.2 TEST SETUP

Same as item 4.3.2.

5.3.3 TEST INSTRUMENTS

Refer to section 4.1.2 to get information of above instrument.

5.3.4 TEST PROCEDURE

Same as item 4.3.4.

5.3.5 DEVIATION FROM TEST STANDARD

No deviation.

5.3.6 EUT OPERATING CONDITIONS

Same as item 4.3.6.



5.3.7 TEST RESULTS

802.11a

CHANNEL	FREQUENCY (MHz)	6dB BANDWIDTH (MHz)			MINIMUM LIMIT (MHz)	PASS / FAIL
		CHAIN 0	CHAIN 1	CHAIN 2		
149	5745	15.73	15.80	16.39	0.5	PASS
157	5785	16.39	13.30	16.40	0.5	PASS
165	5825	15.35	14.47	16.36	0.5	PASS

802.11n (20MHz)

CHANNEL	FREQUENCY (MHz)	6dB BANDWIDTH (MHz)			MINIMUM LIMIT (MHz)	PASS / FAIL
		CHAIN 0	CHAIN 1	CHAIN 2		
149	5745	17.62	17.60	17.61	0.5	PASS
157	5785	16.66	16.89	16.71	0.5	PASS
165	5825	16.88	16.56	17.58	0.5	PASS

802.11n (40MHz)

CHANNEL	FREQUENCY (MHz)	6dB BANDWIDTH (MHz)			MINIMUM LIMIT (MHz)	PASS / FAIL
		CHAIN 0	CHAIN 1	CHAIN 2		
151	5755	36.07	35.73	36.43	0.5	PASS
159	5795	35.56	36.48	36.43	0.5	PASS

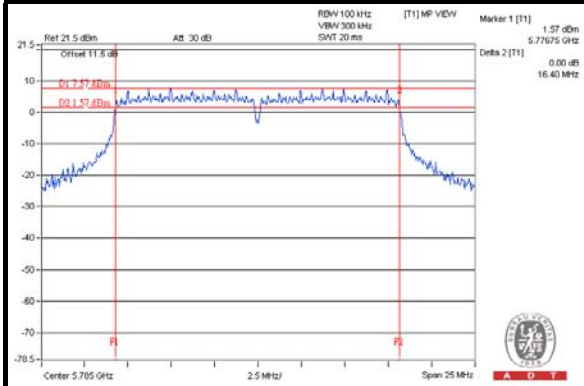
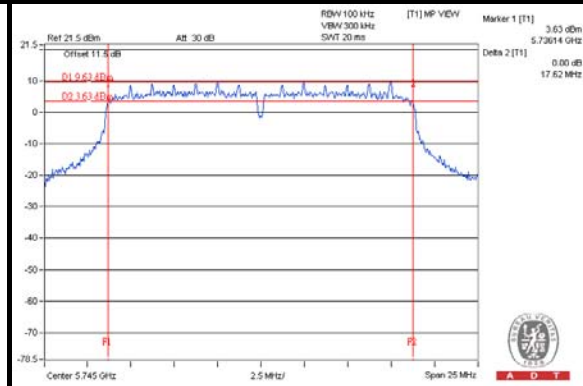
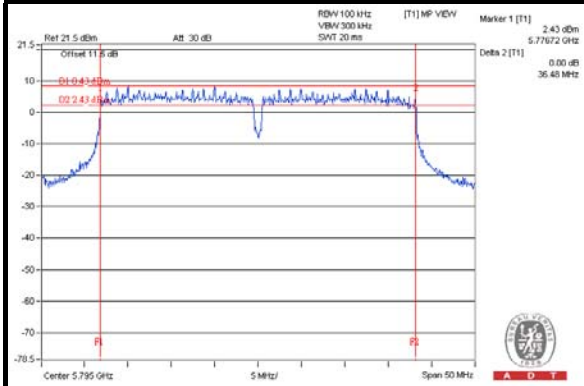
SPECTRUM PLOT OF WORST VALUE**802.11a****802.11n (20MHz)****802.11n (40MHz)**



A D T

5.4 CONDUCTED OUTPUT POWER

5.4.1 LIMITS OF CONDUCTED OUTPUT POWER MEASUREMENT

For systems using digital modulation in the 5725 –5850 MHz bands: 1 Watt (30dBm)

Per KDB 662911 D01 Multiple Transmitter Output v02 Method of conducted output power measurement on IEEE 802.11 devices,

Array Gain = 0 dB (i.e., no array gain) for $NANT \leq 4$;

Array Gain = 0 dB (i.e., no array gain) for channel widths ≥ 40 MHz for any NANT;

Array Gain = $5 \log(NANT/NSS)$ dB or 3 dB, whichever is less for 20-MHz channel widths with $NANT \geq 5$.

For power measurements on all other devices: Array Gain = $10 \log(NANT/NSS)$ dB.

5.4.2 TEST SETUP

Same as Item 4.4.2.

5.4.3 INSTRUMENTS

Refer to section 4.1.2 to get information of above instrument.

5.4.4 TEST PROCEDURES

Same as Item 4.4.4.

5.4.5 DEVIATION FROM TEST STANDARD

No deviation.

5.4.6 EUT OPERATING CONDITIONS

Same as Item 4.3.6.



A D T

5.4.7 TEST RESULTS

802.11a

CHAN.	FREQ. (MHz)	AVERAGE POWER (dBm)			TOTAL POWER (mW)	TOTAL POWER (dBm)	LIMIT (dBm)	PASS / FAIL
		CHAIN 0	CHAIN 1	CHAIN 2				
149	5745	21.28	23.41	24.36	626.454	27.97	30	PASS
157	5785	19.81	22.56	23.73	512.069	27.09	30	PASS
165	5825	23.11	25.95	25.87	984.561	29.93	30	PASS

802.11n (20MHz)

CHAN.	FREQ. (MHz)	AVERAGE POWER (dBm)			TOTAL POWER (mW)	TOTAL POWER (dBm)	LIMIT (dBm)	PASS / FAIL
		CHAIN 0	CHAIN 1	CHAIN 2				
149	5745	21.37	22.62	23.74	556.490	27.45	30	PASS
157	5785	23.07	25.88	26.01	989.051	29.95	30	PASS
165	5825	23.05	25.99	25.92	989.870	29.96	30	PASS

802.11n (40MHz)

CHAN.	FREQ. (MHz)	AVERAGE POWER (dBm)			TOTAL POWER (mW)	TOTAL POWER (dBm)	LIMIT (dBm)	PASS / FAIL
		CHAIN 0	CHAIN 1	CHAIN 2				
151	5755	19.58	21.66	22.84	429.646	26.33	30	PASS
159	5795	23.42	25.76	25.98	992.768	29.97	30	PASS



A D T

5.5 POWER SPECTRAL DENSITY MEASUREMENT

5.5.1 LIMITS OF POWER SPECTRAL DENSITY MEASUREMENT

The Maximum of Power Spectral Density Measurement is 8dBm.

5.5.2 TEST SETUP

Same as item 4.5.2.

5.5.3 TEST INSTRUMENTS

Refer to section 4.1.2 to get information of above instrument.

5.5.4 TEST PROCEDURE.

Same as item 4.5.4.

5.5.5 DEVIATION FROM TEST STANDARD

No deviation.

5.5.6 EUT OPERATING CONDITION

Same as item 4.3.6.



A D T

5.5.7 TEST RESULTS

802.11a

TX chain	Channel	Freq. (MHz)	PSD (dBm/3kHz)	10 log (N=3) dB	Total PSD (dBm/3kHz)	Limit (dBm/3kHz)	PASS /FAIL
0	149	5745	-10.69	4.77	-5.92	4.23	PASS
	157	5785	-12.16	4.77	-7.39	4.23	PASS
	165	5825	-8.45	4.77	-3.68	4.23	PASS
1	149	5745	-10.68	4.77	-5.91	4.23	PASS
	157	5785	-12.92	4.77	-8.15	4.23	PASS
	165	5825	-10.90	4.77	-6.13	4.23	PASS
2	149	5745	-10.78	4.77	-6.01	4.23	PASS
	157	5785	-13.73	4.77	-8.96	4.23	PASS
	165	5825	-10.73	4.77	-5.96	4.23	PASS

NOTE: Directional gain = $5\text{dBi} + 10\log(3) = 9.77\text{dBi} > 6\text{dBi}$, so the power density limit shall be reduced to $8-(9.77-6) = 4.23\text{dBm}$.

802.11n (20MHz)

TX chain	Channel	Freq. (MHz)	PSD (dBm/3kHz)	10 log (N=3) dB	Total PSD (dBm/3kHz)	Limit (dBm/3kHz)	PASS /FAIL
0	149	5745	-12.29	4.77	-7.52	8	PASS
	157	5785	-9.65	4.77	-4.88	8	PASS
	165	5825	-9.56	4.77	-4.79	8	PASS
1	149	5745	-13.96	4.77	-9.19	8	PASS
	157	5785	-11.44	4.77	-6.67	8	PASS
	165	5825	-11.58	4.77	-6.81	8	PASS
2	149	5745	-12.59	4.77	-7.82	8	PASS
	157	5785	-10.22	4.77	-5.45	8	PASS
	165	5825	-10.78	4.77	-6.01	8	PASS

NOTE:

- 802.11n transmit signals are completely uncorrelated.
- Directional gain = $5\text{dBi} + 10\log(3/3) = 5\text{dBi} < 6\text{dBi}$, so the power density limit no need to reduced.



A D T

802.11n (40MHz)

TX chain	Channel	Freq. (MHz)	PSD (dBm/3kHz)	10 log (N=3) dB	Total PSD (dBm/3kHz)	Limit (dBm/3kHz)	PASS /FAIL
0	151	5755	-15.48	4.77	-10.71	8	PASS
	159	5795	-12.10	4.77	-7.33	8	PASS
1	151	5755	-16.93	4.77	-12.16	8	PASS
	159	5795	-14.04	4.77	-9.27	8	PASS
2	151	5755	-15.79	4.77	-11.02	8	PASS
	159	5795	-11.53	4.77	-6.76	8	PASS

NOTE:

1. 802.11n transmit signals are completely uncorrelated.
2. Directional gain = $5\text{dBi} + 10\log(3/3) = 5\text{dBi} < 6\text{dBi}$, so the power density limit no need to reduced.



A D T

SPECTRUM PLOT OF WORST VALUE

802.11a

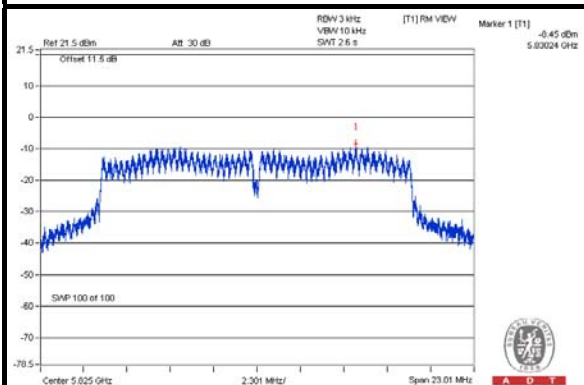

802.11n (20MHz)

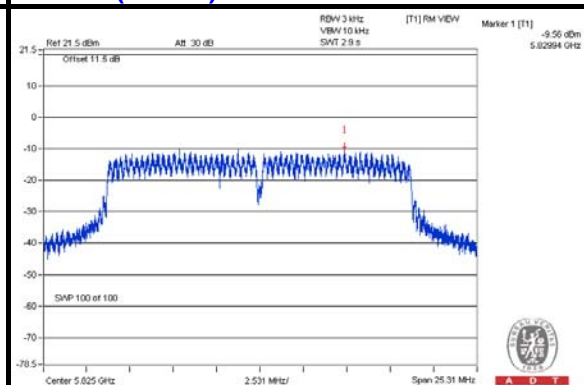

802.11n (40MHz)

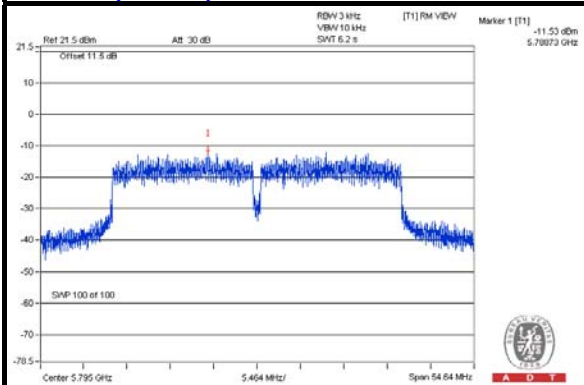



A D T

5.6 CONDUCTED OUT OF BAND EMISSION MEASUREMENT

5.6.1 LIMITS OF CONDUCTED OUT OF BAND EMISSION MEASUREMENT

Below -30dB of the highest emission level of operating band (in 100kHz Resolution Bandwidth).

5.6.2 TEST SETUP

Same as Item 4.6.2

5.6.3 TEST INSTRUMENTS

Refer to section 4.1.2 to get information of above instrument.

5.6.4 TEST PROCEDURE

Same as Item 4.6.4

5.6.5 DEVIATION FROM TEST STANDARD

No deviation.

5.6.6 EUT OPERATING CONDITION

Same as Item 4.3.6

5.6.7 TEST RESULTS

The conducted emission test is performed on each TX port of operating mode without summing or adding $10\log(N)$ since the limit is relative emission limit.

The spectrum plots are attached on the following pages. D1 line indicates the highest level, and D2 line indicates the 30dB offset below D1. It shows compliance with the requirement.



A D T

802.11a CHAIN 0

CH 149

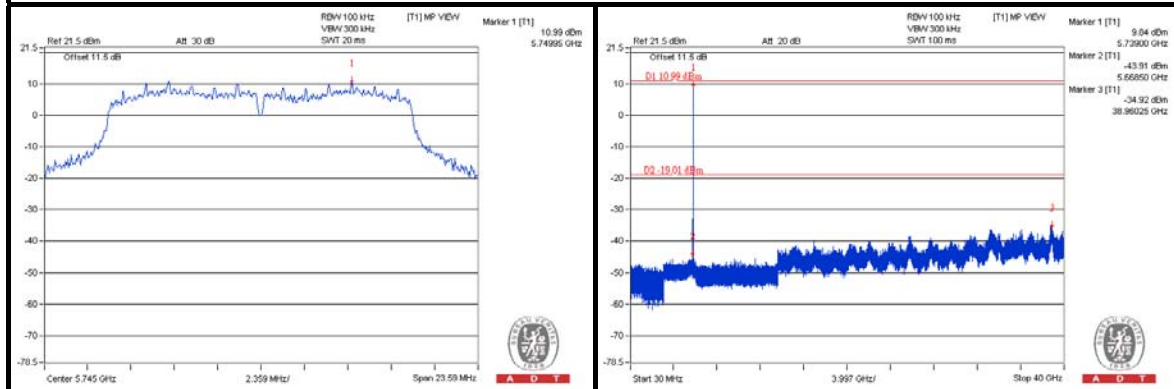

CH 157

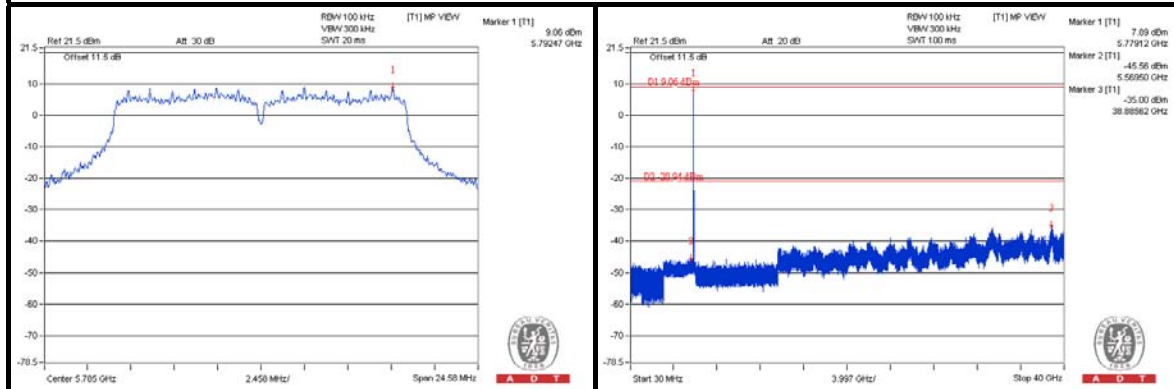

CH 165

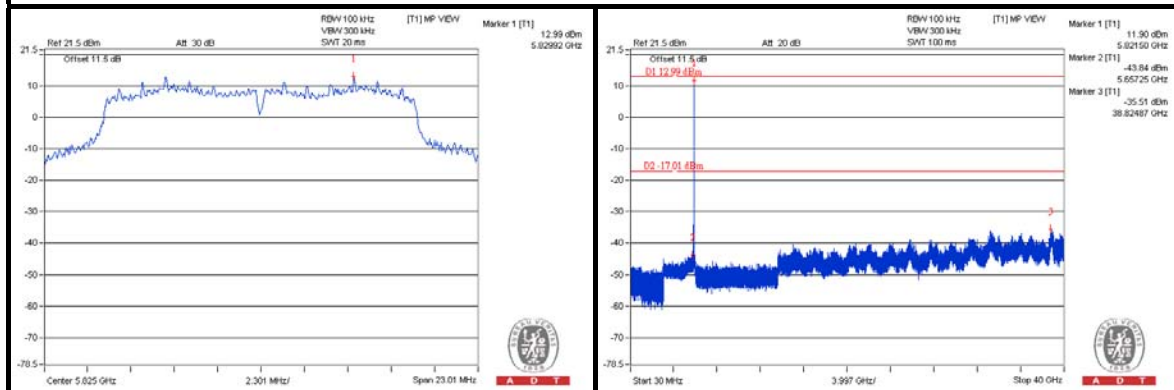

CH 149 Band edge

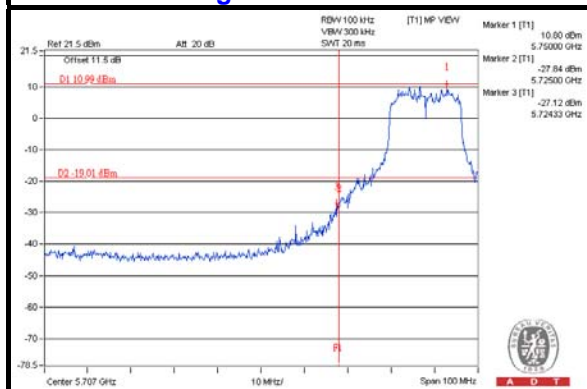

CH 165 Band edge

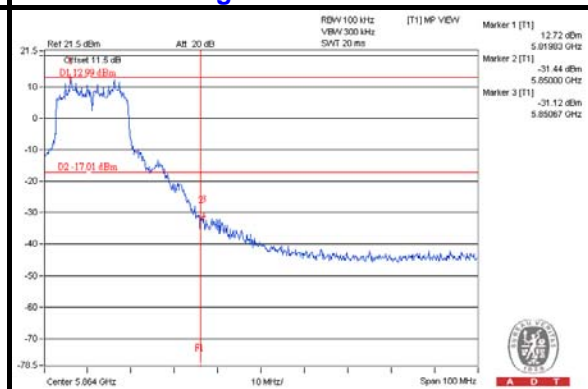



A D T

CHAIN 1

CH 149

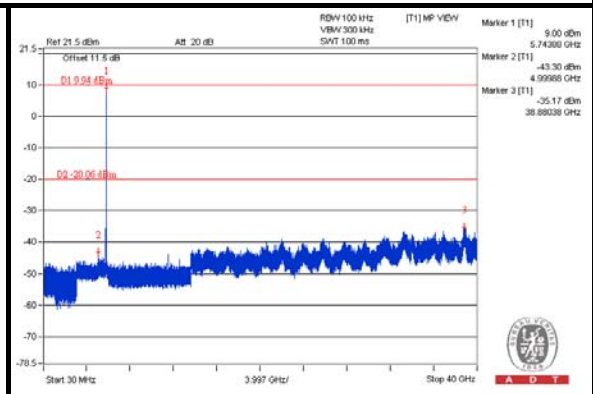
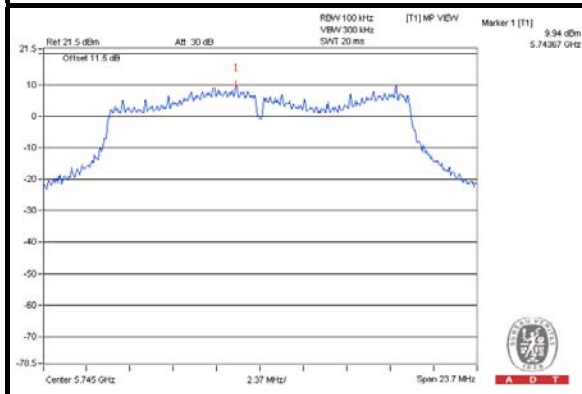

CH 157

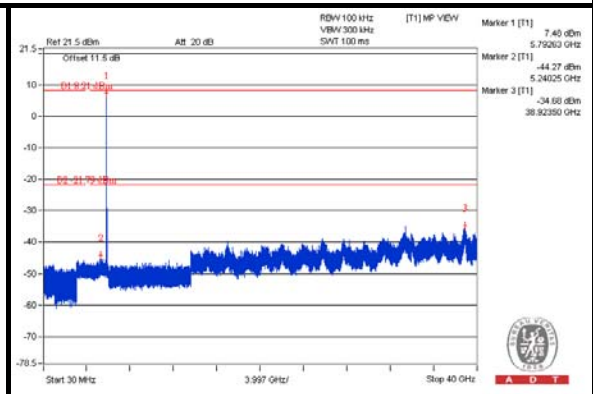
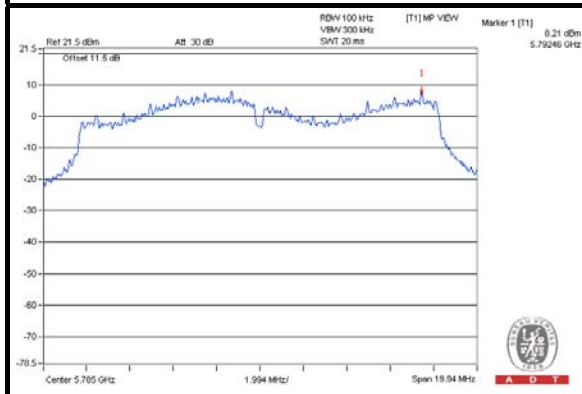

CH 165

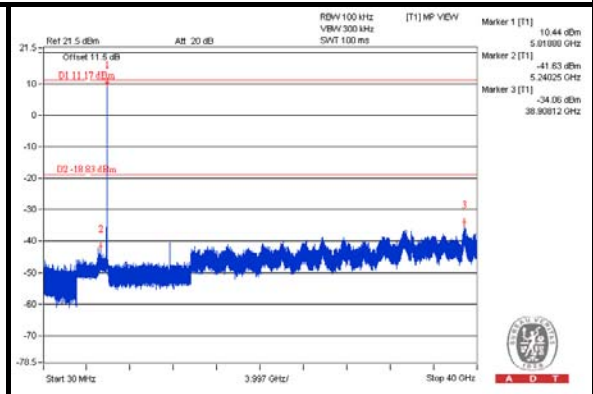
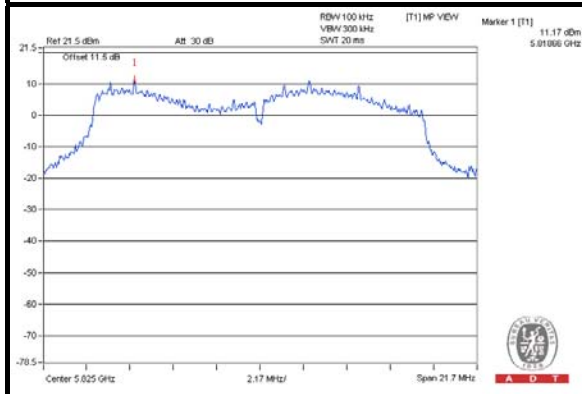

CH 149 Band edge

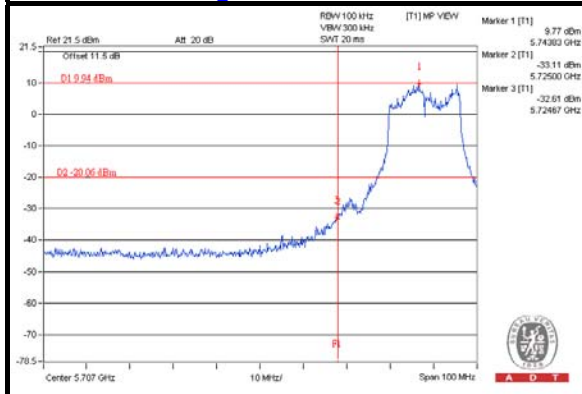

CH 165 Band edge

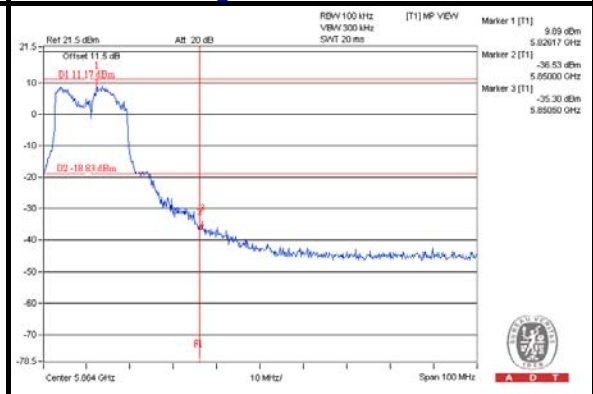



A D T

CHAIN 2

CH 149

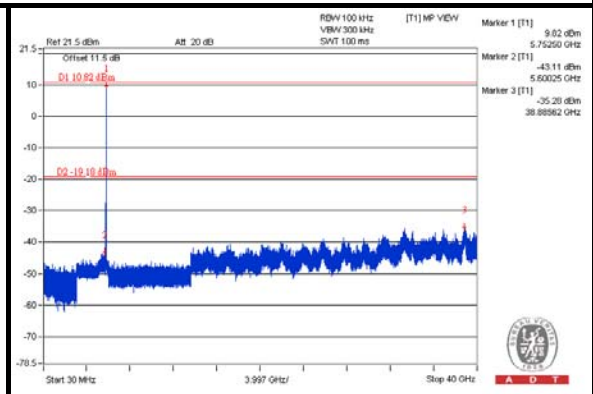
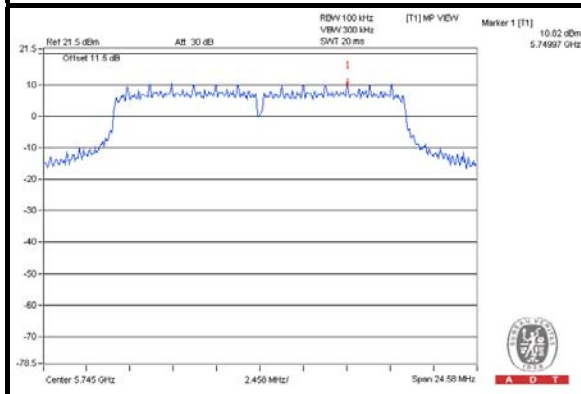

CH 157

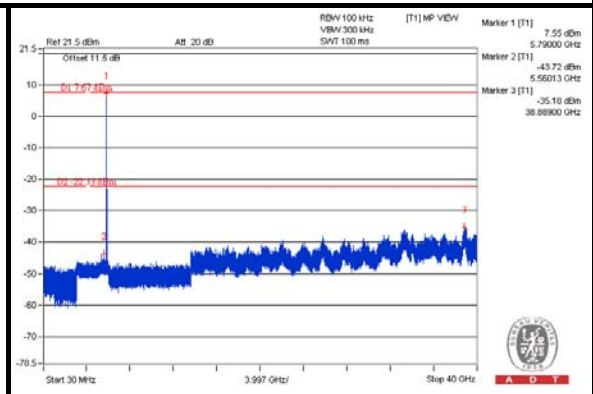
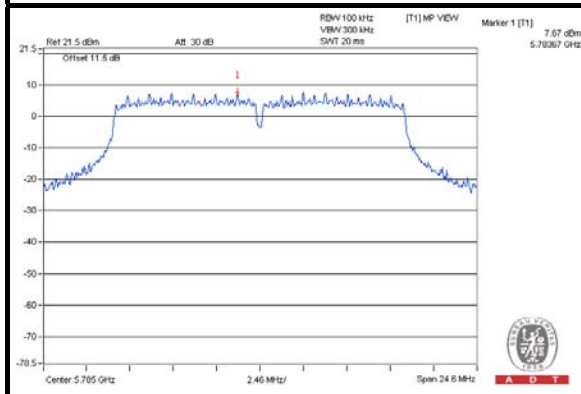

CH 165

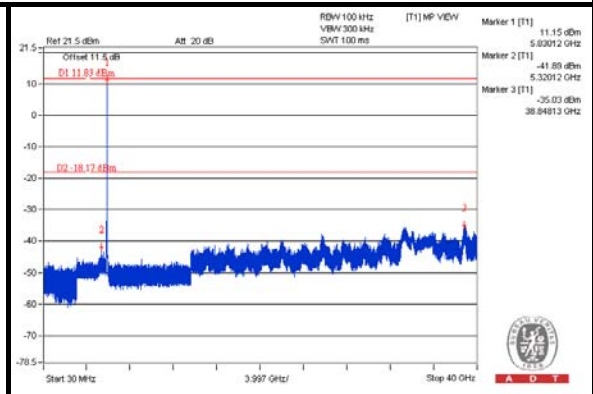
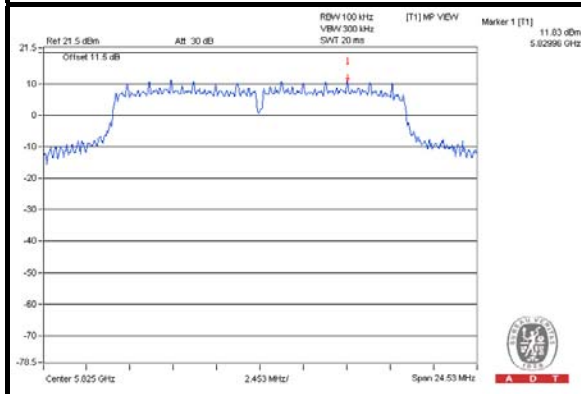

CH 149 Band edge

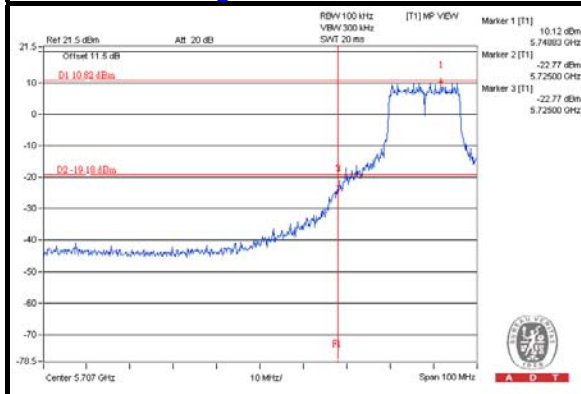

CH 165 Band edge

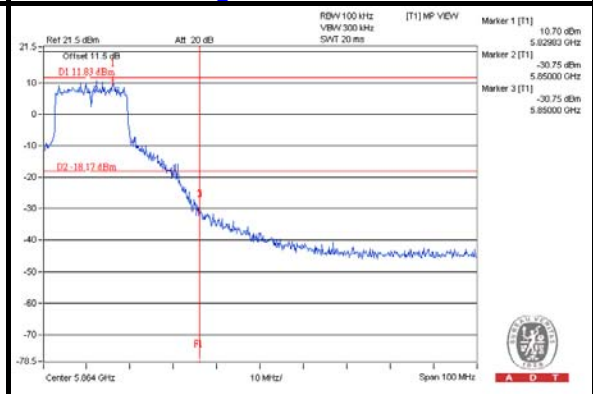



A D T

802.11n (20MHz) CHAIN 0

CH 149

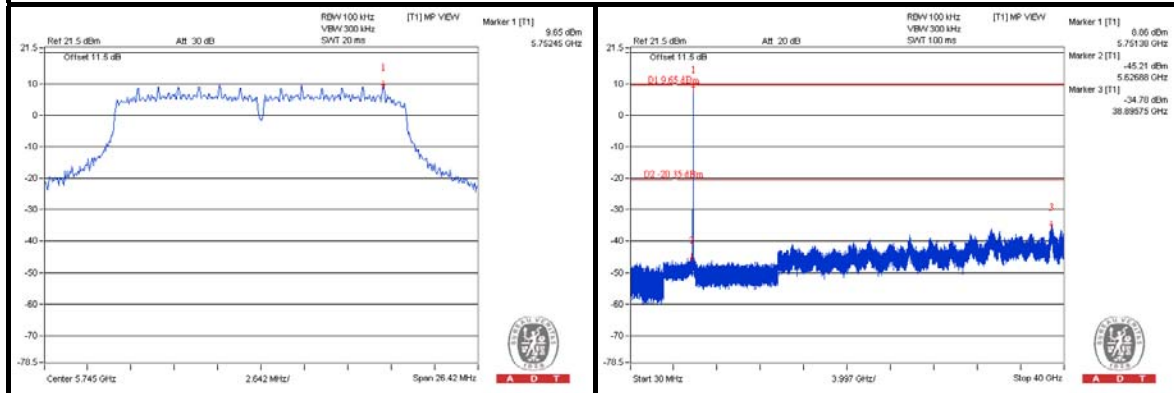

CH 157

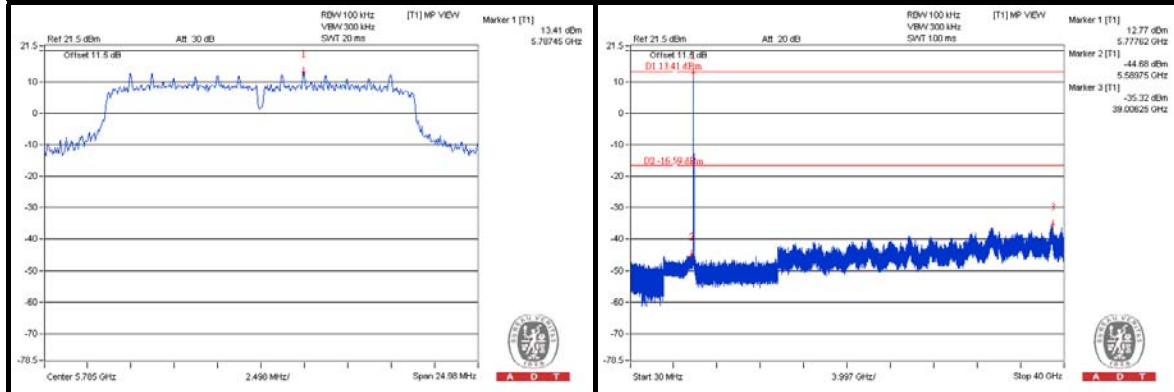

CH 165

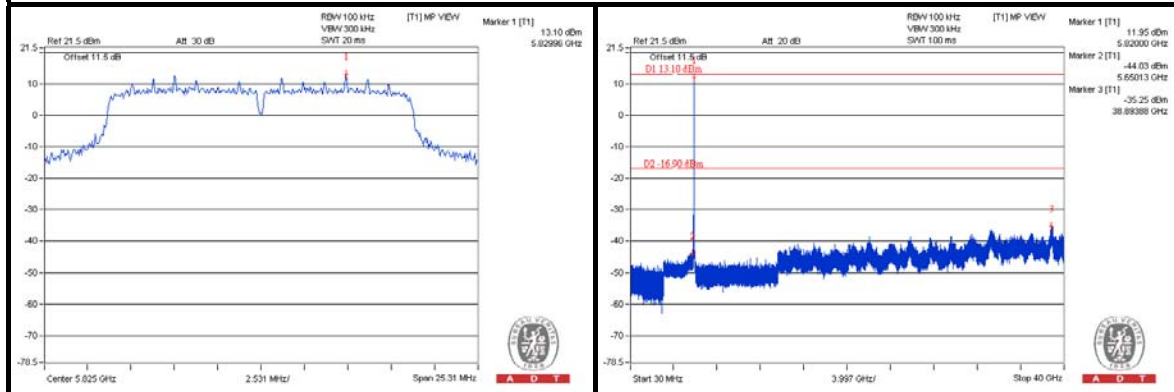

CH 149 Band edge

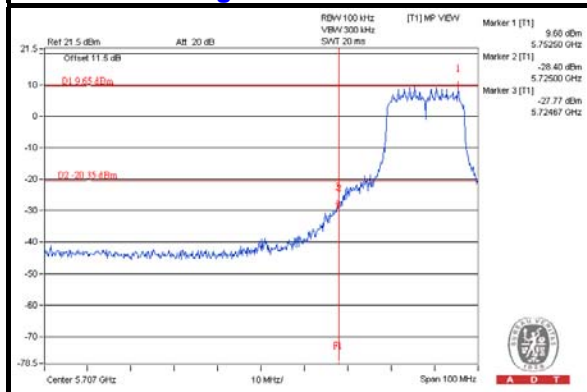

CH 165 Band edge

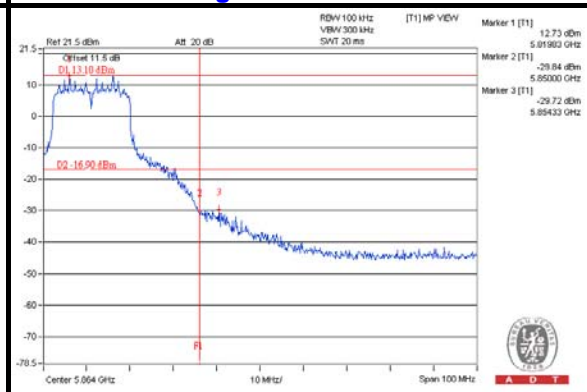



A D T

CHAIN 1

CH 149

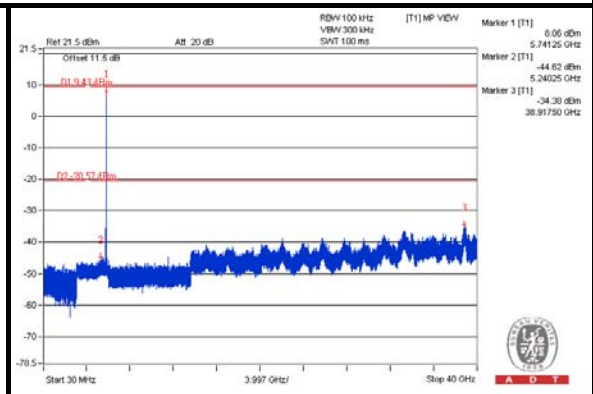
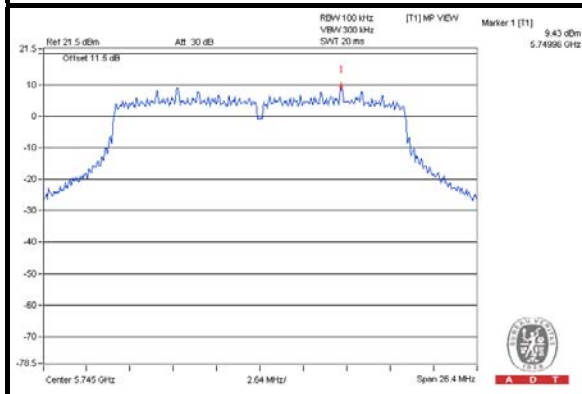

CH 157

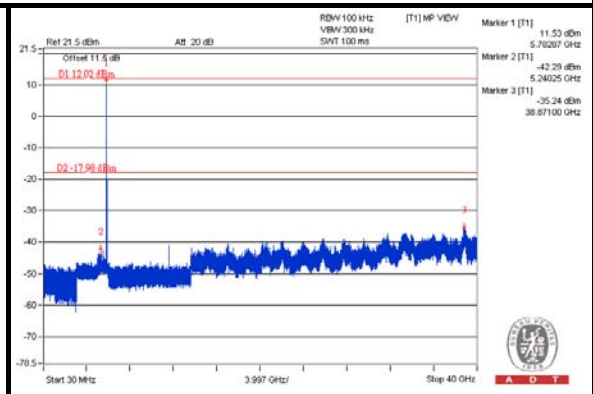
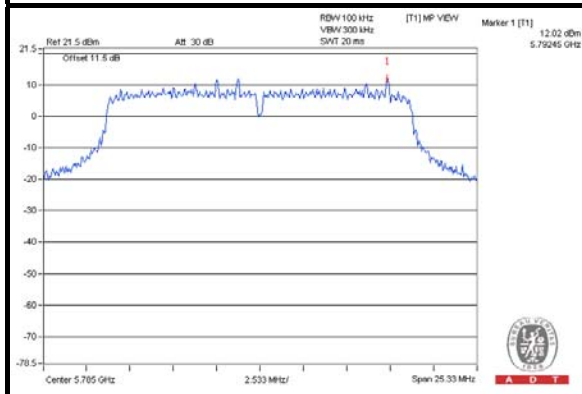

CH 165

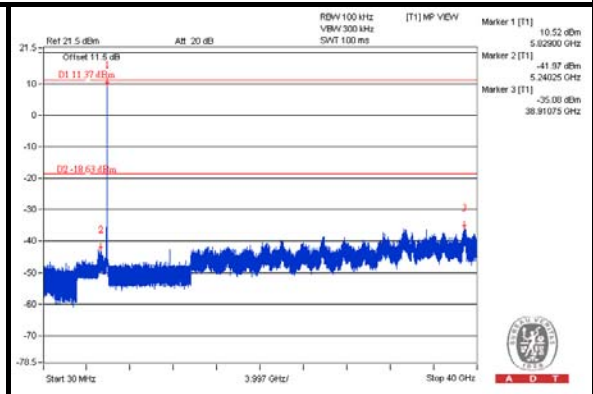
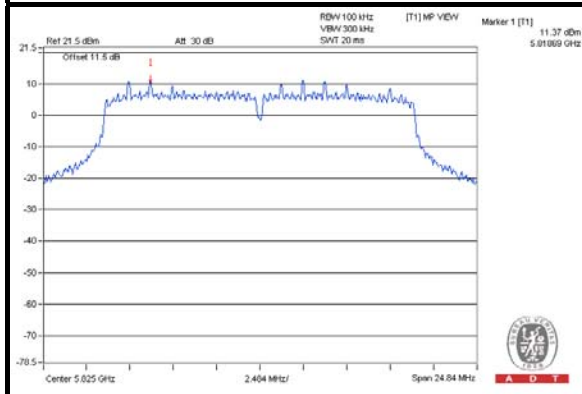

CH 149 Band edge

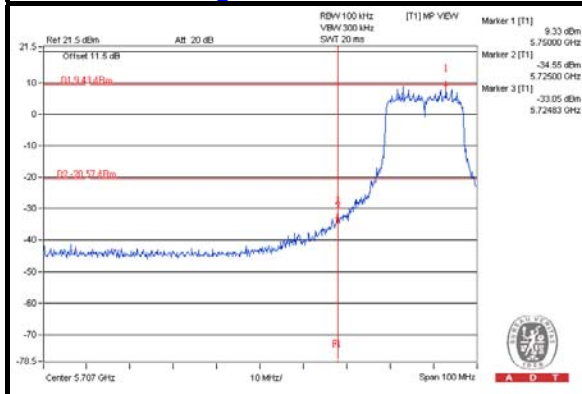

CH 165 Band edge

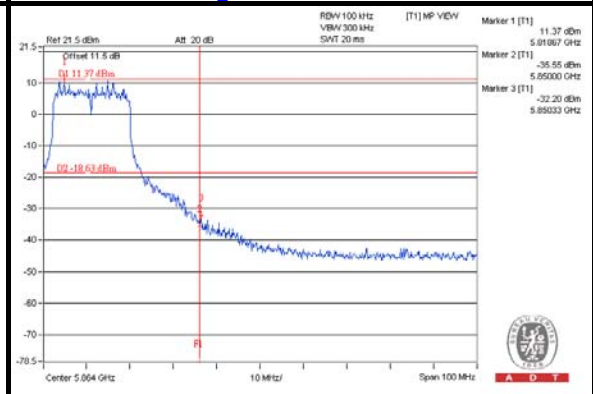



A D T

CHAIN 2

CH 149

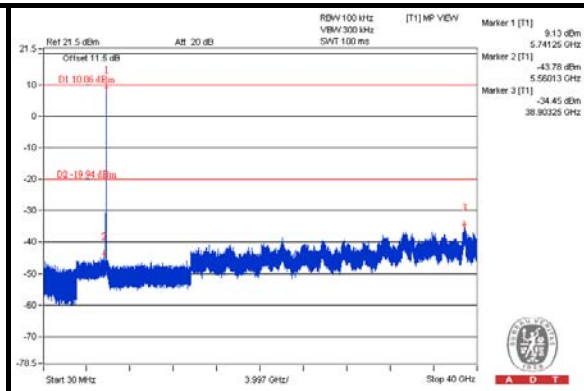
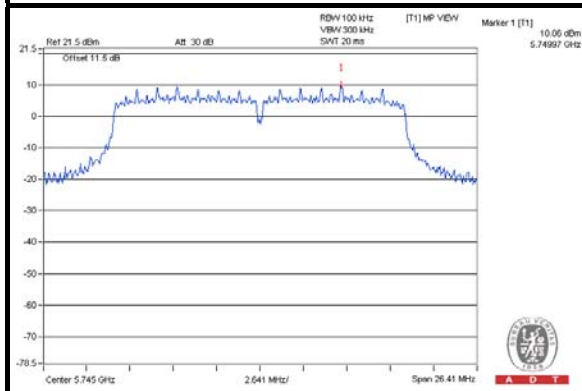

CH 157

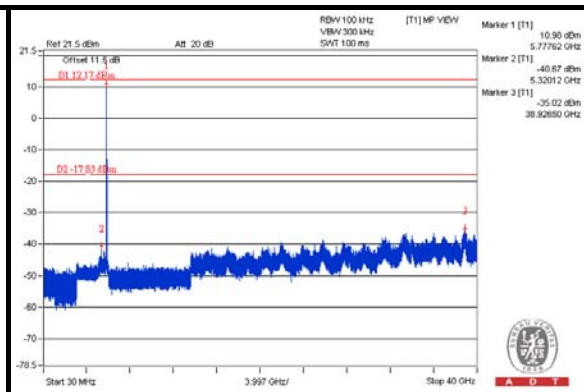
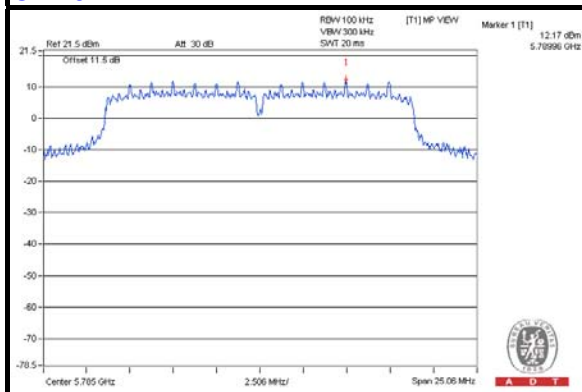

CH 165

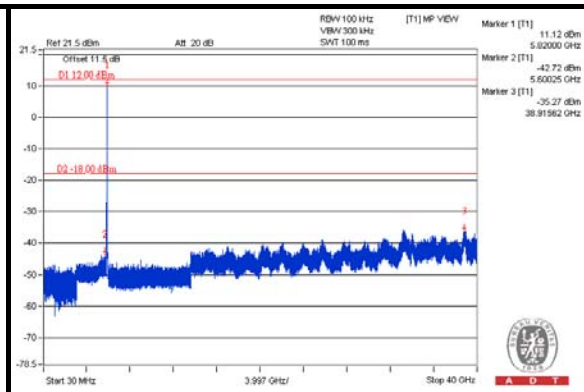
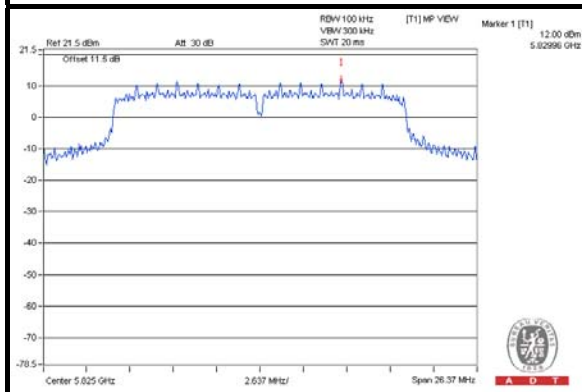

CH 149 Band edge

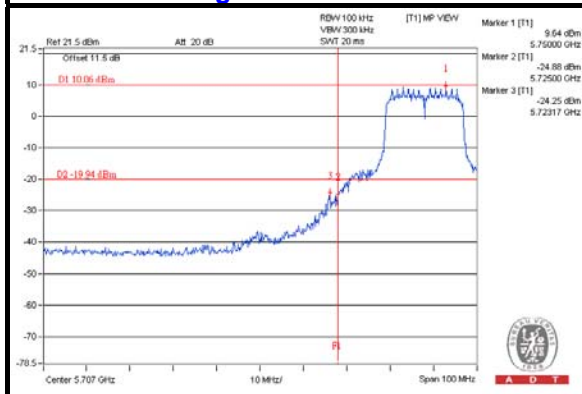

CH 165 Band edge

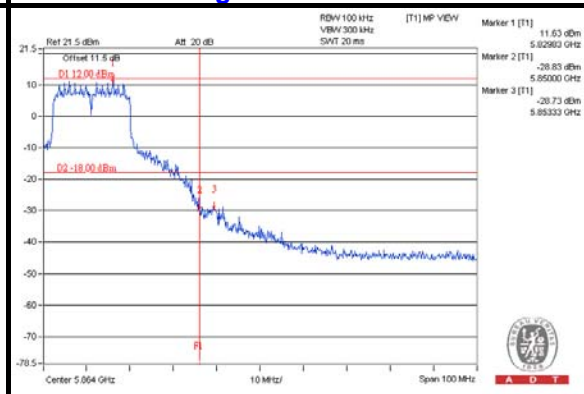



A D T

802.11n (40MHz) CHAIN 0

CH 151

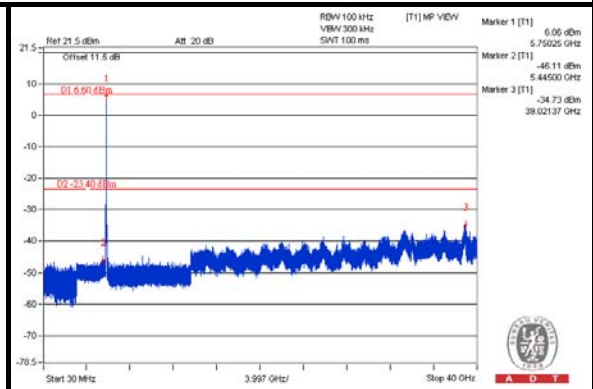
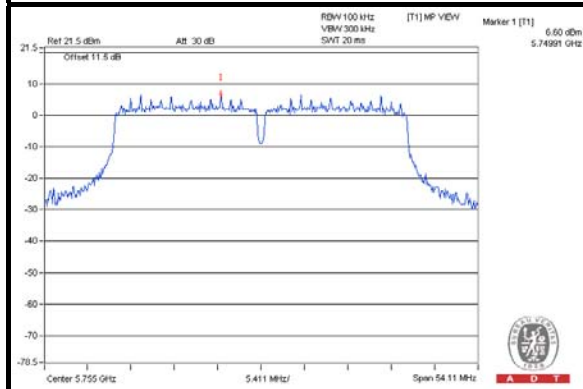

CH 159

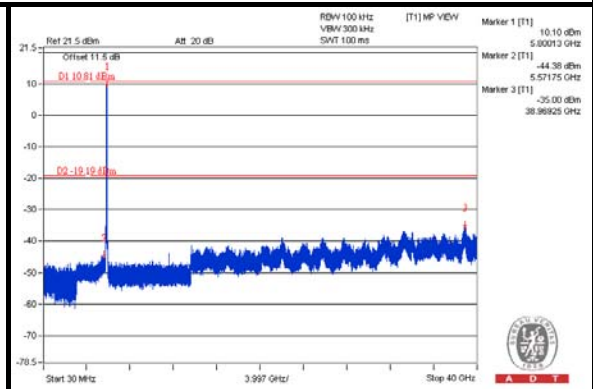
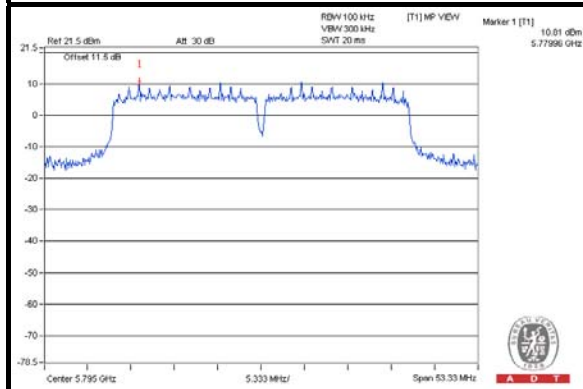

CH 151 Band edge

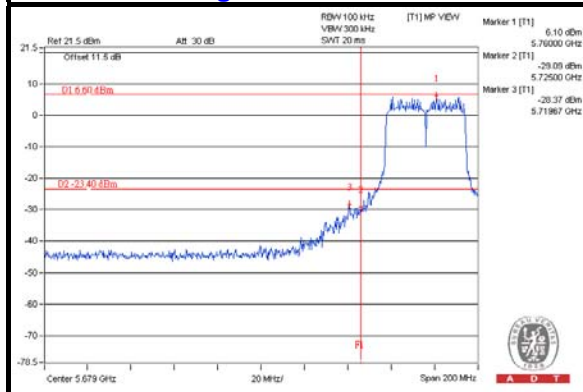

CH 159 Band edge

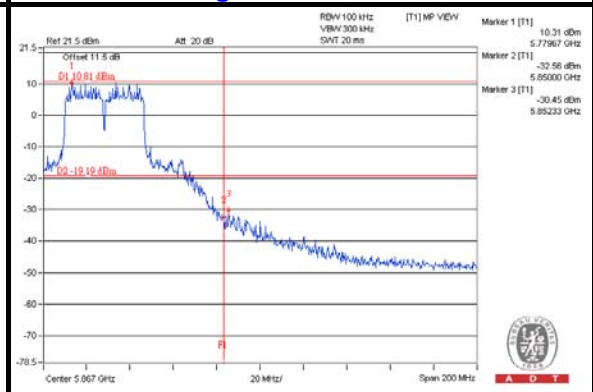



A D T

CHAIN 1

CH 151

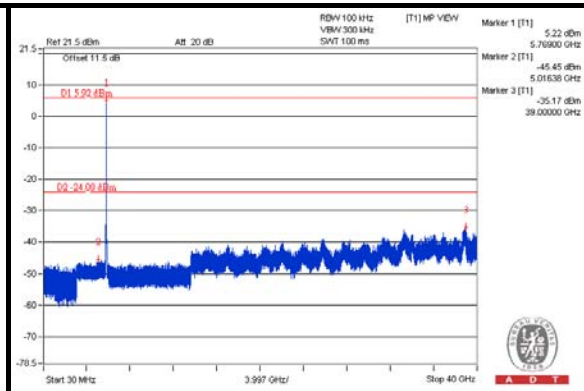
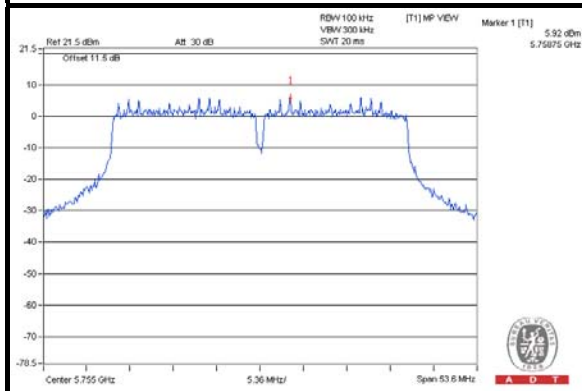

CH 159

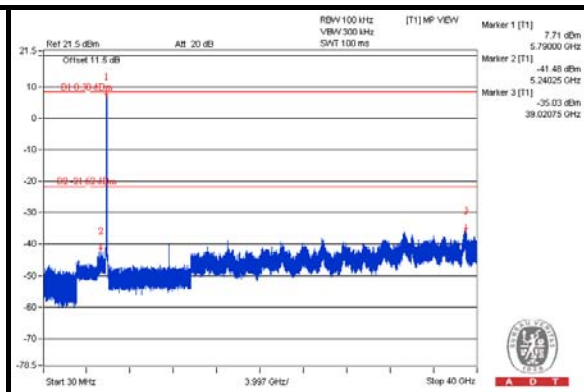
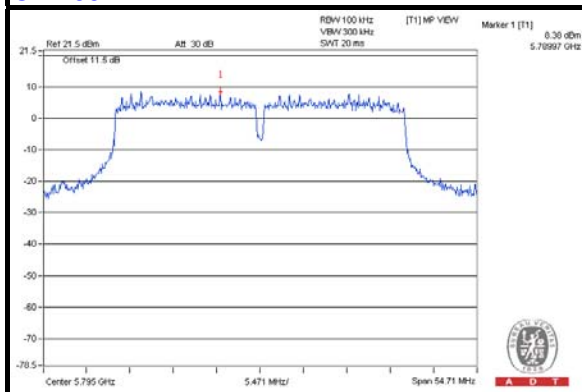

CH 151 Band edge

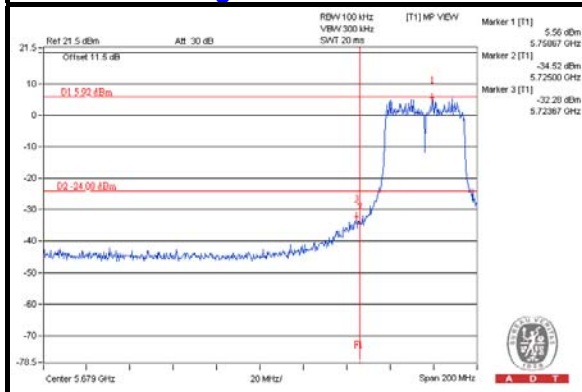

CH 159 Band edge

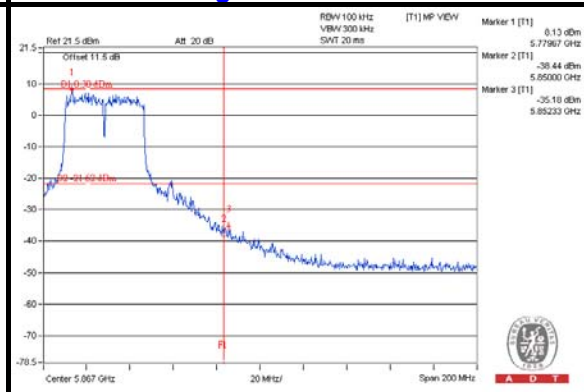



A D T

CHAIN 2

CH 151

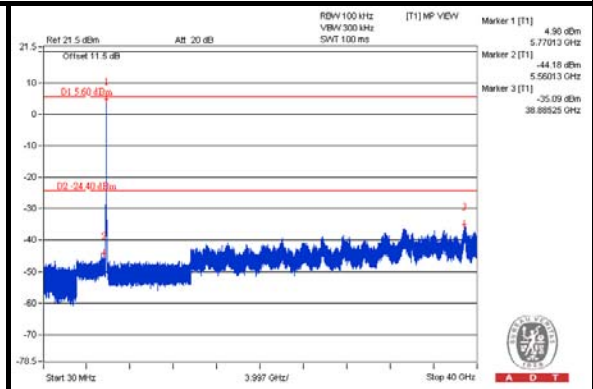
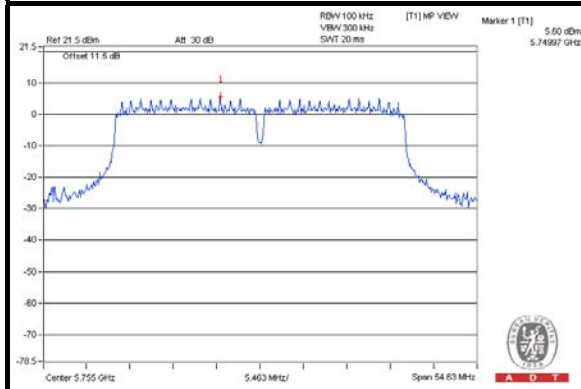

CH 159

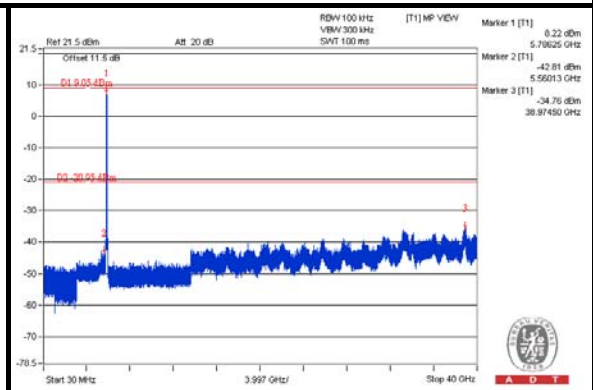
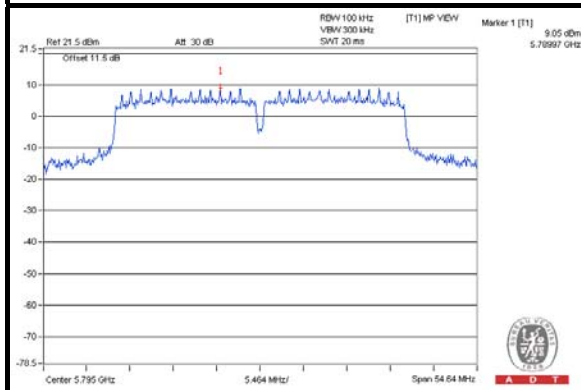

CH 151 Band edge

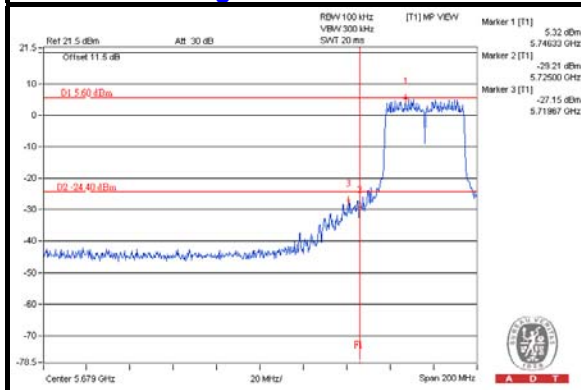

CH 159 Band edge

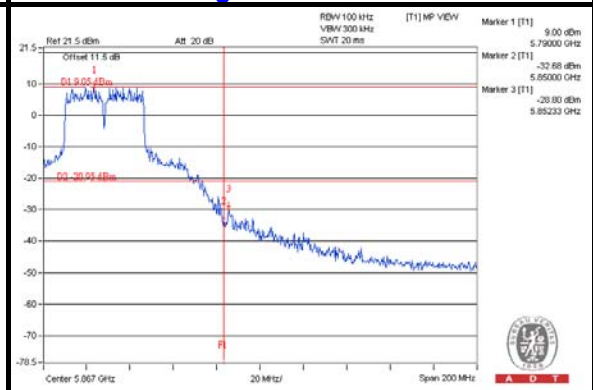



A D T

6. PHOTOGRAPHS OF THE TEST CONFIGURATION

Please refer to the attached file (Test Setup Photo).



A D T

7. INFORMATION ON THE TESTING LABORATORIES

We, Bureau Veritas Consumer Products Services (H.K.) Ltd., Taoyuan Branch, were founded in 1988 to provide our best service in EMC, Radio, Telecom and Safety consultation. Our laboratories are accredited and approved according to ISO/IEC 17025.

If you have any comments, please feel free to contact us at the following:

Linko EMC/RF Lab

Tel: 886-2-26052180

Fax: 886-2-26051924

Hsin Chu EMC/RF Lab

Tel: 886-3-5935343

Fax: 886-3-5935342

Hwa Ya EMC/RF/Safety/Telecom Lab

Tel: 886-3-3183232

Fax: 886-3-3270892

Email: service.adt@tw.bureauveritas.com

Web Site: www.bureauveritas-adt.com

The address and road map of all our labs can be found in our web site also.



A D T

8. APPENDIX A – MODIFICATIONS RECORDERS FOR ENGINEERING CHANGES TO THE EUT BY THE LAB

No modifications were made to the EUT by the lab during the test.

---END---