

FCC Test Report

Report No.: RF140224C17J

FCC ID: WT8-MR1750

Test Model: MR1750

Received Date: Jan. 13, 2016

Test Date: Jan. 19 ~ Feb. 02, 2016

Issued Date: Feb. 17, 2016

Applicant: Open Mesh, Inc.

Address: 5 Centerpointe Drive, Suite 400, Lake Oswego, OR 97035, USA

Issued By: Bureau Veritas Consumer Products Services (H.K.) Ltd., Taoyuan Branch

Lab Address: No. 47-2, 14th Ling, Chia Pau Vil., Lin Kou Dist., New Taipei City, Taiwan, R.O.C.

Test Location: No. 19, Hwa Ya 2nd Rd., Wen Hwa Vil., Kwei Shan Dist., Taoyuan City 33383, TAIWAN (R.O.C.)



This report is for your exclusive use. Any copying or replication of this report to or for any other person or entity, or use of our name or trademark, is permitted only with our prior written permission. This report sets forth our findings solely with respect to the test samples identified herein. The results set forth in this report are not indicative or representative of the quality or characteristics of the lot from which a test sample was taken or any similar or identical product unless specifically and expressly noted. Our report includes all of the tests requested by you and the results thereof based upon the information that you provided to us. You have 60 days from date of issuance of this report to notify us of any material error or omission caused by our negligence, provided, however, that such notice shall be in writing and shall specifically address the issue you wish to raise. A failure to raise such issue within the prescribed time shall constitute your unqualified acceptance of the completeness of this report, the tests conducted and the correctness of the report contents. Unless specific mention, the uncertainty of measurement has been explicitly taken into account to declare the compliance or non-compliance to the specification. The report must not be used by the client to claim product certification, approval, or endorsement by TAF or any government agencies.



Table of Contents

Release Control Record	4
1 Certificate of Conformity	5
2 Summary of Test Results	6
2.1 Measurement Uncertainty	6
2.2 Modification Record	6
3 General Information	7
3.1 General Description of EUT	7
3.2 Description of Test Modes	9
3.2.1 Test Mode Applicability and Tested Channel Detail.....	10
3.3 Duty Cycle of Test Signal	12
3.4 Description of Support Units	13
3.4.1 Configuration of System under Test	14
3.5 General Description of Applied Standards	15
4 Test Types and Results	16
4.1 Radiated Emission and Bandedge Measurement.....	16
4.1.1 Limits of Radiated Emission and Bandedge Measurement	16
4.1.2 Test Instruments	17
4.1.3 Test Procedures.....	18
4.1.4 Deviation from Test Standard	18
4.1.5 Test Set Up	19
4.1.6 EUT Operating Conditions.....	19
4.1.7 Test Results	20
4.2 Conducted Emission Measurement	40
4.2.1 Limits of Conducted Emission Measurement	40
4.2.2 Test Instruments	40
4.2.3 Test Procedures.....	41
4.2.4 Deviation from Test Standard	41
4.2.5 Test Setup.....	41
4.2.6 EUT Operating Conditions.....	41
4.2.7 Test Results	42
4.3 Transmit Power Measurement	46
4.3.1 Limits of Transmit Power Measurement	46
4.3.2 Test Setup.....	46
4.3.3 Test Instruments	46
4.3.4 Test Procedure	47
4.3.5 Deviation from Test Standard	47
4.3.6 EUT Operating Conditions.....	47
4.3.7 Test Result.....	48
4.4 Peak Power Spectral Density Measurement	53
4.4.1 Limits of Peak Power Spectral Density Measurement	53
4.4.2 Test Setup.....	53
4.4.3 Test Instruments	53
4.4.4 Test Procedures.....	53
4.4.5 Deviation from Test Standard	54
4.4.6 EUT Operating Conditions.....	54
4.4.7 Test Results	55
4.5 Frequency Stability.....	60
4.5.1 Limits of Frequency Stability Measurement	60
4.5.2 Test Setup.....	60
4.5.3 Test Instruments	60
4.5.4 Test Procedure	60
4.5.5 Deviation from Test Standard	60
4.5.6 EUT Operating Condition	60



4.5.7 Test Results	61
4.6 6dB Bandwidth Measurement	62
4.6.1 Limits of 6dB Bandwidth Measurement	62
4.6.2 Test Setup	62
4.6.3 Test Instruments	62
4.6.4 Test Procedure	62
4.6.5 Deviation from Test Standard	62
4.6.6 EUT Operating Condition	62
4.6.7 Test Results	63
5 Pictures of Test Arrangements	65
Appendix – Information on the Testing Laboratories	66



A D T

Release Control Record

Issue No.	Description	Date Issued
RF140224C17J	Original release	Feb. 17, 2016

1 Certificate of Conformity

Product: Wireless a/b/g/n/AC Access Point

Brand: Open Mesh

Test Model: MR1750

Sample Status: Engineering Sample

Applicant: Open Mesh, Inc.

Test Date: Jan. 19 ~ Feb. 02, 2016

Standards: 47 CFR FCC Part 15, Subpart E (Section 15.407)
ANSI C63.10:2013

The above equipment has been tested by **Bureau Veritas Consumer Products Services (H.K.) Ltd., Taoyuan Branch**, and found compliance with the requirement of the above standards. The test record, data evaluation & Equipment Under Test (EUT) configurations represented herein are true and accurate accounts of the measurements of the sample's EMC characteristics under the conditions specified in this report.

Prepared by : Celine Chou , **Date:** Feb. 17, 2016
Celine Chou / Specialist

Approved by : Ken Liu , **Date:** Feb. 17, 2016
Ken Liu / Senior Manager

2 Summary of Test Results

47 CFR FCC Part 15, Subpart E (Section 15.407)			
FCC Clause	Test Item	Result	Remarks
15.207 15.407(b)(6)	AC Power Conducted Emissions	Pass	Meet the requirement of limit. Minimum passing margin is -10.54dB at 0.55234MHz.
15.407(b) (1/2/3/4/6)	Radiated Emissions & Band Edge Measurement	Pass	Meet the requirement of limit. Minimum passing margin is -1.0dB at 10360.00MHz and 11570.00MHz.
15.407(a)(1/2 /3)	Max Average Transmit Power	Pass	Meet the requirement of limit.
15.407(a)(1/2 /3)	Peak Power Spectral Density	Pass	Meet the requirement of limit.
15.407(e)	6dB bandwidth	Pass	Meet the requirement of limit. (U-NII-3 Band only)
15.407(g)	Frequency Stability	Pass	Meet the requirement of limit.
15.203	Antenna Requirement	Pass	Antenna connector is IPEX not a standard connector.

2.1 Measurement Uncertainty

Where relevant, the following measurement uncertainty levels have been estimated for tests performed on the EUT as specified in CISPR 16-4-2:

Measurement	Frequency	Expanded Uncertainty (k=2) (±)
Conducted Emissions at mains ports	150kHz ~ 30MHz	2.44 dB
Radiated Emissions up to 1 GHz	30MHz ~ 200MHz	3.86 dB
	200MHz ~ 1000MHz	3.87 dB
Radiated Emissions above 1 GHz	1GHz ~ 18GHz	2.29 dB
	18GHz ~ 40GHz	2.29 dB

2.2 Modification Record

There were no modifications required for compliance.

3 General Information

3.1 General Description of EUT

Product	Wireless a/b/g/n/AC Access Point
Brand	Open Mesh
Test Model	MR1750
Status of EUT	Engineering Sample
Power Supply Rating	12Vdc (Adapter) 48Vdc (PoE)
Modulation Type	64QAM, 16QAM, QPSK, BPSK for OFDM
Modulation Technology	OFDM
Transfer Rate	802.11a: 54.0/ 48.0/ 36.0/ 24.0/ 18.0/ 12.0/ 9.0/ 6.0Mbps 802.11n: up to 450.0Mbps 802.11ac: up to 1299.9Mbps
Operating Frequency	5180 ~ 5240MHz, 5745 ~ 5825MHz
Number of Channel	5180 ~ 5240MHz: 4 for 802.11a, 802.11n (HT20), 802.11ac (VHT20) 2 for 802.11n (HT40), 802.11ac (VHT40) 1 for 802.11ac (VHT80) 5745 ~ 5825MHz: 5 for 802.11a, 802.11n (HT20), 802.11ac (VHT20) 2 for 802.11n (HT40), 802.11ac (VHT40) 1 for 802.11ac (VHT80)
Output Power	5180 ~ 5240MHz: 543.546mW 5745 ~ 5825MHz: 312.173mW
Antenna Type	PIFA antenna with 5.0dBi gain
Antenna Connector	IPEX
Accessory Device	Adapter
Data Cable Supplied	NA

Note:

1. This report is prepared for FCC class II permissive change.
2. This report is issued as a supplementary report to the original ADT report no.: RF140224C17D. The difference compared with the original report is updating U-NII-1 and U-NII-3 band to new rules. All test data had been re-tested.
3. The EUT incorporates a MIMO function. Physically, the EUT provides 3 completed transmitters and 3 receivers.

Modulation Mode	TX Function
802.11a	3TX
802.11n (HT20)	3TX
802.11n (HT40)	3TX
802.11ac (VHT20)	3TX
802.11ac (VHT40)	3TX
802.11ac (VHT80)	3TX

* The modulation and bandwidth are similar for 802.11n mode for HT20//HT40 and 802.11ac mode for VHT20/VHT40, therefore investigated worst case to representative mode in test report. (Final test mode refer section 3.2.1)

4. The EUT consumes power from the following adapter & PoE.

Adapter	
Brand:	Powertron Electronics Corp.
Model:	PA1024-2HUB PA1024-2HU PA1024-120HUB200
Input:	100-240Vac, 50-60Hz, 0.6A
Output:	12Vdc, 2.0A, 24W Max
Power Line:	1.50m non-shielded cable with one core

POE (Support units only)	
Brand:	EnGenius
Model:	NPE-5818
Output:	48Vdc, 0.5A
Adapter for POE (Support units only)	
Brand:	Powertron Electronics Corp.
Model:	PA1024-480DUB050
Input:	100-240V~50-60Hz 0.6A
Output:	48Vdc, 0.5A, 24W Max
Power Line:	1.55m non-shielded cable without core

3.2 Description of Test Modes

For 5180 ~ 5240MHz

4 channels are provided for 802.11a, 802.11n (HT20), 802.11ac (VHT20):

Channel	Frequency	Channel	Frequency
36	5180 MHz	44	5220 MHz
40	5200 MHz	48	5240 MHz

2 channels are provided for 802.11n (HT40), 802.11ac (VHT40):

Channel	Frequency	Channel	Frequency
38	5190 MHz	46	5230 MHz

1 channel is provided for 802.11ac (VHT80):

Channel	Frequency
42	5210MHz

For 5745 ~ 5825MHz:

5 channels are provided for 802.11a, 802.11n (HT20), 802.11ac (VHT20):

Channel	Frequency	Channel	Frequency
149	5745MHz	161	5805MHz
153	5765MHz	165	5825MHz
157	5785MHz		

2 channels are provided for 802.11n (HT40), 802.11ac (VHT40):

Channel	Frequency	Channel	Frequency
151	5755MHz	159	5795MHz

1 channel is provided for 802.11ac (VHT80):

Channel	Frequency
155	5775MHz

3.2.1 Test Mode Applicability and Tested Channel Detail

EUT CONFIGURE MODE	APPLICABLE TO				DESCRIPTION
	RE \geq 1G	RE<1G	PLC	APCM	
A	√	√	√	√	Power from adapter
B	-	√	√	-	Power from PoE

Where **RE \geq 1G**: Radiated Emission above 1GHz & Bandedge Measurement
RE<1G: Radiated Emission below 1GHz
PLC: Power Line Conducted Emission
APCM: Antenna Port Conducted Measurement

Note:

1. The EUT had been pre-tested on the positioned of each 3 axis. The worst case was found when positioned on **Z-plane**.
2. "-" means no effect.

Radiated Emission Test (Above 1GHz):

- Pre-Scan has been conducted to determine the worst-case mode from all possible combinations between available modulations, data rates and antenna ports (if EUT with antenna diversity architecture).
- Following channel(s) was (were) selected for the final test as listed below.

EUT CONFIGURE MODE	MODE	FREQ. BAND (MHz)	AVAILABLE CHANNEL	TESTED CHANNEL	MODULATION TECHNOLOGY	MODULATION TYPE	DATA RATE (Mbps)
A	802.11a	5180-5240	36 to 48	36, 40, 48	OFDM	BPSK	6.0
A	802.11n (HT20)		36 to 48	36, 40, 48	OFDM	BPSK	7.2
A	802.11n (HT40)		38 to 46	38, 46	OFDM	BPSK	15.0
A	802.11ac (VHT80)		42	42	OFDM	BPSK	97.5
A	802.11a	5745-5825	149 to 165	149, 157, 165	OFDM	BPSK	6.0
A	802.11n (HT20)		149 to 165	149, 157, 165	OFDM	BPSK	7.2
A	802.11n (HT40)		151 to 159	151, 159	OFDM	BPSK	15.0
A	802.11ac (VHT80)		155	155	OFDM	BPSK	97.5

Radiated Emission Test (Below 1GHz):

- Pre-Scan has been conducted to determine the worst-case mode from all possible combinations between available modulations, data rates and antenna ports (if EUT with antenna diversity architecture).
- Following channel(s) was (were) selected for the final test as listed below.

EUT CONFIGURE MODE	MODE	FREQ. BAND (MHz)	AVAILABLE CHANNEL	TESTED CHANNEL	MODULATION TECHNOLOGY	MODULATION TYPE	DATA RATE (Mbps)
A,B	802.11a	5180-5240	36 to 48	36	OFDM	BPSK	6.0
	802.11a	5745-5825	149 to 165		OFDM	BPSK	6.0

Power Line Conducted Emission Test:

- Pre-Scan has been conducted to determine the worst-case mode from all possible combinations between available modulations, data rates and antenna ports (if EUT with antenna diversity architecture).
- Following channel(s) was (were) selected for the final test as listed below.

EUT CONFIGURE MODE	MODE	FREQ. BAND (MHz)	AVAILABLE CHANNEL	TESTED CHANNEL	MODULATION TECHNOLOGY	MODULATION TYPE	DATA RATE (Mbps)
A,B	802.11a	5180-5240	36 to 48	36	OFDM	BPSK	6.0
	802.11a	5745-5825	149 to 165		OFDM	BPSK	6.0

Antenna Port Conducted Measurement:

- This item includes all test value of each mode, but only includes spectrum plot of worst value of each mode.
- Pre-Scan has been conducted to determine the worst-case mode from all possible combinations between available modulations, data rates and antenna ports (if EUT with antenna diversity architecture).
- Following channel(s) was (were) selected for the final test as listed below.

EUT CONFIGURE MODE	MODE	FREQ. BAND (MHz)	AVAILABLE CHANNEL	TESTED CHANNEL	MODULATION TECHNOLOGY	MODULATION TYPE	DATA RATE (Mbps)
A	802.11a	5180-5240	36 to 48	36, 40, 48	OFDM	BPSK	6.0
A	802.11n (HT20)		36 to 48	36, 40, 48	OFDM	BPSK	7.2
A	802.11n (HT40)		38 to 46	38, 46	OFDM	BPSK	15.0
A	802.11ac (VHT80)		42	42	OFDM	BPSK	97.5
A	802.11a	5745-5825	149 to 165	149, 157, 165	OFDM	BPSK	6.0
A	802.11n (HT20)		149 to 165	149, 157, 165	OFDM	BPSK	7.2
A	802.11n (HT40)		151 to 159	151, 159	OFDM	BPSK	15.0
A	802.11ac (VHT80)		155	155	OFDM	BPSK	97.5

Test Condition:

APPLICABLE TO	ENVIRONMENTAL CONDITIONS	INPUT POWER	TESTED BY
RE \geq 1G	20deg. C, 64%RH	120Vac, 60Hz	Jones Chang
RE<1G	20deg. C, 64%RH	120Vac, 60Hz 48Vdc	Jones Chang
PLC	24deg. C, 70%RH	120Vac, 60Hz 48Vdc	Jones Chang
APCM	25deg. C, 60%RH	120Vac, 60Hz	Cedric Wu

3.3 Duty Cycle of Test Signal

Duty cycle of test signal is < 98 %, duty factor is required.

802.11a: Duty cycle = $2.015/2.110 = 0.955$, Duty factor = $10 * \log(1/0.955) = 0.20$

802.11n (HT20): Duty cycle = $1.867/2.047 = 0.912$, Duty factor = $10 * \log(1/0.912) = 0.40$

802.11n (HT40): Duty cycle = $0.915/0.997 = 0.918$, Duty factor = $10 * \log(1/0.918) = 0.37$

802.11ac (VHT80): Duty cycle = $0.447/0.530 = 0.843$, Duty factor = $10 * \log(1/0.843) = 0.74$

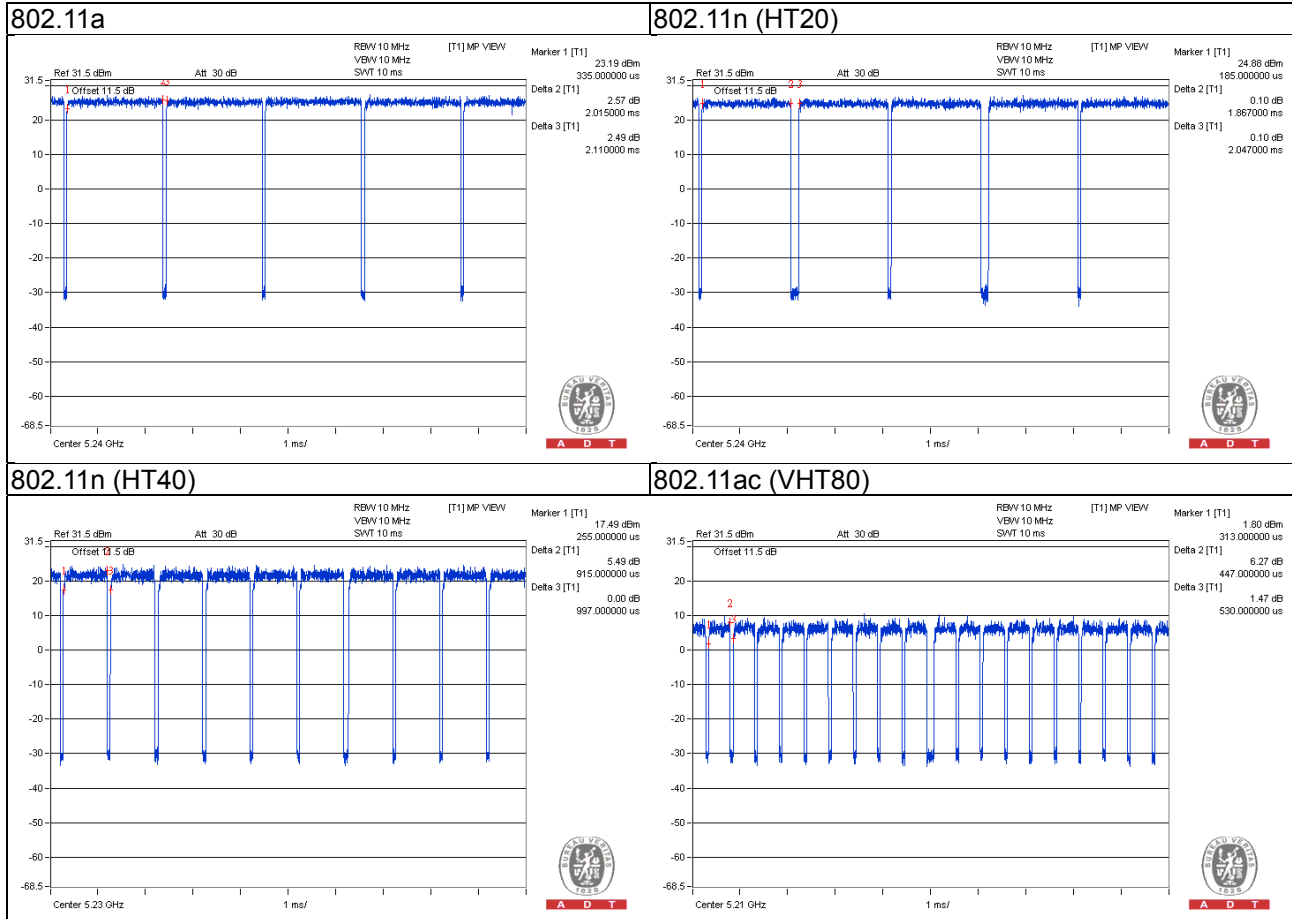

3.4 Description of Support Units

The EUT has been tested as an independent unit together with other necessary accessories or support units. The following support units or accessories were used to form a representative test configuration during the tests.

ID	Product	Brand	Model No.	Serial No.	FCC ID	Remarks
A.	Notebook	DELL	E5410	1HC2XM1	FCC DoC Approved	-
B.	POE	EnGenius	NPE-5818	NA	NA	For test mode B only
C.	Adapter	Powertron Electronics Corp.	PA1024-480DUB050	NA	NA	For test mode B only

Note:

1. All power cords of the above support units are non-shielded (1.8m).
2. Items A acted as communication partners to transfer data.

ID	Descriptions	Qty.	Length (m)	Shielding (Yes/No)	Cores (Qty.)	Remarks
1.	LAN cable	1	10	N	0	-
2.	LAN cable	1	1.8	N	0	For test mode B only
3.	DC power cable	1	1.55	N	0	Attached on the adapter For test mode B only

3.4.1 Configuration of System under Test

Test Mode A

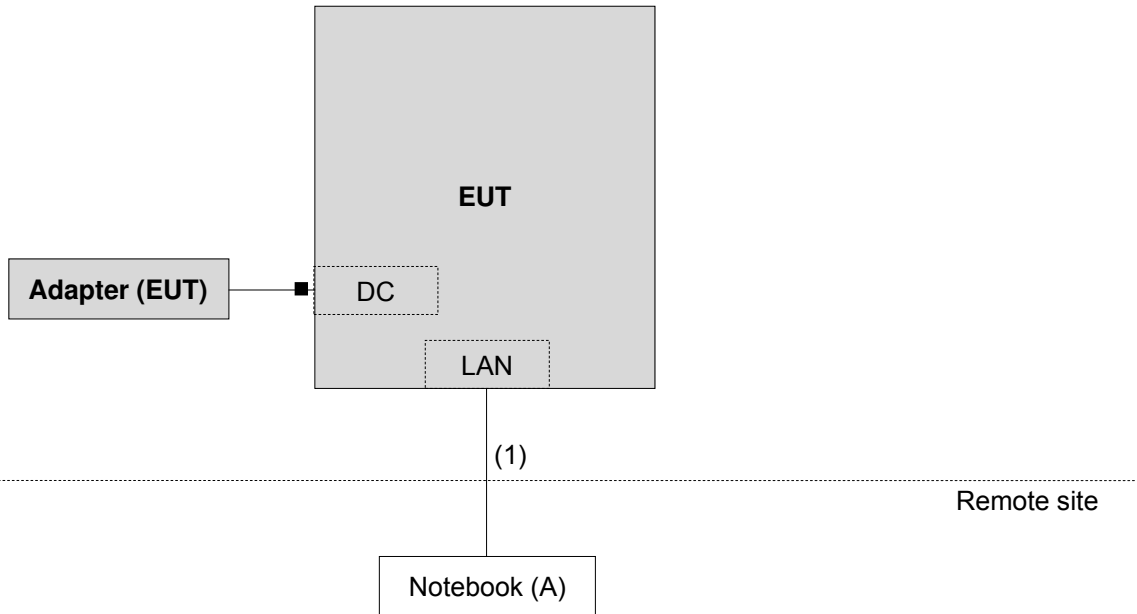

Test Mode B

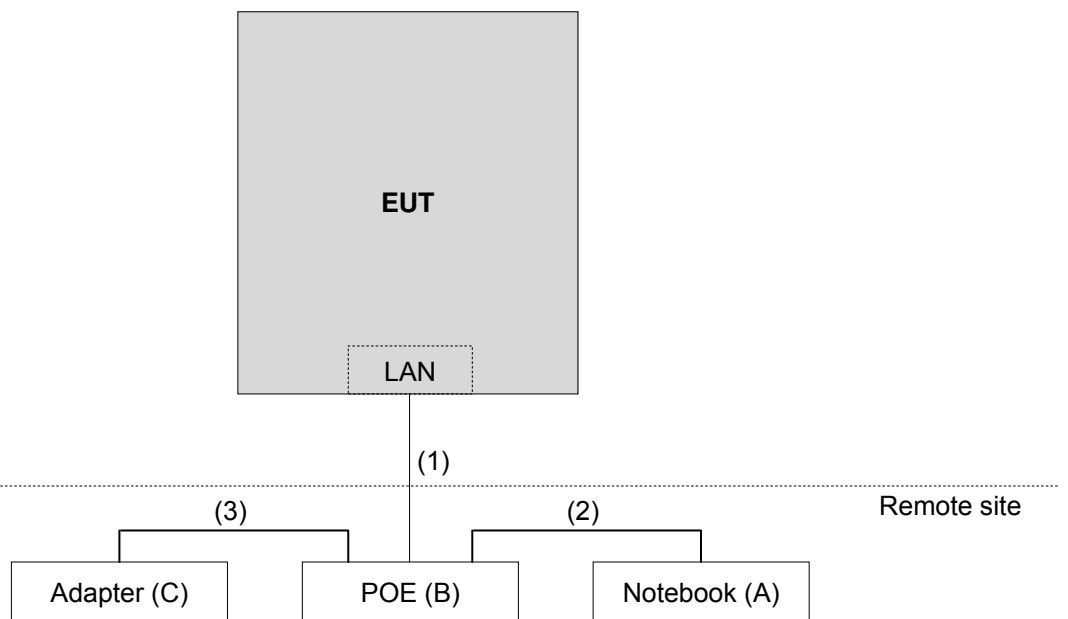

3.5 General Description of Applied Standards

The EUT is a RF Product. According to the specifications of the manufacturer, it must comply with the requirements of the following standards:

FCC Part 15, Subpart E (15.407)

789033 D02 General UNII Test Procedures New Rules v01r01

662911 D01 Multiple Transmitter Output v02r01

ANSI C63.10-2013

All test items have been performed and recorded as per the above standards.

Note: The EUT is also considered as a kind of computer peripheral, because the connection to computer is necessary for typical use. It has been verified to comply with the requirements of FCC Part 15, Subpart B, Class B (DoC). The test report has been issued separately.

4 Test Types and Results

4.1 Radiated Emission and Bandedge Measurement

4.1.1 Limits of Radiated Emission and Bandedge Measurement

Radiated emissions which fall in the restricted bands must comply with the radiated emission limits specified as below table.

Frequencies (MHz)	Field Strength (microvolts/meter)	Measurement Distance (meters)
0.009 ~ 0.490	2400/F(kHz)	300
0.490 ~ 1.705	24000/F(kHz)	30
1.705 ~ 30.0	30	30
30 ~ 88	100	3
88 ~ 216	150	3
216 ~ 960	200	3
Above 960	500	3

NOTE:

1. The lower limit shall apply at the transition frequencies.
2. Emission level (dBuV/m) = 20 log Emission level (uV/m).
3. For frequencies above 1000MHz, the field strength limits are based on average detector, however, the peak field strength of any emission shall not exceed the maximum permitted average limits, specified above by more than 20dB under any condition of modulation.

LIMITS OF UNWANTED EMISSION OUT OF THE RESTRICTED BANDS

APPLICABLE TO	LIMIT	
789033 D02 General UNII Test Procedures New Rules v01r01	FIELD STRENGTH AT 3m	
	PK:74 (dBuV/m)	AV:54 (dBuV/m)
APPLICABLE TO	EIRP LIMIT	EQUIVALENT FIELD STRENGTH AT 3m
15.407(b)(1)	PK:-27 (dBm/MHz)	PK:68.2 (dBuV/m)
15.407(b)(2)		
15.407(b)(3)		
15.407(b)(4)	PK:-27 (dBm/MHz) ^{*1} PK:-17 (dBm/MHz) ^{*2}	PK: 68.2 (dBuV/m) ^{*1} PK: 78.2 (dBuV/m) ^{*2}

NOTE: ^{*1} beyond 10MHz of the band edge ^{*2} within 10 MHz of band edge

The following formula is used to convert the equipment isotropic radiated power (eirp) to field strength:

$$E = \frac{1000000 \sqrt{30P}}{3} \mu\text{V/m, where P is the eirp (Watts).}$$



4.1.2 Test Instruments

Description & Manufacturer	Model No.	Serial No.	Cal. Date	Cal. Due
Test Receiver ROHDE & SCHWARZ	ESIB7	100187	Apr. 10, 2015	Apr. 09, 2016
Spectrum Analyzer ROHDE & SCHWARZ	FSP40	100041	Sep. 02, 2015	Sep. 01, 2016
BILOG Antenna SCHWARZBECK	VULB9168	9168-151	Jan. 07, 2016	Jan. 06, 2017
HORN Antenna SCHWARZBECK	9120D	209	Jan. 20, 2016	Jan. 19, 2017
HORN Antenna SCHWARZBECK	BBHA 9170	BBHA9170241	Jan. 18, 2016	Jan. 17, 2017
Preamplifier Agilent	8447D	2944A10738	Oct. 18, 2015	Oct. 17, 2016
Preamplifier Agilent	8449B	3008A01964	Aug. 22, 2015	Aug. 21, 2016
RF signal cable HUBER+SUHNER	SUCOFLEX 104	Cable-CH3-03 (214378)	Aug. 22, 2015	Aug. 21, 2016
RF signal cable HUBER+SUHNER	SUCOFLEX 106	Cable-CH3-03 (309224+12738)	Aug. 22, 2015	Aug. 21, 2016
Software BV ADT	ADT_Radiated_ V7.6.15.9.4	NA	NA	NA
Antenna Tower inn-co GmbH	MA 4000	013303	NA	NA
Antenna Tower Controller BV ADT	AT100	AT93021702	NA	NA
Turn Table BV ADT	TT100	TT93021702	NA	NA
Turn Table Controller BV ADT	SC100	SC93021702	NA	NA
26GHz ~ 40GHz Amplifier	EM26400	815221	Oct. 18, 2015	Oct. 17, 2016
High Speed Peak Power Meter	ML2495A	0824011	Jul. 09, 2015	Jul. 08, 2016
Power Sensor	MA2411B	0738171	Jul. 09, 2015	Jul. 08, 2016
WIT Standard Temperature And Humidity Chamber	TH-4S-C	W981030	Jun. 08, 2015	Jun. 07, 2016

- Note: 1. The calibration interval of the above test instruments is 12 months and the calibrations are traceable to NML/ROC and NIST/USA.
2. The test was performed in HwaYa Chamber 3.
3. The horn antenna and preamplifier (model: 8449B) are used only for the measurement of emission frequency above 1GHz if tested.
4. The FCC Site Registration No. is 988962.
5. The IC Site Registration No. is IC 7450F-3.

4.1.3 Test Procedures

- a. The EUT was placed on the top of a rotating table 0.8 meters (for below 1GHz) / 1.5 meters (for above 1GHz) above the ground at 3 meter chamber room for test. The table was rotated 360 degrees to determine the position of the highest radiation.
- b. The EUT was set 3 meters away from the interference-receiving antenna, which was mounted on the top of a variable-height antenna tower.
- c. The height of antenna is varied from one meter to four meters above the ground to determine the maximum value of the field strength. Both horizontal and vertical polarizations of the antenna are set to make the measurement.
- d. For each suspected emission, the EUT was arranged to its worst case and then the antenna was tuned to heights from 1 meter to 4 meters and the rotatable table was turned from 0 degrees to 360 degrees to find the maximum reading.
- e. The test-receiver system was set to quasi-peak detect function and specified bandwidth with maximum hold mode when the test frequency is below 1 GHz.
- f. The test-receiver system was set to peak and average detect function and specified bandwidth with maximum hold mode when the test frequency is above 1 GHz. If the peak reading value also meets average limit, measurement with the average detector is unnecessary.

Note:

1. The resolution bandwidth and video bandwidth of test receiver/spectrum analyzer is 120kHz for Quasi-peak detection (QP) at frequency below 1GHz.
2. The resolution bandwidth of test receiver/spectrum analyzer is 1 MHz and the video bandwidth is 3 MHz for Peak detection (PK) at frequency above 1GHz.
3. The resolution bandwidth of test receiver/spectrum analyzer is 1MHz and the video bandwidth is 3MHz for RMS Average (Duty cycle < 98%) for Average detection (AV) at frequency above 1GHz, then the measurement results was added to a correction factor ($10 \log(1/\text{duty cycle})$).
4. The resolution bandwidth of test receiver/spectrum analyzer is 1MHz and the video bandwidth is 10Hz (Duty cycle $\geq 98\%$) for Average detection (AV) at frequency above 1GHz.
5. All modes of operation were investigated and the worst-case emissions are reported.

4.1.4 Deviation from Test Standard

No deviation.

4.1.5 Test Set Up

<Frequency Range below 1GHz>

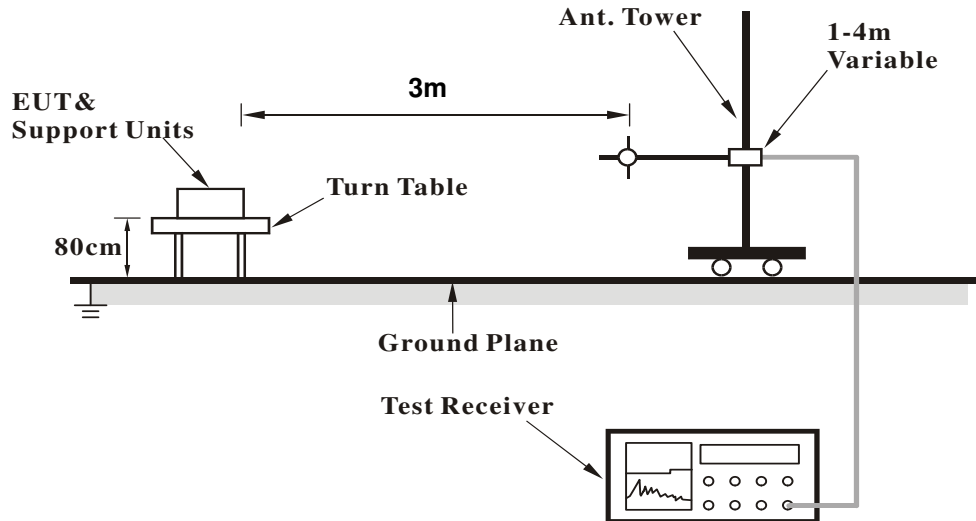

<Frequency Range above 1GHz>

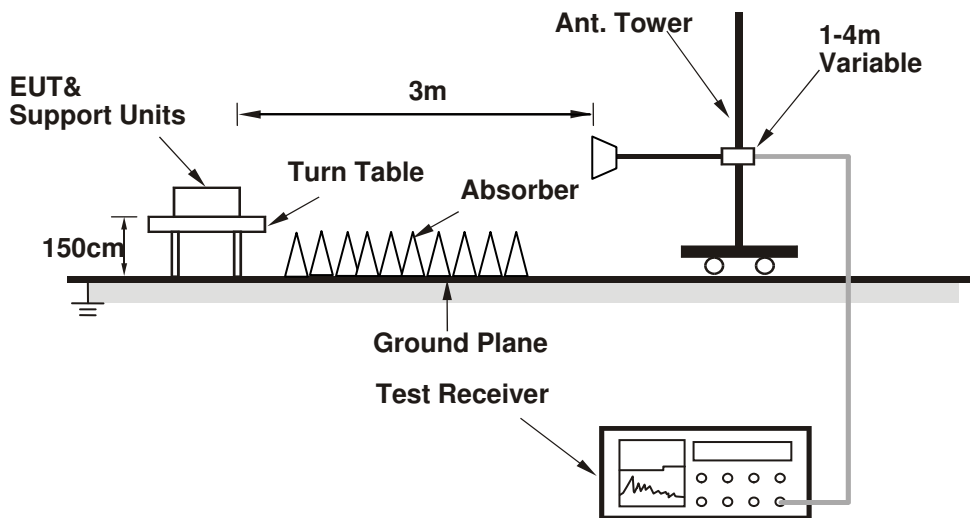

For the actual test configuration, please refer to the attached file (Test Setup Photo)

4.1.6 EUT Operating Conditions

- Placed the EUT on the testing table.
- Prepared notebook to act as communication partner and placed it outside of testing area.
- The communication partner connected with EUT via a RJ45 cable and ran a test program (provided by manufacturer) to enable EUT under transmission condition continuously at specific channel frequency.
- The communication partner sent data to EUT by command "PING".

4.1.7 Test Results

Above 1GHz Worst-Case Data:

802.11a

CHANNEL	TX Channel 36	DETECTOR FUNCTION	Peak (PK)
FREQUENCY RANGE	1GHz ~ 40GHz		Average (AV)

ANTENNA POLARITY & TEST DISTANCE: HORIZONTAL AT 3 M								
NO.	FREQ. (MHz)	EMISSION LEVEL (dBuV/m)	LIMIT (dBuV/m)	MARGIN (dB)	ANTENNA HEIGHT (m)	TABLE ANGLE (Degree)	RAW VALUE (dBuV)	CORRECTION FACTOR (dB/m)
1	5150.00	70.7 PK	74.0	-3.3	2.59 H	19	64.50	6.20
2	5150.00	52.1 AV	54.0	-1.9	2.59 H	19	45.90	6.20
3	*5180.00	119.8 PK			2.10 H	43	80.30	39.50
4	*5180.00	109.7 AV			2.10 H	43	70.20	39.50
5	#10360.00	70.1 PK	74.0	-3.9	2.16 H	342	53.10	17.00
6	#10360.00	49.3 AV	54.0	-4.7	2.16 H	342	32.30	17.00
ANTENNA POLARITY & TEST DISTANCE: VERTICAL AT 3 M								
NO.	FREQ. (MHz)	EMISSION LEVEL (dBuV/m)	LIMIT (dBuV/m)	MARGIN (dB)	ANTENNA HEIGHT (m)	TABLE ANGLE (Degree)	RAW VALUE (dBuV)	CORRECTION FACTOR (dB/m)
1	5150.00	65.7 PK	74.0	-8.3	2.78 V	322	59.50	6.20
2	5150.00	49.8 AV	54.0	-4.2	2.78 V	322	43.60	6.20
3	*5180.00	115.6 PK			2.10 V	324	76.10	39.50
4	*5180.00	105.9 AV			2.10 V	324	66.40	39.50
5	#10360.00	73.0 PK	74.0	-1.0	1.91 V	311	56.00	17.00
6	#10360.00	50.5 AV	54.0	-3.5	1.91 V	311	33.50	17.00

Remarks:

1. Emission Level(dBuV/m) = Raw Value(dBuV) + Correction Factor(dB/m)
2. Correction Factor(dB/m) = Antenna Factor(dB/m) + Cable Factor(dB)
3. The other emission levels were very low against the limit.
4. Margin value = Emission Level – Limit value
5. " * ": Fundamental frequency.
6. " # ": The radiated frequency is out of the restricted band.

CHANNEL	TX Channel 40	DETECTOR FUNCTION	Peak (PK)
FREQUENCY RANGE	1GHz ~ 40GHz		Average (AV)

ANTENNA POLARITY & TEST DISTANCE: HORIZONTAL AT 3 M								
NO.	FREQ. (MHz)	EMISSION LEVEL (dBuV/m)	LIMIT (dBuV/m)	MARGIN (dB)	ANTENNA HEIGHT (m)	TABLE ANGLE (Degree)	RAW VALUE (dBuV)	CORRECTION FACTOR (dB/m)
1	5150.00	62.7 PK	74.0	-11.3	2.40 H	252	56.70	6.00
2	5150.00	48.9 AV	54.0	-5.1	2.40 H	252	42.90	6.00
3	*5200.00	122.3 PK			2.18 H	42	82.80	39.50
4	*5200.00	111.9 AV			2.18 H	42	72.40	39.50
5	#10400.00	70.1 PK	74.0	-3.9	2.11 H	345	52.40	17.70
6	#10400.00	48.5 AV	54.0	-5.5	2.11 H	345	30.80	17.70
ANTENNA POLARITY & TEST DISTANCE: VERTICAL AT 3 M								
NO.	FREQ. (MHz)	EMISSION LEVEL (dBuV/m)	LIMIT (dBuV/m)	MARGIN (dB)	ANTENNA HEIGHT (m)	TABLE ANGLE (Degree)	RAW VALUE (dBuV)	CORRECTION FACTOR (dB/m)
1	5150.00	56.9 PK	74.0	-17.1	1.44 V	263	50.90	6.00
2	5150.00	45.9 AV	54.0	-8.1	1.44 V	263	39.90	6.00
3	*5200.00	116.9 PK			2.20 V	337	77.40	39.50
4	*5200.00	106.5 AV			2.20 V	337	67.00	39.50
5	#10400.00	72.3 PK	74.0	-1.7	2.19 V	315	54.60	17.70
6	#10400.00	49.9 AV	54.0	-4.1	2.19 V	315	32.20	17.70

Remarks:

1. Emission Level(dBuV/m) = Raw Value(dBuV) + Correction Factor(dB/m)
2. Correction Factor(dB/m) = Antenna Factor(dB/m) + Cable Factor(dB)
3. The other emission levels were very low against the limit.
4. Margin value = Emission Level – Limit value
5. " * ": Fundamental frequency.
6. " # ": The radiated frequency is out of the restricted band.

CHANNEL	TX Channel 48	DETECTOR FUNCTION	Peak (PK)
FREQUENCY RANGE	1GHz ~ 40GHz		Average (AV)

ANTENNA POLARITY & TEST DISTANCE: HORIZONTAL AT 3 M								
NO.	FREQ. (MHz)	EMISSION LEVEL (dBuV/m)	LIMIT (dBuV/m)	MARGIN (dB)	ANTENNA HEIGHT (m)	TABLE ANGLE (Degree)	RAW VALUE (dBuV)	CORRECTION FACTOR (dB/m)
1	5080.00	63.8 PK	74.0	-10.2	1.96 H	45	58.00	5.80
2	5080.00	49.6 AV	54.0	-4.4	1.96 H	45	43.80	5.80
3	*5240.00	123.9 PK			1.82 H	51	84.30	39.60
4	*5240.00	113.6 AV			1.82 H	51	74.00	39.60
5	5400.00	62.7 PK	74.0	-11.3	1.86 H	32	56.00	6.70
6	5400.00	50.0 AV	54.0	-4.0	1.86 H	32	43.30	6.70
7	#10480.00	71.6 PK	74.0	-2.4	2.35 H	339	52.90	18.70
8	#10480.00	48.8 AV	54.0	-5.2	2.35 H	339	30.10	18.70
ANTENNA POLARITY & TEST DISTANCE: VERTICAL AT 3 M								
NO.	FREQ. (MHz)	EMISSION LEVEL (dBuV/m)	LIMIT (dBuV/m)	MARGIN (dB)	ANTENNA HEIGHT (m)	TABLE ANGLE (Degree)	RAW VALUE (dBuV)	CORRECTION FACTOR (dB/m)
1	*5240.00	119.6 PK			2.00 V	336	80.00	39.60
2	*5240.00	109.3 AV			2.00 V	336	69.70	39.60
3	5350.00	60.6 PK	74.0	-13.4	2.00 V	60	54.10	6.50
4	5350.00	47.5 AV	54.0	-6.5	2.00 V	60	41.00	6.50
5	#10480.00	72.1 PK	74.0	-1.9	1.89 V	314	53.40	18.70
6	#10480.00	50.7 AV	54.0	-3.3	1.89 V	314	32.00	18.70

Remarks:

1. Emission Level(dBuV/m) = Raw Value(dBuV) + Correction Factor(dB/m)
2. Correction Factor(dB/m) = Antenna Factor(dB/m) + Cable Factor(dB)
3. The other emission levels were very low against the limit.
4. Margin value = Emission Level – Limit value
5. " * ": Fundamental frequency.
6. " # ": The radiated frequency is out of the restricted band.

CHANNEL	TX Channel 149	DETECTOR FUNCTION	Peak (PK)
FREQUENCY RANGE	1GHz ~ 40GHz		Average (AV)

ANTENNA POLARITY & TEST DISTANCE: HORIZONTAL AT 3 M

NO.	FREQ. (MHz)	EMISSION LEVEL (dBuV/m)	LIMIT (dBuV/m)	MARGIN (dB)	ANTENNA HEIGHT (m)	TABLE ANGLE (Degree)	RAW VALUE (dBuV)	CORRECTION FACTOR (dB/m)
1	#5714.00	70.6 PK	74.0	-3.4	2.10 H	278	63.40	7.20
2	#5714.00	52.2 AV	54.0	-1.8	2.10 H	278	45.00	7.20
3	#5722.00	75.0 PK	78.2	-3.2	2.08 H	279	67.80	7.20
4	#5725.00	65.0 PK	78.2	-13.2	2.08 H	279	57.80	7.20
5	*5745.00	120.4 PK			2.56 H	295	80.00	40.40
6	*5745.00	110.5 AV			2.56 H	295	70.10	40.40
7	11490.00	65.4 PK	74.0	-8.6	1.66 H	49	47.10	18.30
8	11490.00	51.6 AV	54.0	-2.4	1.66 H	49	33.30	18.30

ANTENNA POLARITY & TEST DISTANCE: VERTICAL AT 3 M

NO.	FREQ. (MHz)	EMISSION LEVEL (dBuV/m)	LIMIT (dBuV/m)	MARGIN (dB)	ANTENNA HEIGHT (m)	TABLE ANGLE (Degree)	RAW VALUE (dBuV)	CORRECTION FACTOR (dB/m)
1	#5714.00	69.8 PK	74.0	-4.2	2.89 V	339	62.60	7.20
2	#5714.00	52.8 AV	54.0	-1.2	2.89 V	339	45.60	7.20
3	#5722.00	76.6 PK	78.2	-1.6	2.74 V	338	69.40	7.20
4	#5725.00	65.0 PK	78.2	-13.2	2.74 V	338	57.80	7.20
5	*5745.00	115.9 PK			2.87 V	0	75.50	40.40
6	*5745.00	105.6 AV			2.87 V	0	65.20	40.40
7	11490.00	67.8 PK	74.0	-6.2	2.10 V	0	49.50	18.30
8	11490.00	52.2 AV	54.0	-1.8	2.10 V	0	33.90	18.30

Remarks:

1. Emission Level(dBuV/m) = Raw Value(dBuV) + Correction Factor(dB/m)
2. Correction Factor(dB/m) = Antenna Factor(dB/m) + Cable Factor(dB)
3. The other emission levels were very low against the limit.
4. Margin value = Emission Level – Limit value
5. " * ": Fundamental frequency.
6. " # ": The radiated frequency is out of the restricted band.

CHANNEL	TX Channel 157	DETECTOR FUNCTION	Peak (PK)
FREQUENCY RANGE	1GHz ~ 40GHz		Average (AV)

ANTENNA POLARITY & TEST DISTANCE: HORIZONTAL AT 3 M

NO.	FREQ. (MHz)	EMISSION LEVEL (dBuV/m)	LIMIT (dBuV/m)	MARGIN (dB)	ANTENNA HEIGHT (m)	TABLE ANGLE (Degree)	RAW VALUE (dBuV)	CORRECTION FACTOR (dB/m)
1	*5785.00	120.2 PK			2.60 H	306	79.70	40.50
2	*5785.00	110.1 AV			2.60 H	306	69.60	40.50
3	11570.00	65.0 PK	74.0	-9.0	1.80 H	349	46.80	18.20
4	11570.00	52.0 AV	54.0	-2.0	1.80 H	349	33.80	18.20

ANTENNA POLARITY & TEST DISTANCE: VERTICAL AT 3 M

NO.	FREQ. (MHz)	EMISSION LEVEL (dBuV/m)	LIMIT (dBuV/m)	MARGIN (dB)	ANTENNA HEIGHT (m)	TABLE ANGLE (Degree)	RAW VALUE (dBuV)	CORRECTION FACTOR (dB/m)
1	*5785.00	115.9 PK			2.66 V	312	75.40	40.50
2	*5785.00	106.2 AV			2.66 V	312	65.70	40.50
3	11570.00	67.5 PK	74.0	-6.5	1.70 V	319	49.30	18.20
4	11570.00	52.2 AV	54.0	-1.8	1.70 V	319	34.00	18.20

Remarks:

1. Emission Level(dBuV/m) = Raw Value(dBuV) + Correction Factor(dB/m)
2. Correction Factor(dB/m) = Antenna Factor(dB/m) + Cable Factor(dB)
3. The other emission levels were very low against the limit.
4. Margin value = Emission Level – Limit value
5. " * ": Fundamental frequency.

CHANNEL	TX Channel 165	DETECTOR FUNCTION	Peak (PK)
FREQUENCY RANGE	1GHz ~ 40GHz		Average (AV)

ANTENNA POLARITY & TEST DISTANCE: HORIZONTAL AT 3 M

NO.	FREQ. (MHz)	EMISSION LEVEL (dBuV/m)	LIMIT (dBuV/m)	MARGIN (dB)	ANTENNA HEIGHT (m)	TABLE ANGLE (Degree)	RAW VALUE (dBuV)	CORRECTION FACTOR (dB/m)
1	*5825.00	120.0 PK			2.46 H	306	79.50	40.50
2	*5825.00	109.6 AV			2.46 H	306	69.10	40.50
3	#5850.00	59.0 PK	78.2	-19.2	2.50 H	303	51.50	7.50
4	#5853.00	71.2 PK	78.2	-7.0	2.50 H	303	63.60	7.60
5	#5861.00	66.9 PK	74.0	-7.1	2.47 H	300	59.30	7.60
6	#5861.00	51.7 AV	54.0	-2.3	2.47 H	300	44.10	7.60
7	11650.00	65.4 PK	74.0	-8.6	1.98 H	339	46.70	18.70
8	11650.00	52.6 AV	54.0	-1.4	1.98 H	339	33.90	18.70

ANTENNA POLARITY & TEST DISTANCE: VERTICAL AT 3 M

NO.	FREQ. (MHz)	EMISSION LEVEL (dBuV/m)	LIMIT (dBuV/m)	MARGIN (dB)	ANTENNA HEIGHT (m)	TABLE ANGLE (Degree)	RAW VALUE (dBuV)	CORRECTION FACTOR (dB/m)
1	*5825.00	117.0 PK			2.92 V	344	76.50	40.50
2	*5825.00	106.9 AV			2.92 V	344	66.40	40.50
3	#5850.00	56.5 PK	78.2	-21.7	3.00 V	345	49.00	7.50
4	#5853.00	68.5 PK	78.2	-9.7	3.00 V	345	60.90	7.60
5	#5861.00	64.5 PK	74.0	-9.5	3.14 V	344	56.90	7.60
6	#5861.00	48.9 AV	54.0	-5.1	3.14 V	344	41.30	7.60
7	11650.00	65.8 PK	74.0	-8.2	2.21 V	0	47.10	18.70
8	11650.00	52.3 AV	54.0	-1.7	2.21 V	0	33.60	18.70

Remarks:

1. Emission Level(dBuV/m) = Raw Value(dBuV) + Correction Factor(dB/m)
2. Correction Factor(dB/m) = Antenna Factor(dB/m) + Cable Factor(dB)
3. The other emission levels were very low against the limit.
4. Margin value = Emission Level – Limit value
5. " * ": Fundamental frequency.
6. " # ": The radiated frequency is out of the restricted band.

802.11n (HT20)

CHANNEL	TX Channel 36	DETECTOR FUNCTION	Peak (PK)
FREQUENCY RANGE	1GHz ~ 40GHz		Average (AV)

ANTENNA POLARITY & TEST DISTANCE: HORIZONTAL AT 3 M

NO.	FREQ. (MHz)	EMISSION LEVEL (dBuV/m)	LIMIT (dBuV/m)	MARGIN (dB)	ANTENNA HEIGHT (m)	TABLE ANGLE (Degree)	RAW VALUE (dBuV)	CORRECTION FACTOR (dB/m)
1	5150.00	67.3 PK	74.0	-6.7	2.70 H	19	61.30	6.00
2	5150.00	52.7 AV	54.0	-1.3	2.70 H	19	46.70	6.00
3	*5180.00	120.6 PK			1.83 H	42	81.20	39.40
4	*5180.00	109.8 AV			1.83 H	42	70.40	39.40
5	#10360.00	66.9 PK	74.0	-7.1	2.22 H	349	49.10	17.80
6	#10360.00	48.1 AV	54.0	-5.9	2.22 H	349	30.30	17.80

ANTENNA POLARITY & TEST DISTANCE: VERTICAL AT 3 M

NO.	FREQ. (MHz)	EMISSION LEVEL (dBuV/m)	LIMIT (dBuV/m)	MARGIN (dB)	ANTENNA HEIGHT (m)	TABLE ANGLE (Degree)	RAW VALUE (dBuV)	CORRECTION FACTOR (dB/m)
1	5150.00	63.2 PK	74.0	-10.8	1.97 V	319	57.20	6.00
2	5150.00	48.5 AV	54.0	-5.5	1.97 V	319	42.50	6.00
3	*5180.00	113.7 PK			2.08 V	323	74.30	39.40
4	*5180.00	103.7 AV			2.08 V	323	64.30	39.40
5	#10360.00	69.7 PK	74.0	-4.3	1.82 V	311	51.90	17.80
6	#10360.00	49.9 AV	54.0	-4.1	1.82 V	311	32.10	17.80

Remarks:

1. Emission Level(dBuV/m) = Raw Value(dBuV) + Correction Factor(dB/m)
2. Correction Factor(dB/m) = Antenna Factor(dB/m) + Cable Factor(dB)
3. The other emission levels were very low against the limit.
4. Margin value = Emission Level – Limit value
5. " * ": Fundamental frequency.
6. " # ": The radiated frequency is out of the restricted band.

CHANNEL	TX Channel 40	DETECTOR FUNCTION	Peak (PK)
FREQUENCY RANGE	1GHz ~ 40GHz		Average (AV)

ANTENNA POLARITY & TEST DISTANCE: HORIZONTAL AT 3 M

NO.	FREQ. (MHz)	EMISSION LEVEL (dBuV/m)	LIMIT (dBuV/m)	MARGIN (dB)	ANTENNA HEIGHT (m)	TABLE ANGLE (Degree)	RAW VALUE (dBuV)	CORRECTION FACTOR (dB/m)
1	5150.00	60.2 PK	74.0	-13.8	1.84 H	40	54.20	6.00
2	5150.00	49.8 AV	54.0	-4.2	1.84 H	40	43.80	6.00
3	*5200.00	122.9 PK			1.71 H	48	83.40	39.50
4	*5200.00	112.1 AV			1.71 H	48	72.60	39.50
5	#10400.00	71.4 PK	74.0	-2.6	1.84 H	348	53.70	17.70
6	#10400.00	51.0 AV	54.0	-3.0	1.84 H	348	33.30	17.70

ANTENNA POLARITY & TEST DISTANCE: VERTICAL AT 3 M

NO.	FREQ. (MHz)	EMISSION LEVEL (dBuV/m)	LIMIT (dBuV/m)	MARGIN (dB)	ANTENNA HEIGHT (m)	TABLE ANGLE (Degree)	RAW VALUE (dBuV)	CORRECTION FACTOR (dB/m)
1	5150.00	57.3 PK	74.0	-16.7	1.50 V	271	51.30	6.00
2	5150.00	46.1 AV	54.0	-7.9	1.50 V	271	40.10	6.00
3	*5200.00	116.8 PK			2.18 V	325	77.30	39.50
4	*5200.00	107.2 AV			2.18 V	325	67.70	39.50
5	#10400.00	72.4 PK	74.0	-1.6	1.95 V	319	54.70	17.70
6	#10400.00	50.9 AV	54.0	-3.1	1.95 V	319	33.20	17.70

Remarks:

1. Emission Level(dBuV/m) = Raw Value(dBuV) + Correction Factor(dB/m)
2. Correction Factor(dB/m) = Antenna Factor(dB/m) + Cable Factor(dB)
3. The other emission levels were very low against the limit.
4. Margin value = Emission Level – Limit value
5. " * ": Fundamental frequency.
6. " # ": The radiated frequency is out of the restricted band.

CHANNEL	TX Channel 48	DETECTOR FUNCTION	Peak (PK)
FREQUENCY RANGE	1GHz ~ 40GHz		Average (AV)

ANTENNA POLARITY & TEST DISTANCE: HORIZONTAL AT 3 M

NO.	FREQ. (MHz)	EMISSION LEVEL (dBuV/m)	LIMIT (dBuV/m)	MARGIN (dB)	ANTENNA HEIGHT (m)	TABLE ANGLE (Degree)	RAW VALUE (dBuV)	CORRECTION FACTOR (dB/m)
1	*5240.00	122.7 PK			2.32 H	57	83.10	39.60
2	*5240.00	112.3 AV			2.32 H	57	72.70	39.60
3	5360.00	65.4 PK	74.0	-8.6	2.00 H	330	58.90	6.50
4	5360.00	50.5 AV	54.0	-3.5	2.00 H	330	44.00	6.50
5	#10480.00	68.9 PK	74.0	-5.1	1.92 H	0	50.20	18.70
6	#10480.00	48.8 AV	54.0	-5.2	1.92 H	0	30.10	18.70

ANTENNA POLARITY & TEST DISTANCE: VERTICAL AT 3 M

NO.	FREQ. (MHz)	EMISSION LEVEL (dBuV/m)	LIMIT (dBuV/m)	MARGIN (dB)	ANTENNA HEIGHT (m)	TABLE ANGLE (Degree)	RAW VALUE (dBuV)	CORRECTION FACTOR (dB/m)
1	*5240.00	119.1 PK			2.01 V	346	79.50	39.60
2	*5240.00	109.2 AV			2.01 V	346	69.60	39.60
3	5400.00	60.2 PK	74.0	-13.8	2.05 V	340	53.50	6.70
4	5400.00	47.2 AV	54.0	-6.8	2.05 V	340	40.50	6.70
5	#10480.00	72.9 PK	74.0	-1.1	1.98 V	317	54.20	18.70
6	#10480.00	51.3 AV	54.0	-2.7	1.98 V	317	32.60	18.70

Remarks:

1. Emission Level(dBuV/m) = Raw Value(dBuV) + Correction Factor(dB/m)
2. Correction Factor(dB/m) = Antenna Factor(dB/m) + Cable Factor(dB)
3. The other emission levels were very low against the limit.
4. Margin value = Emission Level – Limit value
5. " * ": Fundamental frequency.
6. " # ": The radiated frequency is out of the restricted band.

CHANNEL	TX Channel 149	DETECTOR FUNCTION	Peak (PK)
FREQUENCY RANGE	1GHz ~ 40GHz		Average (AV)

ANTENNA POLARITY & TEST DISTANCE: HORIZONTAL AT 3 M

NO.	FREQ. (MHz)	EMISSION LEVEL (dBuV/m)	LIMIT (dBuV/m)	MARGIN (dB)	ANTENNA HEIGHT (m)	TABLE ANGLE (Degree)	RAW VALUE (dBuV)	CORRECTION FACTOR (dB/m)
1	#5714.00	68.3 PK	74.0	-5.7	2.10 H	284	61.10	7.20
2	#5714.00	52.4 AV	54.0	-1.6	2.10 H	284	45.20	7.20
3	#5722.00	74.4 PK	78.2	-3.8	2.14 H	299	67.20	7.20
4	#5725.00	63.3 PK	78.2	-14.9	2.14 H	299	56.10	7.20
5	*5745.00	119.2 PK			2.56 H	298	78.80	40.40
6	*5745.00	109.3 AV			2.56 H	298	68.90	40.40
7	11490.00	65.6 PK	74.0	-8.4	2.04 H	338	47.30	18.30
8	11490.00	50.3 AV	54.0	-3.7	2.04 H	338	32.00	18.30

ANTENNA POLARITY & TEST DISTANCE: VERTICAL AT 3 M

NO.	FREQ. (MHz)	EMISSION LEVEL (dBuV/m)	LIMIT (dBuV/m)	MARGIN (dB)	ANTENNA HEIGHT (m)	TABLE ANGLE (Degree)	RAW VALUE (dBuV)	CORRECTION FACTOR (dB/m)
1	#5714.00	65.5 PK	74.0	-8.5	2.91 V	343	58.30	7.20
2	#5714.00	49.8 AV	54.0	-4.2	2.91 V	343	42.60	7.20
3	#5722.00	69.0 PK	78.2	-9.2	2.75 V	340	61.80	7.20
4	#5725.00	60.7 PK	78.2	-17.5	2.75 V	340	53.50	7.20
5	*5745.00	118.0 PK			2.73 V	346	77.60	40.40
6	*5745.00	107.9 AV			2.73 V	346	67.50	40.40
7	11490.00	64.1 PK	74.0	-9.9	2.21 V	4	45.80	18.30
8	11490.00	49.8 AV	54.0	-4.2	2.21 V	4	31.50	18.30

Remarks:

1. Emission Level(dBuV/m) = Raw Value(dBuV) + Correction Factor(dB/m)
2. Correction Factor(dB/m) = Antenna Factor(dB/m) + Cable Factor(dB)
3. The other emission levels were very low against the limit.
4. Margin value = Emission Level – Limit value
5. " * ": Fundamental frequency.
6. " # ": The radiated frequency is out of the restricted band.

CHANNEL	TX Channel 157	DETECTOR FUNCTION	Peak (PK)
FREQUENCY RANGE	1GHz ~ 40GHz		Average (AV)

ANTENNA POLARITY & TEST DISTANCE: HORIZONTAL AT 3 M

NO.	FREQ. (MHz)	EMISSION LEVEL (dBuV/m)	LIMIT (dBuV/m)	MARGIN (dB)	ANTENNA HEIGHT (m)	TABLE ANGLE (Degree)	RAW VALUE (dBuV)	CORRECTION FACTOR (dB/m)
1	*5785.00	121.4 PK			2.52 H	290	80.90	40.50
2	*5785.00	111.4 AV			2.52 H	290	70.90	40.50
3	11570.00	66.5 PK	74.0	-7.5	2.09 H	340	48.30	18.20
4	11570.00	53.0 AV	54.0	-1.0	2.09 H	340	34.80	18.20

ANTENNA POLARITY & TEST DISTANCE: VERTICAL AT 3 M

NO.	FREQ. (MHz)	EMISSION LEVEL (dBuV/m)	LIMIT (dBuV/m)	MARGIN (dB)	ANTENNA HEIGHT (m)	TABLE ANGLE (Degree)	RAW VALUE (dBuV)	CORRECTION FACTOR (dB/m)
1	*5785.00	115.3 PK			2.71 V	346	74.80	40.50
2	*5785.00	106.0 AV			2.71 V	346	65.50	40.50
3	11570.00	67.1 PK	74.0	-6.9	1.75 V	345	48.90	18.20
4	11570.00	52.7 AV	54.0	-1.3	1.75 V	345	34.50	18.20

Remarks:

1. Emission Level(dBuV/m) = Raw Value(dBuV) + Correction Factor(dB/m)
2. Correction Factor(dB/m) = Antenna Factor(dB/m) + Cable Factor(dB)
3. The other emission levels were very low against the limit.
4. Margin value = Emission Level – Limit value
5. " * ": Fundamental frequency.
6. " # ": The radiated frequency is out of the restricted band.

CHANNEL	TX Channel 165	DETECTOR FUNCTION	Peak (PK)
FREQUENCY RANGE	1GHz ~ 40GHz		Average (AV)

ANTENNA POLARITY & TEST DISTANCE: HORIZONTAL AT 3 M

NO.	FREQ. (MHz)	EMISSION LEVEL (dBuV/m)	LIMIT (dBuV/m)	MARGIN (dB)	ANTENNA HEIGHT (m)	TABLE ANGLE (Degree)	RAW VALUE (dBuV)	CORRECTION FACTOR (dB/m)
1	*5825.00	120.0 PK			2.42 H	290	79.50	40.50
2	*5825.00	110.3 AV			2.42 H	290	69.80	40.50
3	#5850.00	58.8 PK	78.2	-19.4	2.52 H	299	51.30	7.50
4	#5853.00	69.2 PK	78.2	-9.0	2.52 H	299	61.60	7.60
5	#5861.00	65.2 PK	74.0	-8.8	2.39 H	291	57.60	7.60
6	#5861.00	51.3 AV	54.0	-2.7	2.39 H	291	43.70	7.60
7	11650.00	65.6 PK	74.0	-8.4	2.00 H	338	46.90	18.70
8	11650.00	52.7 AV	54.0	-1.3	2.00 H	338	34.00	18.70

ANTENNA POLARITY & TEST DISTANCE: VERTICAL AT 3 M

NO.	FREQ. (MHz)	EMISSION LEVEL (dBuV/m)	LIMIT (dBuV/m)	MARGIN (dB)	ANTENNA HEIGHT (m)	TABLE ANGLE (Degree)	RAW VALUE (dBuV)	CORRECTION FACTOR (dB/m)
1	*5825.00	116.3 PK			3.06 V	345	75.80	40.50
2	*5825.00	106.2 AV			3.06 V	345	65.70	40.50
3	#5850.00	56.0 PK	78.2	-22.2	2.99 V	346	48.50	7.50
4	#5853.00	66.7 PK	78.2	-11.5	2.99 V	346	59.10	7.60
5	#5861.00	62.8 PK	74.0	-11.2	2.91 V	352	55.20	7.60
6	#5861.00	48.1 AV	54.0	-5.9	2.91 V	352	40.50	7.60
7	11650.00	65.5 PK	74.0	-8.5	2.12 V	0	46.80	18.70
8	11650.00	52.2 AV	54.0	-1.8	2.12 V	0	33.50	18.70

Remarks:

1. Emission Level(dBuV/m) = Raw Value(dBuV) + Correction Factor(dB/m)
2. Correction Factor(dB/m) = Antenna Factor(dB/m) + Cable Factor(dB)
3. The other emission levels were very low against the limit.
4. Margin value = Emission Level – Limit value
5. " * ": Fundamental frequency.
6. " # ": The radiated frequency is out of the restricted band.

802.11n (HT40)

CHANNEL	TX Channel 38	DETECTOR FUNCTION	Peak (PK)
FREQUENCY RANGE	1GHz ~ 40GHz		Average (AV)

ANTENNA POLARITY & TEST DISTANCE: HORIZONTAL AT 3 M

NO.	FREQ. (MHz)	EMISSION LEVEL (dBuV/m)	LIMIT (dBuV/m)	MARGIN (dB)	ANTENNA HEIGHT (m)	TABLE ANGLE (Degree)	RAW VALUE (dBuV)	CORRECTION FACTOR (dB/m)
1	5150.00	66.7 PK	74.0	-7.3	1.86 H	36	60.70	6.00
2	5150.00	52.9 AV	54.0	-1.1	1.86 H	36	46.90	6.00
3	*5190.00	108.0 PK			2.24 H	287	68.60	39.40
4	*5190.00	99.9 AV			2.24 H	287	60.50	39.40
5	#10380.00	59.8 PK	74.0	-14.2	2.00 H	286	42.10	17.70
6	#10380.00	46.7 AV	54.0	-7.3	2.00 H	286	29.00	17.70

ANTENNA POLARITY & TEST DISTANCE: VERTICAL AT 3 M

NO.	FREQ. (MHz)	EMISSION LEVEL (dBuV/m)	LIMIT (dBuV/m)	MARGIN (dB)	ANTENNA HEIGHT (m)	TABLE ANGLE (Degree)	RAW VALUE (dBuV)	CORRECTION FACTOR (dB/m)
1	5150.00	59.6 PK	74.0	-14.4	2.26 V	329	53.60	6.00
2	5150.00	48.1 AV	54.0	-5.9	2.26 V	329	42.10	6.00
3	*5190.00	105.8 PK			2.07 V	321	66.40	39.40
4	*5190.00	96.6 AV			2.07 V	321	57.20	39.40
5	#10380.00	60.6 PK	74.0	-13.4	1.86 V	349	42.90	17.70
6	#10380.00	47.4 AV	54.0	-6.6	1.86 V	349	29.70	17.70

Remarks:

1. Emission Level(dBuV/m) = Raw Value(dBuV) + Correction Factor(dB/m)
2. Correction Factor(dB/m) = Antenna Factor(dB/m) + Cable Factor(dB)
3. The other emission levels were very low against the limit.
4. Margin value = Emission Level – Limit value
5. " * ": Fundamental frequency.
6. " # ": The radiated frequency is out of the restricted band.

CHANNEL	TX Channel 46	DETECTOR FUNCTION	Peak (PK)
FREQUENCY RANGE	1GHz ~ 40GHz		Average (AV)

ANTENNA POLARITY & TEST DISTANCE: HORIZONTAL AT 3 M

NO.	FREQ. (MHz)	EMISSION LEVEL (dBuV/m)	LIMIT (dBuV/m)	MARGIN (dB)	ANTENNA HEIGHT (m)	TABLE ANGLE (Degree)	RAW VALUE (dBuV)	CORRECTION FACTOR (dB/m)
1	5150.00	64.6 PK	74.0	-9.4	1.91 H	50	58.60	6.00
2	5150.00	52.1 AV	54.0	-1.9	1.91 H	50	46.10	6.00
3	*5230.00	119.1 PK			1.88 H	40	79.50	39.60
4	*5230.00	109.9 AV			1.88 H	40	70.30	39.60
5	5360.00	61.6 PK	74.0	-12.4	1.82 H	43	55.10	6.50
6	5360.00	49.5 AV	54.0	-4.5	1.82 H	43	43.00	6.50
7	#10460.00	66.5 PK	74.0	-7.5	2.02 H	350	48.00	18.50
8	#10460.00	52.4 AV	54.0	-1.6	2.02 H	350	33.90	18.50

ANTENNA POLARITY & TEST DISTANCE: VERTICAL AT 3 M

NO.	FREQ. (MHz)	EMISSION LEVEL (dBuV/m)	LIMIT (dBuV/m)	MARGIN (dB)	ANTENNA HEIGHT (m)	TABLE ANGLE (Degree)	RAW VALUE (dBuV)	CORRECTION FACTOR (dB/m)
1	5150.00	57.0 PK	74.0	-17.0	1.60 V	212	51.00	6.00
2	5150.00	45.5 AV	54.0	-8.5	1.60 V	212	39.50	6.00
3	*5230.00	109.5 PK			2.33 V	337	69.90	39.60
4	*5230.00	100.5 AV			2.33 V	337	60.90	39.60
5	5400.00	59.9 PK	74.0	-14.1	1.90 V	100	53.20	6.70
6	5400.00	47.0 AV	54.0	-7.0	1.90 V	100	40.30	6.70
7	#10460.00	64.6 PK	74.0	-9.4	1.97 V	316	46.10	18.50
8	#10460.00	50.1 AV	54.0	-3.9	1.97 V	316	31.60	18.50

Remarks:

1. Emission Level(dBuV/m) = Raw Value(dBuV) + Correction Factor(dB/m)
2. Correction Factor(dB/m) = Antenna Factor(dB/m) + Cable Factor(dB)
3. The other emission levels were very low against the limit.
4. Margin value = Emission Level – Limit value
5. " * ": Fundamental frequency.
6. " # ": The radiated frequency is out of the restricted band.

CHANNEL	TX Channel 151	DETECTOR FUNCTION	Peak (PK)
FREQUENCY RANGE	1GHz ~ 40GHz		Average (AV)

ANTENNA POLARITY & TEST DISTANCE: HORIZONTAL AT 3 M

NO.	FREQ. (MHz)	EMISSION LEVEL (dBuV/m)	LIMIT (dBuV/m)	MARGIN (dB)	ANTENNA HEIGHT (m)	TABLE ANGLE (Degree)	RAW VALUE (dBuV)	CORRECTION FACTOR (dB/m)
1	#5714.00	66.2 PK	74.0	-7.8	2.72 H	9	56.60	9.60
2	#5714.00	52.6 AV	54.0	-1.4	2.72 H	9	43.00	9.60
3	#5722.00	74.5 PK	78.2	-3.7	2.04 H	19	64.90	9.60
4	#5725.00	61.7 PK	78.2	-16.5	2.04 H	19	52.10	9.60
5	*5755.00	110.7 PK			2.53 H	301	67.90	42.80
6	*5755.00	101.3 AV			2.53 H	301	58.50	42.80
7	11510.00	60.0 PK	74.0	-14.0	2.04 H	250	41.90	18.10
8	11510.00	46.8 AV	54.0	-7.2	2.04 H	250	28.70	18.10

ANTENNA POLARITY & TEST DISTANCE: VERTICAL AT 3 M

NO.	FREQ. (MHz)	EMISSION LEVEL (dBuV/m)	LIMIT (dBuV/m)	MARGIN (dB)	ANTENNA HEIGHT (m)	TABLE ANGLE (Degree)	RAW VALUE (dBuV)	CORRECTION FACTOR (dB/m)
1	#5714.00	60.5 PK	74.0	-13.5	2.58 V	316	50.90	9.60
2	#5714.00	49.9 AV	54.0	-4.1	2.58 V	316	40.30	9.60
3	#5722.00	71.2 PK	78.2	-7.0	2.23 V	310	61.60	9.60
4	#5725.00	59.3 PK	78.2	-18.9	2.23 V	310	49.70	9.60
5	*5755.00	106.3 PK			2.88 V	0	63.50	42.80
6	*5755.00	98.1 AV			2.88 V	0	55.30	42.80
7	11510.00	60.2 PK	74.0	-13.8	1.98 V	289	42.10	18.10
8	11510.00	47.1 AV	54.0	-6.9	1.98 V	289	29.00	18.10

Remarks:

1. Emission Level(dBuV/m) = Raw Value(dBuV) + Correction Factor(dB/m)
2. Correction Factor(dB/m) = Antenna Factor(dB/m) + Cable Factor(dB)
3. The other emission levels were very low against the limit.
4. Margin value = Emission Level – Limit value
5. " * ": Fundamental frequency.
6. " # ": The radiated frequency is out of the restricted band.

CHANNEL	TX Channel 159	DETECTOR FUNCTION	Peak (PK)
FREQUENCY RANGE	1GHz ~ 40GHz		Average (AV)

ANTENNA POLARITY & TEST DISTANCE: HORIZONTAL AT 3 M

NO.	FREQ. (MHz)	EMISSION LEVEL (dBuV/m)	LIMIT (dBuV/m)	MARGIN (dB)	ANTENNA HEIGHT (m)	TABLE ANGLE (Degree)	RAW VALUE (dBuV)	CORRECTION FACTOR (dB/m)
1	*5795.00	117.8 PK			2.22 H	276	74.90	42.90
2	*5795.00	108.8 AV			2.22 H	276	65.90	42.90
3	#5850.00	65.8 PK	78.2	-12.4	2.69 H	305	56.00	9.80
4	#5853.00	71.4 PK	78.2	-6.8	2.69 H	305	61.50	9.90
5	#5861.00	65.6 PK	74.0	-8.4	2.50 H	308	55.70	9.90
6	#5861.00	52.9 AV	54.0	-1.1	2.50 H	308	43.00	9.90
7	11590.00	65.1 PK	74.0	-8.9	1.99 H	339	46.80	18.30
8	11590.00	52.2 AV	54.0	-1.8	1.99 H	339	33.90	18.30

ANTENNA POLARITY & TEST DISTANCE: VERTICAL AT 3 M

NO.	FREQ. (MHz)	EMISSION LEVEL (dBuV/m)	LIMIT (dBuV/m)	MARGIN (dB)	ANTENNA HEIGHT (m)	TABLE ANGLE (Degree)	RAW VALUE (dBuV)	CORRECTION FACTOR (dB/m)
1	*5795.00	113.2 PK			2.95 V	349	70.30	42.90
2	*5795.00	104.1 AV			2.95 V	349	61.20	42.90
3	#5850.00	66.5 PK	78.2	-11.7	3.10 V	338	56.70	9.80
4	#5853.00	65.7 PK	78.2	-12.5	3.10 V	338	55.80	9.90
5	#5861.00	61.8 PK	74.0	-12.2	3.09 V	340	51.90	9.90
6	#5861.00	51.4 AV	54.0	-2.6	3.09 V	340	41.50	9.90
7	11590.00	65.4 PK	74.0	-8.6	1.77 V	344	47.10	18.30
8	11590.00	52.5 AV	54.0	-1.5	1.77 V	344	34.20	18.30

Remarks:

1. Emission Level(dBuV/m) = Raw Value(dBuV) + Correction Factor(dB/m)
2. Correction Factor(dB/m) = Antenna Factor(dB/m) + Cable Factor(dB)
3. The other emission levels were very low against the limit.
4. Margin value = Emission Level – Limit value
5. " * ": Fundamental frequency.
6. " # ": The radiated frequency is out of the restricted band.

802.11ac (VHT80)

CHANNEL	TX Channel 42	DETECTOR FUNCTION	Peak (PK)
FREQUENCY RANGE	1GHz ~ 40GHz		Average (AV)

ANTENNA POLARITY & TEST DISTANCE: HORIZONTAL AT 3 M

NO.	FREQ. (MHz)	EMISSION LEVEL (dBuV/m)	LIMIT (dBuV/m)	MARGIN (dB)	ANTENNA HEIGHT (m)	TABLE ANGLE (Degree)	RAW VALUE (dBuV)	CORRECTION FACTOR (dB/m)
1	5150.00	66.7 PK	74.0	-7.3	1.86 H	38	60.70	6.00
2	5150.00	52.9 AV	54.0	-1.1	1.86 H	38	46.90	6.00
3	*5210.00	107.3 PK			1.91 H	41	67.80	39.50
4	*5210.00	95.8 AV			1.91 H	41	56.30	39.50
5	#10420.00	59.8 PK	74.0	-14.2	1.97 H	44	41.90	17.90
6	#10420.00	46.9 AV	54.0	-7.1	1.97 H	44	29.00	17.90

ANTENNA POLARITY & TEST DISTANCE: VERTICAL AT 3 M

NO.	FREQ. (MHz)	EMISSION LEVEL (dBuV/m)	LIMIT (dBuV/m)	MARGIN (dB)	ANTENNA HEIGHT (m)	TABLE ANGLE (Degree)	RAW VALUE (dBuV)	CORRECTION FACTOR (dB/m)
1	5150.00	60.0 PK	74.0	-14.0	2.33 V	317	54.00	6.00
2	5150.00	48.4 AV	54.0	-5.6	2.33 V	317	42.40	6.00
3	*5210.00	100.2 PK			2.36 V	318	60.70	39.50
4	*5210.00	89.8 AV			2.36 V	318	50.30	39.50
5	#10420.00	59.6 PK	74.0	-14.4	2.12 V	313	41.70	17.90
6	#10420.00	46.4 AV	54.0	-7.6	2.12 V	313	28.50	17.90

Remarks:

1. Emission Level(dBuV/m) = Raw Value(dBuV) + Correction Factor(dB/m)
2. Correction Factor(dB/m) = Antenna Factor(dB/m) + Cable Factor(dB)
3. The other emission levels were very low against the limit.
4. Margin value = Emission Level – Limit value
5. " * ": Fundamental frequency.
6. " # ": The radiated frequency is out of the restricted band.

CHANNEL	TX Channel 155	DETECTOR FUNCTION	Peak (PK)
FREQUENCY RANGE	1GHz ~ 40GHz		Average (AV)

ANTENNA POLARITY & TEST DISTANCE: HORIZONTAL AT 3 M

NO.	FREQ. (MHz)	EMISSION LEVEL (dBuV/m)	LIMIT (dBuV/m)	MARGIN (dB)	ANTENNA HEIGHT (m)	TABLE ANGLE (Degree)	RAW VALUE (dBuV)	CORRECTION FACTOR (dB/m)
1	#5714.00	68.9 PK	74.0	-5.1	2.65 H	281	59.30	9.60
2	#5714.00	52.9 AV	54.0	-1.1	2.65 H	281	43.30	9.60
3	#5722.00	74.2 PK	78.2	-4.0	2.34 H	304	64.60	9.60
4	#5725.00	63.7 PK	78.2	-14.5	2.34 H	304	54.10	9.60
5	*5775.00	103.7 PK			2.27 H	298	60.90	42.80
6	*5775.00	94.0 AV			2.27 H	298	51.20	42.80
7	11550.00	59.9 PK	74.0	-14.1	2.02 H	298	41.80	18.10
8	11550.00	46.9 AV	54.0	-7.1	2.02 H	298	28.80	18.10

ANTENNA POLARITY & TEST DISTANCE: VERTICAL AT 3 M

NO.	FREQ. (MHz)	EMISSION LEVEL (dBuV/m)	LIMIT (dBuV/m)	MARGIN (dB)	ANTENNA HEIGHT (m)	TABLE ANGLE (Degree)	RAW VALUE (dBuV)	CORRECTION FACTOR (dB/m)
1	#5714.00	65.4 PK	74.0	-8.6	2.48 V	311	55.80	9.60
2	#5714.00	50.7 AV	54.0	-3.3	2.48 V	311	41.10	9.60
3	#5722.00	70.2 PK	78.2	-8.0	2.60 V	316	60.60	9.60
4	#5725.00	60.1 PK	78.2	-18.1	2.60 V	316	50.50	9.60
5	*5775.00	100.7 PK			2.70 V	302	57.90	42.80
6	*5775.00	90.3 AV			2.70 V	302	47.50	42.80
7	11550.00	60.3 PK	74.0	-13.7	1.80 V	323	42.20	18.10
8	11550.00	47.3 AV	54.0	-6.7	1.80 V	323	29.20	18.10

Remarks:

1. Emission Level(dBuV/m) = Raw Value(dBuV) + Correction Factor(dB/m)
2. Correction Factor(dB/m) = Antenna Factor(dB/m) + Cable Factor(dB)
3. The other emission levels were very low against the limit.
4. Margin value = Emission Level – Limit value
5. " * ": Fundamental frequency.
6. " # ": The radiated frequency is out of the restricted band.

Below 1GHz Worst-Case Data: 802.11a

CHANNEL	TX Channel 36	DETECTOR FUNCTION	Quasi-Peak (QP)
FREQUENCY RANGE	30MHz ~ 1GHz		
TEST MODE	A		

ANTENNA POLARITY & TEST DISTANCE: HORIZONTAL AT 3 M

NO.	FREQ. (MHz)	EMISSION LEVEL (dBuV/m)	LIMIT (dBuV/m)	MARGIN (dB)	ANTENNA HEIGHT (m)	TABLE ANGLE (Degree)	RAW VALUE (dBuV)	CORRECTION FACTOR (dB/m)
1	57.12	33.1 QP	40.0	-6.9	2.50 H	100	47.70	-14.60
2	164.06	34.9 QP	43.5	-8.6	1.50 H	245	48.80	-13.90
3	327.38	40.9 QP	46.0	-5.1	1.01 H	248	52.30	-11.40
4	689.01	40.8 QP	46.0	-5.2	1.01 H	133	45.00	-4.20
5	725.96	42.1 QP	46.0	-3.9	1.01 H	139	45.40	-3.30
6	786.23	41.8 QP	46.0	-4.2	1.01 H	141	44.00	-2.20

ANTENNA POLARITY & TEST DISTANCE: VERTICAL AT 3 M

NO.	FREQ. (MHz)	EMISSION LEVEL (dBuV/m)	LIMIT (dBuV/m)	MARGIN (dB)	ANTENNA HEIGHT (m)	TABLE ANGLE (Degree)	RAW VALUE (dBuV)	CORRECTION FACTOR (dB/m)
1	57.12	34.3 QP	40.0	-5.7	1.00 V	8	48.90	-14.60
2	134.89	35.3 QP	43.5	-8.2	1.00 V	230	50.20	-14.90
3	321.54	38.8 QP	46.0	-7.2	1.00 V	162	50.40	-11.60
4	683.18	42.4 QP	46.0	-3.6	1.50 V	97	46.60	-4.20
5	718.18	41.5 QP	46.0	-4.5	1.50 V	167	45.00	-3.50
6	897.05	37.4 QP	46.0	-8.6	1.50 V	181	38.00	-0.60

Remarks:

1. Emission Level(dBuV/m) = Raw Value(dBuV) + Correction Factor(dB/m)
2. Correction Factor(dB/m) = Antenna Factor(dB/m) + Cable Factor(dB)
3. The other emission levels were very low against the limit.
4. Margin value = Emission Level – Limit value

CHANNEL	TX Channel 36	DETECTOR FUNCTION	Quasi-Peak (QP)
FREQUENCY RANGE	30MHz ~ 1GHz		
TEST MODE	B		

ANTENNA POLARITY & TEST DISTANCE: HORIZONTAL AT 3 M

NO.	FREQ. (MHz)	EMISSION LEVEL (dBuV/m)	LIMIT (dBuV/m)	MARGIN (dB)	ANTENNA HEIGHT (m)	TABLE ANGLE (Degree)	RAW VALUE (dBuV)	CORRECTION FACTOR (dB/m)
1	57.12	33.1 QP	40.0	-6.9	2.49 H	8	47.70	-14.60
2	99.89	31.9 QP	43.5	-11.6	2.49 H	47	50.60	-18.70
3	169.89	32.8 QP	43.5	-10.7	1.49 H	80	47.00	-14.20
4	276.82	37.2 QP	46.0	-8.8	1.00 H	218	50.00	-12.80
5	500.42	32.3 QP	46.0	-13.7	1.49 H	109	40.40	-8.10
6	741.51	34.3 QP	46.0	-11.7	1.00 H	186	37.20	-2.90

ANTENNA POLARITY & TEST DISTANCE: VERTICAL AT 3 M

NO.	FREQ. (MHz)	EMISSION LEVEL (dBuV/m)	LIMIT (dBuV/m)	MARGIN (dB)	ANTENNA HEIGHT (m)	TABLE ANGLE (Degree)	RAW VALUE (dBuV)	CORRECTION FACTOR (dB/m)
1	37.16	36.5 QP	40.0	-3.5	1.50 V	162	52.00	-15.50
2	62.95	36.4 QP	40.0	-3.6	1.00 V	328	51.50	-15.10
3	169.89	32.5 QP	43.5	-11.0	1.00 V	92	46.70	-14.20
4	272.94	31.3 QP	46.0	-14.7	1.51 V	172	44.30	-13.00
5	500.42	32.2 QP	46.0	-13.8	1.00 V	156	40.30	-8.10
6	624.85	32.7 QP	46.0	-13.3	1.51 V	139	37.80	-5.10

Remarks:

1. Emission Level(dBuV/m) = Raw Value(dBuV) + Correction Factor(dB/m)
2. Correction Factor(dB/m) = Antenna Factor(dB/m) + Cable Factor(dB)
3. The other emission levels were very low against the limit.
4. Margin value = Emission Level – Limit value

4.2 Conducted Emission Measurement

4.2.1 Limits of Conducted Emission Measurement

Frequency (MHz)	Conducted Limit (dBuV)	
	Quasi-peak	Average
0.15 - 0.5	66 - 56	56 - 46
0.50 - 5.0	56	46
5.0 - 30.0	60	50

- Note:** 1. The lower limit shall apply at the transition frequencies.
 2. The limit decreases in line with the logarithm of the frequency in the range of 0.15 to 0.50MHz.

4.2.2 Test Instruments

Description & Manufacturer	Model No.	Serial No.	Cal. Date	Cal. Due
Test Receiver ROHDE & SCHWARZ	ESCS 30	100288	Apr. 27, 2015	Apr. 26, 2016
RF signal cable (with 10dB PAD) Woken	5D-FB	Cable-cond2-01	Dec. 26, 2015	Dec. 25, 2016
LISN ROHDE & SCHWARZ (EUT)	ESH2-Z5	100100	Jan. 11, 2016	Jan. 10, 2017
LISN ROHDE & SCHWARZ (Peripheral)	ESH3-Z5	100312	Jul. 21, 2015	Jul. 20, 2016
Software ADT	BV ADT_Cond_ V7.3.7.3	NA	NA	NA

- Note:** 1. The calibration interval of the above test instruments is 12 months and the calibrations are traceable to NML/ROC and NIST/USA.
 2. The test was performed in HwaYa Shielded Room 2.
 3. The VCCI Site Registration No. is C-2047.

4.2.3 Test Procedures

- The EUT was placed 0.4 meters from the conducting wall of the shielded room with EUT being connected to the power mains through a line impedance stabilization network (LISN). Other support units were connected to the power mains through another LISN. The two LISNs provide 50 ohm/ 50uH of coupling impedance for the measuring instrument.
- Both lines of the power mains connected to the EUT were checked for maximum conducted interference.
- The frequency range from 150kHz to 30MHz was searched. Emission levels under (Limit - 20dB) was not recorded.

NOTE: The resolution bandwidth and video bandwidth of test receiver is 9kHz for quasi-peak detection (QP) and average detection (AV) at frequency 0.15MHz-30MHz.

4.2.4 Deviation from Test Standard

No deviation.

4.2.5 Test Setup

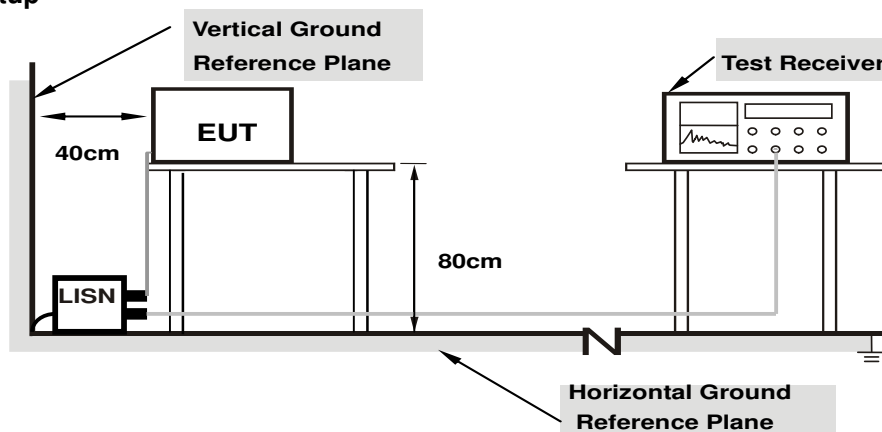

Note: 1.Support units were connected to second LISN.

For the actual test configuration, please refer to the attached file (Test Setup Photo).

4.2.6 EUT Operating Conditions

Same as 4.1.6.

4.2.7 Test Results

Phase	Line (L)	Detector Function	Quasi-Peak (QP) / Average (AV)
Test Mode	A		

No	Freq. [MHz]	Corr. Factor (dB)	Reading Value [dB (uV)]		Emission Level [dB (uV)]		Limit [dB (uV)]		Margin (dB)	
			Q.P.	AV.	Q.P.	AV.	Q.P.	AV.	Q.P.	AV.
			1	0.15000	10.18	44.22	25.28	54.40	35.46	66.00
2	0.16172	10.19	42.97	26.90	53.16	37.09	65.38	55.38	-12.22	-18.29
3	0.17344	10.19	41.01	22.72	51.20	32.91	64.79	54.79	-13.59	-21.88
4	3.23438	10.40	15.48	8.18	25.88	18.58	56.00	46.00	-30.12	-27.42
5	7.62891	10.48	20.94	15.60	31.42	26.08	60.00	50.00	-28.58	-23.92
6	11.84766	10.55	19.27	13.31	29.82	23.86	60.00	50.00	-30.18	-26.14

Remarks:

1. Q.P. and AV. are abbreviations of quasi-peak and average individually.
2. The emission levels of other frequencies were very low against the limit.
3. Margin value = Emission level - Limit value
4. Correction factor = Insertion loss + Cable loss
5. Emission Level = Correction Factor + Reading Value.

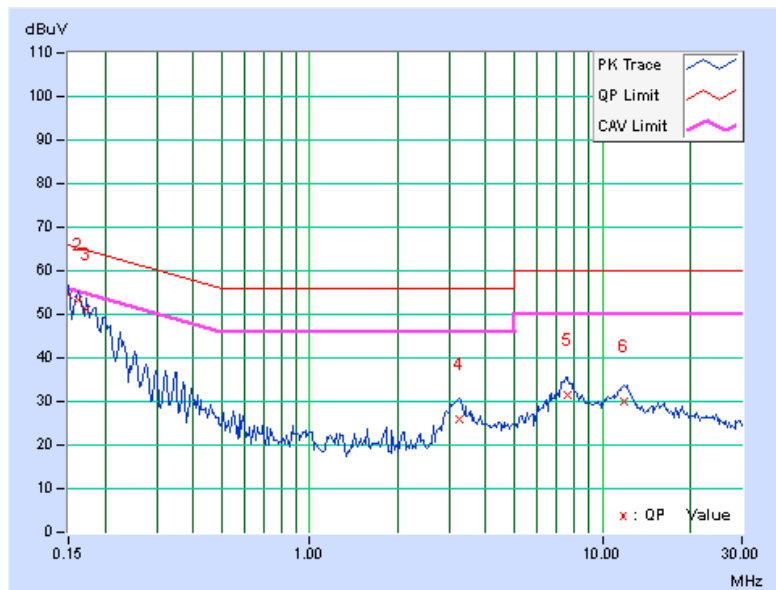

Phase	Neutral (N)	Detector Function	Quasi-Peak (QP) / Average (AV)
Test Mode	A		

No	Freq. [MHz]	Corr. Factor (dB)	Reading Value [dB (uV)]		Emission Level [dB (uV)]		Limit [dB (uV)]		Margin (dB)	
			Q.P.	AV.	Q.P.	AV.	Q.P.	AV.	Q.P.	AV.
			1	0.15000	10.19	44.03	25.89	54.22	36.08	66.00
2	0.16172	10.19	42.73	27.58	52.92	37.77	65.38	55.38	-12.45	-17.60
3	0.17734	10.20	38.65	24.79	48.85	34.99	64.61	54.61	-15.76	-19.62
4	0.34531	10.27	28.90	26.92	39.17	37.19	59.07	49.07	-19.90	-11.88
5	3.04297	10.48	18.93	9.29	29.41	19.77	56.00	46.00	-26.59	-26.23
6	12.00781	10.66	19.97	14.62	30.63	25.28	60.00	50.00	-29.37	-24.72

Remarks:

1. Q.P. and AV. are abbreviations of quasi-peak and average individually.
2. The emission levels of other frequencies were very low against the limit.
3. Margin value = Emission level - Limit value
4. Correction factor = Insertion loss + Cable loss
5. Emission Level = Correction Factor + Reading Value.

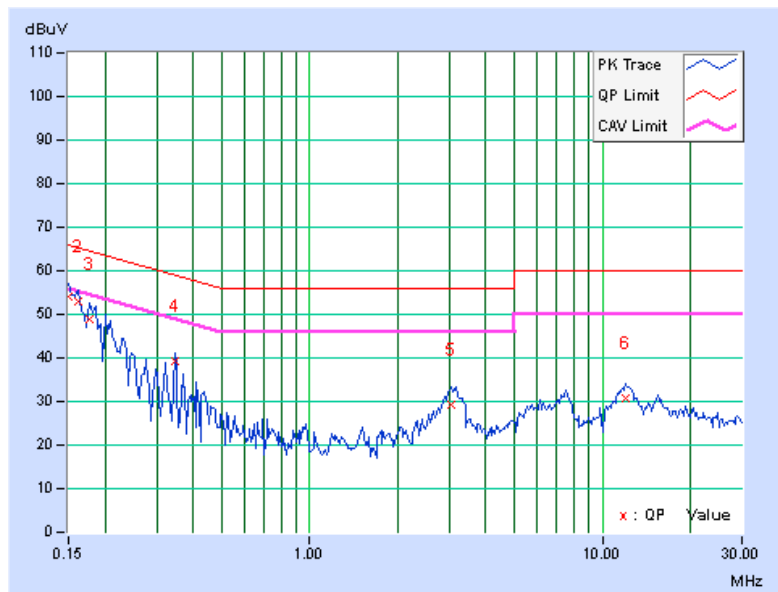

Phase	Line (L)	Detector Function	Quasi-Peak (QP) / Average (AV)
Test Mode	B		

No	Freq. [MHz]	Corr. Factor (dB)	Reading Value [dB (uV)]		Emission Level [dB (uV)]		Limit [dB (uV)]		Margin (dB)	
			Q.P.	AV.	Q.P.	AV.	Q.P.	AV.	Q.P.	AV.
			1	0.16562	10.19	30.78	23.88	40.97	34.07	65.18
2	0.54063	10.26	32.42	22.77	42.68	33.03	56.00	46.00	-13.32	-12.97
3	0.80234	10.29	16.13	15.02	26.42	25.31	56.00	46.00	-29.58	-20.69
4	1.60547	10.35	21.02	14.08	31.37	24.43	56.00	46.00	-24.63	-21.57
5	3.14453	10.40	16.51	10.47	26.91	20.87	56.00	46.00	-29.09	-25.13
6	21.59375	10.65	16.10	8.48	26.75	19.13	60.00	50.00	-33.25	-30.87

Remarks:

1. Q.P. and AV. are abbreviations of quasi-peak and average individually.
2. The emission levels of other frequencies were very low against the limit.
3. Margin value = Emission level - Limit value
4. Correction factor = Insertion loss + Cable loss
5. Emission Level = Correction Factor + Reading Value.

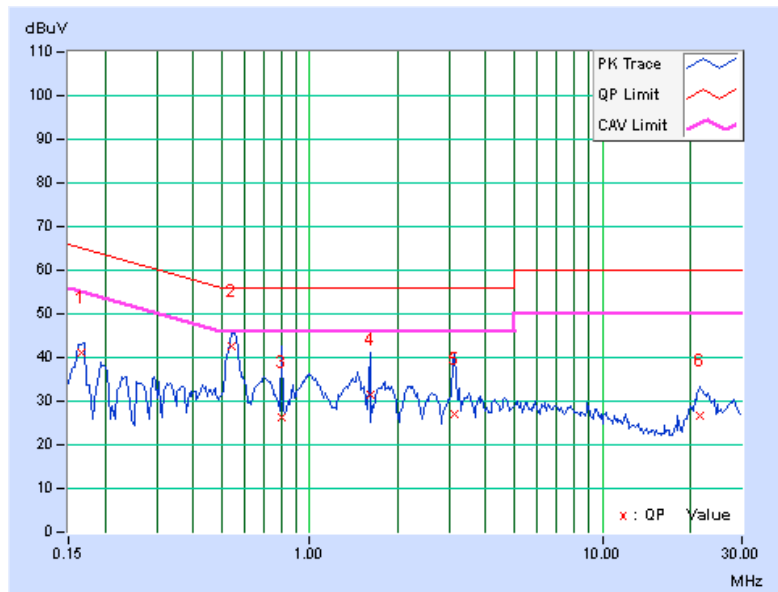

Phase	Neutral (N)	Detector Function	Quasi-Peak (QP) / Average (AV)
Test Mode	B		

No	Freq. [MHz]	Corr. Factor (dB)	Reading Value [dB (uV)]		Emission Level [dB (uV)]		Limit [dB (uV)]		Margin (dB)	
			Q.P.	AV.	Q.P.	AV.	Q.P.	AV.	Q.P.	AV.
			1	0.16562	10.19	31.76	23.05	41.95	33.24	65.18
2	0.19297	10.20	26.81	16.19	37.01	26.39	63.91	53.91	-26.90	-27.52
3	0.55234	10.30	32.03	25.16	42.33	35.46	56.00	46.00	-13.67	-10.54
4	0.99766	10.29	21.04	14.43	31.33	24.72	56.00	46.00	-24.67	-21.28
5	1.43359	10.34	21.21	14.58	31.55	24.92	56.00	46.00	-24.45	-21.08
6	22.17969	10.83	14.54	7.48	25.37	18.31	60.00	50.00	-34.63	-31.69

Remarks:

1. Q.P. and AV. are abbreviations of quasi-peak and average individually.
2. The emission levels of other frequencies were very low against the limit.
3. Margin value = Emission level - Limit value
4. Correction factor = Insertion loss + Cable loss
5. Emission Level = Correction Factor + Reading Value.

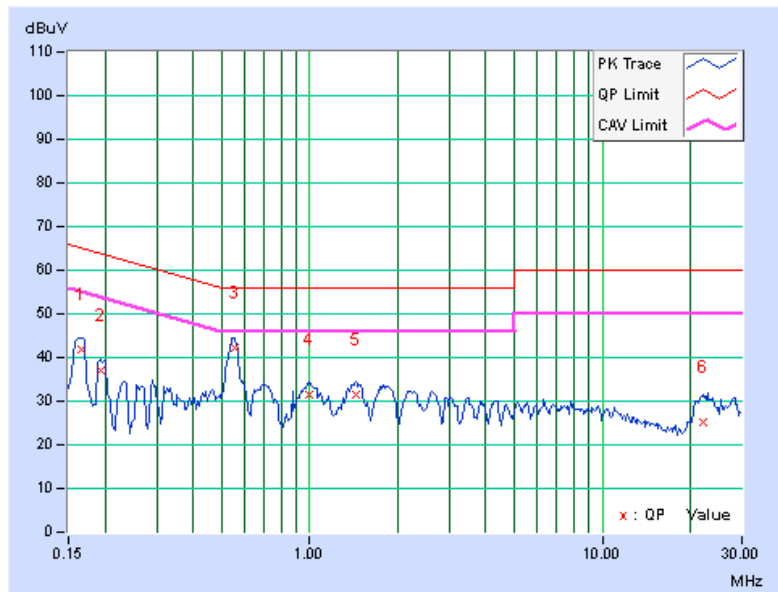

4.3 Transmit Power Measurement

4.3.1 Limits of Transmit Power Measurement

Operation Band	EUT Category		LIMIT
U-NII-1		Outdoor Access Point	1 Watt (30 dBm) (Max. e.i.r.p \leq 125mW(21 dBm) at any elevation angle above 30 degrees as measured from the horizon)
		Fixed point-to-point Access Point	1 Watt (30 dBm)
	√	Indoor Access Point	1 Watt (30 dBm)
		Mobile and Portable client device	250mW (24 dBm)
U-NII-2A	---		250mW (24 dBm) or 11 dBm+10 log B*
U-NII-2C	---		250mW (24 dBm) or 11 dBm+10 log B*
U-NII-3	√		1 Watt (30 dBm)

*B is the 26 dB emission bandwidth in megahertz

Per KDB 662911 Method of conducted output power measurement on IEEE 802.11 devices,

Array Gain = 0 dB (i.e., no array gain) for $N_{ANT} \leq 4$;

Array Gain = 0 dB (i.e., no array gain) for channel widths ≥ 40 MHz for any N_{ANT} ;

Array Gain = $5 \log(N_{ANT}/N_{SS})$ dB or 3 dB, whichever is less for 20-MHz channel widths with $N_{ANT} \geq 5$.

For power measurements on all other devices: Array Gain = $10 \log(N_{ANT}/N_{SS})$ dB.

4.3.2 Test Setup

For 802.11a, 802.11n (HT20), 802.11n (HT40), 802.11ac (VHT20), 802.11ac (VHT40)

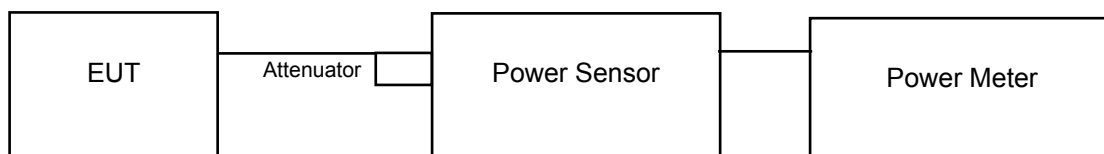

For 802.11ac (VHT80)

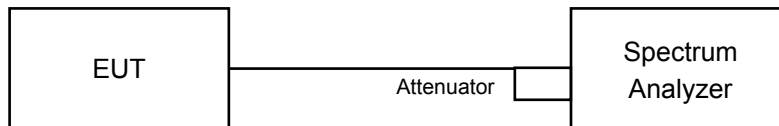

4.3.3 Test Instruments

Refer to section 4.1.2 to get information of above instrument.

4.3.4 Test Procedure

For Average Power Measurement

For 802.11a, 802.11n (HT20), 802.11n (HT40)

Method PM is used to perform output power measurement, trigger and gating function of wide band power meter is enabled to measure max output power of TX on burst. Duty factor is not added to measured value.

For 802.11ac (VHT80)

- a. Set span to encompass the entire 26 dB EBW (or, alternatively, the entire 99% occupied bandwidth) of the signal.
- b. Set sweep trigger to “free run”.
- c. Set RBW = 1 MHz.
- d. Set VBW \geq 3 MHz
- e. Number of points in sweep \geq 2 Span / RBW.
- f. Sweep time \leq (number of points in sweep) * T
- g. Using emission bandwidth to determine the frequency span for integration the channel bandwidth.
- h. Detector = RMS.
- i. Trace mode = max hold.
- j. Allow max hold to run for at least 60 seconds, or longer as needed to allow the trace to stabilize.
- k. Compute power by integrating the spectrum across the EBW (or, alternatively, the entire 99% occupied bandwidth) of the signal using the instrument’ s band power measurement function with band limits set equal to the EBW (or occupied bandwidth) band edges. If the instrument does not have a band power function, sum the spectrum levels (in power units) at 1 MHz intervals extending across the EBW (or, alternatively, the entire 99% occupied bandwidth) of the spectrum.

4.3.5 Deviation from Test Standard

No deviation.

4.3.6 EUT Operating Conditions

The software provided by client to enable the EUT under transmission condition continuously at lowest, middle and highest channel frequencies individually.

4.3.7 Test Result

Power Output:

802.11a

Chan.	Chan. Freq. (MHz)	Maximum Conducted Power (dBm)			Total Power (mW)	Total Power (dBm)	Power Limit (dBm)	Pass / Fail
		Chain 0	Chain 1	Chain 2				
36	5180	18.80	20.43	19.50	275.391	24.40	30.00	Pass
40	5200	21.75	22.32	21.64	466.113	26.68	30.00	Pass
48	5240	22.37	22.02	21.38	469.209	26.71	30.00	Pass
149	5745	19.80	18.02	18.14	224.049	23.50	30.00	Pass
157	5785	21.35	19.17	19.69	312.173	24.94	30.00	Pass
165	5825	20.38	18.21	18.27	242.509	23.85	30.00	Pass

802.11n (HT20)

Chan.	Chan. Freq. (MHz)	Maximum Conducted Power (dBm)			Total Power (mW)	Total Power (dBm)	Power Limit (dBm)	Pass / Fail
		Chain 0	Chain 1	Chain 2				
36	5180	19.19	20.12	19.54	275.737	24.40	30.00	Pass
40	5200	21.53	22.23	21.75	458.966	26.62	30.00	Pass
48	5240	22.83	22.81	22.06	543.546	27.35	30.00	Pass
149	5745	18.84	17.02	16.99	176.913	22.48	30.00	Pass
157	5785	21.19	19.43	19.03	299.205	24.76	30.00	Pass
165	5825	20.12	18.19	18.21	234.941	23.71	30.00	Pass

802.11n (HT40)

Chan.	Chan. Freq. (MHz)	Maximum Conducted Power (dBm)			Total Power (mW)	Total Power (dBm)	Power Limit (dBm)	Pass / Fail
		Chain 0	Chain 1	Chain 2				
38	5190	12.44	13.58	13.36	62.019	17.93	30.00	Pass
46	5230	22.07	22.38	21.39	471.768	26.74	30.00	Pass
151	5755	14.06	12.28	13.07	62.649	17.97	30.00	Pass
159	5795	20.48	19.11	18.67	266.777	24.26	30.00	Pass

802.11ac (VHT80)

Chan.	Chan. Freq. (MHz)	Maximum Conducted Power (dBm)			Total Power (mW)	Total Power (dBm)	Power Limit (dBm)	Pass / Fail
		Chain 0	Chain 1	Chain 2				
42	5210	10.19	10.71	10.64	33.811	15.29	30.00	Pass
155	5775	11.07	9.12	9.76	30.422	14.83	30.00	Pass

26dB Bandwidth:
802.11a

Chan.	Freq. (MHz)	26dBc Bandwidth (MHz)			Pass / Fail
		Chain 0	Chain 1	Chain 2	
36	5180	21.81	21.69	22.42	Pass
40	5200	22.19	22.19	21.97	Pass
48	5240	23.11	23.20	22.96	Pass

802.11n (HT20)

Chan.	Freq. (MHz)	26dBc Bandwidth (MHz)			Pass / Fail
		Chain 0	Chain 1	Chain 2	
36	5180	22.86	23.01	22.56	Pass
40	5200	22.47	23.37	22.66	Pass
48	5240	23.83	24.53	23.48	Pass

802.11n (HT40)

Chan.	Freq. (MHz)	26dBc Bandwidth (MHz)			Pass / Fail
		Chain 0	Chain 1	Chain 2	
38	5190	45.26	46.54	45.29	Pass
46	5230	46.02	46.34	45.48	Pass

802.11ac (VHT80)

Chan.	Freq. (MHz)	26dBc Bandwidth (MHz)			Pass / Fail
		Chain 0	Chain 1	Chain 2	
42	5210	87.52	87.38	85.85	Pass

Spectrum Plot of Worst Value

802.11a

802.11n (HT20)

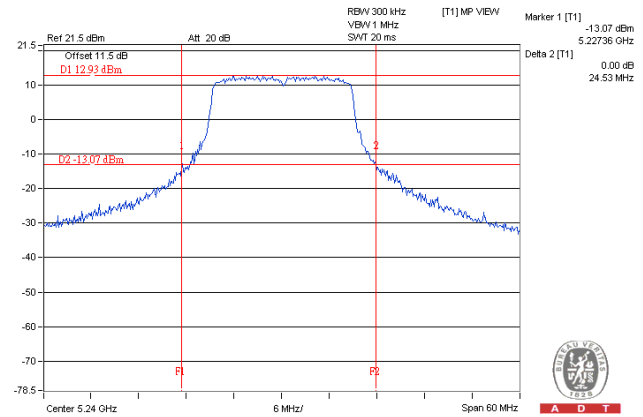
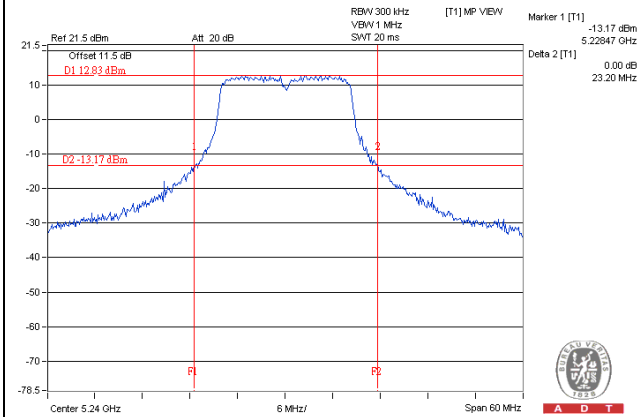

802.11n (HT40)

802.11ac (VHT80)

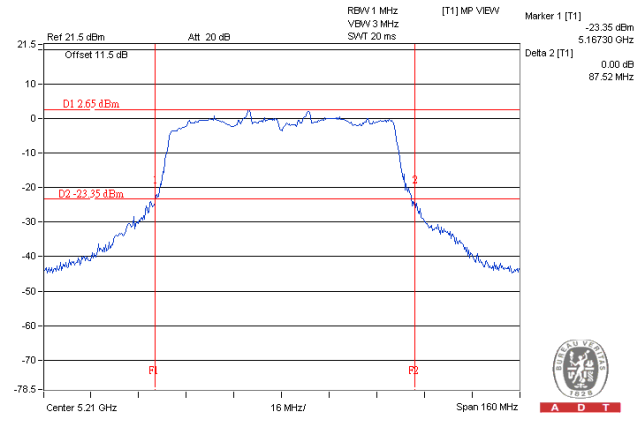
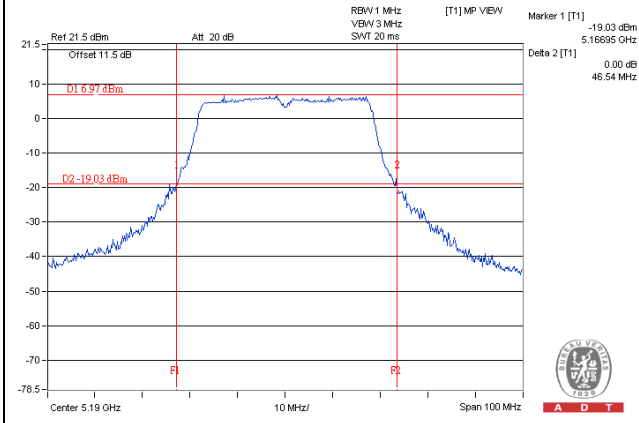

Occupied Bandwidth:
802.11a

Chan.	Freq. (MHz)	Occupied Bandwidth (MHz)		
		Chain 0	Chain 1	Chain 2
36	5180	16.80	16.68	16.68
40	5200	16.80	16.80	16.68
48	5240	16.80	16.80	16.68
149	5745	16.78	16.78	16.70
157	5785	16.80	16.68	16.80
165	5825	16.80	16.68	16.68

802.11n (HT20)

Chan.	Freq. (MHz)	Occupied Bandwidth (MHz)		
		Chain 0	Chain 1	Chain 2
36	5180	17.76	17.88	17.88
40	5200	17.88	18.00	17.88
48	5240	17.88	17.88	17.88
149	5745	17.88	17.88	17.76
157	5785	18.00	17.88	17.88
165	5825	17.88	17.88	17.76

802.11n (HT40)

Chan.	Freq. (MHz)	Occupied Bandwidth (MHz)		
		Chain 0	Chain 1	Chain 2
38	5190	36.72	36.96	36.72
46	5230	37.08	37.20	36.96
151	5755	37.08	36.96	36.96
159	5795	37.08	36.84	36.84

802.11ac (VHT80)

Chan.	Freq. (MHz)	Occupied Bandwidth (MHz)		
		Chain 0	Chain 1	Chain 2
42	5210	75.88	76.16	75.88
155	5775	76.16	76.16	76.44

Spectrum Plot of Worst Value

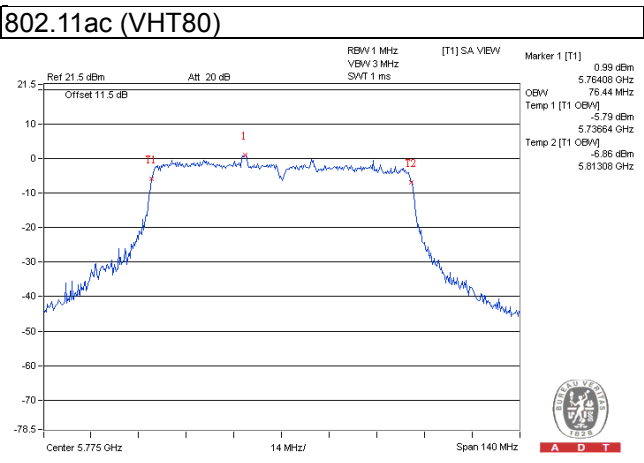
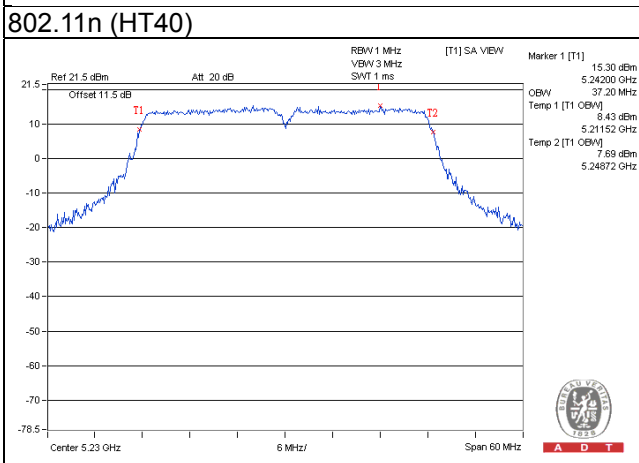
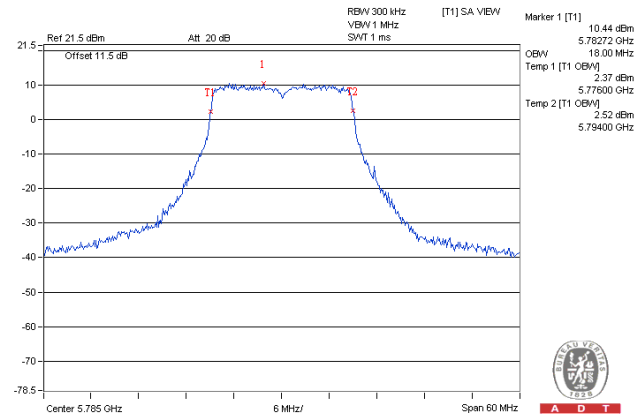
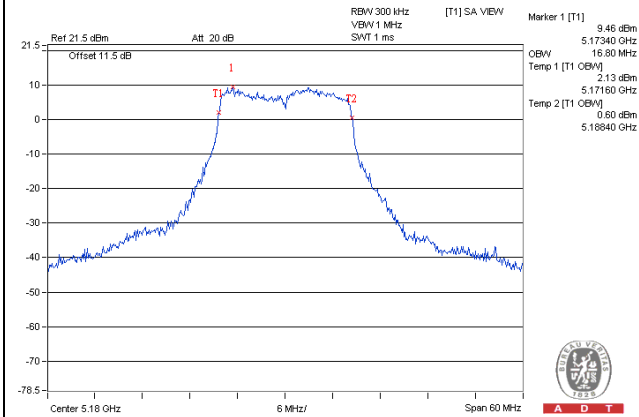

4.4 Peak Power Spectral Density Measurement

4.4.1 Limits of Peak Power Spectral Density Measurement

Operation Band	EUT Category		LIMIT
U-NII-1		Outdoor Access Point	17dBm/ MHz
		Fixed point-to-point Access Point	
	√	Indoor Access Point	11dBm/ MHz
		Mobile and Portable client device	
U-NII-2A	---		11dBm/ MHz
U-NII-2C	---		11dBm/ MHz
U-NII-3	√		30dBm/ 500kHz

4.4.2 Test Setup

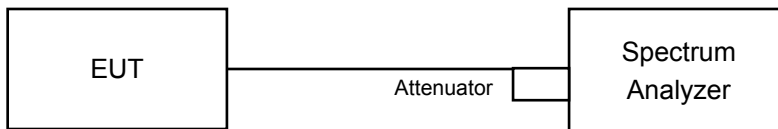

4.4.3 Test Instruments

Refer to section 4.1.2 to get information of above instrument.

4.4.4 Test Procedures

For U-NII-1 band:

Using method SA-2

- Set span to encompass the entire emission bandwidth (EBW) of the signal.
- Set RBW = 1 MHz, Set VBW ≥ 3 MHz, Detector = RMS
- Sweep time = auto, trigger set to “free run”.
- Trace average at least 100 traces in power averaging mode.
- Record the max value and add 10 log (1/duty cycle)

For U-NII-3 band:

- Set span to encompass the entire emission bandwidth (EBW) of the signal.
- Set RBW = 300 kHz, Set VBW ≥ 1 MHz, Detector = RMS
- Use the peak marker function to determine the maximum power level in any 300 kHz band segment within the fundamental EBW.
- Scale the observed power level to an equivalent value in 500 kHz by adjusting (reducing) the measured power by a bandwidth correction factor (BWCF) where $BWCF = 10\log(500\text{ kHz}/300\text{kHz})$
- Sweep time = auto, trigger set to “free run”.
- Trace average at least 100 traces in power averaging mode.
- Record the max value and add 10 log (1/duty cycle)

4.4.5 Deviation from Test Standard

No deviation.

4.4.6 EUT Operating Conditions

Same as Item 4.3.6.

4.4.7 Test Results

For U-NII-1 Band

802.11a

Chan.	Freq. (MHz)	PSD (dBm)			Total PSD w/o duty factor (dBm)	Duty factor	Total PSD with duty factor (dBm)	Max. Limit (dBm)	Pass / Fail
		Chain 0	Chain 1	Chain 2					
36	5180	5.68	4.98	5.03	10.01	0.20	10.21	13.23	Pass
40	5200	8.00	8.17	7.24	12.59	0.20	12.79	13.23	Pass
48	5240	7.97	8.32	6.96	12.56	0.20	12.76	13.23	Pass

Note:

- Method 1 of power density measurement of KDB 662911 is using for calculating total power density. Total power density is summing entire spectra across corresponding frequency bins on the various outputs by computer.
- Directional gain = $5\text{dBi} + 10\log(3) = 9.77\text{dBi} > 6\text{dBi}$, so the power density limit shall be reduced to $17 - (9.77 - 6) = 13.23\text{dBm}$.
- Refer to section 3.3 for duty cycle spectrum plot.

802.11n (HT20)

Chan.	Freq. (MHz)	PSD (dBm)			Total PSD w/o duty factor (dBm)	Duty factor	Total PSD with duty factor (dBm)	Max. Limit (dBm)	Pass / Fail
		Chain 0	Chain 1	Chain 2					
36	5180	5.25	5.29	4.92	9.93	0.40	10.33	13.23	Pass
40	5200	7.34	7.46	6.79	11.98	0.40	12.38	13.23	Pass
48	5240	8.22	8.01	6.91	12.52	0.40	12.92	13.23	Pass

Note:

- Method 1 of power density measurement of KDB 662911 is using for calculating total power density. Total power density is summing entire spectra across corresponding frequency bins on the various outputs by computer.
- Directional gain = $5\text{dBi} + 10\log(3) = 9.77\text{dBi} > 6\text{dBi}$, so the power density limit shall be reduced to $17 - (9.77 - 6) = 13.23\text{dBm}$.
- Refer to section 3.3 for duty cycle spectrum plot.

802.11n (HT40)

Chan.	Freq. (MHz)	PSD (dBm)			Total PSD w/o duty factor (dBm)	Duty factor	Total PSD with duty factor (dBm)	Max. Limit (dBm)	Pass / Fail
		Chain 0	Chain 1	Chain 2					
38	5190	-4.38	-5.19	-4.69	0.03	0.37	0.40	13.23	Pass
46	5230	5.07	4.50	3.48	9.17	0.37	9.54	13.23	Pass

Note:

- Method 1 of power density measurement of KDB 662911 is using for calculating total power density. Total power density is summing entire spectra across corresponding frequency bins on the various outputs by computer.
- Directional gain = $5\text{dBi} + 10\log(3) = 9.77\text{dBi} > 6\text{dBi}$, so the power density limit shall be reduced to $17 - (9.77 - 6) = 13.23\text{dBm}$.
- Refer to section 3.3 for duty cycle spectrum plot.

802.11ac (VHT80)

Chan.	Freq. (MHz)	PSD (dBm)			Total PSD w/o duty factor (dBm)	Duty factor	Total PSD with duty factor (dBm)	Max. Limit (dBm)	Pass / Fail
		Chain 0	Chain 1	Chain 2					
42	5210	-10.18	-10.41	-10.88	-5.71	0.74	-4.97	13.23	Pass

Note:

1. Method 1 of power density measurement of KDB 662911 is using for calculating total power density. Total power density is summing entire spectra across corresponding frequency bins on the various outputs by computer.
2. Directional gain = 5dBi + 10log(3) = 9.77dBi > 6dBi, so the power density limit shall be reduced to 17-(9.77-6) = 13.23dBm.
3. Refer to section 3.3 for duty cycle spectrum plot.

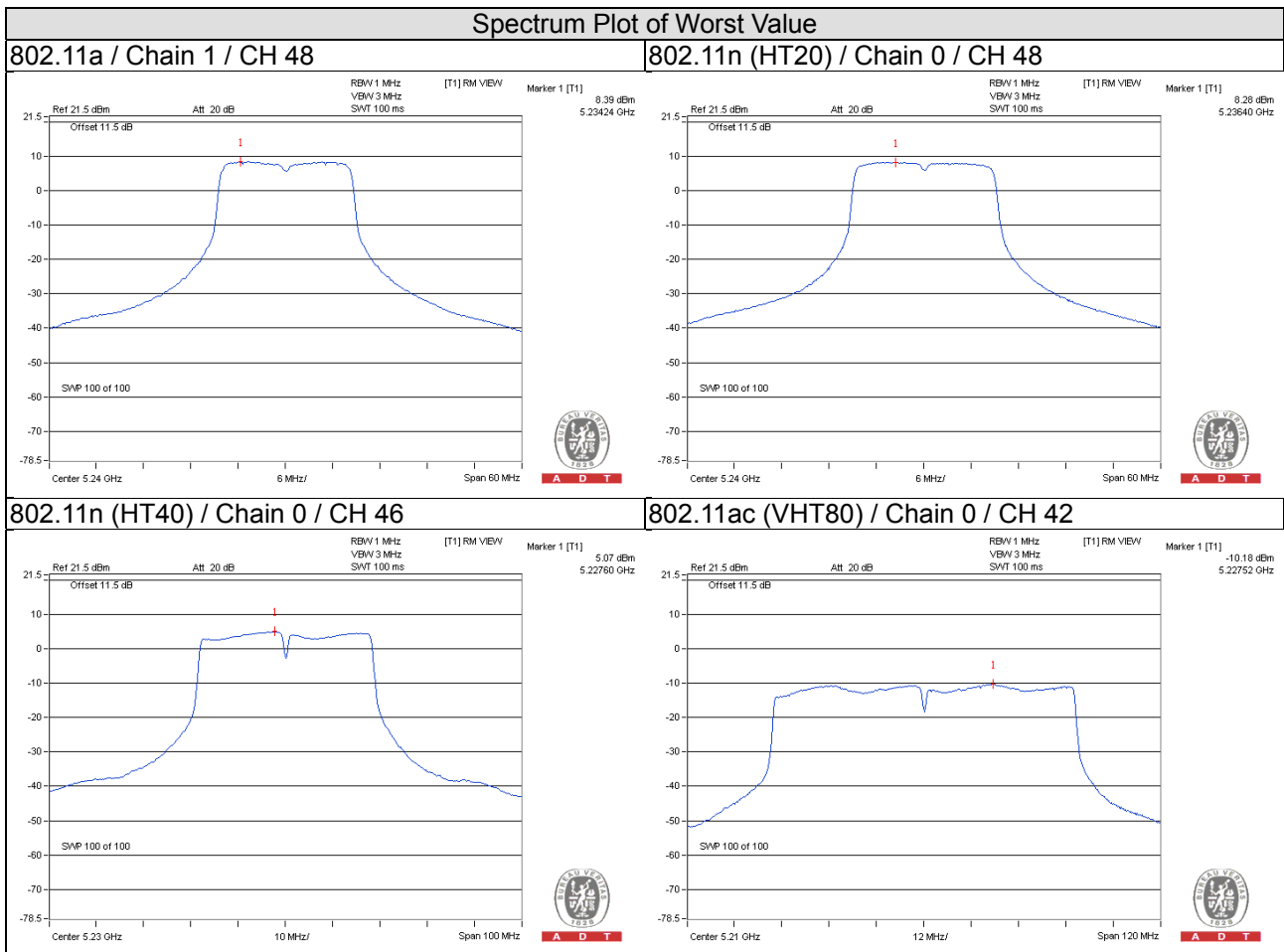

For U-NII-3 Band
802.11a

TX chain	Chan.	Freq. (MHz)	PSD (dBm/300 kHz)	PSD (dBm/500 kHz)	10 log (N=3) dB	Duty factor	Total PSD (dBm/500 kHz)	Limit (dBm/500 kHz)	Pass / Fail
0	149	5745	-3.40	-1.18	4.77	0.20	3.79	26.23	Pass
	157	5785	-1.91	0.31	4.77	0.20	5.28	26.23	Pass
	165	5825	-2.60	-0.38	4.77	0.20	4.59	26.23	Pass
1	149	5745	-4.52	-2.30	4.77	0.20	2.67	26.23	Pass
	157	5785	-3.24	-1.02	4.77	0.20	3.95	26.23	Pass
	165	5825	-4.74	-2.52	4.77	0.20	2.45	26.23	Pass
2	149	5745	-4.56	-2.34	4.77	0.20	2.63	26.23	Pass
	157	5785	-3.56	-1.34	4.77	0.20	3.63	26.23	Pass
	165	5825	-4.34	-2.12	4.77	0.20	2.85	26.23	Pass

Note:

- Method 1 of power density measurement of KDB 662911 is using for calculating total power density. Total power density is summing entire spectra across corresponding frequency bins on the various outputs by computer.
- Directional gain = 5dBi + 10log(3) = 9.77dBi > 6dBi, so the power density limit shall be reduced to 30-(9.77-6) = 26.23dBm.
- Refer to section 3.3 for duty cycle spectrum plot.

802.11n (HT20)

TX chain	Chan.	Freq. (MHz)	PSD (dBm/300 kHz)	PSD (dBm/500 kHz)	10 log (N=3) dB	Duty factor	Total PSD (dBm/500 kHz)	Limit (dBm/500 kHz)	Pass / Fail
0	149	5745	-4.69	-2.47	4.77	0.40	2.70	26.23	Pass
	157	5785	-2.23	-0.01	4.77	0.40	5.16	26.23	Pass
	165	5825	-2.88	-0.66	4.77	0.40	4.51	26.23	Pass
1	149	5745	-6.37	-4.15	4.77	0.40	1.02	26.23	Pass
	157	5785	-4.23	-2.01	4.77	0.40	3.16	26.23	Pass
	165	5825	-4.86	-2.64	4.77	0.40	2.53	26.23	Pass
2	149	5745	-5.64	-3.42	4.77	0.40	1.75	26.23	Pass
	157	5785	-3.77	-1.55	4.77	0.40	3.62	26.23	Pass
	165	5825	-5.06	-2.84	4.77	0.40	2.33	26.23	Pass

Note:

- Method 1 of power density measurement of KDB 662911 is using for calculating total power density. Total power density is summing entire spectra across corresponding frequency bins on the various outputs by computer.
- Directional gain = 5dBi + 10log(3) = 9.77dBi > 6dBi, so the power density limit shall be reduced to 30-(9.77-6) = 26.23dBm.
- Refer to section 3.3 for duty cycle spectrum plot.

802.11n (HT40)

TX chain	Chan.	Freq. (MHz)	PSD (dBm/300 kHz)	PSD (dBm/500 kHz)	10 log (N=3) dB	Duty factor	Total PSD (dBm/500 kHz)	Limit (dBm/500 kHz)	Pass / Fail
0	151	5755	-12.14	-9.92	4.77	0.37	-4.78	26.23	Pass
	159	5795	-5.79	-3.57	4.77	0.37	1.57	26.23	Pass
1	151	5755	-14.07	-11.85	4.77	0.37	-6.71	26.23	Pass
	159	5795	-6.56	-4.34	4.77	0.37	0.80	26.23	Pass
2	151	5755	-13.42	-11.20	4.77	0.37	-6.06	26.23	Pass
	159	5795	-7.48	-5.26	4.77	0.37	-0.12	26.23	Pass

Note:

- Method 1 of power density measurement of KDB 662911 is using for calculating total power density. Total power density is summing entire spectra across corresponding frequency bins on the various outputs by computer.
- Directional gain = 5dBi + 10log(3) = 9.77dBi > 6dBi, so the power density limit shall be reduced to 30-(9.77-6) = 26.23dBm.
- Refer to section 3.3 for duty cycle spectrum plot.

802.11ac (VHT80)

TX chain	Chan.	Freq. (MHz)	PSD (dBm/300 kHz)	PSD (dBm/500 kHz)	10 log (N=3) dB	Duty factor	Total PSD (dBm/500 kHz)	Limit (dBm/500 kHz)	Pass / Fail
0	155	5775	-18.68	-16.46	4.77	0.74	-10.95	26.23	Pass
1	155	5775	-19.94	-17.72	4.77	0.74	-12.21	26.23	Pass
2	155	5775	-20.11	-17.89	4.77	0.74	-12.38	26.23	Pass

Note:

- Method 1 of power density measurement of KDB 662911 is using for calculating total power density. Total power density is summing entire spectra across corresponding frequency bins on the various outputs by computer.
- Directional gain = 5dBi + 10log(3) = 9.77dBi > 6dBi, so the power density limit shall be reduced to 30-(9.77-6) = 26.23dBm.
- Refer to section 3.3 for duty cycle spectrum plot.

Spectrum Plot of Worst Value

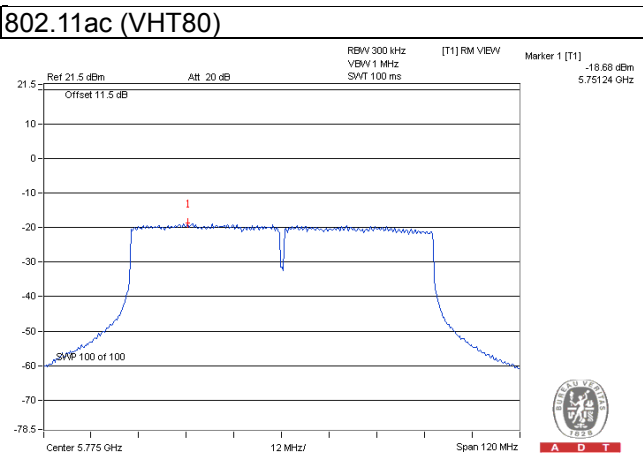
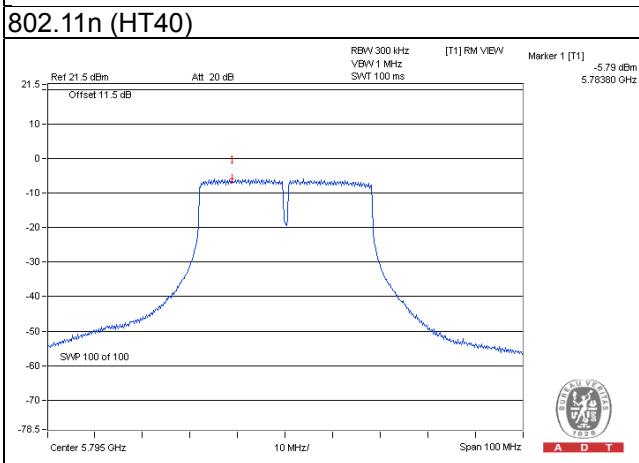
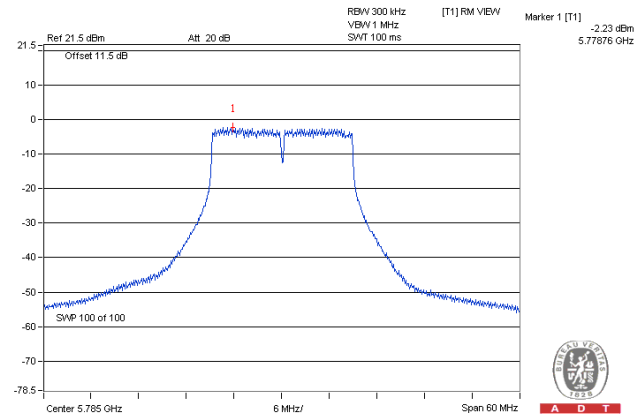
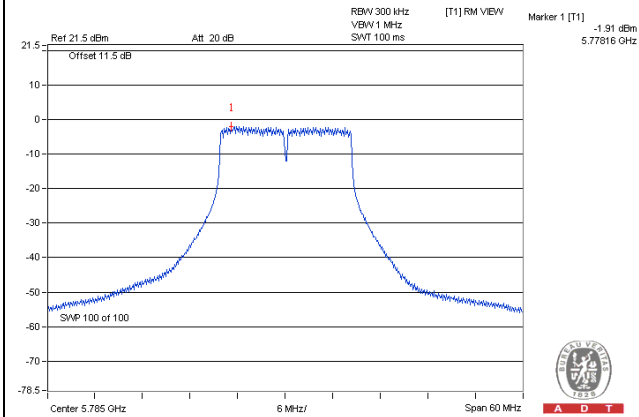

4.5 Frequency Stability

4.5.1 Limits of Frequency Stability Measurement

The frequency of the carrier signal shall be maintained within band of operation

4.5.2 Test Setup

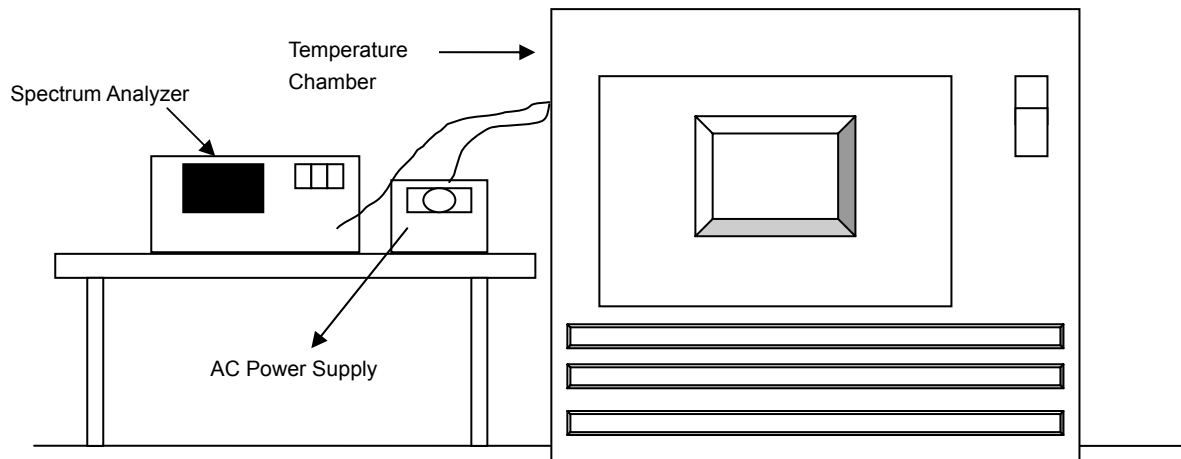

4.5.3 Test Instruments

Refer to section 4.1.2 to get information of above instrument.

4.5.4 Test Procedure

- a. The EUT was placed inside the environmental test chamber and powered by nominal AC voltage.
- b. Turn the EUT on and couple its output to a spectrum analyzer.
- c. Turn the EUT off and set the chamber to the highest temperature specified.
- d. Allow sufficient time (approximately 30 min) for the temperature of the chamber to stabilize, turn the EUT on and measure the operating frequency after 2, 5, and 10 minutes.
- e. Repeat step 2 and 3 with the temperature chamber set to the lowest temperature.
- f. The test chamber was allowed to stabilize at +20 degree C for a minimum of 30 minutes. The supply voltage was then adjusted on the EUT from 85% to 115% and the frequency record.

4.5.5 Deviation from Test Standard

No deviation.

4.5.6 EUT Operating Condition

Set the EUT transmit at un-modulation mode to test frequency stability.

4.5.7 Test Results

Frequency Stability Versus Temp.									
Operating Frequency: 5180MHz									
Temp. (°C)	Power Supply (Vac)	0 Minute		2 Minute		5 Minute		10 Minute	
		Measured Frequency (MHz)	Frequency Drift (%)	Measured Frequency (MHz)	Frequency Drift (%)	Measured Frequency (MHz)	Frequency Drift (%)	Measured Frequency (MHz)	Frequency Drift (%)
50	120	5180.0203	0.00039	5180.0195	0.00038	5180.0212	0.00041	5180.0219	0.00042
40	120	5180.0182	0.00035	5180.021	0.00041	5180.0194	0.00037	5180.0191	0.00037
30	120	5180.0024	0.00005	5180.0031	0.00006	5180.0025	0.00005	5180.001	0.00002
20	120	5179.9883	-0.00023	5179.9911	-0.00017	5179.9902	-0.00019	5179.9884	-0.00022
10	120	5180.0164	0.00032	5180.0189	0.00036	5180.0186	0.00036	5180.0168	0.00032
0	120	5180.0208	0.00040	5180.0213	0.00041	5180.0235	0.00045	5180.0214	0.00041
-10	120	5179.9812	-0.00036	5179.9817	-0.00035	5179.9837	-0.00031	5179.9835	-0.00032
-20	120	5179.9764	-0.00046	5179.9721	-0.00054	5179.9752	-0.00048	5179.9768	-0.00045
-30	120	5179.9957	-0.00008	5179.9946	-0.00010	5179.9947	-0.00010	5179.9973	-0.00005

Frequency Stability Versus Voltage									
Operating Frequency: 5180MHz									
Temp. (°C)	Power Supply (Vac)	0 Minute		2 Minute		5 Minute		10 Minute	
		Measured Frequency (MHz)	Frequency Drift (%)	Measured Frequency (MHz)	Frequency Drift (%)	Measured Frequency (MHz)	Frequency Drift (%)	Measured Frequency (MHz)	Frequency Drift (%)
20	138	5179.9886	-0.00022	5179.9912	-0.00017	5179.991	-0.00017	5179.9892	-0.00021
	120	5179.9883	-0.00023	5179.9911	-0.00017	5179.9902	-0.00019	5179.9884	-0.00022
	102	5179.9873	-0.00025	5179.9911	-0.00017	5179.9898	-0.00020	5179.988	-0.00023

4.6 6dB Bandwidth Measurement

4.6.1 Limits of 6dB Bandwidth Measurement

The minimum of 6dB Bandwidth Measurement is 0.5MHz.

4.6.2 Test Setup

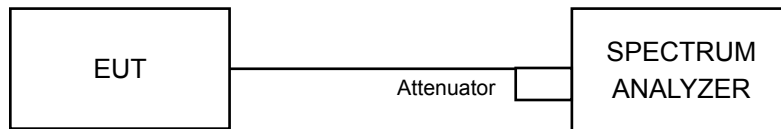

4.6.3 Test Instruments

Refer to section 4.1.2 to get information of above instrument.

4.6.4 Test Procedure

MEASUREMENT PROCEDURE REF

- Set resolution bandwidth (RBW) = 100kHz
- Set the video bandwidth (VBW) $\geq 3 \times$ RBW, Detector = Peak.
- Trace mode = max hold.
- Sweep = auto couple.
- Measure the maximum width of the emission that is constrained by the frequencies associated with the two amplitude points (upper and lower) that are attenuated by 6 dB relative to the maximum level measured in the fundamental emission

4.6.5 Deviation from Test Standard

No deviation.

4.6.6 EUT Operating Condition

The software provided by client to enable the EUT under transmission condition continuously at lowest, middle and highest channel frequencies individually.

4.6.7 Test Results

802.11a

Chan.	Freq. (MHz)	6dB Bandwidth (MHz)			Minimum Limit (MHz)	Pass / Fail
		Chain 0	Chain 1	Chain 2		
149	5745	16.42	16.44	16.41	0.5	Pass
157	5785	16.43	16.41	16.47	0.5	Pass
165	5825	16.45	16.42	16.43	0.5	Pass

802.11n (HT20)

Chan.	Freq. (MHz)	6dB Bandwidth (MHz)			Minimum Limit (MHz)	Pass / Fail
		Chain 0	Chain 1	Chain 2		
149	5745	17.64	17.66	17.64	0.5	Pass
157	5785	17.66	17.65	17.65	0.5	Pass
165	5825	17.65	17.65	17.65	0.5	Pass

802.11n (HT40)

Chan.	Freq. (MHz)	6dB Bandwidth (MHz)			Minimum Limit (MHz)	Pass / Fail
		Chain 0	Chain 1	Chain 2		
151	5755	36.50	36.47	36.48	0.5	Pass
159	5795	36.44	35.39	36.13	0.5	Pass

802.11ac (VHT80)

Chan.	Freq. (MHz)	6dB Bandwidth (MHz)			Minimum Limit (MHz)	Pass / Fail
		Chain 0	Chain 1	Chain 2		
155	5775	76.64	76.67	76.00	0.5	Pass

Spectrum Plot of Worst Value

802.11a

802.11n (HT20)

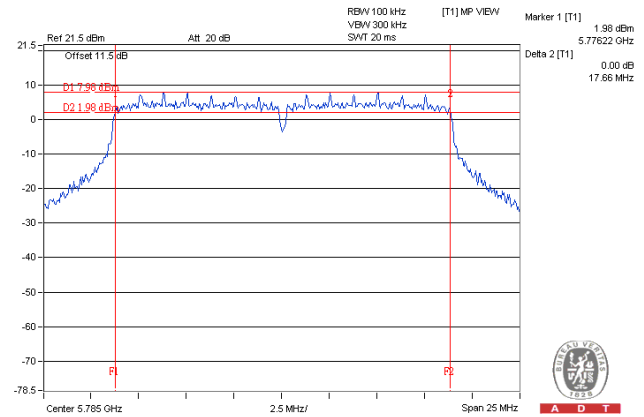
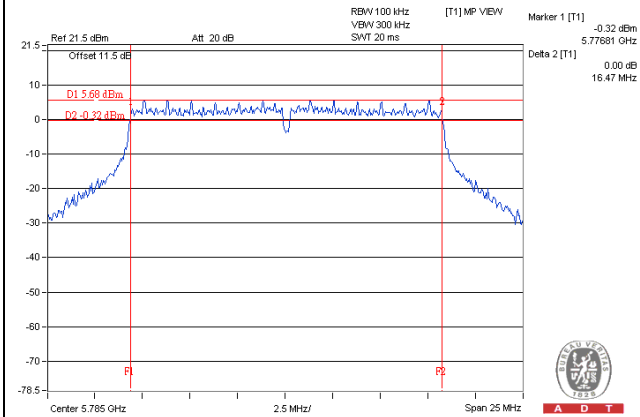

802.11n (HT40)

802.11ac (VHT80)

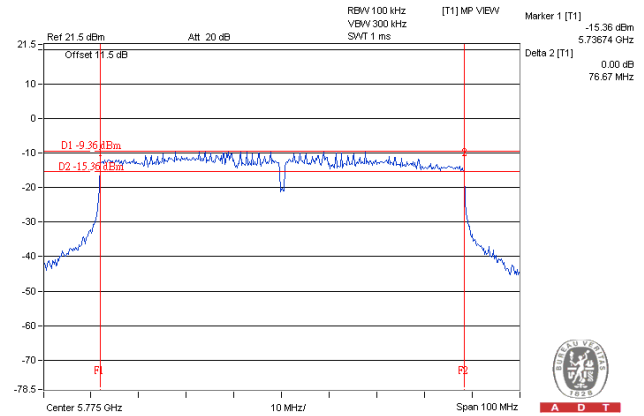
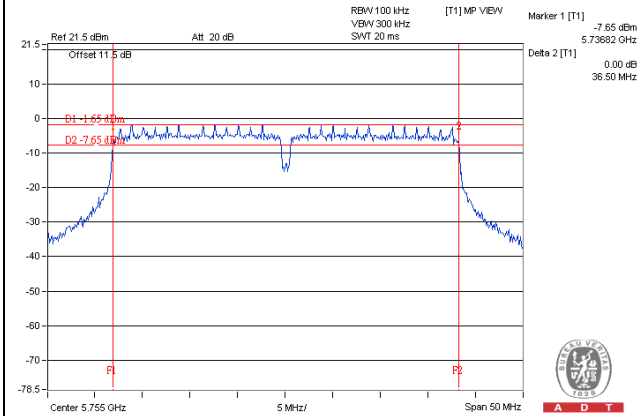

5 Pictures of Test Arrangements

Please refer to the attached file (Test Setup Photo).

Appendix – Information on the Testing Laboratories

We, Bureau Veritas Consumer Products Services (H.K.) Ltd., Taoyuan Branch, were founded in 1988 to provide our best service in EMC, Radio, Telecom and Safety consultation. Our laboratories are accredited and approved according to ISO/IEC 17025.

If you have any comments, please feel free to contact us at the following:

Linko EMC/RF Lab

Tel: 886-2-26052180

Fax: 886-2-26051924

Hsin Chu EMC/RF/Telecom Lab

Tel: 886-3-6668565

Fax: 886-3-6668323

Hwa Ya EMC/RF/Safety Lab

Tel: 886-3-3183232

Fax: 886-3-3270892

Email: service.adt@tw.bureauveritas.com

Web Site: www.bureauveritas-adt.com

The address and road map of all our labs can be found in our web site also.

--- END ---