



MDT-500 IDENTIFICATION LABELS

PRODUCT: MDT-500 763-870 MHZ GPS POWERTRUNK

CODE: MDT-500 Identification Labels

VERSION: 01

REVISION: 00

DATE: 13/12/2012

CLASSIFICATION:

General information

Internal document

DOCUMENT MAINTENANCE

THIS DOCUMENT HAS 5 PAGES

EDIT.	DATE	AUTHOR	DESCRIPTION
1.0	13/12/2012	Guillermo Olagüe	First release.

DOCUMENT APPROVAL

ACTIVITY	NAME	DATE	SIGNATURE
Prepared	Guillermo Olagüe	13/12/2012	
Revised Project Manager	Pedro Peña		
Approved R&D Director	Alfredo Calderón		

	MDT-500 IDENTIFICATION LABELS	Code: MDT-500 Ident. Labels	
		Date: 10/01/13	Page: 2 de 5

PowerTrunk Inc. is the subsidiary of Teltronic S.A.U. responsible for business development, distribution and customer support for Teltronic's Land Mobile Radio products in North America. The company is headquartered in New York City. Teltronic S.A.U. distributes the same products for Land Mobile Radio under different trademarks and brand names in other regions of the world.

Disclaimer

Although every reasonable effort has been made to ensure the accuracy of the information contained herein and any other referred document, this should not be construed as a commitment on the part of Teltronic S.A.U. and/or PowerTrunk Inc., and the liability of Teltronic S.A.U. and/or PowerTrunk Inc. for any errors and omissions shall be limited to the correction of such errors and omissions. Teltronic S.A.U. and/or PowerTrunk Inc. welcomes any comment as a way to improve any delivered documentation.

The information contained herein has been prepared for the use of appropriately trained personnel, and it is intended for the purpose of the agreement under which the information is submitted. Any party using or relying upon this information assumes full responsibility for such use and in no event shall Teltronic S.A.U. and/or PowerTrunk Inc. be liable to anyone for especial, collateral, incidental, or consequential damages in connection with or arising out of the use of this information.

The information or statements given in these documents regarding the suitability, capacity or performance of the mentioned hardware or software products cannot be considered binding but shall be defined in the agreement made between Teltronic S.A.U. and/or PowerTrunk Inc. and the customer.

Teltronic S.A.U. and/or PowerTrunk Inc. reserves the right to revise these documents and to make changes to its content at any time, without prior notification.

Copyrights

No part of the information contained herein and the other referred documents may be copied, distributed or transmitted by any means to any other party without prior written permission of Teltronic S.A.U. and/or PowerTrunk Inc. The distribution of this document may be also covered by NDA (non-disclosure agreement) between Teltronic S.A.U. and/or PowerTrunk Inc. and the receiver.

Please also note that part of these contents even may be covered by patent rights.

This document, the referred documents and the described product are considered protected by copyright according to the applicable laws.

PowerTrunk and the PowerTrunk logo are registered trademarks of Teltronic S.A.U.

Copyright © PowerTrunk Inc. All rights reserved.

	MDT-500 IDENTIFICATION LABELS	Code: MDT-500 Ident. Labels	
		Date: 10/01/13	Page: 3 de 5

CONTENTS:

1.	MDT-500	4
1.1.	INTRODUCTION	4
1.2.	LABELS	4
1.3.	LOCATION OF THE LABELS	5

	MDT-500 IDENTIFICATION LABELS	Code: MDT-500 Ident. Labels	
		Date: 10/01/13	Page: 4 de 5

1. MDT-500

1.1. INTRODUCTION

There are two identification labels, which are located in the rear of the MDT-500.

1.2. LABELS

Label 1

Material: Polyester film laminate.

Colour: Silver and Black.

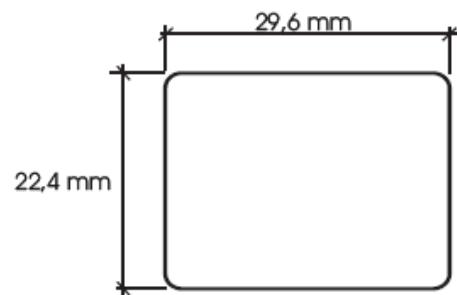
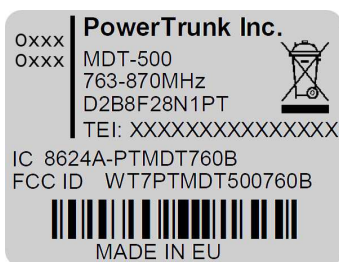

Label 2

Material: Polyester film laminate.

Colour: Silver, black and yellow.

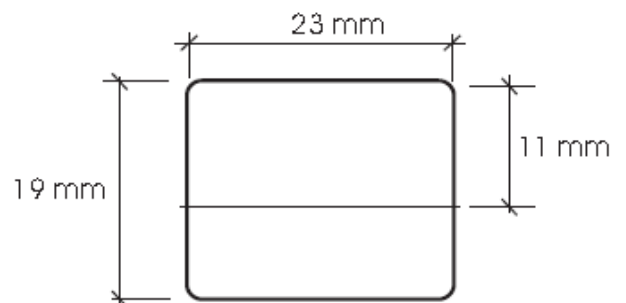
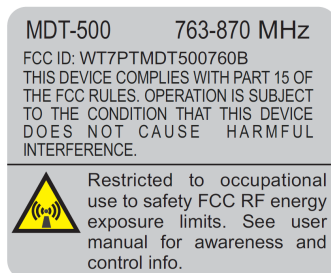

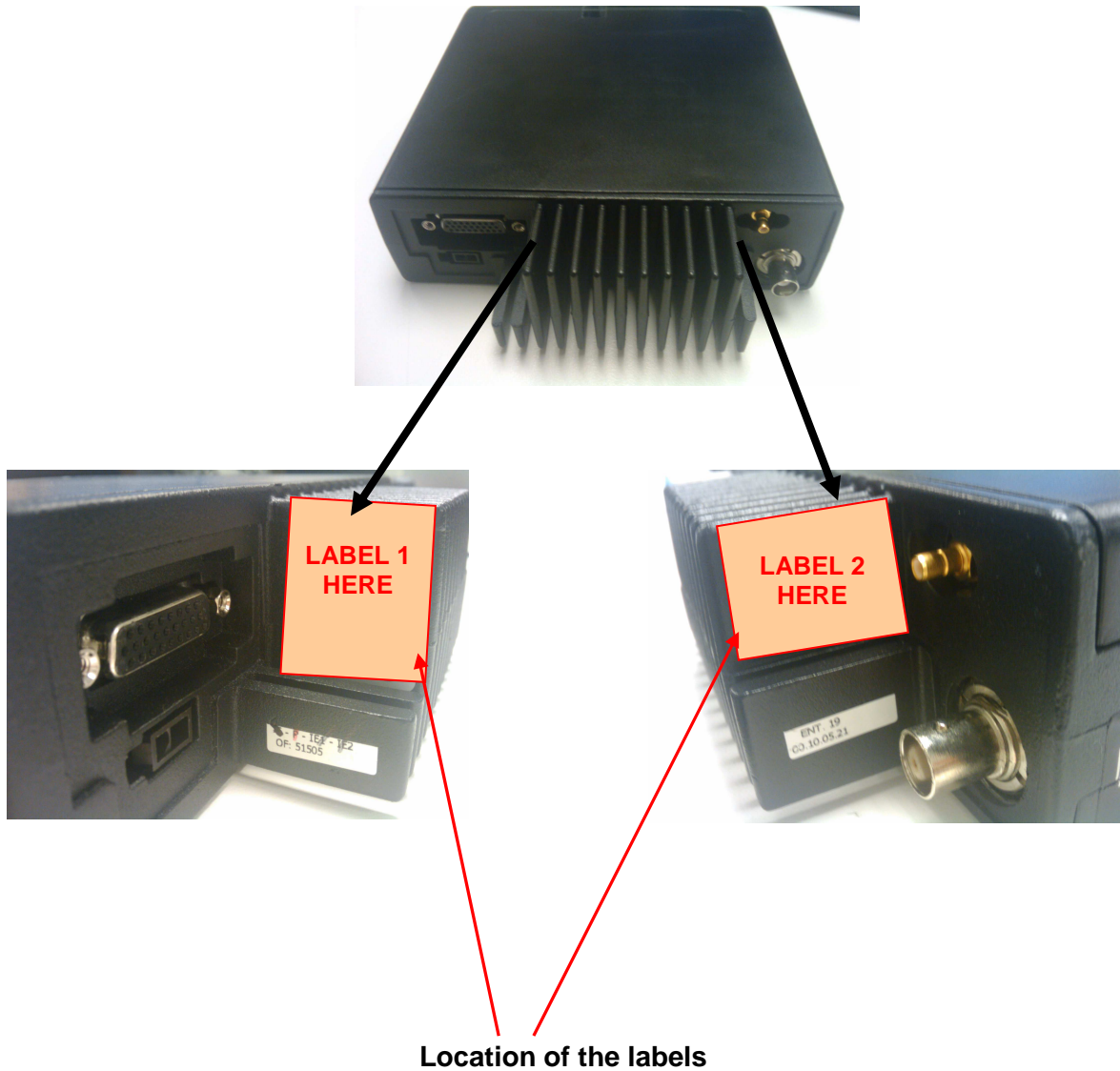
1.3. LOCATION OF THE LABELS

< end of document >